

# AUTOPAGE®

A Leader in Technology and Innovation

## INTRODUCTION

This Remote Starter with Alarm and Keyless Entry System has been designed to be installed on fuel-injected vehicles with an automatic transmission **ONLY**.

■ Never install this remote starter on a manual transmission vehicle. ■ This system must be installed and wired through a safety switch so it will not start in any forward or reverse gear.

Some automatic transmission vehicles mainly older GM vehicles with a purple starter wire have a mechanical-type park safety switch instead of electrical safety switch. The mechanical type does not interrupt the starter circuit when the transmission is in any gear and does not offer the 100% level of safety required for remote starting purposes. Therefore, our system should never be installed on any vehicle that uses a mechanical type park safety switch.

■ Once you install this system, you must verify that the vehicle will not start in any forward or reverse gear, regardless of the type of vehicle. ■ Read the operation manual for operating. ■ Do not install any component near the brake, gas pedal or steering linkage.

■ Some vehicles have a factory installed transponder immobilizer system that can severely complicate the installation. There is a possibility that this system cannot be installed on some immobilizer-equipped vehicles. ■ Most vehicles have an SRS air bag system. Use extreme care and do not probe any wires of the SRS system. ■ Disconnect the car battery before beginning work on the vehicle.

■ Check behind panels before drilling any holes. Ensure that no wiring harness or other components are located behind the panels that would otherwise be damaged.

■ Do not use conventional crimp lock, bullet on any wiring. Poor wiring, i.e. taped joints will possibly introduce unreliability into the alarm system and may result in false alarms or incorrect operation. We suggest soldering all connection points. ■ Install the wiring neatly under carpets or behind trim to prevent possible damage to wires.

## INSTALLATION DIAGRAM

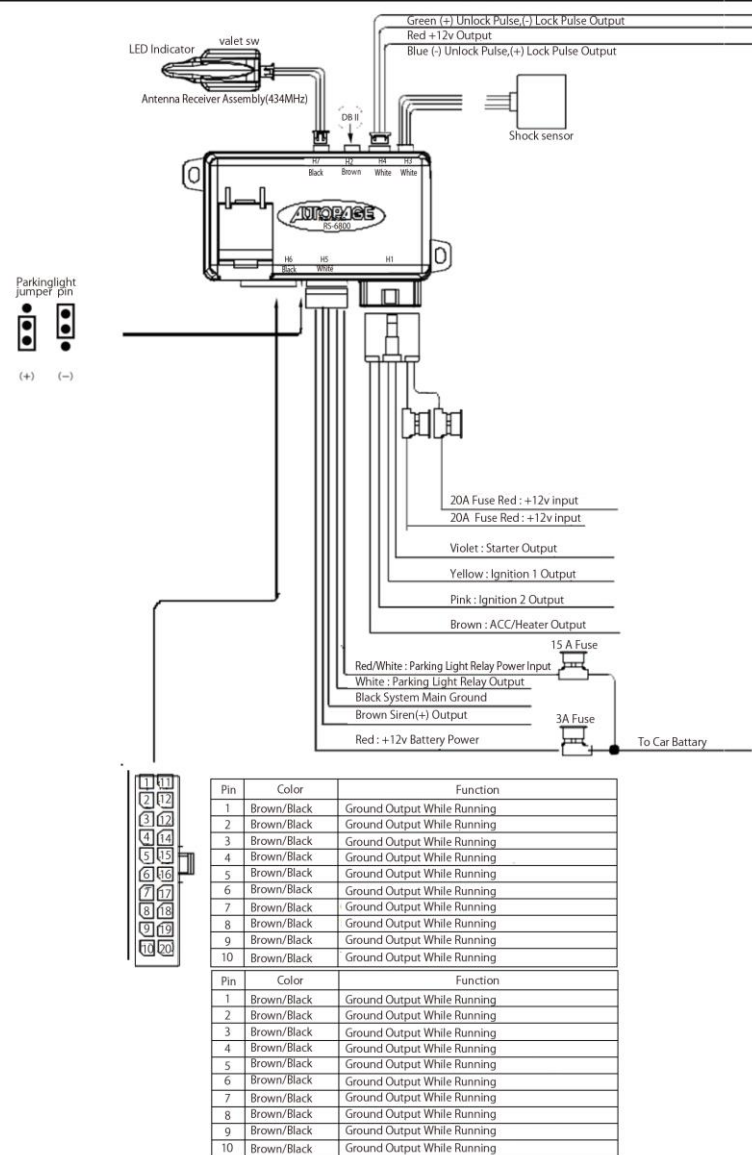

# RS-6800

## INSTALLATION MANUAL

### H1 6 PIN HEAVY GAUGE WIRE HARNESS

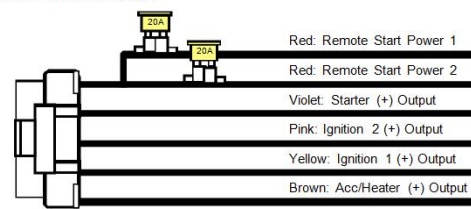

### H5 5 PIN WIRE HARNESS

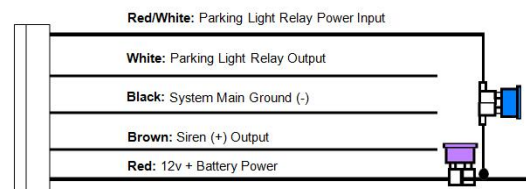

### H4. 3 PIN, DOOR LOCK CONNECTOR

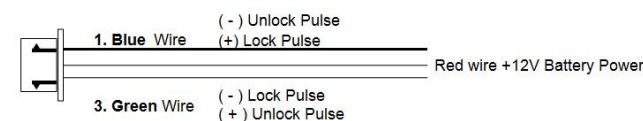

## WIRING

Keep wiring away from moving engine parts, exhaust pipes and high-tension cable. Be sure to tape wires that pass through holes in the firewall to prevent fraying.

**CAUTION:** Do not connect the wire harness to the control module until all wiring to vehicle is complete.

### H1: 6 PIN HEAVY GAUGE WIRING CONNECTIONS:

Remember that what the system does to start a vehicle is to duplicate the functions of the ignition key switch! Below, we will explain the three basic functions of the ignition switch. Since this installation will require analysis of the ignition switch functions, we recommend making the three connections below at the ignition switch harness directly.

#### Violet Wire—Starter Output

Careful consideration for the connection of this wire must be made to prevent the vehicle from starting while in gear. Understanding the difference between a mechanical and an electrical Neutral Start Switch will allow you to properly identify the circuit and select the correct installation method. In addition you will realize why the connection of the safety wire is required for all mechanical switch configurations.

Failure to make this connection properly can result in **personal injury and property damage**.

In all installations it is the responsibility of the installing technician to test the remote start unit and assure that the vehicle cannot start via RF control in any gear selection other than park or neutral.

In both mechanical and electrical neutral start switch configurations, the connection of the VIOLET wire will be made to the low current start solenoid wire of the ignition switch harness. This wire has +12 volts when the ignition switch is turned to the "START" (CRANK) position only. This wire has 0 volts in all other ignition switch positions.

**NOTE:** This wire must be connected to the vehicle side of the starter cut relay (when used). For the electrical neutral switch configuration, this connection must be made between the starter inhibit relay (when used) and the neutral safety switch as shown in the following diagram. Failure to connect this wire to the ignition switch side of the neutral safety switch can result in personal injury and property damage.

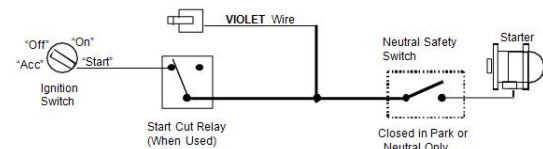

### Red Wire (2) — +12V Power Input

Closed in Park or Neutral Only

Remove the two 20A fuses prior to connecting these wires and do not replace them until the satellite has been plugged into the control module. These wires are the source of current for all the circuits the relay satellite will energize. They must be connected to a high current source. Since the factory supplies (+) 12V to the key switch that is used to operate the motor, it is recommended that these wires be connected there. Note: If the factory supplies two separate (+) 12V feeds to the ignition switch, connect one RED wire of the satellite to each feed at the switch.

### Yellow Wire – Ignition 1 Output

Connect the YELLOW wire to the ignition 1 wire from the ignition switch. The ignition wire should receive "12 volts" when the ignition key is in the "ON" or "RUN" and "START" or "CRANK" position. When the ignition is turned "OFF", the ignition wire should receive "0" voltage. The YELLOW wire must be connected.

### PINK Wire – Ignition 2 Output

Some vehicles have [2] ignition wires that must be power. Connect the PINK wire to the ignition 2 wire from the ignition switch. The ignition wire should receive "12 volts" when the ignition key is in the "ON" or "RUN" and "START" or "CRANK" position. When the ignition is turned "OFF", the ignition wire should receive "0" voltage. If the PINK wire is not used, cap the end of the wire.

### Brown Wire –Accessory Output (Heater /AC Output)

Connect the BROWN wire to the accessory wire in the vehicle that powers the climate control system. An accessory wire will show + 12 volts when the ignition switch is turned to the "ACCESSORY" or "ON" and "RUN" positions, and will show 0 Volts when the key is turned to the "OFF" and "START" or "CRANK" position. There will often be more than one accessory wire in the ignition harness. The correct accessory wire will provide power to the vehicle's climate control system. Some vehicles may have separate wires for the blower motor and the air conditioning compressor. In such cases, it will be necessary to add a relay to power the second accessory wire

### H5:5 PIN WIRE HARNESS:

#### RED / WHITE WIRE –PARKING LIGHT RELAY INPUT —

The RED/WHITE wire is the input to the flashing parking light relay. The connection of the RED/WHITE wire will determine the output polarity of the flashing parking light relay.

If the vehicle you are working on has +12volt switched parking lights, you don't need connect this wire. This wire is already connected to +12volt.

If the vehicle's parking lights are ground switched, cut the RED/WHITE wire, connect the RED/WHITE wire to chassis ground.

#### WHITE WIRE — PARKING LIGHT RELAY OUTPUT (+12 V 10A OUTPUT) —

Connect the WHITE wire to the parking light wire coming from the headlight switch. Do not connect the WHITE wire to the dashboard lighting dimmer switch. (Damage to the dimmer will result). The limitation of the WHITE wire is 10 AMP max. Do not exceed this limit or damage to the alarm and parking relay will result.

#### BLACK WIRE — SYSTEM GROUND —

This is the main ground connection of the alarm module. Make this connection to a solid section of the vehicle frame. Do not connect this wire to any existing ground wires supplied by the factory wire loom, make the connection to the vehicle's frame directly.

#### BROWN WIRE – (+) 2A SIREN OUTPUT —

This wire is provides power to the supplied siren. Connect the Brown wire to the Red wire of the siren. Connect the Black wire of the siren to a stable chassis ground.

#### RED WIRE — SYSTEM POWER (+12V CONSTANT) —

The RED wire supplies power to the system. Connect this wire to a stable constant +12 volt source.

### H7. 3-PIN BLACK CONNECTOR. – TWO-WAY TRANSCEIVER/ANTENNA MODULE

The Two-way transceiver/antenna mounting location should be the upper left or lower left corner of driver's windshield. For optimum range we suggest that the antenna be mounted as shown in picture to the right. (Antenna tip facing up) Warning!

Do not mount in such a manner that it obstructs the driver's view.

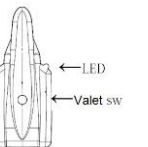

- Remove the protective tape backing.
- Carefully align the two-way transceiver/antenna and apply to windshield.
- Route the black connector wire behind the trim and connect to the two-way transceiver/antenna.
- Connect the other end to the control module.
- Special considerations must be made for windshield glass as some newer vehicles utilize a metal -shielded window glass that will inhibit or restrict RF reception. In these vehicles, route the two ways transceiver/antenna module away from metallic shielded window glass as far as possible.



This manual was written February 1, 2018  
©2018 Varad International, Inc. All rights reserved.

GI-S392

# AUTOPAGE®

A Leader in Technology and Innovation

## H8. 2 PIN BLUE CONNECTOR FOR THE VALET SWITCH: (Under door on main unit)

Select a mounting location for the switch that is easily accessible to the driver of the vehicle. The switch does not have to be concealed, however, concealing the switch is always recommended, as this provides an even higher level of security to the vehicle. Mount the valet switch in a hidden but accessible location. Route the valet switch wires to the control module.

## H3. 4 PIN ORANGE CONNECTOR 2 STAGE SHOCK SENSOR, ZONE-4, (Under door on main unit)

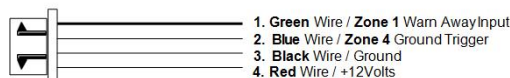
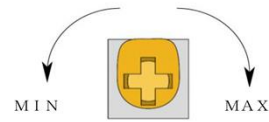

1. Green Wire / Zone 1 Warn Away Input
2. Blue Wire / Zone 4 Ground Trigger
3. Black Wire / Ground
4. Red Wire / +12Volts

## H-6: 20 PIN WIRE CONNECTORS:

Pin	Color	Function
1	Brown/Black	Ground Output While Running
2	Gray/Black	Second Starter Output
3	Pink	2-Step Unlock/Factory Disarm/Sensor By-pass
4	White/Blue	Instant Start And Turn Off Input
5	White	Dome Light Control Output
6	Brown/White	Horn Output (Programmable)
7	Black/Green	Channel 4 Programmable Output
8	Black/White	Neutral Safety Switch Input
9	Orange/White	Ground Output When Disarmed
10	White/Red	Tachometer Signal Input
11	Blue/Black	Accessory 2 Control Output
12	White/Green	Diesel Wait To Start Input
13	Yellow	Ignition 3 Control Output
14	Green	Zone 3 (-) Negative Door Pin Trigger
15	Gray	Channel 3(Trunk) Output
16	Blue	Zone 2 Negative Hood/Trunk Trigger
17	White/Violet	(+) Brake Switch Shutdown Input
18	Violet	Zone 3 (+) Positive Door Pin Trigger
19	White/Black	(-) Negative Hood Pin Safety Shutdown
20	Orange	Ground Output When Armed

## H6/1 BROWN/BLACK WIRE: 200 mA (-) Ground Output When Running.

This wire provides a negative output during the remote start process. It can be used to operate by-pass modules that may be required in your installation. This wire will provide ground once the remote start process has been initiated and will remain grounded while the engine is running.

## H6/2 GRAY/BLACK WIRE: 200 mA (-) Second Starter Output.

This line can be used if a second starter line is needed. Some vehicles require a two-starter line to remote start. This wire provides a negative output that will work the same way as the Violet starter line in connector H1.

## H6/3 PINK WIRE – (-) 200mA Programmable Output 2 Steps Unlock Output (Factory default setting)

The 2 steps unlock feature will work for the most fully electronic door lock circuit. The vehicle must have an electronic door lock switch (not the lock knob or key switch), which locks and unlocks all of vehicle's doors. When wired for this feature, press the disarm (or unlock) button one time will disarm the alarm and unlock the driver's door only. If, press disarm (or unlock) button two times within 3 seconds, the alarm will disarm and all doors will unlock.

### Factory Security Disarm Signal Output –

This wire is designed to disarm a factory installed security system. This wire sends a negative (-) 1 seconds pulse upon a remote start and remote door unlocking. Some factory systems must be disarmed to allow remote starting. In most cases, this wire may be connected directly to the factory alarm disarm wire. The correct wire will show negative ground when the key is used to unlock the doors or trunk. This wire is usually found in the kick panel area in the wiring harness coming into the car body from the door.

### Start Status (Shock Sensor By-Pass Control) Output–

This wire is designed to by-pass shock sensor module. This wire will supply an output at all times the remote start is operating plus an additional 3 seconds after the remote start unit turn off.

### Key Sensor Bypass Output –

This output is for a Key Sense wire by-pass that some Chrysler and Toyota vehicles need to activate remote start. This wire comes on when remote start is activated and stays on for 20 seconds.

# RS-6800

## INSTALLATION MANUAL

## H6/4 WHITE / BLUE WIRE – (-) Instant Start & Turn Off Input –

This wire activates and turns off the remote starter each time it sees a momentary ground signal. Normally used for testing during installation or when activating the module from an :

## H6/5 WHITE WIRE – (-) 200mA Dome Light Control Output –

This wire becomes grounded when the dome light controls circuit active. The current capacity of this wire is 200mA.

This wire can control the operation of the interior lights. An optional 10 Amps relay can be used to this system for interior lights operation.

- Upon disarming, the interior lights will remain on for 30 seconds.
- If the alarm is triggered, the interior light will flash for the same duration as the siren.

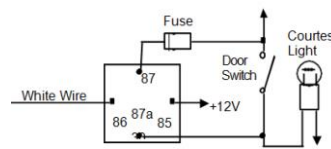

## H6/6 BROWN / WHITE WIRE – (-) 200mA Programmable Output Horn Output – (Factory default setting)

This wire is provided to use the existing vehicle's horn as the alarm system optional's warning audible device. It's a transistorized low current output, and should only be connected to the low current ground output from the vehicle's horn switch. When the system is triggered, the horn will sound. Factory Security Rearm Signal Output. This output is programmable. If programmed rearm a factory installed security system. This wire will supply a pulse whenever the remote start times out or is shut down using the transmitter and remote door locking.

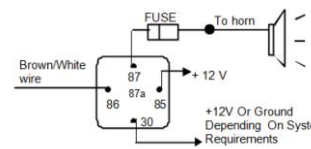

## H6/7 BLACK/GREEN WIRE – (-) 200mA Channel 4

Channel 4 Output (Factory default setting, Momentary grounded)

This wire is built-in user-programmable timer output provides a ground through this wire. Press the transmitter and buttons at the same time. You may program the built-in timer to send a ground signal for any time interval between 1 second and 2 minutes. For instance, this timer output may be used to turn on the headlight with the remote control. Also on certain BMW, Mercedes Benz, Jaguar and Volkswagen cars, you can use this unique timed output to allow remote closure of all power window and sunroof without the need for an external module!

## H6/8 BLACK/WHITE WIRE – (-) Neutral Safety Switch Input or (-) Enable Switch Input –

When the BLACK/WHITE wire is grounded, the remote start unit is operable. When this wire is open from ground, the remote start is disabled.

- The optional "remote start toggle switch" can be added on to temporarily disable the Remote Start Device, it can prevent the vehicle from being remote started accidentally. This feature is useful if the vehicle is being serviced or stored in an enclosed area. To disable the remote start, move the optional remote start enable toggle switch to the OFF position. To enable the remote start, move the optional remote start enable toggle switch to the ON position.
- If needed, this wire can connect to the PARK/NEUTRAL switch in the vehicle. (See the TESTING YOUR INSTALLATION GUIDE)

IMPORTANT NOTE: This wire must have a "GROUND" to operate remote start.

## H6/9 ORANGE/WHITE WIRE – 200mA Grounded Output when Disarmed - N.O. Disable

This wire will become grounded when the alarm is disarmed. The current capacity of this wire is 200mA. It can be connected to optional Ignition disable relay / ECU disable relay / Fuel Pump disable relay.

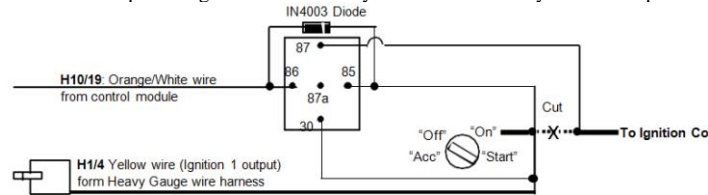

## H6/10 WHITE/RED WIRE – Tachometer Signal Connection –

Note: You should connect this wire if you program the Start Feature E – 2 to "Tachometer checking type", otherwise do not connect this wire and tap the end.

Note: No connection of this wire is required, if you use the voltage or timer checking type mode.

This input provides the remote start system with information about the engine's revolutions per minute (RPM). It can be connected to the negative side of the coil in vehicle with conventional coils. In multi-coil and high energy ignition system locating a proper signal may be more difficult. Once connected,

To test for a tachometer wire, a multi-meter capable of testing AC voltage must be used. The tachometer wire will show between 1V and 6V AC at idle, and will increase as engine RPM increases. In multi-coil ignition system, the system can learn individual coil wire. Individual coil wires in a multi-coil ignition system will register lower amounts of AC voltage. Also, if necessary, the system can use a fuel injector control wire for engine speed sensing. Common locations for a tachometer wire are the ignition coil itself, the back of the gauges, engine computers, and automatic transmission computers.

**IMPORTANT! Do not test tachometer wires with a test light or logic probe. The vehicle will be damaged. How to find a tachometer wire with your multi-meter**

- Set the ACV or AC voltage (12V or 20V is fine.)
- Attach the (-) probe of the meter to chassis ground.
- Start and run the vehicle.
- Probe the wire you suspect of being the tachometer wire with the red probe of the meter.
- If this is the correct wire the meter will read between 1V and 6V.

IMPORTANT NOTE: Must program the "Tach Signal" before trying to remote start.

## H6/11 BLUE/BLACK WIRE – (-) 200mA Accessory 2 Output –

This wire provides a 200mA (-) ground output. This output will energize when the remote start is activated, go away while the starter is cranking, and then come back on when the vehicle has started successfully.

## H6/12 WHITE/GREEN WIRE – (-) Diesel Wait To Start Input

In diesel vehicles it is necessary to interface with the wire that on the WAIT-TO-START light in the dashboard. This wire illuminates the bulb until the vehicle's glow plugs are properly heated. When the light goes out the vehicle can be started. This wire is always at the connector leading to the bulb in the dashboard. It can also be found at the Engine Control Module (ECM) in many vehicles.

To test and determine the polarity of this wire:

- Set your multi-meter to DCV or DC voltage (12V or 20V is fine).
- Attach the (+) probe of the meter to (+) 12V.
- Probe the wire that you suspect leads to the bulb with the (-) probe of the meter.
- Turn the ignition switch to the ON position.
- If the meter indicates 12 volts until the light goes out you have isolated the connect wire and the wire's polarity is negative (ground while the bulb is on).
- If the meter reads zero volts until the light goes out and then reads 12 volts, you have isolated the connect wire and the wire's polarity is positive.

Connect this wire to the wire in the vehicle that sends the signal to turn on the WAIT-TO-START bulb in the dashboard. In most diesels the wire is negative (ground turns on the bulb) and this wire can be directly connected to the wire in the vehicle. If the vehicles use a positive wire (12V to turn the bulb) a relay must be used to change the polarity.

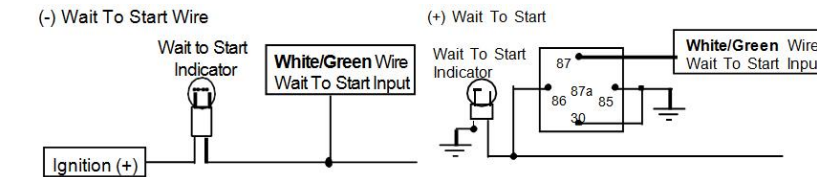

## H6/13 YELLOW WIRE – (-) 200mA Ignition 3 Output –

This wire provides a 200mA (-) ground output that becomes active 4 seconds before the remote start unit initialize, and remains grounded while running.

## Ignition 3 output:

Some newer vehicles use a third ignition wire which is required to start and keep the vehicle's engine running. If this is the case, wire an IGN 3 relay (not supplied) as shown below: Do not connect any vehicle circuits together, they are isolated for a reason.

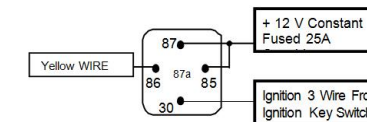

## Transponder interfacing using relay:

If the vehicle has a transponder system installed, you will need to by-pass the system while the vehicle is operating under the control of the Remote Start Unit.

To do this:

- You will need a transponder key that's already programmed to the vehicle.
- Remove the trim around the ignition switch.
- Wrap a thin (28 - 30awg) wire tightly around ignition switch 6 to 8 times and secure it.
- About 6" down line make another loop of approximately 2" diameter.
- Place the key inside this loop and secure it to the loop.
- Connect on end of the (28 - 30awg) wire to pin (87) of the relay module.
- Connect the other end of the loop wire to Pin (30) of relay module.
- Connect the pin (86) of the relay module to the ignition wire from the ignition switch.
- Connect the pin (85) of the relay module to the H6/13 yellow wire of 20-pin connector.

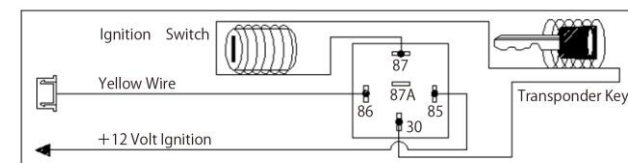

## GM VATS KEY OVERRIDE:

If the vehicle has the General Motor VATS system installed, you will need to by-pass the system while the vehicle is operating under the control of the Remote Start Unit. To do this:

1. Measure the resistance of the resistor pellet on the ignition key then select a resistor within 5% of the key's value.
2. Locate the pair of VATS wires in the vehicle, usually a pair of thin gauge wires running from the ignition switch to the VATS control module.
3. Connect the YELLOW wire from Remote Start Unit to TERMINAL #85 of an external relay. Connect terminal #86 of the relay to a fused +12 volt.
4. Cut (#1) wire (as shown), and connect the ignition switch side of the cut wire to terminal #87a of the relay. Connect the other side of the (#1) wire to terminal #30.
5. Connect the previously selected resistor from terminal #87 to the second (#2) wire (as shown).

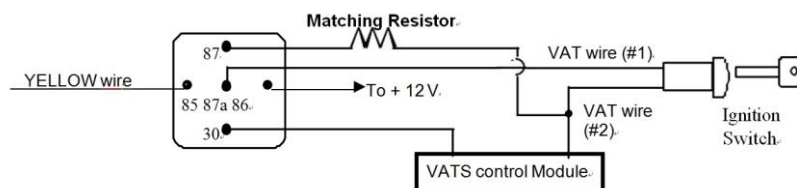

## H6/14 GREEN WIRE – Negative Door Switch Sensing Input (Zone 3) –

This wire is the ground trigger input wire for negative door pin switch. This wire is connection for "grounding" type factory door pins locate the "common wire" that connects the door pin switches. Make the connection of the GREEN Wire here.

## H6/15 GRAY WIRE – (-) 200mA Channel 3 Output –

This will become a 1 second pulse ground by activate (button 3) on transmitter for two seconds, the current capacity of this wire is 200 mA. This feature allows you to remote control trunk release or other electric device. (Relay may be required).

## H6/16 BLUE WIRE – Ground Instant Trigger Input (Zone 2) –

This wire is the ground trigger input wire for hood and or trunk pin switches

## H6/17 WHITE/VIOLET WIRE – Positive Safety Shut Down Input –

This wire provides an instant shutdown for the remote start, whenever it gets +12volts. If the brake lights switch in the vehicle switches +12 volts to the brake light circuit, connect this wire to the output side of the brake switch. This will allow the remote start to shut down if an attempt is made to operate the vehicle without the key while running under the control of the remote start. In most vehicles, in order to shift gear, the brake pedal must be depressed. The brake input will in turn cause the remote start unit to shut off. See diagram.

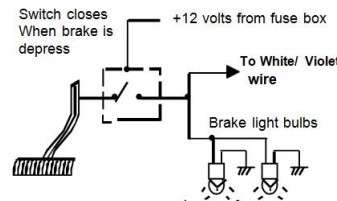

## H6/18 VIOLET WIRE – Positive Door Switch Sensing Input (Zone 3)–

This wire is the positive trigger input wire for positive door pin switch. This wire is connection for "positive" type factory door pins (typical FORD MOTOR). Locate the "common wire" for all door pins and make the connection of the VIOLET Wire here.

## H6/19 WHITE/BLACK WIRE – Negative Safety Shut Down Input – Hood trigger Input

The WHITE/BLACK wire provides an instant shutdown for the remote start, whenever it is grounded. Connect the wire to the hood pin switch previously installed. This wire must be routed through a grommet in the firewall and connected to the hood pin switch. This will also act as a hood trigger for the alarm system. Important! This connection is a safety wire and must be connected as shown and tested as specified. Failure to do so may result

in personal injury or property damage. See detail of wiring in the following diagram. This wire may also be used if the vehicle brake light circuit switches ground to the brake lights. An isolation diode must be used for ground switched brake light circuits and must be connected to the output of the brake switch. Vehicle brake light circuit switches ground to the brake lights. An isolation diode must be used for ground switched brake light circuits and must be connected to the output of the brake switch.



# RS-6800 INSTALLATION MANUAL

## H6/20 ORANGE WIRE – (-) 200mA Grounded Output When Armed –

This wire will become grounded when the alarm is armed. The current capacity of this wire is 200mA. This output can control starter disable, when an intrusion is detected and the system is triggered. The vehicles prevent from any unauthorized starting.

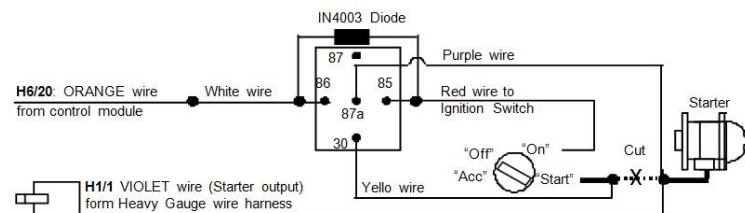

## H2. RS232 C I 3 SERIAL TWO-WAY DATA PORT CONNECTION:

This connector is to be used for Serial Data communications with idatalink modules by Auto Page only! DO NOT CONNECT THIS TO ANY OTHER WIRING!

This connector will transmit digital codes to operate all functions of Autopage data modules. When these modules are used, no other data bus connections need to be made to the RS-730. The Data Bus module will receive its commands directly from the CPU of the RS-730. This will provide greater theft protection as well as aid in the installation of this product. The RS-232 serial harness is provided with all Autopage serial data modules and is not included with the RS-730. This two-way data port has been designed for use with all C I 3 compatible components. C I 3 Telematics system is available at any authorized Autopage dealer.

This port will only operate correctly with Autopage C I 3 idatalink Modules.

## H4. 3 PIN DOOR LOCK CONNECTOR: (Maximum 500mA Output)

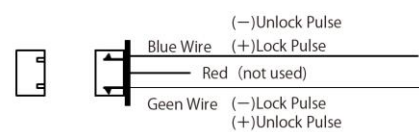

## NEGATIVE TRIGGER DOOR LOCK SYSTEM

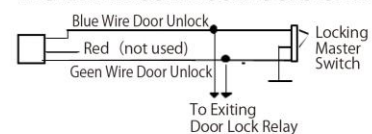

## 5-WIRE ALTERNATING DOOR LOCK

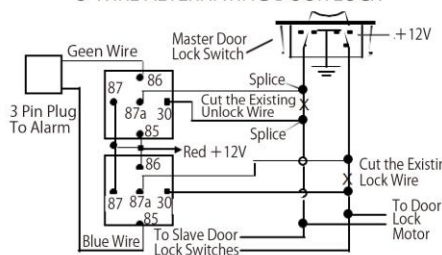

## POSITIVE TRIGGER DOOR LOCK SYSTEM

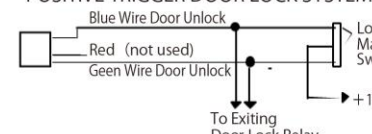

## VACUUM OPERATED CENTRAL LOCKING

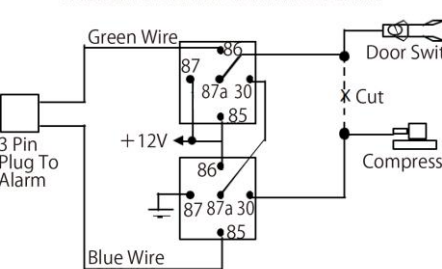

## VACUUM OPERATED DOOR LOCKING SYSTEM:

### TYPICAL OF MERCEDES BENZ AND AUDI.

Locate the wire under the driver's kick panel. Use the voltmeter connecting to ground, verify that you have the correct wire with the doors unlocked, the voltmeter will receive "12 volts". Lock the doors and the voltmeter will read "0 volt". Move the alligator clip to +12V and the voltmeter will receive "12 volts". Cut this wire and make connections. Be sure to program door lock timer to 3.5 seconds.

## 2 STEP DOOR UNLOCK WIRE CONNECTION FOR 5 WIRE ALTERNATING DOOR LOCKS

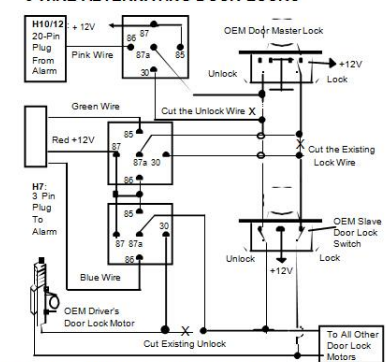

## 2 STEP DOOR UNLOCK WIRE CONNECTION FOR GROUND SWITCHED DOOR LOCKS

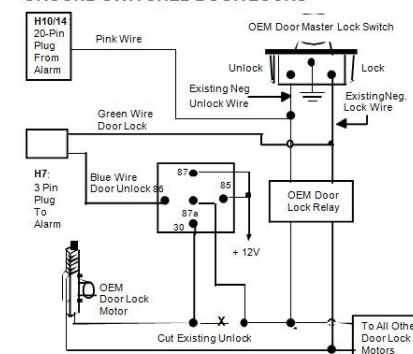

## 2 STEP DOOR UNLOCK WIRE CONNECTION FOR POSITIVE SWITCHED DOOR LOCKS

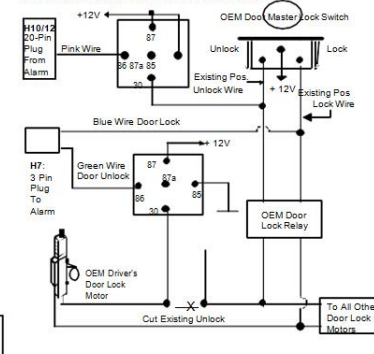

## PROGRAMMING

### PROGRAMMING TRANSMITTER:

- Note: This mode will only retain the last 4 remote transmitters programmed. If the transmitter memory is exceeded, the security system will start deleting transmitters from memory in chronological order.
1. Turn the Ignition 'switch 'OFF/ON' 3 TIMES and stay in ON position. "Within 15 seconds".
  2. Push the Valet switch 2 times and hold it on the 2nd push until a long chirp is heard then release the valet switch. You are now in the Transmitter programming mode.
  3. Press and hold any button of the transmitter until the siren responds with a confirming chirp, indicating the signal has been stored into memory.
  4. If you have additional transmitters (up to 4) that need to be programmed, repeat step 3 for each transmitter.
- Exit: Turn Ignition to 'OFF' position, or leave it for 15 seconds. 3 long chirps & 3 parking light flashes will confirm exit.

## Feature

### 1-01 TX/HHU FUNCTION TABLE

System function	Buttons
Standard arming / doors lock in Valet mode / door lock while driving	#1
Arming with prewarning zone bypass	#1 at any time when armed
Arming with all sensors zones bypass	#1 at any time when armed and prewarning zone had bypassed
Cancel sensor bypass	#1 at any time when armed and all sensor zones had bypassed
Silent arming	#1 press and hold for 1.5 sec
Arming with silent alarm mode	#3 then within 4 sec #1
Silent arming with silent alarm mode	#3 then within 4 sec #1 hold for 1.5 sec
Standard disarming / doors unlock in Valet mode / door unlock while driving	#2
Disarming with 2nd unlock door pulse	#2 at any time when disarmed
Silent disarming	#2 press and hold for 1.5 sec
Channel 3	#3 press and hold for 1.5 sec
Channel 4	#3 then within 4 sec #2
Remote Panic mode on (ign off) / Remote AHJ on (ign on)	#1 + #2 press and hold for 1.5 sec
Remote Panic mode off / car finder	#1 + #2
Remote Valet mode on/off	#2 + #3 press and hold for 1.5 sec at any time when disarmed
System trigger mode stop	#1 or #2
Remote engine start/stop	#4 then within 4 sec #4
Engine run time extension for 1 cycle	#4 then within 4 sec #4 press and hold for 1.5 sec

### HHU special functions :

System function	Buttons
System status check	#1 + #4
Temperature check	#2 + #4
HHU trigger mode stop	#1 or #2 or #3 or #4
LCD backlight on for 5 sec	#4
Beeper / Vibro / Beeper+Vibro selection	#3 + #4
Power saving	#2 + #4 press and hold for 1.5 sec
Buttons lock / unlock	#3 then within 4 sec #4
Alarm clock on / off	#1 + #4 press and hold for 1.5 sec
Countdown timer on / off	#3 + #4 press and hold for 1.5 sec
HHU menu	#4 press and hold for 1.5 sec

### 1-02 TX/HHU PROGRAM MODE

#### 【Enter TX/HHU PROGRAM MODE】

- In DISARMED MODE
  - IGN OFF→ON, and stay in ON position.
  - VALET SW ON→OFF 3 times, you are now in the "TX/HHU PROGRAM MODE", SIREN O/P 3 CHIRP, LED O/P flash slow.
  - VALET SW stay in OFF position, press TX or HHU BTN1/BTN2, if TX/HHU are successfully learnt.
    - SIREN O/P 1 LONG CHIRP.
    - LED O/P 1.5s, after 1.5s, LED keeps blinking.
    - Main module loads 15s.
- Main module answers HHU, and if HHU is successfully paired to main module ID,
- HHU beeps once.
  - LCD backlight lights on 5second.

#### 【Exit TX/HHU PROGRAM MODE】

- Under the following conditions, the system exits TX/HHU PROGRAM MODE, siren outputs 1 short and 1 long chirp, and LED stops blinking.
- IGN OFF
  - TX/ HHU is not found within 15s.

# RS-6800

## OPERATION MANUAL

### 1-03 FEATURE PROGRAM MODE

#### 【Enter FEATURE PROGRAM MODE】

- Make main module enter TX/HHU PROGRAM MODE
  - Siren outputs 3 chirps.
  - LED blinks.
  - Main module loads 15s
- Under TX/HHU PROGRAM MODE, IGN on→off, main module will exit TX/HHU PROGRAM MODE
  - Siren outputs 1 short + 1 long chirps.
  - LED stop blinking.
  - Main module loads 15s
- Within 15s, IGN off→ on, main module enters MENU#1 of FEATURE PROGRAM MODE
  - Siren outputs as option set.
  - LED blinks to indicate which feature item is a user staying.
  - Main module loads 15s.
- Press Valet S/W and hold for 3s, main module will enter MENU#1/2
  - Siren outputs as option set.
  - LED blinks to indicate which feature item is a user staying.
  - Main module loads 15s.
- Under MENU # 1/2, VALET ON→OFF "N" times, system enters to the "N" item of MENU#1/2.
  - Siren outputs as option set.
  - LED blinks to indicate which feature item is a user staying.
  - Main module loads 15s.
- Under any item of MENU # 1/2
  - Press BTN1, switch to Option 1; main module loads 15s.
  - Press BTN2, switch to next option; main module loads 15s.

#### 【Exit FEATURE PROGRAM MODE】

- Under the following conditions, the system exits FEATURE PROGRAM MODE, siren outputs 1 long chirp, and LED stops blinking.
- IGN OFF
  - Feature is not changed within 15s.

#### 【FEATURE TABLE】

##### FIRST MENU OF PROGRAMMABLE FUNCTION

Option	CHIRP 1	CHIRPS 2	CHIRPS 3	CHIRPS 4	CHIRPS 5
F1.01	Passive Arming Off	Passive Arming On With Door Lock	Passive Arming On Without Door Lock		
F1.02	Automatic Rearming Off	Auto Rearming With Door Lock	Auto Rearming Without Doors Lock		
F1.03	Siren Chirp Off	Siren Chirp On			
F1.04	Auto Lock Off	Auto Lock By IGN On			
F1.05	Auto Unlock Off	Auto Unlock On			
F1.06	Valet	Code			
F1.07	Automatic AHJ Off	Automatic AHJ On			
F1.08	"Engine Run Time" 10 Min	"Engine Run Time" 15 Min	"Engine Run Time" 20 Min	"Engine Run Time" 25 Min	"Engine Run Time" 30 Min
F1.09	"Turbo Mode Time" 1 Min	"Turbo Mode Time" 3 Min	"Turbo Mode Time" 5 Min	"Turbo Mode Time" Set By Engine Run Time	
F1.10	Parking Lights Off While Engine Is Running	Parking Lights Flashing While Engine Is Running	Parking Lights On While Engine Is Running		
F1.11	"Siren Output" 50ms	"Siren Output" 20ms			
F1.12	"Horn Output" 50ms	"Horn Output" 20ms			

### PASSIVE ARMING

When under PASSIVE ARMING ON WITH DOOR LOCK or PASSIVE ARMING ON WITHOUT DOOR LOCK:  
Main module under DISARMED MODE, IGN on→off, Door on→off, then activate PASSIVE ARMING countdown 30s.

- Siren outputs 1 chirp.
- LED quickly blinks.
- Lock icon  on HHU keeps blinking.

### AUTO LOCK

"AUTO LOCK BY IGN ON"

- Main module is in DISARMED MODE or VALETED MODE
- IGN OFF→ON & DOOR OFF, after 3s, lock outputs.

### AUTO UNLOCK

ON

- Main module is in DISARMED MODE or VALETED MODE
- IGN OFF→ON & DOOR OFF, after 3s, unlock outputs.

### VALET/CODE

Used to choose the way to OVERRID VALET

- VALET SW OFF, IGN OFF→ON, main module loads 15s.
- Within 15s, VALET SW OFF→ON, OVERRIDE O.K, main module comes back to FULL DISARMED MDOE.

#### CODE

##### 【Use 1 set of pin code to enter】

- IGN OFF→ON, main module loads 5s.
- IGN ON→OFF, main module loads 5s.
- IGN OFF→ON, main module loads 15s.
- Within 15s, use VALET SW to key in PIN CODE, then IGN ON→OFF, main module loads 5s.
- Within 5s, IGN OFF→ON, OVERRID O.K., main module comes back to FULL DISARMED

##### 【Use 2 set of pin code to enter】

- IGN OFF→ON, main module loads 5s.
- IGN ON→OFF, main module loads 5s.
- IGN OFF→ON, main module loads 15s
- Within 15s, use VALET SW to key in the first PIN CODE, then IGN ON→OFF, main module loads 5s.
- Within 5s, IGN OFF→ON, main module loads 15s.
- Within 15s, use VALET SW to key in the 2nd PIN CODE, then IGN ON→OFF, main module loads 5s.
- Within 5s, IGN OFF→ON, OVERRID O.K., main module comes back to FULL DISARMED MODE

### AUTOMATIC AHJ

If feature table set in OFF :

IGN ON, PRESS button 1+2 for 1.5s, can activate ANTI-HIJACK

If feature table set in ON :

Following steps can activate ANTI-HIJACK function:

- IGN ON, PRESS button 1+2 for 1.5s, can activate ANTI-HIJACK
- IGN ON, DOOR OFF→ON, can activate ANTI-HIJACK

\* If ANTI-HIJACK is activated :

- Siren output 1 chirp.
- LED output 5s.
- HHU output 1 beep, icon  blinks 5times then solid on.

### SECOND MENU OF PROGRAMMABLE FUNCTION

Option	CHIRP 1	CHIRPS 2	CHIRPS 3	CHIRPS 4	CHIRPS 5	CHIRPS 6
F2.01	"Arming Delay" 3 Sec	"Arming Delay" 10 Sec	"Arming Delay" 45 Sec			
F2.02	"Door Lock/Unlock Pulse" 1 sec. Lock / 1 sec. Unlock	"Door Lock/Unlock Pulse" 3 sec. Lock / 3 sec. Unlock	"Door Lock/Unlock Pulse" Double Lock / 1 sec. Unlock	"Door Lock/Unlock Pulse" 1 sec Lock / Double Unlock	"Door Lock/Unlock Pulse" 10 Sec. Lock / 1 Sec Unlock	"Door Lock/Unlock Pulse" 28 Sec. Lock / 1 Sec Unlock
F2.03	"Relock Doors In 1 Sec After Engine Stops By RS" Off	"Relock Doors In 1 Sec After Engine Stops By RS" On				
F2.04	"Violet Wire Function" Door Input(+)	"Violet Wire Function" CDL Input(+)				
F2.05	"Green Wire Function" Door Input(-)	"Green Wire Function" CDL Input(-)				
F2.06	"CH3 Output" Trunk Release	"CH3 Output" Pulsed	"CH3 Output" Latched	"CH3 Output" 30 Sec		
F2.07	"CH4 Output" Pulsed	"CH4 Output" Latched	"CH4 Output" 30 Sec	"CH4 Output" 90 Sec	"CH4 Output" Windows Roll Up	
F2.08	"Pink Wire Function" Factory Disarm	"Pink Wire Function" 2nd Unlock				
F2.09	"Brown/White Wire Function" Factory Rearm	"Brown/White Wire Function" Horn				
F2.10	"Engine Check" Off	"Engine Check" By TACH	"Engine check" by DBI bypass module			
F2.11	"Starter Crank Time" 0.6 Sec	"Starter Crank Time" 1.0 Sec	"Starter Crank Time" 1.4Sec	"Starter Crank Time" 1.8 Sec	"Starter Crank Time" 2.5 Sec	"Starter Crank Time" 4.0 Sec
F2.12	"Starter Delay Time" 2.0 Sec	"Starter Delay Time" 6.0 Sec	"Starter Delay Time" 10 Sec			
F2.13	"ACC Delay Time" 0 Sec	"ACC Delay Time" 30 Sec	"ACC Delay Time" 1 Min	"ACC Delay Time" 2 Min		
F2.14	Turbo Mode Off	Turbo Mode On				
F2.15	"RST Activate Pulse" 1 Pulse	"RST Activate Pulse" 2 Pulse	"RST Activate Pulse" 3 Pulse			

#### ARMING DELAY

##### 【ARMING DELAY 03 SEC】

1. When disarm → arm, System bypasses door detect 3s after door is closed.

##### 【ARMING DELAY 10/45 SEC】

1. disarm → arm, System bypasses door detect 10s or 45s after door is closed.

2. If within ARMING DELAY countdown 10 or 45s, system detects door off for 3s:

- (1) Door trigger starts to be ready.
- (2) Shot down ARMING DELAY

#### VIOLET WIRE FUNCTION

##### 【FEATURE IN CDL(+)]

1. When system is in DISARMED MODE,

(1) If user press central door lock switch, system unlock the door; but there is no 2nd unlock output. (depends on real use situation)

(2) If user press central door lock switch, system lock the door. (depends on real use situation)

2. When system is in ARMED MODE,

(1) System will alert when detects someone open the door.

(2) No DOOR DEFECT BYPASS

#### GREEN WIRE FUNCTION

##### 【FEATURE IN CDL(-)]

1. When system is in DISARMED MODE,

(1) If user press central door lock switch, system unlock the door; but there is no 2nd unlock

output. (depends on real use situation)

(2) If user press central door lock switch, system lock the door. (depends on real use situation)

2. When system is in ARMED MODE,

(1) System will alert when detects someone open the door.

(2) No DOOR DEFECT BYPASS

#### CH4 OUTPUT

FEATURE IN "WINDOWS ROLL UP" :

System outputs 30s to roll up window after user armed the car.

#### STARTER CRANK TIME

1. When # "ENGINE CHECK" is selected in "off", Starter outputs as STARTER CRANK TIME specified.

2. When # "ENGINE CHECK" is selected in "BY TACH" or "BY DBI BYPASS MODULE", STARTER outputs 1.8s.

#### 1-04 PIN CODE PROGRAM MODE

1. Default PIN CODE is 2 sets; the 1st pin code is 1; the 2nd pin code is also 1.

2. If F1.06 is selected in "CODE", can enter PIN CODE PROGRAM MODE.

##### 【ENTER PIN CODE PROGRAM MODE】

1. The way to enter PIN CODE PROGRAM MODE if there is only one set of PIN CODE:

- (1) IGN ON → OFF → ON, key in PIN CODE.
- (2) IGN ON → OFF, module loads 5s.

The way to enter PIN CODE PROGRAM MODE if there are 2 sets of PIN CODE:

- (1) IGN ON → OFF → ON, key in 1st PIN CODE.
- (2) IGN OFF → ON, key in 2nd pin code.
- (3) IGN ON → OFF, main module loads 5s.

2. Within 5s, VALET SW ON/OFF 5 times, main module enter PIN CODE PROGRAM MODE

- (1) SIREN output 1 short + 1 long chirps.
- (2) Main module loads 5s.

3. If system is in PIN CODE PROGRAM MODE

- (1) Press BTN1, enters DIGIT-1 PROGRAM PART, siren output 1 chirp, system loads 15s.
- (2) Press BTN2, enters DIGIT-2 PROGRAM PART, siren output 2 chirps, system loads 15s.
4. When system under DIGIT-1 PROGRAM PART, valet sw on/off "N" times, after 1s, system will
  - (1) Change DIGIT-1 = {N}
  - (2) Remove DIGIT-2 to {0}
  - (3) Store the latest pin code to EEPROM, pin code → only 1 pin code.
  - (4) Siren outputs "N" chirps as confirmation to indicate that DIGIT-1 is set successfully.
  - (5) System loads 15s
  - (6) HHU shows PIN CODE value which is learnt and last for 5s.

5. When system under DIGIT-2 PROGRAM PART, valet sw on/off "N" times, after 1s, system will

- (1) Remain DIGIT-1 unchanged.
- (2) DIGIT-2 be changed to {N}
- (3) Store latest PIN CODE to EEPROM, pin code set becomes 2 sets of pin code.
- (4) Siren outputs "N" chirps as confirmation to show that DIGIT-2 is set successfully.
- (5) System loads 15s
- (6) HHU shows PIN CODE value which is learnt for 5s.

\* 9 times if VALET SW ON / OFF is 9 or more times.

\* When the HHU receives the response message "PIN CODE REPORT" of the corresponding host, it is displayed for 5 seconds.

##### 【EXIT PIN CODE PROGRAM MODE】

Siren outputs 1 short +1 long chirps to exit PIN CODE PROGRAM MODE if one of the following conditions is completed:

- (1) IGN ON
- (2) 15s times up.

#### 1-05 TACH PROGRAM MODE

##### 【Enter TACH PROGRAM MODE】

1. System under DISARMED MODE
2. IGN OFF → ON, system loads 15s
3. Within 15s, press VALET SW OFF → ON and hold for 1s, system enters TACH PROGRAM MODE

(1) If system detects right TACH signal value (1HZ ~ 260HZ), LED solid on.

(2) If system hasn't detected correct TACH signal value (1HZ ~ 260HZ) over 1.5s, or even hasn't detected TACH value, then LED output stops.

##### 【EXIT TACH PROGRAM MODE】

1. LED stops output and exits TACH PROGRAM MODE if one of the following conditions is completed

- (1) IGN ON → OFF.
- (2) VALET SW ON → OFF.

2. If system detects right TACH value and exits TACH PROGRAM MODE, new TACH value will be stored, light blinks 1 time.

#### 1-06 FACTORY RESET TO DEFAULT SETTINGS

##### 【RESET FEATURES】

1. System enters FEATURE PROGRAM MODE

2. Press and hold BTN1+2, system exits FEATURE PROGRAM MODE regardless of in MENU#1/2

- (1) Siren outputs 2 short +1 long chirps
- (2) LED stops blinking
- (3) Recover to default feature setting.

\* # "VALET/CODE" will not be recovered to default setting.

\* PIN CODE will not be recovered to default setting.

\* FEATURE "DAILY START FOR PRESET TIME, remained unchanged.

#### 1-07 AUTO START FEATURE PROGRAM MODE

##### 【AUTO TIMER START PROGRAM MODE】

1. Press BTNF on HHU, HHU enters AUTO TIMER START PROGRAM MODE

2. When HHU under HHU MENU PROGRAM MODE, **TIMER** icon blinks.

(1) Press BTN1 and BTN2 to select timer: OFF/1H/2H/3H/4H/24H

(2) HHU sends the value user selected to module, then main module will:

(a) Light output short blink to show value "OFF"

Light output 2 short blinks to show value "1HR".

Light output 3 short blinks to show value "2HR".

Light output 4 short blinks to show value "3HR".

Light output 5 short blinks to show value "4HR".

Light output 6 short blinks to show value "24HR".

(b) Then main module sends signal to HHU, HHU outputs 1 BEEP as confirmation.

(3) Press and hold BTN4 for 1.5s, HHU exits HHU MENU PROGRAM MODE

Press BTN4, HHU exits TIMER START

### 【Enter AUTO TEMPERATURE START PROGRAM MODE】

1. Press BTN F to enter AUTO TEMPERATURE START PROGRAM MODE
2. Under TEMPERATURE START of HHU MENU PROGRAM MODE, HHU

blinks **TEMP**

- (1) Press BTN1/ BTN2 to select temperature: OFF/32°F/23°F/14°F/5°F.
- (2) HHU sends the value user selected to module, then main module will:
  - (a) Light output short blink to show value "OFF"
    - Light output 2 short blinks to show value "32°F".
    - Light output 3 short blinks to show value "23°F".
    - Light output 4 short blinks to show value "14°F".
    - Light output 5 short blinks to show value "5°F".
- (b) Then main module sends signal to HHU, HHU outputs 1 BEEP as confirmation.
- (3) Press and hold BTN4 for 1.5s, HHU exits HHU MENU PROGRAM MODE Press BTN4, HHU exits TEMPERATURE START

### 【enter AUTO DAILY START PROGRAM MODE】

1. Press BTN F to enter DAILY START(HR) OF HHU MENU PROGRAM MODE
2. Press BTN1/ BTN2 to select HR value; press BTN3 to select MIN.
3. Then press BTN 3 to enter DAILY START(ON/OFF) setting.
4. Under DAILY START(ON/OFF) setting mode, press BTN1 to select "on"; press BTN2 to select "off".
  - (1) HHU sends value to main module if setting is changed; then main module will:
    - (a) Light output short blink to show value "OFF"
      - Light output 2 short blinks to show value "ON".
    - (b) Then main module sends signal to HHU, HHU outputs 1 BEEP as confirmation.
  - (2) Press and hold BTN4 for 1.5s, HHU exits HHU MENU PROGRAM MODE Press BTN4, HHU exits DAILY START

### 1-08 TRIGGER ZONE TEST MODE

#### 【ENTER TRIGGER ZONE TEST MODE】

1. In DISARMED MODE.
2. IGN ON→OFF 3 times and stay in OFF position
3. VALET OFF→ON 11 times, press and hold the button at the 11th time, siren outputs 5 short +1 long chirps, system enters HOOD/TRUNK/DOOR ZONE TEST MODE of TRIGGER ZONE TEST MODE, system loads 20 mins test time.

#### 【TRIGGER ZONE TEST MODE - HOOD/TRUNK/DOOR ZONE TEST】

1. If detects HOOD INPUT, siren outputs 2 short chirps.
  - If detects TRUNK INPUT, siren outputs 2 short chirps.
  - If detects DOOR INPUT, siren outputs 3 short chirps.
2. Press TX/HHU BTN2 CMD to switch to SENSOR ZONE TEST MODE
  - (1) Siren outputs 2 chirps.
  - (2) HHU buzzer outputs 2 chirps.

#### 【TRIGGER ZONE TEST MODE - SENSOR ZONE TEST MODE】

1. If detects PREWARN INPUT, siren outputs 1 short chirps.
  - If detects SENSOR INPUT, siren output 1 long chirp.
2. Press TX/HHU BTN2 CMD to switch to HOOD/TRUNK/DOOR ZONE TEST MODE
  - (1) Siren outputs 1 chirp.
  - (2) HHU buzzer outputs 1 chip.

#### 【EXIT TRIGGER ZONE TEST MODE】

1. One of the following actions will let system exit TRIGGER ZONE TEST MODE:
  - (1) Press TX/HHU BTN1
  - (2) IGN ON
  - (3) 20mins time up.

2. System goes back to DISARMED MODE

- (1) Siren outputs 3 long chirps
- (2) Light output blink 3 times.
- (3) HHU buzzer outputs 1 chirp.

### OPTION

#### 2-01 REMOTE SENSOR BYPASS

1. System under DISARMED MODE
2. Change system to Armed mode, loads 5s.
3. During these 5s, press BTN1 to activate BYPASS PREWARN
  - (1) main module will BYPASS PREWARN
  - (2) main module will BYPASS SENSOR for 3s.
  - (3) light short blinks 2 times.
  - (4) HHU buzzer outputs 1 beep.

4. Within 5s, press btn1 to activate BYPASS PREWARN & SENSOR.

- (1) main module BYPASS PREWARN
- (2) main module BYPASS SENSOR
- (3) Light outputs 3 short blinks.

- (4) HHU buzzer outputs 1 beep and shows 

#### 2-02 MANUAL ARMING

【activate MANUAL ARMING】

1. When system in "PASSIVE ARMING OFF" and main module under DISARMED MODE
2. DOOR OPEN, VALET OFF, IGN OFF→ON, system loads 10s.
3. Within these 10s, VALET SW OFF→ON and last for 2s, system activates MANUAL ARMING
  - (1) Siren outputs 1 chirp.

#### 【Activate MANUAL ARMING 30s countdown】

1. If MANUAL ARMING is activated, IGN OFF, DOOR ON→OFF, then activate MANUAL ARMING 30s countdown
  - (1) Siren outputs 1 chirp
  - (2) Horn outputs 1 chirp
  - (3) LED short blinks
  - (4) HHU blinks 
2. After 30s, system enters ARMED MODE

#### 2-03 QUICK PASSIVE BYPASS

【activate】

1. When system under DISARMED MODE
2. IGN OFF →ON, system loads 5s
3. Within these 5s, IGN ON→OFF→ON→OFF, activate QUICK PASSIVE BYPASS
  - (1) Siren outputs 1 long chirp.
  - (2) Horn outputs 1 long chirp.
  - (3) PASSIVE ARMING 30s is temporarily closed.
  - (4) MANUAL ARMING 30s is temporarily closed.

【deactivate】

1. IGN on, deactivates QUICK PASSIVE BYPASS

#### 2-04 VALETED MODE

Enter valeted mode by TX/HHU

1. System under disarmed mode, IGN off.

2. Press key combo of REMOTE VALET ON/OFF of TX/HHU, system enters VALETED MODE

- (1) Siren outputs 1 chirp

- (2) LED solid on.

- (3) HHU outputs 1 beep and shows  icon.

#### 【Exits valeted mode by TX/HHU】

1. System under VALETED MODE, OFF
2. Press key combo of REMOTE VALET ON/OFF of TX/HHU, system exits VALETED MODE, and comes back to DISARMED MODE
  - (1) Siren outputs 2 chirps.
  - (2) LED off

- (3) HHU outputs 1 beep and  off

#### 【Enter VALETED MODE by VALET SW】

1. System under DISARMED MODE, IGN ON→OFF, main module loads 15s.
2. Within these 15s, IGN off, VALET SW OFF →ON and lasts for 2s, main module enters VALETED MODE
  - (1) Siren outputs 1 chirp.
  - (2) LED solid on

- (3) HHU outputs 1 beep, and shows  icon

#### 【Exits VALETED MODE by VALET SW】







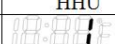

1. System under VALETED MODE, IGN ON→OFF, main module loads 15s
  - (1) Siren outputs 2 chirps
2. Within 15s, VALET SW ON/OFF, main module exits VALETED MODE and comes back to DISARMED MODE
  - (1) Siren outputs 2 chirps
  - (2) LED off

- (3) HHU outputs 1 beep,  off

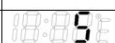
#### 2-05 VOLTAGE STATUS DETECT

1. If system under ARMED MODE, not in REMOTE START, it detects voltage; if voltage under 6V and lasts over 40ms,
  - (1) System POWER ON TRIGGER 1 time.

#### 2-06 RST SHUTDOWN REPORT DISPLAY

SHUTDOWN	HHU
RUNNING TIME	
1. # "ENGINE CHECK" is set to "BY TACH" and the TACH value recognized when the TACH signal exceeds 5 times	
2. # "ENGINE CHECK" is set to "BY DBI BYPASS MODULE", when the DBI RPM signal is detected, it takes 1 second for 3500 RPM	
1. # "ENGINE CHECK" is set to "BY TACH", there is a detected TACH signal, but the condition of entering RST RUNNING is not reached	
2. # "ENGINE CHECK" is set to "BY TACH" and no TACH signal is detected	
3. # "ENGINE CHECK" is set to "BY DBI BYPASS MODULE", detected DBI RPM signal is lower than 350RPM	
4. # "ENGINE CHECK" is set to "BY DBI BYPASS MODULE" and no DBI RPM signal is detected	
1. Start any REMOTE START and then press "REMOTE ENGINE START / STOP" TX / HHU	
2. The number of ACTIVATION SW OFF→ON has been detected (Number of times set by # "RST ACTIVATE PULSE")	
1. HOOD is ON, but can not start any REMOTE START	
2. DISARMED MODE, HOOD OFF→ON after starting any REMOTE START	 Blinks 5 times
1. When BRAKEPEDAL (+) is ON and no REMOTE START can be started	
2. Activate any REMOTE START, BRAKEPEDAL (+) OFF→ON	 Blinks 5 times
3. When SAFETY (-) is OFF and any REMOTE START can not be started	
4. Activate any REMOTE START, SAFETY (-) ON→OFF	
1. After activating any REMOTE START, it will not enter RST RUNNING MODE due to GLOW PLUG (-) ON and GLOW PLUG (-) ON for more than 3 minutes	

### 2-07 SHORT STOP MODE

1. When system under DISARMED MODE
2. IGN OFF → ON, after 1s, system judge engine running status by setting in #ENGINE CHECK
3. If engine is running, IGN on, press key combo of REMOTE ENGINE START/STOP, system REMOTE START(SHORT STOP PREPARATION) immediately, and enters RST RUNNING MODE, RUNNING TIME = 1 min
4. After activate REMOTE START(SHORT STOP PREPARATION)
  - (1) Within 1min, system armed, and main module switch to REMOTE
  - (2) RUNNING TIME = 30 mins if switch to REMOTE START(SHORT STOP)

### 2-08 TURBO MODE

1. System under DISARMED MOD & "TURBO MODE" ON
2. 1s after IGN OFF → ON, system judges whether engine is running or not by settings in ENGINE CHECK
3. If engine is running, 7ms after IGN I/P ON → OFF, main module REMOTE START(TURBO PREPARATION), RUNNING TIME = 1 min

4. After REMOTE START(TURBO PREPARATION) is activated
  - (1) Switch system to ARMED MODE within 1 min, main module will change to REMOTE START (TURBO); RUNNING TIME = settings in TURBO MODE TIME

### 2-09 RST RUNNING TIME EXTENSION

1. If REMOTE START is activated and enters RST RUNNING MODE, RUNNING TIME

### 2-09 RST RUNNING TIME EXTENSION

1. If REMOTE START is activated and enters RST RUNNING MODE, RUNNING TIME < 90 mins, press key combo of ENGINE RUN TIME EXTENSION FOR 1 CYCLE
  - (1) If system not in REMOTE START (TURBO), then system adds RUNNING TIME according to settings in ENGINE RUN TIME
  - If system in REMOTE START(TURBO), system adds RUNNING TIME according to settings in #TURBO MODE TIME
  - (2) Light outputs 3 short blinks
  - (3) HHU shows RUNNING TIME countdown,  blinks, buzzer outputs 1 beep.

### 2-10 activate REMOTE START

Under IGN OFF, can remote start by follow steps

- (1) REMOTE START(NORMAL START). (TX/HHU, ACTIVATION SW)
- (2) REMOTE START(DAILY START). (ARMED MODE)
- (3) REMOTE START(TIMER START). (ARMED MODE)
- (4) REMOTE START(TEMPERATURE START). (ARMED MODE)

\* Each time REMOTE START is activated, the total number of attempts to start is 3.

\* If REMOTE START (DAILY START) is activated, it will blink continuously 

\* If REMOTE START (TIMER START) is activated, it will blink continuously 

\* If REMOTE START (TEMPERATURE START) is activated, it will blink

continuously 

### Warning! Safety first

The following safety warnings must be observed at all times:

Due to the complexity of this system, installation of this product must only be performed by an authorized VARAD / Auto Page dealer.

When properly installed, this system can start the vehicle via a command signal from the remote control transmitter. Therefore, never operate the system in an enclosed area or partially enclosed area without ventilation (such as a garage). When parking in an enclosed or partially enclosed area or when having the vehicle serviced, the remote start system must be disabled using the installed toggle switch. It is the user's sole responsibility to properly handle and keep out of reach from children all remote control transmitters to assure that the system does not unintentionally remote start the vehicle. THE USER MUST INSTALL ACARBON MONOXIDE DETECTOR IN OR ABOUT THE LIVING AREA ADJACENT TO THE VEHICLE. ALL DOORS LEADING FROM ADJACENT LIVING AREAS TO THE ENCLOSED OR PARTIALLY ENCLOSED VEHICLE STORAGE AREA MUST AT ALL TIMES REMAIN CLOSED. These precautions

are the sole responsibility of the user.

Use of this product in a manner contrary to its intended mode of operation may result in property damage, personal injury, or death.

- (1) Never remotely start the vehicle with the vehicle in gear, and
- (2) Never remotely start the vehicle with the keys in the ignition. The user must also have the neutral safety feature of the vehicle periodically checked, wherein the vehicle must not remotely start while the car is in gear. This testing should be performed by an authorized VARAD / AutoPage dealer in accordance with the Safety Check outlined in the product installation guide. If the vehicle starts in gear, cease remote start operation immediately and consult with the authorized VARAD / Auto Page dealer to fix the problem. After the remote start module has been installed, contact your authorized dealer to have him or her test the remote start module by performing the Safety Check outlined in the product installation guide. If the vehicle starts when performing the Neutral Safety Shutdown Circuit test, the remote start unit has not been properly installed. The remote start module must be removed or the installer must properly reinstall the remote start system so that the vehicle does not start in gear. All installations must be performed by an authorized VARAD / Auto Page dealer.

OPERATION OF THE REMOTE START MODULE IF THE VEHICLE STARTS IN GEAR IS CONTRARY TO ITS INTENDED MODE OF OPERATION.

OPERATING THE REMOTE START SYSTEM UNDER THESE CONDITIONS MAY RESULT IN PROPERTY DAMAGE OR PERSONAL INJURY. YOU MUST IMMEDIATELY CEASE THE USE OF THE UNIT AND SEEK THE ASSISTANCE OF AN AUTHORIZED VARAD TO REPAIR OR DISCONNECT THE INSTALLED REMOTE START MODULE. VARAD WILL NOT BE HELD RESPONSIBLE OR PAY FOR INSTALLATION OR REINSTALLATION COSTS.

### FCC COMPLIANCE

This device complies with part 15 of the FCC Rules. Operation is subject to the following two conditions:

- (1) This device may not cause harmful interference, and
- (2) This device must accept any interference received, including interference that may cause undesired operation.

This equipment has been tested and found to comply with the limits for a Class B digital device, pursuant to part 15 of the FCC Rules. These limits are designed to provide reasonable protection against harmful interference in a residential installation. This equipment generates uses and can radiate radio frequency energy and, if not installed and used in accordance with the instructions, may cause harmful interference to radio communications.

However, there is no guarantee that interference will not occur in a particular installation. If this equipment does cause harmful interference to radio or television reception, which can be determined by turning the equipment off and on, the user is encouraged to try to correct the interference by one or more of the following measures:

- Reorient or relocate the receiving antenna.
- Increase the separation between the equipment and receiver.
- Connect the equipment into an outlet on a circuit different from that to which the receiver is connected.
- Consult the dealer or an experienced radio/TV technician for help.

### Warning!

Changes or modifications not expressly approved by the part responsible for compliance could void the user's authority to operate the equipment

NOTE: The manufacturer is not responsible for any radio or TV interference caused by unauthorized modifications to this equipment. Such modifications could void the user's authority to operate the equipment.

