

sonorix

A1 Bluetooth
Handsfree
Kit

USER MANUAL

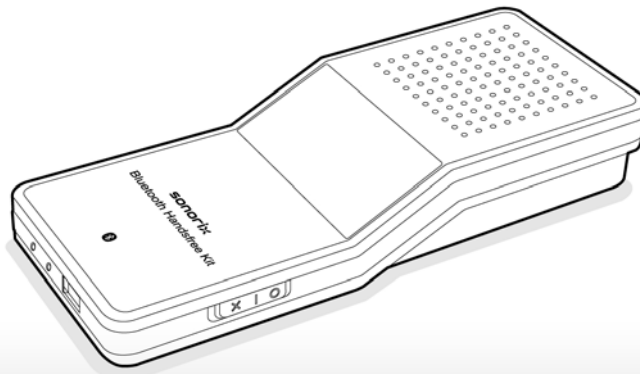
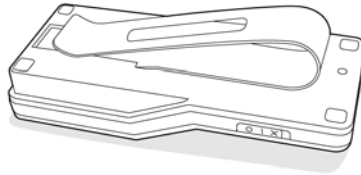

Introduction	4
Product Functions & Features	4
What's included in the Package	4
Description of Parts	5
Clipping the A1 onto Sun Visor	5
OLED Display	5
Charging the Battery	6
Switching the A1 ON/OFF	6
Echo & Noise Cancellation	7
Pairing and Connecting A1 with Bluetooth Devices	8
Using A1 for Handsfree Operations	9
Audio Tuning A1 with My Cell Phone	11
Specifications	12

Safety Instructions

- Check the laws and regulations on the use of mobile phones and handsfree equipments in areas you intend to use.
- As much as possible, do not manipulate the buttons of the device while driving.
- Do not expose the device to direct sunlight especially on the dashboard of car in hot summer as it may cause product deformation and even battery explosion. For safety, store the device in glove or console box when not in use.
- When cleaning the device, do not use any type of abrasive pad, scouring powder or solvents as these may render the finish dull permanently.
- When charging the device using AC/DC adapter, please make sure the correct input voltage is used.
- When using the device for the first time, charge the battery fully until 'Charged' is displayed.
- Do not use in places like hospitals, airplanes etc. where use of electronic devices is prohibited.
- Do not expose the device to extremes of temperature, moisture and vibrations.
- Risk of explosion if battery is replaced by an incorrect type. Dispose of used battery according to the instructions.

Introduction

The sonorix Bluetooth Handsfree Kit A1 is a state-of-the-art device for handsfree operations at its best. It functions as 'Car Handsfree Kit' or 'Portable Speakerphone' when linked to Bluetooth phones supporting Headset or Handsfree profiles.

Uniquely designed to be portable and versatile, A1 provides you with maximum comfort and satisfaction for all of your handsfree needs whether you use the device in car, outdoor or in office.

We hope you enjoy the unique features provided by sonorix.

Product Functions & Features

Caller ID
Display Function

0315966400

Enhanced Echo & Noise
Cancellation via DSP

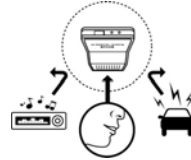

Car Kit and Speakerphone Modes
(Automatic Mode Switching & Invertible Display)

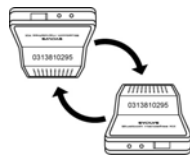

Car Movement Detection –
Automatic Link Connection

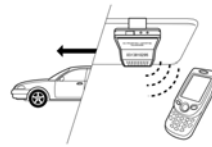

What's included in the Package

- Bluetooth Handsfree Kit A1
- Sun Visor Clip
- AC/DC Adaptor
- User Manual

Description of Parts

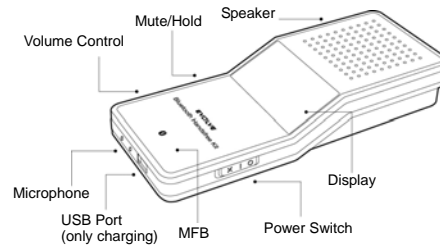

Clipping the A1 onto Sun Visor

- Mount the clip onto the back of A1 and slide the clip onto sun visor as shown below.

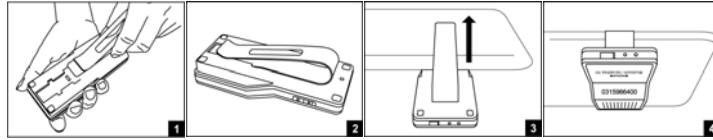

OLED Display

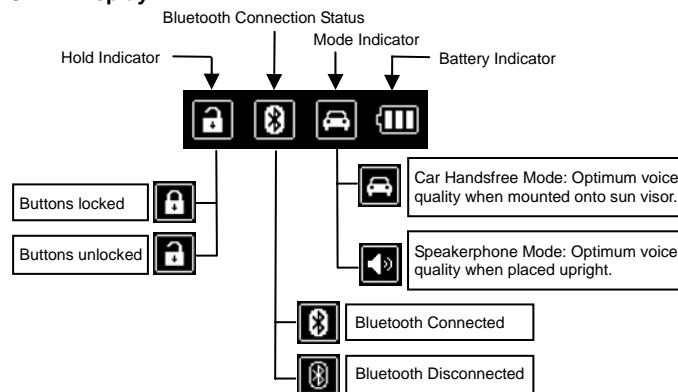

Automatic Mode Switching & Invertible Display Function

A1 is equipped with 'Automatic Mode Switching' as well as 'Automatic Invertible OLED' functions. 'Automatic Mode Switching' sets the best talk environment for user depending on where the A1 is used. If A1 is clipped onto sun visor, it automatically enters into 'Car Handsfree' mode and when placed on table, it enters into 'Speakerphone' mode. (patent pending) Also, the OLED display will be automatically inverted depending on whether the A1 is placed upright or upside down.

For battery power saving, display automatically switches off after 10 seconds. To view the display again, short click volume up or down buttons.

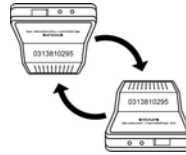

Charging the Battery

- When using the device for the first time, charge the battery fully until 'Charged' is displayed on window. This will optimize the battery calibration.
- If battery level is at its low, battery level indicator icon will be displayed as empty.
- To charge the battery, connect the handsfree kit to AC/DC power adapter.
- During charging, the battery level indicator will flash with 'Charging' displayed in static motion. When charged, the text 'Charged' will be displayed in flashing motion.

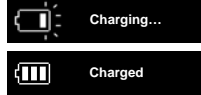

Note: When A1 is connected to USB for charging, the Bluetooth link will be automatically disconnected. When USB is unplugged, A1 will automatically attempt to reconnect to the last connected device. (The USB port is used for charging only.)

Switching the A1 ON/OFF

- To switch on A1, slide the power switch to O. With a boot tone, it will first display the sonorix logo followed by connection state icons and battery level indication. For battery power saving, display will turn off after 10 seconds.



- To switch off A1, slide the power switch to X.

Except during talk mode, battery power consumption is very low and therefore, it is not necessary to switch off power. And by keeping the A1 switched on, you can enjoy the special feature of "Automatic Connection" with phone when car engine is started. Switch off power only if device will not be used for more than 1 month.

Echo & Noise Cancellation

- DSP(Digital Signal Processor) integrated in A1 eliminates echo and noise thereby providing clear voice quality even under harsh environmental conditions.
- If A1 is used as 'Car Handsfree' mode in car, it eliminates surrounding noise (engine noise, wind noise, surrounding noise, radio sound etc.) and delivers clear voice to the other party. Also, it eliminates echo signals created by transmission of car speaker sounds to the microphone. The above mechanism for echo and noise cancellation is realized through the use of 2 microphone system and high-tech algorithm which cancels out unnecessary noise and delivers only the user voice. The directional microphones process only the user voice signal and therefore, for best performance for use in car, mount the A1 onto sun visor.

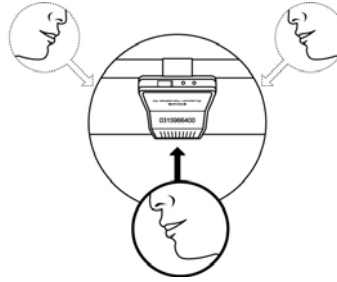



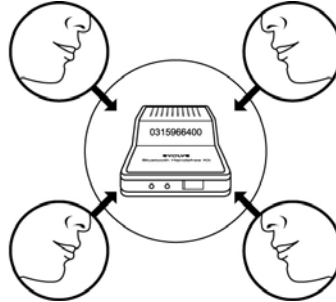

- On the other hand, if A1 is used as 'Speakerphone' mode, it doesn't matter in which direction the A1 is placed as noise signals generated from all directions will be processed thereby making it suitable for conference calls. However, it is important to note that the performance of 'Speakerphone' mode may not be as good as 'Car Handsfree' mode since it allows influx of noise from all directions and this mode is only recommended for use in quiet environment.













- The transition from one mode to another and vice-versa takes place automatically. That is, if A1 is placed upright, 'Speakerphone' mode will be activated and likewise, if it is placed upside down, 'Car Handsfree' mode will be activated. However, this automatic mode transition doesn't take effect during talk mode.

Pairing and Connecting A1 with Bluetooth Devices

Function	Action	Display
Pairing Mode	To put A1 in pairing mode, while pressing MFB, slide Power Switch from x to o. Keep pressing until you see 'Wait for Pairing', sonorix A1 and Bluetooth Device Address. A1 is now ready to be paired. Pairing mode lasts for 3 minutes, after this period A1 returns to standby mode. Note : A1 can be paired with up to 3 devices. To delete all pairing information, long click MFB while A1 is in pairing mode.	
Pairing Successful & Connection State	From a Bluetooth phone or PC, search for sonorix A1. When prompted for pinkey, enter '0000' which is the pinkey for A1. When paired, you will see 'Pairing Success' followed by display of 'Connection States' and 'Battery Level Indicator'. If A1 was paired in upside down position (Car Handsfree mode), car icon will be displayed and likewise, if it was paired in upright position (Speakerphone mode), then the sound icon will be displayed.	
Connection State	In idle mode, short click volume up or volume down buttons to check the connection status. If Bluetooth icon is highlighted, it means A1 is in connection state.	
Reconnect Function	A1 can be automatically reconnected to the last connected device in 2 ways, that is, when car starts to move after engine is started or when A1 is powered on. Note: Connecting time depends on the number of phones paired with A1 as A1 takes turn to connect to each device starting from the last connected device. When A1 is disconnected as a result of getting out of Bluetooth range, it will attempt reconnection to last connected device for maximum 5 minutes. To cancel reconnect function, simply click MFB when 'Connecting...' is displayed. A1 can also be reconnected manually by long clicking MFB in idle mode. You will first hear the beep tone followed by display of Connecting...' image.	
Button Hold Function	To prevent accidental button activation while the device is being carried around, lock the button operations by long clicking 'MUTE/HOLD' button. To unlock, long click 'MUTE/HOLD' button.	

Using A1 for Handsfree Operations

Function	Action	Display
Answer Call	On an incoming call, 'Ringing' and 'Caller ID' will be displayed alternately. If Caller ID function is not supported by phone, then only 'Ringing...' will be displayed. If your phone supports Caller Name Display, only the caller name will be displayed. To answer call, short click MFB.	 Ringing... 0315966400 HOME
Make Call	To make a call, first dial from phone and call will be automatically transferred to A1.	 Call Transfer
Redial	To redial, short click MFB. For some phones, when MFB is short clicked, it first displays the numbers last called or received. In this case, short click MFB again to redial. Note : Some phones allow direct redial by short clicking MFB just once.	 Redialing...
Voice Dial	To voice dial, make sure your phone supports voice dialing function and that it is activated and voice tags have been recorded. In idle mode, long click MFB to initiate voice dial. Follow the rest of the instructions from phone.	 Voice Dialing...
End Call	To end call first, short click MFB during 'Talk Mode'. If other party ends the call first, A1 automatically returns to handsfree standby mode. After call is ended, talk time will also be displayed.	 Call Ended 05:30
Reject Call	To reject incoming call, long click MFB.	 Call Rejected
Volume Control	Short click (+) or (-) to adjust volume. To adjust volume in continuous increments, click and hold (+) or (-) button.	
Microphone Mute	For privacy reasons, if you don't want the party on the other line to hear your voice, you can mute the microphone by short clicking MUTE/HOLD button during talk mode. To cancel mute function, short click MUTE/HOLD button.	 Mic. Muted
Call Transfer	During talk mode, to transfer call from A1 to phone or vice versa, long click MUTE/HOLD button.	 Call Transfer

Function	Action	Display
3 Way Call	<p>During talk mode, if you receive another call, long click MFB to hold the 1st call and answer 2nd call. To toggle between calls, long click MFB. During talk mode, by short clicking MFB, you can end the current call to continue with the next call.</p> <p>Note : 3 Way Call function is only applicable if user has subscribed for such service.</p>	 Call Waited

Audio Tuning A1 with My Cell Phone

- As mobile phones have varying speaker and microphone level settings which affect the handsfree quality in the form of echoes, too low or loud sounds etc. when used with A1, if you encounter such problems, you can calibrate the speaker and microphone settings of your A1 device.
- To be able to adjust the microphone setting, A1 has to be in talk mode. During talk mode long click [+] or [-] button. Followed by a beep tone, the following icon will then be displayed. Short click [+] or [-] button to adjust your microphone setting until the caller on the other side hears your voice well. When display is turned off after 10 seconds or if call is ended, the desired microphone setting will be saved.



Specifications

Standards	Bluetooth Specification V2.0
RF Frequency Range	2402 ~ 2480 MHz
Profiles Supported	Headset, Handsfree
Transmission Power	0.25 ~ 2.5mW (Class 2)
Distance	10m (in open space)
Audio Output	> 1W
Battery Life	Standby > 400 hrs Continuous Talk Time > 15 hrs
Charging Time	< 3 hrs
Charging Voltage	DC +5V
Buttons	Power On/Off, Multi-Function Button, Mute Button, Volume Up/Down
Display	128 X 32 dots OLED (white)
Weight	87.5g (Include Sun Visor Clip)
Operating Temp. & Humidity	-10 ~ +50°C, Rel. Humidity 0 ~ 95%
Certification	BQB, FCC, CE, MIC

Product Warranty

- * OpenBrain Technologies warrants this product against all defects in material and workmanship for a period of one year from the date of purchase by end user. The conditions for warranty are as follows:
- * The warranty is valid only if the original receipt issued to the original purchaser by the dealer is presented with the product to be repaired or replaced.
- * The warranty is void if the serial number, date of purchase and product label had been removed.
- * The warranty does not cover any failure or damage of the product due to normal wear and tear, physical abuse, improper installation, misuse, modification or repairs by unauthorized third parties.
- * OpenBrain Technologies does not assume responsibility for any loss or damage incurred during shipment and as a result of force majeure.
- * OpenBrain Technologies is not liable for any incidental or consequential damages arising from the use or misuse of the product.
- * All warranty claims are limited to repair or replacement of the defective product at the sole discretion of OpenBrain Technologies.
- * If OpenBrain Technologies repairs or replaces the product, the repaired or replaced product shall be warranted for the remaining time of the original warranty period. Repair or replacement may involve the use of functionally equivalent reconditioned units. Replaced part or product becomes the property of OpenBrain Technologies.
- * Consumable components, such as batteries, are not included in the warranty obligation.

Disclaimer Notice

The manufacturer shall not be liable for errors contained herein or for incidental or consequential damages in connection with the furnishing, performance or use of this material. This document contains proprietary information, which is protected by international patent applications and copyright. All rights reserved. No part of this document may be copied, reproduced or translated without prior written consent of the manufacturer. The manufacturer reserves the right to revise this publication and to make changes from time to time in the contents hereof without obligation to notify any person of such revisions or changes. The manufacturer also reserves the right to change the specifications without notice.

European CE notice to users and product statements

This product is CE marked according to the provisions of the R & TTE Directive (99/5/EC). Hereby, OPENBRAIN Technologies Co., Ltd, declares that this product is in compliance with the essential requirements and other relevant provisions of Directive 1999/5/EC. For further information, please contact <http://www.openbrain.co.kr>

FCC notice to users and product statements

THIS DEVICE COMPLIES WITH PART 15 OF THE FCC RULES. Operation is subject to the following two conditions: (1) this device may not cause harmful interference, and (2) this device must accept any interference received, including interference that may cause undesired operation. CAUTION: Changes or modifications not expressly approved by the party responsible for compliance could void the user's authority to operate the equipment.

WEEE Directive 2002/96/EC Art. 11(2)

The use of the symbol indicates that this product may not be treated as household waste. By ensuring this product is disposed of correctly, you will help prevent potential negative consequences for the environment and human health, which could otherwise be caused by inappropriate waste handling of this product. For more detailed information about recycling of this product, please contact your local city office, your household waste disposal service or the shop where you purchased the product.