



OWNER'S MANUAL

SANSUI[®]

DVD PLAYER/HI-FI VIDEO CASSETTE RECORDER

VRDVD4000



VHS Hi-Fi

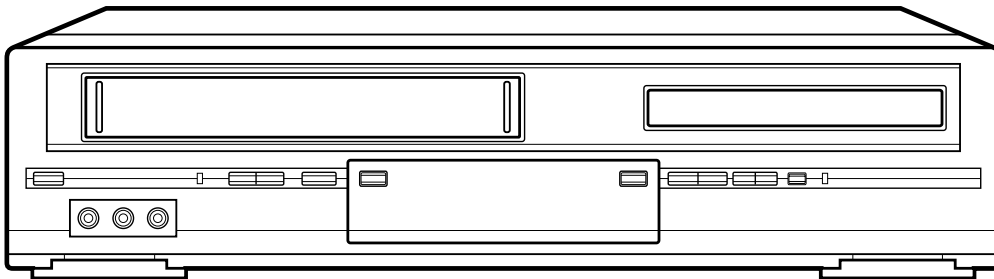

ATTENTION

If you purchase a universal remote control from your local retailer, please contact the remote manufacturer for the required programming code.

TV/CATV MODE SELECTION



When shipped from the factory, the TV/CATV menu option is set to the "CATV" (Cable Television) mode.
If not using CATV (Cable TV), set this menu option to the "TV" mode.

ORION WEBSITE

FOR INFORMATION ON OUR OTHER PRODUCTS,
PLEASE VISIT OUR WEBSITE AT
WWW.ORIONSALESINC.COM

Before operating the unit, please read this manual thoroughly.



	CAUTION RISK OF ELECTRIC SHOCK DO NOT OPEN	
<p>CAUTION: TO REDUCE THE RISK OF ELECTRIC SHOCK, DO NOT REMOVE COVER (OR BACK). NO USER-SERVICEABLE PARTS INSIDE. REFER SERVICING TO QUALIFIED SERVICE PERSONNEL.</p>		



The lightning flash with arrowhead symbol, within an equilateral triangle is intended to alert the user to the presence of uninsulated dangerous voltage within the product's enclosure that may be of sufficient magnitude to constitute a risk of electric shock to persons.



The exclamation point within an equilateral triangle is intended to alert the user to the presence of important operating and maintenance (servicing) instructions in the literature accompanying the appliance.

WARNING: TO REDUCE THE RISK OF FIRE OR ELECTRIC SHOCK, DO NOT EXPOSE THIS APPLIANCE TO RAIN OR MOISTURE.

WARNING: This equipment has been tested and found to comply with the limits for a Class B digital device, pursuant to Part 15 of the FCC Rules. These limits are designed to provide reasonable protection against harmful interference in a residential installation. This equipment generates, uses and can radiate radio frequency energy and, if not installed and used in accordance with the instructions, may cause harmful interference to radio communications. However, there is no guarantee that interference will not occur in a particular installation. If this equipment does cause harmful interference to radio or television reception, which can be determined by turning the equipment off and on, the user is encouraged to try to correct the interference by one or more of the following measures:

- Reorient or relocate the receiving antenna.
- Increase the separation between the equipment and receiver.
- Connect the equipment into an outlet on a circuit different from that to which the receiver is connected.
- Consult the dealer or an experienced radio/TV technician for help.

CAUTION: Changes or modifications not expressly approved by the party responsible for compliance with the FCC Rules could void the user's authority to operate this equipment.

CAUTION:
THIS DIGITAL VIDEO PLAYER EMPLOYS A LASER SYSTEM.

TO ENSURE PROPER USE OF THIS PRODUCT, PLEASE READ THIS USER'S GUIDE CAREFULLY AND RETAIN FOR FUTURE REFERENCE. SHOULD THE UNIT REQUIRE MAINTENANCE, CONTACT AN AUTHORIZED SERVICE LOCATION-SEE SERVICE PROCEDURE.

USE OF CONTROLS, ADJUSTMENTS OR THE PERFORMANCE OF PROCEDURES OTHER THAN THOSE SPECIFIED HEREIN MAY RESULT IN HAZARDOUS RADIATION EXPOSURE.

TO PREVENT DIRECT EXPOSURE TO LASER BEAM, DO NOT TRY TO OPEN THE ENCLOSURE. VISIBLE LASER RADIATION MAY BE PRESENT WHEN THE ENCLOSURE IS OPENED. DO NOT STARE INTO BEAM.

Location of the required Marking

The rating sheet and the safety caution are on the rear of the unit.

CERTIFICATION: COMPLIES WITH FDA RADIATION PERFORMANCE STANDARDS, 21 CFR SUBCHAPTER J.

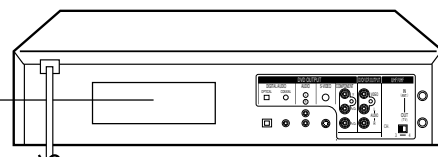



IMPORTANT SAFEGUARDS

1. READ INSTRUCTIONS

All the safety and operating instructions should be read before the unit is operated.

2. RETAIN INSTRUCTIONS

The safety and operating instructions should be retained for future reference.

3. HEED WARNINGS

All warnings on the unit and in the operating instructions should be adhered to.

4. FOLLOW INSTRUCTIONS

All operating and use instructions should be followed.

5. CLEANING

Unplug this unit from the wall outlet before cleaning. Do not use liquid cleaners or aerosol cleaners.

Use a damp cloth for cleaning the exterior cabinet only.

6. ATTACHMENTS

The manufacturer of this unit does not make any recommendations for attachments, as they may cause hazards.

7. WATER AND MOISTURE

Do not use this unit near water. For example, near a bathtub, washbowl, kitchen sink, laundry tub, in a wet basement, or near a swimming pool.

8. ACCESSORIES

Do not place this unit on an unstable cart, stand, tripod, bracket, or table.

The unit may fall, causing serious injury, and serious damage to the unit.

- 8A.** An appliance and cart combination should be moved with care. Quick stops, excessive force, and uneven surfaces may cause the appliance and cart combination to overturn.

9. VENTILATION

Slots and openings in the cabinet back or bottom are provided for ventilation, and to ensure reliable operation of the unit, and to protect it from overheating.

These openings must not be blocked or covered. The openings should never be blocked by placing the unit on a bed, sofa, rug, or other similar surface. This unit should never be placed near or over a radiator or heat source. This unit should not be placed in a built-in installation such as a bookcase or rack unless proper ventilation is provided or the manufacturer's instructions have been adhered to.

10. POWER SOURCES

This unit should be operated only from the type of power source indicated on the rating plate. If you are not sure of the type of power supply to your home, consult your appliance dealer or local power company. For units intended to operate from battery power, or other sources, refer to the operating instructions.

11. GROUNDING OR POLARIZATION

This unit is equipped with a polarized alternating-current line plug (a plug having one blade wider than the other). This plug will fit into the power outlet only one way. This is a safety feature. If you are unable to insert the plug fully into the outlet, try reversing the plug. If the plug should still fail to fit, contact your electrician to replace your obsolete outlet. Do not defeat the safety purpose of the polarized plug, if your unit is equipped with a 3-wire grounding-type plug, a plug having a third (grounding) pin. This plug will only fit into a grounding-type power outlet. This too, is a safety feature. If you are unable to insert the plug into the outlet, contact your electrician to replace your obsolete outlet.

Do not defeat the safety purpose of the grounding-type plug.

12. POWER-CORD PROTECTION

Power-supply cords should be routed so that they are not likely to be walked on or pinched by items placed upon or against them, paying particular attention to cords at plugs, convenience receptacles, and the point where they exit from the appliance.

PORTABLE CART WARNING
(symbol provided by RETAC)



S3125A



IMPORTANT SAFEGUARDS

13. LIGHTNING

To protect your unit from a lightning storm, or when it is left unattended and unused for long periods of time, unplug it from the wall outlet and disconnect the antenna or cable system. This will prevent damage to the unit due to lightning and power line surges.

14. POWER LINES

An outside antenna system should not be located in the vicinity of overhead power lines or other electric light or power circuits, or where it can fall into such power lines or circuits. When installing an outside antenna system, extreme care should be taken to keep from touching such power lines or circuits, as contact with them might be fatal.

15. OVERLOADING

Do not overload wall outlets and extension cords, as this can result in a risk of fire or electric shock.

16. OBJECT AND LIQUID ENTRY

Do not push objects through any openings in this unit, as they may touch dangerous voltage points or short out parts that could result in fire or electric shock. Never spill or spray any type of liquid into the unit.

17. OUTDOOR ANTENNA GROUNDING

If an outside antenna or cable system is connected to the unit, be sure the antenna or cable system is grounded to provide some protection against voltage surges and built-up static charges, Section 810 of the National Electrical Code, ANSI/NFPA 70, provides information with respect to proper grounding of the mast and supporting structure, grounding of the lead-in wire to an antenna discharge unit, size of grounding conductors, location of antenna discharge unit, connection to grounding electrodes, and requirements for the grounding electrode.

18. SERVICING

Do not attempt to service this unit yourself as opening or removing covers may expose you to dangerous voltage or other hazards. Refer all servicing to qualified service personnel.

19. DAMAGE REQUIRING SERVICE

Unplug this unit from the wall outlet and refer servicing to qualified service personnel under the following conditions:

- a. When the power-supply cord or plug is damaged.
- b. If liquid has been spilled, or objects have fallen into the unit.
- c. If the unit has been exposed to rain or water.
- d. If the unit does not operate normally by following the operating instructions. Adjust only those controls that are covered by the operating instructions, as an improper adjustment of other controls may result in damage and will often require extensive work by a qualified technician to restore the unit to its normal operation.
- e. If the unit has been dropped or the cabinet has been damaged.
- f. When the unit exhibits a distinct change in performance, this indicates a need for service.

20. REPLACEMENT PARTS

When replacement parts are required, be sure the service technician uses replacement parts specified by the manufacturer or those that have the same characteristics as the original part.

Unauthorized substitutions may result in fire, electric shock or other hazards.

21. SAFETY CHECK

Upon completion of any service or repairs to this unit, ask the service technician to perform safety checks to determine that the unit is in proper operating condition.

22. HEAT

The product should be situated away from heat sources such as radiators, heat registers, stoves, or other products (including amplifiers) that produce heat.

23. DISC TRAY

Keep your fingers well clear of the disc tray as it is closing. It may cause serious personal injury.

24. CONNECTING

When you connect the product to other equipment, turn off the power and unplug all of the equipment from the wall outlet. Failure to do so may cause an electric shock and serious personal injury. Read the owner's manual of the other equipment carefully and follow the instructions when making any connections.

4



IMPORTANT SAFEGUARDS / Power Source

25. LASER BEAM

Do not look into the opening of the disc tray or ventilation opening of the product to see the source of the laser beam. It may cause sight damage.

26. DISC

Do not use a cracked, deformed, or repaired disc. These discs are easily broken and may cause serious personal injury and product malfunction.

27. NOTE TO CATV SYSTEM INSTALLER

This reminder is provided to call the CATV system installer's attention to Article 820-40 of the NEC that provides guidelines for proper grounding and, in particular, specifies that the cable ground shall be connected to the grounding system of the building, as close to the point of cable entry as practical.

EXAMPLE OF ANTENNA GROUNDING AS PER THE NATIONAL ELECTRICAL CODE

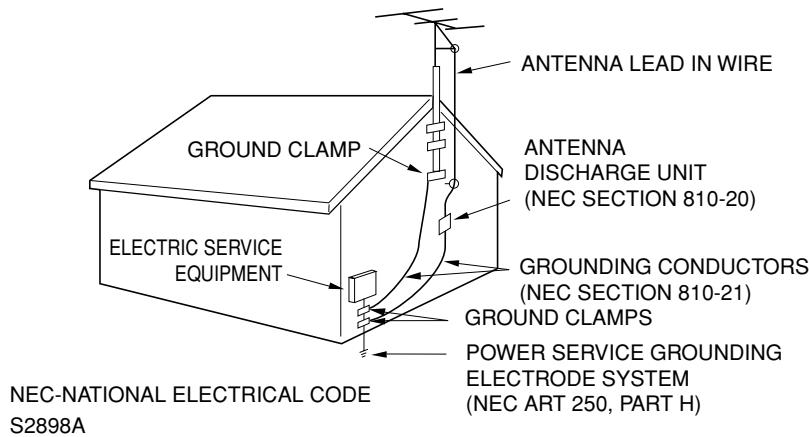

CONDENSATION

Moisture will form in the operating section of the DVD/VCR if the player is brought from cool surroundings into a warm room or if the temperature of the room rises suddenly. When this happens, DVD/VCR's performance will be impaired.

To prevent this, let the DVD/VCR stand in its new surroundings for about an hour before switching it on, or make sure that the room temperature rises gradually.

Condensation may also form during the summer if the DVD/VCR is exposed to the breeze from an air conditioner. In such cases, change the location of the DVD/VCR.

Power Source

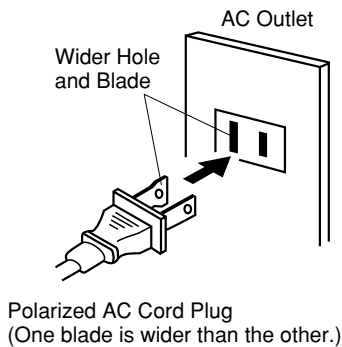

TO USE AC POWER SOURCE

Use the AC polarized line cord provided for operation on AC. Insert the AC cord plug into a standard 120V 60Hz polarized AC outlet.

NOTES:

- Never connect the AC line cord plug to other than the specified voltage (120V 60Hz). Use the attached power cord only.
- If the polarized AC cord does not fit into a non-polarized AC outlet, do not attempt to file or cut the blade. It is the user's responsibility to have an electrician replace the obsolete outlet.
- If you cause a static discharge when touching the unit and the unit fails to function, simply unplug the unit from the AC outlet and plug it back in. The unit should return to normal operation.





Features

DVD/CD Player/Video Cassette Recorder

- **DVD/CD player with Video Cassette Recorder** - Unique space saving design combines a DVD/CD player and a Hi-Fi Video cassette recorder. The DVD disc has much more capacity, but is the same size as the audio CD disc. Picture quality is higher than Super VHS. Audio quality is higher than audio CD. The DVD PLAYER can play back audio CDs.
- **High Quality Picture** - More than 500 lines (VCR mode: 230 lines) of Horizontal Resolution. It exceeds Super VHS (400 lines) or Laser Disc (430 lines) in resolution.

VCR Section

- **Stereo/SAP Reception** - This VCR is designed to receive stereo and separate audio program (SAP) broadcasts where available.
- **4 Video Heads** - Provides optimal picture quality for special effects playback.
- **19µm HEAD** - For superior picture quality even in SLP mode, 19micron width technology helps to avoid crosstalk and boost SLP picture quality to near SP levels. With precision technology, ghosts and color beats are virtually eliminated.
- **Hi-Fi Stereo Sound** - With a frequency response of 20 to 20,000 Hz and a dynamic range of better than 90dB, this VCR provides a level of excellence that rivals compact discs.
- **One-touch Timer Recording (OTR)** - Simply by pressing the REC/OTR button, the VCR can be programmed for up to 5 hours of recording with an immediate start.

DVD Section

- **Compatible with a wide range of DVD audio outputs**

Digital Audio Jack (Optical or Coaxial):

- When a component with a built-in Dolby Digital decoder is connected, Dolby Digital sound can produce the effect of being in a movie theater or a concert hall.
- Surround standard different from Dolby Digital. This format is already in use in many theaters. By connecting this unit to a DTS decoder or an AV amplifier with a built-in DTS decoder, the DTS audio of DVD discs recorded in this format can be enjoyed. However, audio will not be output from the analog audio output jacks.
- The MPEG audio of DVD discs recorded in this format can be enjoyed.
- The Linear PCM sound of a 48 kHz/16 bit through 96 kHz/20 bit exceeds audio CD sound.
- **Multi-Language** - Since this DVD matches with 124 language-subtitles/-soundtracks, you can enjoy selecting a favorite one. (You can not select the language that is not recorded on the disc.)
- **Multi-Angle** - Pictures of Sports or a Live Concert are recorded with many cameras. When you play such a disc, you can change the angles during playback. (If a Multi-Angle is not recorded on the disc, you can not change the angle.)
- **Repeat Playback** - You can repeat chapter, track, title, sides or material between two selected points.
- **Program/Random Playback** - You can play back tracks in programmed or random-selected sequences.
- **Zoom** - You can zoom in on the selected subject on the screen during playback.
- **Video Aspect Ratio** - You can change the aspect ratio of the screen for your monitor/television on a suitable disc.
- **Parental Control** - You can limit the playback of scenes or sounds of adult DVD discs which have a parental level rating.

* This product incorporates copyright protection technology that is protected by method claims of certain U.S. patents and other intellectual property rights owned by Macrovision Corporation and other rights owners. Use of this copyright protection technology must be authorized by Macrovision Corporation or other rights owners and is intended for home and other limited viewing uses only unless otherwise authorized by Macrovision Corporation or other rights owners. Reverse engineering or disassembly is prohibited.

* Manufactured under license from Dolby Laboratories. "Dolby" and the double-D symbol are trademarks of Dolby Laboratories. Confidential unpublished works. © 1992-1997 Dolby Laboratories, Inc. All rights reserved.

* "DTS" and "DTS Digital Out" are trademarks of Digital Theater Systems, Inc.

* Unauthorized recording of copyrighted television programs, films, video cassettes and other materials may infringe the rights of copyright owners and be contrary to copyright laws.



Contents

Before using your unit

IMPORTANT SAFEGUARDS	3
Power Source	5
Features	6
Contents	7
Parts and functions	8
Display	9
Remote control	10
Basic connections	12
CATV (CABLE TV) connections	14
Playback connection	16

Setting up the VCR section

Setting the video channel	18
Setting the language	18
Clock setting	19
Tuner setting	20
To ADD/DELETE channels	21
Noise elimination	21
Loading and Unloading a cassette tape	22

Tape playback operation

Cassette tape playback	23
Special playback	24
ZERO RETURN function	25
Video index search system	25

Recording

Recording a TV program	26
One-touch Timer Recording (OTR)	28
Timer recording	29

Advanced function of VCR section

Stereo recording and playback	31
Separate Audio Program (SAP)	31
Duplicating a video tape	32

Disc playback operation

Disc	33
Setting setup language	34
Playback procedure	35
Special playback	36
Zooming	37
Repeat playback	38
Memory playback/Random playback	39
MP3 playback	40
Changing soundtrack language	41
Changing subtitles language	41
Changing angles	42
Title selection	42
DVD menu	42

Advanced function of DVD section

Parental control	43
Setting menu language	45
Setting subtitle language	46
Setting audio soundtrack language	47
Setting the aspect ratio of TV screen	48
Setting on screen display	49
Setting Audio	50
Setting Operation	51
Setting Background	52
Setting Screen Saver	52
Setting initial setup	53
Output sound conversion table	53
Status display of disc	54
Table of languages	55

Additional information

Problems and troubleshooting	56
Video head cleaning	57
Specifications	58
LIMITED WARRANTY	59



Parts and functions

Front

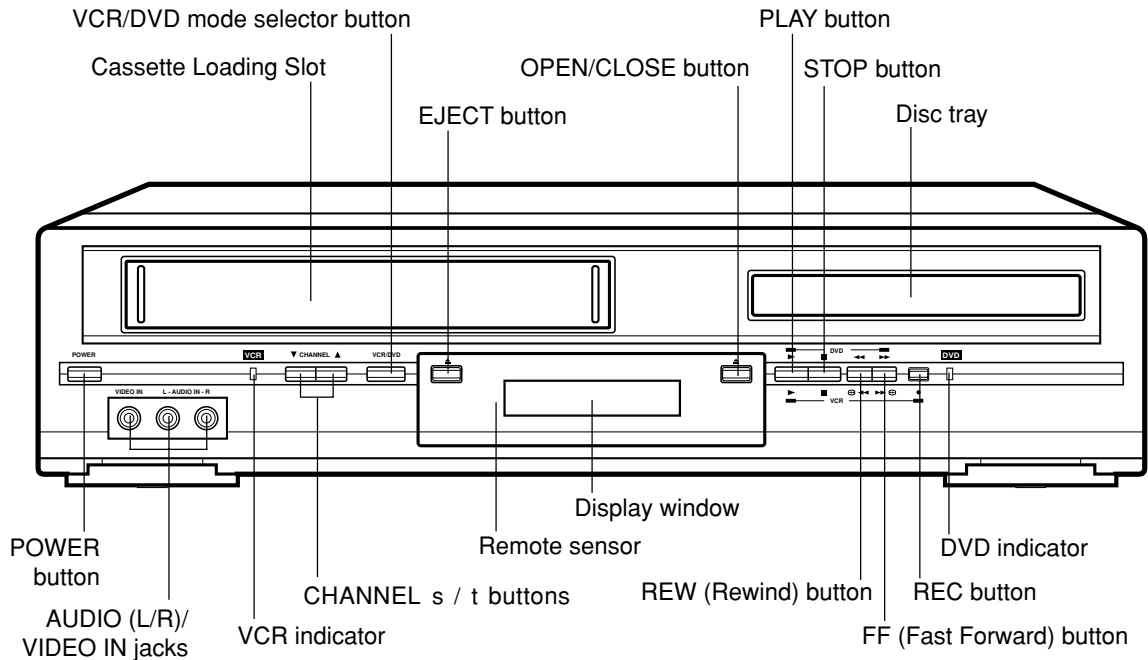

Rear

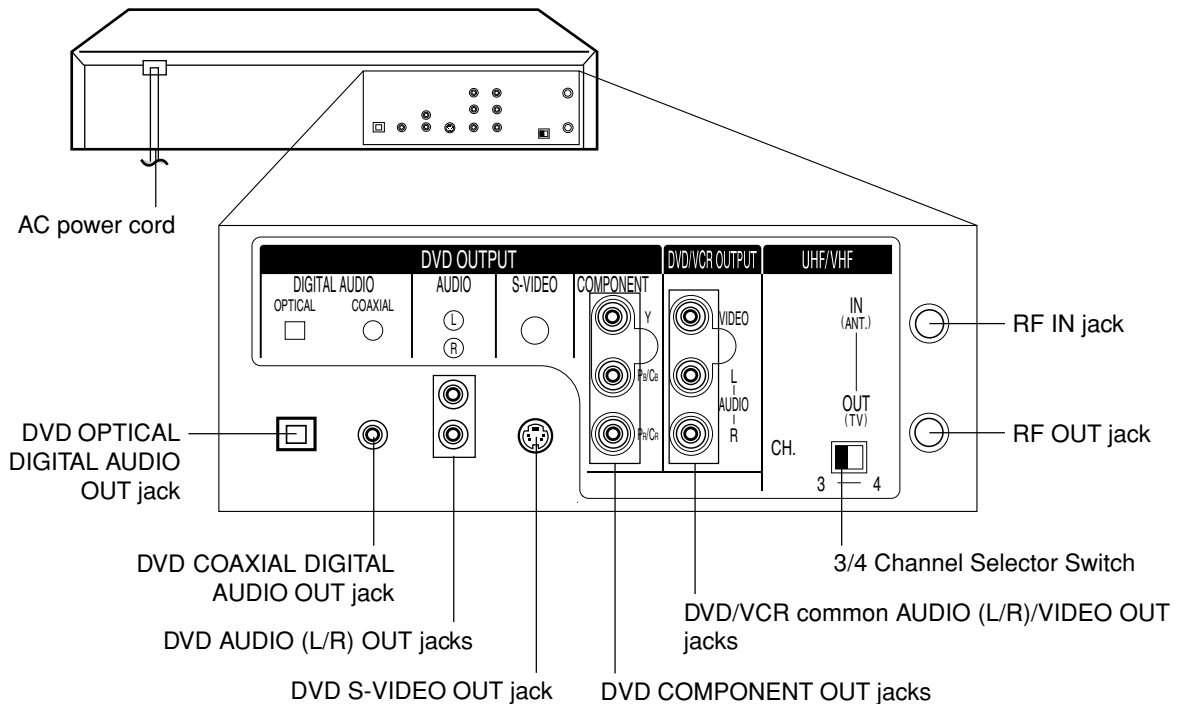



Display

Display window

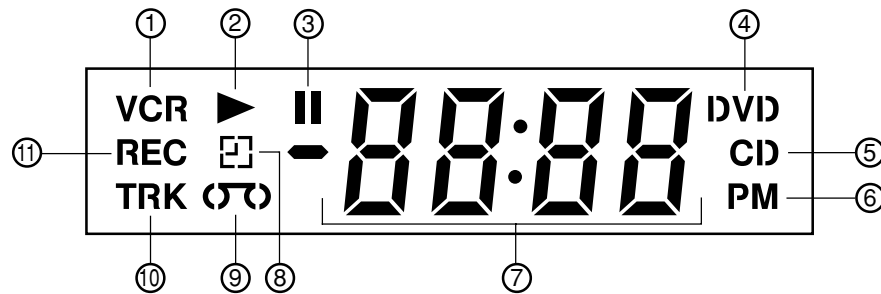

No.	Display	Description
①	VCR	VCR mode
②	▶	Playback (lights) / Auto resume (flashes)
③	⏸	Still picture
④	DVD	DVD disc is inserted.
⑤	CD	CD is inserted.
⑥	PM	Display for afternoon (lights out in the morning)
⑦	10 : 00	Clock display (colon [:] flashes)
	01 : 00	Counter display by hour/minute at VCR/DVD / by minute/second at CD
	2	Track number display for CD
	CH02	TV channel display for VCR
	C036	CATV channel display
	L	External input display
⑧	⏮	Timer recording display
⑨	⏮	Video tape is in the unit
⑩	TRK	Track display for CD
⑪	REC	Normal recording display (flashes during One-touch Timer Recording - OTR)

Explanation for On-Screen-Symbol:

▶ Playback	⏮ Skip chapter to reverse direction	🔍 Zoom
■ Stop	⏪ Open or Close the tray	🔒 Parental level locked
⏸ Still picture	⏩ Auto resume	🔓 Parental level unlocked
⏭ Frame advanced playback	◀▶▶▶ Direction button's mark	📺 Screen size: Normal TV
▶ Forward slowmotion	⏮ A-B A-B repeat	📺 Screen size: PAN SCAN
⏭ Fast Forward playback	⋮ Subtitle language	📺 Screen size: WIDE
⏮ Review playback	🗣 Soundtrack language	🚫 Shows Prohibited act
⏭ Skip chapter to forward direction	🗣 Angle	

Note:

Some discs may be displayed wrong or e.g. chapter number, playback time, etc. may not be displayed.





Remote control

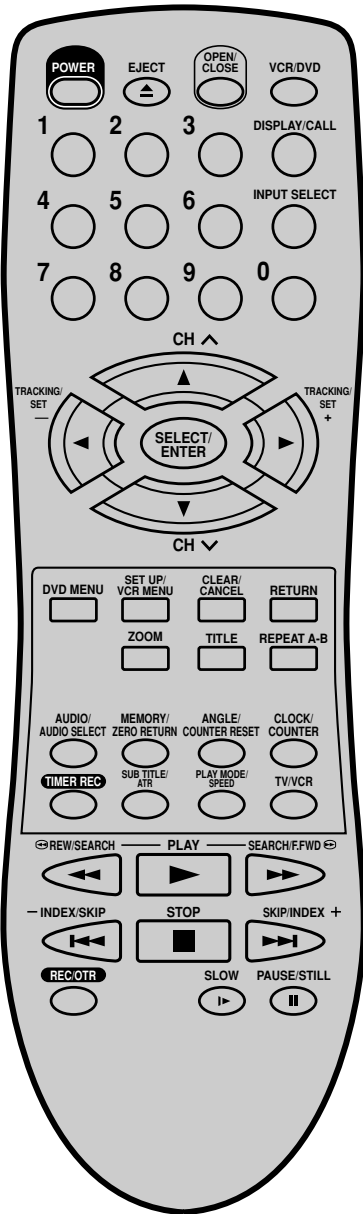

		Page
POWER	Power on/off	18
EJECT	Eject a cassette tape	22
OPEN/CLOSE	Open or Close the tray	35
VCR/DVD	Switch to operate VCR or DVD	18,38
0-9	Direct channel selection of TV	21,26
	Input setting	39
	Enter a password	43
DISPLAY/CALL	Display VCR or DVD operation status	27,54
INPUT SELECT	Switch the connected TV to external mode	32
CH ^/v	Select channel of the connected TV or VCR	26,28
▲ / ▼	Cursor buttons	34
TRACKING/SET -/+	Setting buttons	29,30
	Manual tracking buttons in playback mode	24
◀/▶	Cursor buttons	18
SELECT/ENTER	Enter information in the menu	18
	Select option in the menu	34
DVD MENU	Select menu of a DVD disc	42
SET UP/VCR MENU	Display menu of setup	18,34,43-53
CLEAR/CANCEL	Delete Timer program	30
	Cancel input data in the setting mode	19,29,37,39
RETURN	Remove DVD set up menu	34
ZOOM	Zoom (for DVD playback)	37
TITLE	Select title of a DVD disc	42
REPEAT A-B	Repeat playback between A and B (DVD/CD)	38
AUDIO/AUDIO SELECT	Switches sound between mono, stereo and SAP	31
	Change sound track language of DVD	41
MEMORY	Arrange the order of titles, chapters or tracks	39
ZERO RETURN	Stop the tape when the counter reaches 00:00	25
ANGLE	Change playback angle of a DVD disc	42
COUNTER RESET	Reset the counter to 00:00	25
CLOCK/COUNTER	Change the front Display mode	25
TIMER REC	Set the unit to start recording at a preset time.	29,30
SUB TITLE	Set Subtitle of a DVD disc	41
ATR	Digital AUTO TRACKING	24
PLAY MODE	Select playback mode	38,39
SPEED	Sets the tape speed for recording	26,28
TV/VCR	Switches between TV and VCR	18,27
REW/SEARCH	Rewind/Review playback	23,24,36
PLAY	Playback	23,35
F.FWD/SEARCH	Fast Forward/Forward search playback	23,24,36
SKIP ◀▶	Skip chapter to forward or reverse direction	36
INDEX ◀▶	Search for the INDEX mark of a tape	25
STOP	Stop	23,35
REC/OTR	Recording	26,28,32
SLOW	Slowmotion playback	24,36
PAUSE/STILL	Still picture/Recording pause on/off	24,27,32,36





Remote control

Inserting Batteries

1 Open the battery compartment cover in the direction of the arrow.

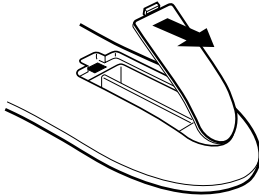

2 Install two "AAA" batteries (not supplied), paying attention to the polarity diagram in the battery compartment.

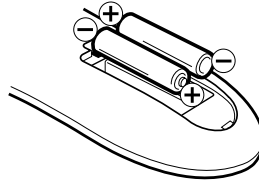

3 Replace the compartment cover.

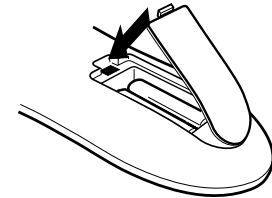

Battery precautions

The precautions below should be followed when using batteries in this device:

1. Use only the size and type of batteries specified.
2. Be sure to follow the correct polarity when installing the batteries as indicated in the battery compartment. Reversed batteries may cause damage to the device. To avoid a potential short circuit, insert the "-" end first.
3. Do not mix different types of batteries together (e.g. Alkaline and Carbon-zinc) or old batteries with fresh ones.
4. If the device is not to be used for a long period of time, remove the batteries to prevent damage or injury from possible battery leakage.
5. Do not try to recharge batteries not intended to be recharged; they can overheat and rupture. (Follow battery manufacturer's directions.)

Remote control basics

- Press **POWER** to turn the DVD/VCR on or off.
- Make sure **VCR/DVD** switch is set to VCR/DVD.
- Tap **CH ^** or **CH v** to move through the channels one channel at a time.
- The **CH ^/v** and **SET +/-** are also used to navigate on-screen menu system.
- You can directly access specific channels using **Number keys** pad.
- Each press of **VCR/DVD** on the remote control, switches the screen between the VCR screen (VCR mode) and the DVD screen (DVD mode).

Operation

- Aim the remote control at the remote sensor and press control buttons to operate.
- Operate the remote control within 30° angle on either side of the remote sensor, up to a distance of Approx. 5 meters.

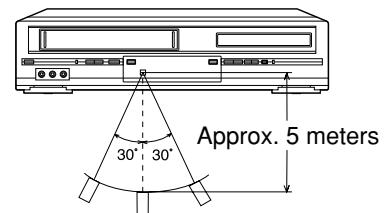



Basic connections

If you are using an antenna system, follow the instructions. If you are a cable (CATV) subscriber, skip ahead to page 14 for the proper connections.

ANTENNA TO DVD/VCR CONNECTION

The DVD/VCR must be connected "between" the antenna and the TV. First, disconnect the antenna from the TV and connect it to the DVD/VCR. Then connect the DVD/VCR to the TV. Below are 3 common methods of connecting an antenna system to a DVD/VCR. Find the type of antenna system you are using and follow the connection diagram.

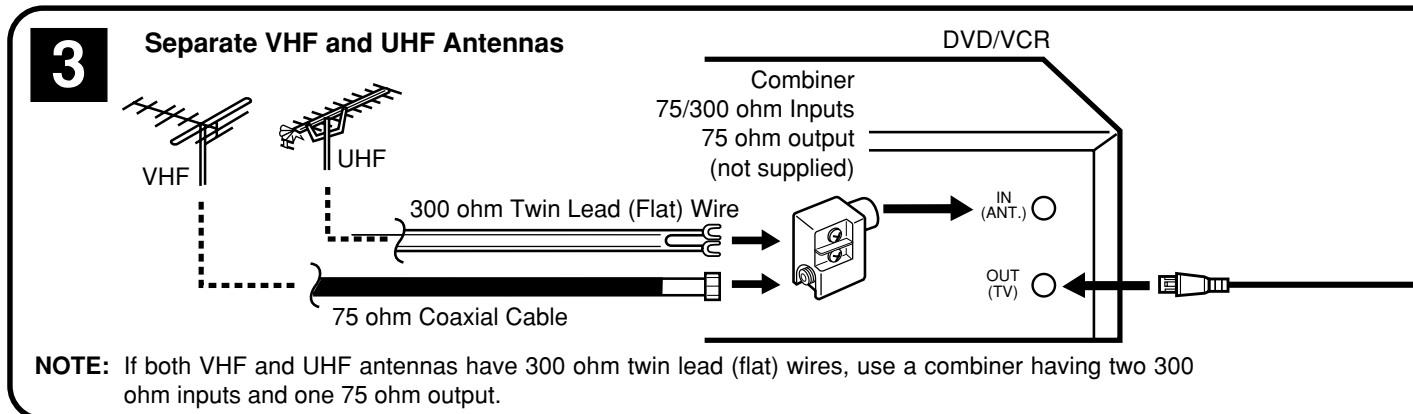
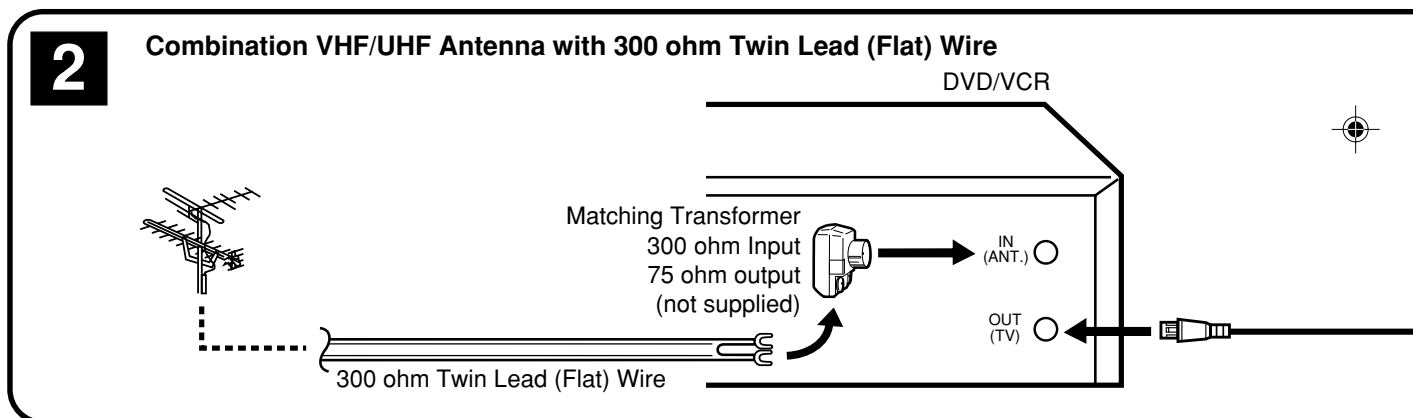
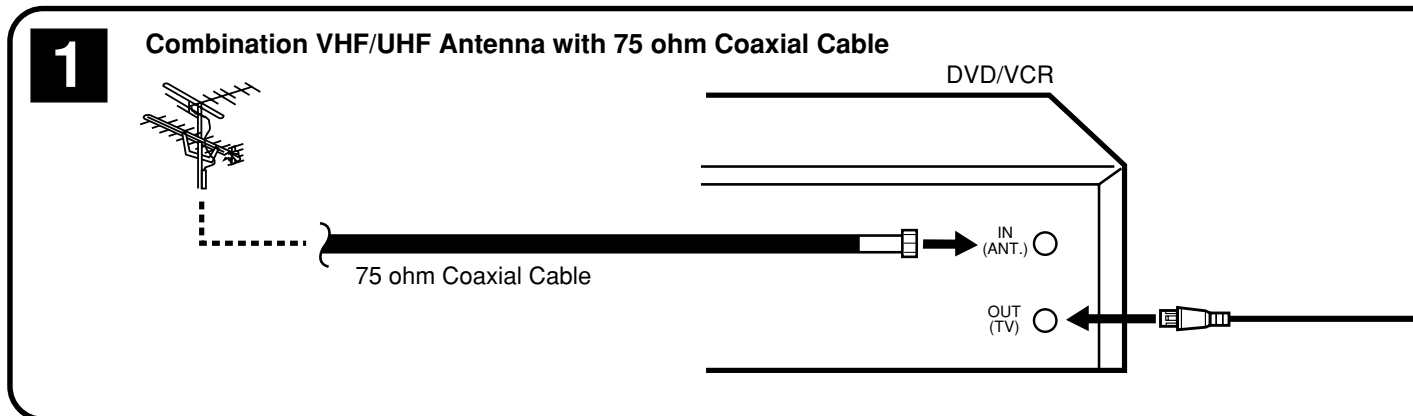

NOTE: If both VHF and UHF antennas have 300 ohm twin lead (flat) wires, use a combiner having two 300 ohm inputs and one 75 ohm output.

- NOTES:**
- A clear picture will not be obtained by the DVD/VCR unless the antenna signal is good. Connect the antenna to the DVD/VCR properly.
 - For better quality recording, an indoor antenna or a telescopic antenna is not recommended. The use of an outdoor type antenna is required.
 - If you are not sure about the connection, please refer to qualified service personnel.





Basic connections

DVD/VCR TO TV CONNECTION

After you have connected the antenna to the DVD/VCR, you must connect the DVD/VCR to the TV. Below are 3 common methods of connecting your DVD/VCR to a TV. Find the type of TV you are using and follow the connection diagram.

This DVD/VCR has a single 75 ohm output for connection to a TV. If your TV has separate VHF and UHF antenna inputs (numbers 2 and 3 below), use a splitter to connect the DVD/VCR to the TV for VHF and UHF reception.

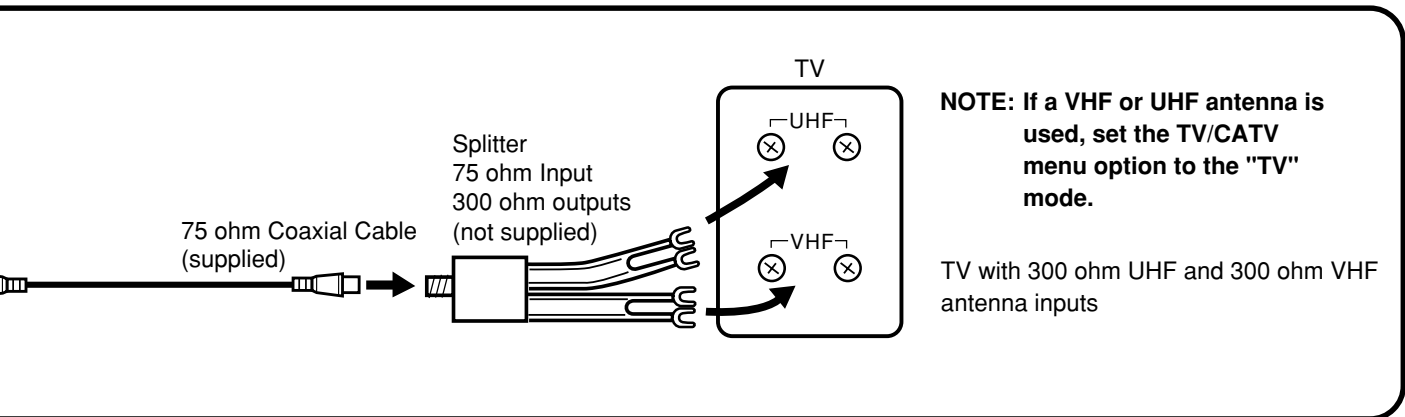
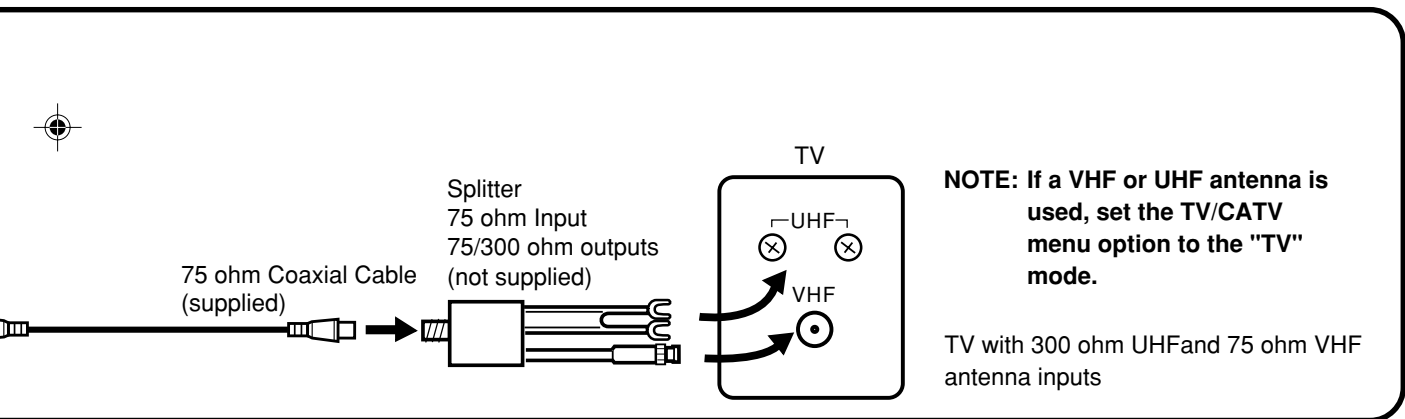
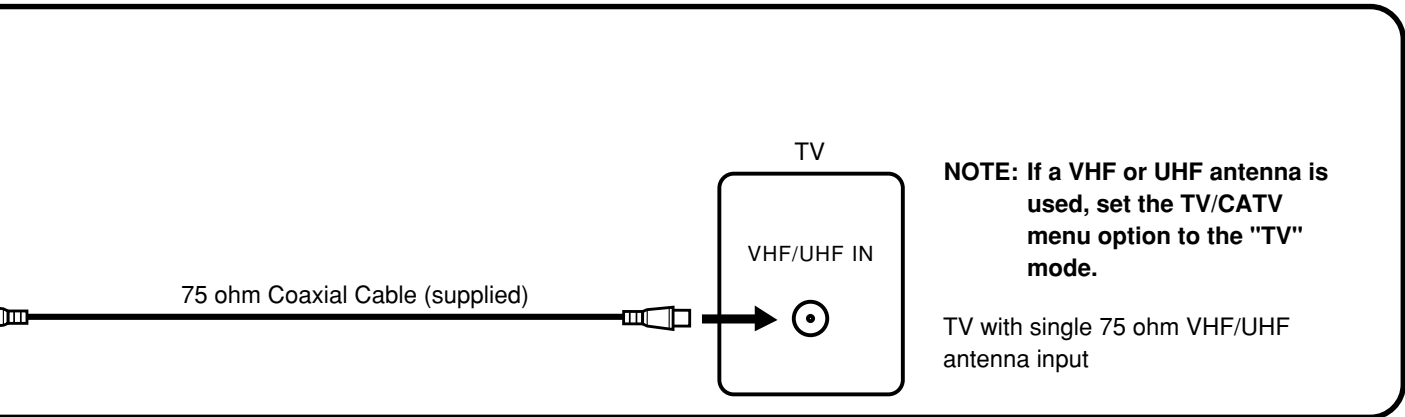



CATV (CABLE TV) connections

Many cable companies offer services permitting reception of extra channels including pay or subscription channels. This DVD/VCR has an extended tuning range and can be tuned to most cable channels without using a cable company supplied converter box, except for those channels which are intentionally scrambled. If you subscribe to a special channel which is scrambled, you must have a descrambler box for proper reception.

1

DVD/VCR

IN (ANT.)

OUT (TV)

Incoming Cable

TV

VHF/UHF IN (ANT.)

ALLOWS:

- * Recording of nonscrambled channels.
- * Use of the programmable timer.
- * Recording of one channel while watching another.

2

DVD/VCR

IN (ANT.)

OUT (TV)

Incoming Cable

Converter/Descrambler

TV

VHF/UHF IN (ANT.)

ALLOWS:

- * Recording of channels through the converter box (scrambled and unscrambled).
- * Using the programmable timer to record only the channel selected at the converter box.

PREVENTS:

- * Recording one channel while watching another.
- * Using the DVD/VCR tuner to select channels.

NOTE:

To record from converter/descrambler, DVD/VCR tuner must be tuned to the converter output channel, usually channel 3 or 4.

3

DVD/VCR

IN (ANT.)

OUT (TV)

Incoming Cable

Converter/Descrambler

TV

VHF/UHF IN (ANT.)

ALLOWS:

- * Recording of nonscrambled channels.
- * Use of the programmable timer.
- * Recording an unscrambled channel while watching any channel selected at the converter box.

PREVENTS:

Recording scrambled channels.

NOTE:

If you are playing a tape or using the tuner built into the DVD/VCR, the converter must be set to the video channel output of the DVD/VCR (either 3 or 4).

NOTE: Whenever a Converter/Descrambler box is placed before the DVD/VCR, you must tune the DVD/VCR to the output of the Converter/Descrambler box, usually channel 3 or 4.





CATV (CABLE TV) connections

IMPORTANT: Make sure the TV/CATV menu option is set to the "CATV" mode.

This DVD/VCR cannot receive scrambled programs since it does not contain a descrambler. In order to receive scrambled programs, your existing descrambler must be used. Descrambler boxes are available from cable companies. Consult your local cable company for more information concerning connection to their descrambler equipment. There are many ways to connect your DVD/VCR to a cable system. Below are six common methods of connection.

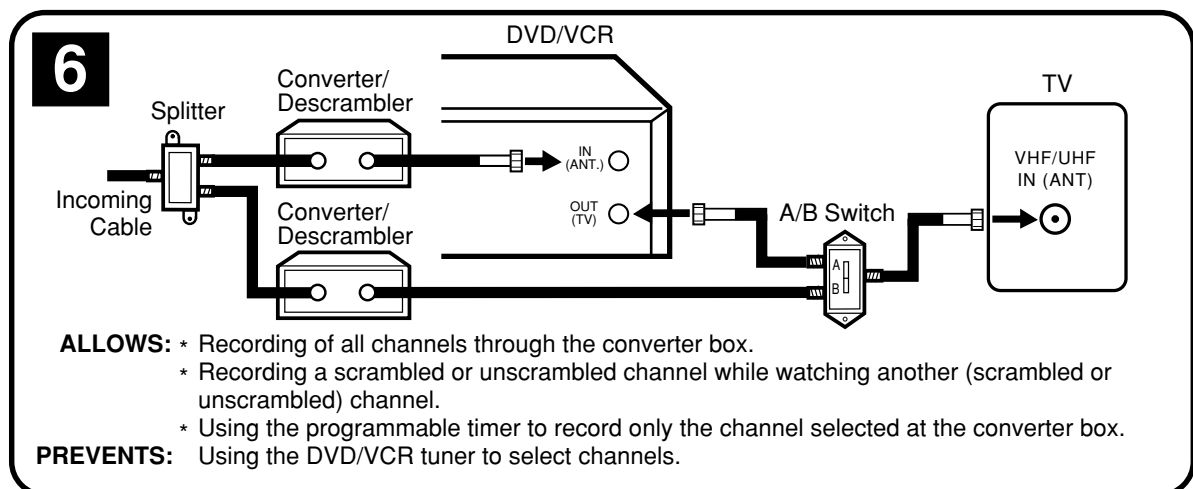
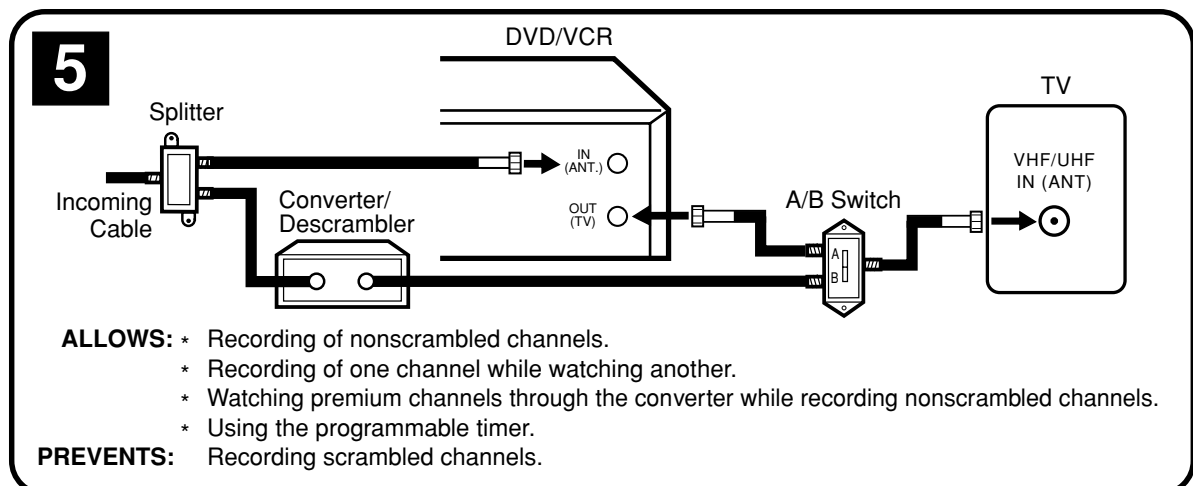
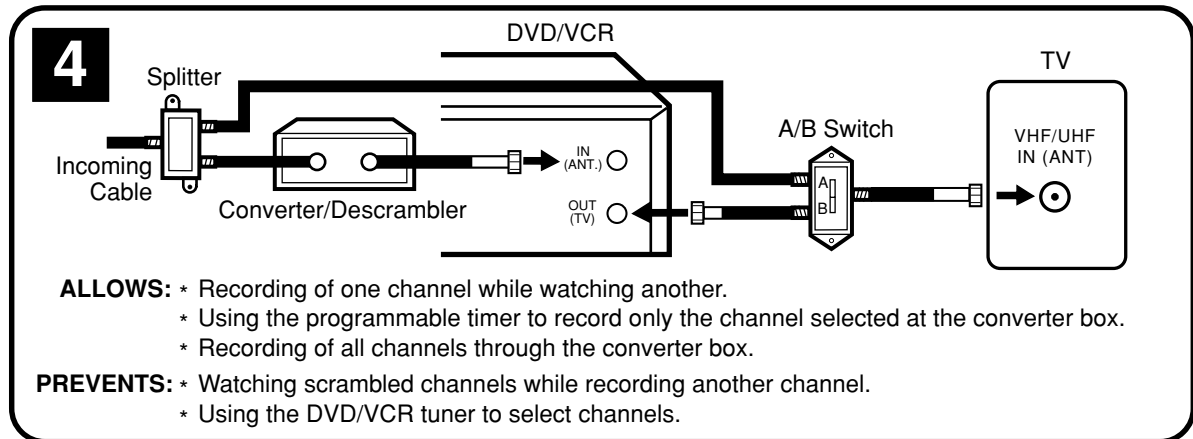



Playback Connection

The exact arrangement you use to interconnect various video and audio components to the DVD/VCR is dependent on the model and features of each component. Check the Owner's Manual provided with each component for the location of video and audio inputs and outputs.

Connect to a TV with Audio/Video Output

Use the supplied AUDIO/VIDEO Cord.

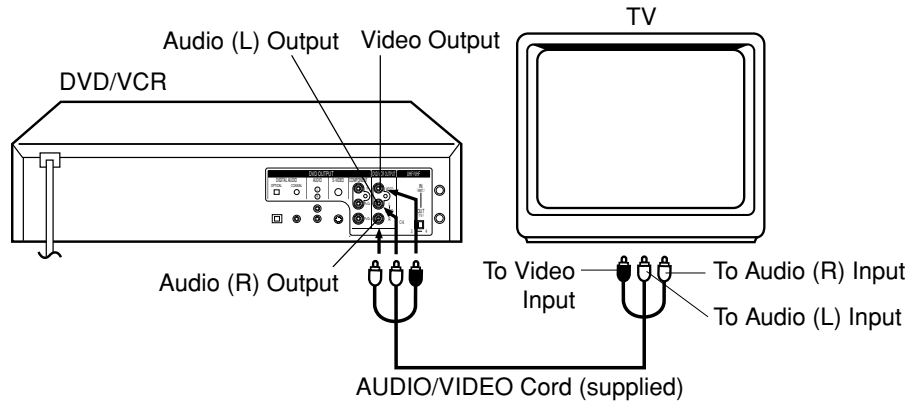

Connect to a TV with S-Video Output

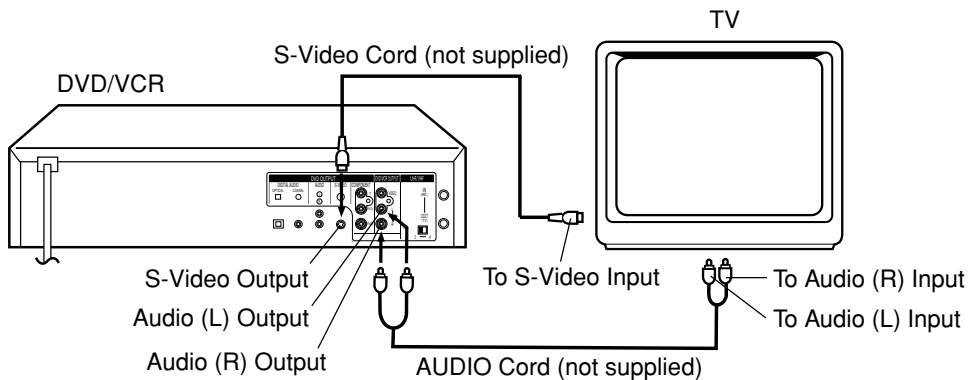

Connect to a BS TUNER

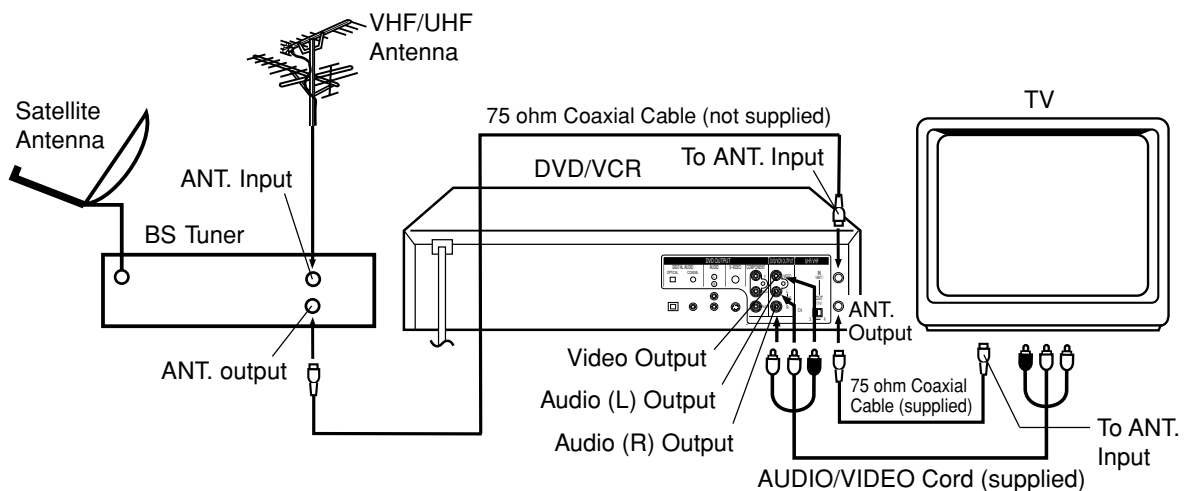



Playback connection

Connect to a Stereo Amplifier with Audio Output

If your TV has COMPONENT VIDEO IN jack, you can connect the DVD/VCR to the TV with a COMPONENT cable (not supplied) as shown below. COMPONENT VIDEO output jack can send high-quality video signal to a TV than S-Video output.

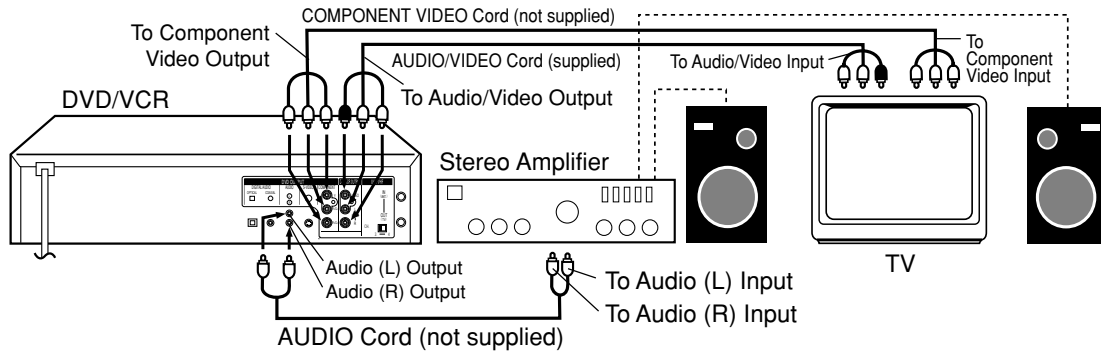

Connect to an AV Amplifier with built-in digital surround

If you are using an Amplifier with a built-in digital surround as follows, you can enjoy the various audio systems such as Dolby Digital and DTS by using the Optical or Coaxial Digital Output.

Use this connection to connect an:

- AV amplifier with built-in *Dolby Digital decoder
- AV amplifier with built-in *DTS decoder

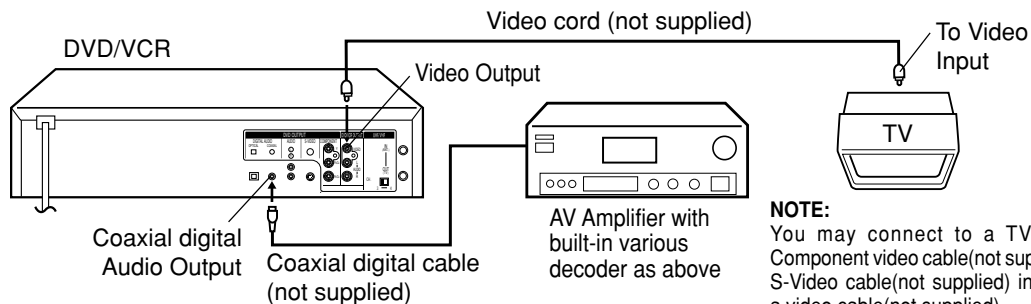

NOTE:
You may connect to a TV with a Component video cable(not supplied) or S-Video cable(not supplied) instead of a video cable(not supplied).

Connecting the optical digital cable

You may connect to an AV Amplifier with an Optical digital cable (not supplied) instead of a Coaxial digital cable.

When you connect the optical digital cable (not supplied), remove the dust protection cap from the rear panel. When not using the optical digital cable, attach the dust protection cap to protect against dust.

NOTES:

- The OPTICAL, COAXIAL, AUDIO L/R, S-VIDEO and COMPONENT jacks are useful only for DVD section. The VHS signal is output only from the composite jack (DVD/VCR VIDEO OUTPUT) and UHF/VHF OUT.
- When you make the connections above, do not set DOLBY DIGITAL to DOLBY DIGITAL or DTS to ON on the AV Amplifier. If you do, a loud noise will suddenly come out from the speakers, affecting your ears or causing the speakers to be damaged.
- Caution for the **optical** digital audio output connector: Do not connect to an amplifier (with an optical digital input connector) which does not contain a Dolby Digital or DTS decoder. Otherwise, any attempt to play DVDs may cause such a high level of noise that it may be harmful to your ears and damage your speakers.
- DTS audio will be output only from the COAXIAL or OPTICAL output. To hear DTS audio, DTS-Decoder is necessary.
- When playing DTS-encoded CDs, only noise will be heard from the speakers or analogue stereo outputs.
- Some DTS decoders which do not support DVD-DTS interface may not work properly with the unit.





Setting the Video Channel / Setting the language

Setting the Video Channel

To view playback of a recorded tape, or to watch a program selected by the VCR's channel selector, the TV must be set to channel 3 or 4 (video channel).

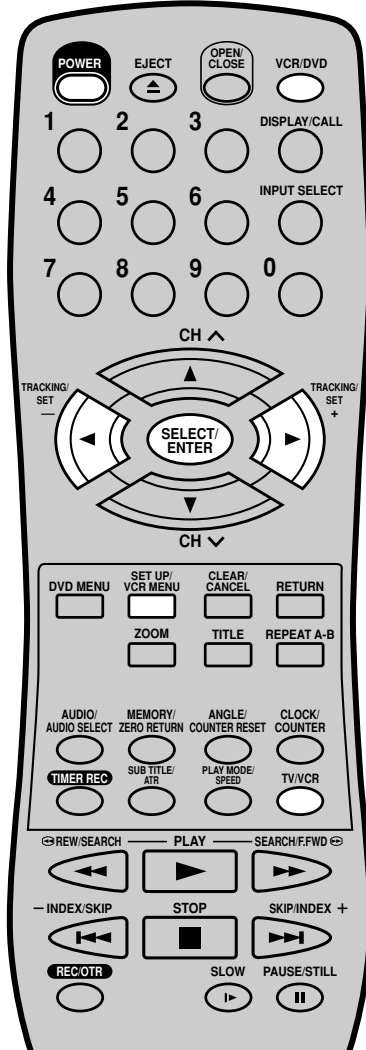

NOTES:

- If the unit does not operate properly, or No key operation (by the unit and/or the remote control): Static electricity, etc., may affect the player's operation. Disconnect the AC power cord once, then connect it again.
- The VCR section has its own menu and also DVD section has its own menu (see page 34).
- If there is no pressing of any buttons for more than 60 seconds, then the MENU screen back to TV-operation automatically.

18

When a TV is connected with the 75 ohm coaxial cable only.

- 1 Press **POWER** to turn on the DVD/VCR.
- 2 Press **VCR/DVD** to select the VCR mode. The VCR indicator on the front panel will light.
- 3 Set the **3/4 Channel selector** switch on the rear panel to CH 3 or 4.
- 4 Turn **ON** the TV and set to CH 3 or 4 to correspond with the channel selected in step 3.
- 5 Press **TV/VCR** to select the VCR position. The VCR indicator will appear in the display.
- 6 Select any channel to receive a TV station in your area. The channel number will appear on the screen for about 4 seconds.

For a push-button TV tuner

If CH 3 or 4 corresponding to the video channel cannot be tuned on your TV, proceed as follows: set the VCR 3/4 channel selector and the TV to CH 3 or 4, play back a prerecorded tape and tune the TV to receive a sharp color picture from the video cassette recorder. Refer to your TV owner's manual for details.

Setting the language

You can choose from three different languages (English, French and Spanish) for the on-screen displays.

- 1 Press **VCR MENU**,
If you use the unit for the first time and press **VCR MENU**, instead of the main menu screen on the right the **SYSTEM SET UP** menu screen in step 2 may appear.

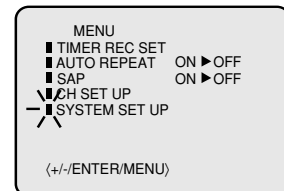

- 2 Press **◀** or **▶** to select the "LANGUAGE" option, then press **ENTER**.

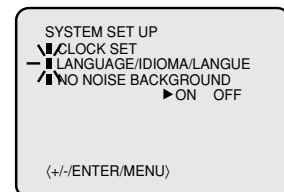

- 3 Press **◀** or **▶** to select the desired language: English (ENGLISH), Spanish (ESPAÑOL) or French (FRANCAIS), then press **ENTER**.



- 4 Press **VCR MENU** until the MENU screen is cleared.





Clock setting

You must set the date and time for timer recordings.

Preparation:

- Turn ON the TV and set to the video input mode.
- Press **VCR/DVD** to select the VCR mode. (The VCR indicator will light)

EXAMPLE: Setting the clock to "8:30 AM" March, 23 (SAT), 2002.

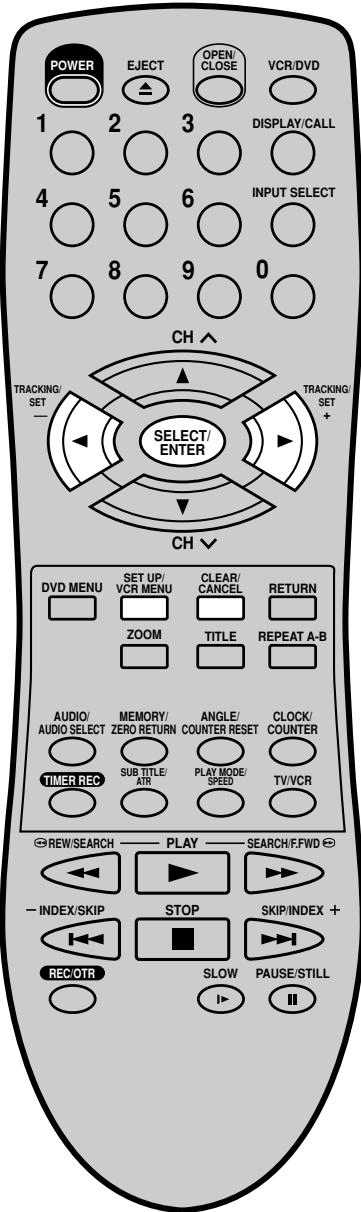

1 Press **VCR MENU**. The VCR menu screen will appear.

2 Press **◀** or **▶** to select the "SYSTEM SET UP" menu, then press **ENTER**.

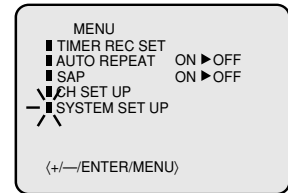

3 Press **◀** or **▶** to select the "CLOCK SET" option, then press **ENTER**.

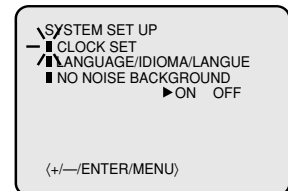

4 Press **◀** or **▶** to set the month, then press **ENTER**.

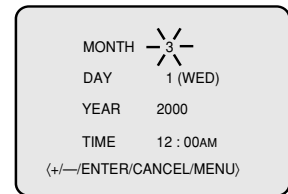

To make corrections any time during the process

Press **CANCEL** repeatedly until the item you want to change blinks, then press **◀** or **▶**.

5 Set the day, year and time as in step 4.

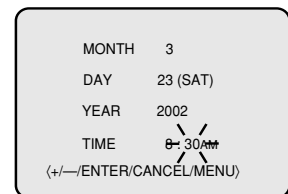

NOTE:

After a power failure or disconnection of the power, the timer settings will be lost. In this case, reset the present time.

6 After setting the clock, date and time starts functioning automatically.

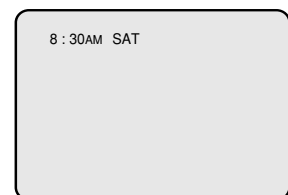



Tuner setting

This DVD/VCR is equipped with a channel memory feature which allows channels to skip up or down to the next channel set into memory, skipping over unwanted channels. Before selecting channels, they must be programmed into the DVD/VCR's memory. In addition to normal VHF and UHF channels, this DVD/VCR can receive up to 113 Cable TV channels. To use this DVD/VCR with an antenna, set the TV/CATV menu option to the TV mode. When shipped from the factory, this menu option is in the CATV mode.

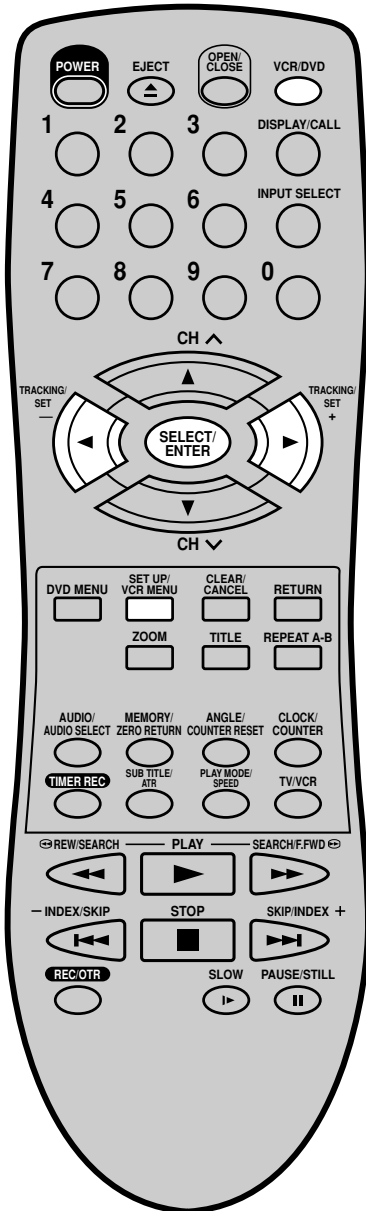

Preparation:

- Turn ON the TV and set to the video input mode.
- Press **VCR/DVD** to select the VCR mode. (The VCR indicator will light)

TV/CATV selection

1 Press **VCR MENU**. The VCR menu screen will appear. Press **◀** or **▶** to select "CH SET UP", then press **ENTER**.

2 Press **◀** or **▶** to select the "TV/ CATV" option.

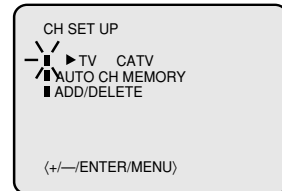

3 Then press **ENTER** to select the TV or CATV mode. The arrow indicates the selected mode.

TV - VHF/UHF channels
CATV - CABLE TV channels

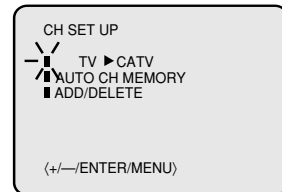

4 Press **VCR MENU** until the menu screen is cleared.

Setting channels automatically

The VCR can receive a maximum of 181 channels by presetting the channels into memory.

1 Repeat above step 1 and press **◀** or **▶** to select "AUTO CH MEMORY".



2 Then press **ENTER**. The auto tuning will start. The channel display will count up and when finished, the screen returns to normal.



NOTE:

- You can't select "CH SET UP" if you set the channel to "L".





To ADD/DELETE channels / Noise elimination

To ADD/DELETE channels

You can add the channels you want or delete the channels you do not want manually.

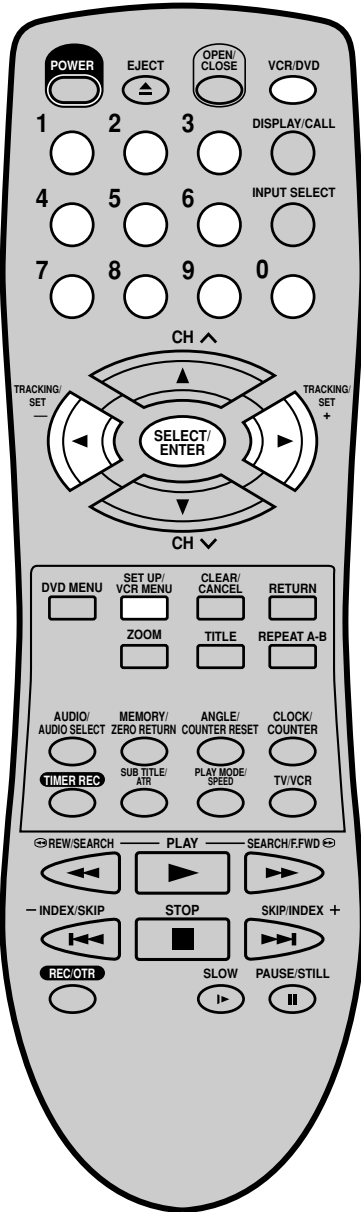

Preparation:

- Turn ON the TV and set to the video input mode.
- Press **VCR/DVD** to select the VCR mode. (The VCR indicator will light)

- 1 Repeat the step 1 on page 20. Then press ◀ or ▶ to select the "ADD/DELETE" option and press **ENTER**.

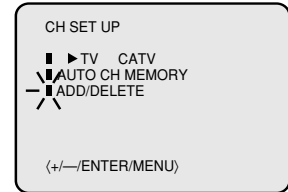

2 To Add or Delete desired channels

- 1 Press **Number keys** or ◀ / ▶ to select a channel number you want to add or delete.

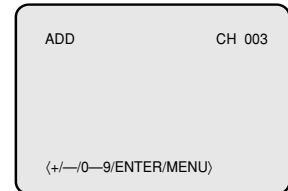

- 2 **To add channels**
Press **ENTER** until "ADD" appears on the screen to set to add the unmemorized channel.

To delete channels

Press **ENTER** until "DELETE" appears on the screen to set to delete the channel from memory. The channel number will blink.

- 3 Repeat 1 to 2 to add or delete other channel.

- 3 Press **VCR MENU** until the menu screen is cleared.

Noise elimination

When you don't want to receive a weak signal broadcast, the Blue back screen can be obtained by selecting the NO NOISE BACKGROUND "ON". When the unit is shipped from the factory, the NO NOISE BACKGROUND is set to the "ON".

- 1 Repeat the steps 1~2 on page 19 and press ◀ or ▶ to select NO NOISE BACKGROUND.

- 2 Press **ENTER** to select the "ON" position.

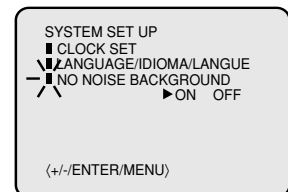

- 3 Press **VCR MENU** until the menu screen is cleared.



Loading and Unloading a cassette tape

Use only video cassette tapes marked **VHS**.

Loading

Push the center of the tape until it is automatically inserted.

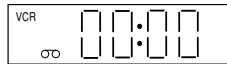
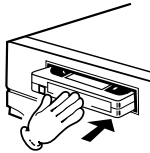

Insert the cassette tape with its labeled side facing up and the erase prevention tab positioned at your left. An inverted cassette tape cannot be inserted.

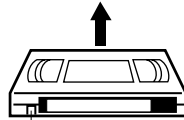

Erase prevention tab

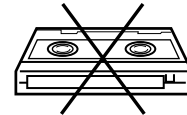

Automatic power ON

When you insert a cassette tape the VCR power will turn ON automatically.

Automatic playback

When loading a cassette tape without an erase prevention tab, playback will start automatically.

Unloading

1 Press **EJECT** on the unit or the Remote.



2 Remove the cassette tape.

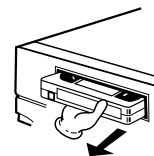

Automatic tape eject

This VCR will automatically rewind the tape when the tape has ended. And when the tape is rewinded to its beginning, the cassette tape will be ejected automatically.

To prevent accidental erasure

Remove the erase prevention tab with a screwdriver.

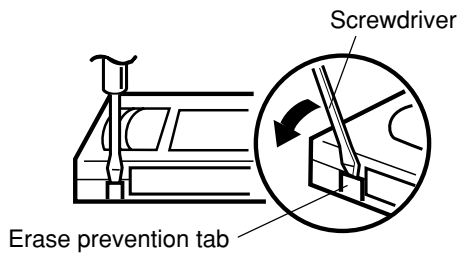

To record again

Cover the hole with a piece of adhesive tape.

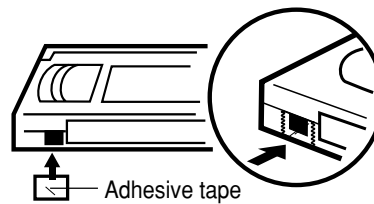

Tape speed and maximum recording time

Tape Speed	Video cassette tape				
	T-160	T-120	T-90	T-60	T-30
SP (Standard Play)	2-2/3 hours	2 hours	1-1/2 hours	1 hour	30 minutes
SLP (Super Long Play)	8 hours	6 hours	4-1/2 hours	3 hours	1-1/2 hours





Cassette tape playback

Preparation:

- Turn ON the TV and set to the video input mode.
- Press **VCR/DVD** to select the VCR mode. (The VCR indicator will light)

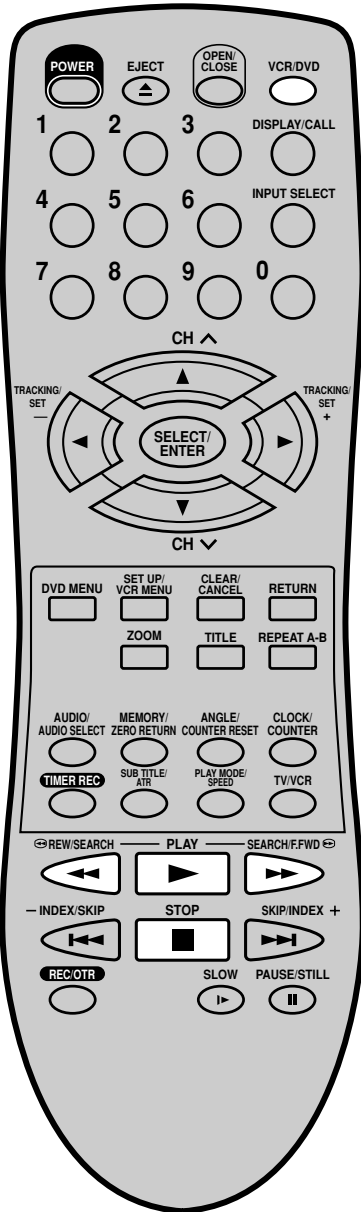

- 1 Load a prerecorded tape
(When loading a cassette tape without the erase prevention tab, playback will start automatically).

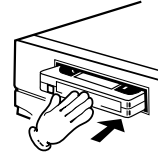

- 2 To start playback

Press **PLAY**.
Playback will start.
"▶" will appear on the screen for about 4 seconds.



To stop playback

Press **STOP** once.
The tape will stop but remain fully loaded and ready to play.
"■" will appear on the screen for about 4 seconds.



To rewind the tape or forward it rapidly

Stop the playback or recording with **STOP**.

To rewind the tape:

Press **REW**.



To forward the tape:

Press **F.FWD**.



To stop the tape-winding, press **STOP**. To switch to playback directly (without **STOP**), press **PLAY**.

Forward/Reverse picture search mode

When the tape is being wound, you can switch to picture search mode (see next page). To do this, press **REW** or **F.FWD** and hold it down. The unit will resume the tape winding as soon as the button is released.

NOTES:

- This VCR selects the playback tape speed SP, LP or SLP automatically.
- The Cassette tape and DVD disc can be played back simultaneously. If you press **VCR/DVD**, the tape playback and DVD playback alternate with each other on the screen.
- When you select the VCR mode during DVD playback DVD playback will stop automatically after approx. 5 minutes.





Special playback

Picture Search

Reverse picture search function

Press **REW** x 1 or x 2 during the playback.

Forward picture search function

Press **F.FWD** x 1 or x 2 during the playback.

To return to playback: Press **PLAY**.

SPEED SEARCH TIMES

TAPE SPEED	PICTURE SEARCH SPEED	
	PRESS ONCE	PRESS TWICE
SP (Standard Play)	3 X	5 X
LP (Long Play)	7 X	9 X
SLP (Super Long Play)	9 X	15 X

Still Picture

Press **PAUSE** during playback. To resume normal playback: Press **PLAY**.

Slow Motion

During playback press **SLOW**.

To return to playback: Press **PLAY** or **SLOW**.

Slow tracking and vertical lock adjustment

If noise bars appear in the picture during slow motion, press the **TRACKING +** or **-** to reduce the noise bars. If the still picture jitters excessively, press **TRACKING +** or **-** to stabilize the still picture.

Frame by Frame picture

Press **PAUSE** during playback.

Press **SLOW** one by one: The picture advances frame by frame.

To return to playback: Press **PLAY** or **PAUSE**.

Adjusting tracking condition

Automatic tracking adjustment

Whenever you insert a tape and start playback, automatic tracking starts working and continuously analyzes the signal to enable optimum picture quality during playback.

Manual tracking adjustment

If automatic tracking cannot eliminate noises well during playback, press **TRACKING +/-** to eliminate the noises. "MANUAL TR." will appear. Press it briefly for a fine adjustment, or press and hold for a coarse adjustment.

- Press **ATR** to reactivate automatic tracking again. "AUTO TR." will appear.

NOTES:

- The audio output is muted during SPEED SEARCH, STILL, FRAME ADVANCE and SLOW MOTION.
- During picture search mode there will be noise bars which are caused by the system.
- These Special Playback will automatically change to playback after approx. 5 minutes to protect the video tape against excessive wear.

Repeat playback

The whole of the video tape will be played until its end. Then the tape will be wound until its beginning and the playback will be repeated.

1 Press **SETUP MENU**. Press **◀** or **▶** to select **AUTO REPEAT**.

2 Then press **ENTER** to select [ON] or [OFF]. If [ON] is selected, the playback will be repeated endlessly.

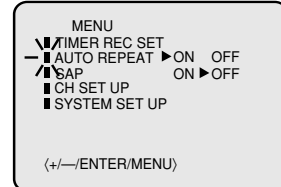

3 Press **VCR MENU** until the menu screen is cleared. If you press **CALL**, "⌂" will appear on the screen.

4 To start the playback, press **PLAY**. The playback will be repeated endlessly.

To cancel repeat mode:

Follow the above step 1, then press **ENTER** to select the OFF position. Press **VCR MENU** to return to the TV.



ZERO RETURN function / Video index search system

ZERO RETURN function

This function makes tape-rewinding stop at the counter 00:00:00 position automatically.

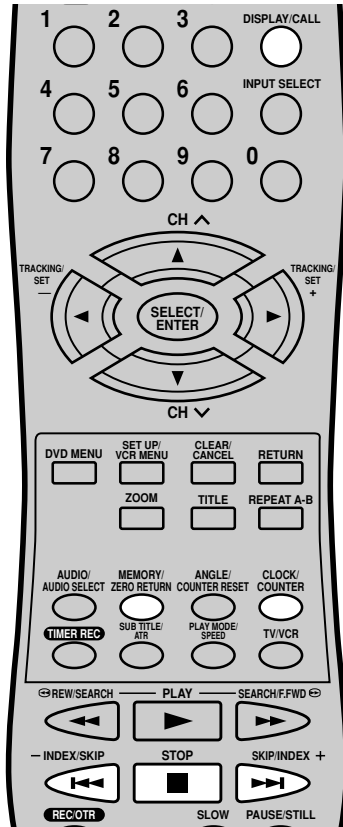

Preparation:

- Turn ON the TV and set to the video input mode.
- Press **VCR/DVD** to select the VCR mode. (The VCR indicator will light)

1 Press **CALL**.

The counter display shows the tape running time during playback or recording.

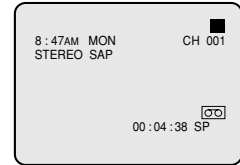

2 Press **COUNTER RESET** at the desired tape position. The counter display will be reset to the "00:00:00" position (e.g. the beginning of recording).

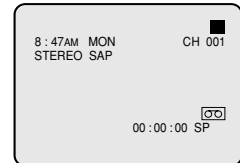
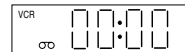

3 Press **STOP** when playback or recording is finished. Press **ZERO RETURN**.

The tape will be rewinded or fast forwarded and automatically stop at the "00:00:00" position.

The **CLOCK/COUNTER**-button

Press **CLOCK/COUNTER**. The clock and tape counter alternate with each other in the display.

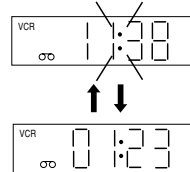

NOTES for Counter Display:

- If you rewind the tape from "00:00:00", a minus sign ("-") will be displayed in front of the time.
- When you load a tape, the counter will reset to "00:00:00".
- The counter does not function on nonrecorded (blank) sections of the tape. When you rewind, fast forward or play tapes through blank sections, the counter stops.

NOTES for Video index search system:

- When you recorded an INDEX mark at the very beginning of the tape, the mark may not be found.
- During INDEX search, the tape may stop and begin to play at a slightly different location.
- INDEX may not function properly with old or worn out video tapes.
- INDEX mark may not be found if it is extremely close to the point where the search began.
- In recording, if you stop recording temporarily, the INDEX mark is not recorded on the tape.

Video index search system

This function enables you to locate the beginning of any recording made on the VCR.

Recording an **INDEX MARK**

The Index Search function automatically records an INDEX mark on the tape whenever a recording is initiated.

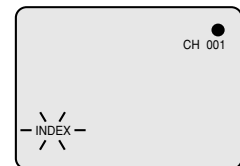

Index Search

Press **INDEX** **▶▶** or **◀◀** during stop or play mode.

For Succeeding programs: Press **INDEX** **▶▶**.
For Preceding programs: Press **INDEX** **◀◀**.
(Additional press increases the INDEX NO. up to 9.)

The **INDEX** **▶▶** or **◀◀** is pressed, the unit starts searching the INDEX NO. selected and finds the portion, then playback starts automatically.

To stop the Index Search, press **STOP**.



▶▶ or ◀◀ is displayed

INDEX NO. (up to 9)





Recording a TV program

Recording and viewing the same TV program

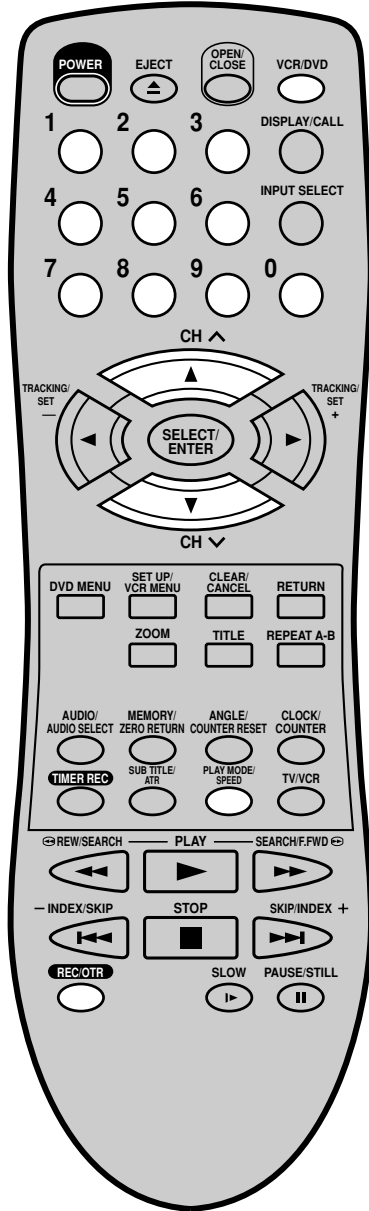

Preparation:

- Turn ON the TV and set to the video input mode.
- Press **VCR/DVD** to select the VCR mode. (The VCR indicator will light)

- 1 Load a cassette tape with the erase prevention tab intact. The VCR will automatically turn on.



- 2 Press **SPEED** to select the desired tape speed SP or SLP. The tape counter and SP or SLP will appear on the screen for about 4 seconds.



- 3 Set the TV/CATV option to the appropriate position (See page 20).

TV - VHF/UHF channels
CATV - CABLE TV channels

- 4 Press **Number keys** or **CH ^/v** to select the channel to be recorded.

- 1-9 Press **0** twice and then **1-9** as required. Example: To select 2, Press **"002"**.
- 10-12 Press **0** first and then the remaining 2 digits in order from left to right. Example: Press **012** for "12".
- 13-99 Press 2 digits in order. Example: Press **22** for "22".
- 100-125 Press the 3 digits in order. Example: Press **110** for "110".

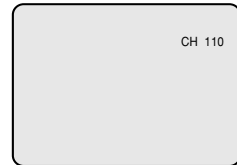

VHF/UHF/CATV CHANNELS

TV	CATV
VHF 2-13	VHF 2-13
UHF 14-69	STD/HRC/IRC 14-36 (A) (W) 37-59 (AA) (WW) 60-85 (AAA) (ZZZ) 86-94 (86) (94) 95-99 (A-5) (A-1) 100-125 (100)(125) 01 (5A)

NOTES:

- If the erase prevention tab is removed, the tape will eject when **REC/OTR** is pressed for recording.
- If you wish to watch the DVD playback during the normal recording on VCR, press **VCR/DVD** to change to DVD mode and perform the DVD playback (see page 35).
- You can not record disc material in DVD, Video CD, Audio CD, etc. onto a video tape with this DVD/VCR.

- 5 Press **REC/OTR**. "●" will appear on the screen for about 4 seconds and "REC" will appear on the display.

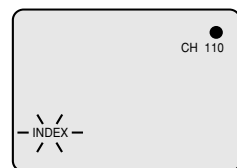



Recording a TV program

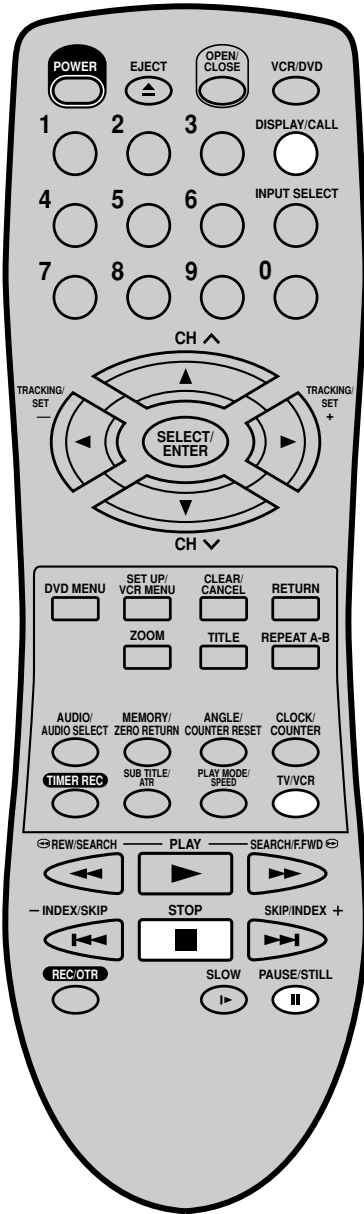

To stop recording

Press **STOP** to stop recording. "■" will appear on screen for about 4 seconds.

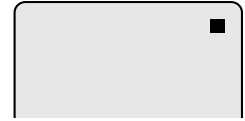

To stop recording temporarily

Press **PAUSE/STILL** to avoid recording unwanted material. Press again to continue the recording.

"●||" will appear on screen for about 4 seconds.



NOTES:

- The pause function will be released after 5 minutes to prevent damage to the tape or the VCR. The VCR will change to the STOP mode.
- You can select a recording channel in the recording pause mode.

Recording one program while watching another

While the VCR is recording, press **TV/VCR** to select the TV position. The "VCR" will go off and recording will continue. Select the TV channel you want to watch by using the TV channel selector.

NOTE:

Some CATV hookups do not permit viewing one channel while recording another. See pages 14,15.

To Display VCR operation Status

Press **CALL**. The clock, day of the week and more informations will be indicated.

While watching TV

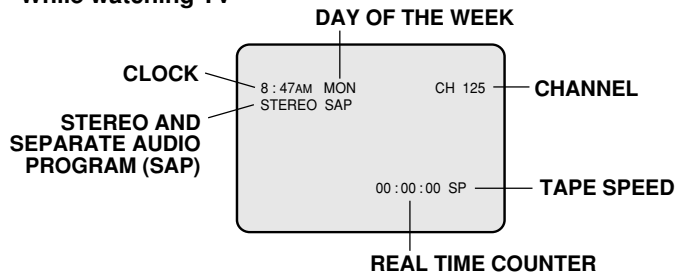

While operating a tape

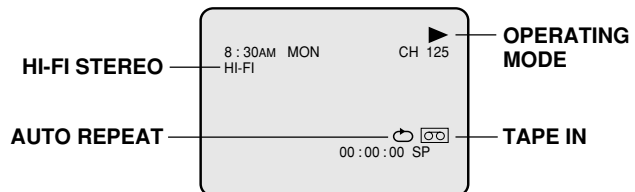

Auto Rewind feature

This VCR will automatically rewind the tape when the tape has ended (except during OTR and TIMER REC). It will also eject the tape.

To cancel the indicating: Press **CALL** until all indicator disappear.





One-touch Timer Recording (OTR)

The One-touch Timer Recording feature provides a simple and convenient way to make a timed recording.

Preparation:

- Turn ON the TV and set to the video input mode.
- Press **VCR/DVD** to select the VCR mode. (The VCR indicator will light)

Example: One-touch Timer Recording for 30 minutes.

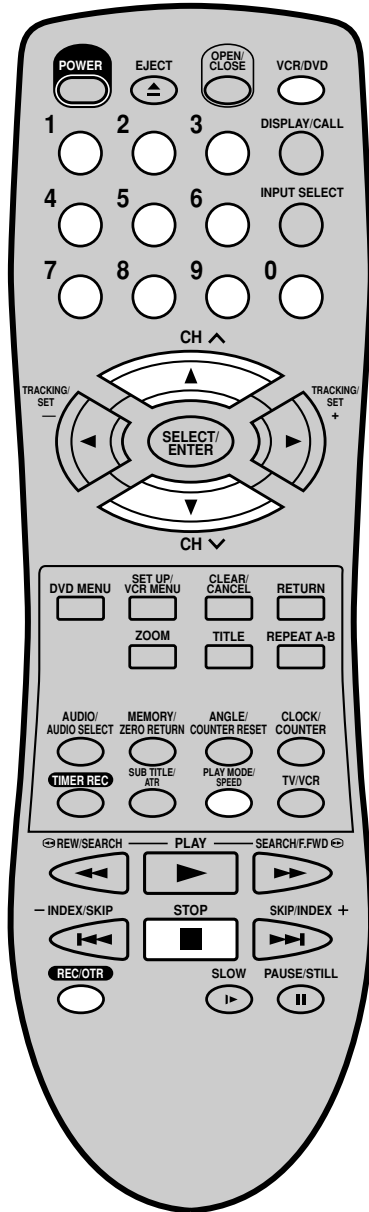

1 Load a cassette tape with the erase prevention tab intact. The VCR will automatically turn on.

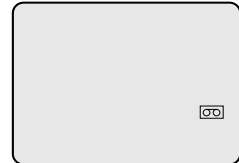

2 Press **SPEED** to select the desired tape speed SP or SLP. The tape counter and SP or SLP will appear on the screen for about 4 seconds.

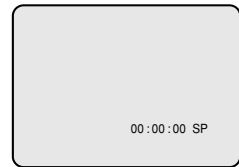

3 Set the TV/CATV option to the appropriate position (See page 20).

TV - VHF/UHF channels
CATV - CABLE TV channels

4 Press **Number keys** or **CH ^/v** to select the channel to be recorded.

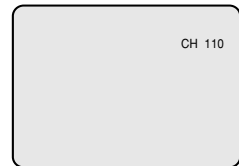

5 Press **REC/OTR**. Press the button again to stop recording after 30 minutes. Each additional press of **REC/OTR** will increase recording time as shown in the chart below, up to a maximum of 5 hours. The OTR and recording time will appear on the screen for about 4 seconds. And, REC will keep blinking in the display.

Press	Recording time	Press	Recording time
once	NORMAL REC	6 times	3:00
twice	0:30	7 times	4:00
3 times	1:00	8 times	5:00
4 times	1:30	9 times	NORMAL REC
5 times	2:00		

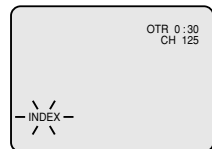

NOTE:

If you wish to watch the DVD playback during the OTR, press **DVD/VCR** to change to DVD mode and perform the DVD playback (see page 35).

To cancel OTR

Press **STOP** or turn off the power. "■" will appear on screen for about 4 seconds.

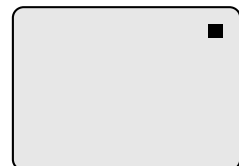



Timer Recording

Timer recording can be programmed on-screen with the remote control. The built-in timer allows automatic unattended recording of up to 8 programs within 1 month.

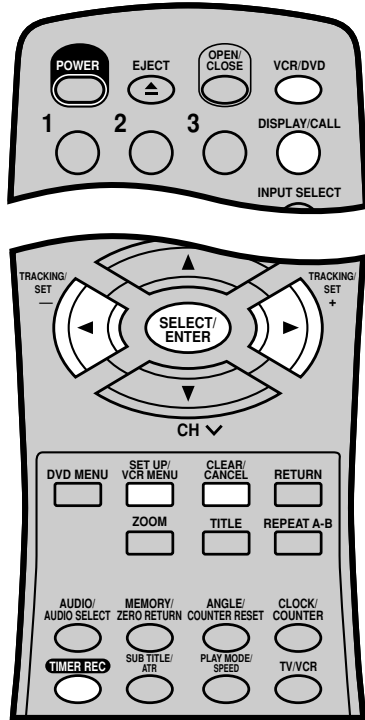

Preparation:

- Press **VCR/DVD** to select the VCR mode.
- Load a cassette tape with the erase prevention tab intact.
- Make sure with **CALL** that the time and date are correct. (see page 27).

Example: Program a timer recording for the 26th day, channel 125 (CATV), 11:00 - 11:30 PM on timer program number 1 (Tape speed: SLP).

- 1 Press **VCR MENU**. Check the **TIMER REC SET** option is selected, then press **ENTER**.

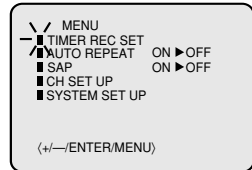

- 2 Press **SET +** or **-** to select one of the program line, then press **ENTER**.

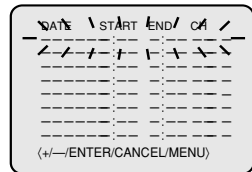

- 3 Press **SET +** or **-** to select the date, then press **ENTER**.

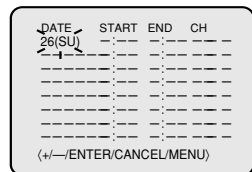

- 4 Set the **start time**, **end time**, **channel** and **tape speed** as in step 3.

NOTES:

- Press **CANCEL** to move cursor backward for correction.
- To record from external source set the channel to "L". "L" will appear next to CH 125 (or 69).

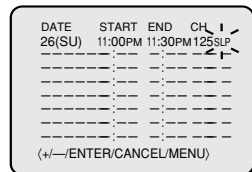

- 5 To enter other programs, repeat step 2 through 4.

- To return to the normal screen, press **VCR MENU** twice.

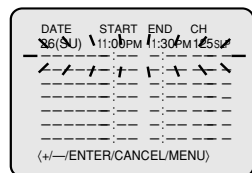

- 6 Press **TIMER REC**. The clock symbol (⌚) will appear on the display and the VCR stands by for recording. At the same time, VCR mode will change to DVD mode automatically. You can use DVD even if the VCR is in the Timer recording mode. If you do not use the DVD, turn the power off. The timer recording will start at 20 seconds before the time you predetermined.

NOTES:

- If the clock symbol (⌚) does not appear on the display in spite of the pressing of **TIMER REC**, the cassette may not have been loaded yet. (see page 22)
- If the cassette is ejected in spite of the pressing of **TIMER REC**, the erase prevention tab of the cassette may have been removed. (see page 22)



Timer-Recording

Timer Recording Special case

Weekly (e.g. WKL-TU: each Tuesday) or daily (e.g. MO-SA: Monday to Saturday) Timer recording

Follow the procedure of timer recording on the previous page. At picture 3 press **SET +** or **-** repeatedly until the desired setting appears. Then press **ENTER**.

When you press **SET -** repeatedly, the indicator at DATE will change as follows, in case today is Friday.

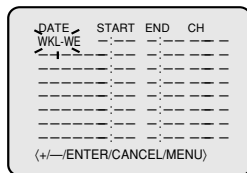
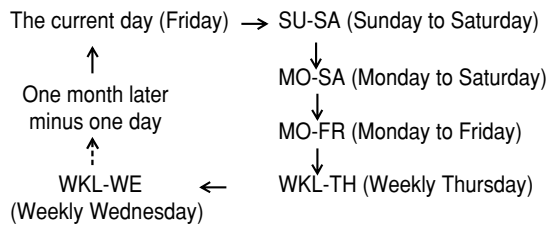

Confirmation / Cancellation of the Timer Recording

1 If the Timer has been activated, now press **TIMER REC** to deactivate the Timer. The clock symbol (🕒) will disappear. Then press **VCR/DVD** to change to VCR mode.

2 To confirm Timer program:

At picture 1 on the previous page select **TIMER REC SET** option and press **ENTER**. Then the timer program list as right will appear on the screen.

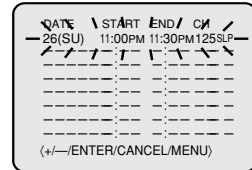

3 To cancel Timer program:

Press **SET +** or **-** to select the unnecessary program, then press **CANCEL** to cancel the program.

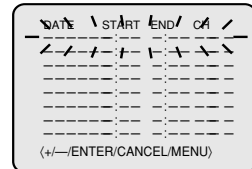

4 Press **VCR MENU** repeatedly until the TV-picture appears.

In case of Timer programs-overlapping

- Do not overlap timer programs as portions of the conflicting programs will be lost. The first recording time has priority over the next recording time as shown in the diagram below.

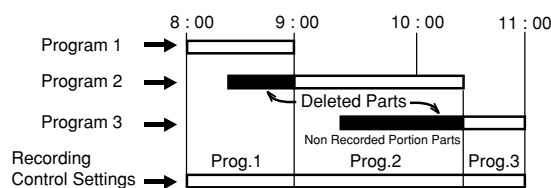

NOTES:

- The daily/weekly recording can be made continuously until the recording is canceled or the tape reaches the end.
- During timer recording the automatic rewinding mechanism does not function.

NOTES:

- If there are other timed record programs remaining, **TIMER REC** must be pressed to reactivate the timer, otherwise the remaining timer record programs will be ignored.
- You can not confirm the Timer program during timer recording operation.
- You can correct or cancel the programmed setting in program confirm mode.





Stereo recording and playback / Separate Audio Program (SAP)

Stereo recording and playback

The VHS Hi-Fi audio system permits high fidelity recording of MTS STEREO TV broadcasts.

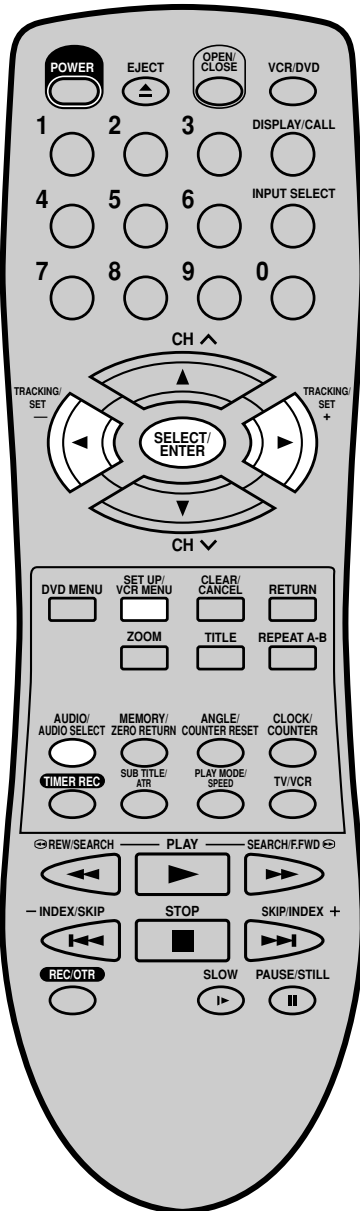

When a MTS STEREO broadcast is received, the STEREO will appear on the screen and the program can be viewed or recorded in stereo.

The Hi-Fi STEREO recording procedure is the same as for normal recordings.



NOTE:

When using a CATV system, stereo TV programs may be transmitted over a mono cable channel. In this case the word "STEREO" will not appear and the sound will be in mono.

Output selection

When viewing an MTS STEREO TV program, or playing a prerecorded VHS Hi-Fi STEREO videotape, press **AUDIO SELECT** to select how the audio will be heard through the speakers. Normally set to the Hi-Fi STEREO position, this button can be set to the MONO position if the stereo broadcast or videotape audio is of poor quality. The "R" and "L" positions allow the audio from the Right or Left Hi-Fi channel to be heard over both TV speakers. This button has no effect when viewing a MONO videotape or TV program. Each time when you press the button, OUTPUT SELECTION display appears on the screen for several seconds. Refer to the chart below.

OUTPUT SELECTION	SOUND HEARD ON BOTH SPEAKERS
STEREO	STEREO
L CH	LEFT CHANNEL AUDIO
R CH	RIGHT CHANNEL AUDIO
MONO	MONO

Separate Audio Program (SAP)

Your VCR is fitted with an SAP broadcast system which enables you to switch to a separate audio program when viewing a selected channel.

This function applies only when the program is broadcast in multi-languages through the SAP broadcast system.

- 1 Press **VCR MENU**. Then press **◀** or **▶** to select "SAP".
- 2 Then press **ENTER** to select [ON].

Then press **VCR MENU** until the menu screen is cleared.

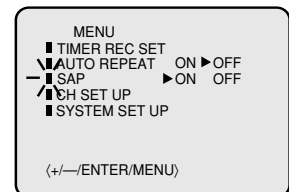

NOTES:

- When playing back a tape that is not recorded in Hi-Fi stereo mode, the audio will automatically be monaural.
- When listening to a VHS Hi-Fi video tape or MTS broadcast through the VHF/UHF jack (Audio/Video cord not connected), the sound will be monaural.

Listening to SAP

When the VCR is turned on or a channel selection is made, make certain "SAP" appears on the screen. This means that the "Separate Audio Program" broadcasting is available.

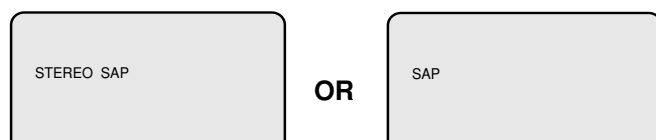



Duplicating a video tape/Duplicating a disc material onto a video tape

Duplicating a video tape

If you connect the VCR to another VCR or camcorder, you can duplicate a previously recorded tape. Make all connections before turning on the power.

- 1 Load a blank cassette tape with the erase prevention tab intact into the recording VCR. Load a previously recorded tape into the playback VCR or CAMCORDER.
- 2 Press **SPEED** to select the desired tape speed SP or SLP. It is recommended that you set the Speed to the SP mode on the recording VCR for best results.
- 3 Press **INPUT SELECT** to select AUDIO/VIDEO input position. "L" will appear in the display. 
- 4 Press **REC/OTR** on the recording VCR, then press **PAUSE/STILL**.
- 5 Press **PLAY** button on the playback VCR or CAMCORDER, then press **PAUSE/STILL** button.
- 6 Press **PAUSE/STILL** on both the VCRs simultaneously to begin the duplicating process.

Connection with second Video recorder

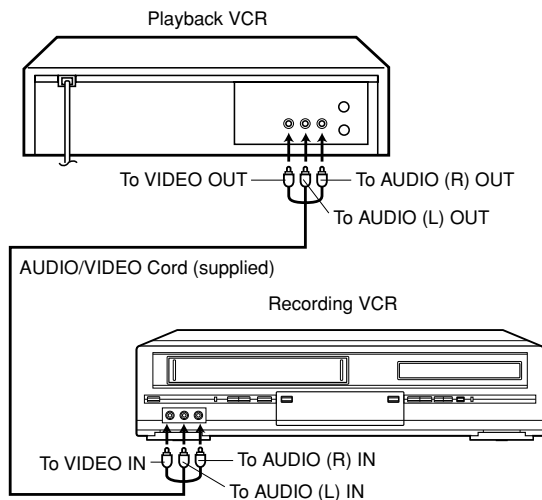

Connection with Video camera

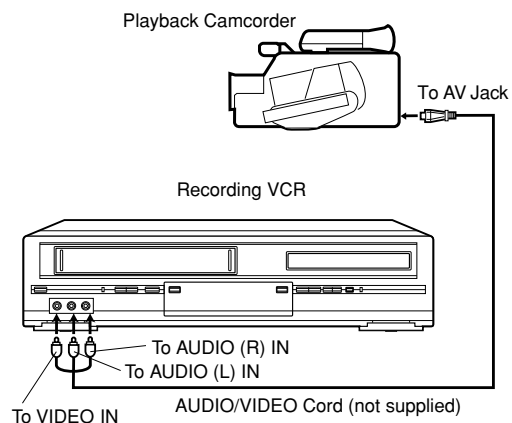

For duplicating a previously recorded tape from a camcorder, follow the camcorder manufacturer's instructions. A typical camcorder dubbing hookup is shown above.



Disc

This unit applies to DVD discs from Region 1 only.
The loaded Disc (DVD, Audio-CD and MP3-CD) will be recognized automatically.
The suitable Disc-format are: DVD, CD-R and CD-RW.

Do not play DVD-ROM, DVD-Audio, CDV, Video-CD, CD-G or Photo CD to prevent accidental erasure of prerecorded material.

Some DVDs is played back with a Copy guard system. In case of a dubbing on video tape, strong disturbance may occur. This is not a defect of this DVD/VCR.

Title

When two or more movies are recorded on a disc, the disc is divided into two or more sections. Each section is called a "TITLE".

Chapter

The titles can be subdivided into many sections. Each section is called a "CHAPTER".

Track

An Audio CD can contain several items. These are assigned to the tracks.

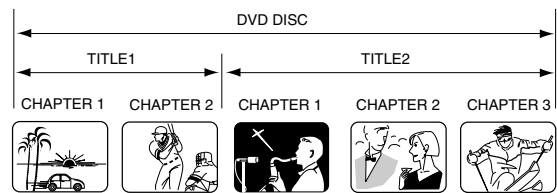

Removing Disc from Case

Be sure to hold the edge of disc. Do not touch the surface of the disc.
Pick up the disc gently from the case.

- Do not scratch the disc.
- Do not get dirt on the surface of the disc.
- Do not stick a label or adhesive tape on the disc.
- Do not drop or bend the disc.

Storing Disc

- Store the disc in the case to avoid risk of scratches, dirt or damage.
- Do not leave disc exposed to direct sunlight or in hot or humid places.

Cleaning Disc

Wipe the disc with a clean, dry cloth from centre to edge.

- Do not wipe the disc round.
- Do not use liquid or aerosol cleaners.

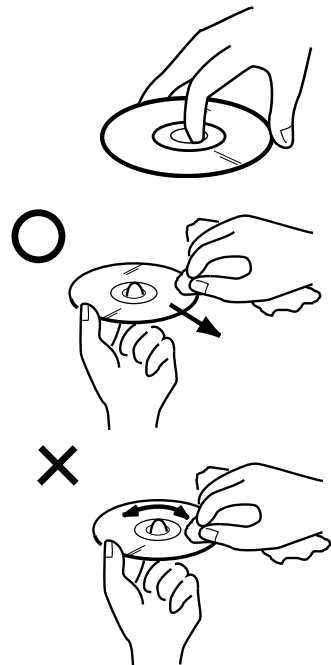



Setting setup language

The setup language can be selected.

Preparation:

- Turn ON the TV and set to the video input mode.
- When using an amplifier, switch on the amplifier.

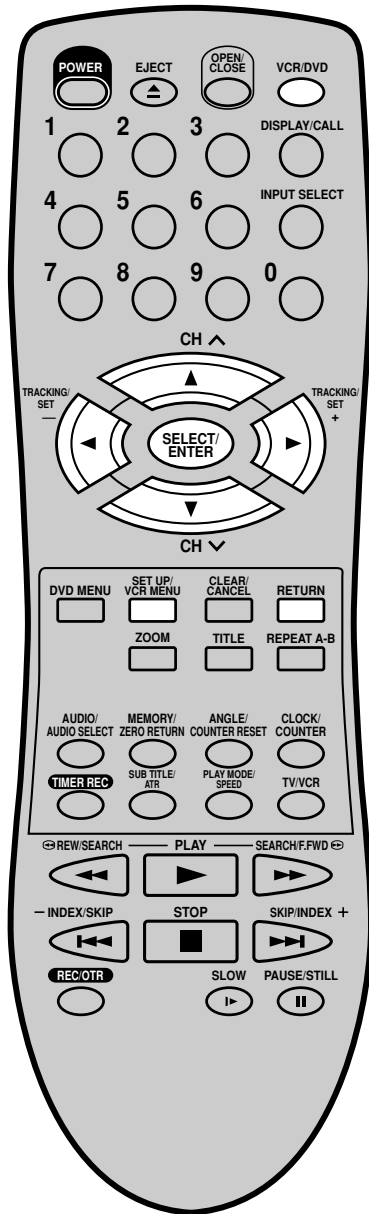

1 Press **VCR/DVD** to select the DVD mode. (The DVD indicator will light)
 “No Disc” will appear on the screen. (If DVD disc has already loaded, the playback will start automatically.)



2 Press **SET UP** in the stop mode. The SETUP MENU of DVD will appear on the screen. Then press **◀** or **▶** to select “Language”.

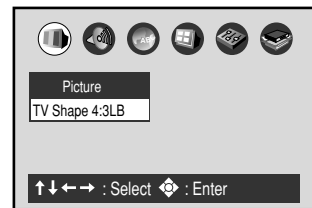

3 Press **▲/▼** to select On-screen Language, then press **ENTER**.

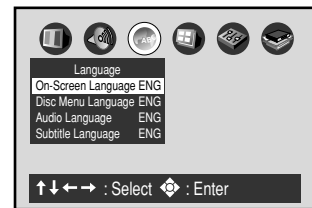

4 Press **▲/▼** to select desired language (e.g. English), then press **ENTER**.



NOTE: To make SETUP screen disappear, press **SETUP** (or **RETURN**).

If the DVD/VCR does not operate properly: Static electricity, etc., may affect the player's operation. Disconnect the AC power cord once, then connect it again.





Playback procedure

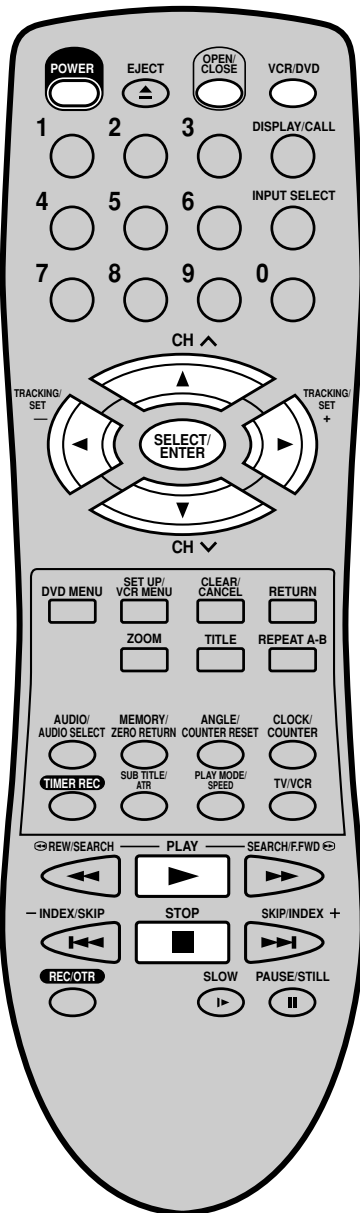

Preparation:

- Turn ON the TV and set to the video input mode.
- Press **VCR/DVD** to select the DVD mode. (The DVD indicator will light)

1 Press **OPEN/CLOSE**.
The disc tray will open.

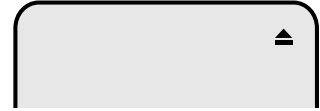

2 Place a disc onto the tray.
Hold the disc, position it with the printed label side up, align it with the guides, and place it in its proper position.

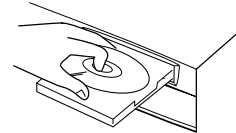

3 Press **PLAY** or **OPEN/CLOSE**.
The disc tray closes automatically.
On the screen, ▲ change to "Ⓢ" and then playback will commence.



- A menu screen may appear on the TV screen, if the disc has a menu feature. In this case, press ▲, ▼, ◀, ▶ or **ENTER** to operate a menu feature.



4 Press **STOP** to end playback.

- The DVD/VCR memorizes the stopped point, depending on the disc. "To Return To The Last Scene Viewed, Press Play. To Disable This Operation, Press STOP Again." appears on the screen for approx. 4 seconds. "▶" keep blinking in the display until the playback is stopped completely. Press **PLAY** to resume playback (from the scene point).
- If you press **STOP** again ("■" appears on the screen) or unload the disc, the DVD/VCR will clear the stopped point.

5 Then press **OPEN/CLOSE**.

- The disc tray opens.
- Remove the disc and press **POWER**.
- The disc tray closes automatically and DVD/VCR turns off.

NOTES:

- If a non-compatible disc is loaded, "Please Check Disc", "Disc playback unauthorized Consult owners manual for further information" or "Parental Lock" will appear on the TV screen according to the type of loaded disc. In this case, check your disc again (See pages 33 and 43).
- Some discs may take a minute or so to start playback.
- A "Prohibition" symbol (⊘) may appear at the upper right of the screen. This symbol means either the feature you tried is not available on the disc, or the DVD/VCR can not access the feature at this time. This does not indicate a problem with the DVD/VCR.
- When you set a single-faced disc label downwards (ie. the wrong way up) and press **PLAY** or **OPEN/CLOSE**, "Ⓢ" will appear and remain on the screen for approx. 40 seconds and then it will change to "Please Check Disc".
- Some playback operations of DVDs may be intentionally fixed by software producers. Since this DVD/VCR plays DVDs according to the disc contents the software producers designed, some playback features may not be available. Also refer to the instructions supplied with the DVDs.
- When playing DTS-encoded Audio CDs, excessive noise will be heard from the analogue stereo outputs. To avoid possible damage to the audio system, the consumer should take proper precautions when the analogue stereo outputs of the DVD/VCR are connected to an amplification system.





Special playback

Note: there may be a slight delay between you pressing the button and the function activating.

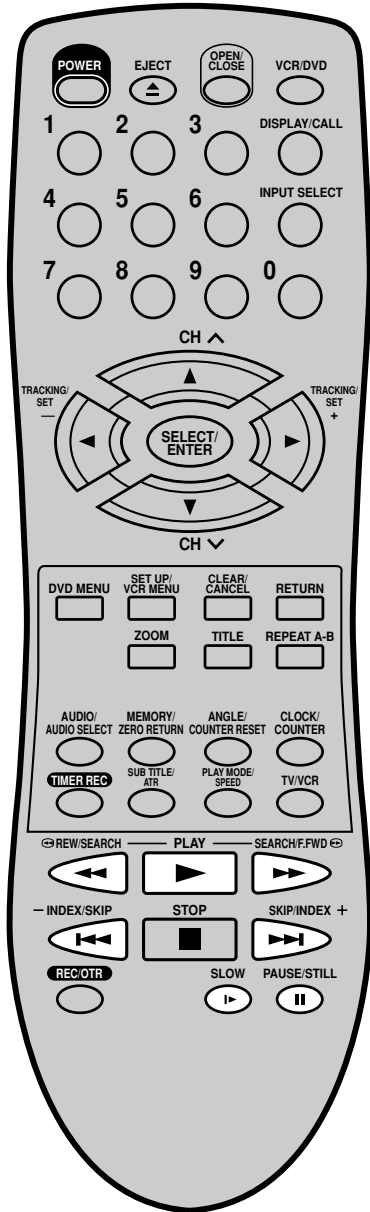

Fast Forward Playback

Press **F.FWD** during normal playback. Each press of **F.FWD** will increase the speed of the search x2, x8, x30, x100. (in case of Audio-CD: x4 and x8 are available)

- To resume normal playback, press **PLAY**.

Review Playback

Press **REW** normal playback. Each press of **REW** will increase the speed of the search x2, x8, x30, x100. (in case of Audio-CD: x4 and x8 are available)

- To resume normal playback, press **PLAY**.

Still Playback

Press **PAUSE/STILL** during normal playback.

To resume normal playback, press **PLAY**.



Frame Advance

Press **PAUSE/STILL** during still playback. One frame is advanced each time you press **PAUSE/STILL**.

To resume normal playback, press **PLAY**.



Slow-motion Playback

Press **SLOW** during normal playback or still playback. Each press of **SLOW** will change the speed of the slow x1/2, x1/4, x1/8.

- To resume normal playback, press **PLAY**.
- To resume the still playback, press **PAUSE/STILL**.

NOTE:

The unit is capable of holding a still video image or On screen display image on your television screen indefinitely. If you leave the still video image or On screen display image displayed on your TV for an extended period of time, you risk permanent damage to your television screen. Projection televisions are very susceptible.

Locating a chapter or track

Press **SKIP (▶▶)** Forward or **SKIP (◀◀)** Reverse during playback to locate a chapter that you want to watch. Each time you press the button, a chapter or track is skipped.





Zooming

Preparation:

- Turn ON the TV and set to the video input mode.
- Press **VCR/DVD** to select the DVD mode. (The DVD indicator will light)

Zooming

This unit will allow you to zoom in on the frame image. You can then make selections by switching the position of the frame.

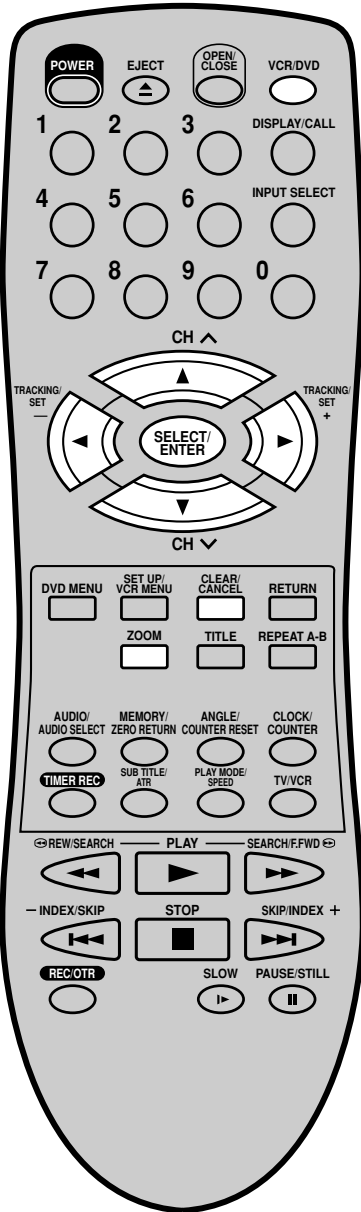

- 1 Press **ZOOM** during playback. The center part of the image will be zoomed in. As you repeatedly press the **ENTER** or **ZOOM** button while "ZOOM" is selected, the magnification level changes. Variation of the levels includes image reduction.

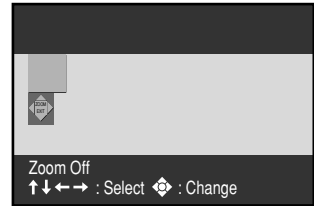

- If you want to return to a 1:1 view, select "EXIT" and press **ENTER**.

- 2 Press **▲/▼** or **◀/▶** to view a different part of the frame. You may move the frame from the center position to UP, DOWN, LEFT or RIGHT direction.
 - Press **CLEAR** to restore the zoom point to the center of the picture.

- 3 While "ZOOM" is selected, press **ZOOM** repeatedly to return to a 1:1 view.



Repeat playback

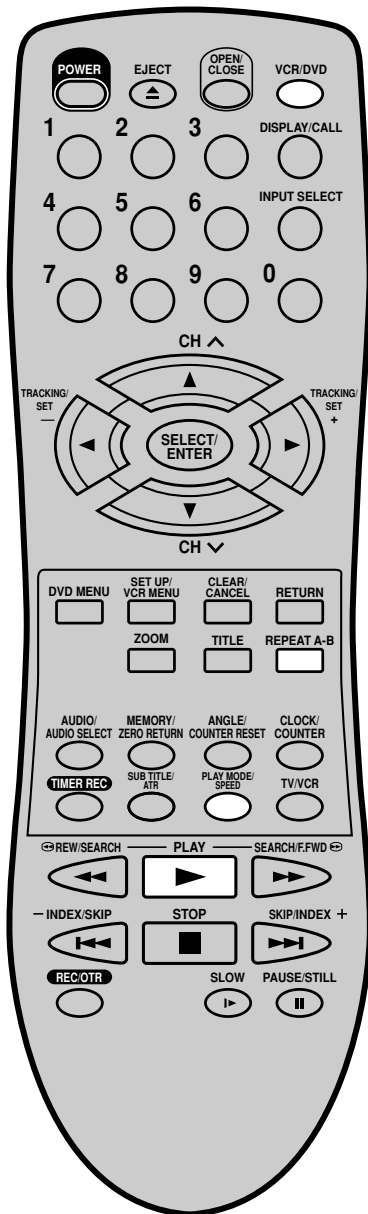

Preparation:

- Turn ON the TV and set to the video input mode.
- Press **VCR/DVD** to select the DVD mode. (The DVD indicator will light)

Title, Chapter, Track, Random Playback

REPEAT PLAYBACK

- 1 Press **PLAY MODE** repeatedly to select "Chapter Repeat", "Title Repeat" or "ALL". (In case of CD, select "Track Repeat" or "ALL Repeat")

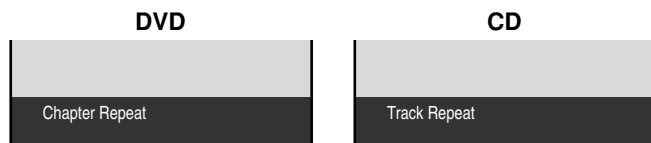

- 2 During play repeat playback will start automatically. During stop mode press **PLAY** within about 5 seconds after you press the **PLAY MODE** button to start repeat playback.
 - To resume normal playback, select Off.

A-B Repeat Playback

A-B repeat playback allows you to repeat material between two selected points.

- 1 Press **REPEAT A-B** during playback. The start point is selected.
- 2 Press **REPEAT A-B** again. The end point is selected. Playback starts at the point that you selected. Playback stops at the end point, returns to Point A automatically, then starts again.

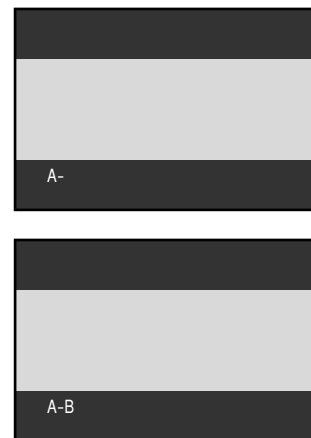

To resume normal playback press **REPEAT A-B** again. "Repeat Off" appears on the screen.

NOTES:

- Some discs may not work with the repeat operation.
- In A-B repeat mode, subtitles near point A or B may not appear.
- During the A-B Repeat Playback the ANGLE feature will not operate.
- You may not be able to set A-B Repeat, depending on the scenes of the DVD.
- A-B repeat does not work with an interactive DVD and MP3-CD.
- Random playback can not be combined with Repeat playback.





Memory playback/Random playback

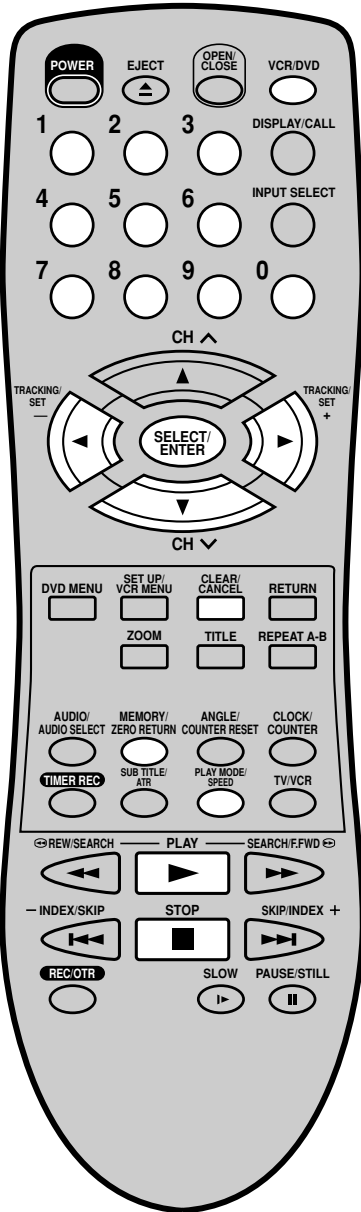

Preparation:

- Turn ON the TV and set to the video input mode.
- Press **VCR/DVD** to select the DVD mode. (The DVD indicator will light)

Memory playback

You can arrange the order of titles, chapter or tracks on the disc.

1 Press **MEMORY**.

In stop mode

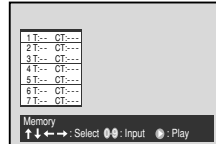

In play back



2 Press **◀/▶** to select "T" or "CT". Use **Number keys** to Input the favorite number.

In stop mode

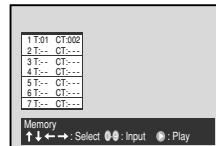

In play back



T : Title number
CT : Chapter number or track number

3 Press **▼** or **ENTER**. Set the "T" and "CT" to bar that you want to enter as In step 2.

In stop mode

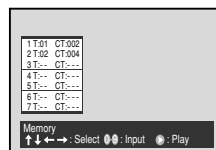

In play back



- When you select another chapter In the same title, you do not need to select the title number.

4 Press **PLAY** to start MEMORY playback.

- To resume normal playback, press **CANCEL**.

Random playback

1 Press **PLAY MODE** repeatedly to select " Chapter Random" or "Title Randon".(In case of CD, select Track Random)

DVD

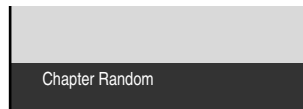

CD

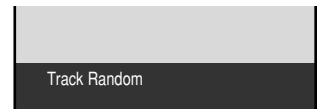

NOTES:

- The memory is cancelled when press **STOP** during memory playback.
- Random playback can not be combined with Repeat playback.
- You can program up to 30 selections into the memory.
- Depending on the DVD, Chapter Random operation may not work during playback.
- You cannot use the random playback with memory playback.

2 During play random playback will start automatically. During stop mode press **PLAY** within about 5 seconds after you press the **PLAY MODE** button to start random playback.

- To resume normal playback, select Off.





MP3 Playback

This player can play back the MP3-data which recorded on CD-R or CD-RW. To produce the MP3-data, you need a Windows-PC with CD-ROM drive and a MP3-encoding Software (not supplied).
The Apple-HFS-System can not be played.

MP3 CD Information

Limitations on MP3 CD playback

- MP3 CD is the disc that standardized by ISO9660, its file name must include 3-digits extension letters, "mp3".
- The directory and file names of the MP3 CD must be corresponded to the ISO standardized files.
- This unit can read 200 files per one disc. If one directory has more than 200 files, it reads up to 200 files, the more files will be omitted.
- As for multi-session disc, only the first session can be played.
- If the CD has both audio tracks and MP3 files, only audio tracks are played.
- It would take one minute or more for this unit to read MP3 files depending on its structure.
- Music recorded by "Joliet Recording Specification" can be played back, the file name is displayed (within 8 letters) on the screen shorter than the actual file names.
- The music files recorded by "Hierarchical File System" (HFS) cannot be played.

Limitations on display

- The maximum number for display is 8 letters. Available letters for display are the following: capital or small alphabets of A through Z, numbers of 0 through 9, and _ (under score).
- Other letters than those above are replaced in hyphen.

Notes on MP3 files

- To play back MP3 CD in the recorded order,
1. please use the MP3 software with the function that can record data alphabetically or numerically.
 2. we recommend you to put the name including two-digit or threedigit number like "01" "02" or "001" "002" on each file.
 3. please refrain from making many sub-folders by preference.

CAUTION:

- Some MP3 CDs can not be played back depending on the recording conditions.
- The CD-R/RW that has no music data or non-MP3 files can not be played back.

Preparation:

- Turn ON the TV and set to the video input mode.
- Press **VCR/DVD** to select the DVD mode. (The DVD indicator will light)

- 1 Press **OPEN/CLOSE**.
The disc tray will open.
Then place a disc onto the tray.

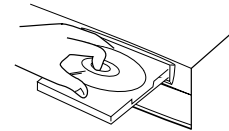

- 2 Press **PLAY** or **OPEN/CLOSE**.
The disc tray closes automatically.
On the TV-screen, "CD" and then reading file number will appear.
Reading will take as much time as the number of file.

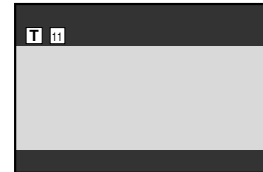

- 3 Press **DISPLAY**.
Then press **◀/▶** to select MP3 and press **ENTER**.

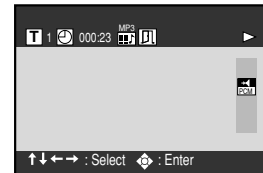

- 4 Press **▲/▼** or **◀/▶** to select your desired track, then press **ENTER**. Track is selected and play commences.
 - In case the folder include more than 9 tracks, press **◀/▶** to display next track list.
 - To remove track list, press **CANCEL**.
 - Press **◀/▶** to select "T" and press **Number keys** your desired to input.



- 5 Press **STOP** to end playback.
 - The unit records the stopped point.
Press **PLAY** to resume playback (from the scene point).
 - If you press **STOP** again or unload the disc, the unit will clear the stopped point.

- 6 Then press **OPEN/CLOSE**.
The disc tray opens.
Remove the disc and press **POWER**.
The disc tray closes automatically and DVD/VCR turns off.

NOTES:

- During MP3-Playback, you can not use SEARCH, A-B Repeat functions.
- You can use Repeat(Track or All) and Random functions for MP3 CD Playback.(See page 38 and 39)





Changing soundtrack language / Changing Subtitles language

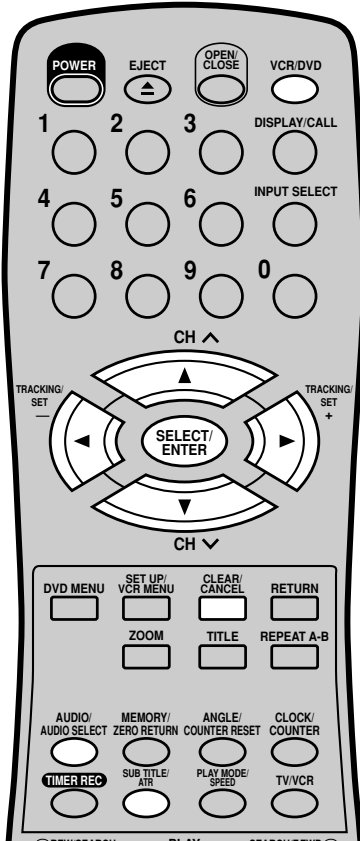

Preparation:

- Turn ON the TV and set to the video input mode.
- Press **VCR/DVD** to select the DVD mode. (The DVD indicator will light)

Changing soundtrack language

You can select the language when you play a multilingual disc.

- 1 Press **AUDIO** during playback. The current soundtrack language is displayed.

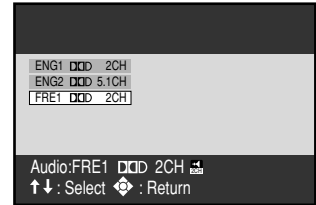

- 2 Press **AUDIO** repeatedly until the desired language is selected. The on-screen display will disappear after a few seconds.

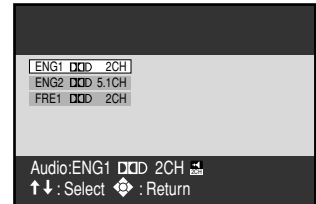

Changing Subtitles language

You can select the language when playing back a disc recorded with multi-lingual subtitles.

- 1 Press **SUB TITLE** during playback. Then press **▲/▼** to select the desired language.
 - To turn off the subtitle setting display, press the **CLEAR** or **ENTER** button.
 - To turn the subtitles off, select "Off".

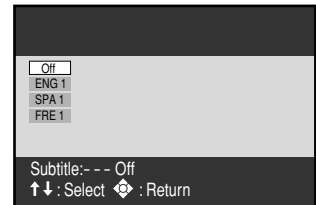

- 2 Press **SUB TITLE** or **◀/▶** to turn Subtitles on or off.

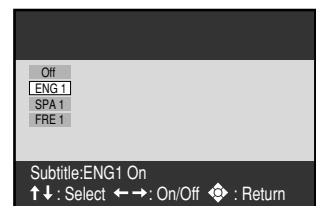

NOTES:

- If the desired language is not heard after pressing the button several times, the language is not recorded on the disc.
- Changing soundtrack or subtitle language is cancelled when you open the disc tray or turn the power off. The initial default language or available language will be heard and seen if the disc is played back again.
- Depending on the DVD, you may not be able to turn the subtitles on even if they are recorded on it. Depending on the DVD, you may not be able to turn the subtitles off even if you set the subtitle function to off. Depending on the DVD, you may not be able to change the subtitles even if multilingual subtitles are recorded on it. While playing the DVD, the subtitle may change when: -you open or close the disc tray -you change the title.
- During some scenes, the subtitles may not appear immediately after you select "On".
- The abbreviation of the language appears instead of the language name. Refer to the list of languages and their abbreviations. (See on page 55)





Changing angles / Title selection / DVD menu

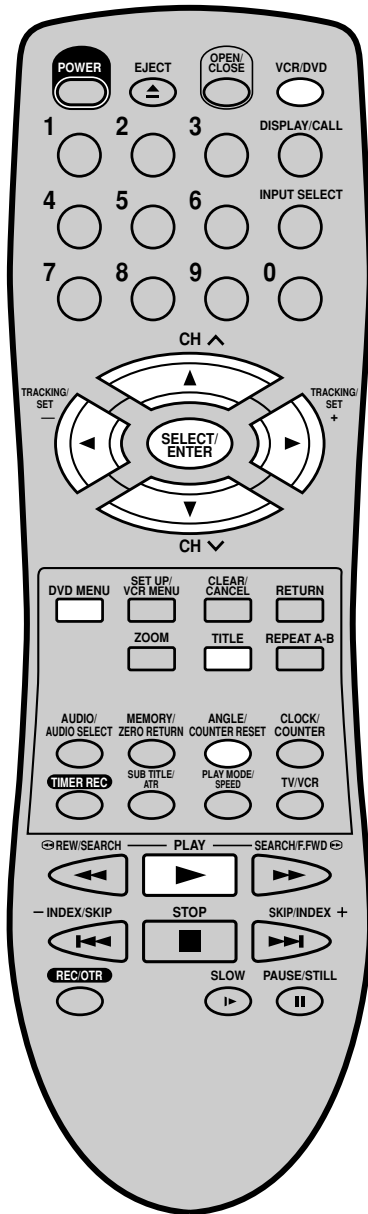

Preparation:

- Turn ON the TV and set to the video input mode.
- Press **VCR/DVD** to select the DVD mode. (The DVD indicator will light)

Changing Angles

When playing back a disc recorded with multi-angle facility, you can change the angle that you are viewing the scene from.

- 1 Press **ANGLE** during playback. The current angle will appear.

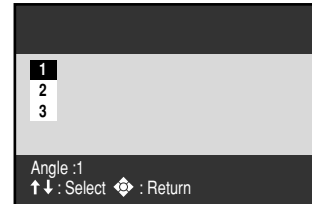

- 2 Press **ANGLE** or **▲/▼** repeatedly until the desired angle is selected.
 - To turn off the angle number display, press the **CLEAR**.
 - You can change the camera angle directly by pressing the number keys corresponding to its angle number instead of using the **▲/▼** buttons.

Title Selection

Two or more titles are recorded on some discs. If the title menu is recorded on the disc, you can select the desired title.

- 1 Title menu appears on the screen.
 - Press **TITLE** again to resume playback at the scene when you pressed **TITLE**.
- 2 Press **▲/▼** or **◀/▶** to select the desired title.
- 3 Press **ENTER** or **PLAY**. The playback of the selected title will start.

DVD Menu

Some DVDs allow you to select the disc contents using the menu.

When you play back these DVDs, you can select the subtitle language and sound-track language, etc. using the DVD menu.

- 1 Press **DVD MENU** during playback. The DVD menu appears on the screen.
 - Press **DVD MENU** again to resume playback at the scene when you pressed **DVD MENU**.
- 2 Press **▲/▼** or **◀/▶** to select the desired item.
- 3 Press **ENTER**. The menu continues to another screen. Repeat steps 2 and 3 to set the item completely.

NOTES:

- Depending on the DVD, you may not be able to change the angles even if multi-angles are recorded on the DVD.
- Depending on the DVD, you may not be able to select the title.
- Depending on the DVD, a "title menu" may simply be called a "menu" or "title" in the instructions supplied with the disc.





Parental control

Some discs are specified not suitable for children. Such discs can be limited not to play back with the unit.

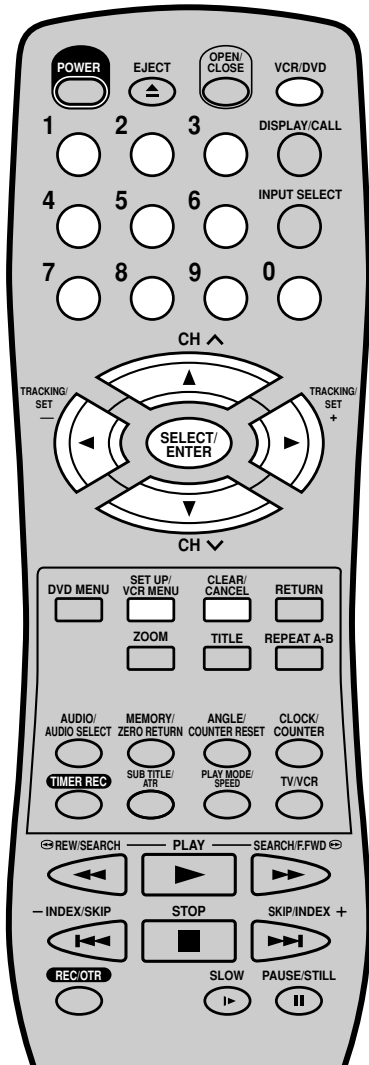

NOTES:

- If each setup (page 43~53) has been completed, the unit can always be worked under the same conditions (especially with DVD discs). Each setup will be retained in the memory if you turn the power off.
- Depending on the discs, the unit cannot limit playback.
- Some discs may not be encoded with specific rating level information though its disc jacket says "adult". For those discs, the age restriction will not work.
- Do not forget the password. If you forget the password, contact the dealer that you purchased the unit from.

Preparation:

- Turn ON the TV and set to the video input mode.
- Press **VCR/DVD** to select the DVD mode. (The DVD indicator will light)

Parental control setting

- 1 Press **SETUP MENU** in the stop mode. Press **◀** or **▶** to select "Operation".

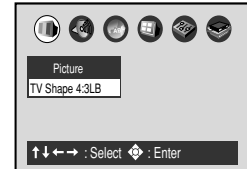

- 2 Press **▲** or **▼** to select "Parental Lock", then press **ENTER**.

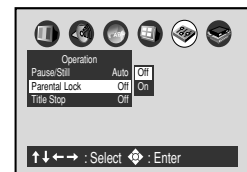

- 3 Press **▲** or **▼** to select Off or On.

Off: The parental lock feature does not function.

After pressing the **ENTER** button, follow step 4 below.

On: To activate the parental lock feature or change the settings.

After pressing the **ENTER** button, follow steps 4-6 below.

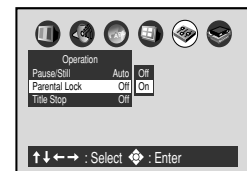

- 4 Press **Number keys** to input a 4-digits password then press the **ENTER** button.

- If you input a wrong number, press **CANCEL**.

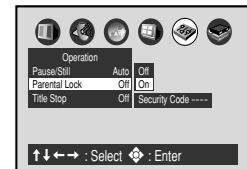

- 5 Enter the code of a country/area whose standards were used to rate the DVD disc. (See the list on the page 44)

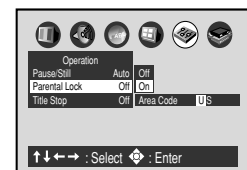



Parental control (Continued)

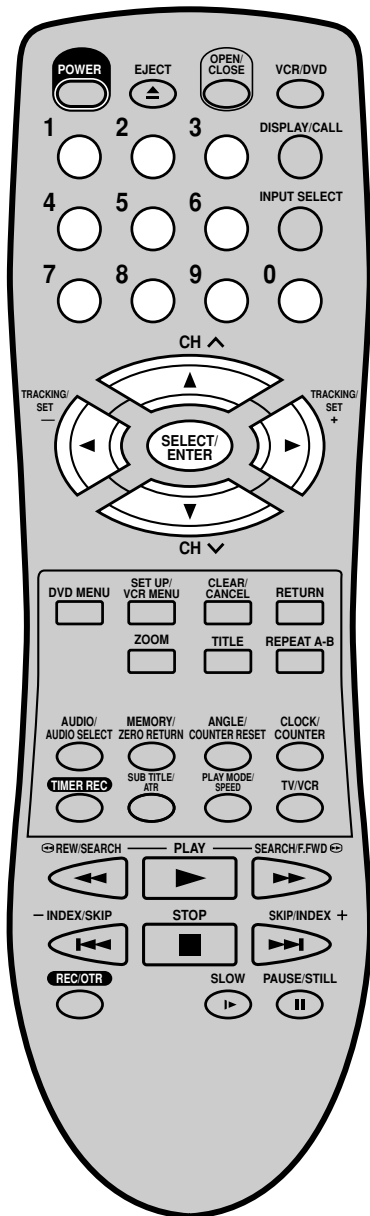

Country/Area	Code	Country/Area	Code
AUSTRALIA	AU	NETHERLANDS	NL
BELGIUM	BE	NORWAY	NO
CANADA	CA	PHILIPPINES	PH
CHINA	CN	RUSSIAN FEDERATION	RU
CHINA HONG KONG	HK	SINGAPORE	SG
DENMARK	DK	SPAIN	ES
FINLAND	FI	SWEDEN	SE
FRANCE	FR	SWITZERLAND	CH
GERMANY	DE	TAIWAN	TW
INDONESIA	ID	THAILAND	TH
ITALY	IT	UNITED KINGDOM	GB
JAPAN	JP	UNITED STATES	US
MALAYSIA	MY		

- Press ▲/▼ to select the first character.
- Press the ◀/▶ to shift and press ▲/▼ to select the second character.
- Press the **ENTER** button.

- Press the ▲/▼ buttons to select the parental lock level, then press the **ENTER** button.

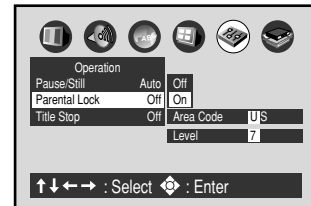

You cannot play DVD discs rated higher than the level you selected unless you cancel the parental lock function. For example, when you select level 7, discs rated higher than level 7 are locked out and cannot be played.

The parental lock level is equivalent to following USA movie ratings.

- Level 7: NC-17
- Level 6: R
- Level 4: PG 13
- Level 3: PG
- Level 1: G

The parental lock levels for other countries/areas than U.S. are included for future use. Check the appropriate parental lock level when you buy a DVD disc equipped with the parental lock feature in the future.

- **To change the parental lock level**
Follow steps 4- 6.

- **To change your 4-digit security code**

- After selecting "On" or "Off" press the STOP button four times, then press the **ENTER** button.
The 4-digit security code is cleared.
- Press the **Number Keys** buttons to create a new 4-digit security code.
- Press the **ENTER** button.





Setting menu language

You can select the language of the disc menu messages of DVDs.

Preparation:

- Turn ON the TV and set to the video input mode.
- Press **VCR/DVD** to select the DVD mode. (The DVD indicator will light)

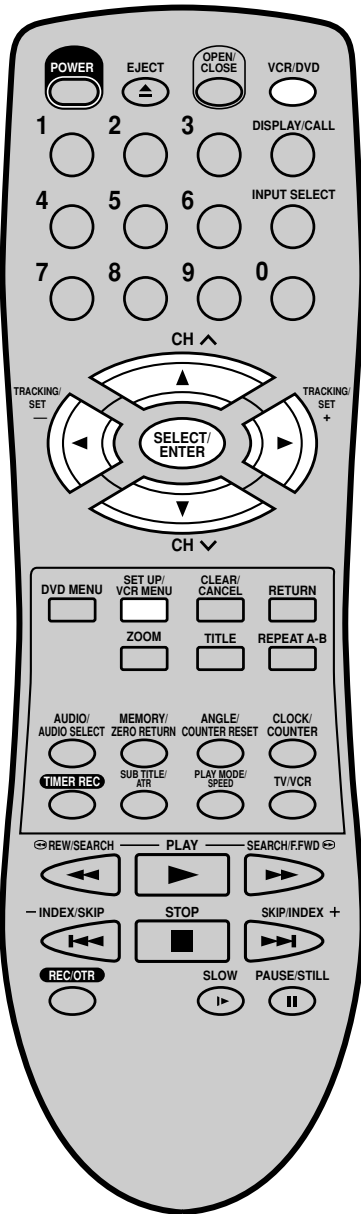

- 1 Press **SET UP** in the stop mode. Press **◀** or **▶** to select "Language".

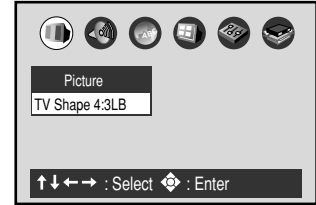

- 2 Press **▲** or **▼** to select "Disc Menu Language".

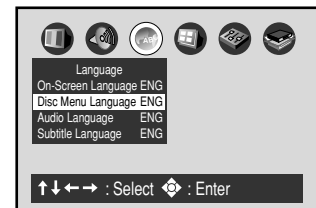

- 3 Press **ENTER**. Press **▲** or **▼** to select your desired language, then press **ENTER**.

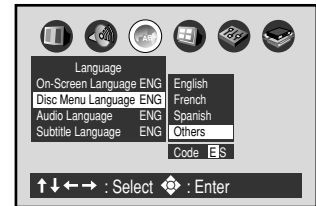

English, French, Spanish

The selected language is the first-priority Menu language.

OTHER: Other language can be selected (See the Table of languages on page 55).

- 4 To make SETUP screen disappear, press **SET UP**.



Setting subtitle language

The same subtitle language can always be selected even if you replace the disc or turn the power off.

Preparation:

- Turn ON the TV and set to the video input mode.
- Press **VCR/DVD** to select the DVD mode. (The DVD indicator will light)

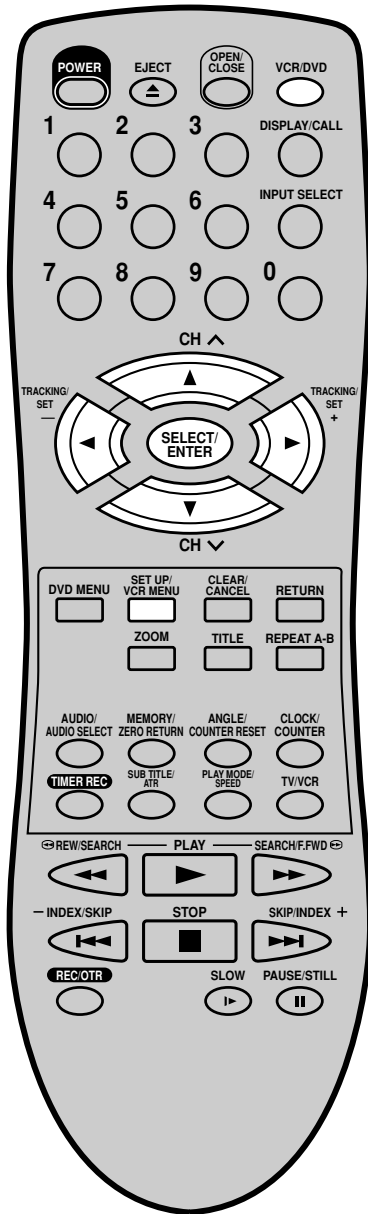

1 Press **SET UP** in the stop mode. Press **◀** or **▶** to select "Language"

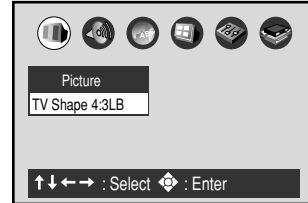

2 Press **▲** or **▼** to select "Subtitle Language".

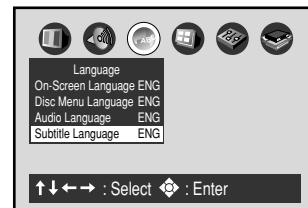

3 Press **ENTER**. Press **▲** or **▼** to select your desired language, then press **ENTER**.

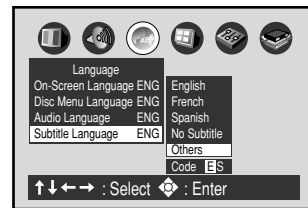

English, French, Spanish

The subtitle is displayed with the selected language if it is recorded on the disc.

OTHER:

If you want to select another language, enter the language code (See the Table of languages on page 55).

No Subtitle:

Subtitles do not appear.

4 To make SETUP screen disappear, press **SET UP**.

NOTES:

- If the selected language is not recorded on the disc, the first-priority language is selected.
- Some DVD discs may be set to display Subtitles in a different language than you selected. A prior subtitle language may be programmed on the disc.





Setting audio soundtrack language

The same audio soundtrack language can always be selected by your unit even if you replace the disc or turn the power off.

Preparation:

- Turn ON the TV and set to the video input mode.
- Press **VCR/DVD** to select the DVD mode. (The DVD indicator will light)

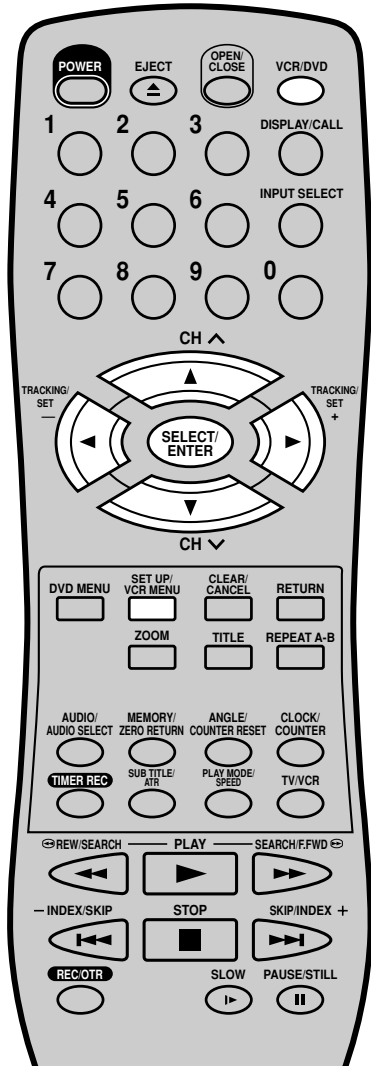

- 1 Press **SET UP** in the stop mode. Press **◀** or **▶** to select "Language"

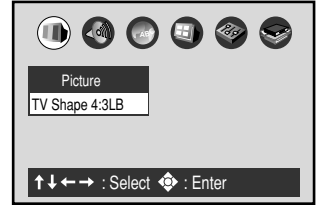

- 2 Press **▲** or **▼** to select "Audio Language".



- 3 Press **ENTER**. Press **▲** or **▼** to select your desired Audio Language, then press **ENTER**.

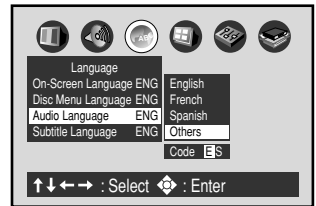

English, French, Spanish

The language you have selected will play if it is recorded on the disc.

OTHER: If you want to select another language, enter the language code (See the Table of languages on page 55).

- 4 To make SETUP screen disappear, press **SET UP**.

NOTES:

- If the selected language is not recorded on the disc, the original language will be heard.
- Some DVD discs may be played in a different language than you selected. A prior language may be programmed on the disc.





Setting the aspect ratio of TV screen

You can select the aspect ratio for your TV.

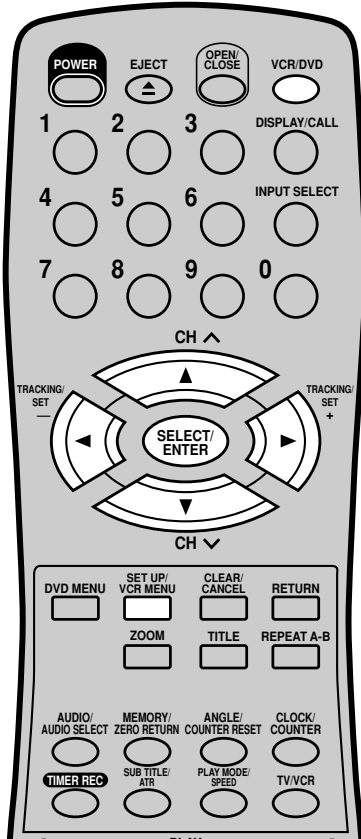

Preparation:

- Turn ON the TV and set to the video input mode.
- Press **VCR/DVD** to select the DVD mode. (The DVD indicator will light)

- 1 Press **SET UP** in the stop mode. Press **◀** or **▶** to select "Picture".

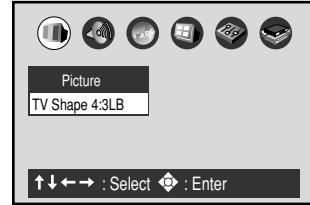

- 2 Press **ENTER**. Press **▲** or **▼** to select your desired screen type, then press **ENTER**.

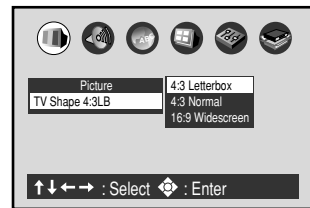

You have the following screen sizes to choose from:

4:3 Letterbox:

Select when a standard 4:3 TV is connected. Displays theatrical images with masking bars above and below the picture.

4:3 Normal:

Select when a standard 4:3 TV is connected. Displays pictures cropped to fill your TV screen. Either or both sides of the picture are cut off.

16:9 Widescreen:

Select this mode when connecting to a wide-screen TV. A wide screen picture is displayed full size.

NOTES:

- The displayable picture size is preset on the DVD video disc. Therefore, the playback picture of some DVD video discs may not conform to the picture size you select.
- When you play DVD video discs recorded in the 4:3 picture size only, the playback picture always appears in the 4:3 picture size regardless of the TV shape setting.
- If you select "16:9 widescreen" and you own a 4:3 TV set, the DVD playback picture will be horizontally distorted during playback. Images will appear to be horizontally compressed. Always be sure that your TV shape conforms to the actual TV in use.





Setting on Screen display

On screen display can be switched on or off when you press the buttons.

Preparation:

- Turn ON the TV and set to the video input mode.
- Press **VCR/DVD** to select the DVD mode. (The DVD indicator will light)

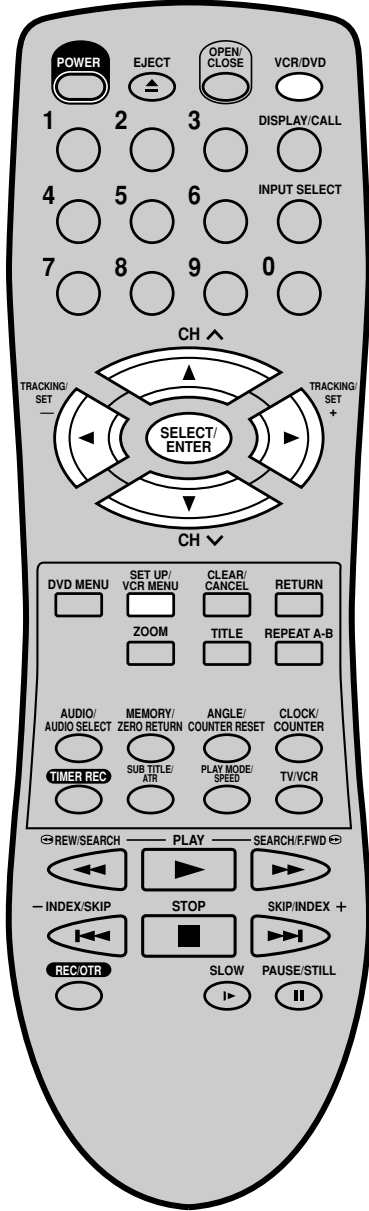

- 1 Press **SET UP** in the stop mode. Press **◀** or **▶** to select "Display"

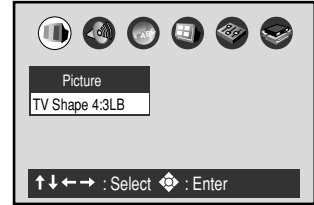

- 2 Press **▲** or **▼** to select "On-Screen Displays".

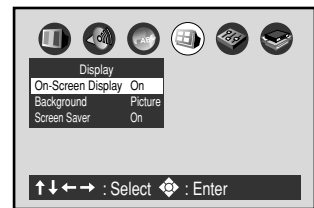

- 3 Press **ENTER**. Press **▲** or **▼** to select "On" or "Off", then press **ENTER**.

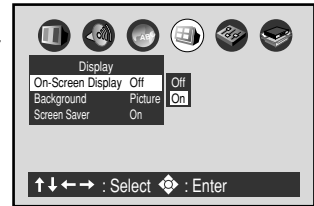

On: Operational modes (e.g. "II", "▶▶") appear when you press the buttons (factory setting).

Off: Operational modes (e.g. "II", "▶▶") do not appear when you press any buttons.

- 4 To make SETUP screen disappear, press **SETUP**.



Setting Audio

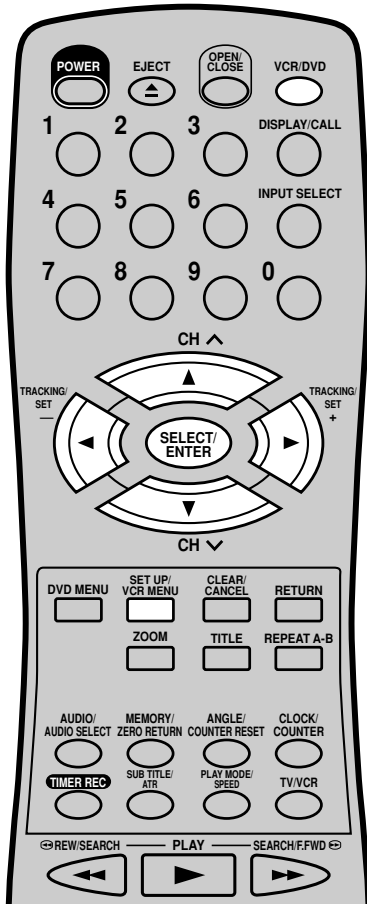

Preparation:

- Turn ON the TV and set to the video input mode.
- Press **VCR/DVD** to select the DVD mode. (The DVD indicator will light)

Audio Out Select

Select the output sound format corresponding to your system connection. For details of sound recording systems, see on page 53.

- 1 Press **SET UP** in the stop mode. Press **◀** or **▶** to select "Audio".
- 2 Press **▲** or **▼** to select "Audio Out Select", then press **ENTER**. Press **▲** or **▼** to select your desired output sound, then press **ENTER**.

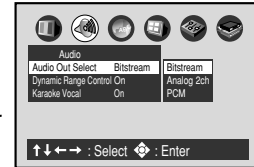

- Bitstream:** Select when connected to an amplifier equipped with a Dolby Digital, DTS, MPEG1 or MPEG2 decoder. The DVD/VCR outputs digital audio information in the bitstream format when you play a DVD video disc recorded on the Dolby Digital, DTS, MPEG1 or MPEG2 recording system.
- Analog 2ch:** Select when connected to a TV, Dolby Pro Logic or stereo system via the analog audio jacks.
- PCM:** Select when connected to a 2 channel digital stereo amplifier. The DVD/VCR outputs sounds in the PCM 2ch format when you play a DVD video disc recorded on the Dolby Digital, MPEG1 or MPEG2 recording system.

- 3 To make SETUP screen disappear, press **SET UP**.

Dynamic Range Control

Turn on or off a function that makes faint sounds easier to hear even if you lower the volume during late hours playback.

- 1 Press **SET UP** in the stop mode. Press **◀** or **▶** to select "Audio".
- 2 Press **▲** or **▼** to select "Dynamic Range Control", then press **ENTER**. Press **▲** or **▼** to select "On" or "Off", then press **ENTER**.

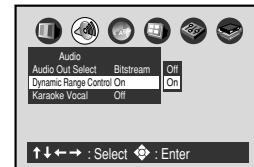

- Off: Full dynamic range is maintained.
- On: Dynamic range is reduced.

- 3 To make SETUP screen disappear, press **SET UP**.

Karaoke Vocal

Turn on or off the vocal output during DVD KARAOKE disc playback.

- 1 Press **SET UP** in the stop mode. Press **◀** or **▶** to select "Audio".
- 2 Press **▲** or **▼** to select "Karaoke Vocal", then press **ENTER**. Press **▲** or **▼** to select "On" or "Off", then press **ENTER**.

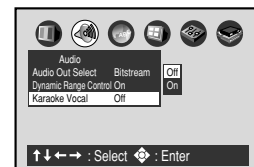

- Off: The primary vocal is not output.
- On: The primary vocal is output when it is recorded on the disc.

- 3 To make SETUP screen disappear, press **SET UP**.

NOTES:

- Dynamic Range Control function works only during playback of Doldy Digital recorded discs.
- The level of Dynamic Range Control may differ depending on the DVD video disc.
- The vocal output feature is used during playback of Dolby Digital (multi-channel) recorded DVD KARAOKE discs. This feature allows you to turn off vocal audio tracks, or restore them for background accompaniment.
- When playing KARAOKE, connect appropriate audio equipment such as amplifier to the DVD video player.





Setting Operation

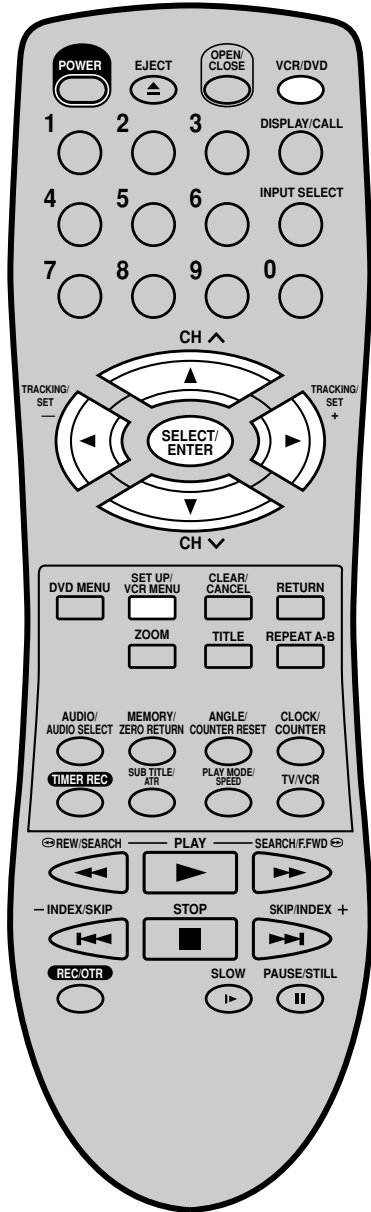

Preparation:

- Turn ON the TV and set to the video input mode.
- Press **VCR/DVD** to select the DVD mode. (The DVD indicator will light)

Pause/Still

Select the resolution of still pictures.

- 1 Press **SET UP** in the stop mode. Press **◀** or **▶** to select "Operation".

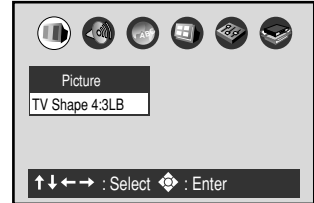

- 2 Press **▲** or **▼** to select "Pause/Still", then press **ENTER**. Press **▲** or **▼** to select "Auto" or "Frame", then press **ENTER**.

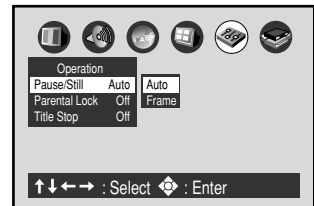

Auto: For normal use. Still and fast motion images can be paused.

Frame: The resolution of still pictures is improved, so that you can make a motionless picture more clearer when you pause it.

- 3 To make SETUP screen disappear, press **SET UP**.

Title Stop

Turn on or off a feature that automatically stops playback after a title has been viewed.

- 1 Press **SET UP** in the stop mode. Press **◀** or **▶** to select "Operation".

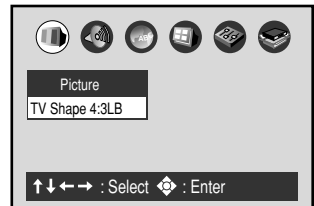

- 2 Press **ENTER**, then press **▲** or **▼** to select "Title Stop", then press **ENTER**. Press **▲** or **▼** to select "On" or "Off", then press **ENTER**.

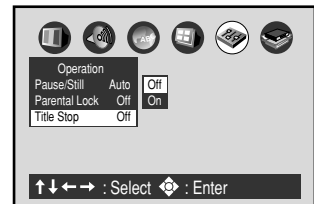

Off: The DVD/VCR continues playback after playback of a title is completed.

On: The DVD/VCR stops after playback of a title is completed.

- 3 To make SETUP screen disappear, press **SET UP**.





Setting Background/Setting Screen Saver

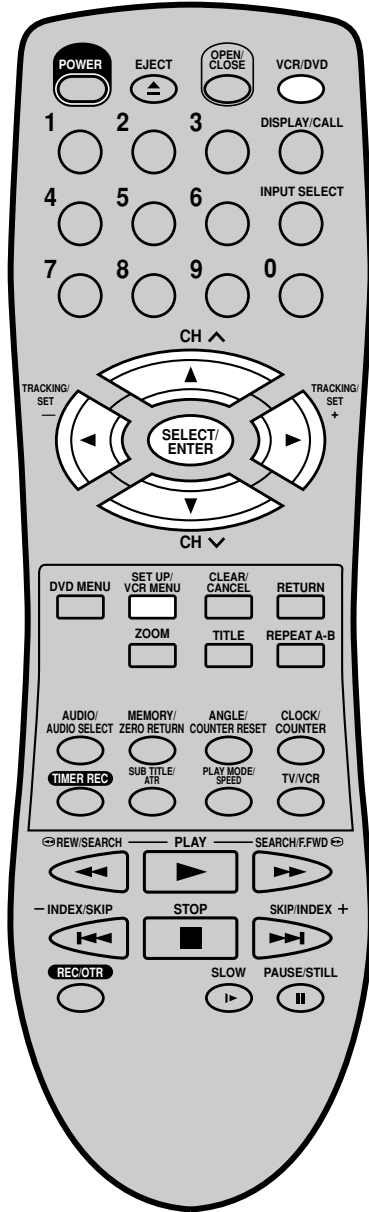

Preparation:

- Turn ON the TV and set to the video input mode.
- Press **VCR/DVD** to select the DVD mode. (The DVD indicator will light)

Setting Background

Select the background color or background picture.

- 1 Press **SET UP** in the stop mode. Press **◀** or **▶** to select "Display".

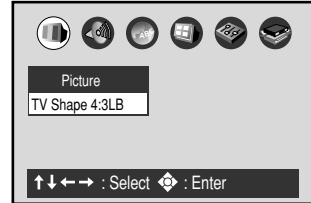

- 2 Press **▲** or **▼** to select "Background", then press **ENTER**. Press **▲** or **▼** to select your desired background, then press **ENTER**.

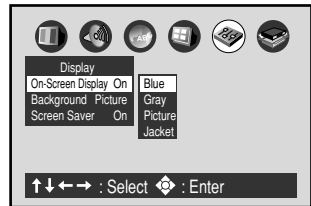

Blue: Blue background.

Gray: Gray background.

Picture: Use the picture which appears when you turn on the DVD/VCR as a background.

Jacket: Use the jacket picture included on some discs as a background. If it is not included, a gray background will be substituted.

- 3 To make SETUP screen disappear, press **SET UP**.

Setting Screen Saver

To turn the screen saver on or off.

- 1 Press **SET UP** in the stop mode. Press **◀** or **▶** to select "Display".

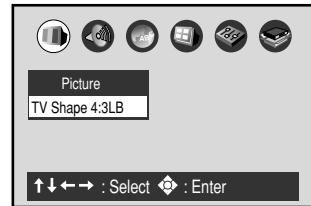

- 2 Press **▲** or **▼** to select "Screen Saver", then press **ENTER**. Press **▲** or **▼** to select "On" or "Off", then press **ENTER**.

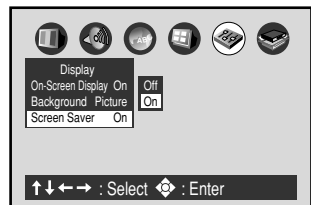

Off: The screen saver is disengaged.

On: The screen saver operates.

- 3 To make SETUP screen disappear, press **SETUP MENU**.





Setting Initial Setup/Output Sound Conversion Table

You can install the initial system setting.

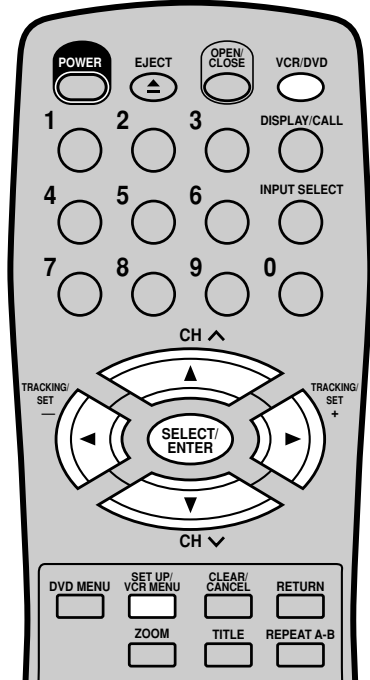

Preparation:

- Turn ON the TV and set to the video input mode.
- Press **VCR/DVD** to select the DVD mode. (The DVD indicator will light)

Setting Initial Setup

- 1 Press **SET UP** in the stop mode. Press **◀** or **▶** to select "Initial Setup".

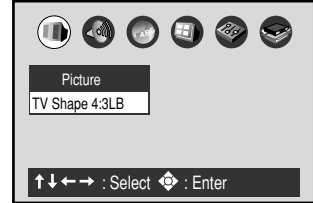

- 2 Press **ENTER**, then press **▲** or **▼** to select "On-Screen Language", "TV Shape" or "Audio Out Select".

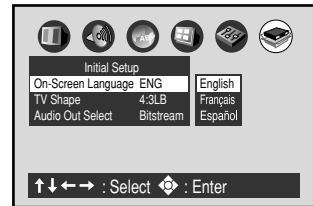

On-Screen Language: See on page 34.
 TV Shape: See on page 37.
 Audio Out Select: See on page 50.

Output sound conversion table (sampling frequency/quantization bit)

You can select the output sound format corresponding to your system connection (see page 50).

Discs	Recording system	Bitstream		Analog 2ch		PCM		
		DIGITAL AUDIO OUT jack	ANALOG AUDIO OUT jack	DIGITAL AUDIO OUT jack	ANALOG AUDIO OUT jack	DIGITAL AUDIO OUT jack	ANALOG AUDIO OUT jack	
DVD video discs	Dolby Digital	Bitstream	48 kHz/20 bit	Bitstream	48 kHz/20 bit	48 kHz/16 bit	48 kHz/20 bit	
	Linear PCM	48 kHz/16 bit	48 kHz/16 bit	48 kHz/16 bit	48 kHz/16 bit	48 kHz/16 bit	48 kHz/16 bit	48 kHz/16 bit
		48 kHz/20 bit	48 kHz/16 bit	48 kHz/20 bit	48 kHz/16 bit	48 kHz/20 bit	48 kHz/16 bit	48 kHz/20 bit
		48 kHz/24 bit	48 kHz/16 bit	48 kHz/24 bit	48 kHz/16 bit	48 kHz/24 bit	48 kHz/16 bit	48 kHz/24 bit
		96 kHz/16 bit	48 kHz/16 bit	48 kHz/16 bit	---	96 kHz/16 bit	48 kHz/16 bit	48 kHz/16 bit
		96 kHz/20 bit	48 kHz/16 bit	48 kHz/20 bit	---	96 kHz/20 bit	48 kHz/16 bit	48 kHz/20 bit
		96 kHz/24 bit	48 kHz/16 bit	48 kHz/24 bit	---	96 kHz/24 bit	48 kHz/16 bit	48 kHz/24 bit
	DTS	Bitstream	---	Bitstream	---	---	---	
MPEG1, MPEG2	Bitstream	48 kHz/16 bit	Bitstream	48 kHz/16 bit	48 kHz/16 bit	48 kHz/16 bit		
Audio CDs	Linear PCM 44.1 kHz/16 bit	44.1 kHz/16 bit	44.1 kHz/16 bit	44.1 kHz/16 bit	44.1 kHz/16 bit	44.1 kHz/16 bit	44.1 kHz/16 bit	
	DTS	Bitstream	(Noise)	Bitstream	(Noise)	Bitstream	(Noise)	

: 3D (N-2-2) sound enhancement can function.





Status display of Disc

You can view Information on operation status and access and setting.

1 Each Press of **DISPLAY**, the status display of the disc will appear on the screen and change as follows.

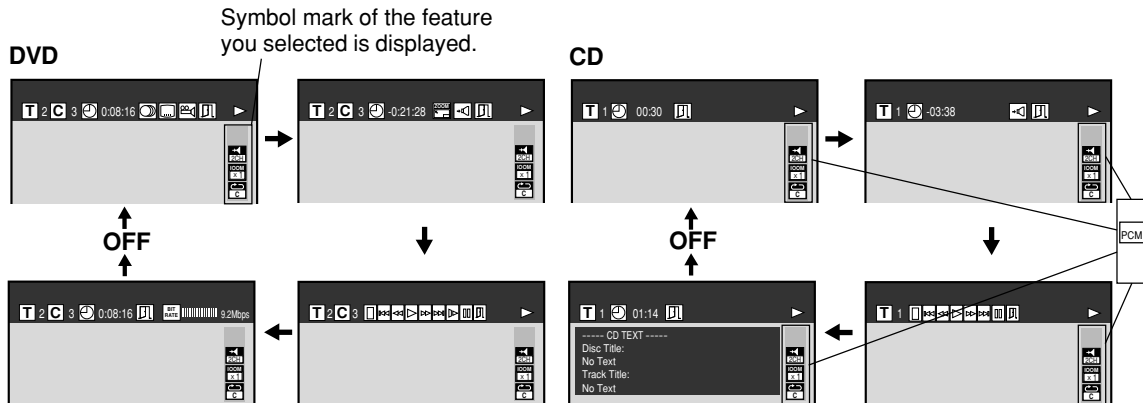

2 Press ◀ or ▶ to select your desired a symbol mark, then press **ENTER**.

You can access the specific feature. **T**, **C** and are no need to press **ENTER**.

T : Title number (Track number)

Press ▲/▼ or Number keys to locate a title or track, then press **PLAY**.

: Elapsed (remaining) time of the current title

Press **Number keys** to locate a desired Location, then press **PLAY**.

: Subtitle setting

See page 41.

: To zoom a picture

See page 37.

: To stop playback

See page 35.

: Fast reverse playback

See Page 36.

: Fast forward playback

See page 36.

: To begin slow motion playback

See page 36.

: To turn off the display

CD TEXT

Displays CD text data if included on the audio CDs. (Some letters may not be displayed properly depending on the disc.)

C : Chapter number

Press ▲/▼ or Number keys to locate a Chapter, then press **PLAY**.

: Audio setting

See page 41.

: Angle setting

See page 42.

: Audio Out Select setting

BST: Bitstream 2CH:Analog 2ch PCM:PCM
See page 50.

: Playback starts from the beginning of the current chapter or track.

See page 36.

: To start playback

See page 35.

: To locate succeeding chapters or tracks.

See page 36.

: To pause playback

See page 36.

Data transfer rate (Mbit/s)
Amount of picture, sound and subtitle data in the DVD video disc transferred per second.

The larger the value is, the more data processed, but this does not necessarily insure better picture quality.





Problems and troubleshooting

Use the following check list for troubleshooting when you have problems with your unit. Consult your local dealer or service outlet if problems persist.

Be sure all connections are properly made when using with other units.

SYMPTOMS	POSSIBLE SOLUTIONS	PAGE
DVD/VCR		
DVD/VCR does not operate.	<ul style="list-style-type: none"> • Make sure the power cord is plugged in. • Try another AC outlet. • Power is off, check fuse or circuit breaker. • Unplug unit, then plug it back in. • Select the DVD or VCR mode before operating. 	5 – – 5 18,34
No picture.	<ul style="list-style-type: none"> • Antenna connection is not correct or antenna cable is disconnected. • The video channel is not in the correct position or the TV is not set to the video channel 3 or 4. • Check the unit is connected correctly. • The video input selector of the TV is not set to VIDEO. Set to VIDEO (or equivalent). • Channel is set to the external mode. 	12~15 18 12~17 – –
No sound.	<ul style="list-style-type: none"> • Check the unit is connected correctly. • Check the input selector of the amplifier is set properly. • The unit is in the Special playback mode. 	12~17 – 24,36
The remote control does not function.	<ul style="list-style-type: none"> • Aim at the remote control at the remote sensor. • Operate within Approx. 5 Meters or reduce the light in the room. • Clear the path of the beam. • The batteries are weak. Replace the batteries. • Check the batteries are inserted correctly. • Check the frequency code is set correctly. 	11
No CATV reception	<ul style="list-style-type: none"> • Check all CATV connections. • Station or CATV system problems, try another station. 	14,15
VCR		
TV recording does not work.	<ul style="list-style-type: none"> • The erase prevention tab of the video cassette is broken off. • The unit is in the external input mode. 	22,26
Timer recording does not work.	<ul style="list-style-type: none"> • The time is not set correctly. • The recording start/end time is not set correctly. • The TIMER has not been pressed (⏸ is not lit). 	19 29 29
Noise bars on screen.	<ul style="list-style-type: none"> • Tracking adjustment beyond range of automatic tracking circuit. Try Manual tracking adjustment. • Video heads are dirty. • The tape is worn or damaged. 	24 53 –
DVD		
Display is not shown in your language.	<ul style="list-style-type: none"> • Select proper language in the menu options. 	34
Playback doesn't start.	<ul style="list-style-type: none"> • No disc is inserted. • The disc may be dirty. Clean up the disc. • The unit cannot play DVD-ROMs, etc. 	35 33 33
Stopping playback, search, slow-motion play, repeat play, or program play, etc. cannot be performed.	<ul style="list-style-type: none"> • Some discs may not do some of the functions. 	–





Problems and troubleshooting / Video head cleaning

SYMPTOMS	POSSIBLE SOLUTIONS	PAGE
No 4:3 (16:9) picture	• The setup does not match your TV.	48
No on-screen display	• Select Display On.	49
No surround sound	• The setup does not match your stereo system.	17
The unit or remote operation key is not functioning.	• Turn off the unit and unplug the AC power cord for several minutes, then replug it.	–
Playback does not start when the title is selected.	• Check the Parental setup.	43
Audio soundtrack and/or subtitle language is not changed when you play back a DVD.	• Multilingual language is not recorded on the DVD disc.	46,47
No subtitle	• Some discs have no subtitles. • Subtitles are cleared. Press SUB TITLE.	46
Angle cannot be changed.	• Multi-angles are not recorded on the DVD disc.	42
✎ appears on the screen.	• The function is prohibited with the unit or the disc.	–

Video head cleaning

Video head clogging

The video heads are the means by which the DVD/VCR reads the picture from the tape during playback. In the unlikely event that the heads become dirty enough to be clogged, no picture will be played back. This can easily be determined if, during playback of a known good tape, there is good sound, but no picture (picture is extremely snowy). If this is the case, have the DVD/VCR checked by qualified service personnel.



Good Picture

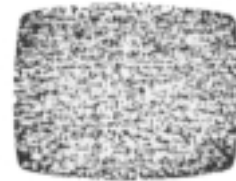

Snowy Picture

NOTES: • DO NOT ATTEMPT TO CLEAN THE VIDEO HEADS OR SERVICE THE UNIT BY REMOVING THE REAR COVER.

- Video heads may eventually wear out and should be replaced when they fail to produce clear pictures.
- To help prevent video head clogging, use only good quality VHS tapes. Discard worn out tapes.



FOR CUSTOMER SERVICE,
ADDITIONAL SET-UP OR
OPERATING ASSISTANCE
PLEASE CALL:

1-800-289-0980

TO ORDER ACCESSORY
PARTS OR LITERATURE

PLEASE CALL:

1-800-369-0304

OR WRITE TO:
ORION SALES, INC.
3471 N. UNION DR.
OLNEY, ILLINOIS 62450

FOR INFORMATION ON OUR OTHER PRODUCTS, PLEASE VISIT OUR WEBSITE AT
www.orionsalesinc.com





Specifications

GENERAL

Power supply: AC 120V 60Hz
 Power consumption: Operation: 20W
 Stand by: 3W
 Weight: 9.9lbs (4.5 kg)
 Dimensions: Width : 16-15/16 inches (430 mm)
 Height: 3-7/8 inches (99 mm)
 Depth : 12-3/8 inches (314.5 mm)

Inputs/Outputs:
 Video: In: 1Vp-p/75 ohm
 Out: 1Vp-p/75 ohm
 Audio: In: -8dBm/50K ohm
 Out: -8dBm/1K ohm
 Antenna: UHF/VHF IN/OUT: 75 ohm coaxial
 Hi-Fi Frequency Response: 20Hz to 20,000Hz
 Hi-Fi Dynamic Range: More than 90dB

VCR section

Video Head: 4 Rotary Heads
 Audio Track: Hi-Fi Sound - 2 Tracks / MONO Sound - 1 Track
 Tuner: 181 Channel Freq. Synthesized
 VHF 2-13
 UHF 14-69
 CATV 14-36 (A)-(W)
 37-59 (AA)-(WW)
 60-85 (AAA)-(ZZZ)
 86-94 (86)-(94)
 95-99 (A-5)-(A-1)
 100-125 (100)-(125)
 01 (5A)

RF Channel Output: Channel 3 or 4, Switchable
 F.FWD/REW Time: Approx. 1minutes and 48 seconds (with T-120 Cassette Tape)

DVD section

Signal system: NTSC
 Applicable disc: DVD (12cm, 8cm), CD (12cm, 8cm)
 Audio characteristics: DVD: 4Hz - 22KHz
 CD: 4Hz - 20KHz
 Frequency response: 90dB
 S/N Ratio: 0.01%
 Harmonic distortion: Below Measurable Level
 Wow and flutter: 90dB
 Dynamic range: 90dB
 Output: Video : (RCA) 1 Vp-p/75ohm
 Audio : (RCA) -8 dBm/1Kohm
 Digital Audio : 0.5Vp-p/75 ohm

Pickup: CD : Wavelength: 775 - 805 nm
 Maximum output power: 0.5 mW
 DVD : Wavelength: 640 - 660 nm
 Maximum output power: 1.0 mW

ACCESSORIES:

Remote control x 1
 75 ohm Coaxial Cable x 1
 AUDIO/VIDEO Cable x 1



SANSUI *limited* **WARRANTY**

DVD PLAYER / VIDEO CASSETTE RECORDER COMBINATION UNIT

ORION warrants this product to be free from manufacturing defects in material and workmanship under normal use and conditions for a period of ninety (90) days from date of original purchase in the United States only.

Should service be necessary under this warranty for any reason due to a manufacturing defect or malfunction during the first ninety (90) day period from date of original purchase, ORION will provide carry-in repair service at an ORION authorized Independent Service Center at no charge. In addition, for a period of up to six (6) months from date of original purchase for video heads and twelve (12) months from date of original purchase for other component parts, if an original part fails due to a manufacturing defect in material or workmanship we will replace the defective part only (EXCLUDING LABOR AFTER INITIAL NINETY (90) DAY WARRANTY PERIOD) provided the defect or malfunction is verified along with dated proof of purchase.

There are ORION Independent Service Centers located throughout the country. For the one nearest you, DIAL TOLL FREE: 1-800-289-0980 or visit our website at www.orionsalesinc.com. This product is eligible for CARRY-IN service only. ORION will not be liable for damages incurred during shipment of the unit. If there are no ORION authorized Independent Service Centers in your area please call – 1-888-296-7466 for assistance.

Note: This warranty is void if the product is:

- (a) Damaged through negligence, misuse, or accident.
- (b) Used in a commercial application or rentals.
- (c) Modified or repaired by anyone other than an Independent Service Center authorized by ORION to effect warranty repairs to the class of product or by the ORION Factory Service Center.
- (d) Damaged because it is improperly connected to the equipment of other manufacturers.

This warranty does not cover:

- a) Damage to tape cartridge.
- b) Cleaning of video heads.
- c) Damage to DVD and CD discs.
- d) Damage to equipment not properly connected to the product.
- e) Costs incurred in the shipping of the product to an ORION authorized Independent Service Center or ORION Factory Service Center.
- f) Damage or improper operation of unit caused by customer abuse, misuse, negligence, or failure to follow operating instructions provided with the product.
- g) Ordinary adjustments to the product, which can be performed by customer as outlined in the owner's manual.

THIS WARRANTY IS NON-TRANSFERABLE AND APPLIES ONLY TO THE ORIGINAL PURCHASER AND DOES NOT EXTEND TO SUBSEQUENT OWNERS OF THE PRODUCT. ANY APPLICABLE IMPLIED WARRANTIES, INCLUDING THE WARRANTY OF MERCHANTABILITY, ARE LIMITED IN DURATION TO A PERIOD OF THE EXPRESS WARRANTY AS PROVIDED HEREIN BEGINNING WITH THE DATE OF ORIGINAL PURCHASE AT RETAIL AND NO WARRANTIES, WHETHER EXPRESS OR IMPLIED SHALL APPLY TO THIS PRODUCT THEREAFTER. ORION MAKES NO WARRANTY AS TO THE FITNESS OF THE PRODUCT FOR ANY PARTICULAR PURPOSE AND USE.

UNDER NO CIRCUMSTANCES SHALL ORION BE LIABLE FOR ANY LOSS, DIRECT, INDIRECT, INCIDENTAL, SPECIAL, OR CONSEQUENTIAL DAMAGE ARISING OUT OF OR IN CONNECTION WITH THE USE OF THIS PRODUCT.

THIS WARRANTY IS VALID ONLY IN THE UNITED STATES OF AMERICA. THIS WARRANTY GIVES YOU SPECIFIC LEGAL RIGHTS, HOWEVER, YOU MAY HAVE OTHER RIGHTS WHICH MAY VARY FROM STATE TO STATE. SOME STATES DO NOT ALLOW LIMITATION ON IMPLIED WARRANTIES OR EXCLUSION OF CONSEQUENTIAL DAMAGE; THEREFORE, THESE RESTRICTIONS MAY NOT APPLY TO YOU.

ORION SALES, INC.
3471 N. UNION DR.
OLNEY, ILLINOIS 62450



2A70101A 
02/01

Printed in Thailand

