

Timer recording

Timer recording can be programmed on-screen with the remote control. The built-in timer allows automatic unattended recording of up to 8 programs within 1 month.

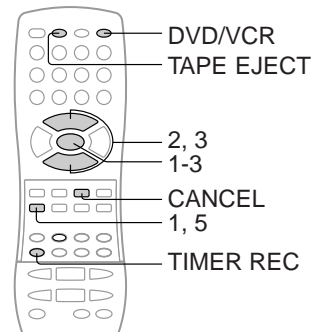

Timer recording

Preparation:

- Press **DVD/VCR** to select the VCR mode.
- Load a cassette tape with the erase prevention tab intact.
- Check the time and date are correct [24].

Example: Program a timer recording for the 26th day, channel 125 (CATV), 11:00 - 11:30 PM on timer program number 1 (Tape speed: SLP).

1 Press **VCR MENU**. Select "TIMER REC SET", then press **ENTER**.

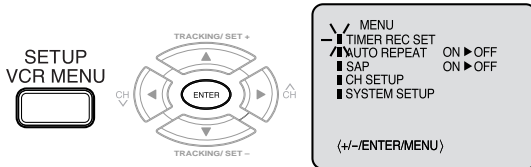

2 Press **SET +** or **-** to select one of the program line, then press **ENTER**.

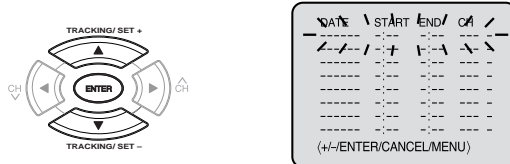

3 Press **SET +** or **-** to select the date, then press **ENTER**.

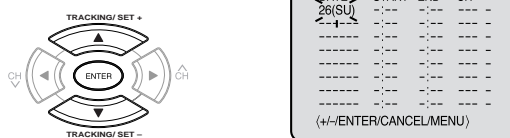

4 Set the start time, end time, channel and tape speed as in step 3.

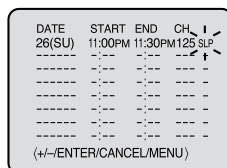

Notes:

- Press **CANCEL** to move cursor backward for correction.
- To record from external source set the channel to "L1" or "L2". "L1" or "L2" will appear next to CH 125 (or 69).

5 To enter other programs, repeat step 2 through 4.



- To return to the normal screen, press **VCR MENU** twice.

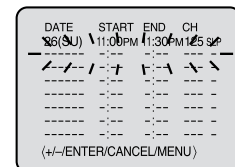

6 Press **TIMER REC**. The timer symbol (⏺) will appear on the display and the VCR stands by for recording.



At the same time, VCR mode will change to DVD mode automatically. You can use DVD even if the VCR is in the timer recording mode. If you do not use the DVD, turn the power off.

Notes:

- The timer recording will start at 5 seconds before the time you predetermined.
- If the timer symbol (⏺) does not appear on the display in spite of the pressing of **TIMER REC**, the cassette may not have been loaded. [29]
- If the cassette is ejected in spite of the pressing of **TIMER REC**, the erase prevention tab of the cassette may have been removed. [29]

Notes:

- If the timer symbol (⏺) blinks when the timer recording ended, the TV program has not been completely recorded because of an insufficient tape length. Press **TIMER REC** to cancel the timer program or press **TAPE EJECT** to remove the cassette tape.
- During timer recording standby mode, the VCR mode cannot be operated. To use the VCR, press **TIMER REC** at first, then press **DVD/VCR** to change to VCR mode. After you use the VCR, press **TIMER REC** again to put the VCR into timer recording standby mode.
- If you press **TIMER REC** during timer recording, the recording operation will be interrupted. If you press **TIMER REC** again within the programmed time, the recording operation will start again.
- After a power failure or disconnection of the power plug, all programmed recording settings and time display will be lost upon resumption of power. In this case, reset the clock [24] and reprogram any timer recording.

Recording (VCR)

Timer recording (continued)

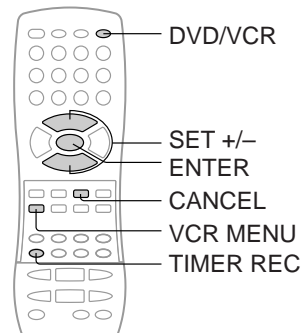

To set daily/weekly timer

Weekly (e.g. WKL-TU: each Tuesday) or daily (e.g. MO-SA: Monday to Saturday) Timer recording

Follow the procedure of timer recording on the previous page. At step 3 press **SET +** or **-** repeatedly until the desired setting appears. Then press **ENTER**.

When you press **SET -** repeatedly, the DATE indicator will change as follows, in this case the day is Friday.

The current day (Friday) → SU-SA (Sunday to Saturday)

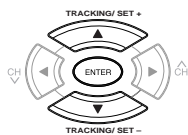
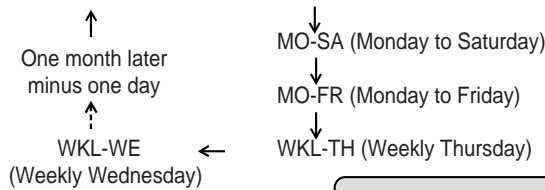

DATE	START	END	CH
WKL-WE	---	---	---
---	---	---	---
---	---	---	---
---	---	---	---
---	---	---	---
---	---	---	---
---	---	---	---
---	---	---	---

(+/-)ENTER/CANCEL/MENU

To confirm or cancel a program

1 If the Timer has been activated, press **TIMER REC** to deactivate the Timer.

The timer symbol (⏰) will disappear. Then press **DVD/VCR** to change to VCR mode.



2 To confirm Timer program:

At step 1 on the previous page select "TIMER REC SET" and press **ENTER**. The timer program list will appear on the screen.

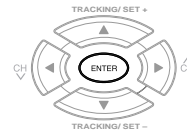

DATE	START	END	CH
26(SU)	11:00PM	11:30PM	125SLP
---	---	---	---
---	---	---	---
---	---	---	---
---	---	---	---
---	---	---	---
---	---	---	---
---	---	---	---

(+/-)ENTER/CANCEL/MENU

If the programs overlap another

Do not overlap timer programs as portions of the conflicting programs will be lost. The first recording time has priority over the next recording time as shown in the diagram below.

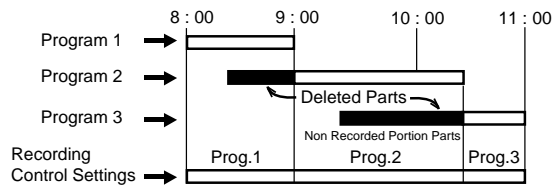

Notes:

- The daily/weekly recording can be made continuously until the recording is canceled or the tape reaches the end.
- During timer recording the automatic rewinding mechanism does not function.

3 To cancel Timer program:

Press **SET +** or **-** to select the unwanted program, then press **CANCEL** to cancel the program.

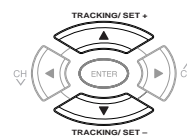

DATE	START	END	CH
---	---	---	---
---	---	---	---
---	---	---	---
---	---	---	---
---	---	---	---
---	---	---	---
---	---	---	---
---	---	---	---

(+/-)ENTER/CANCEL/MENU

4 Press **VCR MENU** repeatedly until the menu screen is cleared.



Notes:

- If there are other timer record programs remaining, **TIMER REC** must be pressed to reactivate the timer, otherwise the remaining timer record programs will be ignored.
- You cannot confirm the Timer program during timer recording operation.
- You can correct or cancel a programmed setting in program confirm mode.



Stereo recording and playback / Separate Audio Program (SAP)

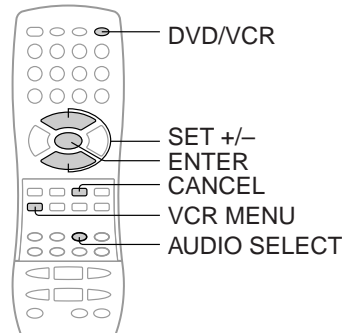

Stereo recording and playback

The VHS Hi-Fi audio system permits high fidelity recording of MTS STEREO TV broadcasts.

When a MTS STEREO broadcast is received, "STEREO" will appear on the screen for about 4 seconds and the program can be viewed or recorded in stereo. The Hi-Fi stereo recording procedure is the same as for normal recordings.

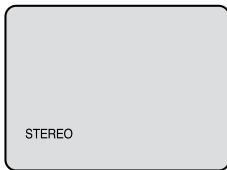

Note:

When using a CATV system, stereo TV programs may be transmitted over a mono cable channel. In this case "STEREO" will not appear and the sound will be in mono.



Output selection

When viewing an MTS stereo TV program, or playing a prerecorded VHS Hi-Fi stereo videotape, press **AUDIO SELECT** to select how the audio will be heard through the speakers. Normally set to the Hi-Fi stereo position, this button can be set to the MONO position if the stereo broadcast or videotape audio is of poor quality. The "R" and "L" positions allow the audio from the Right or Left Hi-Fi channel to be heard over both TV speakers. This button has no effect when viewing a MONO videotape or TV program. Each time when you press the button, OUTPUT SELECTION display appears on the screen for several seconds. Refer to the chart below.

OUTPUT SELECTION	SOUND HEARD ON BOTH SPEAKERS
STEREO	STEREO
L CH	LEFT CHANNEL AUDIO
R CH	RIGHT CHANNEL AUDIO
MONO	MONO

Separate Audio Program (SAP)

Your DVD/VCR is fitted with a SAP broadcast system which enables you to switch to a separate audio program when viewing a selected channel.

This function applies only when the program is broadcast in multi-languages through the SAP broadcast system.

1 Press VCR MENU. Then press SET + or - to select "SAP".

The diagram shows the remote control with the VCR MENU button highlighted. An arrow points to the SET +/- button. A second diagram shows the remote with the TRACKING/SET +/- buttons highlighted, with an arrow pointing to the SET +/- button. A third diagram shows the on-screen menu with the SAP option highlighted.

```

MENU
  [ ] TIMER REC SET   ON > OFF
  [ ] AUTO REPEAT   ON > OFF
  [ ] SAP             ON > OFF
  [ ] CH SETUP      ON > OFF
  [ ] SYSTEM SETUP
  (+/-)/ENTER/MENU
  
```

2 Press ENTER to select "ON".
Then press **VCR MENU** until the menu screen is cleared.

The diagram shows the remote control with the TRACKING/SET +/- buttons highlighted, with an arrow pointing to the ENTER button. A second diagram shows the remote with the VCR MENU button highlighted. A third diagram shows the on-screen menu with the SAP option selected (ON > OFF).

```

MENU
  [ ] TIMER REC SET   ON > OFF
  [ ] AUTO REPEAT   ON > OFF
  [ ] SAP             ON > OFF
  [ ] CH SETUP      ON > OFF
  [ ] SYSTEM SETUP
  (+/-)/ENTER/MENU
  
```

Listening to SAP

When the VCR is turned on or a channel selection is made, make certain the letters "SAP" appears on the screen for about 4 seconds. This means that the "Separate Audio Program" broadcasting is available.

The diagram shows two possible screen displays: "STEREO SAP" and "SAP".

Notes:

- When playing back a tape that is not recorded in Hi-Fi stereo mode, the audio will automatically be monaural.
- When listening to a VHS Hi-Fi video tape or MTS broadcast through the VHF/UHF jack (Audio/Video cable not connected), the sound will be monaural.

Other functions (VCR)



Duplicating a video tape

If you connect the DVD/VCR to another VCR or Camcorder, you can duplicate a previously recorded tape. Make all connections before turning on the power.

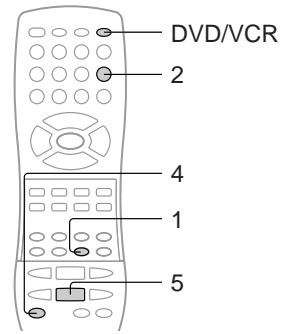

Duplicating a video tape

Preparation:

- Turn ON the TV and select the corresponding video input.
- Press **DVD/VCR** to select the VCR mode. (The VCR indicator will light.)
- Load a cassette tape with the erase prevention tab intact.
- Load a previously recorded tape into the playback VCR or Camcorder.

1 Press SP/SLP to select the desired tape speed SP or SLP.



It is recommended that you set the tape speed to the SP mode on the recording VCR for best results.

2 Press INPUT SELECT once or twice to select AUDIO/VIDEO input position.

"L1" or "L2" will appear in the display.

INPUT SELECT



L1: on the rear panel
L2: on the front panel

3 Press PLAY on the playback VCR or Camcorder.

4 Press REC on the recording VCR.

The duplicating process begins.



5 Press STOP after duplicating a video tape.

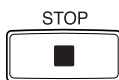

Connection with second VCR

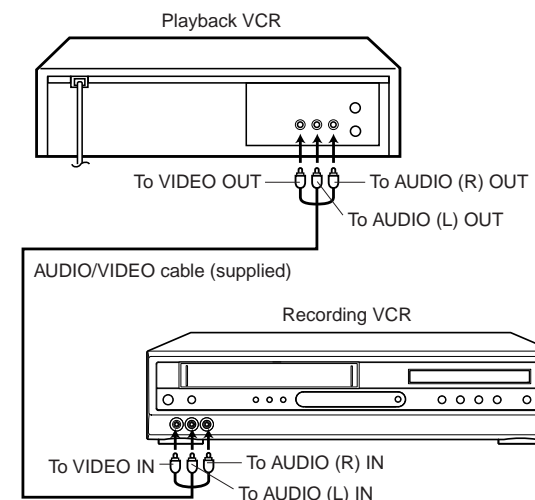

Connection with Camcorder

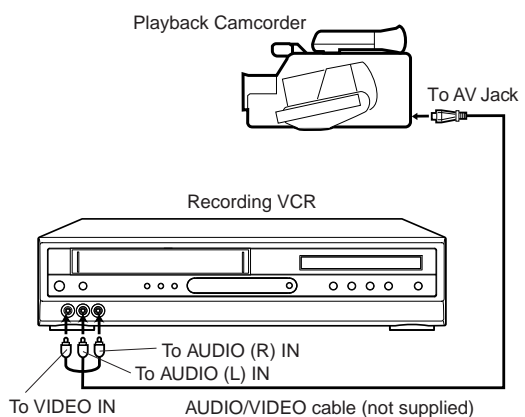

For duplicating a previously recorded tape from a camcorder, follow the camcorder manufacturer's instructions. A typical camcorder dubbing hookup is shown above.



Recording a DVD/CD disc

You can record disc material in DVD, Audio CD, etc. onto a Video tape with this DVD/VCR.

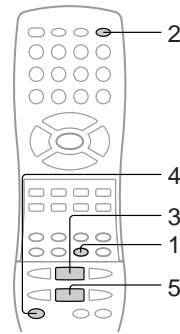

Duplicating a DVD or CD disc

Preparation:

- Turn ON the TV and select the corresponding video input.
- Press **DVD/VCR** to select the VCR mode. (The VCR indicator will light.)
- Load a cassette tape with the erase prevention tab intact.
- Load a DVD/CD disc.

Notes:

- You may not be able to record the beginning of the disc. Begin VCR recording once program playback commences on the DVD.
- You can not record discs encoded with copy guard function. The following icon and text will show up on the TV screen.



DISC IS COPY PROTECTED

1 Press SP/SLP to select the desired tape speed SP or SLP.

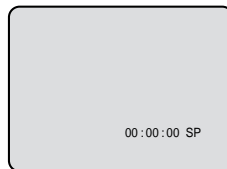

2 Press DVD/VCR to select the DVD mode. The DVD indicator will light.



3 Press PLAY to start playback.



4 Press REC to start recording.

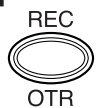

The DVD/VCR will change to the VCR mode automatically and the playback picture or sound will be duplicated on the video cassette tape.

5 Press STOP if you finish recording.

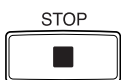

If you wish to stop a DVD/CD disc, press **DVD/VCR** to change the DVD mode, then press **STOP**.

Playing a disc

This section shows you the basics on how to play a disc.

CAUTION

Keep your fingers well clear of the disc tray as it is closing. Neglecting to do so may cause serious personal injury.

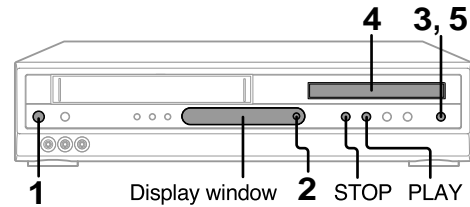

Basic playback

Preparations:

- When you want to view a disc, turn on the TV and select the corresponding video input connected to the DVD/VCR. This may include S-video or component video inputs which are exclusive to DVD playback.
- When you want to enjoy the sound of discs from the audio system, turn on the audio system and select the input connected to the DVD/VCR.

1 Press ON/STANDBY (I / ⏻).
 ON/STANDBY I / ⏻ The DVD/VCR turns on.

2 Press DVD/VCR to select the DVD mode.
 VCR/DVD SELECT The DVD indicator will light.

3 Press OPEN/CLOSE.
 OPEN/CLOSE ▲ The disc tray opens.

4 Place the disc on the disc tray.
 With the playback side down

- There are two different disc sizes. Place the disc in the correct guide on the disc tray. If the disc is out of the guide, it may damage the disc and cause the DVD/VCR to malfunction.
- Do not place a disc which is unplayable in this DVD/VCR.

5 Press OPEN/CLOSE or PLAY on the unit.
 OPEN/CLOSE ▲ OR ▶ The disc tray closes automatically. On the TV-screen, ▲ changes to "Reading" and then playback commences.

- A menu screen will appear on the TV screen, if the disc has a menu feature.

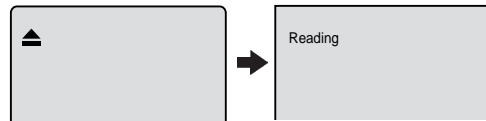

6 Press ▲/▼ or ◀/▶ to select title.

7 Press ENTER.
 • Title is selected and play commences.

8 Press STOP to end playback.
 STOP ■

- The unit records the stopped point, depending on the disc. "■" appears on the screen. Press **PLAY** to resume playback (from the scene point).
- If you press **STOP** again or unload the disc ("■" appears on the screen.), the unit will clear the stopped point.

■ To start playback in the stop mode
 Press **PLAY**.



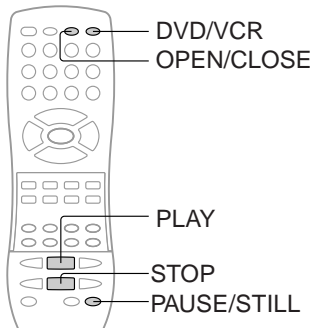

■ To obtain a higher quality picture

Occasionally, some picture noise not usually visible during a normal broadcast may appear on the TV screen while playing a DVD video disc because the high resolution pictures on these discs include a lot of information. While the amount of noise depends on the TV you use with this DVD/VCR, you should generally reduce the sharpness adjustment on your TV when viewing DVD video discs.

■ About

The icons on the heading bar show the playable discs for the function described under that heading.

: You can use this function with DVD video discs.

: You can use this function with VIDEO CDs.

: You can use this function with audio CDs and CD-R/RW CDs.

■ To pause playback (still mode)

Press **PAUSE/STILL** during playback.

PAUSE/STILL



To resume normal playback, press the **PLAY** button.

- The sound is muted during still mode.

■ To stop playback

Press **STOP**.

STOP



■ To remove the disc

Press **OPEN/CLOSE**.

OPEN/
CLOSE



Remove the disc after the disc tray opens completely.

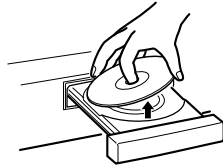

Be sure to press the **OPEN/CLOSE** button to close the disc tray after you remove the disc.

Notes:

- If a non-compatible disc is loaded, "Incorrect Disc", "Region Code Error" or "Parental Error" will appear on the TV screen according to the type of loaded disc. In this case, check your disc again (See pages 8 and 60).
- Some discs may take a minute or so to start playback.
- When you set a single-faced disc label downwards (ie. the wrong way up) and press the **OPEN/CLOSE** button or the **PLAY** button on the unit, "Reading" will appear on the display for 40 seconds and then "Incorrect Disc" will continue to be displayed.
- Some playback operations of DVDs may be intentionally fixed by software producers. Since this unit plays DVDs according to the disc contents the software producers designed, some playback features may not be available. Also refer to the instructions supplied with the DVDs.
- When playing DTS-encoded Audio CDs, excessive noise will be heard from the analogue stereo outputs. To avoid possible damage to the audio system, the consumer should take proper precautions when the analogue stereo outputs of the DVD player are connected to an amplification system.
- Do not move the DVD/VCR during playback. Doing so may damage the disc.
- Use the **OPEN/CLOSE** button to open and close the disc tray. Do not push the disc tray while it is moving. Doing so may cause the DVD/VCR to malfunction.
- Do not push up on the disc tray or put any objects other than discs on the disc tray. Doing so may cause the DVD/VCR to malfunction.
- In many instances, a menu screen will appear after playback of a movie is completed. Prolonged display of an on-screen menu may damage your television set, permanently etching that image onto its screen. To avoid this, be sure to press the **STOP** button on your remote control once the movie is completed.
- During the DVD playback if you change the operating mode from DVD to VCR, the DVD will continue to play back the disc and stop after about 5 minutes.
- There may be a slight delay between you pressing the button and the function activating.





Basic playback (DVD)

Playing a disc (continued)

You can play discs at various speeds.

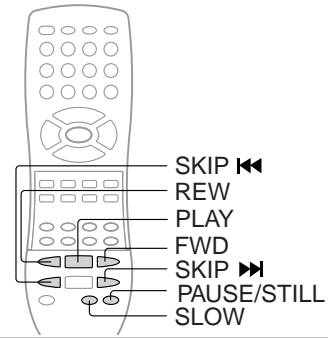

DVD VCD CD Playing in fast reverse or fast forward directions

Press REW or FWD during playback.



REW: Fast reverse playback
FWD: Fast forward playback

Each time you press the REW or FWD button, the playback speed changes.

■ To resume normal playback

Press **PLAY**.



Notes:

- The DVD/VCR mutes sound and subtitles during reverse and forward scan of DVD video discs. However, the DVD/VCR plays sound during fast forward or fast reverse play of audio CDs.
- The playback speed may differ depending on the disc.

DVD VCD Playing frame by frame

Press PAUSE/STILL during still playback.



Each time you press the PAUSE/STILL button, the picture advances one frame.

■ To resume normal playback

Press **PLAY**.



Note:

- The sound is muted during frame by frame playback.

DVD VCD Playing in slow-motion

Press SLOW during playback.



Each time you press the SLOW button, the slow-motion speed changes.

■ To resume normal playback

Press **PLAY**.



Note:

- The sound is muted during slow-motion playback.

DVD VCD CD Locating a chapter or track

Press SKIP (▶▶) Forward or SKIP (◀◀) Reverse during playback to locate a chapter that you want to watch.



Each time you press the button, a chapter or track is skipped.

Notes:

- A "Prohibition" symbol  may appear at the upper left of the screen. This symbol means either the feature you tried is not available on the disc, or the DVD/VCR can not access the feature at this time. This does not indicate a problem with the DVD/VCR.
- The unit is capable of holding a still video image or On screen display image on your television screen indefinitely. If you leave the still video image or On screen display image displayed on your TV for an extended period of time, you risk permanent damage to your television screen. Projection televisions are very susceptible.



MP3/WMA/JPEG playback

This player can play back the MP3/WMA/JPEG-data which has been recorded on CD-R or CD-RW. To produce the MP3/WMA/JPEG-data, you need a Windows-PC with CD-ROM drive and a MP3/WMA/JPEG-encoding Software (not supplied).
The Apple-HFS-System can not be played.

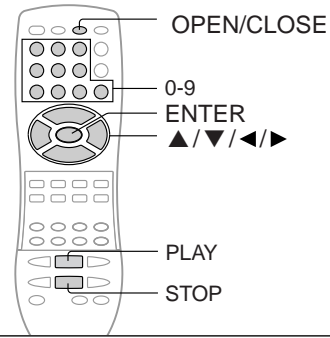

MP3/WMA Playback

1 Press OPEN/CLOSE.
The disc tray will open. Place a disc on which MP3 or WMA files have been recorded onto the tray.

2 Press OPEN/CLOSE or PLAY.
The disc tray closes automatically. On the TV-screen, "Reading" will appear. Reading will take as much time as the number of file.

3 A file menu screen will appear on the TV screen. Press left or right to select folder.

4 Press up/down or left/right or Number keys to select the desired file, then press ENTER.
The file is selected and play commences.

• In case the folder includes more than 15 tracks, press left or right to display next file list.

• When **PLAY** has been pressed after displaying the file menu, or when the disc tray has been closed after pressing **PLAY** in step 2, playback begins automatically starting from the first file. In this case, if the first file is an MP3/WMA file, only MP3/WMA files are played back in order. If the first file is a JPEG file, the first JPEG file is played back.

5 Press STOP to end playback.

• The unit records the stopped point. "■" appears on the screen. Press **PLAY** to resume playback (from the scene point).

• If you press **STOP** again or unload the disc, the unit will clear the stopped point.

Notes:

- During MP3/WMA/JPEG-Playback, you can not use SEARCH, A-B Repeat functions.
- You can use Repeat (Track or All), Random functions and Program playback for MP3/WMA/JPEG CD Playback. (See page 52 and 53.)

MP3/WMA/JPEG CD Information

Limitations on MP3/WMA/JPEG CD playback

- MP3/WMA/JPEG CD is the disc that is standardized by ISO9660, its file name must include 3-digits extension letters, "mp3", "wma", "jpg".
- The directory and file names of the MP3/WMA/JPEG CD must be correspond to the ISO standardized files.
- This unit can read 200 files per disc. If one directory has more than 200 files, it reads up to 200 files, the remaining files will be omitted.
- The unit is able to recognize up to a maximum of 50 directories per disc.
- MP3/WMA CDs cannot be used for playback for the purpose of recording.
- As for multi-session disc, only the first session can be played.
- If the CD has both audio tracks and MP3/WMA/JPEG files, only audio tracks are played.
- It may take more than one minute for this unit to read MP3/WMA/JPEG files depending on its structure.
- Music recorded by "Joliet Recording Specification" can be played back, the file name is displayed (within 16 letters) on the screen. Long file names will be condensed.
- The music files recorded by "Hierarchical File System" (HFS) cannot be played.
- The unit can play back baseline and progressive JPEG files.

Limitations on display

- The maximum number for display is 16 letters. Available letters for display are the following: capital or small alphabets of A through Z, numbers of 0 through 9, and _ (under score).
- Other letters than those above are replaced in hyphen.

Notes on MP3/WMA/JPEG files
To play back MP3/WMA/JPEG CD in the recorded order,

- Use MP3/WMA/JPEG software that records data alphabetically or numerically.
- Name each file including two-digit or three-digit number (e.g. "01" "02" or "001" "002").
- Refrain from making too many sub-folders.

CAUTION:

- Some MP3/WMA/JPEG CDs can not be played back depending on the recording conditions.
- The CD-R/RW that has no music data or non-MP3/WMA/JPEG files can not be played back.

Advanced playback (DVD)



MP3/WMA/JPEG playback (continued)

You can select your desired JPEG file on the file menu and picture menu. The selected JPEG file is automatically adjusted to the TV screen. (When the aspect ratio of the JPEG file is different to your TV screen, the black bar will appear at the top and bottom, or the both sides of the TV screen.)

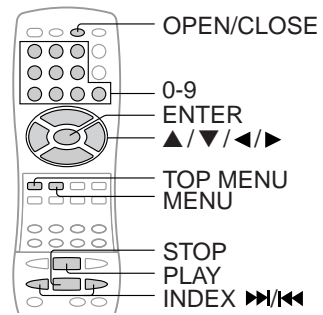

CD JPEG CD playback

1 Press OPEN/CLOSE.
 The disc tray will open. Place a disc on which JPEG files have been recorded onto the tray.

2 Press OPEN/CLOSE or PLAY.
 The disc tray closes automatically. On the TV-screen, "Reading" will appear. Reading will take as much time as the number of file.

3 A file menu screen will appear on the TV screen. Press ◀ or ▶ to select folder.

4 Press ▲/▼ or ◀/▶ or Number keys to select the desired file.

To display a picture menu, press MENU. (To return to a file menu, press TOP MENU.) Press ▲/▼ or ◀/▶ to select the desired file.

• To display next list, press SKIP ▶▶ or ◀◀.

• When PLAY has been pressed after displaying the file menu, or when the disc tray has been closed after pressing PLAY in step 2, playback begins automatically starting from the first file. In this case, if the first file is a JPEG file, the first JPEG file is played back. If the first file is an MP3/WMA file, only MP3/WMA files are played back in order.

5 Press ENTER.
 The selected picture appears on the TV screen.

6 Press STOP to end playback.
 The file menu appears on the TV screen. If you want to watch the other file, repeat steps 4-5.

Notes:

- The picture menu is displayed when the FUJICOLOR CD or the Kodak Picture CD are played. To display the file menu press TOP MENU.
- In the case of a CD containing a mixture of MP3, WMA and JPEG files, the files are played back by selecting them from the file menu.

File menu information

Operation	Media type	File number	Elapsed time
Folder	CD-R	1/94	02:36
	Pops		
	1 flower	8	MP3
	2 Bay Bridge	9	MP3
	3 CLOSE MY EYES	10	Pic-1
	4 DIVE TO BLUE	11	Pic-2
	5 Honey	12	Pic-3
	6 BLUE EYES	13	Pic-4
	7 Blurry Eyes	14	Pic-5

: Indicates MP3 file
 : Indicates WMA file
 : Indicates JPEG file

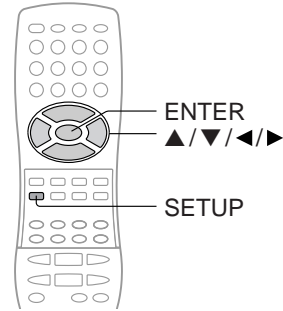

CD Setting the JPEG Interval

You can continuously play back all JPEG files automatically.
After the setting below, start playing the disc on which JPEG files have been recorded.

1 Press **SETUP** in the stop mode. Press **◀** or **▶** to select "Picture", then press **ENTER**.

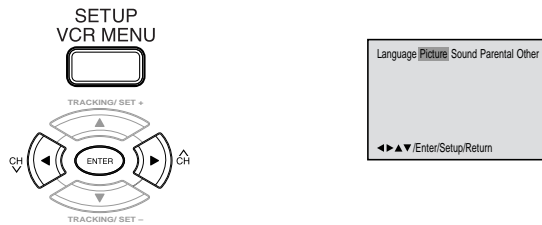

4 To make **SETUP** screen disappear, press **SETUP**.



2 Press **▲** or **▼** to select "JPEG Interval".



3 Press **ENTER**. Press **◀** or **▶** to select your desired time, then press **ENTER**.



Off:

Plays back one file at a time.

5 Seconds:

Plays back images in the form of a slide show at 5 second intervals.

10 Seconds:

Plays back images in the form of a slide show at 10 second intervals.

15 Seconds:

Plays back images in the form of a slide show in 15 second intervals.

Advanced playback (DVD)

MP3/WMA/JPEG playback (continued)

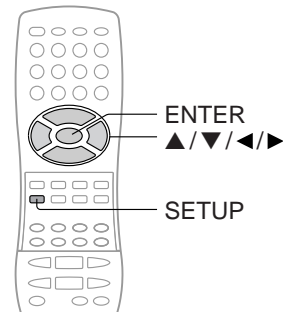

CD Setting the Select Files

When playing back a CD containing a mixture of MP3, WMA and JPEG files, only MP3/WMA or JPEG files can be displayed on the file menu.

1 Press **SETUP** in the stop mode. Press **◀** or **▶** to select "Picture", then press **ENTER**.

2 Press **▲** or **▼** to select "Select Files".

3 Press **ENTER**. Press **◀** or **▶** to select your desired file type, then press **ENTER**.

All:
Displays all files.
Music Only:
Displays only MP3/WMA files.
Pictures Only:
Displays only JPEG files.

4 To make **SETUP** screen disappear, press **SETUP**.

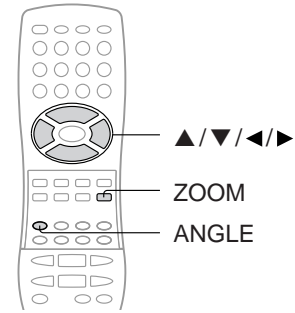

CD Zooming (JPEG CD)

This unit will allow you to zoom in on the JPEG image.

1 Press ZOOM during playback.



Enlarged JPEG images are displayed. You can make the images even larger by repeatedly pressing **ZOOM**.

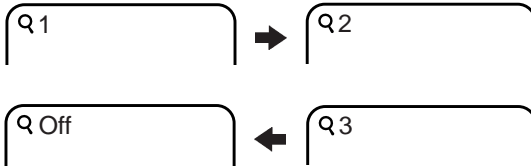

2 Press ▲/▼/◀/▶ to view a different part of the frame.

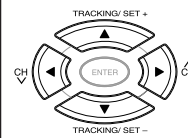

You may move the frame from the centre position to UP, DOWN, LEFT or RIGHT direction.

3 In the zoom mode press ZOOM repeatedly to return to a 1:1 view (Q Off).



CD Changing angles (JPEG CD)

You can display JPEG images rotating at 90 degree intervals.

1 Press ANGLE during playback. Images are rotated 90 degrees to the right.



2 Press ANGLE repeatedly until the desired angle is selected. Pressing ANGLE four times returns the image to its original angle.



- Images are displayed at the same angle until the disc is removed.

Advanced playback (DVD)



Zooming/Locating desired scene

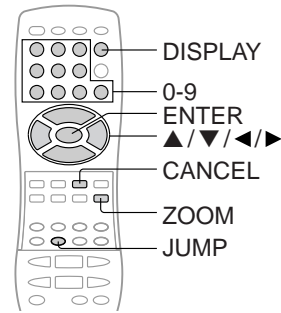

DVD VCD Zooming

This unit will allow you to zoom in on the frame image. You can then make selections by switching the position of the frame.

1 Press ZOOM during playback.



The centre part of the image will be zoomed in. Each press of **ZOOM** will change the ZOOM Q 1 (x 1.3), Q 2 (x 1.5) and Q 3 (x 2.0).

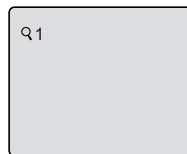

2 Press ▲ / ▼ / ◀ / ▶ to view a different part of the frame.

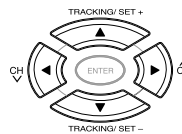

You may move the frame from the centre position to UP, DOWN, LEFT or RIGHT direction.

3 In the zoom mode press ZOOM repeatedly to return to a 1:1 view (Q Off).



Notes:

- You can select the Pause, Slow or Search playback in the zoom mode.
- Some discs may not respond to zoom feature.

DVD VCD CD Locating desired scene

Use the title, chapter and time recorded on the disc to locate the desired point to play back. To check the title, chapter and time, press **DISPLAY**.

1 Press JUMP during playback or stop mode.

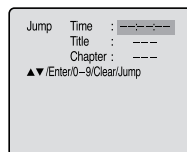

3 Press Numbered buttons (0-9) to change the number.



- If you input a wrong number, press **CANCEL**.
- Refer to the package supplied with the disc to check the numbers.

2 Press ▲ or ▼ to select the "Time", "Title" or "Chapter".

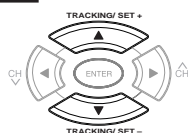

4 Press ENTER. Playback starts.



- When you change the title, playback starts from Chapter 1 of the selected title.
- Some discs may not work in the above operation.

Note:

In case of the Video-CD playback with PBC, the SEARCH MODE does not work.





Marking desired scenes

The unit stores the points that you want to watch again up to 3 points. You can resume playback from each scene.

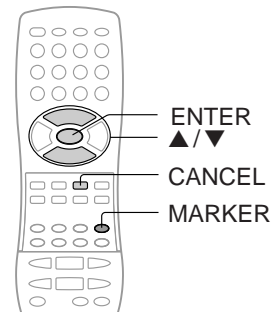

DVD VCD Marking the Scenes

- 1 Press MARKER during playback.**

MARKER

```
Marker 1 : **: **: **
Marker 2 : **: **: **
Marker 3 : **: **: **
▲▼/Enter/Clear/Marker
```
- 2 Select the blank Marker using ▲ or ▼. Then press ENTER at the desired scene.**

 - Repeat this procedure to set the other 2 scenes.

```
Marker 1 : 00 : 27 : 54
Marker 2 : **: **: **
Marker 3 : **: **: **
▲▼/Enter/Clear/Marker
```
- 3 Press MARKER to remove this display.**

MARKER

DVD VCD Returning to the Scenes

- 1 Press MARKER during playback or stop mode.**

MARKER

```
Marker 1 : 00 : 27 : 54
Marker 2 : 01 : 16 : 25
Marker 3 : 02 : 08 : 31
▲▼/Enter/Clear/Marker
```
- 2 Press ▲ or ▼ to select the Marker 1-3.**

```
Marker 1 : 00 : 27 : 54
Marker 2 : 01 : 16 : 25
Marker 3 : 02 : 08 : 31
▲▼/Enter/Clear/Marker
```
- 3 Press ENTER.**

Playback starts from the marked scene.

■ To cancel the Marker
Follow the above steps 1~2, then press **CANCEL**.

Notes:

- Some discs may not work with the marking operation.
- The marking is canceled when you open the disc tray or turn the power off.
- Some subtitles recorded around the marker may fail to appear.

Advanced playback (DVD)

Repeat playback

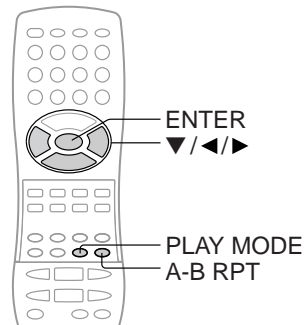

DVD VCD CD Repeat playback of Title, Chapter and Track

- 1 Press PLAY MODE during playback or stop mode.**
- 2 DVD**
Press ◀/▶ or ENTER once or twice to select "Chapter" or "Title".

CD/VCD
Press ▼ to select "Repeat".
Press ◀/▶ or ENTER once or twice to select "Track" or "All".
- 3 Press PLAY MODE again to make the screen disappear.**
Press PLAY to start Repeat playback.
To resume normal playback, select Repeat "Off".

Note:
Some discs may not work with the repeat operation.

DVD VCD CD A-B Repeat Playback

A-B repeat playback allows you to repeat material between two selected points.

- 1 Press REPEAT A-B during playback.**

A-B RPT The start point is selected.
- 2 Press A-B RPT again.**

A-B RPT The end point is selected. Playback starts at the point that you selected. Playback stops at the end point, returns to Point A automatically, then starts again.

■ To resume normal playback

Press **A-B RPT** again.
A-B RPT "Off" appears on the screen.

- Notes:**
- In A-B repeat mode, subtitles near point A or B may not appear.
 - Repeat playback is not available in multi-angle scenes.
 - You may not be able to set A-B Repeat, depending on the scenes of the DVD.
 - A-B repeat does not work with an interactive DVD, MP3/WMA/JPEG CD and Video CD with PBC.



Program playback/Random playback (CD)

You can arrange the order of tracks on the disc.

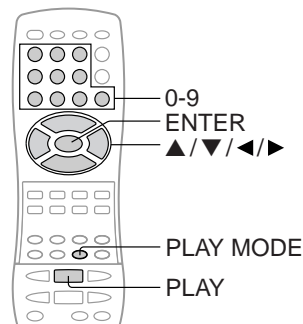

VCD CD Program Playback

1 Press PLAY MODE in the stop mode.

PLAY MODE SP/SLP

Play Mode	: Off
Repeat	: Off
◀▶▲▼/Enter/Play Mode	

2 Press ▲ or ▼ to select Play Mode, then press ◀ or ▶ to select program.

Play Mode	: Program		
Repeat	: Off		
1	4	7	10
2	5	8	11
3	6	9	12
Clear	Program Playback		
◀▶▲▼/Enter/0-9/Clear/Play Mode			

3 Press ▲/▼ or ◀/▶ to select the programming position. Use Numbered buttons (0-9) to input the Track numbers.

- To program others, repeat Step 3.
- If you input a wrong number, press **CANCEL**.

Play Mode	: Program			
Repeat	: Off			
1	9	4	7	10
2	3	5	8	11
3	11	6	9	12
Clear	Program Playback			
◀▶▲▼/Enter/0-9/Clear/Play Mode				

4 Press ▲/▼ or ◀/▶ to select "Program Playback" and press ENTER.

The programmes you selected will start to playback in the order.
To return to normal playback, select Play Mode: "Off".

Play Mode	: Program			
Repeat	: Off			
1	7	4	7	10
2	3	5	8	11
3	11	6	9	12
Clear	Program Playback			
◀▶▲▼/Enter/0-9/Clear/Play Mode				

To cancel program playback
Select "Clear" and press ENTER.

- The program is cancelled when you open the disc tray or turn the power off.

Note:
In playing back the Video CD with PBC, you can not set Program playback.

VCD CD Random Playback

1 Press PLAY MODE in the stop mode.

PLAY MODE SP/SLP

2 Press ▲/▼ to select Play Mode, then press ◀/▶ to select "Random".

Play Mode	: Random
Repeat	: Off
◀▶▲▼/Enter/Play Mode	

3 Press PLAY.

PLAY

The Random Playback will start.

Note:
In playing back the Video CD with PBC, you can not set Random playback.

Advanced playback (DVD)

Changing angles/Title selection/DVD menu

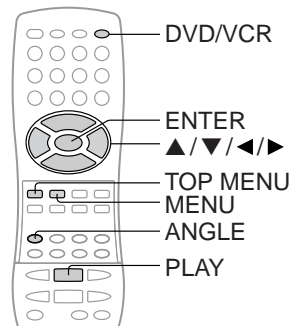

DVD Changing Angles

When playing back a disc recorded with multi-angle facility, you can change the angle that you are viewing the scene from.

1 Press ANGLE during playback.
 ANGLE COUNTER RESET The current angle will appear.

2 Press ANGLE repeatedly until the desired angle is selected.

Note:
 Depending on the DVD, you may not be able to change the angles even if multi-angles are recorded on the DVD.

DVD Title Selection

Two or more titles are recorded on some discs. If the title menu is recorded on the disc, you can select the desired title.

1 Press TOP MENU during playback.
 TOP MENU Title menu appears on the screen.

2 Press ▲/▼ or ◀/▶ to select the desired title.

3 Press ENTER or PLAY.
 The playback of the selected title will start.

Note:
 Depending on the DVD, you may not be able to select the title. Depending on the DVD, a "title menu" may simply be called a "menu" or "title" in the instructions supplied with the disc.

DVD DVD Menu

Some DVDs allow you to select the disc contents using the menu. When you play back these DVDs, you can select the subtitle language and sound-track language, etc. using the menu.

1 Press MENU during playback.
 MENU The DVD menu appears on the screen.
 • Press **MENU** again to resume playback at the scene when you pressed **MENU**.

2 Press ▲/▼ or ◀/▶ to select the desired item.

3 Press ENTER.
 The menu continues to another screen. Repeat steps 2 and 3 to set the item completely.



Changing soundtrack language/ Setting surround sound

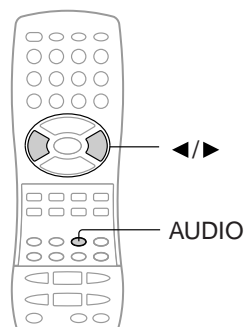

Changing soundtrack language

You can select the language when you play a multilingual disc.

1 Press AUDIO during playback.

AUDIO AUDIO SELECT



The current soundtrack language will appear.



2 Press AUDIO repeatedly until the desired language is selected.

AUDIO AUDIO SELECT



The on-screen display will disappear after a few seconds.

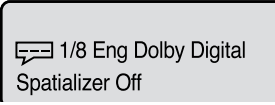

■ In case of VIDEO CD playback

Audio type changes as follows each time you press **AUDIO**.



Notes:

- If the desired language is not heard after pressing the button several times, the language is not recorded on the disc.
- Changing soundtrack language is cancelled when you open the disc tray. The initial default language or available language will be heard if the disc is played back again.
- If desired language is not selected after pressing the button several times, the language is not recorded on the disc.

Setting surround sound

This DVD/VCR equipped with a "SPATIALIZER VIRTUAL SURROUND". It can produce the effect of being in a cinema or a concert hall.

1 During disc playback press AUDIO.

AUDIO AUDIO SELECT

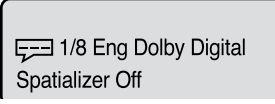
2 Press ◀ or ▶ to select "On".

■ To cancel Surround mode:

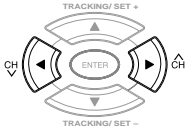
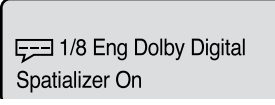
Follow the left steps 1~2, then press ◀ or ▶ to select the "Off" position.

Notes:

- If the selected language is not recorded on the disc, the original language will be heard.
- The "SPATIALIZER VIRTUAL SURROUND" is effective only for the sound of disc.

Spatializer® 3-Dimensional Sound Processing provided by Desper Products, Inc. Certain audio features of this product manufactured under a license from Desper Products, Inc., Spatializer® and the circle-in-square device are trademarks owned by Desper Products, Inc.

Advanced playback (DVD)



Setting subtitles/Karaoke playback

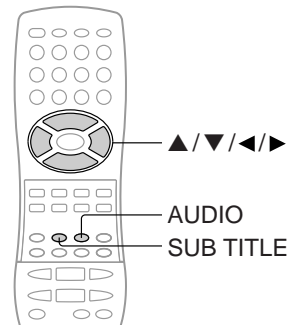



DVD Turning the subtitles on and off

When playing back a disc recorded with subtitles, you can turn the subtitles on or off.

Press SUB TITLE during playback until "Off" appears.

SUB TITLE
ATR

Note:
Depending on the DVD, you may not be able to turn the subtitles on even if they are recorded on it. Depending on the DVD, you may not be able to turn the subtitles off.

DVD Changing the subtitle language

You can select the language when playing back a disc recorded with multi-lingual subtitles.

1 Press SUBTITLE repeatedly during playback until your desired language appears.

SUB TITLE
ATR

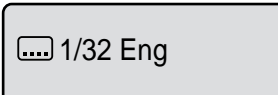
2 The on-screen display will disappear after a few seconds.

Notes:

- Changing subtitle language is cancelled when you open the disc tray.
- Depending on the DVD, you may not be able to change the subtitles even if multilingual subtitles are recorded on it. While playing the DVD, the subtitle may change when: -you open or close the disc tray -you change the title.
- In some cases, the subtitle language is not changed to the selected one immediately.

DVD Karaoke playback

You can turn the vocal on or off recorded on the DVD KARAOKE.

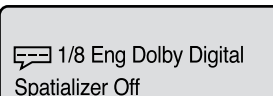

1 During DVD KARAOKE disc playback, press AUDIO.

AUDIO
AUDIO SELECT

2 Press ▲ or ▼ until the KARAOKE symbol (🎤) appears.

TRACKING/SET +
ENTER
TRACKING/SET -

3 Press ◀ or ▶ to select "On" or "Off".

TRACKING/SET +
ENTER
TRACKING/SET -



On : The primary vocal is output when it is recorded on the disc.
Off : The primary vocal is not output.

Notes:

- The vocal output feature is used during playback of Dolby Digital (multi-channel) recorded DVD KARAOKE discs. This feature allows you to turn off vocal audio tracks, or restore them for background accompaniment.
- When playing Karaoke, connect appropriate audio equipment such as an amplifier to the DVD/VCR.



Setting the aspect ratio of TV screen

You can select the aspect ratio for your TV.
The following pages describe the setup/operation in DVD mode.

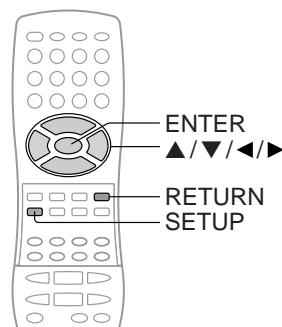

DVD Setting the aspect ratio of TV screen

1 Press **SETUP** in the stop mode or No Disc. Press **◀** or **▶** to select "Picture".

Language	Picture	Sound	Parental	Other
----------	---------	-------	----------	-------

◀▶/Enter/Setup/Return

2 Press **▼** or **ENTER**, then press **▲** or **▼** to select "Tv Screen".

Language	Picture	Sound	Parental	Other
Tv Screen	4:3			
Display	On			
JPEG Interval	Off			
Select Files	All			

◀▶/Enter/Setup/Return

3 Press **▶** or **ENTER**. Press **▲** or **▼** to select your desired screen type, then press **ENTER**.

Language	Picture	Sound	Parental	Other
Tv Screen	4:3	4:3		
Display	On	4:3		
JPEG Interval	Off	16:9		
Select Files	All			

◀▶/Enter/Setup/Return

You have the following screen sizes to choose from:

4:3 **LETTERBOX**
Select this mode when connecting to a conventional TV. When playing back a wide screen-DVD disc, it displays the wide picture with black bands at the top and bottom of screen.

4:3 **PANSCAN**
It displays the wide picture on the whole screen with left and right edges automatically cut off.

16:9 **WIDE SCREEN**
Select this mode when connecting to a wide-screen TV. A wide screen picture is displayed full size.

4 To make **SETUP** screen disappear, press **SETUP** or **RETURN** while the **SETUP** screen is being displayed.

Note:
If the DVD disc is not formatted in the pan & scan style, it displays 4:3 style.

Function setup (DVD)



Setting on screen display/Status display of disc

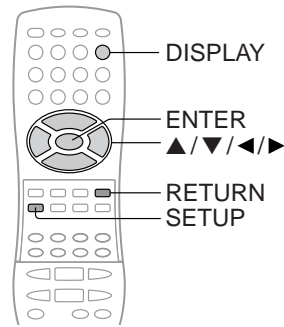

DVD Setting on screen display

On screen display can be switched on or off when you press the buttons.

1 Press **SETUP** in the stop mode or No Disc. Press **◀** or **▶** to select "Picture".

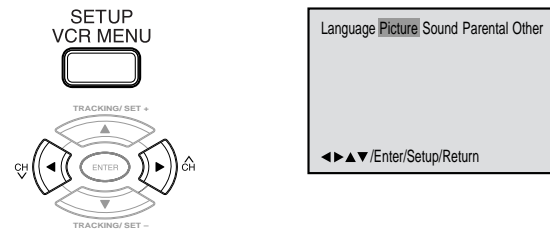

2 Press **▼** or **ENTER**, then press **▲** or **▼** to select "Display".

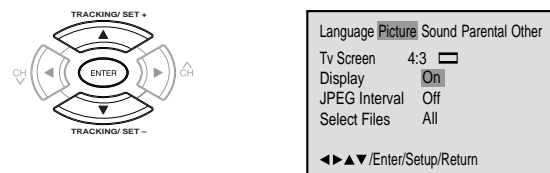

3 Press **◀/▶** or **ENTER** to select "On" or "Off".

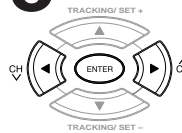

ON: On screen displays appear when you press the buttons (factory setting).
OFF: On screen displays do not appear when you press any buttons.

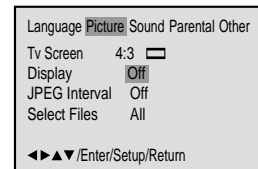

4 To make **SETUP** screen disappear, press **SETUP** or **RETURN** while the **SETUP** screen is being displayed.



DVD VCD CD Status display of disc

Each Press of **DISPLAY**, the status display of the disc will appear on the screen and change as follows.

DVD

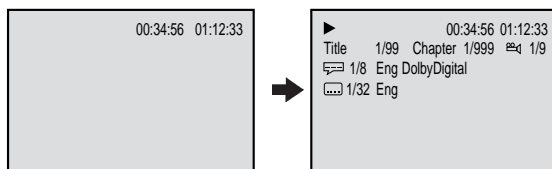

To make status display disappear, press **DISPLAY** again.

VIDEO CD

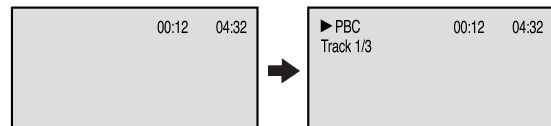

AUDIO CD

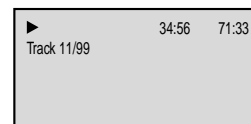

When you playback the CD disc, the status display will appear on the screen and continue displaying.





Dynamic Range Control

DRC (Dynamic Range Control) enables you to control the dynamic range so as to achieve a suitable sound for your equipment.

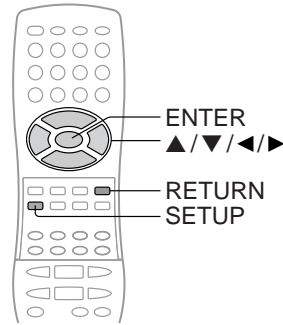

DVD Dynamic Range Control

1 Press **SETUP** in the stop mode. Press **◀** or **▶** to select "Sound".

Language Picture **Sound** Parental Other

◀▶▶/Enter/Setup/Return

2 Press **▼** or **ENTER** to select "DRC".

Language Picture **Sound** Parental Other

DRC **Std**

◀▶▶/Enter/Setup/Return

3 Press **▶** or **ENTER**, then press **▲** or **▼** to select desired setting.

Max: Full dynamic range is increased.
Std: Full dynamic range is maintained.
Min: Dynamic range is reduced.

Language Picture **Sound** Parental Other

DRC **Std** Max
Std
Min

◀▶▶/Enter/Setup/Return

4 To make **SETUP** screen disappear, press **SETUP** or **RETURN** while the **SETUP** screen is being displayed.

SETUP
VCR MENU

RETURN

- Notes:**
- This function works only during playback of Dolby Digital recorded discs.
 - The level of Dynamic Range Reduction may differ depending on DVD video disc.

Function setup (DVD)



Parental control setting

Some discs are specified not suitable for children. Such discs can be limited not to play back with the unit.

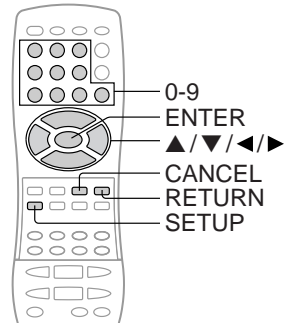

DVD Parental control setting

1 Press **SETUP** in the stop mode or No Disc. Press **◀** or **▶** to select "Parental". Then press **▼** or **ENTER**.

Language	Picture	Sound	Parental	Other

			Off	
0-9/Clear				
◀▶▲▼/Enter/Setup/Return				

4 Press **ENTER** to store the password.

Note: Now the rating is locked and the setting cannot be changed unless you enter the correct password.

Language	Picture	Sound	Parental	Other

			1	
0-9/Clear				
◀▶▲▼/Enter/Setup/Return				

2 Press **▲** or **▼** to select "Parental", then press **◀** or **▶** until the level you require appears.

- **Level Off** : The parental control setting does not function.
- **Level 8** : All DVD software can be played back.
- **Level 1** : DVD software for adults cannot be played back.
- Select from the level 1 to level 8. The limitation will be more severe as the level number is lower.

Language	Picture	Sound	Parental	Other
			1	
0-9/Clear				
◀▶▲▼/Enter/Setup/Return				

5 Press **SETUP** or **RETURN** to remove the parental control screen.

3 Press **▲** or **▼** to select "Password". Press number buttons (0-9) to input a 4-digit password.

Be sure to remember this number!

- If you input a wrong number, press **CANCEL**.

Language	Picture	Sound	Parental	Other
			1234	
			1	
0-9/Clear				
◀▶▲▼/Enter/Setup/Return				

Notes:

- If each setup (P. 57-66) has been completed, the unit can always be worked under the same conditions (especially with DVD discs). Each setup will be retained in the memory if you turn the power off.
- Depending on the discs, the unit cannot limit playback.
- Some discs may not be encoded with specific rating level information though its disc jacket says "adult." For those discs, the age restriction will not work.



To change the parental level

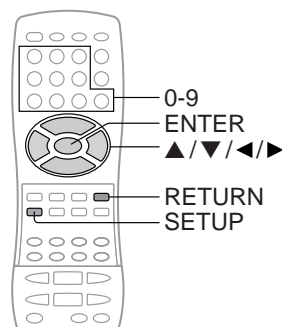

DVD To change the parental level

1 Press **SETUP** in the stop mode or No Disc. Press **◀** or **▶** to select "Parental". Then press **▼** or **ENTER**.

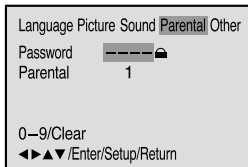
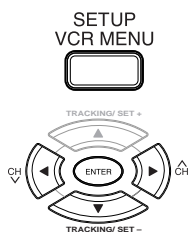

2 Press number buttons (0-9) to enter the password you have stored.

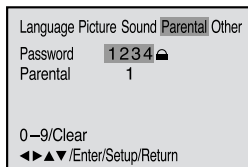

3 Press **ENTER**. The rating is now unlocked.

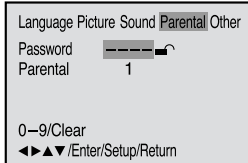
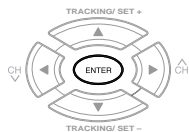

4 Press **▲** or **▼** to select "Parental", then press **◀** or **▶** to change the parental level.

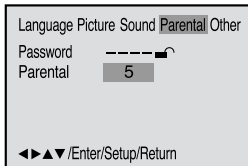
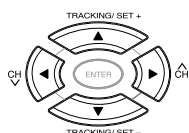

5 Press **▲** or **▼** to select "Password", then press number buttons (0-9) to enter the password.

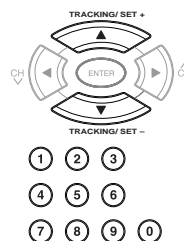

Note: You can change the password if you want.

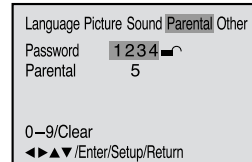

6 Press **ENTER**.

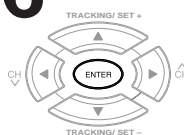

Now the parental level is changed and locked.

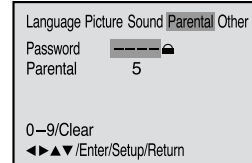

7 Press **SETUP** or **RETURN** to remove the parental control screen.



Note: Do not forget the password. If you forget the password, contact the dealer that you purchased the unit from.

Function setup (DVD)

Temporary disabling of rating level by DVD disc

Depending on the DVD disc, the disc may try to temporarily cancel the rating level that you have set. It is up to you to decide whether to cancel the rating level or not.

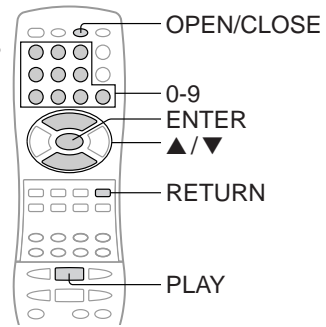

DVD Temporary disabling of rating level by DVD disc

- 1** Load a DVD disc and press **PLAY** or **OPEN/CLOSE** on the unit (see P. 42).

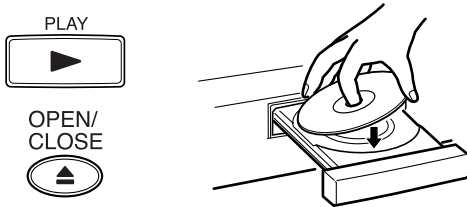

- 2** If the DVD disc has been designed to temporarily cancel the Rating level, the screen which follows the "Reading" screen will change, depending on which disc is played. If you select "YES" with the **ENTER** key, "Your disc exceeds The parental control level#." screen will then appear.

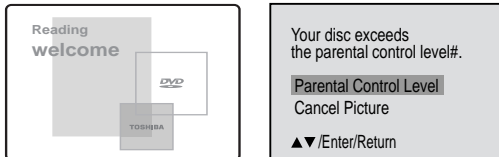

- 3** If you wish to cancel the set rating level temporarily, select "Parental Control Level" with **▲** or **▼**, then press **ENTER**. If the 4-digit password at step 2 on P.61 has been set, the password entering screen will appear as shown in step 4. Alternatively, if the password has not been set, playback will commence. If you don't know (or have forgotten) the password, select "Cancel Picture". The setting screen will disappear. Press **OPEN/CLOSE** to remove the disc.

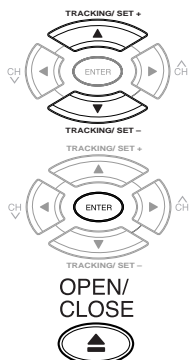

- 4** Enter the password with number buttons (0-9). Then press **ENTER**.

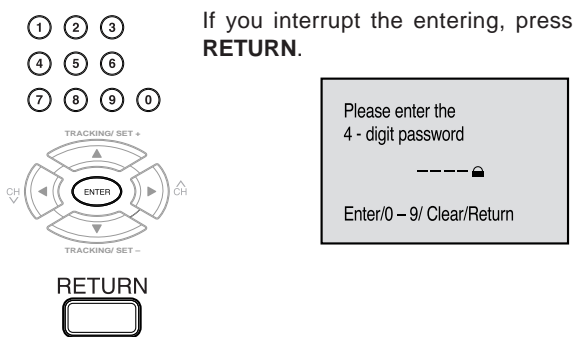

- 5** Playback will commence if the entered password was correct.

Note:

This temporary cancellation of rating level will be kept until the disc is ejected. When the disc is ejected, the original rating level will be set again automatically.



Setting setup language

The setup language can be selected.

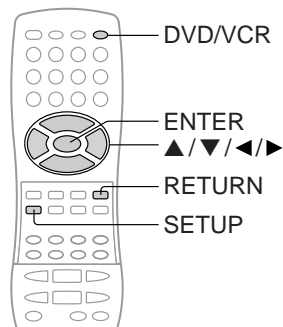

DVD VCR CD Setting setup language

1 Press DVD/VCR to select the DVD mode.

DVD/VCR "Reading" changes to "No Disc".
(If DVD disc has already loaded, the playback will start automatically.)

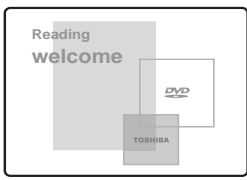

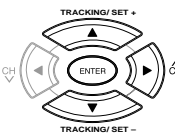
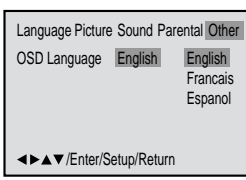

4 Press **▶** or ENTER and then press **▲** or **▼** to select desired language (e.g. English), then press ENTER.

2 Press SETUP in the stop mode.
Press **◀** or **▶** to select "Other".

SETUP VCR MENU

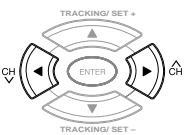
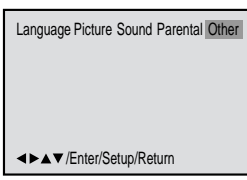



5 To make SETUP screen disappear, press SETUP or RETURN while the SETUP screen is being displayed.

SETUP VCR MENU



RETURN

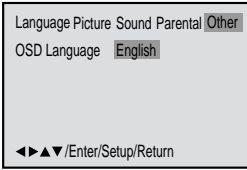

3 Press **▼** or ENTER to select "OSD Language".

If the unit does not operate properly: Static electricity, etc., may affect the player's operation. Disconnect the AC power cord once, then connect it again.

Function setup (DVD)



Setting menu language

You can select the language of the disc menu messages of DVDs.

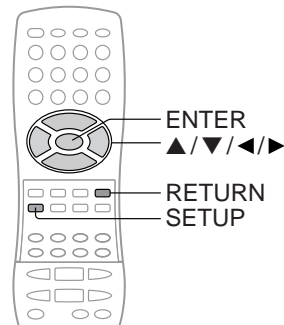

DVD Setting menu language

1 Press **SETUP** in the stop mode or No Disc. Press **◀** or **▶** to select "Language".

4 To make **SETUP** screen disappear, press **SETUP** or **RETURN** while the **SETUP** screen is being displayed.

2 Press **▼** or **ENTER**, then press **▲** or **▼** to select "Menu".

3 Press **▶** or **ENTER**. Press **▲** or **▼** to select your desired language, then press **ENTER**.

English, Francais, Espanol
The selected language is the first-priority Menu language.

Other: Other language can be selected (See the Language code list on page 67).



Changing subtitle language

The same subtitle language can always be selected even if you replace the disc or turn the power off.

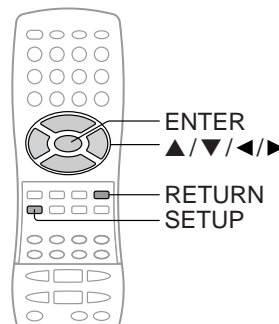

DVD Changing subtitle language

1 Press **SETUP** in the stop mode or No Disc. Press **◀** or **▶** to select "Language".

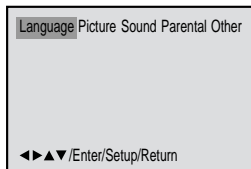
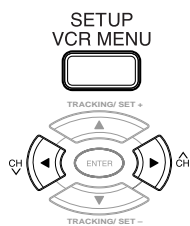

4 To make **SETUP** screen disappear, press **SETUP** or **RETURN** while the **SETUP** screen is being displayed.



2 Press **▼** or **ENTER**, then press **▲** or **▼** to select "Subtitle".

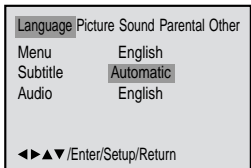
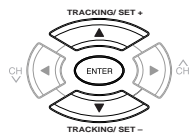

Note:

If the selected language is not recorded on the disc, the first-priority language is selected.

3 Press **▶** or **ENTER**. Press **▲** or **▼** to select your desired language, then press **ENTER**.



English, Francais, Espanol
The subtitle is displayed with the selected language if it is recorded on the disc.

Other:
If you want to select another language, enter the language code (see the language code list on page 67).

- Automatic:**
- The unit will automatically select the same language in the AUDIO setting.
 - When the unit selects the same language as the AUDIO, the subtitles will not appear during playback.
 - When you do not use the same language as the AUDIO, the subtitles will appear during playback.

Off:
Subtitles do not appear.

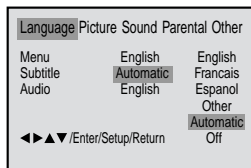

Function setup (DVD)





Function setup (DVD)

Setting audio soundtrack language

The same audio soundtrack language can always be selected by your unit even if you replace the disc or turn the power off.

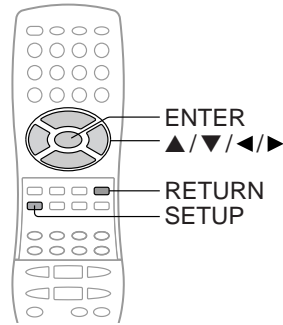

DVD Setting audio soundtrack language

- 1** Press **SETUP** in the stop mode or No Disc. Press **◀** or **▶** to select "Language".

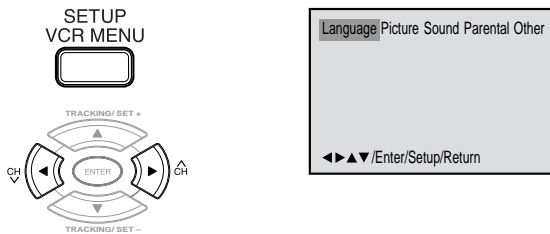

- 4** To make **SETUP** screen disappear, press **SETUP** or **RETURN** while the **SETUP** screen is being displayed.



- 2** Press **▼** or **ENTER**, then press **▲** or **▼** to select "Audio".

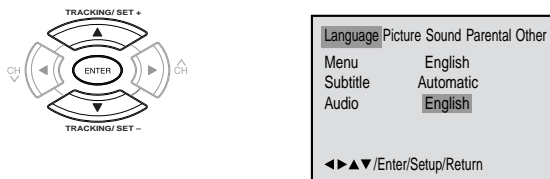

Note:

If the selected language is not recorded on the disc, the original language will be heard.

- 3** Press **▶** or **ENTER**. Press **▲** or **▼** to select your desired Audio Language, then press **ENTER**.

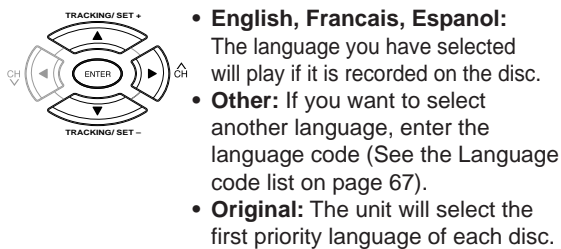

- **English, Francais, Espanol:** The language you have selected will play if it is recorded on the disc.
- **Other:** If you want to select another language, enter the language code (See the Language code list on page 67).
- **Original:** The unit will select the first priority language of each disc.

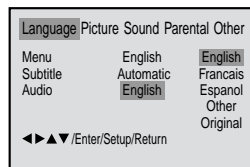



Language code list

Enter the appropriate code number for the initial settings "AUDIO", "SUBTITLE" and/or "MENU LANGUAGE" (see pages 64-66).

Language code list

Language Name	Code	Language Name	Code	Language Name	Code	Language Name	Code
Abkhazian	1112	Fiji	1620	Lingala	2224	Singhalese	2919
Afar	1111	Finnish	1619	Lithuanian	2230	Slovak	2921
Afrikaans	1116	French	1628	Macedonian	2321	Slovenian	2922
Albanian	2927	Frisian	1635	Malagasy	2317	Somali	2925
Amharic	1123	Galician	1722	Malay	2329	Spanish	1529
Arabic	1128	Georgian	2111	Malayalam	2322	Sundanese	2931
Armenian	1835	German	1415	Maltese	2330	Swahili	2933
Assamese	1129	Greek	1522	Maori	2319	Swedish	2932
Aymara	1135	Greenlandic	2122	Marathi	2328	Tagalog	3022
Azerbaijani	1136	Guarani	1724	Moldavian	2325	Tajik	3017
Bashkir	1211	Gujarati	1731	Mongolian	2324	Tamil	3011
Basque	1531	Hausa	1811	Nauru	2411	Tatar	3030
Bengali; Bangla	1224	Hebrew	1933	Nepali	2415	Telugu	3015
Bhutani	1436	Hindi	1819	Norwegian	2425	Thai	3018
Bihari	1218	Hungarian	1831	Oriya	2528	Tibetan	1225
Breton	1228	Icelandic	1929	Panjabi	2611	Tigrinya	3019
Bulgarian	1217	Indonesian	1924	Pashto, Pushto	2629	Tonga	3025
Burmese	2335	Interlingua	1911	Persian	1611	Turkish	3028
Byelorussian	1215	Irish	1711	Polish	2622	Turkmen	3021
Cambodian	2123	Italian	1930	Portuguese	2630	Twi	3033
Catalan	1311	Japanese	2011	Quechua	2731	Ukrainian	3121
Chinese	3618	Javanese	2033	Rhaeto-Romance	2823	Urdu	3128
Corsican	1325	Kannada	2124	Romanian	2825	Uzbek	3136
Croatian	1828	Kashmiri	2129	Russian	2831	Vietnamese	3219
Czech	1329	Kazakh	2121	Samoan	2923	Volapük	3225
Danish	1411	Kirghiz	2135	Sanskrit	2911	Welsh	1335
Dutch	2422	Korean	2125	Scots Gaelic	1714	Wolof	3325
English	1524	Kurdish	2131	Serbian	2928	Xhosa	3418
Esperanto	1525	Laothian	2225	Serbo-Croatian	2918	Yiddish	2019
Estonian	1530	Latin	2211	Shona	2924	Yoruba	3525
Faroese	1625	Latvian, Lettish	2232	Sindhi	2914	Zulu	3631

Others

Before calling service personnel

Check the following guide for the possible cause of a problem before contacting service.

Symptoms and correction

SYMPTOMS	POSSIBLE SOLUTIONS	PAGE
DVD/VCR		
DVD/VCR does not operate.	<ul style="list-style-type: none"> • Make sure the power cord is plugged in. • Try another AC outlet. • Power is off, check fuse or circuit breaker. • Unplug unit, then plug it back in. • Select the DVD or VCR mode before operating. 	5 – – 5 30,42
No picture.	<ul style="list-style-type: none"> • Antenna connection is not correct or antenna cable is disconnected. • The video channel is not in the correct position or the TV is not set to the video channel 3 or 4. • Check the unit is connected correctly. • The video input selector of the TV is not set to VIDEO. Set to VIDEO (or equivalent). • Channel is set to the external mode. 	14–17 22 14–19 – –
No sound.	<ul style="list-style-type: none"> • Check the unit is connected correctly. • Check the input selector of the amplifier is set properly. • The unit is in the Special playback mode. 	14–19 – 31,34
The remote control does not function.	<ul style="list-style-type: none"> • Aim at the remote control at the remote sensor. • Operate within Approx. 7 Meters or reduce the light in the room. • Clear the path of the beam. • The batteries are weak. Replace the batteries. • Check the batteries are inserted correctly. 	13
No CATV reception.	<ul style="list-style-type: none"> • Check all CATV connections. • Station or CATV system problems, try another station. 	16,17
VCR		
TV recording does not work.	<ul style="list-style-type: none"> • The erase prevention tab of the video cassette is broken off. • The unit is in the external input mode. 	29,34
Timer recording does not work.	<ul style="list-style-type: none"> • The time is not set correctly. • The recording start/end time is not set correctly. • The TIMER has not been pressed (E) is not lit). 	24 37 37
Noise bars on screen.	<ul style="list-style-type: none"> • Tracking adjustment beyond range of automatic tracking circuit. Try Manual tracking adjustment. • Video heads are dirty. • The tape is worn or damaged. 	31 31 –
DVD		
Display is not shown in your language.	<ul style="list-style-type: none"> • Select proper language in the menu options. 	63
Playback doesn't start.	<ul style="list-style-type: none"> • No disc is inserted. • The disc may be dirty. Clean up the disc. • The unit cannot play DVD-ROMs, etc. 	42 42 42
Stopping playback, slow-motion play, repeat play, or memory play, etc. cannot be performed.	<ul style="list-style-type: none"> • Some discs may not do some of the functions. 	–
No 4:3 (16:9) picture.	<ul style="list-style-type: none"> • The setup does not match your TV. 	57
No on-screen display.	<ul style="list-style-type: none"> • Select Display "On". 	58
No surround sound.	<ul style="list-style-type: none"> • The setup does not match your stereo system. 	20
The unit or remote operation key is not functioning.	<ul style="list-style-type: none"> • Turn off the unit and unplug the AC power cord for several minutes, then replug it. 	–
Playback does not start when the title is selected.	<ul style="list-style-type: none"> • Check the Parental setup. 	60,61
Audio soundtrack and/or subtitle language is not changed when you play back a DVD.	<ul style="list-style-type: none"> • Multilingual language is not recorded on the DVD disc. 	65,66
No subtitle.	<ul style="list-style-type: none"> • Some discs have no subtitles. • Subtitles are cleared. Press SUB TITLE. 	56
Angle cannot be changed.	<ul style="list-style-type: none"> • Multi-angles are not recorded on the DVD disc. 	54
⏸ appears on the screen.	<ul style="list-style-type: none"> • The function is prohibited with the unit or the disc. 	44



Specifications

General / input / output / supplied accessories

GENERAL

Power supply	AC 120V 60Hz
Power consumption	Operation: 16W, Stand by: 2W
Weight	7.9lbs (3.6 kg)
Dimensions	Width : 16-15/16 inches (430 mm) Height : 3-7/8 inches (99 mm) Depth : 9-7/8 inches (251.5 mm)
Tuner	181 channel freq. synthesized VHF 2-13 UHF 14-69 CATV 125 Channels
Antenna input/output	UHF/VHF In/Out : 75 ohm coaxial
RF channel output	Channel 3 or 4, Switchable
Color system	NTSC
Video head	4 Rotary heads
Audio track	Hi-Fi sound - 2 Tracks / MONO sound - 1 Track
Hi-Fi frequency response	20Hz to 20,000Hz
Hi-Fi dynamic range	More than 90dB
F.FWD/REW time at 25°C (77°F)	Approx. 1minute and 48 seconds (with T-120 Cassette Tape)
Applicable disc	DVD (12cm, 8cm), CD (12cm, 8cm)
Frequency range	DVD linear sound: 48 kHz sampling 4Hz-22kHz 96 kHz sampling 4Hz-44 kHz
S/N ratio	90dB (DVD)
Harmonic distortion	0.02% (DVD)
Wow and flutter	Below measurable level (DVD)
Operating conditions	Temperature: 5°C-40°C (41°F-104°F), Operating status: Horizontal

Input/Output

DVD/VCR	
Video input	1.0 V (p-p), 75 Ω, negative sync., pin jack x 2
Video output	1.0 V (p-p), 75 Ω, negative sync., pin jack x 1
Audio input	-8dBm, 50kΩ, negative sync., pin jack (L/R) x 2
Audio output	-8dBm, 1kΩ, negative sync., pin jack (L/R) x 1
DVD	
S video output	(Y) 1.0 V (p-p), 75 Ω, negative sync., Mini DIN 4-pin x 1 (C) 0.286 V (p-p), 75 Ω
Component video output	(Y) 1.0 V (p-p), 75 Ω, negative sync., pin jack x 1 (P _B)/(P _R) 0.7 V (p-p), 75 Ω, pin jack x 2
Audio output (BITSTREAM/PCM COAXIAL)	0.5V (p-p), 75 Ω, pin jack x 1
Audio output (BITSTREAM/PCM OPTICAL)	Optical connector x 1
Audio output (ANALOG)	-12dB, 1kΩ, pin jacks (L, R) x 1

Supplied accessories

Audio/video cable	1
Remote control (SE-R0088)	1
Batteries (AAA)	2
75 ohm coaxial cable	1

• Designs and specifications are subject to change without notice.

Others



LIMITED WARRANTY DVD VIDEO PLAYER

Toshiba America Consumer Products, Inc. ("TACP"), Toshiba Hawaii ("THI") and Toshiba Canada Limited ("TCL") make the following limited warranties. These limited warranties extend to original purchaser or any person receiving this set as a gift from the original purchaser and to no other purchaser or transferee.

Limited Ninety (90) Day Warranty

TACP/THI warrant this product against defects in materials or workmanship for a period of ninety (90) days after the date of original retail purchase. During this period, TACP/THI will repair or replace a defective product or part, at their option, with a new or refurbished product or part without charge to you. You must deliver the entire product to a TACP/THI Authorized Service Station. You are responsible for all transportation and insurance charges for the unit to and from the Authorized Service Station. If you live in the U.S.A. you may, at your option, return your DVD Unit to:

Toshiba America Consumer Products Inc.
Returns Center
1420C Toshiba Dr.
Lebanon, TN 37087

Upon receipt we will, at our option, exchange the DVD Unit with a new or refurbished unit. **Canadian consumers are requested to contact TCL. In Hawaii consumers are requested to contact THI.**

Limited One (1) Year Warranty

TACP/THI further warrant the parts in this product against defects in materials or workmanship for a period of one (1) year after the date of original retail purchase. During this period, TACP/THI will repair or replace a defective product or part, at their option, with a new or refurbished product or part without charge to you, except that if a defective part is replaced after ninety (90) days from the date of the original retail purchase you pay labor charges involved in the replacement. You must also deliver the entire product to a TACP/THI Authorized Service Station. You are responsible for all transportation and insurance charges for the unit to and from the Authorized Service Station. If you live in the U.S.A. you may, at your option, return your DVD Unit to:

Toshiba America Consumer Products Inc.
Returns Center
1420C Toshiba Dr.
Lebanon, TN 37087

Upon receipt we will, at our option, exchange the DVD Unit with a new or refurbished unit. **Canadian Consumers are requested to contact TCL. In Hawaii consumers are requested to contact THI.**

Rental Units

The warranty for rental units begin with the first rental or thirty (30) days from the date of shipment to the rental firm, whichever comes first.

Commercial Units

Products sold and used for commercial use have a limited ninety (90) day warranty for all parts and labor.

Owner's Manual

You should read the owner's manual thoroughly before operating this product. You should complete and mail the enclosed Demographic card within ten (10) days after you, or the person who has given you this product as a gift, purchased this product. This is one way to enable TACP to provide you with better customer service and improved products. Failure to return the card will not affect your rights under this warranty.

Your Responsibility

The above warranties are subject to the following conditions:

- (1) You must retain your bill of sale or provide other proof of purchase.
- (2) You must notify a TACP/THI/TCL /Authorized Service Station within thirty (30) days after you discover a defective product or part.
- (3) All warranty servicing of this product must be made by a TACP/THI/TCL Authorized Service Station.
- (4) U.S.A. warranties are effective only if the product is purchased and operated in the Continental U.S.A. or Puerto Rico.
- (5) Labor service charges for set installation. Set up, adjustment of customer controls and installation or repair of antenna systems are not covered by this warranty. Reception problems caused by inadequate antenna systems are your responsibility.
- (6) Warranties extend only to defects in materials or workmanship as limited above and do not extend to any product or parts which have been lost or discarded by you or to damage to products or parts caused by misuse, accident, damage caused by Acts of God, such as lighting or fluctuations in electric power, improper installation, improper maintenance or use in violation of instructions furnished by us; or to units which have been altered or modified without authorization of TACP/THI/TCL or to damage to products or part thereof which have had the serial number removed, altered, defaced or rendered illegible.
- (7) Should you elect to return your DVD Unit to TACP after the ninety (90) days and within one (1) year, or after the warranty period has expired: Call (800)-631-3811 to receive information concerning an exchange price. Payment must be enclosed with product in the form of a certified check or money order including reason for return.
- (8) Physically damaged DVD Units are not acceptable for repair or exchange whether in or out of warranty and will be returned as received.

(Continued)



LIMITED WARRANTY DVD VIDEO PLAYER (continued)

How to Obtain Warranty Service

- (1) Refer to the troubleshooting guide in your owner's manual. This check list may solve your problem.
- (2) In the U.S.A., only call the TACP toll free number 800-631-3811, or if in Hawaii or Canada see listing below within (30) days after you find a defective product or part.
- (3) Arrange for the delivery of the product to the TACP/THI/TCL Authorized Service Station or TACP Return Center. Products shipped to the Service Station must be insured and safely and securely packed, preferably in the original shipping carton, and a letter explaining the defect and also a copy of the bill of sale or other proof of purchase must be enclosed.

In the Continental United States contact:**In Hawaii contact:**

Toshiba Hawaii Inc.
327 Kamakee Street
Honolulu, HA 96814
(808)-521-5377

In Canada contact:

Consumer Electronics Group
191 McNabb Street
Markham, Ontario L3R 8H2
(905)-470-5400

Consumer Electronics Group
22171 Fraserwood Way
Richmond, B.C. V6W 1J5
(604)-303-2500

Consumer Electronics Group
18050 Trans canada
Kirkland, Quebec H9J 4A1
(514)-390-7766

All warranties implied by state law, including the implied warranties of merchantability and fitness for a particular purpose, are expressly limited to the duration of the limited warranties set forth above. With the exception of any warranties implied by state law as hereby limited, the foregoing warranty is exclusive and in lieu of all other warranties, guarantees, agreements and similar obligations of manufacturer or seller with respect to the repair or replacement of any parts. In no event shall TACP/THI be liable for consequential or incidental damages.

No person, agent, distributor, dealer or company is authorized to change, modify or extend the terms of these warranties in any manner whatsoever. The time within which an action must be commenced to enforce any obligation of TACP/THI arising under the warranty or under any statute, or law of the United States or any state thereof, is hereby limited to ninety (90) days from the date you discover or should have discovered, the defect. This limitation does not apply to implied warranties arising under state law.

This warranty gives you specific legal rights and you may also have other rights which may vary from state to state. Some states do not allow limitation on how long an implied warranty lasts, when an action may be brought, or the exclusion or limitation of incidental or consequential damages, so the above provisions may not apply to you.

ATTENTION CANADIAN CONSUMERS:

Canadian consumers are requested to complete the special Canadian "Warranty Registration Form" enclosed, and forward this completed form with a copy of bill of sale to TOSHIBA OF CANADA to "Register and Validate" their warranty. Product must be purchased from an Authorized Canadian Dealer. Products purchased in the U.S.A. and used in Canada are not covered by these warranties.

IMPORTANT: PACKING AND SHIPPING INSTRUCTION

When you send the product to a Service Station, you must use the original carton box and packing material, then insert the original carton box containing the unit into another carton using more packing material.

Others





TOSHIBA

J2C31101A 
03/01

Printed in Thailand

