

DRAFT

OWNER'S MANUAL

 **SANSUI**®

DVD PLAYER/Hi-Fi VIDEO CASSETTE RECORDER

VRDVD4001A



VHS Hi-Fi

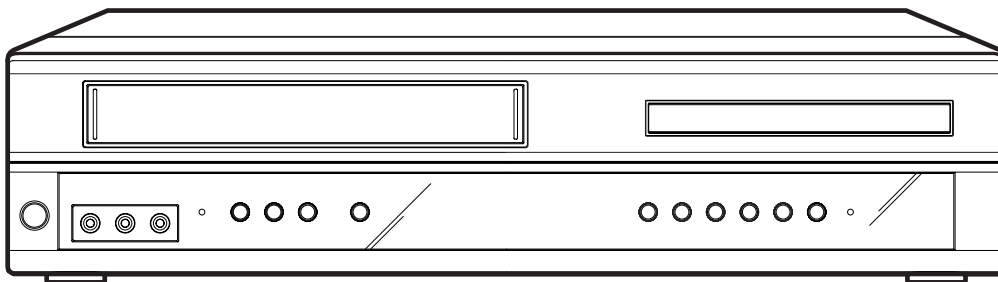

ATTENTION

If you purchase a universal remote control from your local retailer, please contact the remote manufacturer for the required programming code.

TV/CABLE MODE SELECTION

When shipped from the factory, the TV/CABLE menu option is set to the "CABLE" (Cable Television) mode.

If not using CABLE (Cable TV), set this menu option to the "TV" mode.

ORION WEBSITE

FOR INFORMATION ON OUR OTHER PRODUCTS,
PLEASE VISIT OUR WEBSITE AT
WWW.ORIONSALESINC.COM

Before operating the unit, please read this manual thoroughly.



	CAUTION RISK OF ELECTRIC SHOCK DO NOT OPEN	
<p>CAUTION: TO REDUCE THE RISK OF ELECTRIC SHOCK, DO NOT REMOVE COVER (OR BACK). NO USER-SERVICEABLE PARTS INSIDE. REFER SERVICING TO QUALIFIED SERVICE PERSONNEL.</p>		



The lightning flash with arrowhead symbol, within an equilateral triangle is intended to alert the user to the presence of uninsulated dangerous voltage within the product's enclosure that may be of sufficient magnitude to constitute a risk of electric shock to persons.



The exclamation point within an equilateral triangle is intended to alert the user to the presence of important operating and maintenance (servicing) instructions in the literature accompanying the appliance.

WARNING: TO REDUCE THE RISK OF FIRE OR ELECTRIC SHOCK, DO NOT EXPOSE THIS APPLIANCE TO RAIN OR MOISTURE.

WARNING: This equipment has been tested and found to comply with the limits for a Class B digital device, pursuant to Part 15 of the FCC Rules. These limits are designed to provide reasonable protection against harmful interference in a residential installation. This equipment generates, uses and can radiate radio frequency energy and, if not installed and used in accordance with the instructions, may cause harmful interference to radio communications.

However, there is no guarantee that interference will not occur in a particular installation. If this equipment does cause harmful interference to radio or television reception, which can be determined by turning the equipment off and on, the user is encouraged to try to correct the interference by one or more of the following measures:

- Reorient or relocate the receiving antenna.
- Increase the separation between the equipment and receiver.
- Connect the equipment into an outlet on a circuit different from that to which the receiver is connected.
- Consult the dealer or an experienced radio/TV technician for help.

CAUTION: Changes or modifications not expressly approved by the party responsible for compliance with the FCC Rules could void the user's authority to operate this equipment.

CAUTION:
THIS DIGITAL VIDEO PLAYER EMPLOYS A LASER SYSTEM.

TO ENSURE PROPER USE OF THIS PRODUCT, PLEASE READ THIS USER'S GUIDE CAREFULLY AND RETAIN FOR FUTURE REFERENCE. SHOULD THE UNIT REQUIRE MAINTENANCE, CONTACT AN AUTHORIZED SERVICE LOCATION-SEE SERVICE PROCEDURE.

USE OF CONTROLS, ADJUSTMENTS OR THE PERFORMANCE OF PROCEDURES OTHER THAN THOSE SPECIFIED HEREIN MAY RESULT IN HAZARDOUS RADIATION EXPOSURE.

TO PREVENT DIRECT EXPOSURE TO LASER BEAM, DO NOT TRY TO OPEN THE ENCLOSURE. VISIBLE LASER RADIATION MAY BE PRESENT WHEN THE ENCLOSURE IS OPENED. DO NOT STARE INTO BEAM.

Location of the required Marking

The rating sheet and the safety caution are on the rear of the unit.

CERTIFICATION: COMPLIES WITH FDA RADIATION PERFORMANCE STANDARDS, 21 CFR SUBCHAPTER J.

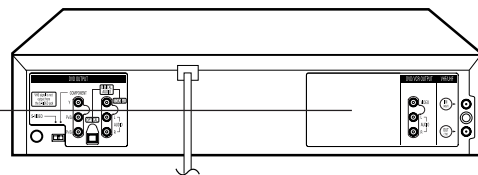



IMPORTANT SAFEGUARDS

1. READ INSTRUCTIONS

All the safety and operating instructions should be read before the unit is operated.

2. RETAIN INSTRUCTIONS

The safety and operating instructions should be retained for future reference.

3. HEED WARNINGS

All warnings on the unit and in the operating instructions should be adhered to.

4. FOLLOW INSTRUCTIONS

All operating and use instructions should be followed.

5. CLEANING

Unplug this unit from the wall outlet before cleaning. Do not use liquid cleaners or aerosol cleaners.

Use a damp cloth for cleaning the exterior cabinet only.

6. ATTACHMENTS

The manufacturer of this unit does not make any recommendations for attachments, as they may cause hazards.

7. WATER AND MOISTURE

Do not use this unit near water. For example, near a bathtub, washbowl, kitchen sink, laundry tub, in a wet basement, or near a swimming pool.

8. ACCESSORIES

Do not place this unit on an unstable cart, stand, tripod, bracket, or table.

The unit may fall, causing serious injury, and serious damage to the unit.

- 8A. An appliance and cart combination should be moved with care. Quick stops, excessive force, and uneven surfaces may cause the appliance and cart combination to overturn.

9. VENTILATION

Slots and openings in the cabinet back or bottom are provided for ventilation,

to ensure reliable operation of the unit, and to protect it from overheating.

These openings must not be blocked or covered. The openings should never be blocked by placing the unit on a bed, sofa, rug, or other similar surface. This unit should never be placed near or over a radiator or heat source. This unit should not be placed in a built-in installation such as a bookcase or rack unless proper ventilation is provided and/or the manufacturer's instructions have been adhered to.

10. POWER SOURCES

This unit should be operated only from the type of power source indicated on the rating plate. If you are not sure of the type of power supply to your home, consult your appliance dealer or local power company. For units intended to operate from battery power, or other sources, refer to the operating instructions.

11. GROUNDING OR POLARIZATION

This unit is equipped with a polarized alternating-current line plug (a plug having one blade wider than the other). This plug will fit into the power outlet only one way. This is a safety feature. If you are unable to insert the plug fully into the outlet, try reversing the plug. If the plug should still fail to fit, contact your electrician to replace your obsolete outlet. Do not defeat the safety purpose of the polarized plug, if your unit is equipped with a 3-wire grounding-type plug, a plug having a third (grounding) pin. This plug will only fit into a grounding-type power outlet. This too, is a safety feature. If you are unable to insert the plug into the outlet, contact your electrician to replace your obsolete outlet. Do not defeat the safety purpose of the grounding-type plug.

12. POWER-CORD PROTECTION

Power-supply cords should be routed so that they are not likely to be walked on or pinched by items placed upon or against them, paying particular attention to cords at plugs, convenience receptacles, and the point where they exit from the appliance.

13. LIGHTNING

To protect your unit from a lightning storm, or when it is left unattended and unused for long periods of time, unplug it from the wall outlet and disconnect the antenna or cable system. This will prevent damage to the unit due to lightning and power line surges.

14. POWER LINES

An outside antenna system should not be located in the vicinity of overhead power lines or other electric light or power circuits, or where it can fall into such power lines or circuits. When installing an outside antenna system, extreme care should be taken to keep from touching such power lines or circuits, as contact with them might be fatal.

15. OVERLOADING

Do not overload wall outlets and extension cords, as this can result in a risk of fire or electric shock.

16. OBJECT AND LIQUID ENTRY

Do not push objects through any openings in this unit, as they may touch dangerous voltage points or short out parts that could result in fire or electric shock. Never spill or spray any type of liquid into the unit.

17. OUTDOOR ANTENNA GROUNDING

If an outside antenna or cable system is connected to the unit, be sure the antenna or cable system is grounded to provide some protection against voltage surges and built-up static charges, Section 810 of the National Electrical Code, ANSI/NFPA 70, provides information with respect to proper grounding of the mast and supporting structure, grounding of the lead-in wire to an antenna discharge unit, size of grounding conductors, location of antenna discharge unit, connection to grounding electrodes, and requirements for the grounding electrode.

18. SERVICING

Do not attempt to service this unit yourself as opening or removing covers may expose you to dangerous voltage or other hazards. Refer all servicing to qualified service personnel.

PORTABLE CART WARNING
(symbol provided by RETAC)



S3125A



IMPORTANT SAFEGUARDS

19. DAMAGE REQUIRING SERVICE

Unplug this unit from the wall outlet and refer servicing to qualified service personnel under the following conditions:

- a. When the power-supply cord or plug is damaged.
- b. If liquid has been spilled, or objects have fallen into the unit.
- c. If the unit has been exposed to rain or water.
- d. If the unit does not operate normally by following the operating instructions. Adjust only those controls that are covered by the operating instructions, as an improper adjustment of other controls may result in damage and will often require extensive work by a qualified technician to restore the unit to its normal operation.
- e. If the unit has been dropped or the cabinet has been damaged.
- f. When the unit exhibits a distinct change in performance, this indicates a need for service.

20. REPLACEMENT PARTS

When replacement parts are required, be sure the service technician uses replacement parts specified by the manufacturer or those that have the same characteristics as the original part.

Unauthorized substitutions may result in fire, electric shock or other hazards.

21. SAFETY CHECK

Upon completion of any service or repairs to this unit, ask the service technician to perform safety checks to determine that the unit is in proper operating condition.

22. HEAT

The product should be situated away from heat sources such as radiators, heat registers, stoves, or other products (including amplifiers) that produce heat.

23. DISC TRAY

Keep your fingers well clear of the disc tray as it is closing. It may cause serious personal injury.

24. CONNECTING

When you connect the product to other equipment, turn off the power and unplug all of the equipment from the wall outlet. Failure to do so may cause an electric shock and serious personal injury. Read the owner's manual of the other equipment carefully and follow the instructions when making any connections.

25. LASER BEAM

Do not look into the opening of the disc tray or ventilation opening of the product to see the source of the laser beam. It may cause sight damage.

26. DISC

Do not use a cracked, deformed, or repaired disc. These discs are easily broken and may cause serious personal injury and product malfunction.

27. NOTE TO CABLE TV SYSTEM INSTALLER

This reminder is provided to call the CABLE TV system installer's attention to Article 820-40 of the NEC that provides guidelines for proper grounding and, in particular, specifies that the cable ground shall be connected to the grounding system of the building, as close to the point of cable entry as practical.

EXAMPLE OF ANTENNA GROUNDING AS PER THE NATIONAL ELECTRICAL CODE

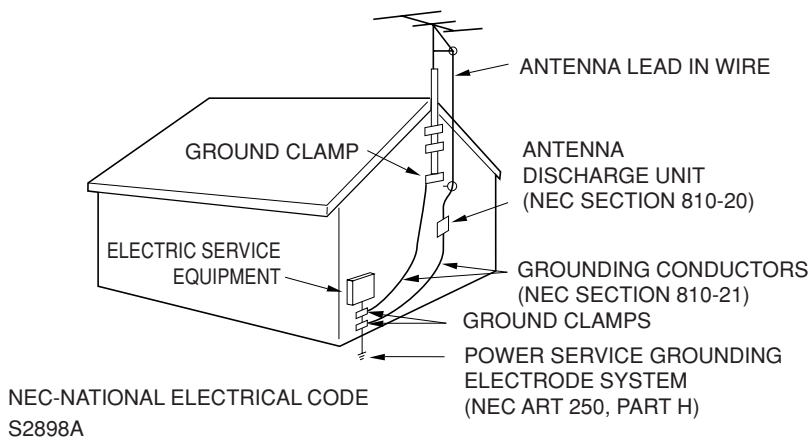

CONDENSATION

Moisture will form in the operating section of the DVD/VCR if the player is brought from cool surroundings into a warm room or if the temperature of the room rises suddenly. When this happens, the DVD/VCR's performance will be impaired. To prevent this, let the DVD/VCR stand in its new surroundings for about an hour before switching it on, or make sure that the room temperature rises gradually.

Condensation may also form during the summer if the DVD/VCR is exposed to the breeze from an air conditioner. In such cases, change the location of the DVD/VCR.





Features

DVD/CD Player/Video Cassette Recorder

- **DVD/CD player with Video Cassette Recorder** - Unique space saving design combines a DVD/CD player and a Hi-Fi Video cassette recorder. The DVD disc has much more capacity, but is the same size as the audio CD disc. Picture quality is higher than Super VHS. Audio quality is higher than audio CD. The DVD PLAYER can play back audio CDs.
- **High Quality Picture** - More than 500 lines (VCR mode: 230 lines) of Horizontal Resolution. It exceeds Super VHS (400 lines) or Laser Disc (430 lines) in resolution.

VCR Section

- **Stereo/SAP Reception** - This VCR is designed to receive stereo and second audio program (SAP) broadcasts where available.
- **4 Video Heads** - Provides optimal picture quality for special effects playback.
- **19µm HEAD** - For superior picture quality even in SLP mode, 19micron width technology helps to avoid crosstalk and boost SLP picture quality to near SP levels. With precision technology, ghosts and color beats are virtually eliminated.
- **Hi-Fi Stereo Sound** - With a frequency response of 20 to 20,000 Hz and a dynamic range of better than 90dB, this VCR provides a level of excellence that rivals compact discs.
- **One-touch Timer Recording (OTR)** - Simply by pressing the REC/OTR button, the VCR can be programmed for up to 6 hours of recording with an immediate start.

DVD Section

• Compatible with a wide range of DVD audio outputs

Digital Audio Jack (Optical or Coaxial):

- When a component with a built-in Dolby Digital decoder is connected, Dolby Digital sound can produce the effect of being in a movie theater or a concert hall.
- Surround standard different from Dolby Digital. This format is already in use in many theaters. By connecting this unit to a DTS decoder or an AV amplifier with a built-in DTS decoder, the DTS audio of DVD discs recorded in this format can be enjoyed. However, audio will not be output from the analog audio output jacks.
- The MPEG audio of DVD discs recorded in this format can be enjoyed.
- The Linear PCM sound of a 48 kHz/16 bit through 96 kHz/24 bit exceeds audio CD sound.
- **Progressive scan** - Progressive scan displays all the horizontal lines of a picture at one time, as a single frame. This unit converts the interlaced (480i) video from DVD into progressive (480p) format for connection to a progressive display. It increases the vertical resolution.
- **Multi-Language** - Since this DVD matches with 124 language-subtitles/-soundtracks, you can enjoy selecting a favorite one. (You can not select the language that is not recorded on the disc.)
- **Multi-Angle** - Pictures of Sports or a Live Concert are recorded with many cameras. When you play such a disc, you can change the angles during playback. (If a Multi-Angle is not recorded on the disc, you can not change the angle.)
- **Repeat Playback** - You can repeat chapter, track, title, sides or material between two selected points.
- **Program/Random Playback (CD)** - You can play back tracks in programmed or random-selected sequences.
- **Zoom** - You can zoom in on the selected subject on the screen during playback.
- **Video Aspect Ratio** - You can change the aspect ratio of the screen for your monitor/television on a suitable disc.
- **Parental Control** - You can limit the playback of scenes or sounds of adult DVD discs which have a parental level rating.

* This product incorporates copyright protection technology that is protected by method claims of certain U.S. patents and other intellectual property rights owned by Macrovision Corporation and other rights owners. Use of this copyright protection technology must be authorized by Macrovision Corporation and is intended for home and other limited viewing uses only unless otherwise authorized by Macrovision Corporation. Reverse engineering or disassembly is prohibited. Consumers should note that not all high definition television sets are fully compatible with this product and may cause artifacts to be displayed in the picture. In case of 525 progressive scan picture problems, it is recommended that the user switch the connection to the "STANDARD DEFINITION" output. If there are questions regarding our TV set compatibility with this model 525p DVD player, please contact our customer service center.

* Manufactured under license from Dolby Laboratories. "Dolby" and the double-D symbol are trademarks of Dolby Laboratories.

* "DTS" and "DTS Digital Out" are trademarks of Digital Theater Systems, Inc.

* Unauthorized recording of copyrighted television programs, films, video cassettes and other materials may infringe the rights of copyright owners and be contrary to copyright laws.



Contents

Before using your unit

IMPORTANT SAFEGUARDS	3
Features	5
Contents	6
Parts and functions	7
Remote control	8
Power Source	9
Basic connections	10
CABLE TV CONNECTIONS	11
Playback connections	12

Setting up the VCR section

Setting the video channel	14
Setting the language	14
Auto clock setting	15
Manual clock setting	16
Tuner setting	16
To ADD/DELETE channels	16
Noise elimination	16
Loading and Unloading a cassette tape	17

Tape playback operation

Playback	17
Special playback	18
ZERO RETURN function	18
Video index search system	18

Recording

Recording a TV program	19
One-touch Timer Recording (OTR)	20
Timer recording	20

Advanced function of VCR section

Stereo recording and playback	22
Second Audio Program (SAP)	22
Duplicating a video tape	22

Disc playback operation

Disc	23
Setting setup language	23
Playback procedure	24
Special playback	24
Zooming	24
Locating desired scene	25
Marking desired scenes	25
Changing soundtrack language	25
Subtitles	25
Title selection	26
DVD menu	26
Karaoke playback	26
Changing angles	26
Repeat playback	27
Program playback	27
Random playback (CD)	27
MP3 playback	28

Advanced function of DVD section

Parental control	29
Temporary disabling of rating level by DVD disc	29
Setting language	30
Setting the aspect ratio of TV screen	30
Status display of disc	30
Setting on screen display	31
Dynamic Range Control	31
Progressive scan	31

Additional information

Language code list	32
Problems and troubleshooting	33
Video head cleaning	34
Specifications	35
Limited WARRANTY	Back cover



Parts and functions

Front

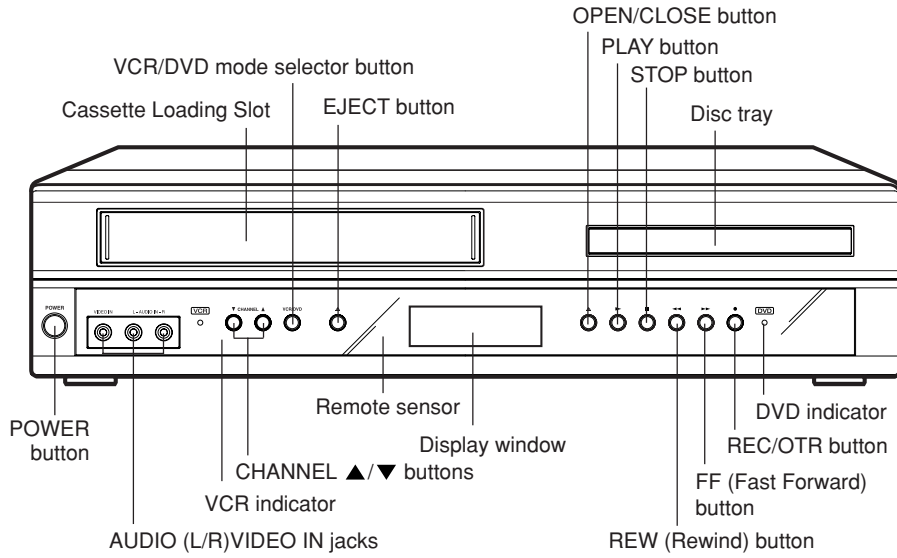

Display window

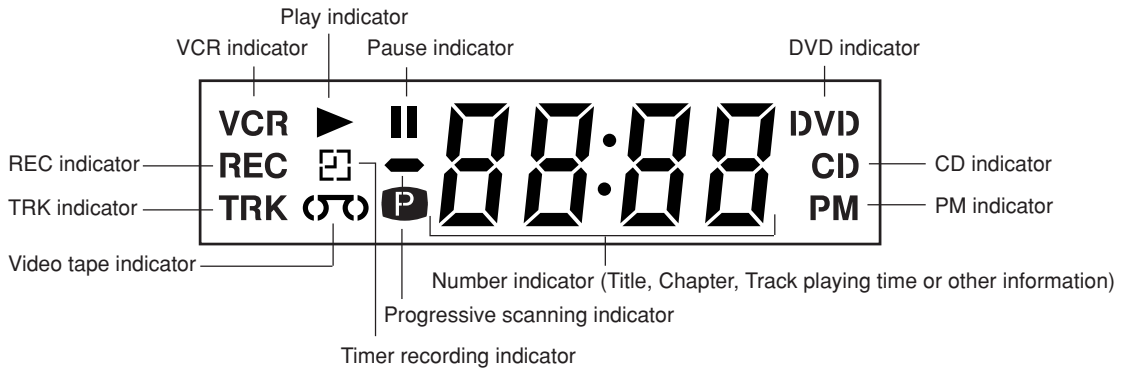

NOTE:

Some discs may be displayed wrong or e.g. chapter number, playback time, etc. may not be displayed.

Rear

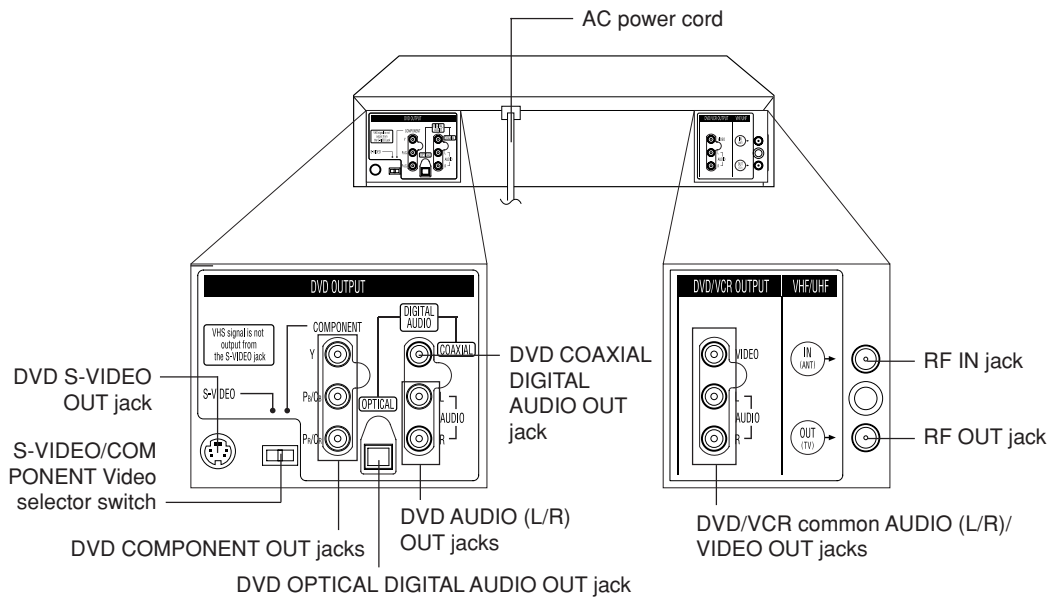



Remote control

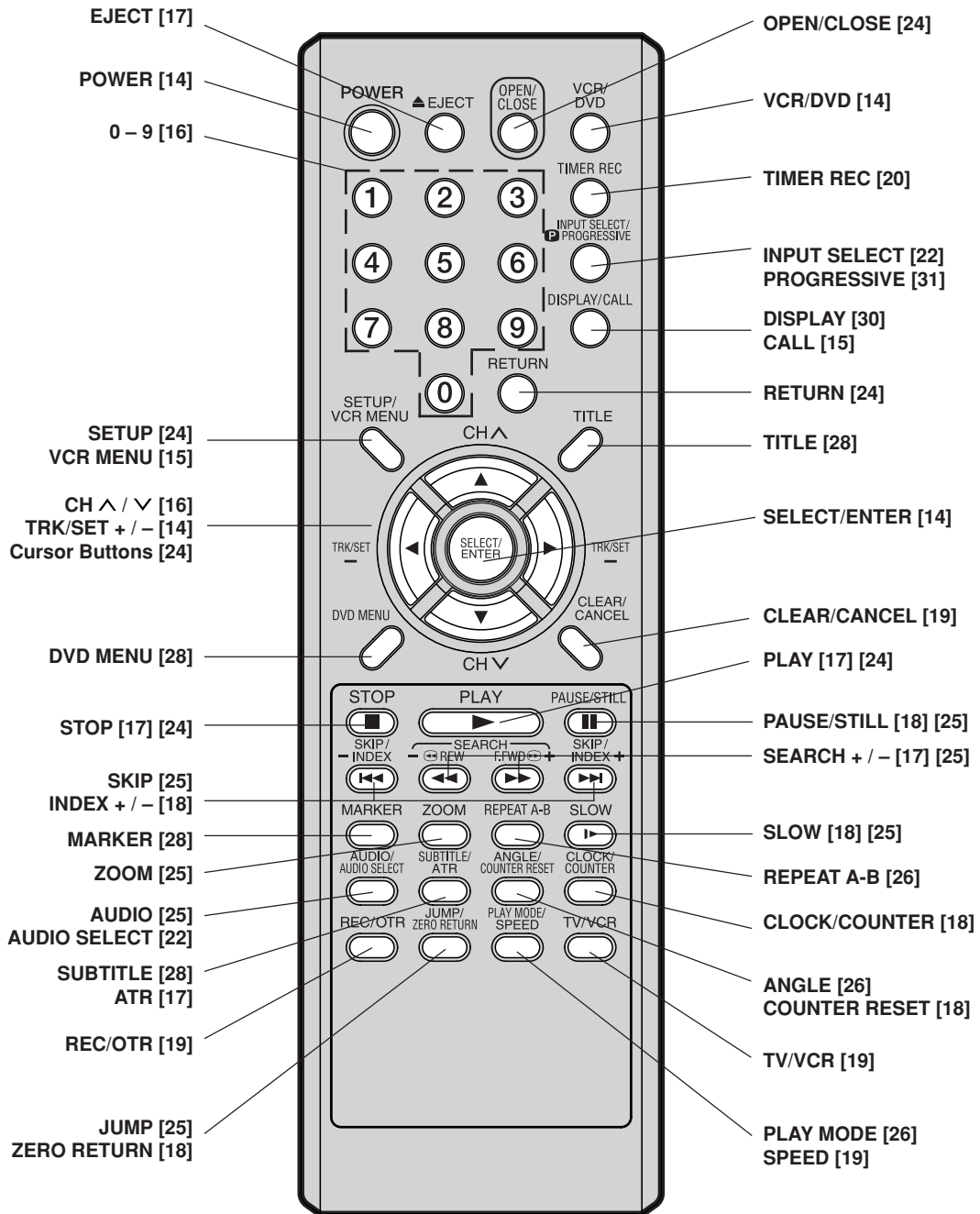



Remote control / Power source

Inserting Batteries

- 1 Open the battery compartment cover in the direction of the arrow.

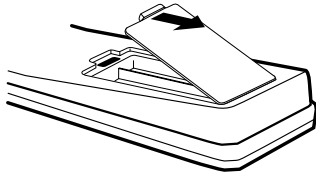

- 2 Install two "AAA" batteries (not supplied), paying attention to the polarity diagram in the battery compartment.

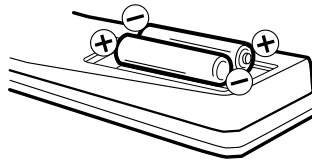

- 3 Replace the compartment cover.

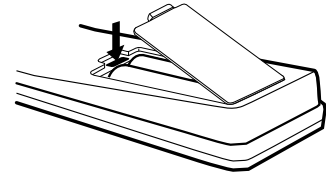

Battery precautions

The precautions below should be followed when using batteries in this device:

1. Use only the size and type of batteries specified.
2. Be sure to follow the correct polarity when installing the batteries as indicated in the battery compartment. Reversed batteries may cause damage to the device. To avoid a potential short circuit, insert the "-" end first.
3. Do not mix different types of batteries together (e.g. Alkaline and Carbon-zinc) or old batteries with fresh ones.
4. If the device is not to be used for a long period of time, remove the batteries to prevent damage or injury from possible battery leakage.
5. Do not try to recharge batteries not intended to be recharged; they can overheat and rupture. (Follow battery manufacturer's directions.)

Remote control basics

- Press **POWER** to turn the DVD/VCR on or off.
- Press **CH ^** or **CH v** to move through the channels one channel at a time.
- The **CH ^/v** and **SET +/-** are also used to navigate on-screen menu system.
- You can directly access specific channels using **Number keys** pad.
- Each press of **VCR/DVD** on the remote control, switches the screen between the VCR screen (VCR mode) and the DVD screen (DVD mode).

Operation

- Aim the remote control at the remote sensor and press control buttons to operate.
- Operate the remote control within 30° angle on either side of the remote sensor, up to a distance of Approx. 5 meters.

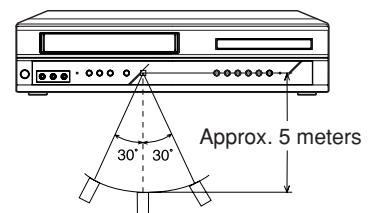

Power source

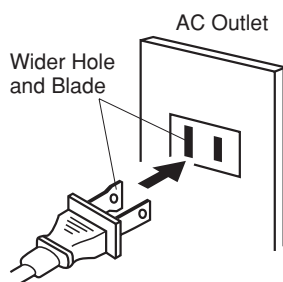

Polarized AC Cord Plug
(One blade is wider than the other.)

TO USE AC POWER SOURCE

Use the AC polarized line cord provided for operation on AC. Insert the AC cord plug into a standard 120V 60Hz polarized AC outlet.

NOTES:

- Never connect the AC line cord plug to other than the specified voltage (120V 60Hz). Use the attached power cord only.
- If the polarized AC cord does not fit into a non-polarized AC outlet, do not attempt to file or cut the blade. It is the user's responsibility to have an electrician replace the obsolete outlet.
- If you cause a static discharge when touching the unit and the unit fails to function, simply unplug the unit from the AC outlet and plug it back in. The unit should return to normal operation.





Basic connections

ANTENNA TO DVD/VCR CONNECTION

The DVD/VCR must be connected "between" the antenna and the TV. First, disconnect the antenna from the TV and connect it to the DVD/VCR. Then connect the DVD/VCR to the TV. Below are 3 common methods of connecting an antenna system to a DVD/VCR. Find the type of antenna system you are using and follow the connection diagram.

Example 1: Combination VHF/UHF antenna with 75 ohm coaxial cable

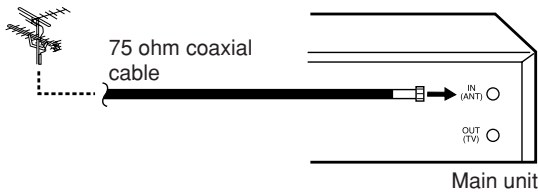

Example 2: Combination VHF/UHF antenna with 300 ohm twin lead (flat) wire

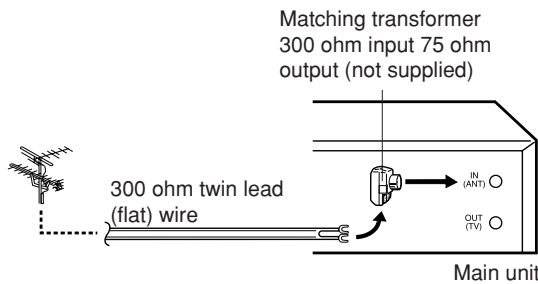

Example 3: Separate VHF and UHF antennas

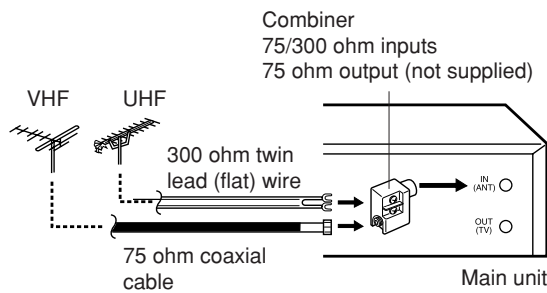

NOTE:
If both VHF and UHF antennas have 300 ohm twin lead (flat) wires, use a combiner having two 300 ohm inputs and one 75 ohm output.

- NOTES:**
- A clear picture will not be obtained by the main unit unless the antenna signal is good. Connect the antenna to the main unit properly.
 - For better quality recording, an indoor antenna or a telescopic antenna is not recommended. The use of an outdoor type antenna is required.
 - If you are not sure about the connection, please refer to qualified service personnel.

DVD/VCR TO TV CONNECTION

After you have connected the antenna to the DVD/VCR, you must connect the DVD/VCR to the TV.

Below are 3 common methods of connecting your DVD/VCR to a TV. Find the type of TV you are using and follow the connection diagram.

This DVD/VCR has a single 75 ohm output for connection to a TV. If your TV has separate VHF and UHF antenna inputs (numbers 2 and 3 below), use a splitter to connect the DVD/VCR to the TV for VHF and UHF reception.

Example 1: TV with single 75 ohm VHF/UHF antenna input

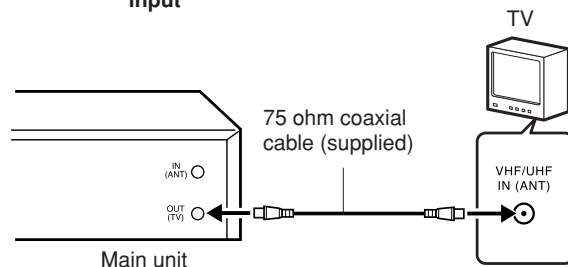

NOTE:
If a VHF or UHF antenna is used, set the TV/CABLE menu option to the "TV" mode. (See "TV/CABLE selection" on page 11.)

Example 2: TV with 300 ohm UHF and 75 ohm VHF antenna inputs

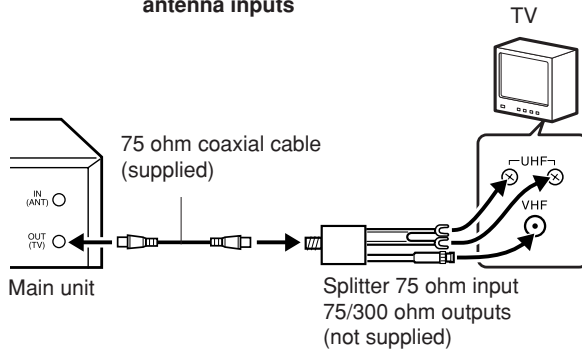

NOTE:
If a VHF or UHF antenna is used, set the TV/CABLE menu option to the "TV" mode. (See "TV/CABLE selection" on page 11.)

Example 3: TV with 300 ohm UHF and 300 ohm VHF antenna inputs

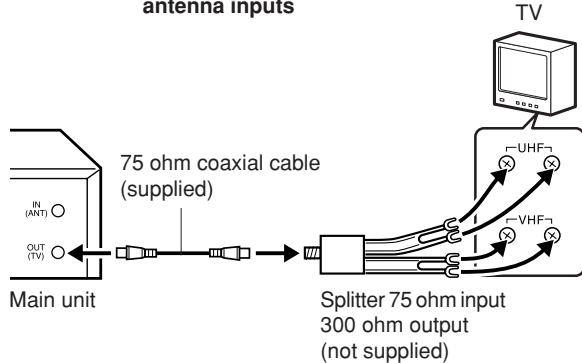

NOTE:
If a VHF or UHF antenna is used, set the TV/CABLE menu option to the "TV" mode. (See "TV/CABLE selection" on page 16.)





CABLE TV connections

Many cable companies offer services permitting reception of extra channels including pay or subscription channels. This DVD/VCR has an extended tuning range and can be tuned to most cable channels without using a cable company supplied converter box, except for those channels which are intentionally scrambled. If you subscribe to a special channel which is scrambled, you must have a descrambler box for proper reception.

Example 1:

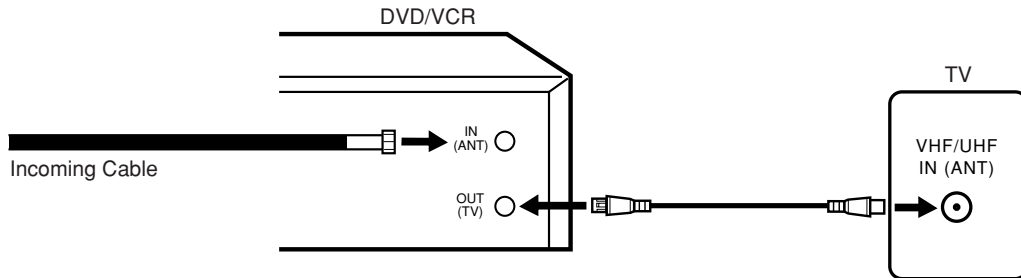

- ALLOWS:**
- * Recording of nonscrambled channels.
 - * Use of the programmable timer.
 - * Recording of one channel while watching another.

Example 2:

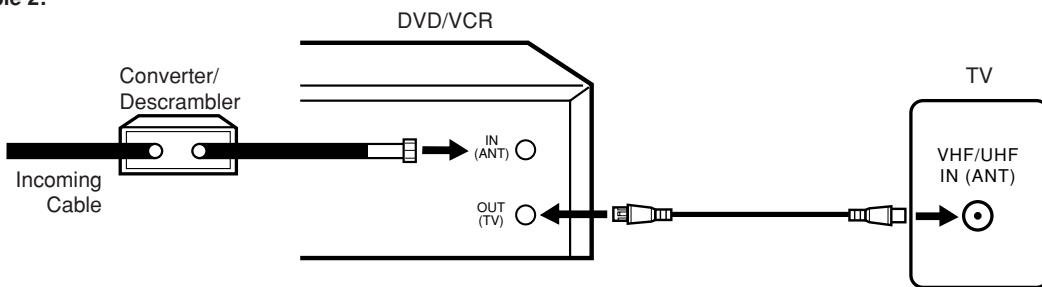

- ALLOWS:**
- * Recording of channels through the converter box (scrambled and unscrambled).
 - * Using the programmable timer to record only the channel selected at the converter box.

- PREVENTS:**
- * Recording one channel while watching another.
 - * Using the DVD/VCR tuner to select channels.

NOTE:

To record from converter/descrambler, DVD/VCR tuner must be tuned to the converter output channel, usually channel 3 or 4.

Example 3:

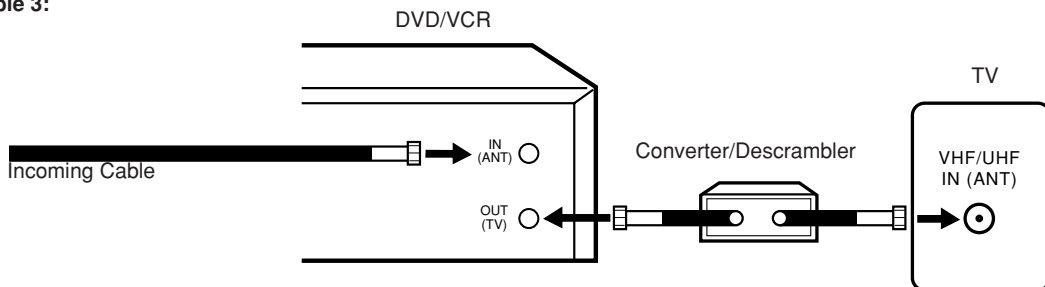

- ALLOWS:**
- * Recording of nonscrambled channels.
 - * Use of the programmable timer.
 - * Recording an unscrambled channel while watching any channel selected at the converter box.

- PREVENTS:** Recording scrambled channels.

NOTE:

If you are playing a tape or using the tuner built into the DVD/VCR, the converter must be set to the video channel output of the DVD/VCR (either 3 or 4).

NOTE: Whenever a Converter/Descrambler box is placed before the DVD/VCR, you must tune the DVD/VCR to the output of the Converter/Descrambler box, usually channel 3 or 4.





Playback connections

The exact arrangement you use to interconnect various video and audio components to the DVD/VCR is dependent on the model and features of each component. Check the Owner's Manual provided with each component for the location of video and audio inputs and outputs.

Connect to a TV with Audio/Video Output

You can enjoy playback by connecting the unit to a TV.

Connect the unit to a TV equipped with audio input (L/R) and video input jacks using the supplied audio/video cable.

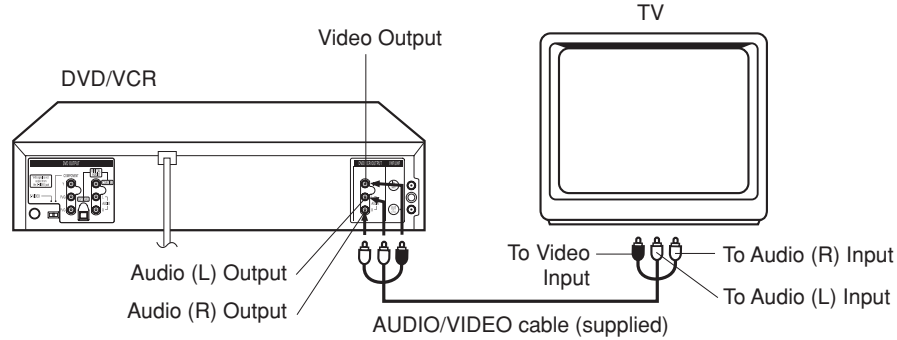

Connect to a TV with S-Video Output (for DVD/CD playback)

If your TV has an S-VIDEO input, you can get higher quality by connecting it with the S-VIDEO output of the unit using the S-video cable instead of connecting the video input of the TV to the VIDEO jack of the unit.

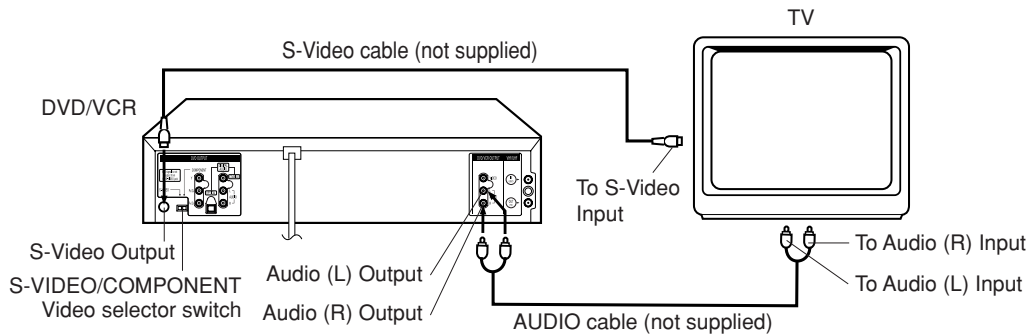

Connect to a TV with Component Video Output (for DVD/CD playback)

You can enjoy high quality picture by connecting the unit's COMPONENT VIDEO OUT jacks to the COMPONENT VIDEO IN jacks of your TV with the COMPONENT video cables (not supplied).

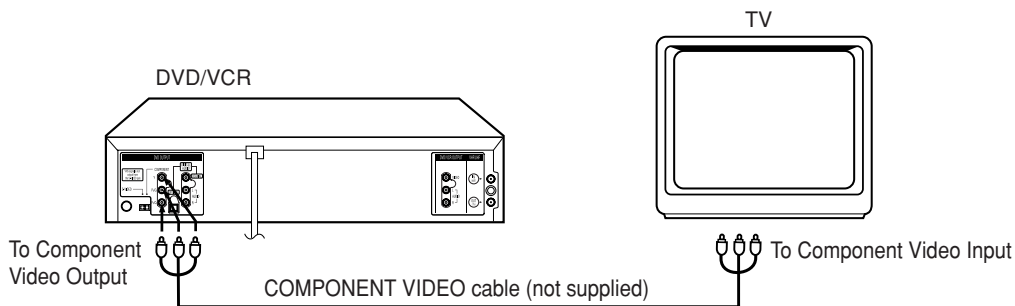

NOTES:

- When you connect to a TV with S-video jack or component jacks, set the S-VIDEO/COMPONENT Video selector switch to the desired position. And also you must select the corresponding video input on your TV.
- When connecting to a TV using the VIDEO or S-VIDEO jack, make sure that the PROGRESSIVE indicator on the display window is not lit. If it is lit, the VIDEO and S-VIDEO outputs do not feed the correct signals and you cannot see any picture. To turn off the PROGRESSIVE indicator, make the Progressive scanning mode inactive (see page 31).
- When the component video input jacks on a TV is of the BNC type, use an adapter to convert a pin jack to a BNC jack (not supplied).





Playback connections

Connect to a Stereo Amplifier with Audio Output

You can enjoy high quality audio by connecting the audio output to your amplifier.
Connect the AUDIO OUT jacks to any line-level inputs (such as AUX, DVD, CD, etc.) of an audio amplifier.

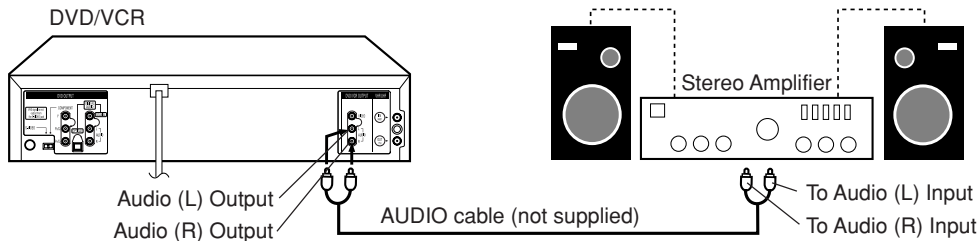

Connect to an AV Amplifier with built-in digital surround

If you are using an Amplifier with a built-in digital surround as follows, you can enjoy the various audio systems such as Dolby Digital and DTS by using the Optical or Coaxial Digital Output.

Use this connection to connect an:

- AV amplifier with built-in *Dolby Digital decoder
- AV amplifier with built-in *DTS decoder

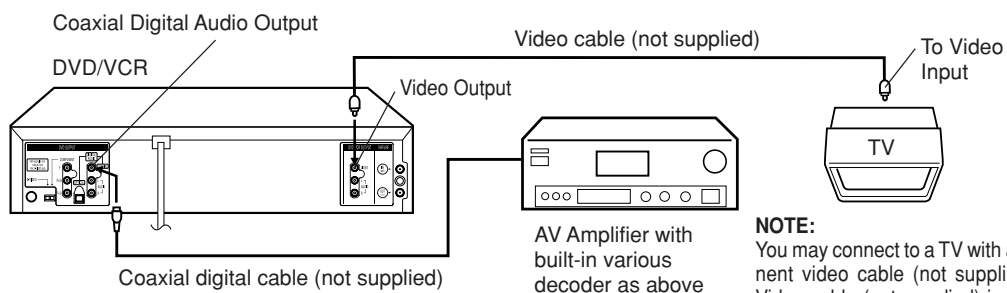

NOTE:
You may connect to a TV with a Component video cable (not supplied) or S-Video cable (not supplied) instead of a video cable (not supplied).

Connecting the optical digital cable

You may connect to an AV Amplifier with an Optical digital cable (not supplied) instead of a Coaxial digital cable.

When you connect the optical digital cable (not supplied), remove the dust protection cap from the rear panel.
When not using the optical digital cable, attach the dust protection cap to protect against dust.

NOTES:

- The DVD OUTPUT jacks (OPTICAL, COAXIAL, AUDIO L/R, S-VIDEO and COMPONENT) are useful only for DVD section.
- The VHS signal is output only from the composite jacks (DVD/VCR OUTPUT) and UHF/VHF OUT.
- When you make the connections above, do not set DOLBY DIGITAL to DOLBY DIGITAL or DTS to ON on the AV Amplifier. If you do, a loud noise will suddenly come out from the speakers, affecting your ears or causing the speakers to be damaged.
- Caution for the **optical** digital audio output connector: Do not connect to an amplifier (with an optical digital input connector) which does not contain a Dolby Digital or DTS decoder. Otherwise, any attempt to play DVDs may cause such a high level of noise that it may be harmful to your ears and damage your speakers.
- DTS audio will be output only from the COAXIAL or OPTICAL output. To hear DTS audio, DTS-Decoder is necessary.
- When playing DTS-encoded CDs, only noise will be heard from the speakers or analogue stereo outputs.
Some DTS decoders which do not support DVD-DTS interface may not work properly with the unit.





Setting the video channel

To view playback of a recorded tape or DVD disc, or to watch a program selected by the VCR's channel selector, the TV must be set to channel 3 or 4 (video channel).

When a TV is connected with the 75 ohm coaxial cable only.

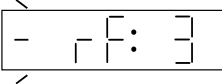
- 1 Press and hold **3** or **4** on the remote control for 3 seconds in the standby mode to select CH 3 or 4. The selected channel number will flash on the display for about 4 seconds. 
- 2 Turn ON the TV and set to CH 3 or 4 to correspond with the channel selected in step 1.
- 3 Press **POWER** to turn on the DVD/VCR.
- 4 Press **VCR/DVD** to select the VCR mode. The VCR indicator on the front panel will light.
- 5 Press **TV/VCR** to select the VCR position. The VCR indicator will appear in the display.
- 6 Select any channel to receive a TV station in your area. The channel number will appear on the screen for about 4 seconds.

For a push-button TV tuner

If CH 3 or 4 corresponding to the video channel cannot be tuned on your TV, proceed as follows: set the VCR 3/4 channel selector and the TV to CH 3 or 4, play back a prerecorded tape and tune the TV to receive a sharp color picture from the video cassette recorder. Refer to your TV owner's manual for details.

NOTES:

- When shipped from factory, the video channel is set to **CH 3**.
- If the unit does not operate properly, or No key operation (by the unit and/or the remote control): Static electricity, etc., may affect the player's operation. Disconnect the AC power cord once, then connect it again.

Setting the language

You can choose from three different languages (English, French and Spanish) for the on-screen displays.

- 1 Press **VCR MENU**. The VCR menu screen will appear. Press **SET +** or **-** to select the "SYSTEM SETUP" menu, then press **ENTER**.
If you use the unit for the first time and press **VCR MENU**, instead of the main menu screen on the right the "SYSTEM SETUP" menu screen in step 2 may appear.
- 2 Press **SET +** or **-** to select the "LANGUAGE" option, then press **ENTER**.

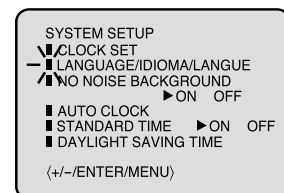
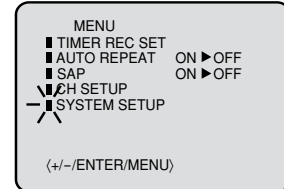

- 3 Press **SET +** or **-** to select the desired language: English (ENGLISH), Spanish (ESPAÑOL) or French (FRANCAIS), then press **ENTER**.



- 4 Press **VCR MENU** until the MENU screen is cleared.

NOTES:

- Both the VCR and the DVD have their own menu option (See page 23).
- If no buttons are pressed for more than 60 seconds, the MENU screen will return to normal TV-operation automatically.





Auto clock setting

The Auto Clock function will automatically set the built-in clock (Month, Day, Year and Time) when the TV/VCR is connected to an Antenna or Cable system and it is turned off. As the TV/VCR searches for a receivable station in your area and it receives a broadcast signal for Auto Clock, the Auto Clock needs several minutes to set itself.

- 1 Connect the Antenna or Cable system.
 - If you use a cable box, turn it on.
- 2 Plug the AC Power cord to the AC outlet.
- 3 Make sure the TV/VCR is turned off.
 - If you press **POWER**, the Auto Clock set is not effective.
- 4 Wait at least three minutes and press **POWER**.
- 5 Press **CALL** to check the clock on the screen.
- 6 If the clock is not set, check the Antenna condition. The Auto Clock may not function properly if the reception condition is not good.

Auto clock adjustment

The Auto Clock Adjustment will be performed at 12:00 PM everyday if you turn off the TV/VCR.

- If you use a cable box and you want Auto Clock adjustment to be performed, the cable box must be left on.
- The Auto Clock Adjustment is not effective when there is a difference of more than 5 minutes exists between the built-in clock time and the actual time.

To set auto clock to off

When shipped from factory the AUTO CLOCK option is set to ON.

But if you do not want Auto Clock set (Adjustment):

- 1 Turn on the TV/VCR.
- 2 Press **MENU**.
- 3 Press **▲** or **▼** to select the SYSTEM SET-UP option, then press the ENTER button.
- 4 Press **▲** or **▼** to select the AUTO CLOCK option.
- 5 Press **ENTER** to select OFF.
- 6 Press **MENU** repeatedly to return to the normal screen.
 - When the AUTO CLOCK is set to OFF, the Auto Clock adjustment does not function.
 - Set the clock manually (see page 16).

To set standard time

In the rare event that you live within broadcast range of two stations in two different time zones, the TV/VCR may recognize the wrong station for the Auto Clock set.

To correct the situation:

- 1 Press **MENU**.
- 2 Press **▲** or **▼** to select the SYSTEM SET-UP option, then press **ENTER**.
- 3 Press **▲** or **▼** to select the STANDARD TIME option, then press **ENTER**.

- 4 Press **▲** or **▼** to select your time zone, then press **ENTER**.

ATLANTIC	:	GMT - 4 hours
		(GMT: Greenwich Mean Time)
EASTERN	:	GMT - 5 hours
CENTRAL	:	GMT - 6 hours
MOUNTAIN	:	GMT - 7 hours
PACIFIC	:	GMT - 8 hours
ALASKA	:	GMT - 9 hours
HAWAII	:	GMT - 10 hours
AUTO	:	AUTO SET

- 5 Press **MENU** twice to return to the normal screen.

NOTES:

- To be able to select the standard time, the clock must first be set by "AUTO CLOCK" once.
- If you live in Newfoundland and the Auto Clock does not function properly, set the AUTO CLOCK menu option to OFF and set the clock manually.

Daylight saving time setting

You can set the Daylight saving time automatically or manually.

- 1 Press **MENU**. Press **▲** or **▼** to select the SYSTEM SET-UP option, then press **ENTER**.
- 2 Press **▲** or **▼** to select the DAYLIGHT SAVING TIME option, then press **ENTER**.
- 3 Press **▲** or **▼** to select one of the options, then press **ENTER**. Press **MENU** until the MENU screen is cleared.
 - ON:** for manual setting (forward one hour)
 - OFF:** for manual setting (back one hour)
 - AUTO:** for automatic setting (read XDS in the signal)

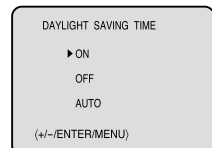
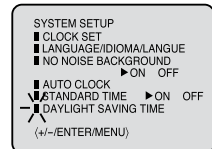
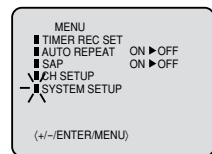

When you want to set the Daylight Saving Time manually, on the first Sunday in April you set to "ON", and on the last Sunday in October you set to "OFF".

NOTES:

- When shipped from factory, the DAYLIGHT SAVING TIME option is set to AUTO position.
- When the clock is not set, Daylight Saving Time setting is not available.
- When there is no Daylight Saving Time in your area, always select OFF position in step 3.



Manual clock setting

You must set the date and time manually for Timer Recordings, ON/OFF Timer and Daylight Saving Time if the Auto Clock process did not set them correctly.

EXAMPLE: Setting the clock to "8:30 AM", 30th (SAT) October, 2004.

- 1 Press **MENU**.
Press **▲** or **▼** to select the SYSTEM SETUP option, then press **ENTER**.
- 2 Press **▲** or **▼** to select the CLOCK SET option, then press **ENTER**.
- 3 Press **▲** or **▼** to set the month, then press **ENTER**.
- 4 Set the day, year and time as in step 3.

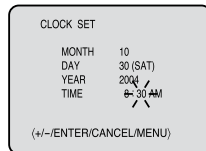
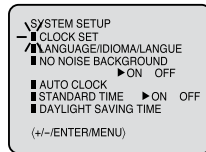
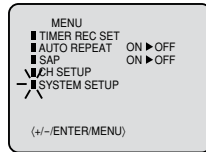

After setting the clock, date and time starts functioning automatically.

NOTES:

- After a power failure or disconnection of the power plug, the time display will be lost. In this case, set the present time again if the Auto Clock did not set correctly.
- To move cursor backward, press the CANCEL button.

Tuner setting

This TV/VCR is equipped with a channel memory feature which allows channels to skip up or down to the next channel set into memory, skipping over unwanted channels. Before selecting channels, they must be programmed into the TV/VCR's memory. In addition to normal VHF and UHF channels, this TV/VCR can receive up to 113 Cable TV channels. To use this TV/VCR with an antenna, set the TV/CABLE menu option to the TV mode. When shipped from the factory, this menu option is in the CABLE mode.

TV/CABLE selection

- 1 Press **MENU**.
Press **▲** or **▼** to select the CH SETUP mode, then press **ENTER**.
- 2 Press **▲** or **▼** to select the TV/CABLE mode.
- 3 Press **ENTER** to select the TV or CABLE mode.
The arrow indicates the selected mode.
- 4 Press **MENU** until the MENU screen is cleared.

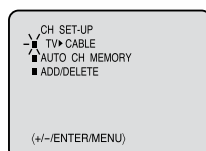
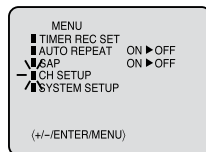

TV - VHF/UHF channels
CABLE - CABLE TV channels

Automatic memory tuning

- 1 Press **MENU**.
Press **▲** or **▼** to select the CH SETUP mode, then press **ENTER**.
- 2 Press **▲** or **▼** to select the AUTO CH MEMORY mode, then press **ENTER**. The TV/VCR will begin memorizing all the channels available in your area. Channel numbers will remain red until auto memorizing is complete.
- 3 Press **MENU** until the MENU screen is cleared.

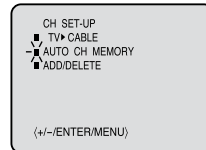

To add/delete channels

- 1 Press **MENU**.
Press **▲** or **▼** to select the CH SETUP mode, then press **ENTER**.
- 2 Press **▲** or **▼** to select the ADD/DELETE mode, then press **ENTER**.
- 3 Select the desired channel to be memorized or deleted using **TRK/SET +** or **-** button, or using **Direct Channel Selection buttons (0-9)**, or **CH ▲ / ▼**.
- 4 Press **ENTER** to select the ADD or DELETE.
If you select an unmemorized channel, the Channel indication will be red. If you select the ADD mode, the Channel indication changes from red to green and the channel will be memorized. If you select a memorized channel, the Channel indication will be green. If you select the DELETE mode, the Channel indication changes from green to red and the channel will be deleted from the memory.
- 5 Press **MENU** until the MENU screen is cleared.

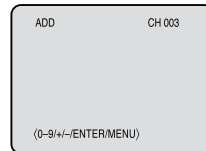
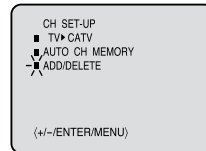

Noise elimination

When you don't want to receive a weak signal broadcast, the Blue back screen can be obtained by selecting the NO NOISE BACKGROUND "ON". When the unit is shipped from the factory, the NO NOISE BACKGROUND is set to the "ON".

- 1 In the SYSTEM SETUP menu, press **SET +** or **-** to select "NO NOISE BACKGROUND".
- 2 Press **ENTER** to select the "ON" position.
- 3 Press **VCR MENU** until the menu screen is cleared.

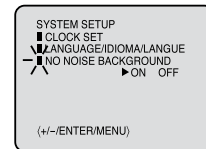



Loading and Unloading a cassette tape

Use only video cassette tapes marked **VHS**.

Loading

Push the center of the tape until it is automatically retracted into the TV/VCR.

Automatic power on and play

When loading a cassette tape without the erase prevention tab intact, the TV/VCR will turn on automatically and playback will start immediately.

Insert the cassette with its labeled side facing you. An inverted video cassette cannot be inserted.

Unloading

To unload a video cassette, press **EJECT** on the remote control, or press **STOP/EJECT** on the TV/VCR twice. The first press will stop the tape in any mode. The second press will eject the tape.

Automatic eject

If the TV/VCR automatically rewinds the tape to the beginning (AUTO REWIND FEATURE), the tape will be ejected automatically.

NOTES:

- Always eject the tape when not in use.
- The cassette tape can be ejected even if the POWER is "OFF".

To prevent accidental erasure

After recording, break off the erase prevention tab if you do not wish to record over the tape.

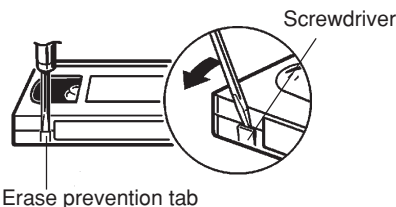

To record again

Cover the hole with adhesive tape. Be careful the tape does not extend past the edges of the video cassette housing.

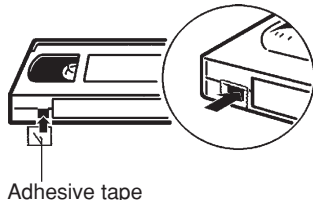

Tape Speed	Video cassette tape		
	T-160	T-120	T-60
SP (Standard Play)	2-2/3 hours	2 hours	1 hour
SLP (Super Long Play)	8 hours	6 hours	3 hours

Cassette tape playback

Load a prerecorded tape (When loading a cassette tape without the erase prevention tab, playback will start automatically).

To start playback

Press **PLAY** to begin playback.

"▶" will appear on the screen.

NOTE:

This TV/VCR selects the playback tape speed SP, LP or SLP automatically.

To stop playback

Press **STOP** once.

The tape will stop, but remain fully loaded and ready to play.

"■" will appear on the screen.

To rewind or forward the tape rapidly

Press **REW** or **F.FWD** in the Stop mode.

"◀" or "▶" will appear on the screen.

FORWARD/REVERSE PICTURE SEARCH

If you want to see the tape during REW or FWD mode, press and hold the **REW** or **F.FWD**. The backward or forward visual search picture will be seen on the screen. Release to return to the REW or FWD mode.

Special playback

Picture Search

Reverse picture search function

Press **REW** x 1 or x 2 during the playback.

Forward picture search function

Press **F.FWD** x 1 or x 2 during the playback.

To return to playback: Press **PLAY**.

SPEED SEARCH TIMES

TAPE SPEED	PICTURE SEARCH SPEED	
	PRESS ONCE	PRESS TWICE
SP (Standard Play)	3 X	5 X
LP (Long Play)	7 X	9 X
SLP (Super Long Play)	9 X	15 X

Still Picture

Press **PAUSE** during playback. To resume normal playback: Press **PLAY**.



Slow Motion

During playback press **SLOW**.
To return to playback: Press **PLAY** or **SLOW**.

Slow tracking and vertical lock adjustment

If noise bars appear in the picture during slow motion, press the **TRACKING +** or **-** to reduce the noise bars.
If the still picture jitters excessively, press **TRACKING +** or **-** to stabilize the still picture.

Frame by Frame picture

Press **PAUSE** during playback.
Press **SLOW** one by one: The picture advances frame by frame.
To return to playback: Press **PLAY** or **PAUSE**.

Adjusting tracking condition

Automatic tracking adjustment

Whenever you insert a tape and start playback, automatic tracking starts working and continuously analyzes the signal to enable optimum picture quality during playback.

Repeat playback

The entire video tape will be played until its end. The tape will then automatically rewind to the beginning and the playback will be repeated.

- 1 Press **VCR MENU**. Press **SET +** or **-** to select **AUTO REPEAT**.
- 2 Then press **ENTER** to select "ON" or "OFF".
If "ON" is selected, the playback will be repeated endlessly.
- 3 Press **VCR MENU** until the menu screen is cleared. if you press **CALL**, "⏪" will appear on the screen.
- 4 To start the playback, press **PLAY**.
The playback will be repeated endlessly.

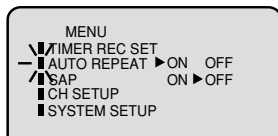

To cancel repeat mode:



Follow the above step 1, then press **ENTER** to select the OFF position. Press **VCR MENU** to return to the TV.

NOTES:

- The audio output is muted during **SPEED SEARCH**, **STILL**, **FRAME ADVANCE** and **SLOW MOTION**.
- During picture search mode there will be noise bars which are caused by the system.
- The Special Playback will automatically change to playback after approx. 5 minutes to protect the video tape against excessive wear.

ZERO RETURN function

This function makes tape-rewinding stop at the counter **00:00:00** position automatically.

- 1 Press **CALL**.
The counter display shows the tape running time during playback or recording. 
- 2 Press **COUNTER RESET** at the desired tape position. The counter display will be reset to the "00:00:00" position (e.g. the beginning of recording). 
- 3 Press **STOP** when playback or recording is finished. Press **ZERO RETURN**.
The tape will be rewinded or fast forwarded and automatically stop at the "00:00:00" position.

The CLOCK/COUNTER-button

Press **CLOCK/COUNTER**. The clock and tape counter alternate with each other in the display.

Video index search system

This function enables you to locate the beginning of any recording made on the VCR.

Recording an INDEX MARK

The Index Search function automatically records an INDEX mark on the tape whenever a recording is initiated.

Index Search

Press **INDEX▶▶▶** or **◀◀◀** during stop or play mode.
For Succeeding programs: Press **INDEX▶▶▶**.
For Preceding programs: Press **INDEX◀◀◀**.
(Additional press increases the INDEX NO. up to 9.)
When the **INDEX▶▶▶** or **◀◀◀** is pressed, the unit starts searching the INDEX NO. selected and finds the portion, then playback starts automatically.
To stop the Index Search, press **STOP**.

NOTES for Counter Display:

- If you rewind the tape beyond "00:00:00", a minus sign ("—") will be displayed in front of the time.
When you load a tape, the counter will reset to "00:00:00".
- The counter does not function on nonrecorded (blank) sections of the tape. When you rewind, fast forward or play tapes through blank sections, the counter stops.

NOTES for Video index search system:

- When you record an INDEX mark at the very beginning of the tape, the mark may not be found.
- During INDEX search, the tape may stop and begin to play at a slightly different location.
- INDEX may not function properly with old or worn out video tapes.
- INDEX marks may not be found if it is extremely close to the point where the search began.
- In recording, if you stop recording temporarily, the INDEX mark is not recorded on the tape.



Recording a TV program

Recording and viewing the same TV program.

- 1 Load a cassette tape with the erase prevention tab intact. The VCR will automatically turn on.
- 2 Press **SPEED** to select the desired tape speed SP or SLP. The tape counter and SP or SLP will appear on the screen for about 4 seconds.
- 3 Set the TV/CABLE option to the appropriate position (See page 16).
- 4 Press **Number keys** or **CH** \wedge / \vee to select the channel to be recorded.
 - 1-9 Press **0** twice and then **1-9** as required. Example: To select 2, Press "002".
 - 10-12 Press **0** first and then the remaining 2 digits in order from left to right. Example: Press **012** for "12".
 - 13-99 Press 2 digits in order. Example: Press **22** for "22".
 - 100-125 Press the 3 digits in order. Example: Press **110** for "110".

VHF/UHF/CABLE CHANNELS

TV	CABLE
VHF 2-13	VHF 2-13
UHF 14-69	STD/HRC/IRC 14-36 (A) (W) 37-59 (AA) (WW) 60-85 (AAA) (ZZZ) 86-94 (86) (94) 95-99 (A-5) (A-1) 100-125 (100)(125) 01 (5A)

- 5 Press **REC/OTR**. "●" will appear on the screen for about 4 seconds and "REC" will appear on the display.

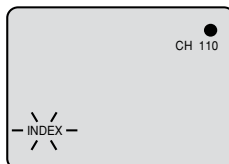

NOTES:

- If the erase prevention tab is removed, the tape will eject when **REC/OTR** is pressed for recording.
- If you wish to watch the DVD playback during the normal recording on VCR, press **VCR/DVD** to change to DVD mode and perform the DVD playback (see page 24).
- You can not record disc material in DVD, Audio CD, etc. onto a video tape with this DVD/VCR.

To stop recording

Press **STOP** to stop recording.
"■" will appear on screen for about 4 seconds.

To stop recording temporarily

Press **PAUSE/STILL** to avoid recording unwanted material.
"●||" will appear on screen for about 4 seconds.
Press again to continue the recording.

NOTES:

- The pause function will be released after 5 minutes to prevent damage to the tape or the VCR. The VCR will change to the STOP mode.
- You can select a recording channel in the recording pause mode.

Recording one program while watching another

While the VCR is recording, press **TV/VCR** to select the TV position. The "VCR" will go off and recording will continue. Select the TV channel you want to watch by using the TV channel selector.

NOTE:

Some CABLE hookups do not permit viewing one channel while recording another. See page 11.

To Display VCR operation Status

Press **CALL**. The clock, day of the week and more information will be indicated.

While watching TV

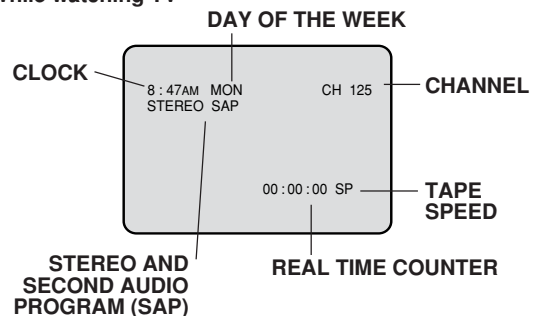

While operating a tape

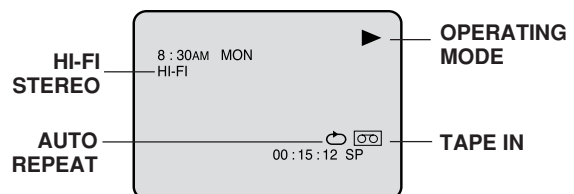

To cancel the display: Press **CALL** until all indicators disappear.

Auto Rewind feature

This VCR will automatically rewind the tape when the tape has ended (except during OTR and TIMER REC). It will also eject the tape.



One-touch Timer Recording (OTR)

The One-touch Timer Recording feature provides a simple and convenient way to make a timed recording.

Example: One-touch Timer Recording for 30 minutes.

- 1 Load a cassette tape with the erase prevention tab intact.
The VCR will automatically turn on.
- 2 Press **SPEED** to select the desired tape speed SP or SLP.
The tape counter and SP or SLP will appear on the screen for about 4 seconds.
- 3 Set the TV/CABLE option to the appropriate position.
- 4 Press **Number keys** or **CH** \wedge/\vee to select the channel to be recorded.
- 5 Press **REC/OTR**. Press the button again to stop recording after 30 minutes. Each additional press of **REC/OTR** will increase recording time as shown in the chart below, up to a maximum of 6 hours. The OTR and recording time will appear on the screen for about 4 seconds. And, REC will keep blinking in the display.

Press	Recording time	Press	Recording time
once	NORMAL REC	6 times	3:00
twice	0:30	7 times	4:00
3 times	1:00	8 times	5:00
4 times	1:30	9 times	6:00
5 times	2:00	10 times	NORMAL REC

To cancel OTR

Press **STOP** or turn off the power.

"■" will appear on screen for about 4 seconds.

NOTE:

If you wish to watch the DVD playback during the OTR, press **DVD/VCR** to change to DVD mode and perform the DVD playback (see page 24).

Timer recording

Timer recording can be programmed on-screen with the remote control. The built-in timer allows automatic unattended recording of up to 8 programs within 1 month.

Example: Program a timer recording for the 26th day, channel 125 (CABLE), 11:00 - 11:30 PM on timer program number 1 (Tape speed: SLP).

- 1 Press **VCR MENU**. Select the "TIMER REC SET" option, then press **ENTER**.
- 2 Press **SET +** or **-** to select one of the program line, then press **ENTER**.
- 3 Press **SET +** or **-** to select the date, then press **ENTER**.
- 4 Set the **start time**, **end time**, **channel** and **tape speed** as in step 3.

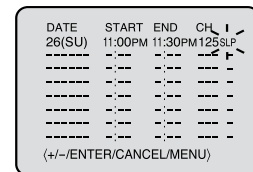
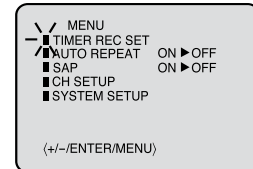

NOTES:

- Press **CANCEL** to move cursor backward for correction.
- To record from external source set the channel to "L". "L" will appear next to CH 125 (or 69).

- 5 To enter other programs, repeat step 2 through 4.
• To return to the normal screen, press **VCR MENU** twice.

- 6 Press **TIMER REC**. The clock symbol (⌚) will appear on the display and the VCR stands by for recording. At the same time, VCR mode will change to DVD mode automatically. You can use DVD even if the VCR is in the Timer recording mode.
If you do not use the DVD, turn the power off.
The timer recording will start at 20 seconds before the time you predetermined.

NOTES:

- If the clock symbol (⌚) does not appear on the display in spite of the pressing of **TIMER REC**, the cassette may not have been loaded yet. (see page 12)
- If the cassette is ejected in spite of the pressing of **TIMER REC**, the erase prevention tab of the cassette may have been removed. (see page 12)

NOTES:

- If the clock symbol (⌚) blinks when the timer recording ended, the TV program has not been completely recorded because of an insufficient tape supply. Press **TIMER REC** to cancel the timer program or press **EJECT** to remove the cassette tape.
- During timer recording standby mode, the VCR mode cannot be selected. To use the VCR, press **TIMER REC** at first, then press **VCR/DVD** to change to VCR mode. After you use the VCR, press **TIMER REC** again to put the VCR into timer recording standby mode.
- If you press **TIMER REC** during timer recording, the recording operation will be interrupted. If you press **TIMER REC** again within the programmed time, the recording operation will start again.
- After a power failure or disconnection of the power plug, all programmed recording settings and time display will be lost upon resumption of power. In this case, reset the clock (see page 15) and reprogram any timer recordings.



Timer recording special case

Weekly (e.g. WKL-TU: each Tuesday) or daily (e.g. MO-SA: Monday to Saturday) Timer recording

Follow the procedure of timer recording on the previous page. At picture 3 press **SET +** or **-** repeatedly until the desired setting appears. Then press **ENTER**.

When you press **SET -** repeatedly, the indicator at DATE will change as follows, in this case the day is Friday.

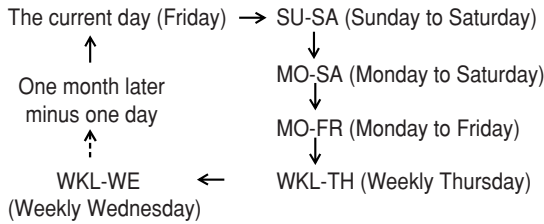

DATE	START	END	CH
WKL-WE	-:-	-:-	-:-
-:-	-:-	-:-	-:-
-:-	-:-	-:-	-:-
-:-	-:-	-:-	-:-
-:-	-:-	-:-	-:-
-:-	-:-	-:-	-:-
(+/-)/ENTER/CANCEL/MENU)			

In case Timer programs-overlap

- Do not overlap timer programs as portions of the conflicting programs will be lost. The first recording time has priority over the next recording time as shown in the diagram below.

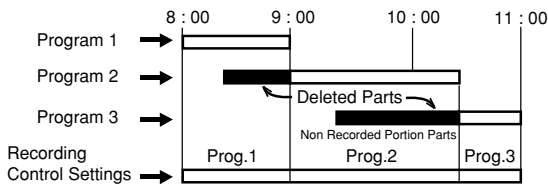

NOTES:

- The daily/weekly recording can be made continuously until the recording is canceled or the tape reaches the end.
- During timer recording the automatic rewinding mechanism does not function.

Confirmation / Cancellation of the Timer recording

1 If the Timer has been activated, press **TIMER REC** to deactivate the Timer. The clock symbol(🕒) will disappear. Then press **VCR/DVD** to change to VCR mode.

2 To confirm Timer program:

At picture 1 on the previous page select the "TIMER REC SET" option and press **ENTER**.

Then the timer program list as right will appear on the screen.

DATE	START	END	CH
26(SU)	11:00PM	11:30PM	125SLP
-:-	-:-	-:-	-:-
-:-	-:-	-:-	-:-
-:-	-:-	-:-	-:-
-:-	-:-	-:-	-:-
-:-	-:-	-:-	-:-
(+/-)/ENTER/CANCEL/MENU)			

3 To cancel Timer program:

Press **SET +** or **-** to select the unnecessary program, then press **CANCEL** to cancel the program.

DATE	START	END	CH
-:-	-:-	-:-	-:-
-:-	-:-	-:-	-:-
-:-	-:-	-:-	-:-
-:-	-:-	-:-	-:-
-:-	-:-	-:-	-:-
-:-	-:-	-:-	-:-
(+/-)/ENTER/CANCEL/MENU)			

4 Press **VCR MENU** repeatedly until the TV-picture appears.

NOTES:

- If there are other timer record programs remaining, **TIMER REC** must be pressed to reactivate the timer, otherwise the remaining timer record programs will be ignored.
- You cannot confirm the Timer program during timer recording operation.
- You can also correct the programmed setting in program confirm mode.

At step 2 above, press **ENTER** to enter the program input mode. Then press **ENTER** repeatedly until the item you wish to correct blinks. Then correct the data with **SET +** or **-**. Then press **VCR MENU** repeatedly until the TV-picture appears.

DATE	START	END	CH
26(SU)	11:00PM	11:30PM	125 SLP
-:-	-:-	-:-	-:-
-:-	-:-	-:-	-:-
-:-	-:-	-:-	-:-
-:-	-:-	-:-	-:-
-:-	-:-	-:-	-:-
(+/-)/ENTER/CANCEL/MENU)			



Stereo recording and playback

The VHS Hi-Fi audio system permits high fidelity recording of MTS STEREO TV broadcasts.

When a MTS STEREO broadcast is received, the word STEREO will appear on the screen and the program can be viewed or recorded in stereo.

STEREO

The Hi-Fi STEREO recording procedure is the same as for normal recordings.

NOTE:

When using a CABLE system, stereo TV programs may be transmitted over a mono cable channel. In this case the word "STEREO" will not appear and the sound will be in mono.

Output selection

When viewing an MTS STEREO TV program, or playing a prerecorded VHS Hi-Fi STEREO videotape, press **AUDIO SELECT** to select how the audio will be heard through the speakers. Normally set to the Hi-Fi STEREO position, this button can be set to the MONO position if the stereo broadcast or videotape audio is of poor quality. The "R" and "L" positions allow the audio from the Right or Left Hi-Fi channel to be heard over both TV speakers. This button has no effect when viewing a MONO videotape or TV program. Each time when you press the button, OUTPUT SELECTION display appears on the screen for several seconds. Refer to the chart below.

OUTPUT SELECTION	SOUND HEARD ON BOTH SPEAKERS
STEREO	STEREO
L ch	LEFT CHANNEL AUDIO
R ch	RIGHT CHANNEL AUDIO
MONO	MONO

Second Audio Program (SAP)

Your VCR is fitted with a SAP broadcast system which enables you to switch to a second audio program when viewing a selected channel.

This function applies only when the program is broadcast in multi-languages through the SAP broadcast system.

- 1 Press **VCR MENU**. Then press **SET +** or **-** to select "SAP".
- 2 Then press **ENTER** to select "ON".
- 3 Then press **VCR MENU** until the menu screen is cleared.

Listening to SAP

When the VCR is turned on or a channel selection is made, make certain the letters "SAP" appears on the screen. This means that the "Second Audio Program" broadcasting is available.

NOTES:

- When playing back a tape that is not recorded in Hi-Fi stereo mode, the audio will automatically be monaural.
- When listening to a VHS Hi-Fi video tape or MTS broadcast through the VHF/UHF jack (Audio/Video cord not connected), the sound will be monaural.

Duplicating a video tape

If you connect the VCR to another VCR or camcorder, you can duplicate a previously recorded tape.

Make all connections before turning on the power.

- 1 Load a blank cassette tape with the erase prevention tab intact into the recording VCR. Load a previously recorded tape into the playback VCR or CAMCORDER.
- 2 Press **SPEED** to select the desired tape speed SP or SLP. It is recommended that you set the Speed to the SP mode on the recording VCR for best results.
- 3 Press **INPUT SELECT** to select AUDIO/VIDEO input position. "L" will appear in the display.
- 4 Press **REC/OTR** on the recording VCR, then press **PAUSE/STILL**.
- 5 Press the **PLAY** button on the playback VCR or CAMCORDER, then press the **PAUSE/STILL** button.
- 6 Release the recording pause and the playback still simultaneously to begin the duplicating process.

Connection with second Video recorder

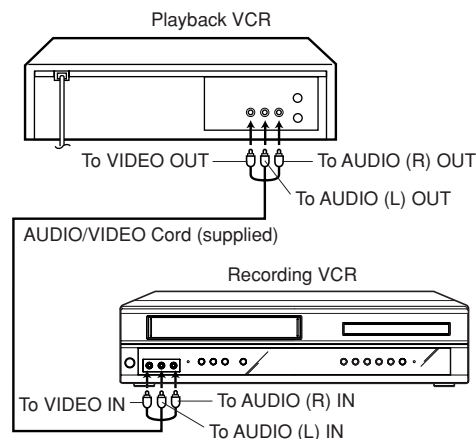

Connection with Video camera

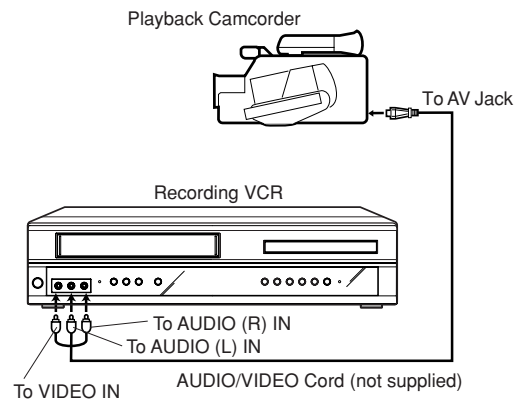



Disc

This unit applies to DVD discs from Region 1 or Region ALL. The loaded Disc (DVD, Audio-CD and MP3-CD) will be recognized automatically. The suitable Disc-formats are: DVD, CD-R and CD-RW. Some CD-R/RW discs may be incompatible.

Do not play DVD-ROM, DVD-Audio, CDV, Video-CD, CD-G or Photo CD to prevent accidental erasure of prerecorded material.

This unit cannot record disc material in DVD, Audio CD etc. onto a video tape.

If you press the REC/OTR during DVD playback, a symbol mark "Ⓢ → ❌" will appear on the screen for approx. 4 seconds.

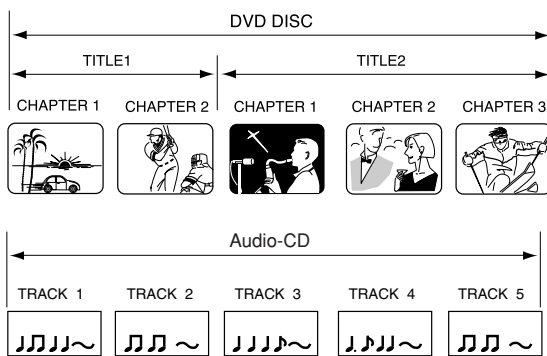

Title

When two or more movies are recorded on a disc, the disc is divided into two or more sections. Each section is called a "TITLE".

Chapter

The titles can be subdivided into many sections. Each section is called a "CHAPTER".

Track

An Audio CD can contain several items. These are assigned to the tracks.

Removing Disc from Case

Be sure to hold the edge of disc. Do not touch the surface of the disc. Pick up the disc gently from the case.

- Do not scratch the disc.
- Do not get dirt on the surface of the disc.
- Do not stick a label or adhesive tape on the disc.
- Do not drop or bend the disc.

Storing Disc

- Store the disc in the case to avoid risk of scratches, dirt or damage.
- Do not leave disc exposed to direct sunlight or in hot or humid places.

Cleaning Disc

Wipe the disc with a clean, dry cloth from center to edge.

- Do not wipe the disc round.
- Do not use liquid or aerosol cleaners.

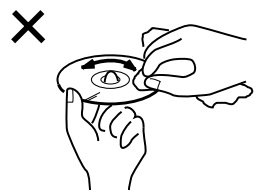
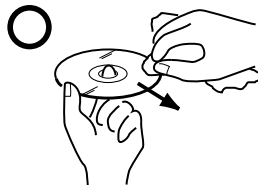

Setting setup language

The setup language can be selected.

- 1 Press **VCR/DVD** to select the DVD mode. (The DVD indicator will light) "No Disc" will appear on the screen. (If a DVD disc has already loaded, the playback will start automatically.)



- 2 Press **SETUP** in the stop mode. The SETUP MENU of DVD will appear on the screen. Then press **▶** to select Other.

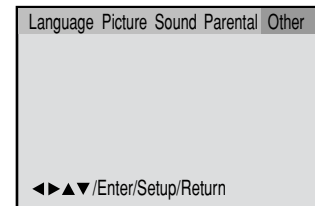

- 3 Press **▼** or **ENTER** to select OSD Language.

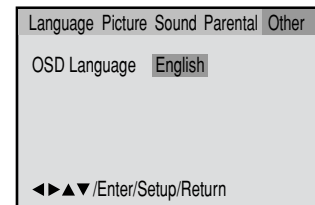

- 4 Press **▶** or **ENTER** and then press **▲** or **▼** to select desired language (e.g. English), then press **ENTER**.

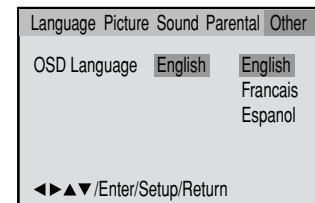

NOTE: To make the SETUP screen disappear, press **SETUP** (or **RETURN**).

If the DVD/VCR does not operate properly: Static electricity, etc., may affect the player's operation. Disconnect the AC power cord once, then connect it again.



Playback procedure

- 1 Press **OPEN/CLOSE**.
The disc tray will open.
- 2 Place a disc onto the tray.
Hold the disc, position it with the printed label side up, align it with the guides, and place it in its proper position.
- 3 Press **PLAY** or **OPEN/CLOSE**.
The disc tray closes automatically.
On the screen, changes to "Reading" and then playback will commence.
 - A menu screen may appear on the TV screen, if the disc has a menu feature. In this case, press , , , or **ENTER** to operate a menu feature.
- 4 Press **STOP** to end playback.
 - The DVD/VCR memorizes the stopped point, depending on the disc. appears on the screen. Press **PLAY** to resume playback (from the scene point).
 - If you press **STOP** again (appears on the screen) or unload the disc, the DVD/VCR will clear the stopped point.
- 5 Then press **OPEN/CLOSE**.
The disc tray opens.
Remove the disc and press **POWER**.
The disc tray closes automatically and DVD/VCR turns off.

NOTES:

- If a non-compatible disc is loaded, "Incorrect Disc", "Region Code Error" or "Parental Error" will appear on the TV screen according to the type of loaded disc. In this case, check your disc again (See page 23).
- Some discs may take a minute or so to start playback.
A "Prohibition" symbol may appear at the upper left of the screen. This symbol means either the feature you tried is not available on the disc, or the DVD/VCR can not access the feature at this time. This does not indicate a problem with the DVD/VCR.
- When you set a single-faced disc label downwards (ie. the wrong way up) and press **PLAY** or **OPEN/CLOSE**, "Reading" will appear and remain on the screen for approx. 40 seconds and then it will change to "Incorrect Disc".
- Some playback operations of DVDs may be intentionally fixed by software producers. Since this DVD/VCR plays DVDs according to the disc contents the software producers designed, some playback features may not be available. Also refer to the instructions supplied with the DVDs.
- When playing DTS-encoded Audio CDs, excessive noise will be heard from the analog stereo outputs. To avoid possible damage to the audio system, the consumer should take proper precautions when the analog stereo outputs of the DVD/VCR are connected to an amplification system.

Special playback

There may be a slight delay between pressing the button and the function activation.

Fast Forward Playback

Press **F.FWD** during normal playback.
Each press of **F.FWD** will increase the speed of the search (x2), (x4), (x8), (x20).

- To resume normal playback, press **PLAY**.

Review Playback

Press **REW** during normal playback.
Each press of **REW** will increase the speed of the search (x2), (x4), (x8), (x20).

- To resume normal playback, press **PLAY**.

Still Playback

Press **PAUSE/STILL** during normal playback.

To resume normal playback, press **PLAY**.

Frame Advance

Press **PAUSE/STILL** during still playback.
One frame is advanced each time you press **PAUSE/STILL**.

To resume normal playback, press **PLAY**.

Slow-motion Playback

Press **SLOW** during normal playback or still playback.
Each press of **SLOW** will change the speed of the slow x1/2, x1/4, x1/6, x1/7.

Locating a chapter or track

Press **SKIP** () Forward or **SKIP** () Reverse during playback to locate a chapter that you want to watch.
Each time you press the button, a chapter or track is skipped.

- To resume normal playback, press **PLAY**.
- To resume the still playback, press **PAUSE/STILL**.

NOTE:

The unit is capable of holding a still video image or On screen display image on your television screen indefinitely. If you leave the still video image or On screen display image displayed on your TV for an extended period of time, you risk permanent damage to your television screen. Projection televisions are very susceptible.

Zooming

This unit will allow you to zoom in on the frame image. You can then make selections by switching the position of the frame.

- 1 Press **ZOOM** during playback.
The center part of the image will be zoomed in.
Each press of **ZOOM** will change the ZOOM 1 (x 1.3), 2 (x 1.5) and 3 (x 2.0).
- 2 Press / or / to view a different part of the frame.
You may move the frame from the center position to UP, DOWN, LEFT or RIGHT direction.
- 3 In the zoom mode press **ZOOM** repeatedly to return to a 1:1 view (Off).



Locating desired scene

Use the title, chapter and time recorded on the disc to locate the desired point to play back.

To check the title, chapter and time, press **DISPLAY**. (see page 30)

- 1 Press **JUMP** during playback or stop mode.
- 2 Press **▲** or **▼** to select the "Time", "Title" or "Chapter".
- 3 Press **Number keys** to change the number.
 - If you input a wrong number, press **CANCEL**.
 - Refer to the package supplied with the disc to check the numbers.
- 4 Press **ENTER**. Playback starts.
 - When you change the title, playback starts from Chapter 1 of the selected title.
 - Some discs may not work in the above operation.

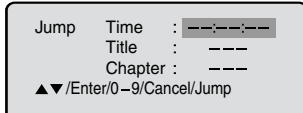

NOTE:

You can use the Pause, Slow, Search or Skip feature in the zoom mode.

Title Selection

Two or more titles are recorded on some discs. If the title menu is recorded on the disc, you can select the desired title.

- 1 Press **TITLE** during playback. Title menu appears on the screen.
 - Press **TITLE** again to resume playback at the scene when you pressed **TITLE**.
- 2 Press **▲/▼** or **◀/▶** to select the desired title.
- 3 Press **ENTER** or **PLAY**. The playback of the selected title will start.

Marking desired Scenes

The unit stores the points that you want to watch again up to 3 points. You can resume playback from each scene.

Marking the Scenes

- 1 Press **MARKER** during playback.
- 2 Select the blank Marker using **▲/▼**. Then press **ENTER** at the desired scene.
 - Repeat this procedure to set the other 2 scenes.
- 3 Press **MARKER** to remove this display.

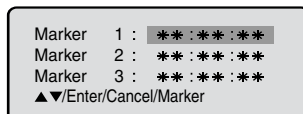

Returning to the Scenes

- 1 Press **MARKER** during playback or stop mode.
- 2 Press **▲/▼** to select the Marker 1-3.
- 3 Press **ENTER**. Playback starts from the marked scene.

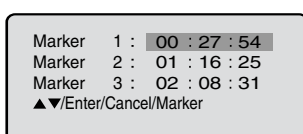

To Cancel the Mark

- 1 Press **MARKER**.
- 2 Press **▲/▼** to select the Marker 1-3.

- 3 Press **CANCEL**. To remove this display, press **MARKER**.

NOTES:

- Some discs may not work with the marking operation.
- The marking is canceled when you open the disc tray or turn the power off.
- Some subtitles recorded around the marker may fail to appear.

Changing soundtrack language

You can select the language when you play a multilingual disc.

- 1 Press **AUDIO** during playback. The current soundtrack language will appear.
- 2 Press **AUDIO** repeatedly until the desired language is selected. The on-screen display will disappear after a few seconds.

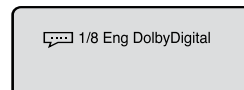

Subtitles

Turning the Subtitles On and Off

When playing back a disc recorded with subtitles, you can turn the subtitles on or off.

Press **SUBTITLE** during playback until "Off" appears.

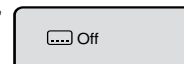

Changing the subtitle language

You can select the language when playing back a disc recorded with multi-lingual subtitles.

Press **SUBTITLE** repeatedly during playback until your desired language appears. The on-screen display will disappear after a few seconds.

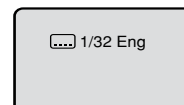

NOTES:

- If the desired language is not heard after pressing the button several times, the language is not recorded on the disc.
- Changing soundtrack or subtitle language is cancelled when you open the disc tray or turn the power off. The initial default language or available language will be heard and seen if the disc is played back again.
- Depending on the DVD you may be unable to turn on, turn off, or change the subtitles, even if they are recorded on the disc. While playing the DVD, the subtitle may change while opening or closing the disc tray, or while changing the title.
- In some cases, the subtitle language is not changed to the selected one immediately.

Karaoke playback

When playing back a DVD KARAOKE disc, you can turn the vocal on or off.

- 1 Press **AUDIO** during DVD KARAOKE disc playback.
- 2 Press **◀** or **▶** to select "On" or "Off".
 - On:** The primary vocal is output when it is recorded on the disc.
 - Off:** The primary vocal is not output.

NOTES:

- The vocal output feature is used during playback of Dolby Digital (multi-channel) recorded DVD KARAOKE discs. This feature allows you to turn off vocal audio tracks, or restore them for background accompaniment.
- When playing KARAOKE, connect appropriate audio equipment such as an amplifier to the DVD/VCR.



Changing Angles

When playing back a disc recorded with multi-angle facility, you can change the angle that you are viewing the scene from.

- 1 Press **ANGLE** during playback.
The current angle will appear.

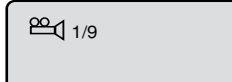

- 2 Press **ANGLE** repeatedly until the desired angle is selected.

NOTE:

Depending on the DVD, you may not be able to change the angles even if multi-angles are recorded on the disc.

Title Selection

Two or more titles are recorded on some discs. If the title menu is recorded on the disc, you can select the desired title.

- 1 Press **TITLE** during playback.
Title menu appears on the screen.
 - Press **TITLE** again to resume playback at the scene when you pressed **TITLE**.
- 2 Press **▲/▼** or **◀/▶** to select the desired title.
- 3 Press **ENTER** or **PLAY**.
The playback of the selected title will start.

DVD Menu

Some DVDs allow you to select the disc contents using the menu. When you play back these DVDs, you can select the subtitle language and soundtrack language, etc. using the DVD menu.

- 1 Press **DVD MENU** during playback.
The DVD menu appears on the screen.
 - Press **DVD MENU** again to resume playback at the scene when you pressed **DVD MENU**.
- 2 Press **▲/▼** or **◀/▶** to select the desired item.
- 3 Press **ENTER**. The menu continues to another screen. Repeat steps 2 and 3 to set the item completely.

NOTE:

Depending on the DVD, you may be unable to select the title, and a "title menu" may simply be called a "menu" or "title" in the instructions supplied with the disc.



Repeat playback

Title, Chapter, Track Playback

- 1 Press **PLAY MODE** during playback or stop mode.

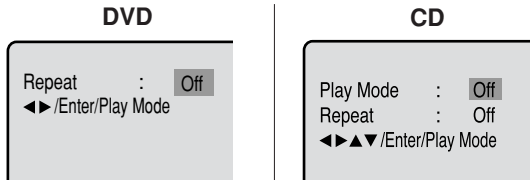

- 2 Press **ENTER** once or twice to select "Chapter" or "Title".
In case of CD, at first press **▼** to select "Repeat" and then press **ENTER** once or twice to select "Track" or "All".

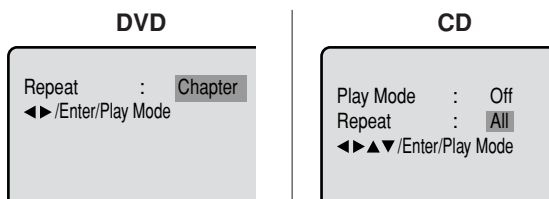

- 3 Press **PLAY MODE** again to make the screen disappear.

- Press **PLAY** to start Repeat playback.
- To resume normal playback, select Repeat Off.

A-B Repeat Playback

A-B repeat playback allows you to repeat material between two selected points.

- 1 Press **REPEAT A-B** during playback.
The start point is selected.



- 2 Press **REPEAT A-B** again.
The end point is selected.
Playback starts at the point that you selected.
Playback stops at the end point, returns to Point A automatically, then starts again.

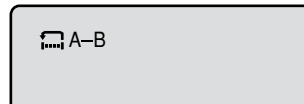

To resume normal playback press **REPEAT A-B** again.

"**Off**" appears on the screen.

NOTES:

- Some discs may not work with the repeat operation.
- In A-B repeat mode, subtitles near point A or B may not appear.
- During the A-B Repeat Playback the ANGLE feature will not operate.
- You may not be able to set A-B Repeat, depending on the scenes of the DVD.
- A-B repeat does not work with an interactive DVD and MP3-CD.

Program playback

You can arrange the order of tracks on the disc.

- 1 Press **PLAY MODE** in the stop mode.

- 2 Press **ENTER** repeatedly until the program table shown at right appears.

- 3 **Example:** In case you wish to program in order of 7, 3, 11:
Enter as **7 ▼, 3 ▼, 11.**
If you input a wrong number, press **CANCEL**.

- 4 Press **▲/▼** or **◀/▶** to select "Program Playback" and press **ENTER**. "Program Playback" will appear on the screen. The program you selected will begin to playback in the order set.
To return to normal playback, select "Play Mode: Off" at step 2 above.

Random playback

- 1 Press **PLAY MODE** in the stop mode.

- 2 Press **◀/▶** to select "Random".

- 3 Press **PLAY**.

"Random Play" will appear on the screen and Random Playback will start.

NOTES:

- To cancel program play, select "Clear" at step 4 and press **ENTER**.
- The program is cancelled when you open the disc tray or turn the power off.
- Random playback can not be combined with Repeat playback.



MP3 playback

This player can play back the MP3-data which has been recorded on CD-R or CD-RW. To produce the MP3-data, you need a Windows-PC with CD-ROM drive and a MP3-encoding Software (not supplied). The Apple-HFS-System can not be played.

MP3 CD Information

Limitations on MP3 CD playback

- MP3 CD is the disc that is standardized by ISO9660, its file name must include 3-digits extension letters, "mp3".
- The directory and file names of the MP3 CD must correspond to the ISO standardized files.
- This unit can read 200 files per disc. If one directory has more than 200 files, it reads up to 200 files, the remaining files will be omitted.
- As for multi-session disc, only the first session can be played.
- If the CD has both audio tracks and MP3 files, only audio tracks are played.
- It may take more than one minute for this unit to read MP3 files depending on its structure.
- Music recorded by "Joliet Recording Specification" can be played back, the file name is displayed (within 16 letters) on the screen. Long file names will be condensed.
- The music files recorded by "Hierarchical File System" (HFS) cannot be played.

Limitations on display

- The maximum number for display is 16 letters. Available letters for display are the following: capital or small alphabets of A through Z, numbers of 0 through 9, and _ (under score).
- Other characters than those above are replaced by a hyphen.

Notes on MP3 files

To play back MP3 CD in the recorded order,

1. Use MP3 software that records data alphabetically or numerically.
2. Name each file including two-digit or three-digit number (e.g. "01" "02" or "001" "002").
3. Refrain from making too many sub-folders.

CAUTION:

- Some MP3 CDs can not be played back depending on the recording conditions.
- The CD-R/RW that has no music data or non-MP3 files can not be played back.

- 1 Press **OPEN/CLOSE**. The disc tray will open. Place a disc onto the tray.

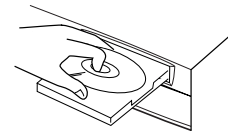

- 2 Press **PLAY** or **OPEN/CLOSE**. The disc tray closes automatically. On the TV-screen, "Reading" will appear. Reading will take as much time as the number of file.

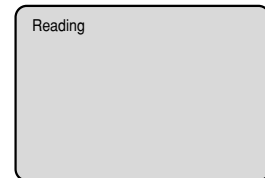

- 3 A MP3 menu screen will appear on the TV screen. Press **◀/▶** or **ENTER** to select folder.

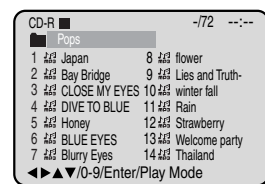

- 4 Press **▲/▼** or **◀/▶** or **Number keys** to select the desired track, then press **ENTER**. Track is selected and play commences.
 - In case the folder includes more than 15 tracks, press **◀** or **▶** to display next track list.

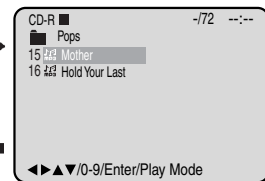
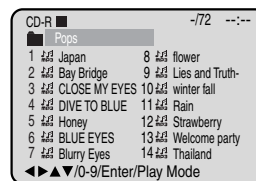

- 5 Press **STOP** to end playback.
 - The unit records the stopped point. "■" appears on the screen. Press **PLAY** to resume playback (from the scene point).
 - If you press **STOP** again or unload the disc, the unit will clear the stopped point.

- 6 Then press **OPEN/CLOSE**. The disc tray opens. Remove the disc and press **POWER**. The disc tray closes automatically and DVD/VCR turns off.

NOTES:

- During MP3-Playback, you can not use SEARCH, A-B Repeat functions.
- You can use Repeat (Track or All), Random functions and Program playback for MP3 CD Playback. (See page 27)





Parental control

Some discs are specified not suitable for children. Such discs can be prevented from play back with the unit.

Parental control setting

- 1 Press **SETUP** in the stop mode. Press ◀ or ▶ to select "Parental". Then press ▼ or **ENTER**.

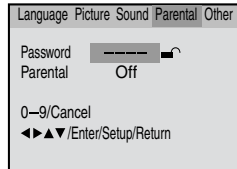

- 2 Press ▼ once to select "Parental Off", then press **ENTER** until the level you desire appears (e.g.: 1).
- 3 Press ▲ once to select "Password -----". Then press **Number keys** to input a 4-digit password (e.g.: 1234).
 - If you input a wrong number, press **CANCEL**.
 - Be sure to remember this number!

Level Off : The parental control setting does not function.
Level 1 : DVD software for adults cannot be played back.
Level 8 : All DVD software can be played back.

Select from level 1 to level 8.
 On a scale of 1-8, "1" is the most restrictive.

- 4 Press **ENTER**.
 1234 change to -----.

- 5 To make SETUP screen disappear, press **SETUP**.

To unlock the Parental control setting

Cancel the password so as to set the Parental level freely again,

- 1 Select "Password -----" (step 2) and press **Number keys** to input your 4-digit password. Then press **ENTER**.

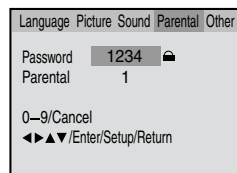

- 2 If the input password was right, ----- will appear. You can move to "Parental 1"(e.g.) to input the desired level or to cancel parental control.

NOTES:

- If each setup (pages 30, 31) has been completed, the unit can always be worked under the same conditions (especially with DVD discs).
- Each setup will be retained in the memory if you turn the power off.
- Depending on the discs, the unit cannot limit playback. Some discs may not be encoded with specific rating level information though its disc jacket says "adult". For those discs, the age restriction will not work.
- Do not forget the password. If you forget the password, contact customer service.

Temporary disabling of rating level by DVD disc

Depending on the DVD disc, the disc may try to temporarily cancel the rating level that you have set. It is up to you to decide whether to cancel the rating level or not.

- 1 Load a DVD disc and press **PLAY** or **OPEN/CLOSE** (see page 24).

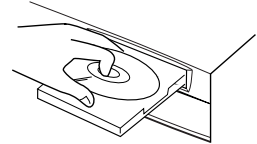

- 2 If the DVD disc has been designed to temporarily cancel the Rating level, the screen which follows the "Reading" screen will change, depending on which disc is played. If you select "YES" with **ENTER** key, "Your disc exceeds the parental control level 1."(e.g.) screen will then appear.

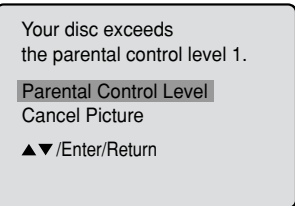

- 3 If you wish to cancel the set rating level temporarily, select "Parental Control Level" with ▲ or ▼, then press **ENTER**. If the 4-digits password at step 3 on left column has been set, the password entering screen will appear as shown in step 4 below. Alternatively, if the password has not been set, playback will commence. If you don't know (or have forgotten) the password, select "Cancel Picture". The setting screen will disappear. Press **OPEN/CLOSE** to remove the disc.

- 4 Enter the password with **Number buttons (0-9)**. Then press **ENTER**.

If you interrupt the entering, press **RETURN**.

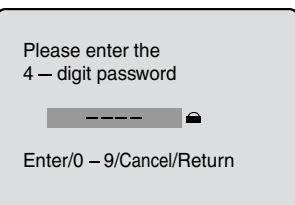

- 5 Playback will commence if the entered password was correct.

NOTE:

This temporary cancellation of rating level will be kept until the disc is ejected.
 When the disc is ejected, the original rating level will be set again automatically.





Setting language

You can select the language of the disc menu messages of DVDs.

- 1 Press **SETUP** in the stop mode.
Press ◀ or ▶ to select "Language".
- 2 Press ▼ or **ENTER**.
Then press ▲ or ▼ to select desired option.

- 3 Press ▶ or **ENTER**.
Press ▲ or ▼ to select your desired language, then press **ENTER**.

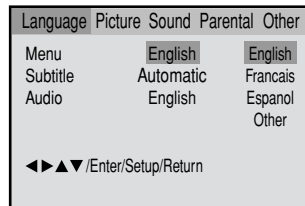

English, Francais, Espanol:

The selected language will be heard or seen.

Other:

Other language can be selected (see the "Language code list" on page 33).

Automatic: (Subtitle)

- The unit will automatically select the same language in the AUDIO setting.
- When the unit selects the same language as the AUDIO, the subtitles will not appear during playback.
- When you do not use the same language as the AUDIO, the subtitles will appear during playback.

Off: (Subtitle)

Subtitles do not appear.

Original: (Audio)

The unit will select the first priority language of each disc.

- 4 To make SETUP screen disappear, press **SETUP**.

NOTE:

If the selected language is not recorded on the disc, the first priority language is selected.

Setting the aspect ratio of TV screen

You can select the aspect ratio for your TV.

- 1 Press **SETUP** in the stop mode.
Press ◀ or ▶ to select "Picture".
- 2 Press ▼ or **ENTER**, then press ▲ or ▼ to select "Tv Screen".

- 3 Press ▶ or **ENTER**.
Press ▲ or ▼ to select your desired screen type, then press **ENTER**.

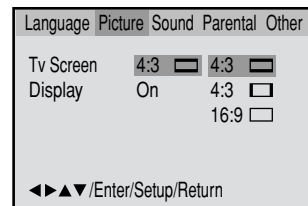

You have the following screen sizes to choose from:

4:3 Letter box

Select this mode when connecting to a conventional TV. When playing back a wide screen-DVD disc, it displays the wide picture with black bands at the top and bottom of screen.

4:3 Pan Scan

It displays the wide picture on the whole screen with left and right edges automatically cut off.

16:9 Wide

Select this mode when connecting to a wide-screen TV. A wide screen picture is displayed full size.

- 4 To make SETUP screen disappear, press **SETUP**.

NOTE:

If the DVD disc is not formatted in the pan & scan style, it displays 4:3 style.

Status display of disc

Each press of **DISPLAY**, the status display of the disc will appear on the screen and change as follows.

DVD

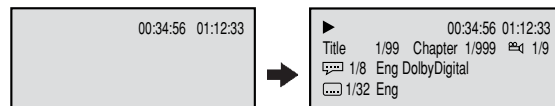

To make status display disappear, press **DISPLAY** again.

AUDIO / CD

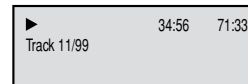

When you playback the CD disc, the status display will appear on the screen and continue displaying.



Setting on screen display

Setting on screen display

On screen display can be switched on or off when you press the DISPLAY button.

- 1 Press **SETUP** in the stop mode.
Press ◀ or ▶ to select "Picture"

- 2 Press ▼ or **ENTER**, then press ▲ or ▼ to select "Display".

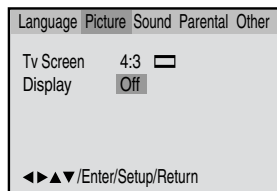

- 3 Press ▶ or **ENTER** to select "On" or "Off".

- On:** On screen displays appears when you press any buttons (factory setting).
- Off:** On screen displays do not appear when you press any buttons except **SETUP**, **SEARCH MODE**, **PLAY MODE**, **MARKER** and **DISPLAY**.

- 4 To make SETUP screen disappear, press **SETUP**.

Dynamic Range Control

DRC (Dynamic Range Control) enables you to control the dynamic range so as to achieve a suitable sound for your equipment.

- 1 Press **SETUP** in the stop mode.
Press ◀ or ▶ to select "Sound".

- 2 Press ▼ or **ENTER** to select "DRC".

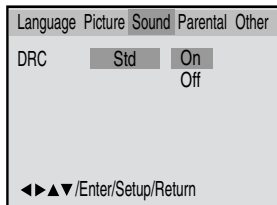

- 3 Press ▶ or **ENTER**, then press ▲ or ▼ to select desired setting.

NOTES:

- This function works only during playback of Dolby Digital recorded discs.
- The level of Dynamic Range Reduction may differ depending on DVD video disc.

Progressive scan

The unit supports the Progressive scanning system as well as the conventional interlaced scanning system. If your TV is equipped with component jacks which support the progressive video input, you can enjoy high quality picture by making the Progressive scanning mode active.

S-VIDEO/COMPONENT
Video selector switch

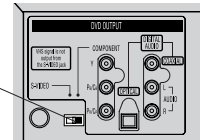

- 1 Press **PROGRESSIVE** in the stop mode.
The PROGRESSIVE indicator "P" on the display window will light.

- The unit recognizes the picture source (film or video) of the current disc according to the disc information.

- 2 Press **PLAY** to start playback.

- To make the progressive scanning mode inactive, press **PROGRESSIVE** in the stop mode.
The PROGRESSIVE indicator "P" on the display window will go off.

About PROGRESSIVE SCANNING MODE

To display video on the TV screen, the conventional scanning method is called "Interlaced scanning." With this method, only half of the horizontal lines are displayed at a time. So two fields complete a single picture (frame); i.e., the first field, containing all the odd-numbered lines, is displayed followed by the second field, containing all the even-numbered lines.

The Progressive scanning system scans all horizontal lines at a time, so you can double the number of lines compared with the interlaced scanning, resulting in a high-density, flicker-free picture.

To enjoy a progressive scanned video, the TV connected to the unit must have Progressive inputs.

Depending on the material source format, DVD discs can be classified into two categories; film and video (note that some DVD discs contain both a film source and a video source). Film sources are recorded as 24-frame-per-second information, while (NTSC) video sources are recorded as 30-frame-per second (60-field-per-second interlaced) information.

When the unit plays back a film source material, uninterlaced progressive output signals are created using the original information. When a video source material is played back, the unit interleaves lines between the interlaced lines on each to create the interpolated picture and outputs as the progressive signal.

NOTES:

- Some discs may not be played back with the progressive scanning mode correctly because of the disc characteristics or recording condition.
- There are some progressive TV and High-Definition TV sets that are not fully compatible with the unit, resulting in the unnatural picture when playing back a DVD disc in the Progressive scanning mode. In such a case, use the Interlaced scanning mode.
- You cannot make the progressive scanning mode active in following cases.
 - The unit is in the VCR mode.
 - The disc is played back in the DVD mode.
 - The S-VIDEO/COMPONENT video selector switch is set to S-VIDEO position.



Language code list

Enter the appropriate code number for the initial settings “Audio”, “Subtitle” and/or “Menu” (see page 30).

Language Name	Code	Language Name	Code	Language Name	Code	Language Name	Code
Abkhazian	1112	Fiji	1620	Lingala	2224	Sinhalese	2919
Afar	1111	Finnish	1619	Lithuanian	2230	Slovak	2921
Afrikaans	1116	French	1628	Macedonian	2321	Slovenian	2922
Albanian	2927	Frisian	1635	Malagasy	2317	Somali	2925
Amharic	1123	Galician	1722	Malay	2329	Spanish	1529
Arabic	1128	Georgian	2111	Malayalam	2322	Sundanese	2931
Armenian	1835	German	1415	Maltese	2330	Swahili	2933
Assamese	1129	Greek	1522	Maori	2319	Swedish	2932
Aymara	1135	Greenlandic	2122	Marathi	2328	Tagalog	3022
Azerbaijani	1136	Guarani	1724	Moldavian	2325	Tajik	3017
Bashkir	1211	Gujarati	1731	Mongolian	2324	Tamil	3011
Basque	1531	Hausa	1811	Nauru	2411	Tatar	3030
Bengali; Bangla	1224	Hebrew	1933	Nepali	2415	Telugu	3015
Bhutani	1436	Hindi	1819	Norwegian	2425	Thai	3018
Bihari	1218	Hungarian	1831	Oriya	2528	Tibetan	1225
Breton	1228	Icelandic	1929	Panjabi	2611	Tigrinya	3019
Bulgarian	1217	Indonesian	1924	Pashto, Pushto	2629	Tonga	3025
Burmese	2335	Interlingua	1911	Persian	1611	Turkish	3028
Byelorussian	1215	Irish	1711	Polish	2622	Turkmen	3021
Cambodian	2123	Italian	1930	Portuguese	2630	Twi	3033
Catalan	1311	Japanese	2011	Quechua	2731	Ukrainian	3121
Chinese	3618	Javanese	2033	Rhaeto-Romance	2823	Urdu	3128
Corsican	1325	Kannada	2124	Romanian	2825	Uzbek	3136
Croatian	1828	Kashmiri	2129	Russian	2831	Vietnamese	3219
Czech	1329	Kazakh	2121	Samoan	2923	Volapük	3225
Danish	1411	Kirghiz	2135	Sanskrit	2911	Welsh	1335
Dutch	2422	Korean	2125	Scots Gaelic	1714	Wolof	3325
English	1524	Kurdish	2131	Serbian	2928	Xhosa	3418
Esperanto	1525	Laothian	2225	Serbo-Croatian	2918	Yiddish	2019
Estonian	1530	Latin	2211	Shona	2924	Yoruba	3525
Faroese	1625	Latvian, Lettish	2232	Sindhi	2914	Zulu	3631





Problems and troubleshooting

Use the following check list for troubleshooting when you have problems with your unit. Consult your local dealer or service outlet if problems persist.

Be sure all connections are properly made when using with other units.

SYMPTOMS	POSSIBLE SOLUTIONS	PAGE
DVD/VCR		
DVD/VCR does not operate.	<ul style="list-style-type: none"> • Make sure the power cord is plugged in. • Try another AC outlet. • Power is off, check fuse or circuit breaker. • Unplug unit, then plug it back in. • Select the DVD or VCR mode before operating. 	9 – – 9 –
No picture.	<ul style="list-style-type: none"> • Antenna connection is not correct or antenna cable is disconnected. • The video channel is not in the correct position or the TV is not set to the video channel 3 or 4. • Check the unit is connected correctly. • The video input selector of the TV is not set to VIDEO. Set to VIDEO (or equivalent). • Channel is set to the external mode. 	10,11 14 10~13 – –
No sound.	<ul style="list-style-type: none"> • Check the unit is connected correctly. • Check the input selector of the amplifier is set properly. • The unit is in the Special playback mode. 	10~13 – 18,24
The remote control does not function.	<ul style="list-style-type: none"> • Aim at the remote control at the remote sensor. • Operate within Approx. 5 Meters or reduce the light in the room. • Clear the path of the beam. • The batteries are weak. Replace the batteries. • Check the batteries are inserted correctly. 	9
No CABLE reception	<ul style="list-style-type: none"> • Check all CABLE connections. • Station or CABLE system problems, try another station. 	11
VCR		
TV recording does not work.	<ul style="list-style-type: none"> • The erase prevention tab of the video cassette is broken off. • The unit is in the external input mode. 	17,19
Timer recording does not work.	<ul style="list-style-type: none"> • The time is not set correctly. • The recording start/end time is not set correctly. • TIMER REC has not been pressed (⏸ is not lit). 	16 20 20
Noise bars on screen.	<ul style="list-style-type: none"> • Tracking adjustment beyond range of automatic tracking circuit. Try Manual tracking adjustment. • Video heads are dirty. • The tape is worn or damaged. 	18 34 –
DVD		
Display is not shown in your language.	<ul style="list-style-type: none"> • Select proper language in the menu options. 	23
Playback doesn't start.	<ul style="list-style-type: none"> • No disc is inserted. • The disc may be dirty. Clean up the disc. • The unit cannot play DVD-ROMs, etc. 	24 23 23
Stopping playback, search, slow-motion play, repeat play, or program play, etc. cannot be performed.	<ul style="list-style-type: none"> • Some discs may not do some of the functions. 	–
No picture, or the screen is blurred or divided into two parts.	<ul style="list-style-type: none"> • The S-VIDEO/COMPONENT selector is not set correctly. • The progressive scanning mode is active through the unit is connected to a TV via the VIDEO OUT jack. 	12 31





Problems and troubleshooting / Video head cleaning

SYMPTOMS	POSSIBLE SOLUTIONS	PAGE
No 4:3 (16:9) picture	• The setup does not match your TV.	30
No on-screen display	• Select Display On.	30
No surround sound	• The setup does not match your stereo system.	13
The unit or remote operation key is not functioning.	• Turn off the unit and unplug the AC power cord for several minutes, then replug it.	–
Playback does not start when the title is selected.	• Check the Parental setup.	29
Audio soundtrack and/or subtitle language is not changed when you play back a DVD.	• Multilingual language is not recorded on the DVD disc.	30
No subtitle	• Some discs have no subtitles. • Subtitles are cleared. Press SUB TITLE.	28,30
Angle cannot be changed.	• Multi-angles are not recorded on the DVD disc.	26
 appears on the screen.	• The function is prohibited with the unit or the disc.	–

Video head cleaning

Video head clogging

The video heads are the means by which the DVD/VCR reads the picture from the tape during playback. In the unlikely event that the heads become dirty enough to be clogged, no picture will be played back. This can easily be determined if, during playback of a known good tape, there is good sound, but no picture (picture is extremely snowy). If this is the case, have the DVD/VCR checked by qualified service personnel.



Good Picture



Snowy Picture

- NOTES:**
- DO NOT ATTEMPT TO CLEAN THE VIDEO HEADS OR SERVICE THE UNIT BY REMOVING THE REAR COVER.
 - Video heads may eventually wear out and should be replaced when they fail to produce clear pictures.
 - To help prevent video head clogging, use only good quality VHS tapes. Discard worn out tapes.





Specifications

Specifications

GENERAL

Power supply: AC 120V 60Hz
 Power consumption: Operation: 18W
 Stand by: 2W
 Weight: 7.9 lbs (3.6 kg)
 Dimensions: Width : 16-15/16 inches (430 mm)
 Height : 3-7/8 inches (99 mm)
 Depth : 9-3/4 inches (247 mm)

Inputs/Outputs:
 Video:
 In: 1Vp-p/75 ohm
 Audio:
 Out: 1Vp-p/75 ohm
 In: -8dBm/50k ohm
 Antenna:
 Out: -8dBm/1k ohm
 Hi-Fi frequency response: UHF/VHF IN/OUT: 75 ohm
 Hi-Fi dynamic range: coaxial
 20Hz to 20,000Hz
 More than 90dB

VCR section

Video head: 4 Rotary Heads
 Audio track: Hi-Fi Sound - 2 Tracks / MONO
 Tuner: Sound - 1 Track
 181 Channel Freq. Synthesized
 VHF 2-13
 UHF 14-69
 CABLE TV 14-36 (A)-(W)
 37-59 (AA)-(WW)
 60-85 (AAA)-(ZZZ)
 86-94 (86)-(94)
 95-99 (A-5)-(A-1)
 100-125 (100)-(125)
 01 (5A)

RF channel output: Channel 3 or 4, Switchable
 F.FWD/REW Time: Approx. 1 minute and 48 seconds
 (with T-120 Cassette
 Tape)(at+25°C)

DVD section

Signal system: NTSC
 Applicable disc: DVD (12cm, 8cm), CD (12cm, 8cm)

Audio characteristics
 frequency response: DVD: 4Hz - 22kHz
 CD: 4Hz - 20kHz
 S/N Ratio: 90dB
 Harmonic distortion: 0.02%
 Wow and flutter: Less than 0.01% Wrms
 Dynamic range: More than 90dB
 Output: Video : (RCA) 1 Vp-p/75 ohm
 Audio : (RCA) -8 dBm/1k ohm
 Digital Audio : 0.5Vp-p/75 ohm
 Pickup: CD : Wavelength: 775 - 805 nm
 Maximum output power: 0.5 mW
 DVD :Wavelength: 640 - 660 nm
 Maximum output power: 1.0 mW

ACCESSORIES:

Remote control x 1
 75 ohm Coaxial Cable x 1
 AUDIO/VIDEO Cable x 1



FOR CUSTOMER SERVICE,
 ADDITIONAL SET-UP OR
 OPERATING ASSISTANCE
 PLEASE CALL:

1-800-289-0980

TO ORDER ACCESSORY
 PARTS OR LITERATURE

PLEASE CALL:

1-888-369-0304

OR WRITE TO:
ORION SALES, INC.
 3471 N. UNION DR.
 OLNEY, ILLINOIS 62450

FOR INFORMATION ON OUR OTHER PRODUCTS, PLEASE VISIT OUR WEBSITE AT
www.orionsalesinc.com





limited WARRANTY

DVD PLAYER / VIDEO CASSETTE RECORDER COMBINATION UNIT

ORION warrants this product to be free from manufacturing defects in material and workmanship under normal use and conditions for a period of ninety (90) days from date of original purchase in the United States only.

Should service be necessary under this warranty for any reason due to a manufacturing defect or malfunction during the first ninety (90) day period from date of original purchase, ORION will provide carry-in repair service at an ORION authorized Independent Service Center at no charge. In addition, for a period of up to six (6) months from date of original purchase for video heads and twelve (12) months from date of original purchase for other component parts, if an original part fails due to a manufacturing defect in material or workmanship we will replace the defective part only (EXCLUDING LABOR AFTER INITIAL NINETY (90) DAY WARRANTY PERIOD) provided the defect or malfunction is verified along with dated proof of purchase.

There are ORION Independent Service Centers located throughout the country. For the one nearest you, DIAL TOLL FREE: 1-800-289-0980 or visit our website at www.orionsalesinc.com. This product is eligible for CARRY-IN service only. ORION will not be liable for damages incurred during shipment of the unit. If there are no ORION authorized Independent Service Centers in your area please call – 1-888-296-7466 for assistance.

Note: This warranty is void if the product is:

- (a) Damaged through negligence, misuse, or accident.
- (b) Used in a commercial application or rentals.
- (c) Modified or repaired by anyone other than an Independent Service Center authorized by ORION to effect warranty repairs to the class of product or by the ORION Factory Service Center.
- (d) Damaged because it is improperly connected to the equipment of other manufacturers.

This warranty does not cover:

- a) Damage to tape cartridge.
- b) Cleaning of video heads.
- c) Damage to DVD and CD discs.
- d) Damage to equipment not properly connected to the product.
- e) Costs incurred in the shipping of the product to an ORION authorized Independent Service Center or ORION Factory Service Center.
- f) Damage or improper operation of unit caused by customer abuse, misuse, negligence, or failure to follow operating instructions provided with the product.
- g) Ordinary adjustments to the product, which can be performed by customer as outlined in the owner's manual.

THIS WARRANTY IS NON-TRANSFERABLE AND APPLIES ONLY TO THE ORIGINAL PURCHASER AND DOES NOT EXTEND TO SUBSEQUENT OWNERS OF THE PRODUCT. ANY APPLICABLE IMPLIED WARRANTIES, INCLUDING THE WARRANTY OF MERCHANTABILITY, ARE LIMITED IN DURATION TO A PERIOD OF THE EXPRESS WARRANTY AS PROVIDED HEREIN BEGINNING WITH THE DATE OF ORIGINAL PURCHASE AT RETAIL AND NO WARRANTIES, WHETHER EXPRESS OR IMPLIED SHALL APPLY TO THIS PRODUCT THEREAFTER. ORION MAKES NO WARRANTY AS TO THE FITNESS OF THE PRODUCT FOR ANY PARTICULAR PURPOSE AND USE.

UNDER NO CIRCUMSTANCES SHALL ORION BE LIABLE FOR ANY LOSS, DIRECT, INDIRECT, INCIDENTAL, SPECIAL, OR CONSEQUENTIAL DAMAGE ARISING OUT OF OR IN CONNECTION WITH THE USE OF THIS PRODUCT.

THIS WARRANTY IS VALID ONLY IN THE UNITED STATES OF AMERICA. THIS WARRANTY GIVES YOU SPECIFIC LEGAL RIGHTS, HOWEVER, YOU MAY HAVE OTHER RIGHTS WHICH MAY VARY FROM STATE TO STATE. SOME STATES DO NOT ALLOW LIMITATION ON IMPLIED WARRANTIES OR EXCLUSION OF CONSEQUENTIAL DAMAGE; THEREFORE, THESE RESTRICTIONS MAY NOT APPLY TO YOU.

ORION SALES, INC.
3471 N. UNION DR.
OLNEY, ILLINOIS 62450



J2D80401A

04/06 U

Printed in Thailand

