

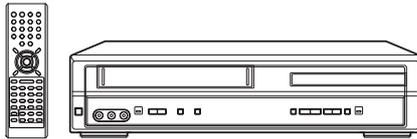

Panasonic®

DOUBLEFEATURE™



DVD/VCR DECK Operating Instructions

Omnivision **VHS** Model No. **PV-D744S-A**



*Ability to play back may depend on recording conditions.



As an ENERGY STAR® Partner, Matsushita Electric Corporation of America has determined that this product or product model meets the ENERGY STAR® guidelines for energy efficiency.

Please read these instructions carefully before attempting to connect, operate, or adjust this product. Please save this manual.
Spanish Quick Use Guide is included.
(Guía para rápida consulta en español está incluida.)

TV/CABLE MODE SELECTION

When shipped from the factory, the TV/CABLE menu option is set to the "CABLE" (Cable Television) mode. If not using Cable TV, set this menu option to the "TV" position.

For assistance, please call : 1-800-211-PANA(7262) or send e-mail to : consumerproducts@panasonic.com





	CAUTION RISK OF ELECTRIC SHOCK DO NOT OPEN	
<p>CAUTION: TO REDUCE THE RISK OF ELECTRIC SHOCK, DO NOT REMOVE COVER (OR BACK). NO USER-SERVICEABLE PARTS INSIDE. REFER SERVICING TO QUALIFIED SERVICE PERSONNEL.</p>		



The lightning flash with arrowhead symbol, within an equilateral triangle is intended to alert the user to the presence of uninsulated dangerous voltage within the product's enclosure that may be of sufficient magnitude to constitute a risk of electric shock to persons.



The exclamation point within an equilateral triangle is intended to alert the user to the presence of important operating and maintenance (servicing) instructions in the literature accompanying the appliance.

WARNING: TO REDUCE THE RISK OF FIRE OR ELECTRIC SHOCK, DO NOT EXPOSE THIS APPLIANCE TO RAIN OR MOISTURE.

WARNING: This equipment has been tested and found to comply with the limits for a Class B digital device, pursuant to Part 15 of the FCC Rules. These limits are designed to provide reasonable protection against harmful interference in a residential installation. This equipment generates, uses and can radiate radio frequency energy and, if not installed and used in accordance with the instructions, may cause harmful interference to radio communications. However, there is no guarantee that interference will not occur in a particular installation. If this equipment does cause harmful interference to radio or television reception, which can be determined by turning the equipment off and on, the user is encouraged to try to correct the interference by one or more of the following measures:

- Reorient or relocate the receiving antenna.
- Increase the separation between the equipment and receiver.
- Connect the equipment into an outlet on a circuit different from that to which the receiver is connected.
- Consult the dealer or an experienced radio/TV technician for help.

CAUTION: Changes or modifications not expressly approved by the party responsible for compliance with the FCC Rules could void the user's authority to operate this equipment.

<p>CAUTION: THIS DIGITAL VIDEO PLAYER EMPLOYS A LASER SYSTEM.</p> <p>TO ENSURE PROPER USE OF THIS PRODUCT, PLEASE READ THIS USER'S GUIDE CAREFULLY AND RETAIN FOR FUTURE REFERENCE. SHOULD THE UNIT REQUIRE MAINTENANCE, CONTACT AN AUTHORIZED SERVICE LOCATION-SEE SERVICE PROCEDURE.</p> <p>USE OF CONTROLS, ADJUSTMENTS OR THE PERFORMANCE OF PROCEDURES OTHER THAN THOSE SPECIFIED HEREIN MAY RESULT IN HAZARDOUS RADIATION EXPOSURE.</p> <p>TO PREVENT DIRECT EXPOSURE TO LASER BEAM, DO NOT TRY TO OPEN THE ENCLOSURE. VISIBLE LASER RADIATION MAY BE PRESENT WHEN THE ENCLOSURE IS OPENED. DO NOT STARE INTO BEAM.</p>
--

Location of the required Marking

The rating sheet and the safety caution are on the rear of the unit.

CERTIFICATION: COMPLIES WITH FDA RADIATION PERFORMANCE STANDARDS, 21 CFR SUBCHAPTER J.

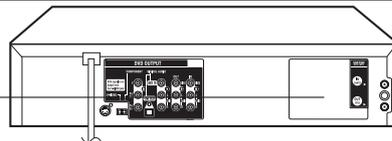

2





IMPORTANT SAFEGUARDS

1. READ INSTRUCTIONS

All the safety and operating instructions should be read before the unit is operated.

2. RETAIN INSTRUCTIONS

The safety and operating instructions should be retained for future reference.

3. HEED WARNINGS

All warnings on the unit and in the operating instructions should be adhered to.

4. FOLLOW INSTRUCTIONS

All operating and use instructions should be followed.

5. CLEANING

Unplug this unit from the wall outlet before cleaning. Do not use liquid cleaners or aerosol cleaners.

Use a damp cloth for cleaning the exterior cabinet only.

6. ATTACHMENTS

The manufacturer of this unit does not make any recommendations for attachments, as they may cause hazards.

7. WATER AND MOISTURE

Do not use this unit near water. For example, near a bathtub, washbowl, kitchen sink, laundry tub, in a wet basement, or near a swimming pool.

8. ACCESSORIES

Do not place this unit on an unstable cart, stand, tripod, bracket, or table.

The unit may fall, causing serious injury, and serious damage to the unit.

- 8A.** An appliance and cart combination should be moved with care. Quick stops, excessive force, and uneven surfaces may cause the appliance and cart combination to overturn.

9. VENTILATION

Slots and openings in the cabinet back or bottom are provided for ventilation, to ensure reliable operation of the unit, and to protect it from overheating.

These openings must not be blocked or covered. The openings should never be blocked by placing the unit on a bed, sofa, rug, or other similar surface. This unit should never be placed near or over a radiator or heat source. This unit should not be placed in a built-in installation such as a bookcase or rack unless proper ventilation is provided and/or the manufacturer's instructions have been adhered to.

10. POWER SOURCES

This unit should be operated only from the type of power source indicated on the rating plate. If you are not sure of the type of power supply to your home, consult your appliance dealer or local power company. For units intended to operate from battery power, or other sources, refer to the operating instructions.

11. GROUNDING OR POLARIZATION

This unit is equipped with a polarized alternating-current line plug (a plug having one blade wider than the other). This plug will fit into the power outlet only one way. This is a safety feature. If you are unable to insert the plug fully into the outlet, try reversing the plug. If the plug should still fail to fit, contact your electrician to replace your obsolete outlet. Do not defeat the safety purpose of the polarized plug, if your unit is equipped with a 3-wire grounding-type plug, a plug having a third (grounding) pin. This plug will only fit into a grounding-type power outlet. This too, is a safety feature. If you are unable to insert the plug into the outlet, contact your electrician to replace your obsolete outlet. Do not defeat the safety purpose of the grounding-type plug.

12. POWER-CORD PROTECTION

Power-supply cords should be routed so that they are not likely to be walked on or pinched by items placed upon or against them, paying particular attention to cords at plugs, convenience receptacles, and the point where they exit from the appliance.

PORTABLE CART WARNING
(symbol provided by RETAC)



S3125A



IMPORTANT SAFEGUARDS

13. LIGHTNING

To protect your unit from a lightning storm, or when it is left unattended and unused for long periods of time, unplug it from the wall outlet and disconnect the antenna or cable system. This will prevent damage to the unit due to lightning and power line surges.

14. POWER LINES

An outside antenna system should not be located in the vicinity of overhead power lines or other electric light or power circuits, or where it can fall into such power lines or circuits. When installing an outside antenna system, extreme care should be taken to keep from touching such power lines or circuits, as contact with them might be fatal.

15. OVERLOADING

Do not overload wall outlets and extension cords, as this can result in a risk of fire or electric shock.

16. OBJECT AND LIQUID ENTRY

Do not push objects through any openings in this unit, as they may touch dangerous voltage points or short out parts that could result in fire or electric shock. Never spill or spray any type of liquid into the unit.

17. OUTDOOR ANTENNA GROUNDING

If an outside antenna or cable system is connected to the unit, be sure the antenna or cable system is grounded to provide some protection against voltage surges and built-up static charges, Section 810 of the National Electrical Code, ANSI/NFPA 70, provides information with respect to proper grounding of the mast and supporting structure, grounding of the lead-in wire to an antenna discharge unit, size of grounding conductors, location of antenna discharge unit, connection to grounding electrodes, and requirements for the grounding electrode.

18. SERVICING

Do not attempt to service this unit yourself as opening or removing covers may expose you to dangerous voltage or other hazards. Refer all servicing to qualified service personnel.

19. DAMAGE REQUIRING SERVICE

Unplug this unit from the wall outlet and refer servicing to qualified service personnel under the following conditions:

- a. When the power-supply cord or plug is damaged.
- b. If liquid has been spilled, or objects have fallen into the unit.
- c. If the unit has been exposed to rain or water.
- d. If the unit does not operate normally by following the operating instructions. Adjust only those controls that are covered by the operating instructions, as an improper adjustment of other controls may result in damage and will often require extensive work by a qualified technician to restore the unit to its normal operation.
- e. If the unit has been dropped or the cabinet has been damaged.
- f. When the unit exhibits a distinct change in performance, this indicates a need for service.

20. REPLACEMENT PARTS

When replacement parts are required, be sure the service technician uses replacement parts specified by the manufacturer or those that have the same characteristics as the original part. Unauthorized substitutions may result in fire, electric shock or other hazards.

21. SAFETY CHECK

Upon completion of any service or repairs to this unit, ask the service technician to perform safety checks to determine that the unit is in proper operating condition.

22. HEAT

The product should be situated away from heat sources such as radiators, heat registers, stoves, or other products (including amplifiers) that produce heat.

23. DISC TRAY

Keep your fingers well clear of the disc tray as it is closing. It may cause serious personal injury.

24. CONNECTING

When you connect the product to other equipment, turn off the power and unplug all of the equipment from the wall outlet. Failure to do so may cause an electric shock and serious personal injury. Read the owner's manual of the other equipment carefully and follow the instructions when making any connections.

4





IMPORTANT SAFEGUARDS

25. LASER BEAM

Do not look into the opening of the disc tray or ventilation opening of the product to see the source of the laser beam. It may cause sight damage.

26. DISC

Do not use a cracked, deformed, or repaired disc. These discs are easily broken and may cause serious personal injury and product malfunction.

27. NOTE TO CABLE TV SYSTEM INSTALLER

This reminder is provided to call the Cable TV system installer's attention to Article 820-40 of the NEC that provides guidelines for proper grounding and, in particular, specifies that the cable ground shall be connected to the grounding system of the building, as close to the point of cable entry as practical.

EXAMPLE OF ANTENNA GROUNDING AS PER THE NATIONAL ELECTRICAL CODE

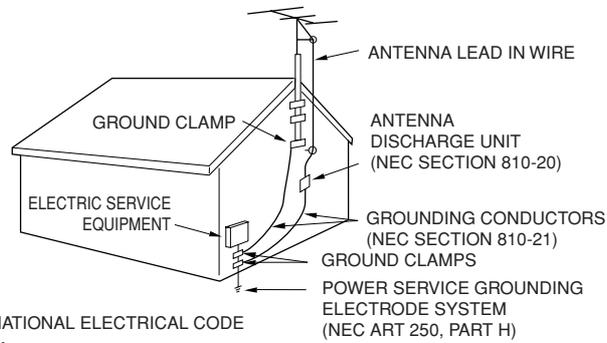

CONDENSATION

Moisture will form in the operating section of the DVD/VCR if the player is brought from cool surroundings into a warm room or if the temperature of the room rises suddenly. When this happens, the DVD/VCR's performance will be impaired.

To prevent this, let the DVD/VCR stand in its new surroundings for about an hour before switching it on, or make sure that the room temperature rises gradually.

Condensation may also form during the summer if the DVD/VCR is exposed to the breeze from an air conditioner. In such cases, change the location of the DVD/VCR.

* This product incorporates copyright protection technology that is protected by method claims of certain U.S. patents and other intellectual property rights owned by Macrovision Corporation and other rights owners. Use of this copyright protection technology must be authorized by Macrovision Corporation and is intended for home and other limited viewing uses only unless otherwise authorized by Macrovision Corporation. Reverse engineering or disassembly is prohibited.

Consumers should note that not all high definition television sets are fully compatible with this product and may cause artifacts to be displayed in the picture. In case of 525 progressive scan picture problems, it is recommended that the user switch the connection to the "STANDARD DEFINITION" output. If there are questions regarding our TV set compatibility with this model 525p DVD player, please contact our customer service center.

* Manufactured under license from Dolby Laboratories. "Dolby" and the double-D symbol are trademarks of Dolby Laboratories.

* "DTS" and "DTS Digital Out" are trademarks of Digital Theater Systems, Inc.

* Unauthorized recording of copyrighted television programs, films, video cassettes and other materials may infringe the rights of copyright owners and be contrary to copyright laws.

* MPEG Layer-3 audio decoding technology licensed from Fraunhofer IIS and Thomson multimedia.





Disc information

Discs that can be played

Disc type	Disc Logo	Disc formats supported by this unit
DVD-Video		• DVD-Video format
CD-DA		• CD-DA format
CD-R		• CD-DA format • MP3 and JPEG file (finalized*)
CD-RW		• MP3 and JPEG file (finalized*)

- Discs played 8 cm (3") or 12 cm (5").
- * A process that allows play on compatible equipment.
- This unit can play back FUJICOLOR and Kodak Picture CD formats.

Discs which cannot be played with this unit

- DVD with Region No. other than "1" or "ALL"
- DVD of PAL system
- DVD-RAM
- DVD-ROM
- DVD-AUDIO
- DVD-R/RW
- DVD+R/RW
- CD-ROM
- CDV
- CVD
- CD-G
- CD-TEXT
- VCD
- SVCD
- SACD
- Photo-CD

Region Management Information

This unit is designed and manufactured to respond to the Region Management Information that is recorded on a DVD disc. If the Region number described on the DVD disc does not correspond to the Region number of this unit, this unit cannot play this disc.

- The region number of this player is "1".
- The player will play DVD-Video marked with labels containing "1" or "ALL".

Example:



Definition of Terms

Angle

Some DVD discs feature scenes simultaneously shot from different angles. The ANGLE button can be used to view the scene from different angles.

Chapter Number

Titles are subdivided into numbered sections. You can quickly search for a favorite scene using these numbers.

DVD

A high-density optical disc on which high-quality pictures and sound have been digitally recorded. DVD incorporates new video compression technology (MPEG II) and high-density recording technology which allow entire movies to be recorded with incredible playback quality.

Subtitles

Written dialogue which appears at the bottom of the screen.

Time Number

The elapsed play time from the start of a disc or title. Use to quickly find scenes. (May not work with some discs.)

Title Number

For DVD discs with two or more titles, the title is numbered as title 1, title 2, etc.

Track Number

Numbers assigned to tracks on CDs to allow specific tracks to be quickly located.

6

Disc Handling

Handling precautions

- Do not attach sticker to discs. (Do not use discs with exposed adhesive from tape or left over peeled-off stickers.)
- Only hold disc by edges as shown. Fingerprints, dirt, and scratches can cause skipping and distortion.
- Do not write on label side of disc.
- Never use record cleaning sprays, benzine, thinner, static electricity prevention liquids, or any other solvent.
- Be careful not to drop or bend disc.
- Do not place more than 1 disc on disc tray.
- Do not try to close disc tray when disc is not properly placed.
- Always store discs in their proper cases when not in use.

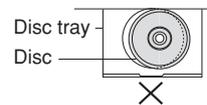

To clean disc surface

With a soft, damp (water only) cloth, gently wipe from the center hole to the outer edge as shown below. (Wiping in a circular pattern will scratch the surface.)

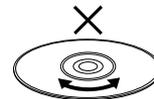
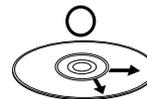

If disc is brought from a cold to a warm environment, moisture may form on the disc

Wipe away moisture with a soft, dry, lint-free cloth before using disc. (See above.)

Improper disc storage

Discs could be damaged if stored or left in areas:

- exposed to direct sunlight.
- that are humid or dusty.
- near heat (i.e. heater, radiator, etc.).





Contents

Before using your unit

IMPORTANT SAFEGUARDS	3
Disc information	6
Contents	7
Parts and functions	8
Display	9
Remote control	10
Power source	11
Basic connections	12
Cable TV connections	14
Playback connections	16

Setting up the VCR section

Auto clock setting	18
Manual clock setting	20
Setting the video channel	21
Setting the language	21
Tuner setting	22
To ADD/DELETE channels	23
Weak signal display	23
Loading and Unloading a cassette tape	24

Tape playback operation

Cassette tape playback	25
Special playback	26
ZERO SEARCH function	27
Video index search system	27

Recording

Recording a TV program	28
One-touch Timer Recording (OTR)	30
Timer recording	31

Advanced function of VCR section

Stereo recording and playback	33
Second Audio Program (SAP)	33
Duplicating a video tape	34

Disc playback operation

Setting setup language	35
Progressive scan mode	35
Playback procedure	36
Special playback	37
Zooming	38
Locating desired scene	38
Marking desired scenes	39
Repeat playback	40
Program playback/Random playback (CD)	41
Changing soundtrack language	42
Subtitles	42
Karaoke playback	42
Changing angles	43
Title selection	43
DVD menu	43
MP3/JPEG playback	44

Advanced function of DVD section

Parental control	47
Temporary disabling of rating level by DVD disc ...	48
Setting menu language	49
Setting subtitle language	50
Setting audio soundtrack language	51
Setting the aspect ratio of TV screen	52
Setting on screen display	53
Status display of disc	53
Dynamic Range Control	54

Additional information

Language code list	55
Problems and troubleshooting	56
Built-in head cleaner	57
Video head cleaning	57
Specifications	58
Spanish Quick Use Guide (Guía para rápida consulta)	59
Limited Warranty	64
Customer Services Directory	65
Index	66

Accessories



Remote Control
(076N0HR01A)

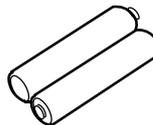

Batteries 2 "AAA"
(1411004015)

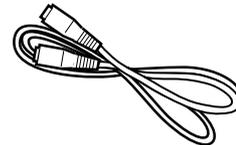

RF Cable
(06CPL02006)





Parts and functions

Front

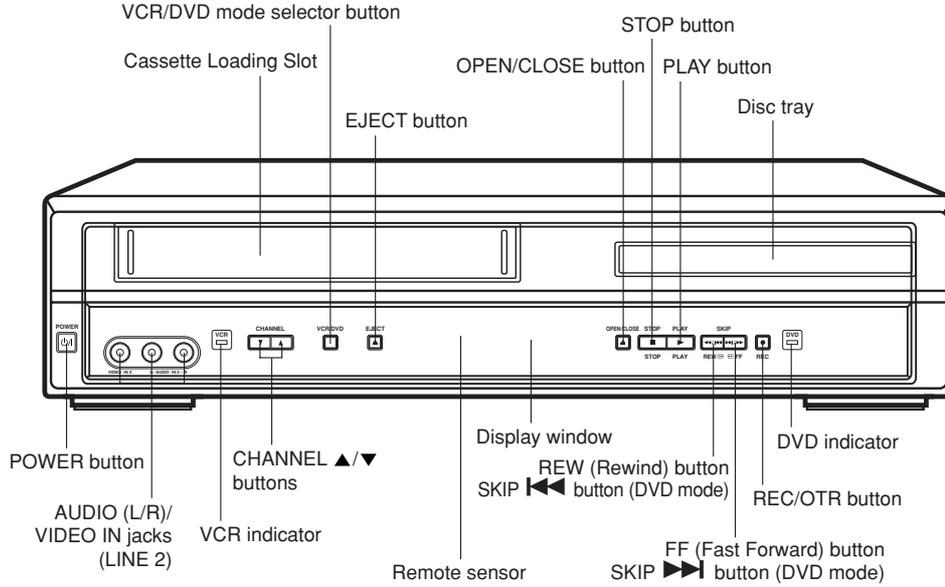

Rear

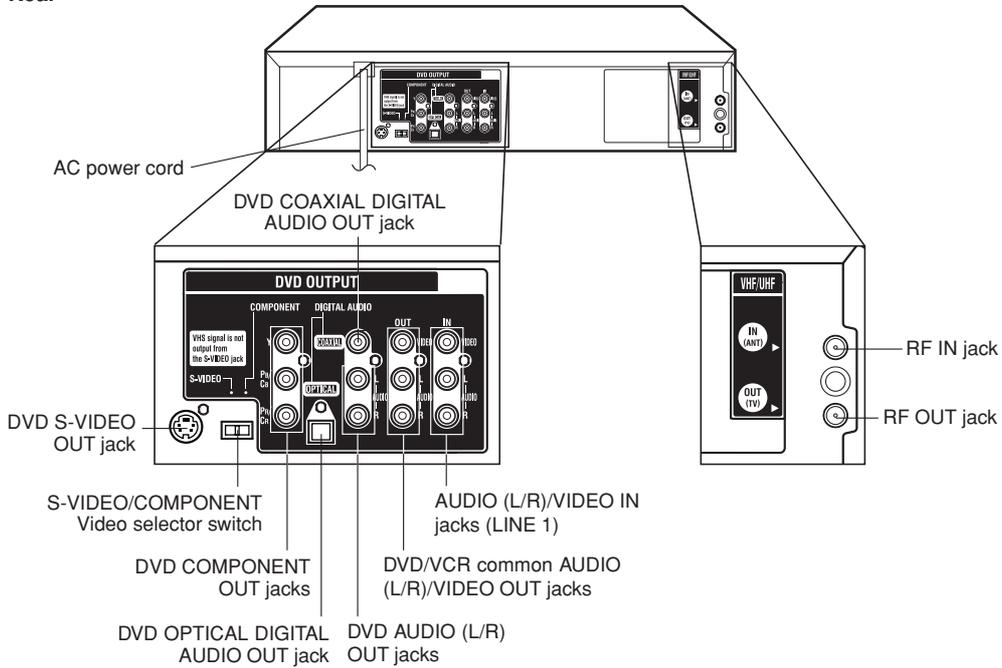



Display

Display window

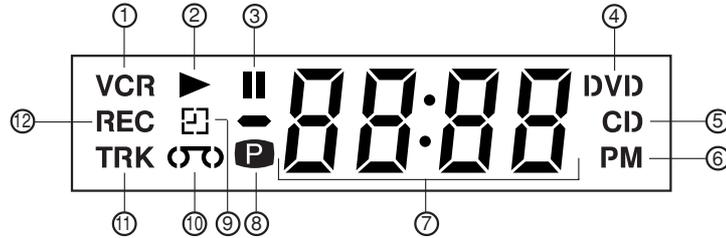

No.	Display	Description
①	VCR	When this unit and the TV are only connected by a coaxial cable, pressing the TV/VCR button on the remote control makes this display appear.
②	▶	Playback (lights) / Auto resume (flashes)
③	⏸	Still picture
④	DVD	DVD disc is inserted.
⑤	CD	CD is inserted.
⑥	PM	Display for afternoon (lights out in the morning)
⑦	10 : 00	Clock display (colon [:] flashes)
	01 : 00	Counter display by hour/minute at VCR/DVD / by minute/second at CD
	2	Track number display for CD
	CH02	TV channel display for VCR
	C036	Cable TV channel display
	L1, L2	External input display
	Err	Error display
⑧	P	Progressive scanning mode
⑨	⏮	Timer recording display
⑩	⏪	Video tape is in the unit
⑪	TRK	Track display for CD
⑫	REC	Normal recording display (flashes during One-touch Timer Recording - OTR)

NOTE:

Some discs may be displayed wrong or e.g. chapter number, playback time, etc. may not be displayed.





Remote control

- VCR/DVD**
See pages 18-23, 25, 27, 28, 30-32, 35-54
- POWER**
See pages 18, 21, 36
- 0-9**
See pages 23, 28, 30, 38, 41, 45, 47, 48
- ENTER**
See pages 18-23, 26, 31-33, 35, 36, 38-41, 43-54
- DVD MENU**
See pages 43, 45
- CH ▲/▼**
See pages 28, 30
- RETURN**
See page 35
- PLAY**
See pages 25, 26, 36, 37, 40, 41, 43-45, 48
- STOP**
See pages 25, 27, 29, 30, 36, 44, 45, 47
- INDEX/SKIP** ◀▶
See pages 27, 37, 45
- CM SKIP**
See page 26
- MARKER**
See page 39
- ANGLE**
See pages 43, 45
- COUNTER RESET**
See page 27
- AUDIO**
See pages 33, 42
- PLAY MODE**
See pages 40, 41
- SPEED**
See pages 28, 30, 34
- PROG TIMER**
See pages 31, 32
- JUMP**
See page 38
- ZERO SEARCH**
See page 27
- REC/OTR**
See pages 28, 30

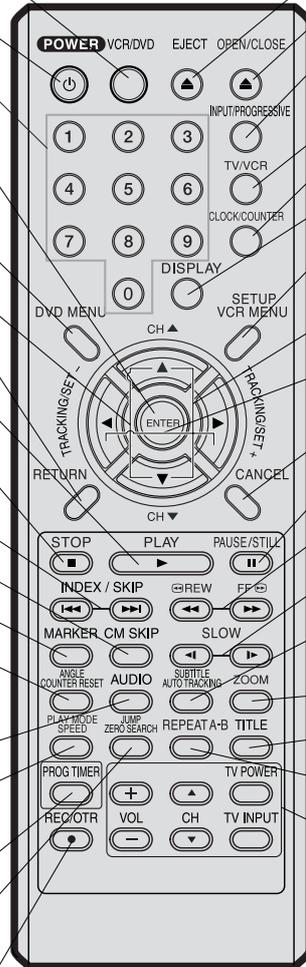

- EJECT**
See page 24
- OPEN/CLOSE**
See pages 36, 44, 45, 48
- INPUT**
See page 34
- PROGRESSIVE**
See page 35
- TV/VCR**
See pages 21, 29
- CLOCK/COUNTER**
See page 27
- DISPLAY**
See pages 26, 27, 29, 31, 38, 53
- SETUP**
VCR MENU
See pages 18-23, 26, 31-33, 35, 46, 47, 49-54
- ▲▼▶◀
See pages 35, 36, 38-54
- TRACKING +/-**
See page 26
- SET +/-**
See pages 18-23, 26, 31-33
- CANCEL**
See pages 20, 31, 32, 38, 39, 41, 47
- PAUSE/STILL**
See pages 26, 29, 37
- REW/FF**
See pages 25, 26, 37
- SLOW +/-**
See pages 26, 37
- SUBTITLE**
See page 42
- AUTO TRACKING**
See page 26
- ZOOM**
See pages 38, 45
- TITLE**
See pages 43, 45
- REPEAT A-B**
See page 40
- TV control buttons**
Notes:
 - Only Panasonic TVs can be operated using this remote control.
 - There may be some TV models that cannot be operated with this remote control. If this is the case, use the original remote control supplied with the TV.
 - POWER button
 - INPUT select button
 - CH (Channel) ▲/▼ buttons
 - VOL (Volume) + / - buttons





Inserting Batteries

- 1 Open the battery compartment cover.
- 2 Install two "AAA" batteries paying attention to the polarity diagram in the battery compartment.
- 3 Replace the compartment cover.

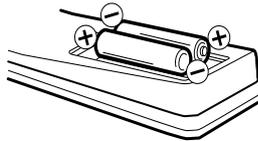

Battery precautions

The precautions below should be followed when using batteries in this device:

1. Use only the size and type of batteries specified.
2. Be sure to follow the correct polarity when installing the batteries as indicated in the battery compartment. Reversed batteries may cause damage to the device. To avoid a potential short circuit, insert the "-" end first.
3. Do not mix different types of batteries together (e.g. Alkaline and Carbon-zinc) or old batteries with fresh ones.
4. If the device is not to be used for a long period of time, remove the batteries to prevent damage or injury from possible battery leakage.
5. Do not try to recharge batteries not intended to be recharged; they can overheat and rupture. (Follow battery manufacturer's directions.)

Remote control operations

- Aim the remote control at the remote sensor and press control buttons to operate.
- Operate the remote control within 30° angle on either side of the remote sensor, up to a distance of Approx. 5 meters.

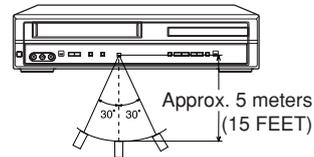

Power source

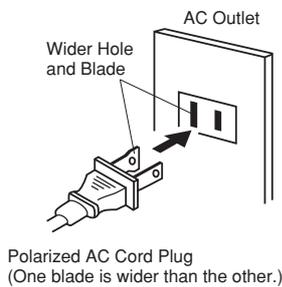

TO USE AC POWER SOURCE

Use the AC polarized line cord provided for operation on AC. Insert the AC cord plug into a standard 120V 60Hz polarized AC outlet.

NOTES:

- Never connect the AC line cord plug to other than the specified voltage (120V 60Hz). Use the attached power cord only.
- If the polarized AC cord does not fit into a non-polarized AC outlet, do not attempt to file or cut the blade. It is the user's responsibility to have an electrician replace the obsolete outlet.
- If you cause a static discharge when touching the unit and the unit fails to function, simply unplug the unit from the AC outlet and plug it back in. The unit should return to normal operation.





Basic connections

If you are using an antenna system, follow these instructions. If you are a Cable TV subscriber, skip ahead to page 14 for the proper connections.

ANTENNA TO DVD/VCR CONNECTION

The DVD/VCR must be connected "between" the antenna and the TV. First, disconnect the antenna from the TV and connect it to the DVD/VCR. Then connect the DVD/VCR to the TV. Below are 3 common methods of connecting an antenna system to a DVD/VCR. Find the type of antenna system you are using and follow the connection diagram.

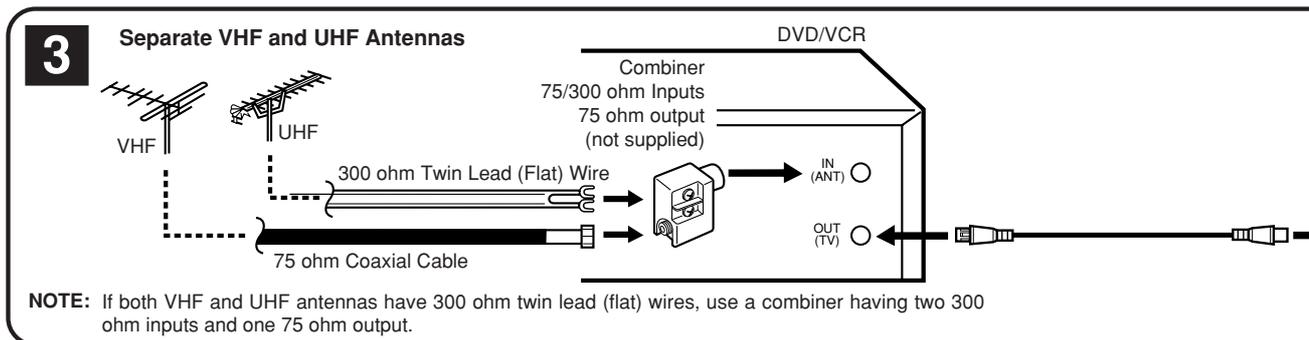
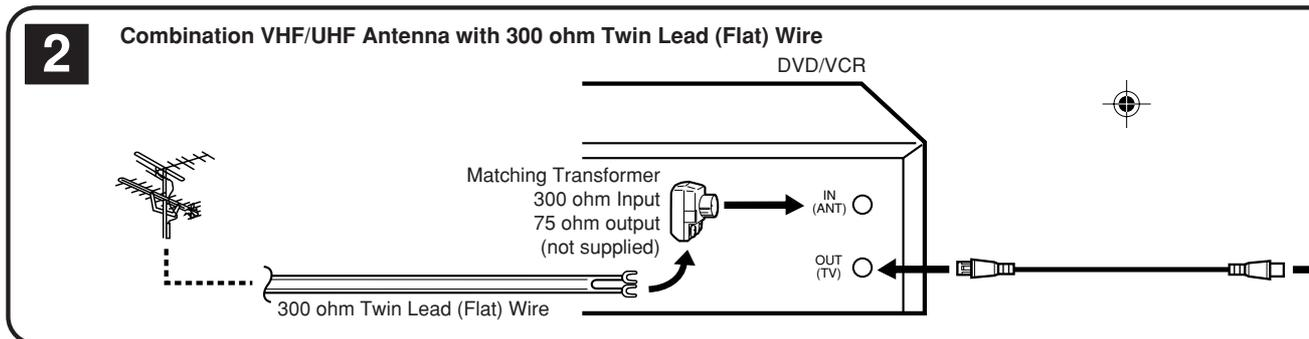
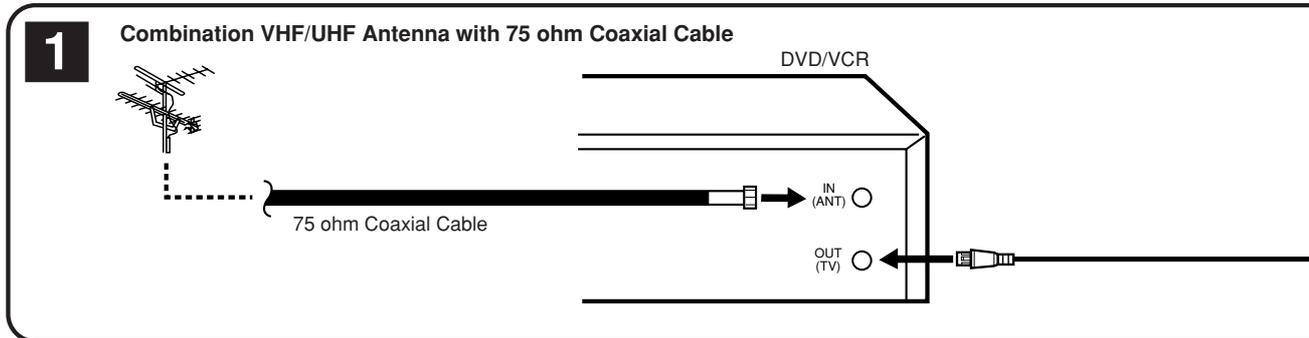

- NOTES:**
- A clear picture will not be obtained by the DVD/VCR unless the antenna signal is good. Connect the antenna to the DVD/VCR properly.
 - For better quality recording, an indoor antenna or a telescopic antenna is not recommended. The use of an outdoor type antenna is required.
 - If you are not sure about the connection, please refer to qualified service personnel.





DVD/VCR TO TV CONNECTION

After you have connected the antenna to the DVD/VCR, you must connect the DVD/VCR to the TV. Below are 3 common methods of connecting your DVD/VCR to a TV. Find the type of TV you are using and follow the connection diagram.

This DVD/VCR has a single 75 ohm output for connection to a TV. If your TV has separate VHF and UHF antenna inputs (numbers 2 and 3 below), use a splitter to connect the DVD/VCR to the TV for VHF and UHF reception.

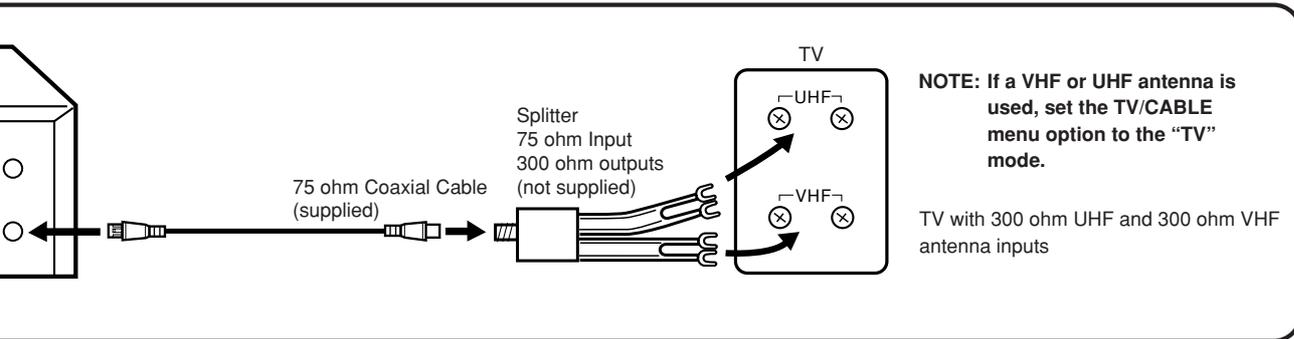
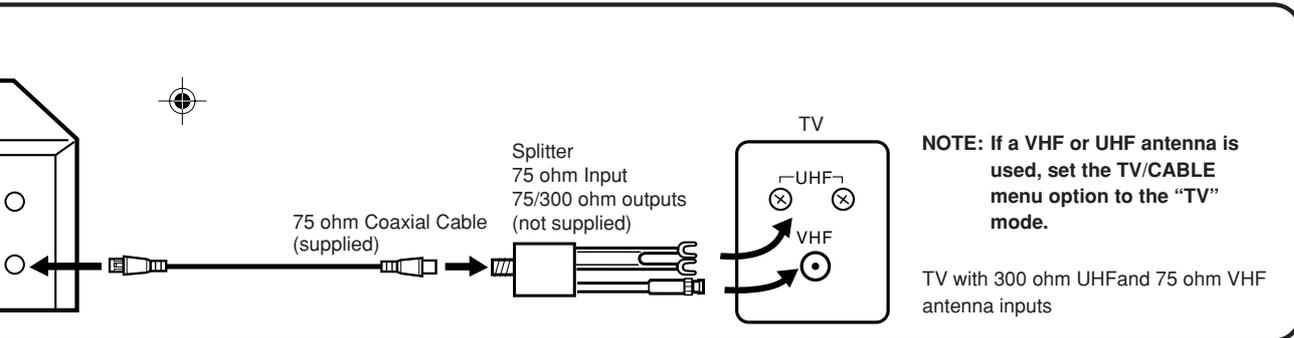
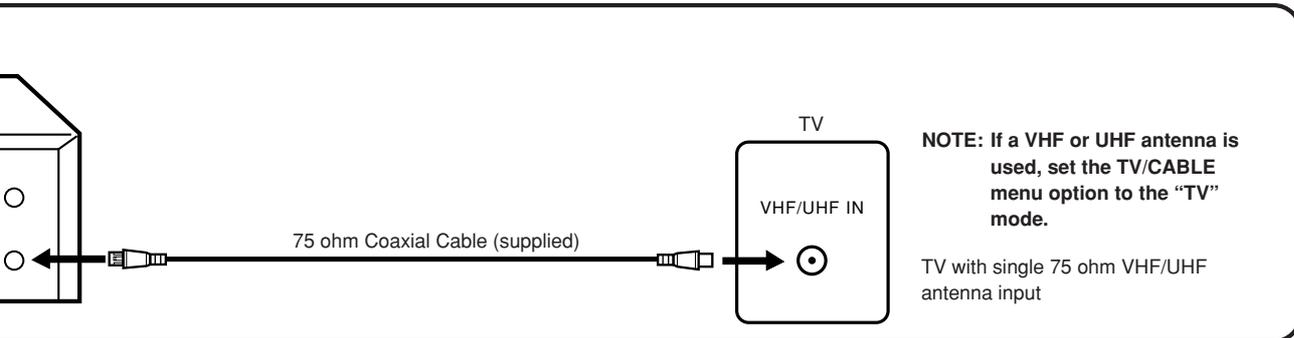



Cable TV connections

Many cable companies offer services permitting reception of extra channels including pay or subscription channels. This DVD/VCR has an extended tuning range and can be tuned to most cable channels without using a cable company supplied converter box, except for those channels which are intentionally scrambled. If you subscribe to a special channel which is scrambled, you must have a descrambler box for proper reception.

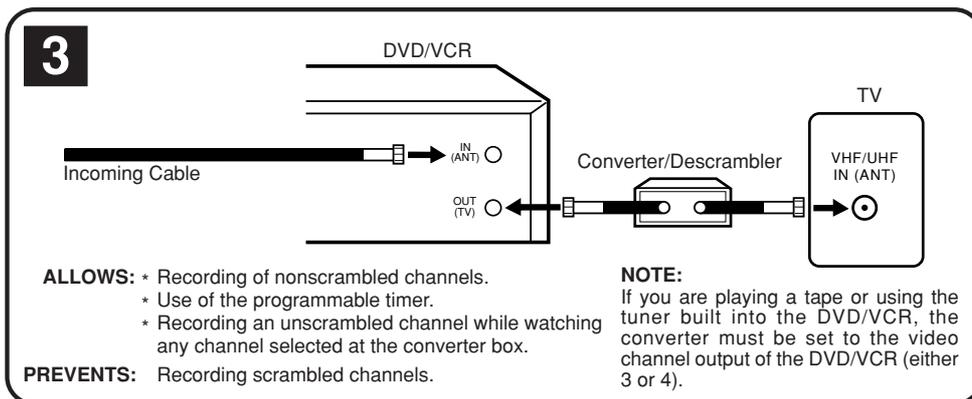
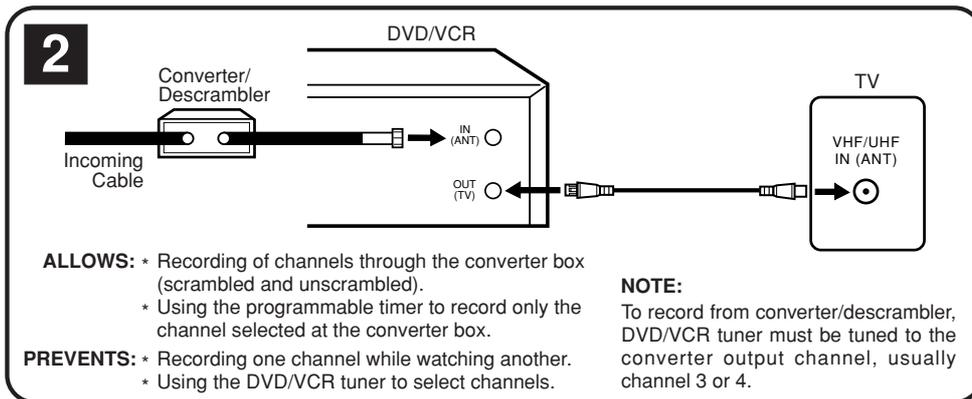
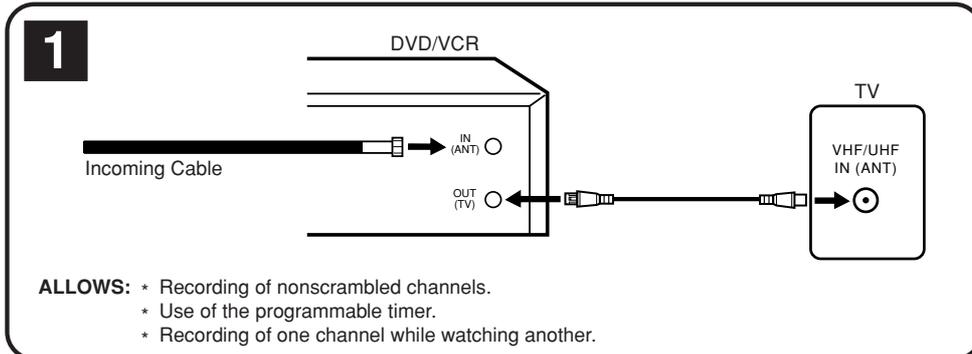

NOTE: Whenever a Converter/Descrambler box is placed before the DVD/VCR, you must tune the DVD/VCR to the output of the Converter/Descrambler box, usually channel 3 or 4.





IMPORTANT: Make sure the TV/CABLE menu option is set to the "CABLE" mode.

This DVD/VCR cannot receive scrambled programs since it does not contain a descrambler. In order to receive scrambled programs, your existing descrambler must be used. Descrambler boxes are available from cable companies. Consult your local cable company for more information concerning connection to their descrambler equipment. There are many ways to connect your DVD/VCR to a cable system. Below are six common methods of connection.

4

ALLOWS:

- * Recording of one channel while watching another.
- * Using the programmable timer to record only the channel selected at the converter box.
- * Recording of all channels through the converter box.

PREVENTS:

- * Watching scrambled channels while recording another channel.
- * Using the DVD/VCR tuner to select channels.

5

ALLOWS:

- * Recording of nonscrambled channels.
- * Recording of one channel while watching another.
- * Watching premium channels through the converter while recording nonscrambled channels.
- * Using the programmable timer.

PREVENTS: Recording scrambled channels.

6

ALLOWS:

- * Recording of all channels through the converter box.
- * Recording a scrambled or unscrambled channel while watching another (scrambled or unscrambled) channel.
- * Using the programmable timer to record only the channel selected at the converter box.

PREVENTS: Using the DVD/VCR tuner to select channels.





Playback connections

The exact arrangement you use to interconnect various video and audio components to the DVD/VCR is dependent on the model and features of each component. Check the Owner's Manual provided with each component for the location of video and audio inputs and outputs.

Connect to a TV with Audio/Video Output

You can enjoy playback by connecting the unit to a TV.

Connect the unit to a TV equipped with audio input (L/R) and video input jacks using the audio/video cable (not supplied).

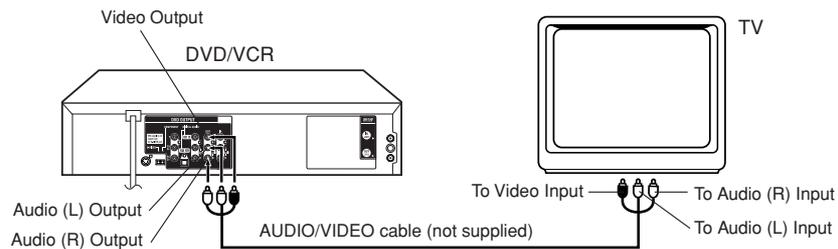

Connect to a TV with S-Video Output (for DVD playback)

If your TV has an S-VIDEO input, you can get higher quality by connecting it with the S-VIDEO output of the unit using the S-video cable instead of connecting the video input of the TV to the VIDEO jack of the unit.

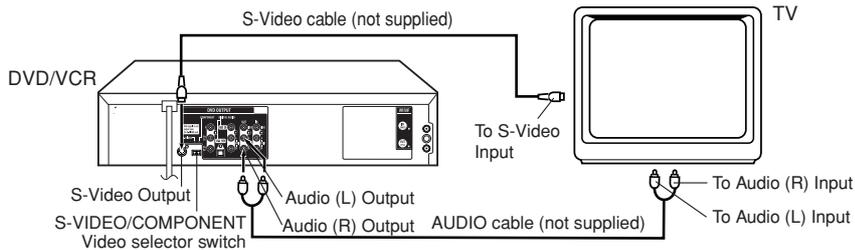

Connect to a TV with Component Video Output (for DVD playback)

You can enjoy high quality picture by connecting the unit's COMPONENT VIDEO OUT jacks to the COMPONENT VIDEO IN jacks of your TV with the COMPONENT video cables (not supplied).

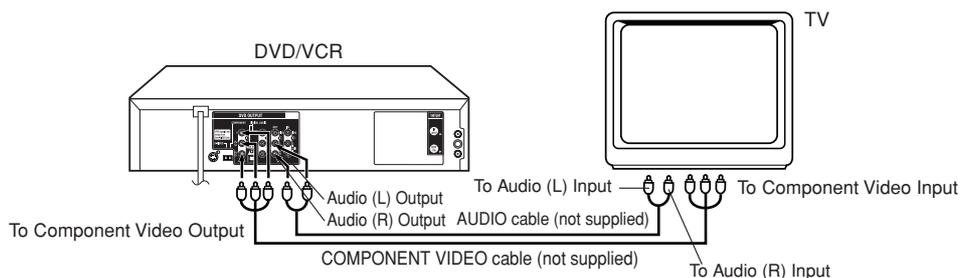

NOTES:

- When you connect to a TV with S-video jack or component jacks, set the S-VIDEO/COMPONENT Video selector switch to the desired position. And also you must select the corresponding video input on your TV.
- When connecting to a TV using the VIDEO or S-VIDEO jack, make sure that the PROGRESSIVE indicator on the display window is not lit. If it is lit, the VIDEO and S-VIDEO outputs do not feed the correct signals and you cannot see any picture. To turn off the PROGRESSIVE indicator, make the Progressive scanning mode inactive (see page 35).





Connect to a Stereo Amplifier with Audio Output

You can enjoy high quality audio by connecting the audio output to your amplifier. Connect the AUDIO OUT jacks to any line-level inputs (such as AUX, DVD, CD, etc.) of an audio amplifier.

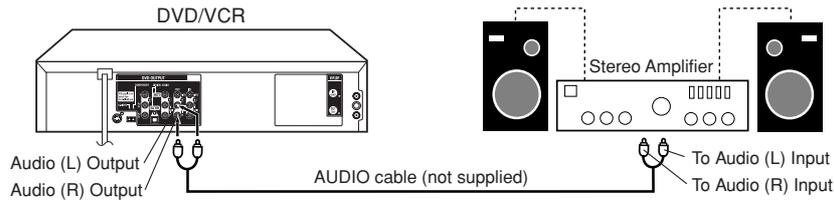

Connect to an AV Amplifier with built-in digital surround

If you are using an Amplifier with a built-in digital surround as follows, you can enjoy the various audio systems such as Dolby Digital and DTS by using the Optical or Coaxial Digital Output.

- Use this connection to connect an:
- AV amplifier with built-in *Dolby Digital decoder
 - AV amplifier with built-in *DTS decoder

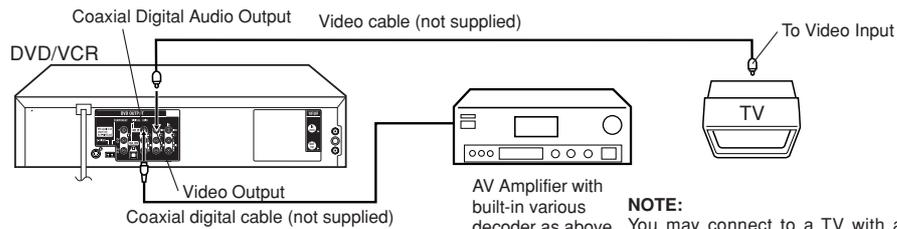

NOTE:
You may connect to a TV with a Component video cable (not supplied) or S-Video cable (not supplied) instead of a video cable (not supplied).

Connecting the optical digital cable

You may connect to an AV Amplifier with an Optical digital cable (not supplied) instead of a Coaxial digital cable. When you connect the optical digital cable (not supplied), remove the dust protection cap from the rear panel. When not using the optical digital cable, attach the dust protection cap to protect against dust.

NOTES:

- The DVD OUTPUT jacks (OPTICAL, COAXIAL, AUDIO L/R, S-VIDEO and COMPONENT) are useful only for DVD section. The VHS signal is output only from the composite jacks (DVD/VCR OUTPUT) and UHF/VHF OUT.
- When you make the connections above, do not set DOLBY DIGITAL to DOLBY DIGITAL or DTS to ON on the AV Amplifier. If you do, a loud noise will suddenly come out from the speakers, affecting your ears or causing the speakers to be damaged.
- Caution for the **optical** digital audio output connector: Do not connect to an amplifier (with an optical digital input connector) which does not contain a Dolby Digital or DTS decoder. Otherwise, any attempt to play DVDs may cause such a high level of noise that it may be harmful to your ears and damage your speakers.
- DTS audio will be output only from the COAXIAL or OPTICAL output. To hear DTS audio, DTS-Decoder is necessary.
- When playing DTS-encoded CDs, only noise will be heard from the speakers or analogue stereo outputs.
- Some DTS decoders which do not support DVD-DTS interface may not work properly with the unit.





Auto clock setting

The Auto Clock feature enables the automatic clock setting and updating, and also to set the Time Zone and Daylight Saving Time by receiving XDS (Extended Data Service) information carried on the channel signal.

Preparation:

You must set the antenna connection before the AC cord plug is inserted into the AC outlet.

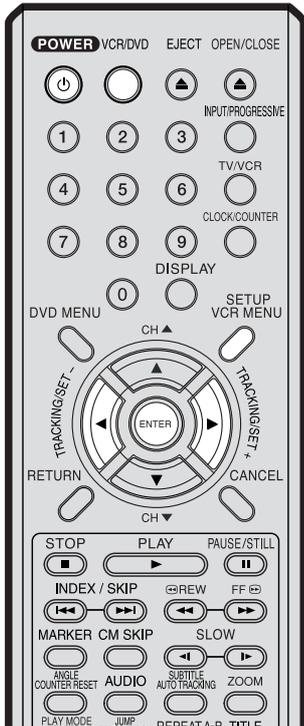

Auto clock setting

WAIT 30 MINUTES! when the power switch is off, after the connections of the antenna and the power plug. Because the Auto Clock setting feature is activate.

After the clock is set automatically, you may have to set the Time Zone and Daylight Saving Time.

Press **POWER** to turn on the DVD/VCR after the Auto Clock operation completed.

- When shipped from factory, the "Auto Clock" option is set to "ON" position.
- If you turn the DVD/VCR on during Auto Clock setting, the clock is not set.
- With cable box connection, if the Auto Clock Setting is unsuccessful, please select the PBS channel carrying the XDS information, then turn the DVD/VCR off. After 30 minutes, turn the DVD/VCR on, and if the clock is not set automatically, set the clock manually. (See page 20)

Time Zone setting (STANDARD TIME)

In the rare event that you live within broadcast range of two stations in two different time zones, the DVD/VCR may recognize the wrong station for the Auto Clock set. To correct the situation:

Preparation:

- Turn ON the TV and set to the video input mode.
- Press **VCR/DVD** to select the VCR mode. (The VCR indicator will light.)

1 Press **VCR MENU**. The VCR menu screen will appear. Press **SET + or -** to select the "SYSTEM SETUP" menu, then press **ENTER**.

2 Press **SET + or -** to select the "STANDARD TIME" option, then press **ENTER**.

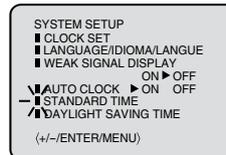

3 Press **SET + or -** to select your Time Zone, then press the **ENTER**.
ATLANTIC : GMT - 4 hours
(GMT: Greenwich Mean Time)

- EASTERN : GMT - 5 hours
- CENTRAL : GMT - 6 hours
- MOUNTAIN : GMT - 7 hours
- PACIFIC : GMT - 8 hours
- ALASKA : GMT - 9 hours
- HAWAII : GMT - 10 hours
- AUTO : AUTO SET

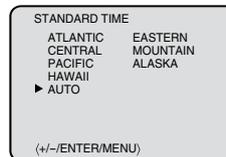

4 Press **VCR MENU** until the MENU screen is cleared.

NOTES:

- **If the unit does not operate properly, or No key operation (by the unit and/or the remote control):** Static electricity, etc., may affect the player's operation. Disconnect the AC power cord once, then connect it again.
- Both the VCR and the DVD have their own menu option (See page 35).
- If no buttons are pressed for more than 60 seconds, the MENU screen will return to normal TV-operation automatically.
- When shipped from factory, the "Time Zone" option is set to "AUTO" position.
- After Auto Clock setting, in some case the clock may display the other time zone's. You can correct the clock by selecting your Time Zone setting above.
- When the clock is not set or you set the clock manually, Time Zone setting is not available.





Daylight Saving Time setting

You can set the Daylight Saving Time "ON" or "OFF".

Preparation:

- Turn ON the TV and set to the video input mode.
- Press **VCR/DVD** to select the VCR mode. (The VCR indicator will light.)

- 1 Repeat the step 1 on page 18 and press **SET +** or **-** to select "DAYLIGHT SAVING TIME" option, then press **ENTER**.

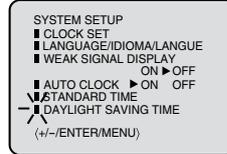

- 2 Press **SET +** or **-** to select "ON" or "OFF", then press **ENTER**.



- ON:** forward one hour
OFF: back one hour

When you want to set the Daylight Saving Time, on the first Sunday in April you set to "ON", and on the last Sunday in October you set to "OFF".

NOTES:

- When shipped from factory, the "Daylight Saving Time" option is set to "OFF" position.
- When the clock is not set, Daylight Saving Time setting is not available.
- When there is no Daylight Saving Time in your area, always select "OFF" position in step 2.

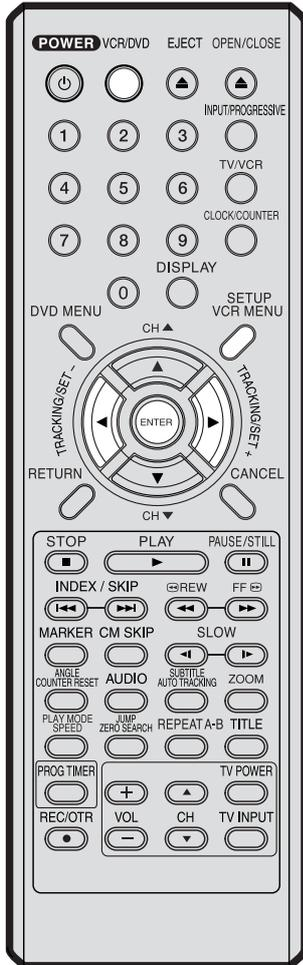



Manual clock setting

You must set the date and time for timer recordings and Daylight Saving Time if the Auto Clock process did not set them correctly.

Preparation:

- Turn ON the TV and set to the video input mode.
- Press **VCR/DVD** to select the VCR mode. (The VCR indicator will light.)

EXAMPLE: Setting the clock to "8:30 AM" October, 30 (SAT), 2004.

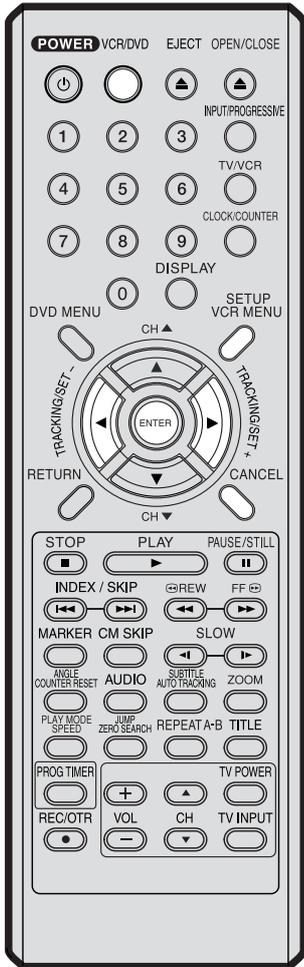

1 Press **VCR MENU**. The VCR menu screen will appear.

2 Press **SET + or -** to select the "SYSTEM SETUP" menu, then press **ENTER**.

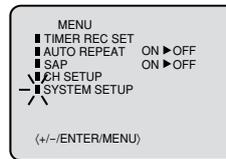

3 Press **SET + or -** to select the "CLOCK SET" option, then press **ENTER**.

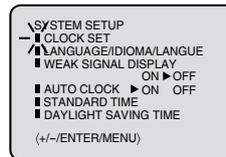

4 Press **SET + or -** to set the month, then press **ENTER**.



To make corrections any time during the process
Press **CANCEL** repeatedly until the item you want to change blinks, then press **SET + or -**.

5 Set the day, year and time as in step 4.

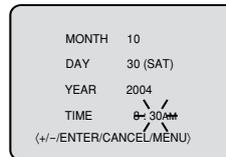

6 After setting the clock, date and time starts functioning automatically.



NOTE:
After a power failure or disconnection of the power, the timer settings will be lost. In this case, reset the present time.





Setting the video channel / Setting the language

Setting the video channel

To view playback of a recorded tape or DVD disc, or to watch a program selected by the VCR's channel selector, the TV must be set to channel 3 or 4 (video channel).

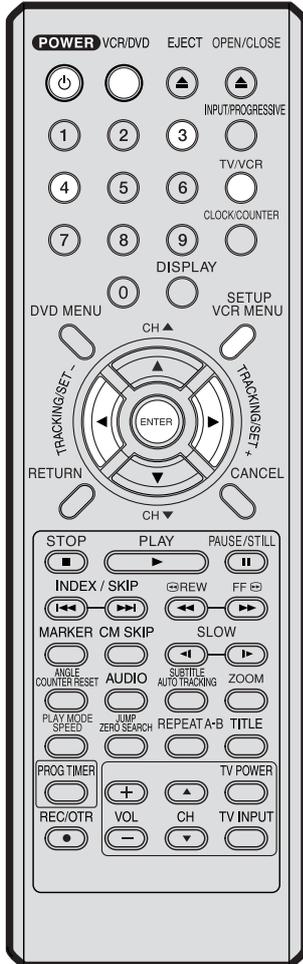

NOTE:
When shipped from factory, the video channel is set to CH 3.

When a TV is connected with the 75 ohm coaxial cable only.

- 1 Press and hold **3** or **4** on the remote control for 3 seconds in the standby mode to select CH 3 or 4. The selected channel number will flash on the display for about 4 seconds.
- 2 Turn ON the TV and set to CH 3 or 4 to correspond with the channel selected in step 1.
- 3 Press **POWER** to turn on the DVD/VCR.
- 4 Press **VCR/DVD** to select the VCR mode. The VCR indicator on the front panel will light.
- 5 Press **TV/VCR** to select the VCR position. The VCR indicator will appear in the display.
- 6 Select any channel to receive a TV station in your area. The channel number will appear on the screen for about 4 seconds.

For a push-button TV tuner

If CH 3 or 4 corresponding to the video channel cannot be tuned on your TV, proceed as follows: set the VCR 3/4 channel selector and the TV to CH 3 or 4, play back a prerecorded tape and tune the TV to receive a sharp color picture from the video cassette recorder. Refer to your TV owner's manual for details.

Setting the language

You can choose from three different languages (English, French and Spanish) for the on-screen displays.

Preparation:

- Turn ON the TV and set to the video input mode.
- Press **VCR/DVD** to select the VCR mode. (The VCR indicator will light.)

- 1 Press **VCR MENU**.
The VCR menu screen will appear. Press **SET +** or **-** to select the "SYSTEM SETUP" menu, then press **ENTER**.
If you use the unit for the first time and press **VCR MENU**, instead of the main menu screen on the right the "SYSTEM SETUP" menu screen in step 2 may appear.

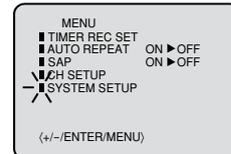

- 2 Press **SET +** or **-** to select the "LANGUAGE" option, then press **ENTER**.

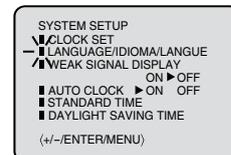

- 3 Press **SET +** or **-** to select the desired language: English (ENGLISH), Spanish (ESPAÑOL) or French (FRANCAIS), then press **ENTER**.



- 4 Press **VCR MENU** until the MENU screen is cleared.

21





Tuner setting

This DVD/VCR is equipped with a channel memory feature which allows channels to skip up or down to the next channel set into memory, skipping over unwanted channels. Before selecting channels, they must be programmed into the DVD/VCR's memory. In addition to normal VHF and UHF channels, this DVD/VCR can receive up to 113 Cable TV channels. To use this DVD/VCR with an antenna, set the TV/CABLE menu option to the TV mode. When shipped from the factory, this menu option is in the CABLE mode.

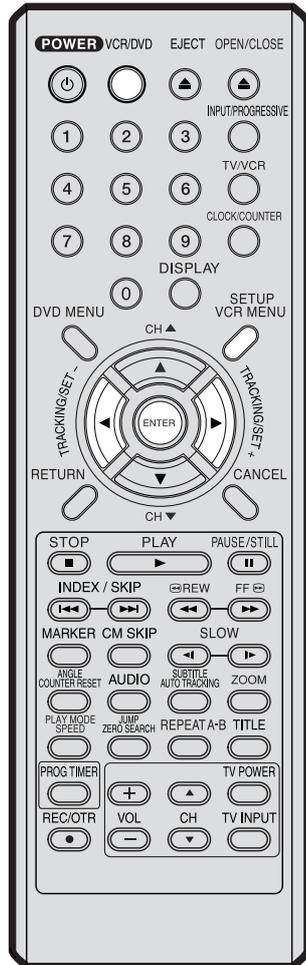

Preparation:

- Turn ON the TV and set to the video input mode.
- Press **VCR/DVD** to select the VCR mode. (The VCR indicator will light.)

TV/CABLE selection

1 Press **VCR MENU**. The VCR menu screen will appear. Press **SET +** or **-** to select "CH SETUP", then press **ENTER**.

2 Press **SET +** or **-** to select the "TV/CABLE" option.

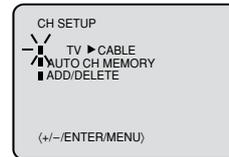

3 Then press **ENTER** to select the TV or CABLE mode. The arrow indicates the selected mode.

TV - VHF/UHF channels
CABLE - Cable TV channels

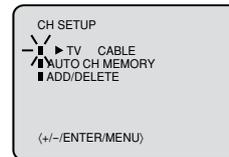

4 Press **VCR MENU** until the menu screen is cleared.

Setting channels automatically

The VCR can receive a maximum of 181 channels by presetting the channels into memory.

1 Repeat above step 1 and press **SET +** or **-** to select "AUTO CH MEMORY".

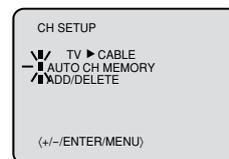

2 Then press **ENTER**. The auto tuning will start. The channel display will count up and when finished, the screen returns to normal.

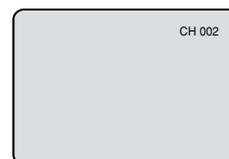

NOTE:

You can't select "CH SETUP" if you set the channel to "LINE 1" or "LINE 2".





To ADD/DELETE channels / Weak signal display

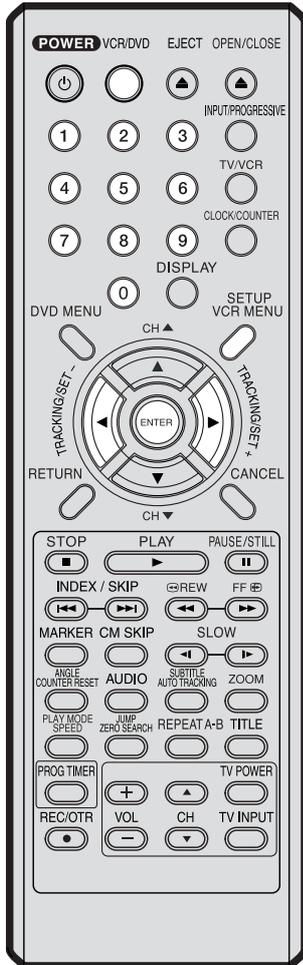

Preparation:

- Turn ON the TV and set to the video input mode.
- Press **VCR/DVD** to select the VCR mode. (The VCR indicator will light.)

To ADD/DELETE channels

You can add the channels you want or delete the channels you do not want manually.

- 1 Repeat the step 1 on page 22. Then press **SET +** or **-** to select the "ADD/DELETE" option and press **ENTER**.

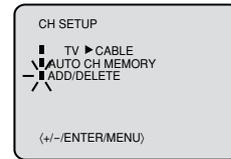

2 To Add or Delete desired channels

- 1 Press **Number keys** or **SET +** or **-** to select a channel number you want to add or delete.
- 2 **To add channels**
Press **ENTER** until "ADD" appears on the screen to set to add the unmemorized channel.

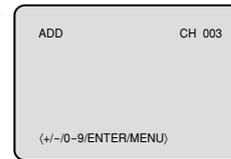

To delete channels

Press **ENTER** until "DELETE" appears on the screen to set to delete the channel from memory. The channel number will blink.

- 3 Repeat **1** and **2** to add or delete other channel.

3 Press VCR MENU until the menu screen is cleared.

Weak signal display

When you don't want to receive a weak signal broadcast, the Blue back screen can be obtained by selecting the "WEAK SIGNAL DISPLAY" option "ON". When the unit is shipped from the factory, the "WEAK SIGNAL DISPLAY" option is set to the "OFF".

- 1 Repeat the steps 1-2 on page 21 and press **SET +** or **-** to select "WEAK SIGNAL DISPLAY" option.

- 2 Press **ENTER** to select the "ON" position.

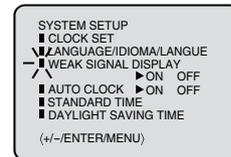

- 3 Press **VCR MENU** until the menu screen is cleared.





Loading and Unloading a cassette tape

Use only video cassette tapes marked **VHS**.

Loading

Push the center of the tape until it is automatically inserted.

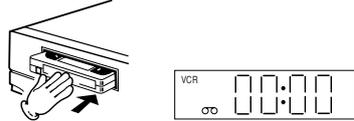

Insert the cassette tape with its labeled side facing up and the erase prevention tab positioned at your left. An inverted cassette tape cannot be inserted.



Automatic power ON

When you insert a cassette tape the VCR power will turn ON automatically.

Automatic playback

When loading a cassette tape without an erase prevention tab, playback will start automatically.

Unloading

1 Press **EJECT** on the unit or the Remote.

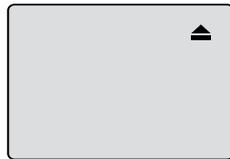

2 Remove the cassette tape.

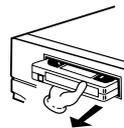

Automatic tape eject

This VCR will automatically rewind the tape when the tape has ended. And when the tape is rewinded to its beginning, the cassette tape will be ejected automatically.

To prevent accidental erasure

Remove the erase prevention tab with a screwdriver.

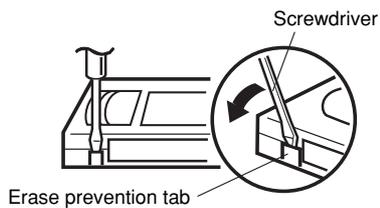

To record again

Cover the hole with a piece of adhesive tape.

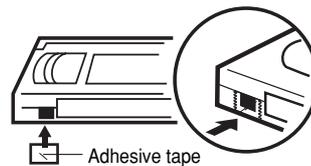

Tape speed and maximum recording time

Tape Speed	Video cassette tape				
	T-160	T-120	T-90	T-60	T-30
SP (Standard Play)	2-2/3 hours	2 hours	1-1/2 hours	1 hour	30 minutes
SLP (Super Long Play)	8 hours	6 hours	4-1/2 hours	3 hours	1-1/2 hours





Cassette tape playback

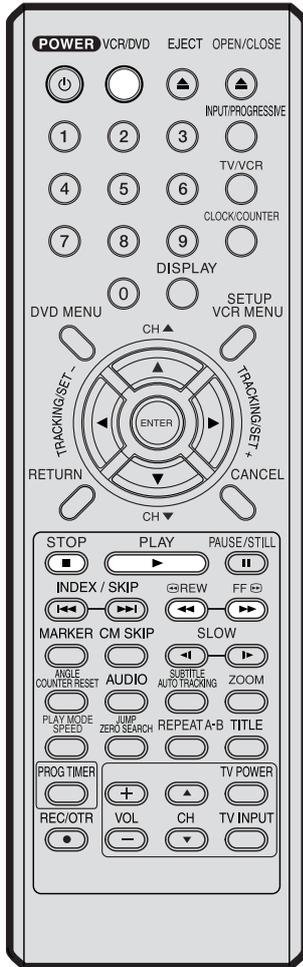

NOTES:

- This VCR selects the playback tape speed SP, LP or SLP automatically.
- The Cassette tape and DVD disc can be played back simultaneously. If you press **VCR/DVD**, the tape playback and DVD playback alternate with each other on the screen.

Preparation:

- Turn **ON** the TV and set to the video input mode.
- Press **VCR/DVD** to select the VCR mode. (The VCR indicator will light.)
- Load a prerecorded tape (When loading a cassette tape without the erase prevention tab, playback will start automatically).

To start playback

Press **PLAY**.
Playback will start.
"▶" will appear on the screen for about 4 seconds.



To stop playback

Press **STOP** once.
The tape will stop but remain fully loaded and ready to play.
"■" will appear on the screen for about 4 seconds.

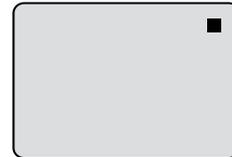

To rewind the tape or forward it rapidly

Stop the playback or recording with **STOP**.

To rewind the tape:

Press **REW**.



To forward the tape:

Press **FF**.

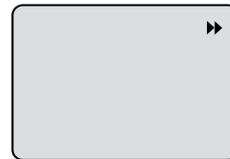

To stop the tape-winding, press **STOP**. To switch to playback directly (without **STOP**), press **PLAY**.

Forward/Reverse picture search mode

When the tape is being winded, you can switch to picture search mode (see next page). To do this, press **REW** or **FF** and hold it down. The unit will resume the tape winding as soon as the button is released.





Special playback

Picture Search

Reverse picture search function

Press **REW** x 1 or x 2 during the playback.

Forward picture search function

Press **FF** x 1 or x 2 during the playback.

To return to playback: Press **PLAY**.

SPEED SEARCH TIMES

TAPE SPEED	PICTURE SEARCH SPEED	
	PRESS ONCE	PRESS TWICE
SP (Standard Play)	3 X	5 X
LP (Long Play)	7 X	9 X
SLP (Super Long Play)	9 X	15 X

Still Picture

Press **PAUSE/STILL** during playback. To resume normal playback: Press **PLAY** or **PAUSE/STILL**.

Slow Motion

During playback press **SLOW** **I▶**.

To return to playback: Press **PLAY** or **SLOW** **I▶**.

Slow tracking and vertical lock adjustment

If noise bars appear in the picture during slow motion, press the **TRACKING +** or **-** to reduce the noise bars. If the still picture jitters excessively, press **TRACKING +** or **-** to stabilize the still picture.

Frame by Frame picture

Press **PAUSE/STILL** during playback.

Press **SLOW** **I▶** one by one: The picture advances frame by frame.

To return to playback: Press **PLAY** or **PAUSE/STILL**.

Adjusting tracking condition

Automatic tracking adjustment

Whenever you insert a tape and start playback, automatic tracking starts working and continuously analyzes the signal to enable optimum picture quality during playback.

Manual tracking adjustment

If automatic tracking cannot eliminate noises well during playback, press **TRACKING +/-** to eliminate the noises. "MANUAL TR." will appear. Press it briefly for a fine adjustment, or press and hold for a coarse adjustment.

- Press **AUTO TRACKING** to reactivate automatic tracking again. "AUTO TR." will appear.

NOTES:

- The audio output is muted during SPEED SEARCH, STILL, FRAME ADVANCE and SLOW MOTION.
- During picture search mode there will be noise bars which are caused by the system.
- The Special Playback will automatically change to playback after approx. 5 minutes to protect the video tape against excessive wear.

Repeat playback

The entire video tape will be played until its end. The tape will then automatically rewind to the beginning and the playback will be repeated.

1 Press **VCR MENU**. Press **SET +** or **-** to select "AUTO REPEAT" option.

2 Then press **ENTER** to select "ON" or "OFF". If "ON" is selected, the playback will be repeated endlessly.

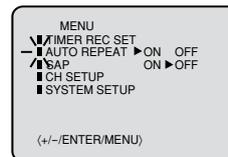

3 Press **VCR MENU** until the menu screen is cleared.

if you press **DISPLAY**, "Ⓞ" will appear on the screen.

4 To start the playback, press **PLAY**. The playback will be repeated endlessly.

To cancel repeat mode:

Follow the above step 1, then press **ENTER** to select the "OFF" position. Press **VCR MENU** to return to the TV.

Commercial Skip

Press **CM SKIP** during playback.

The VCR will search forward through approximately 30 seconds of the tape (e.g. unwanted commercial time) for each press of **CM SKIP** (maximum six presses) and then resume normal playback.





ZERO SEARCH function / Video index search system

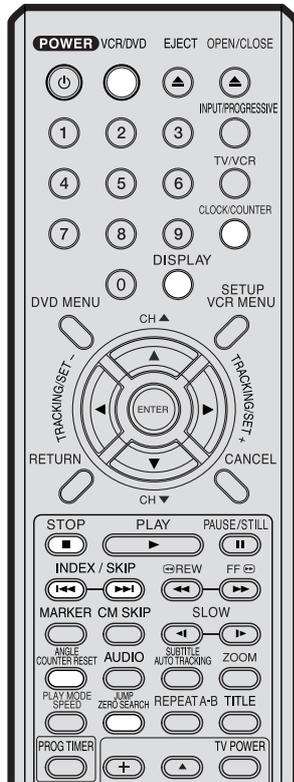

Preparation:

- Turn ON the TV and set it to the video input mode.
- Press **VCR/DVD** to select the VCR mode. (The VCR indicator will light.)

ZERO SEARCH function

This function makes tape-rewinding stop at the counter 00:00:00 position automatically.

- 1 Press **DISPLAY**.
The counter display shows the tape running time during playback or recording.

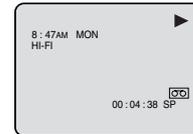

- 2 Press **COUNTER RESET** at the desired tape position. The counter display will be reset to the "00:00:00" position (e.g. the beginning of recording).



- 3 Press **STOP** when playback or recording is finished. Press **ZERO SEARCH**.
The tape will be rewinded or fast forwarded and automatically stop at the "00:00:00" position.

The CLOCK/COUNTER-button

Press **CLOCK/COUNTER**. The clock and tape counter alternate with each other in the display.

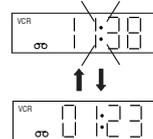

NOTES for Counter Display:

- If you rewind the tape beyond "00:00:00", a minus sign ("-") will be displayed in front of the time.
- When you load a tape, the counter will reset to "00:00:00".
- The counter does not function on nonrecorded (blank) sections of the tape. When you rewind, fast forward or play tapes through blank sections, the counter stops.

NOTES for Video index search system:

- When you record an INDEX mark at the very beginning of the tape, the mark may not be found.
- During INDEX search, the tape may stop and begin to play at a slightly different location.
- INDEX may not function properly with old or worn out video tapes.
- INDEX marks may not be found if it is extremely close to the point where the search began.
- In recording, if you stop recording temporarily, the INDEX mark is not recorded on the tape.

Video index search system

This function enables you to locate the beginning of any recording made on the VCR.

Recording an INDEX MARK

The Index Search function automatically records an INDEX mark on the tape whenever a recording is initiated.

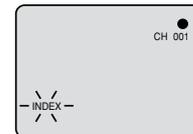

Index Search

Press **INDEX** **▶▶** or **◀◀** during stop or play mode.
For Succeeding programs: Press **INDEX** **▶▶**.
For Preceding programs: Press **INDEX** **◀◀**.
(Additional press increases the INDEX NO. up to 9.)

When the **INDEX** **▶▶** or **◀◀** is pressed, the unit starts searching the INDEX NO. **▶▶** or **◀◀** is displayed
INDEX NO. (up to 9)



To stop the Index Search, press **STOP**.





Recording a TV program

Recording and viewing the same TV program.

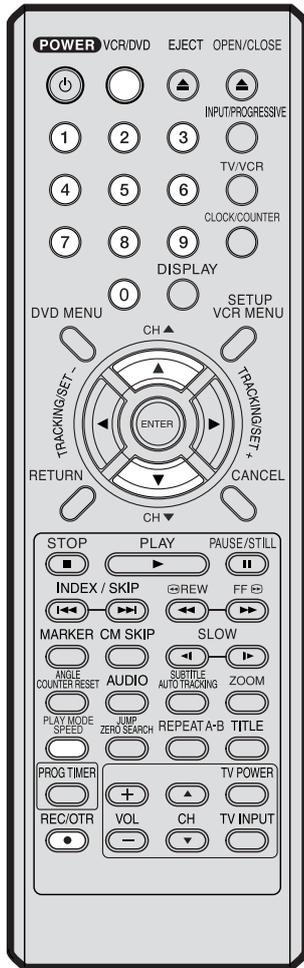

Preparation:

- Turn ON the TV and set to the video input mode.
- Press **VCR/DVD** to select the VCR mode. (The VCR indicator will light.)

- 1 Load a cassette tape with the erase prevention tab intact. The VCR will automatically turn on.

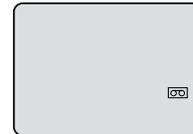

- 2 Press **SPEED** to select the desired tape speed SP or SLP. The tape counter and SP or SLP will appear on the screen for about 4 seconds.

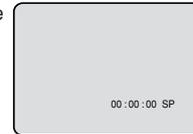

- 3 Set the TV/CABLE option to the appropriate position (See page 22).

TV - VHF/UHF channels
CABLE - Cable TV channels

- 4 Press **Number keys** or **CH ▲/▼** to select the channel to be recorded.

- 1-9 Press **0** twice and then **1-9** as required. Example: To select 2, Press "002".
- 10-12 Press **0** first and then the remaining 2 digits in order from left to right. Example: Press **012** for "12".
- 13-99 Press 2 digits in order. Example: Press **22** for "22".
- 100-125 Press the 3 digits in order. Example: Press **110** for "110".

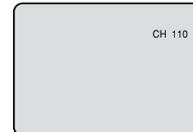

VHF/UHF/CABLE TV CHANNELS

TV	CABLE TV
VHF 2-13	VHF 2-13
UHF 14-69	STD/HRC/IRC 14-36 (A) (W) 37-59 (AA) (WW) 60-85 (AAA) (ZZZ) 86-94 (86) (94) 95-99 (A-5) (A-1) 100-125 (100)(125) 01 (5A)

NOTES:

- If the erase prevention tab is removed, the tape will eject when **REC/OTR** is pressed for recording.
- If you wish to watch the DVD playback during the normal recording on VCR, press **VCR/DVD** to change to DVD mode and perform the DVD playback (see page 36).
- You can not record disc material in DVD, Audio CD, etc. onto a video tape with this DVD/VCR.

- 5 Press **REC/OTR**. "●" will appear on the screen for about 4 seconds and "REC" will appear on the display.



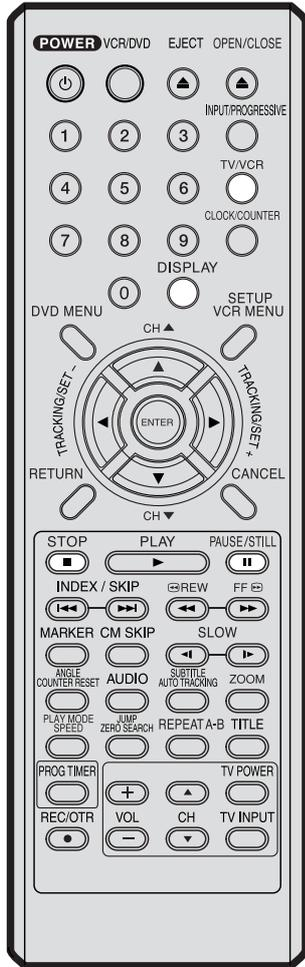

To stop recording

Press **STOP** to stop recording.
 "■" will appear on screen for about 4 seconds.

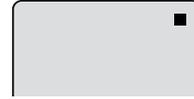

To stop recording temporarily

Press **PAUSE/STILL** to avoid recording unwanted material.
 "●||" will appear on screen for about 4 seconds.
 Press again to continue the recording.

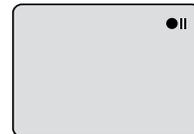

NOTES:

- The pause function will be released after 5 minutes to prevent damage to the tape or the VCR. The VCR will change to the STOP mode.
- You can select a recording channel in the recording pause mode.

Recording one program while watching another

While the VCR is recording, press **TV/VCR** to select the TV position. The "VCR" will go off and recording will continue.
 Select the TV channel you want to watch by using the TV channel selector.

NOTE:

Some Cable TV hookups do not permit viewing one channel while recording another. See pages 14,15.

To Display VCR operation Status

Press **DISPLAY**. The clock, day of the week and more information will be indicated.

While watching TV

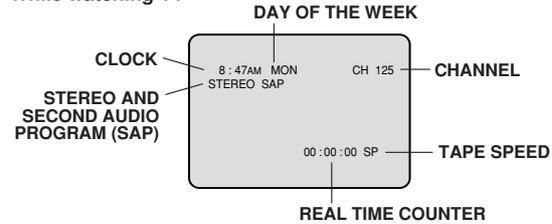

While operating a tape

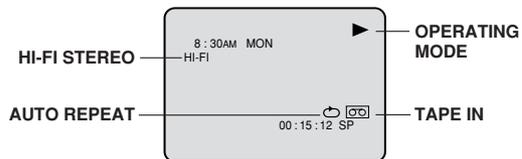

To cancel the display: Press **DISPLAY** until all indicators disappear.

Auto Rewind feature

This VCR will automatically rewind the tape when the tape has ended (except during OTR and TIMER REC). It will also eject the tape.





One-touch Timer Recording (OTR)

The One-touch Timer Recording feature provides a simple and convenient way to make a timed recording.

Preparation:

- Turn ON the TV and set to the video input mode.
- Press **VCR/DVD** to select the VCR mode. (The VCR indicator will light.)

Example: One-touch Timer Recording for 30 minutes.

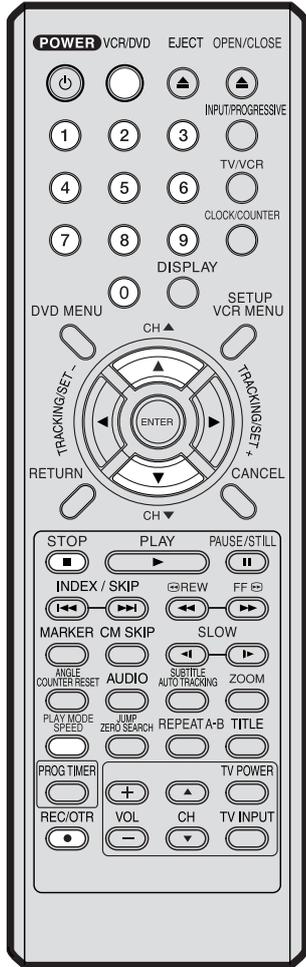

1 Load a cassette tape with the erase prevention tab intact. The VCR will automatically turn on.



2 Press **SPEED** to select the desired tape speed SP or SLP. The tape counter and SP or SLP will appear on the screen for about 4 seconds.



3 Set the TV/CABLE option to the appropriate position (See page 22).

TV - VHF/UHF channels
CABLE - Cable TV channels

4 Press **Number keys** or **CH ▲/▼** to select the channel to be recorded.



5 Press **REC/OTR**. Press the button again to stop recording after 30 minutes. Each additional press of **REC/OTR** will increase recording time as shown in the chart below, up to a maximum of 6 hours. The OTR and recording time will appear on the screen for about 4 seconds. And, REC will keep blinking in the display.

Press	Recording time	Press	Recording time
once	NORMAL REC	6 times	3:00
twice	0:30	7 times	4:00
3 times	1:00	8 times	5:00
4 times	1:30	9 times	6:00
5 times	2:00	10 times	NORMAL REC

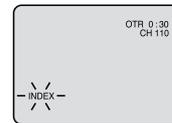

NOTE:

If you wish to watch the DVD playback during the OTR, press **VCR/DVD** to change to DVD mode and perform the DVD playback (see page 36).

To cancel OTR

Press **STOP** or turn off the power. "■" will appear on screen for about 4 seconds.





Timer recording

Timer recording can be programmed on-screen with the remote control. The built-in timer allows automatic unattended recording of up to 8 programs within 1 month.

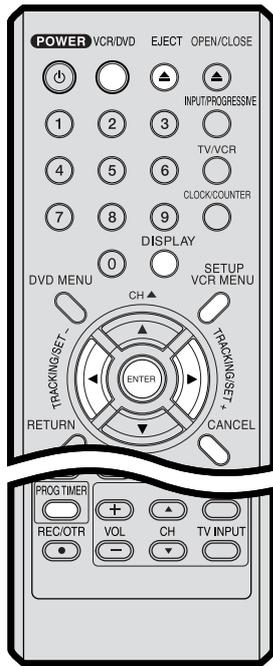

NOTES:

- If the clock symbol(🕒) blinks when the timer recording ended, the TV program has not been completely recorded because of an insufficient tape supply. Press and hold **PROG TIMER** for more than 1 second to cancel the timer program or press **EJECT** to remove the cassette tape.
- During timer recording standby mode, the VCR mode cannot be selected. To use the VCR, press and hold **PROG TIMER** for more than 1 second at first, then press **VCR/DVD** to change to VCR mode. After you use the VCR, press and hold **PROG TIMER** for more than 1 second again to put the VCR into timer recording standby mode.
- If you press and hold **PROG TIMER** for more than 1 second during timer recording, the recording operation will be interrupted. If you press and hold **PROG TIMER** for more than 1 second again within the programmed time, the recording operation will start again.
- After a power failure or disconnection of the power plug, all programmed recording settings and time display will be lost upon resumption of power. In this case, reset the clock (see pages 18-20) and reprogram any timer recordings.

Preparation:

- Press **VCR/DVD** to select the VCR mode.
- Load a cassette tape with the erase prevention tab intact.
- Press the **DISPLAY** button to verify that the time and date are correct (see page 29).

Example: Program a timer recording for the 26th day, channel 125 (Cable TV), 11:00 - 11:30 PM on timer program number 1 (Tape speed: SLP).

1 Press **VCR MENU**. Select the "TIMER REC SET" option, then press **ENTER**.

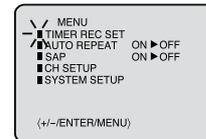

2 Press **SET +** or **-** to select one of the program line, then press **ENTER**.

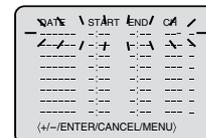

3 Press **SET +** or **-** to select the date, then press **ENTER**.

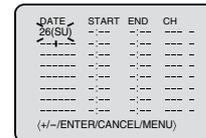

4 Set the **start time**, **end time**, **channel** and **tape speed** as in step 3.

NOTES:

- Press **CANCEL** to move cursor backward for correction.
- To record from external source set the channel to "L1" or "L2". "L1" or "L2" will appear next to CH 125 (or 69).

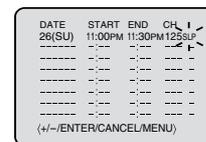

5 To enter other programs, repeat step 2 through 4.

- To return to the normal screen, press **VCR MENU** twice.

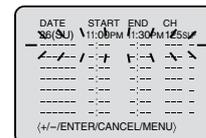

6 Press and hold **PROG TIMER** for more than 1 second. The clock symbol(🕒) will appear on the display and the VCR stands by for recording. At the same time, VCR mode will change to DVD mode automatically ("VCR" display remains on the display even if the VCR change to DVD mode). You can use DVD even if the VCR is in the Timer recording mode. If you do not use the DVD, turn the power off. The timer recording will start at 5 seconds before the time you predetermined.

NOTES:

- If the clock symbol(🕒) does not appear on the display in spite of the pressing of **PROG TIMER**, the cassette may not have been loaded yet. (see page 24)
- If the cassette is ejected in spite of the pressing of **PROG TIMER**, the erase prevention tab of the cassette may have been removed. (see page 24)
- If there are other timer record programs remaining when the timer recording ended, the VCR stands by for recording continuously. (VCR mode will change to DVD mode automatically.)





Timer recording

(continued)

Weekly (e.g. WKL-TU: each Tuesday) or daily (e.g. MO-SA: Monday to Saturday) Timer recording

Follow the procedure of timer recording on the previous page. At picture 3 press **SET +** or **-** repeatedly until the desired setting appears. Then press **ENTER**.

When you press **SET -** repeatedly, the indicator at DATE will change as follows, in this case the day is Friday.

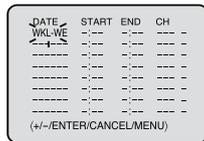
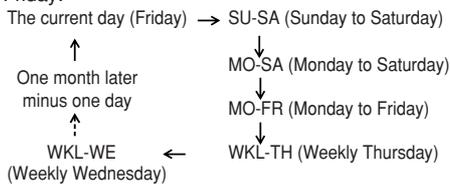

Confirmation/Cancellation of the Timer recording

1 If the Timer has been activated, press and hold **PROG TIMER** for more than 1 second to deactivate the Timer. The clock symbol(⌚) will disappear. Then press **VCR/DVD** to change to VCR mode.

2 To confirm Timer program:

At picture 1 on the previous page select the "TIMER REC SET" option and press **ENTER**.

Then the timer program list as right will appear on the screen.



3 To cancel Timer program:

Press **SET +** or **-** to select the unnecessary program, then press **CANCEL** to cancel the program.

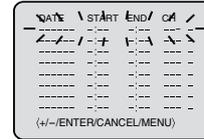

4 Press **VCR MENU** repeatedly until the TV-picture appears.

In case Timer programs-overlap

Do not overlap timer programs as portions of the conflicting programs will be lost. The first recording time has priority over the next recording time as shown in the diagram below.

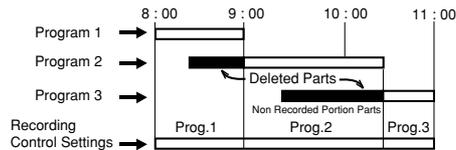

NOTES:

- The daily/weekly recording can be made continuously until the recording is canceled or the tape reaches the end.
- During timer recording the automatic rewinding mechanism does not function.

NOTES:

- If there are other timer record programs remaining, **PROG TIMER** must be pressed to reactivate the timer, otherwise the remaining timer record programs will be ignored.
- You cannot confirm the Timer program during timer recording operation.
- You can also correct the programmed setting in program confirm mode.

At step 2 above, press **ENTER** to enter the program input mode. Then press **ENTER** repeatedly until the

item you wish to correct blinks. Then correct the data with **SET +** or **-**.

Then press **VCR MENU** repeatedly until the TV-picture appears.

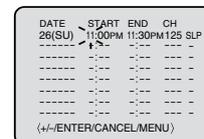



Stereo recording and playback / Second Audio Program (SAP)

Stereo recording and playback

The VHS Hi-Fi audio system permits high fidelity recording of MTS STEREO TV broadcasts.

When a MTS STEREO broadcast is received, the word STEREO will appear on the screen and the program can be viewed or recorded in stereo. The Hi-Fi STEREO recording procedure is the same as for normal recordings.

STEREO

NOTE:

When using a Cable TV system, stereo TV programs may be transmitted over a mono cable channel. In this case the word "STEREO" will not appear and the sound will be in mono.

Output selection

When viewing an MTS STEREO TV program, or playing a prerecorded VHS Hi-Fi STEREO videotape, press **AUDIO** to select how the audio will be heard through the speakers. Normally set to the Hi-Fi STEREO position, this button can be set to the MONO position if the stereo broadcast or videotape audio is of poor quality. The "R" and "L" positions allow the audio from the Right or Left Hi-Fi channel to be heard over both TV speakers. This button has no effect when viewing a MONO videotape or TV program. Each time when you press the button, OUTPUT SELECTION display appears on the screen for several seconds. Refer to the chart below.

OUTPUT SELECTION	SOUND HEARD ON BOTH SPEAKERS
STEREO	STEREO
L ch	LEFT CHANNEL AUDIO
R ch	RIGHT CHANNEL AUDIO
MONO	MONO

Second Audio Program (SAP)

Your VCR is fitted with a SAP broadcast system which enables you to switch to a second audio program when viewing a selected channel.

This function applies only when the program is broadcast in multi-languages through the SAP broadcast system.

- 1 Press **VCR MENU**. Then press **SET +** or **-** to select "SAP".
- 2 Then press **ENTER** to select "ON".

Then press **VCR MENU** until the menu screen is cleared.



Listening to SAP

When the VCR is turned on or a channel selection is made, make certain the letters "SAP" appears on the screen. This means that the "Second Audio Program" broadcasting is available.

STEREO SAP

OR

SAP

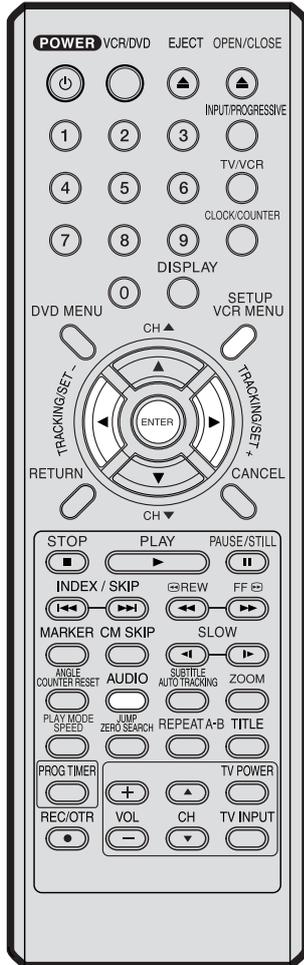

NOTES:

- When playing back a tape that is not recorded in Hi-Fi stereo mode, the audio will automatically be monaural.
- When listening to a VHS Hi-Fi video tape or MTS broadcast through the VHF/UHF jack (Audio/Video cord not connected), the sound will be monaural.



Duplicating a video tape

If you connect the VCR to another VCR or camcorder, you can duplicate a previously recorded tape. Make all connections before turning on the power.

- 1 Load a blank cassette tape with the erase prevention tab intact into the recording VCR. Load a previously recorded tape into the playback VCR or CAMCORDER.
- 2 Press **SPEED** to select the desired tape speed SP or SLP. It is recommended that you set the Speed to the SP mode on the recording VCR for best results.
- 3 Press **INPUT** to select AUDIO/VIDEO input position. "L1" or "L2" will appear in the display.
 - L1 (LINE 1) : on the rear panel
 - L2 (LINE 2) : on the front panel
- 4 Press **REC/OTR** on the recording VCR, then press **PAUSE/STILL**.
- 5 Press the **PLAY** button on the playback VCR or CAMCORDER, then press the **PAUSE/STILL** button.
- 6 Release the recording pause and the playback still simultaneously to begin the duplicating process.

Connection with second Video recorder

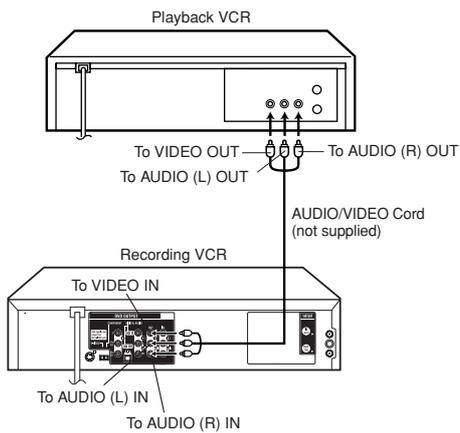

Connection with Video camera

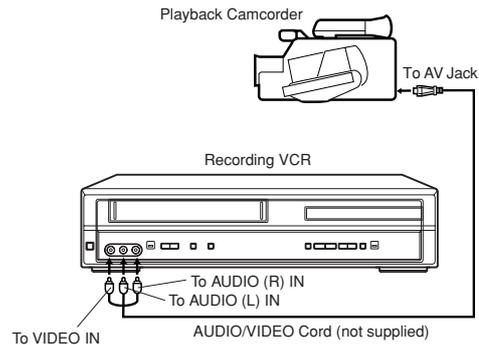

For duplicating a previously recorded tape from a camcorder, follow the camcorder manufacturer's instructions. A typical camcorder dubbing hookup is shown above.





Setting setup language/Progressive scan mode

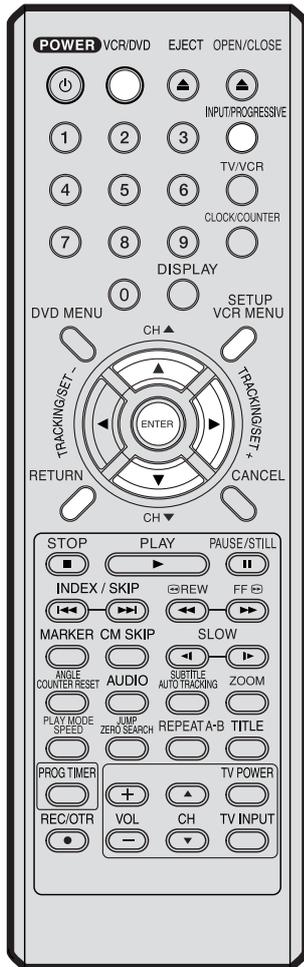

If the DVD/VCR does not operate properly: Static electricity, etc., may affect the player's operation. Disconnect the AC power cord once, then connect it again.

Preparation:

- Turn ON the TV and set to the video input mode.
- Press **VCR/DVD** to select the DVD mode. (The DVD indicator will light.) "No Disc" will appear on the screen. (If a DVD disc has already loaded, the playback will start automatically.)



Setting setup language

The setup language can be selected.

- 1 Press **SETUP** in the stop mode. The SETUP MENU of DVD will appear on the screen. Then press **▶** to select Other.
- 2 Press **▼** or **ENTER** to select OSD Language.
- 3 Press **▶** or **ENTER** and then press **▲** or **▼** to select desired language (e.g. English), then press **ENTER**.

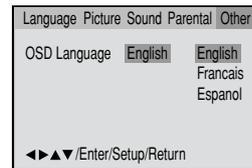
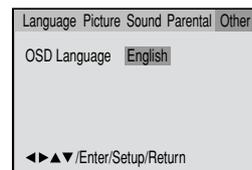

NOTE: To make the SETUP screen disappear, press **SETUP** (or **RETURN**).

Progressive scan mode

The unit supports the Progressive scan mode. If your TV is equipped with component jacks which support the progressive video input, you can enjoy high quality picture by making the Progressive scan mode active.

- 1 Connect the COMPONENT VIDEO OUT jacks to the COMPONENT VIDEO IN jacks of a TV (see page 16).
- 2 Press **PROGRESSIVE** in the stop mode. The PROGRESSIVE indicator "P" on the display window will lit, and progressive scan signal is output from the COMPONENT VIDEO OUT jacks.
- 3 To make the Progressive scan mode inactive, press **PROGRESSIVE** in the stop mode. The PROGRESSIVE indicator "P" on the display window will go off.

NOTES:

- TV must have capability to accept and display a progressive scan signal to use Progressive scan mode. Consult your TV operating instructions.
- You cannot make the Progressive scan mode active in following case.
 - The unit is in the VCR mode.
 - The disc is played back in the DVD mode.
 - The S-VIDEO/COMPONENT video selector switch is set to S-VIDEO position.

35





Playback procedure

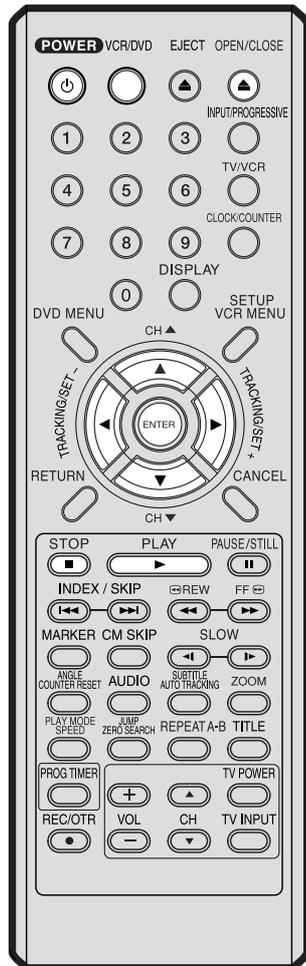

Preparation:

- Turn ON the TV and set to the video input mode.
- Press **VCR/DVD** to select the DVD mode. (The DVD indicator will light.)

- 1 Press **OPEN/CLOSE**.
The disc tray will open.



- 2 Place a disc onto the tray.
Hold the disc, position it with the printed label side up, align it with the guides, and place it in its proper position.

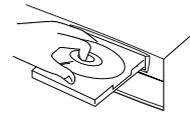

- 3 Press **PLAY** or **OPEN/CLOSE**.
The disc tray closes automatically.
On the screen, ▲ changes to "Reading" and then playback will commence.



- A menu screen may appear on the TV screen, if the disc has a menu feature. In this case, press ▲, ▼, ◀, ▶ or **ENTER** to operate a menu feature.

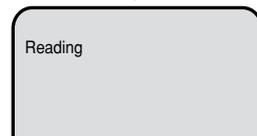

- 4 Press **STOP** to end playback.
 - The DVD/VCR memorizes the stopped point, depending on the disc. "■" appears on the screen for approx. 4 seconds. "▶" keep blinking in the display until the playback is stopped completely. Press **PLAY** to resume playback (from the scene point).
 - If you press **STOP** again ("■" appears on the screen) or unload the disc, the DVD/VCR will clear the stopped point.

- 5 Then press **OPEN/CLOSE**.
The disc tray opens.
Remove the disc and press **POWER**.
The disc tray closes automatically and DVD/VCR turns off.

NOTES:

- If a non-compatible disc is loaded, "Incorrect Disc", "Region Code Error" or "Parental Error" will appear on the TV screen according to the type of loaded disc. In this case, check your disc again (See pages 6 and 47).
- Some discs may take a minute or so to start playback.
- A "Prohibition" symbol 🚫 may appear at the upper left of the screen. This symbol means either the feature you tried is not available on the disc, or the DVD/VCR can not access the feature at this time. This does not indicate a problem with the DVD/VCR.
- When you set a single-faced disc label downwards (ie. the wrong way up) and press **PLAY** or **OPEN/CLOSE**, "Reading" will appear and remain on the screen for approx. 40 seconds and then it will change to "Incorrect Disc".
- Some playback operations of DVDs may be intentionally fixed by software producers. Since this DVD/VCR plays DVDs according to the disc contents the software producers designed, some playback features may not be available. Also refer to the instructions supplied with the DVDs.
- When playing DTS-encoded Audio CDs, excessive noise will be heard from the analog stereo outputs. To avoid possible damage to the audio system, the consumer should take proper precautions when the analog stereo outputs of the DVD/VCR are connected to an amplification system.





Special playback

Note: There may be a slight delay between pressing the button and the function activation.

Preparation:

- Turn ON the TV and set to the video input mode.
- Press **VCR/DVD** to select the DVD mode. (The DVD indicator will light.)

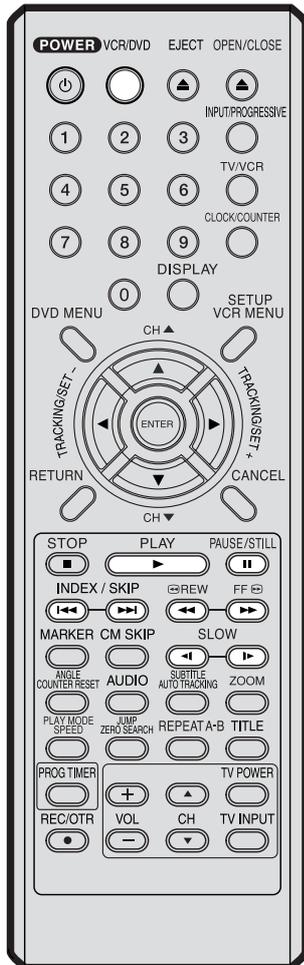

Fast Forward Playback

Press **FF** (▶▶) during normal playback.

Each press of **FF** (▶▶) will increase the speed of the search ▶▶ (x2), ▶▶▶▶ (x4), ▶▶▶▶▶▶ (x8), ▶▶▶▶▶▶▶▶ (x20).

- To resume normal playback, press **PLAY**.

Review Playback

Press **REW** (◀◀) during normal playback.

Each press of **REW** (◀◀) will increase the speed of the search ◀◀ (x2), ◀◀◀◀ (x4), ◀◀◀◀◀◀ (x8), ◀◀◀◀◀◀◀◀ (x20).

- To resume normal playback, press **PLAY**.

Still Playback

Press **PAUSE/STILL** during normal playback.

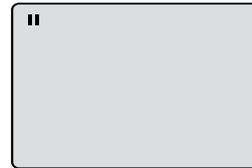

To resume normal playback, press **PLAY**.

Frame Advance

Press **PAUSE/STILL** during still playback.

One frame is advanced each time you press **PAUSE/STILL**.



To resume normal playback, press **PLAY**.

Slow-motion Playback

Press **SLOW** (◀|▶) Forward or **SLOW** (▶|◀) Reverse during normal playback or still playback.

Each press of **SLOW** will change the speed of the slow x1/2, x1/4, x1/6, x1/7.

- To resume normal playback, press **PLAY**.
- To resume the still playback, press **PAUSE/STILL**.

Locating a chapter or track

Press **SKIP** (▶▶|) Forward or **SKIP** (◀◀|) Reverse during playback to locate a chapter that you want to watch.

Each time you press the button, a chapter or track is skipped.

NOTE:

The unit is capable of holding a still video image or on screen display image on your television screen indefinitely. If you leave the still video image or on screen display image displayed on your TV for an extended period of time, you risk permanent damage to your television screen. Projection televisions are very susceptible.





Zooming/Locating desired scene

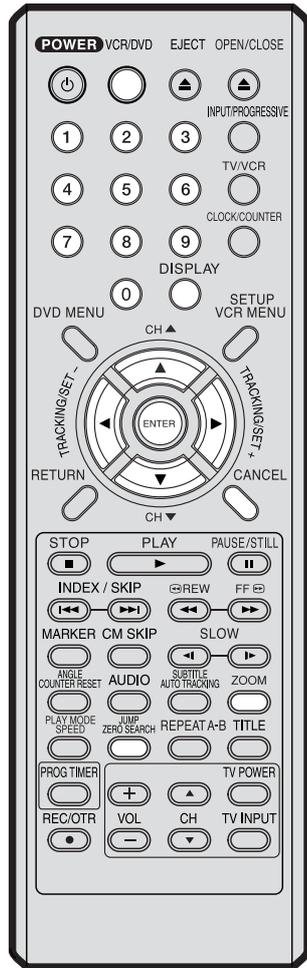

Preparation:

- Turn ON the TV and set to the video input mode.
- Press **VCR/DVD** to select the DVD mode. (The DVD indicator will light.)

Zooming

This unit will allow you to zoom in on the frame image. You can then make selections by switching the position of the frame.

- 1 Press **ZOOM** during playback. The center part of the image will be zoomed in. Each press of **ZOOM** will change the ZOOM **Q** 1 (x 1.3), **Q** 2 (x 1.5) and **Q** 3 (x 2.0).

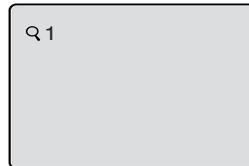

- 2 Press **▲/▼** or **◀/▶** to view a different part of the frame. You may move the frame from the center position to UP, DOWN, LEFT or RIGHT direction.
- 3 In the zoom mode press **ZOOM** repeatedly to return to a 1:1 view (**Q** Off).

Locating desired scene

Use the title, chapter and time recorded on the disc to locate the desired point to play back.

To check the title, chapter and time, press **DISPLAY**. (see page 53)

- 1 Press **JUMP** during playback or stop mode.

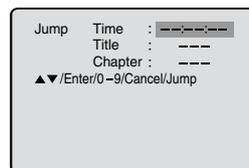

- 2 Press **▲** or **▼** to select the "Time", "Title" or "Chapter".
- 3 Press **Number keys** to change the number.

- If you input a wrong number, press **CANCEL**.
- Refer to the package supplied with the disc to check the numbers.

- 4 Press **ENTER**. Playback starts.

- When you change the title, playback starts from Chapter 1 of the selected title.
- Some discs may not work in the above operation.

NOTE:

You can use the Pause, Slow, Search or Skip feature in the zoom mode.





Marking desired scenes

The unit stores the points that you want to watch again up to 3 points. You can resume playback from each scene.

Preparation:

- Turn ON the TV and set to the video input mode.
- Press **VCR/DVD** to select the DVD mode. (The DVD indicator will light.)

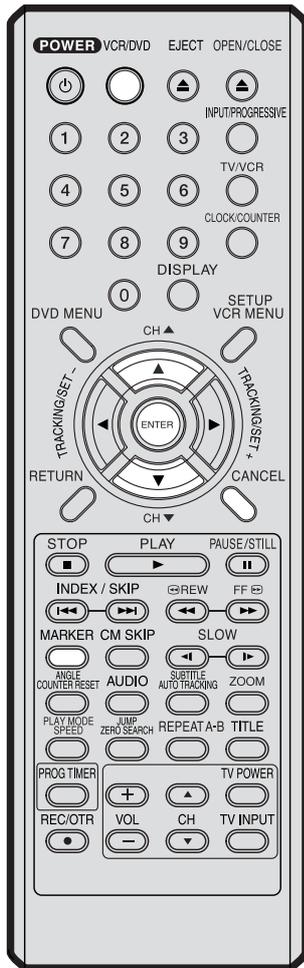

Marking the scenes

- 1 Press **MARKER** during playback.

```
Marker 1 : **: **: **: **
Marker 2 : **: **: **: **
Marker 3 : **: **: **: **
▲▼/Enter/Cancel/Marker
```

- 2 Select the blank Marker using ▲/▼. Then press **ENTER** at the desired scene.

```
Marker 1 : 00 : 27 : 54
Marker 2 : **: **: **: **
Marker 3 : **: **: **: **
▲▼/Enter/Cancel/Marker
```

- Repeat this procedure to set the other 2 scenes.

- 3 Press **MARKER** to remove this display.

Returning to the scenes

- 1 Press **MARKER** during playback or stop mode.

```
Marker 1 : 00 : 27 : 54
Marker 2 : 01 : 16 : 25
Marker 3 : 02 : 08 : 31
▲▼/Enter/Cancel/Marker
```

- 2 Press ▲/▼ to select the Marker 1-3.

```
Marker 1 : 00 : 27 : 54
Marker 2 : 01 : 16 : 25
Marker 3 : 02 : 08 : 31
▲▼/Enter/Cancel/Marker
```

- 3 Press **ENTER**. Playback starts from the marked scene.

To cancel the mark

- 1 Press **MARKER**.
- 2 Press ▲/▼ to select the Marker 1-3.
- 3 Press **CANCEL**. To remove this display, press **MARKER**.

NOTES:

- Some discs may not work with the marking operation.
- The marking is cancelled when you open the disc tray or turn the power off.
- Some subtitles recorded around the marker may fail to appear.





Repeat playback

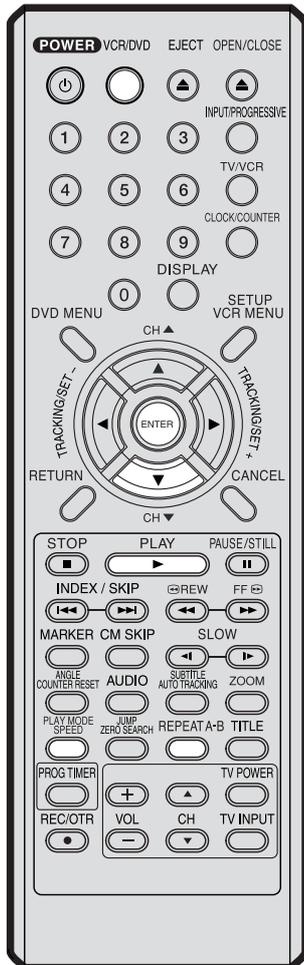

NOTES:

- Some discs may not work with the repeat operation.
- In A-B repeat mode, subtitles near point A or B may not appear.
- During the A-B Repeat Playback the ANGLE feature will not operate.
- You may not be able to set A-B Repeat, depending on the scenes of the DVD.
- A-B repeat does not work with an interactive DVD and MP3/JPEG-CD.

Preparation:

- Turn ON the TV and set to the video input mode.
- Press **VCR/DVD** to select the DVD mode. (The DVD indicator will light.)

Title, Chapter, Track Playback

- 1 Press **PLAY MODE** during playback or stop mode.



- 2 Press **ENTER** once or twice to select "Chapter" or "Title".
In case of CD, at first press **▼** to select "Repeat" and then press **ENTER** once or twice to select "Track" or "All".



- 3 Press **PLAY MODE** again to make the screen disappear.

- Press **PLAY** to start Repeat playback.
- To resume normal playback, select Repeat Off.

A-B Repeat Playback

A-B repeat playback allows you to repeat material between two selected points.

- 1 Press **REPEAT A-B** during playback.
The start point is selected.

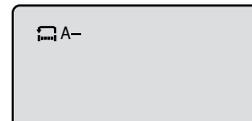

- 2 Press **REPEAT A-B** again.
The end point is selected.
Playback starts at the point that you selected. Playback stops at the end point, returns to Point A automatically, then starts again.

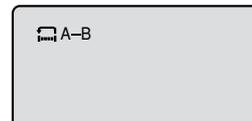

To resume normal playback press **REPEAT A-B** again.
"Off" appears on the screen.





Program playback/Random playback (CD)

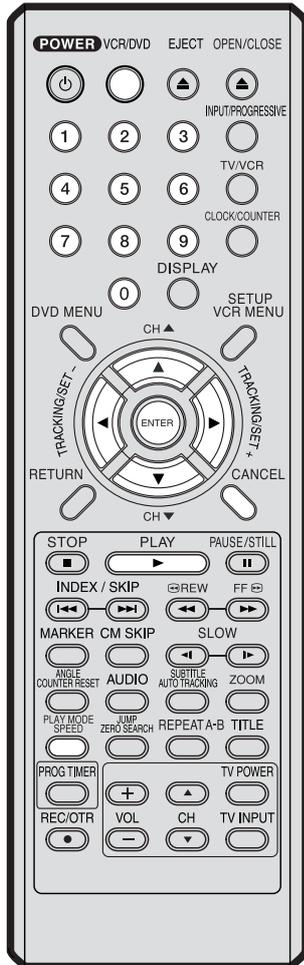

NOTES:

- To cancel program play, select "Clear" at step 4 and press **ENTER**.
- The program is cancelled when you open the disc tray or turn the power off.
- Program playback/Random playback can not be combined with Repeat playback.

Preparation:

- Turn ON the TV and set to the video input mode.
- Press **VCR/DVD** to select the DVD mode. (The DVD indicator will light.)

Program playback

You can arrange the order of tracks on the disc.

- 1 Press **PLAY MODE** in the stop mode.

Play Mode	: Off
Repeat	: Off
◀▶▲▼/Enter/Play Mode	

- 2 Press **ENTER** repeatedly until the program table shown at right appears.

Play Mode	: Program						
Repeat	: Off						
1	---	4	---	7	---	10	---
2	---	5	---	8	---	11	---
3	---	6	---	9	---	12	---
Clear		Program Playback					
◀▶▲▼/Enter/0-9/Cancel/Play Mode							

- 3 **Example:** In case you wish to program in order of 7, 3, 11:
Enter as **7 ▼**, **3 ▼**, **11**.

Play Mode	: Program						
Repeat	: Off						
1	7--	4	---	7	---	10	---
2	3--	5	---	8	---	11	---
3	11-	6	---	9	---	12	---
Clear		Program Playback					
◀▶▲▼/Enter/0-9/Cancel/Play Mode							

If you input a wrong number, press **CANCEL**.

- 4 Press **▲/▼** or **◀/▶** to select "Program Playback" and press **ENTER**. "Program Playback" will appear on the screen. The program you selected will begin to playback in the order set. To return to normal playback, select "Play Mode: Off" at step 2 above.

Program Playback	00:01	03:59
Track 7/15		

Random playback

- 1 Press **PLAY MODE** in the stop mode.

Play Mode	: Off
Repeat	: Off
◀▶▲▼/Enter/Play Mode	

- 2 Press **◀/▶** to select "Random".

Play Mode	: Random
Repeat	: Off
◀▶▲▼/Enter/Play Mode	

- 3 Press **PLAY**. "Random Play" will appear on the screen and Random Playback will start.





Changing soundtrack language / Subtitles / Karaoke playback

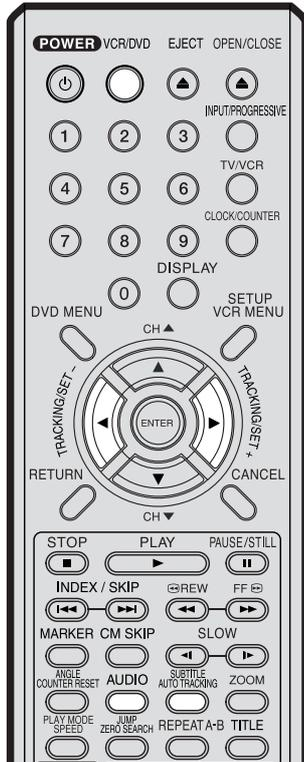

NOTES:

- If the desired language is not heard after pressing the **AUDIO** button several times, the language is not recorded on the disc.
- Changing soundtrack or subtitle language is cancelled when you open the disc tray. The initial default language or available language will be heard and seen if the disc is played back again.
- Depending on the DVD you may be unable to turn on, turn off, or change the subtitles, even if they are recorded on the disc. While playing the DVD, the subtitle may change while opening or closing the disc tray, or while changing the title.
- In some cases, the subtitle language is not changed to the selected one immediately.
- The vocal output feature is used during playback of Dolby Digital (multi-channel) recorded DVD KARAOKE discs. This feature allows you to turn off vocal audio tracks, or restore them for background accompaniment.
- When playing KARAOKE, connect appropriate audio equipment such as an amplifier to the DVD/VCR.

42

Preparation:

- Turn ON the TV and set to the video input mode.
- Press **VCR/DVD** to select the DVD mode. (The DVD indicator will light.)

Changing soundtrack language

You can select the language when you play a multilingual disc.

- 1 Press **AUDIO** during playback. The current soundtrack language will appear.

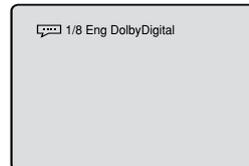

- 2 Press **AUDIO** repeatedly until the desired language is selected. The on-screen display will disappear after a few seconds.



Turning the subtitles On and Off

When playing back a disc recorded with subtitles, you can turn the subtitles on or off.

Press **SUBTITLE** during playback until "Off" appears.

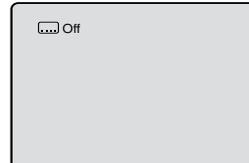

Changing the subtitle language

You can select the language when playing back a disc recorded with multi-lingual subtitles.

Press **SUBTITLE** repeatedly during playback until your desired language appears. The on-screen display will disappear after a few seconds.

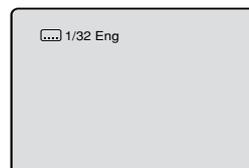

Karaoke playback

When playing back a DVD KARAOKE disc, you can turn the vocal on or off.

- 1 Press **AUDIO** during DVD KARAOKE disc playback.
- 2 Press **◀** or **▶** to select "On" or "Off".

- On:** The primary vocal is output when it is recorded on the disc.
- Off:** The primary vocal is not output.

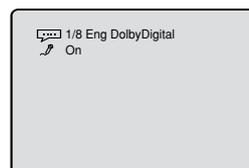



Changing angles / Title selection / DVD menu

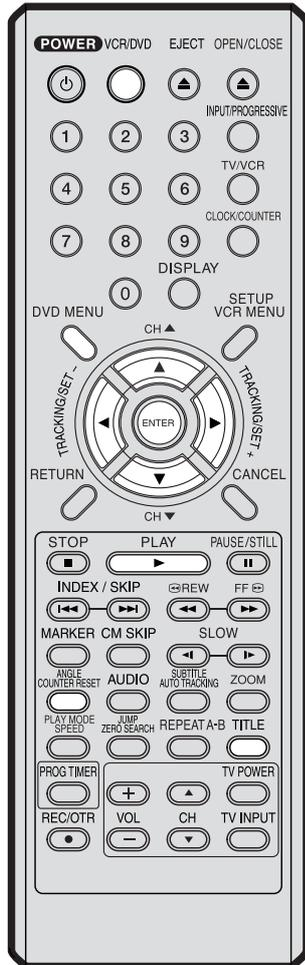

Preparation:

- Turn ON the TV and set to the video input mode.
- Press **VCR/DVD** to select the DVD mode. (The DVD indicator will light.)

Changing Angles

When playing back a disc recorded with multi-angle facility, you can change the angle that you are viewing the scene from.

- 1 Press **ANGLE** during playback. The current angle will appear.

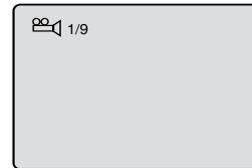

- 2 Press **ANGLE** repeatedly until the desired angle is selected.

Title Selection

Two or more titles are recorded on some discs. If the title menu is recorded on the disc, you can select the desired title.

- 1 Press **TITLE** during playback. Title menu appears on the screen.
 - Press **TITLE** again to resume playback at the scene when you pressed **TITLE**.
- 2 Press **▲/▼** or **◀/▶** to select the desired title.
- 3 Press **ENTER** or **PLAY**. The playback of the selected title will start.

DVD Menu

Some DVDs allow you to select the disc contents using the menu.

When you play back these DVDs, you can select the subtitle language and soundtrack language, etc. using the DVD menu.

- 1 Press **DVD MENU** during playback. The DVD menu appears on the screen.
 - Press **DVD MENU** again to resume playback at the scene when you pressed **DVD MENU**.
- 2 Press **▲/▼** or **◀/▶** to select the desired item.
- 3 Press **ENTER**. The menu continues to another screen. Repeat steps 2 and 3 to set the item completely.

NOTE:

Depending on the DVD, you may not be able to change the angles even if multi-angles are recorded on the disc, or you may be unable to select the title, and a "title menu" may simply be called a "menu" or "title" in the instructions supplied with the disc.





MP3/JPEG playback

This unit can play back MP3/JPEG format CD-R or CD-RW recorded for personal use on a PC, etc. Some discs may not play back due to the condition of the recording.

Preparation:

- Turn ON the TV and set it to the video input mode.
- Press **VCR/DVD** to select the DVD mode. (The DVD indicator will light.)

MP3/JPEG CD information

Limitations on MP3/JPEG CD playback

- MP3/JPEG CD is the disc that is standardized by ISO9660, its file name must include 3-digits extension letters, "mp3" or "jpg".
- This unit can read 600 files per disc. If one directory has more than 600 files, it reads up to 600 files, the remaining files will be omitted.
- The unit is able to recognize up to a maximum of 50 directories per disc.
- If the CD has both audio tracks and MP3/JPEG files, only audio tracks are played.
- It may take more than one minute for this unit to read MP3/JPEG files depending on its structure.
- The music files recorded by "Joliet Recording Specification" can be played back.
- The music files recorded by "Hierarchical File System" (HFS) cannot be played.
- The unit can play back baseline and progressive JPEG files.
- Displayable maximum JPEG image size is 3800 x 2800 pixels.

Limitations on display

- The maximum number for display is 16 letters. Available letters for display are the following: capital or small alphabets of A through Z, numbers of 0 through 9, and _ (under score).
- Other letters than those above are replaced in hyphen.

Notes on MP3/JPEG files

To play back MP3/JPEG CD in the recorded order,

1. Use MP3/JPEG software that records data alphabetically or numerically.
2. Name each file including two-digit or three-digit number (e.g. "01" "02" or "001" "002").
3. Refrain from making too many sub-folders.

About file menu

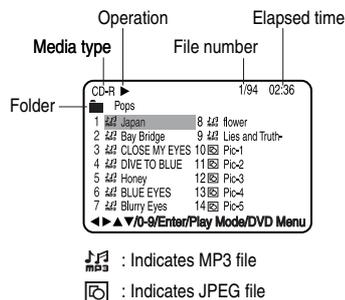

MP3 CD playback

1 Press OPEN/CLOSE.

The disc tray will open. Place a disc on which MP3 files have been recorded onto the tray.

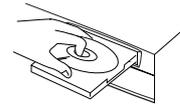

2 Press OPEN/CLOSE or PLAY. The disc tray closes automatically. On the TV-screen, "Reading" will appear. Reading will take as much time as the number of file.

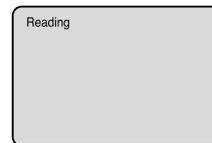

3 A file menu screen will appear on the TV screen. Press ◀/▶ to select folder.

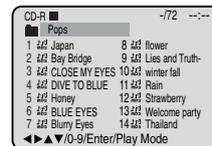

4 Press ▲/▼ or ◀/▶ or Number keys to select the desired MP3 file.

- In case the folder includes more than 15 files, press ◀ or ▶ to display next file list.

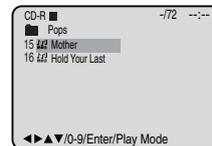
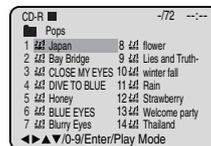

- When **PLAY** has been pressed after displaying the file menu, or when the disc tray has been closed after pressing **PLAY** in step 2, playback begins automatically starting from the first file. In this case, if the first file is an MP3 file, only MP3 files are played back in order. If the first file is a JPEG file, the first JPEG file is played back.

5 Press ENTER.

The selected file starts playing back.

6 Press STOP to end playback.

- The unit records the stopped point. "■" appears on the screen. Press **PLAY** to resume playback (from the scene point).
- If you press **STOP** again or unload the disc, the unit will clear the stopped point.

NOTES:

- During MP3/JPEG-Playback, you can not use SEARCH, A-B Repeat functions.
- You can use Repeat (Track or All), Random functions and Program playback for MP3/JPEG CD Playback (see pages 40 and 41).



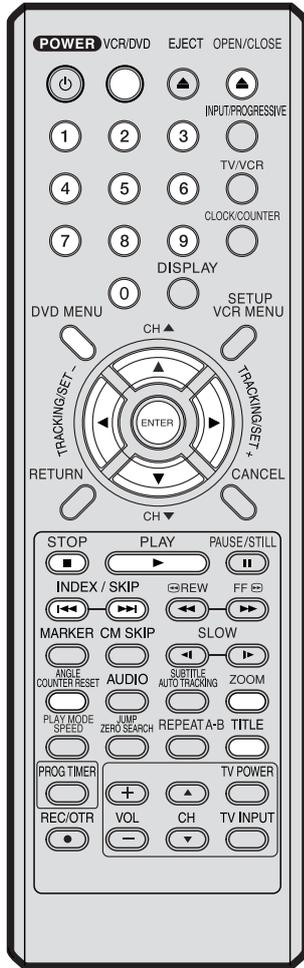

Preparation:

- Turn ON the TV and set it to the video input mode.
- Press **VCR/DVD** to select the DVD mode. (The DVD indicator will light.)

JPEG playback

- 1 Repeat the steps 1~3 on page 44.
- 2 Press **▲/▼** or **◀/▶** or **Number keys** to select the desired JPEG file.

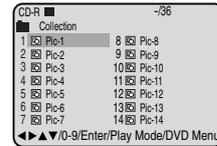

To display a picture menu, press **DVD MENU**. (To return to a file menu, press **TITLE**.)

Press **▲/▼** or **◀/▶** to select the desired JPEG file.

• To display next list, press **SKIP ▶▶** / **◀◀**.

• When **PLAY** has been pressed after displaying the file menu, or when the disc tray has been closed after pressing **PLAY** in step 2, playback begins automatically starting from the first file. In this case, if the first file is a JPEG file, the first JPEG file is played back. If the first file is an MP3 file, only MP3 files are played back in order.



- 3 Press **ENTER**. The selected picture appears on the TV screen.
- 4 Press **STOP** to end playback. The file menu appears on the TV screen. If you want to watch the other file, repeat steps 2-3.



JPEG Zooming

This unit will allow you to zoom in on the JPEG image.

Press **ZOOM** during JPEG playback.

Each press of **ZOOM** will change the ZOOM "Q1", "Q2", "Q3" and "Q Off".

JPEG Rotation

You can display JPEG images rotating at 90 degree intervals.

Press **ANGLE** repeatedly during JPEG playback. Images are rotated 90 degrees clockwise.

- Images are displayed at the same angle until the disc is removed.

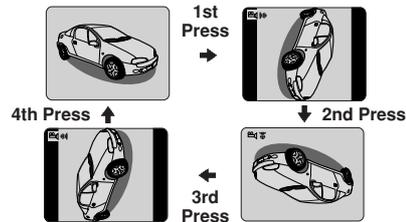

NOTE:

The picture menu is displayed when the FUJICOLOR CD or the Kodak Picture CD are played. To display the file menu press **TITLE**.





MP3/JPEG playback (continued)

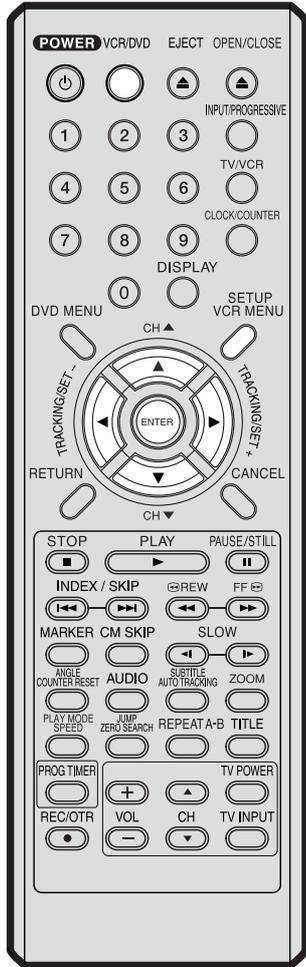

Preparation:

- Turn ON the TV and set it to the video input mode.
- Press **VCR/DVD** to select the DVD mode. (The DVD indicator will light.)

Setting the JPEG Slide-show

You can continuously play back all JPEG files automatically as a slide-show.

1 Press **SETUP** in the stop mode. Press **◀** or **▶** to select "Picture", then press **▼** or **ENTER**.

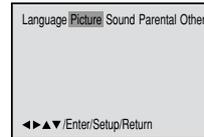

2 Press **▲** or **▼** to select "JPEG Interval".



3 Press **ENTER**. Press **◀** or **▶** to select your desired time.

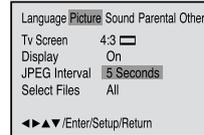

Off:
Plays back one file at a time.

5 Seconds:
Plays back images in the form of a slide-show at 5 second intervals.

10 Seconds:
Plays back images in the form of a slide-show at 10 second intervals.

15 Seconds:
Plays back images in the form of a slide-show in 15 second intervals.

4 To make SETUP screen disappear, press **SETUP**.

Setting the display of file menu

When playing back a CD containing a mixture of MP3 and JPEG files, only MP3 or JPEG files can be displayed on the file menu.

1 Repeat the above step 1.

2 Press **▲** or **▼** to select "Select Files".

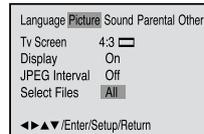

3 Press **ENTER**. Press **◀** or **▶** to select your desired file type.

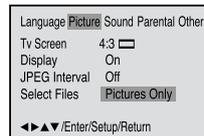

All:
Displays all files.

Music Only:
Displays only MP3 files.

Pictures Only:
Displays only JPEG files.

4 To make SETUP screen disappear, press **SETUP**.





Parental control

Some discs are specified not suitable for children. Such discs can be prevented from play back with the unit.

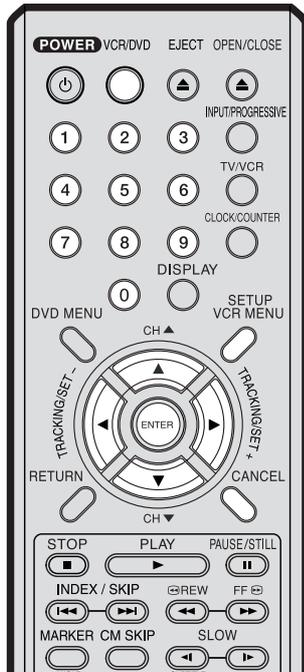

Preparation:

- Turn ON the TV and set to the video input mode.
- Press **VCR/DVD** to select the DVD mode. (The DVD indicator will light.)

Parental control setting

- 1 Press **SETUP** in the stop mode. Press **◀** or **▶** to select "Parental". Then press **▼** or **ENTER**.
- 2 Press **▼** once to select "Parental Off", then press **ENTER** until the level you desire appears (e.g.: 1).
- 3 Press **▲** once to select "Password ". Then press **Number keys** to input a 4-digit password (e.g.: 1234).

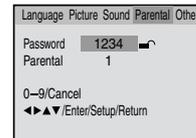
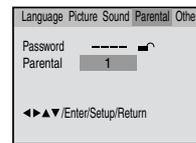
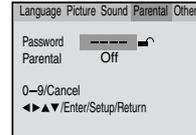

- If you input a wrong number, press **CANCEL**.
- Be sure to remember this number!

Level Off: The parental control setting does not function. (Factory preset)

Level 1: DVDs expressly for children can be played back. (DVDs for adults/general audiences are prohibited.)

Level 2 to 7: DVDs for general audiences/children can be played back. (DVDs for adults are prohibited.)

Level 8: NO LIMIT: All DVDs can be played back.

Select from the level 1 to level 8. The limitation will be more severe as the level number is lower.

- 4 Press **ENTER**. 1234 change to .

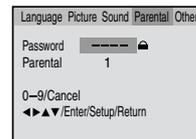

- 5 To make SETUP screen disappear, press **SETUP**.

To unlock the Parental control setting

Cancel the password so as to set the Parental level freely again.

- 1 Select "Password (step 2) and press **Number keys** to input your 4-digit password. Then press **ENTER**.
- 2 If the input password was right, will appear. You can move to "Parental 1" (e.g.) to input the desired level or to cancel parental control.

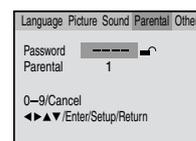
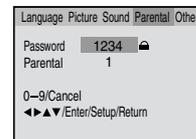

NOTES:

- If each setup (pages 46~54) has been completed, the unit can always be worked under the same conditions (especially with DVD discs). Each setup will be retained in the memory if you turn the power off.
- Depending on the discs, the unit cannot limit playback.
- Some discs may not be encoded with specific rating level information though its disc jacket says "adult". For those discs, the age restriction will not work.
- Do not forget the password. If you forget the password, in the No Disc DVD mode, press and hold **STOP** on the unit, and simultaneously press and hold **7** on the remote control for more than 3 seconds. "PASSWORD CLEAR" appears on the screen. The password has been cleared. The above procedure will clear the password only.





Temporary disabling of rating level by DVD disc

Depending on the DVD disc, the disc may try to temporarily cancel the rating level that you have set. It is up to you to decide whether to cancel the rating level or not.

Preparation:

- Turn ON the TV and set to the video input mode.
- Press **VCR/DVD** to select the DVD mode. (The DVD indicator will light.)

- 1 Load a DVD disc and press **PLAY** or **OPEN/CLOSE** (see page 36).

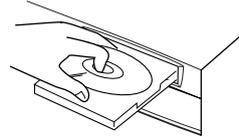

- 2 If the DVD disc has been designed to temporarily cancel the Rating level, the screen which follows the "Reading" screen will change, depending on which disc is played. If you select "YES" with **ENTER** key, "Your disc exceeds the parental control level 1." (e.g.) screen will then appear.

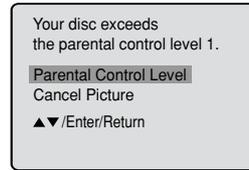

- 3 If you wish to cancel the set rating level temporarily, select "Parental Control Level" with **▲** or **▼**, then press **ENTER**. If the 4-digits password at step 3 on page 47 has been set, the password entering screen will appear as shown in step 4 below. Alternatively, if the password has not been set, playback will commence. If you don't know (or have forgotten) the password, select "Cancel Picture". The setting screen will disappear. Press **OPEN/CLOSE** to remove the disc.

- 4 Enter the password with **Number buttons (0-9)**. Then press **ENTER**.

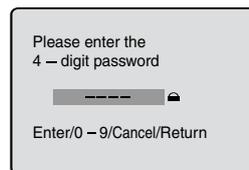

If you interrupt the entering, press **RETURN**.

- 5 Playback will commence if the entered password was correct.

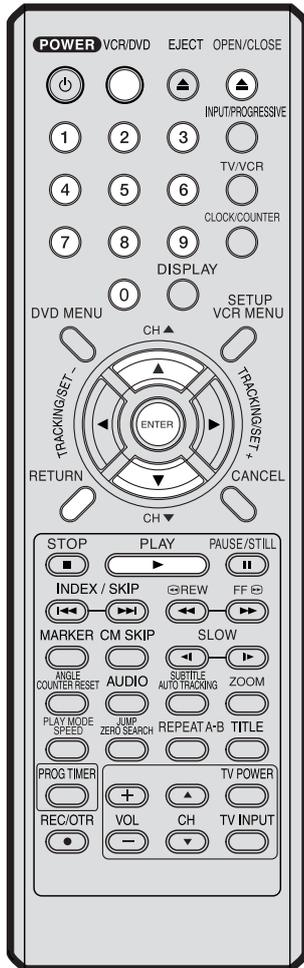

NOTE:

This temporary cancellation of rating level will be kept until the disc is ejected. When the disc is ejected, the original rating level will be set again automatically.





Setting menu language

You can select the language of the disc menu messages of DVDs.

Preparation:

- Turn ON the TV and set to the video input mode.
- Press **VCR/DVD** to select the DVD mode. (The DVD indicator will light.)

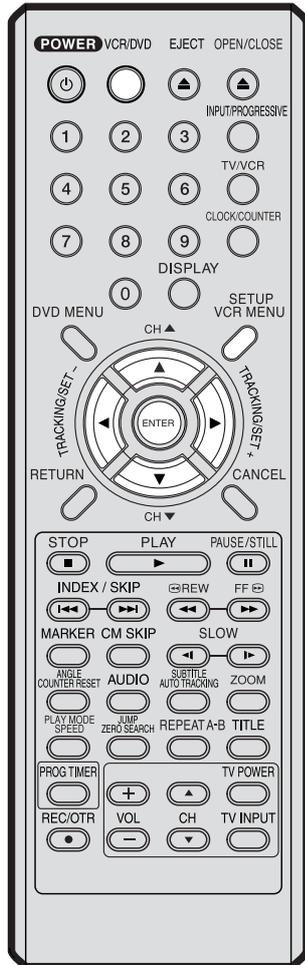

- 1 Press **SETUP** in the stop mode. Press **◀** or **▶** to select "Language".

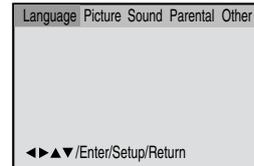

- 2 Press **▼** or **ENTER**. Then press **▲** or **▼** to select "Menu".

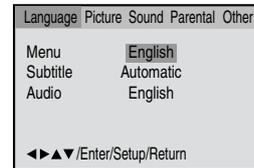

- 3 Press **▶** or **ENTER**. Press **▲** or **▼** to select your desired language, then press **ENTER**.

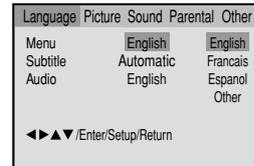

English, Francais, Espanol:

The selected language is the first priority Menu language.

Other:

Other languages can be selected (see the Language code list on page 55).

- 4 To make SETUP screen disappear, press **SETUP**.



Setting subtitle language

The same subtitle language can always be selected even if you replace the disc or turn the power off.

Preparation:

- Turn ON the TV and set to the video input mode.
- Press **VCR/DVD** to select the DVD mode. (The DVD indicator will light.)

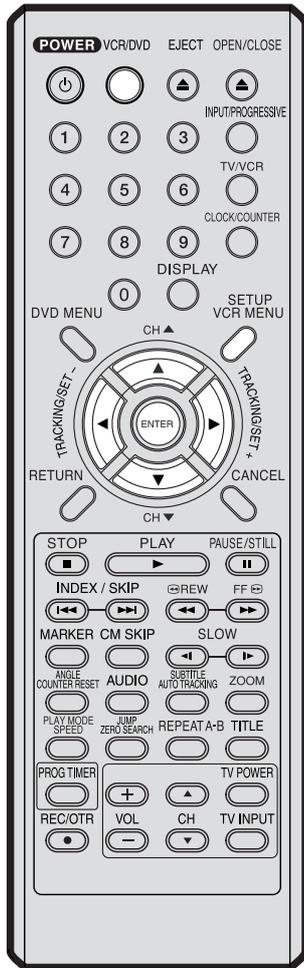

- 1 Press **SETUP** in the stop mode. Press **◀** or **▶** to select "Language"

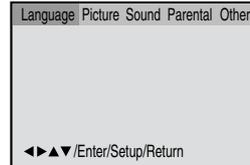

- 2 Press **▼** or **ENTER**. Then press **▲** or **▼** to select "Subtitle".

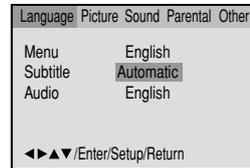

- 3 Press **▶** or **ENTER**. Press **▲** or **▼** to select your desired language, then press **ENTER**.

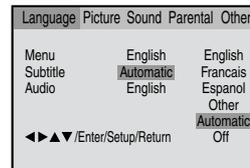

English, Francais, Espanol:

The subtitle is displayed with the selected language if it is recorded on the disc.

Other:

If you want to select another language, enter the language code (see the Language code list on page 55).

Automatic:

- The unit will automatically select the same language in the AUDIO setting.
- When the unit selects the same language as the AUDIO, the subtitles will not appear during playback.
- When you do not use the same language as the AUDIO, the subtitles will appear during playback.

Off:

Subtitles do not appear.

- 4 To make SETUP screen disappear, press **SETUP**.

NOTE:

If the selected language is not recorded on the disc, the first-priority language is selected.





Setting audio soundtrack language

The same audio soundtrack language can always be selected by your unit even if you replace the disc or turn the power off.

Preparation:

- Turn ON the TV and set to the video input mode.
- Press **VCR/DVD** to select the DVD mode. (The DVD indicator will light.)

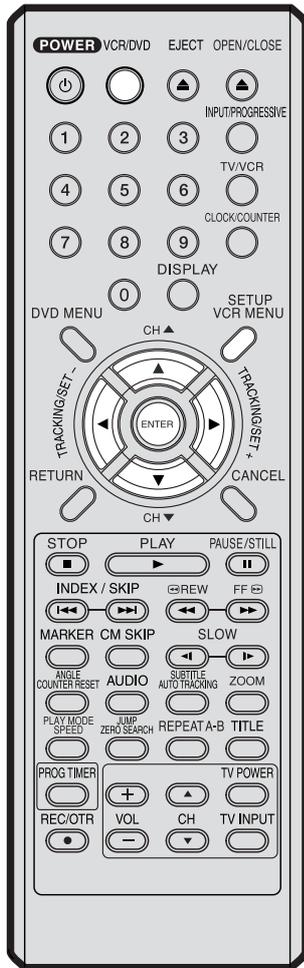

- 1 Press **SETUP** in the stop mode.
Press ◀ or ▶ to select "Language"

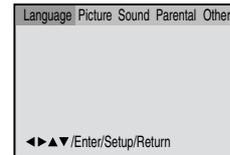

- 2 Press ▼ or **ENTER**.
Then press ▲ or ▼ to select "Audio".

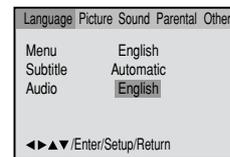

- 3 Press ▶ or **ENTER**.
Press ▲ or ▼ to select your desired Audio Language, then press **ENTER**.

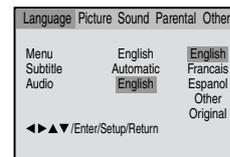

English, Francais, Espanol:

The language you have selected will play if it is recorded on the disc.

Other:

If you want to select another language, enter the language code (see the Language code list on page 55).

Original:

The unit will select the first priority language of each disc.

- 4 To make SETUP screen disappear, press **SETUP**.

NOTE:

If the selected language is not recorded on the disc, the original language will be heard.





Setting the aspect ratio of TV screen

You can select the aspect ratio for your TV.

Preparation:

- Turn ON the TV and set to the video input mode.
- Press **VCR/DVD** to select the DVD mode. (The DVD indicator will light.)

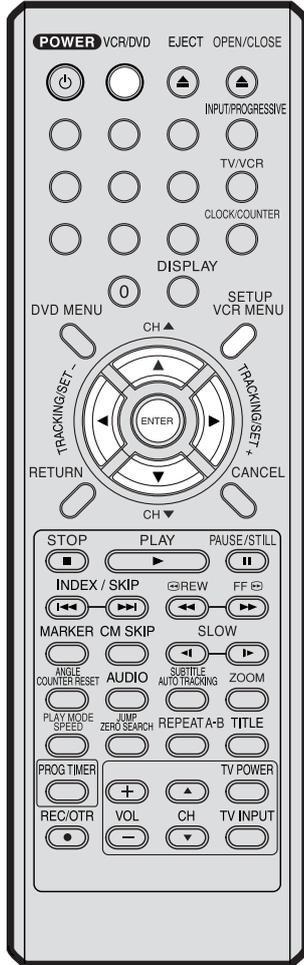

- 1 Press **SETUP** in the stop mode. Press **◀** or **▶** to select "Picture".

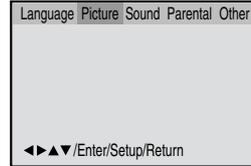

- 2 Press **▼** or **ENTER**, then press **▲** or **▼** to select "Tv Screen".

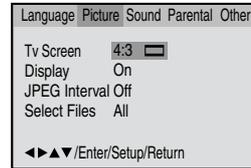

- 3 Press **▶** or **ENTER**. Press **▲** or **▼** to select your desired screen type, then press **ENTER**.

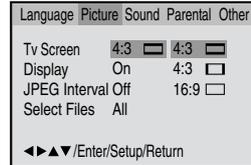

You have the following screen sizes to choose from:

4:3 Letter box:

Select this mode when connecting to a conventional TV. When playing back a wide screen-DVD disc, it displays the wide picture with black bands at the top and bottom of screen.

4:3 Pan Scan:

It displays the wide picture on the whole screen with left and right edges automatically cut off.

16:9 Wide:

Select this mode when connecting to a wide-screen TV. A wide screen picture is displayed full size.

- 4 To make SETUP screen disappear, press **SETUP**.

NOTE:

If the DVD disc is not formatted in the pan & scan style, it displays 4:3 style.





Setting on screen display/Status display of disc

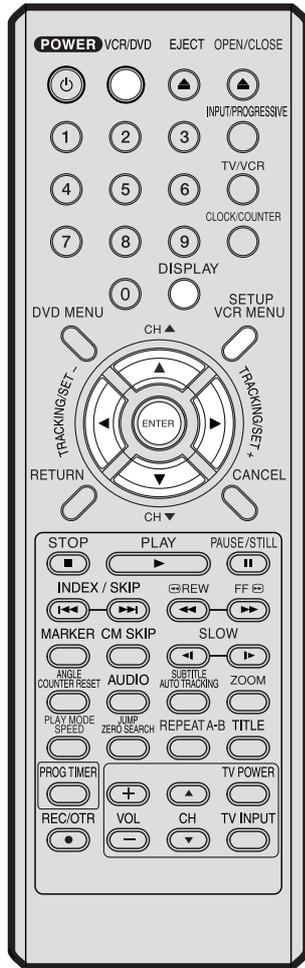

Preparation:

- Turn ON the TV and set to the video input mode.
- Press **VCR/DVD** to select the DVD mode. (The DVD indicator will light.)

Setting on screen display

On screen display can be switched on or off when you press the **DISPLAY** button.

- 1 Press **SETUP** in the stop mode.
Press **◀** or **▶** to select "Picture".

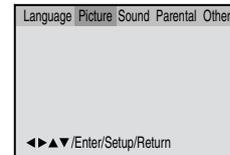

- 2 Press **▼** or **ENTER**, then press **▲** or **▼** to select "Display".

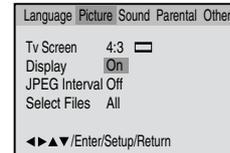

- 3 Press **▶** or **ENTER** to select "On" or "Off".

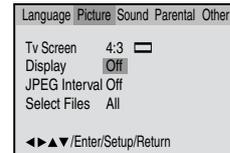

On: On screen displays appears when you press any buttons (factory setting).

Off: On screen displays do not appear when you press any buttons except **SETUP**, **SEARCH MODE**, **PLAY MODE**, **MARKER** and **DISPLAY**.

- 4 To make SETUP screen disappear, press **SETUP**.

Status display of disc

Each press of **DISPLAY**, the status display of the disc will appear on the screen and change as follows.



To make status display disappear, press **DISPLAY** again.



When you playback the CD disc, the status display will appear on the screen and continue displaying.





Dynamic Range Control

DRC (Dynamic Range Control) enables you to control the dynamic range so as to achieve a suitable sound for your equipment.

Preparation:

- Turn ON the TV and set to the video input mode.
- Press **VCR/DVD** to select the DVD mode. (The DVD indicator will light.)

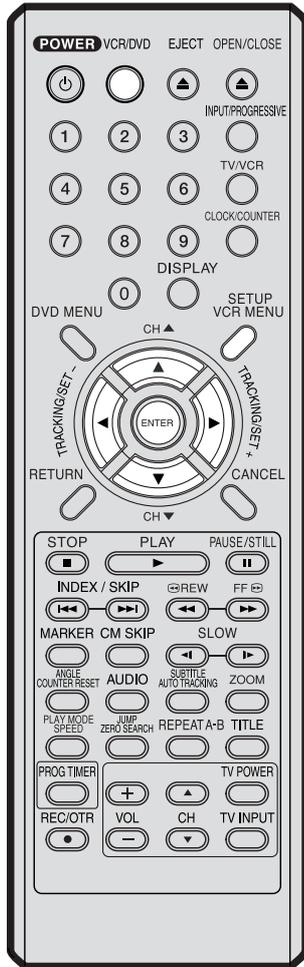

- 1 Press **SETUP** in the stop mode. Press **◀** or **▶** to select "Sound".

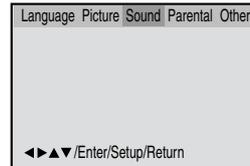

- 2 Press **▼** or **ENTER** to select "DRC".

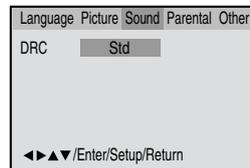

- 3 Press **▶** or **ENTER**, then press **▲** or **▼** to select desired setting.

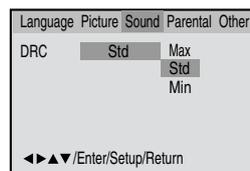

- Max:** Full dynamic range is increased.
- Std:** Full dynamic range is maintained.
- Min:** Dynamic range is reduced.

- 4 To make SETUP screen disappear, press **SETUP**.

NOTES:

- This function works only during playback of Dolby Digital recorded discs.
- The level of Dynamic Range Reduction may differ depending on DVD video disc.





Language code list

Enter the appropriate code number for the initial settings "Audio", "Subtitle" and/or "Menu" (see pages 49-51).

Language Name Code	Language Name Code	Language Name Code	Language Name Code
Abkhazian 1112	Fiji 1620	Lingala 2224	Singhalese 2919
Afar 1111	Finnish 1619	Lithuanian 2230	Slovak 2921
Afrikaans 1116	French 1628	Macedonian 2321	Slovenian 2922
Albanian 2927	Frisian 1635	Malagasy 2317	Somali 2925
Amharic 1123	Galician 1722	Malay 2329	Spanish 1529
Arabic 1128	Georgian 2111	Malayalam 2322	Sundanese 2931
Armenian 1835	German 1415	Maltese 2330	Swahili 2933
Assamese 1129	Greek 1522	Maori 2319	Swedish 2932
Aymara 1135	Greenlandic 2122	Marathi 2328	Tagalog 3022
Azerbaijani 1136	Guarani 1724	Moldavian 2325	Tajik 3017
Bashkir 1211	Gujarati 1731	Mongolian 2324	Tamil 3011
Basque 1531	Hausa 1811	Nauru 2411	Tatar 3030
Bengali; Bangla 1224	Hebrew 1933	Nepali 2415	Telugu 3015
Bhutani 1436	Hindi 1819	Norwegian 2425	Thai 3018
Bihari 1218	Hungarian 1831	Oriya 2528	Tibetan 1225
Breton 1228	Icelandic 1929	Panjabi 2611	Tigrinya 3019
Bulgarian 1217	Indonesian 1924	Pashto, Pushto 2629	Tonga 3025
Burmese 2335	Interlingua 1911	Persian 1611	Turkish 3028
Byelorussian 1215	Irish 1711	Polish 2622	Turkmen 3021
Cambodian 2123	Italian 1930	Portuguese 2630	Twi 3033
Catalan 1311	Japanese 2011	Quechua 2731	Ukrainian 3121
Chinese 3618	Javanese 2033	Rhaeto-Romance 2823	Urdu 3128
Corsican 1325	Kannada 2124	Romanian 2825	Uzbek 3136
Croatian 1828	Kashmiri 2129	Russian 2831	Vietnamese 3219
Czech 1329	Kazakh 2121	Samoan 2923	Volapük 3225
Danish 1411	Kirghiz 2135	Sanskrit 2911	Welsh 1335
Dutch 2422	Korean 2125	Scots Gaelic 1714	Wolof 3325
English 1524	Kurdish 2131	Serbian 2928	Xhosa 3418
Esperanto 1525	Laothian 2225	Serbo-Croatian 2918	Yiddish 2019
Estonian 1530	Latin 2211	Shona 2924	Yoruba 3525
Faroese 1625	Latvian, Lettish 2232	Sindhi 2914	Zulu 3631





Problems and troubleshooting

Use the following check list for troubleshooting when you have problems with your unit. Consult your local dealer or service outlet if problems persist.

Be sure all connections are properly made when using with other units.

SYMPTOMS	POSSIBLE SOLUTIONS	PAGE
DVD/VCR		
DVD/VCR does not operate.	<ul style="list-style-type: none"> • Make sure the power cord is plugged in. • Try another AC outlet. • Power is off, check fuse or circuit breaker. • Unplug unit, then plug it back in. • Select the DVD or VCR mode before operating. 	11 – – 11 21,35
No picture.	<ul style="list-style-type: none"> • Antenna connection is not correct or antenna cable is disconnected. • The video channel is not in the correct position or the TV is not set to the video channel 3 or 4. • Check the unit is connected correctly. • The video input selector of the TV is not set to VIDEO. Set to VIDEO (or equivalent). • Channel is set to the external mode. 	12~15 21 12~17 – –
No sound.	<ul style="list-style-type: none"> • Check the unit is connected correctly. • Check the input selector of the amplifier is set properly. • The unit is in the Special playback mode. 	12~17 – 26,37
The remote control does not function.	<ul style="list-style-type: none"> • Aim at the remote control at the remote sensor. • Operate within Approx. 5 Meters or reduce the light in the room. • Clear the path of the beam. • The batteries are weak. Replace the batteries. • Check the batteries are inserted correctly. 	11
No Cable TV reception.	<ul style="list-style-type: none"> • Check all Cable TV connections. • Station or Cable TV system problems, try another station. 	14,15
VCR		
TV recording does not work.	<ul style="list-style-type: none"> • The erase prevention tab of the video cassette is broken off. • The unit is in the external input mode. 	24,28
Timer recording does not work.	<ul style="list-style-type: none"> • The time is not set correctly. • The recording start/end time is not set correctly. • PROG TIMER has not been pressed (⏸ is not lit). 	18~20 31 31
Noise bars on screen.	<ul style="list-style-type: none"> • Tracking adjustment beyond range of automatic tracking circuit. Try Manual tracking adjustment. • Video heads are dirty. • The tape is worn or damaged. 	26 57 –
DVD		
Display is not shown in your language.	<ul style="list-style-type: none"> • Select proper language in the menu options. 	35
Playback doesn't start.	<ul style="list-style-type: none"> • No disc is inserted. • The disc may be dirty. Clean up the disc. • The unit cannot play DVD-ROMs, etc. 	36 6 6
Stopping playback, search, slow-motion play, repeat play, or program play, etc. cannot be performed.	<ul style="list-style-type: none"> • Some discs may not do some of the functions. 	–





SYMPTOMS	POSSIBLE SOLUTIONS	PAGE
No picture, or the screen is blurred or divided into two parts.	<ul style="list-style-type: none"> The S-VIDEO/COMPONENT selector is not set correctly. The progressive scanning mode is active through the unit is connected to a TV via the VIDEO OUT jack. 	16 35
No 4:3 (16:9) picture.	<ul style="list-style-type: none"> The setup does not match your TV. 	52
No on-screen display.	<ul style="list-style-type: none"> Select Display On. 	53
No surround sound.	<ul style="list-style-type: none"> The setup does not match your stereo system. 	17
The unit or remote operation key is not functioning.	<ul style="list-style-type: none"> Turn off the unit and unplug the AC power cord for several minutes, then replug it. 	–
Playback does not start when the title is selected.	<ul style="list-style-type: none"> Check the Parental setup. 	47
Audio soundtrack and/or subtitle language is not changed when you play back a DVD.	<ul style="list-style-type: none"> Multilingual language is not recorded on the DVD disc. 	50,51
No subtitle.	<ul style="list-style-type: none"> Some discs have no subtitles. Subtitles are cleared. Press SUBTITLE. 	42
Angle cannot be changed.	<ul style="list-style-type: none"> Multi-angles are not recorded on the DVD disc. 	43
 appears on the screen.	<ul style="list-style-type: none"> The function is prohibited with the unit or the disc. 	–

If you cannot resolve the problem, please call the Customer Satisfaction Center for product assistance at 1-800-211-PANA(7262).
 To locate an authorized servicenter call toll free 1-800-211-PANA(7262) or send e-mail to :
 consumerproducts@panasonic.com.

Built-in head cleaner

A clean video head helps produce a clear picture. So, we have equipped your DVD/VCR with a built-in, non-chemical head cleaning system that helps prevent clogging of the video heads. Cleaning is performed each time you load or unload a video cassette.

- This feature is preventative only. If your video heads are seriously clogged, consider the use of a chemical non-abrasive head cleaning kit or take your DVD/VCR to a Servicenter.

Video head cleaning

The video heads are the means by which the DVD/VCR reads the picture from the tape during playback. In the unlikely event that the heads become dirty enough to be clogged, no picture will be played back. This can easily be determined if, during playback of a known good tape, there is good sound, but no picture (picture is extremely snowy). If this is the case, have the DVD/VCR checked by qualified service personnel.



Good Picture

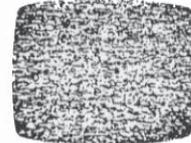

Snowy Picture

- NOTES:**
- DO NOT ATTEMPT TO CLEAN THE VIDEO HEADS OR SERVICE THE UNIT BY REMOVING THE REAR COVER.
 - Video heads may eventually wear out and should be replaced when they fail to produce clear pictures.
 - To help prevent video head clogging, use only good quality VHS tapes. Discard worn out tapes.





Specifications

GENERAL

Power supply:	AC 120V 60Hz
Power consumption:	Operation: 18W Stand by: 2W
Weight:	3.6 kg (7.9 lbs)
Dimensions:	Width : 430 mm (16-15/16 inches) Height : 99 mm (3-7/8 inches) Depth : 250 mm (9-13/16 inches)
Inputs/Outputs:	
Video:	In: 1Vp-p/75 ohm Out: 1Vp-p/75 ohm
Audio:	In: -8dBm/50k ohm Out: -8dBm/1k ohm
Antenna:	UHF/VHF IN/OUT: 75 ohm coaxial
Hi-Fi frequency response:	20Hz to 20,000Hz
Hi-Fi dynamic range:	More than 90dB

VCR section

Video head:	4 Rotary Heads
Audio track:	Hi-Fi Sound - 2 Tracks / MONO Sound - 1 Track
Tuner:	181 Channel Freq. Synthesized VHF 2-13 UHF 14-69 Cable TV 14-36 (A)-(W) 37-59 (AA)-(WW) 60-85 (AAA)-(ZZZ) 86-94 (86)-(94) 95-99 (A-5)-(A-1) 100-125 (100)-(125) 01 (5A)
RF channel output:	Channel 3 or 4, Switchable
F.FWD/REW Time:	Approx. 1minute and 48 seconds (with T-120 Cassette Tape)(at+25°C)

DVD section

Signal system:	NTSC
Applicable disc:	DVD (12cm, 8cm), CD (12cm, 8cm)
Audio characteristics frequency response:	DVD: 4Hz - 22kHz CD: 4Hz - 20kHz
S/N Ratio:	90dB
Harmonic distortion:	0.02%
Wow and flutter:	Less than 0.01% Wrms
Dynamic range:	More than 90dB
Output:	Video : (RCA) 1 Vp-p/75 ohm Audio : (RCA) -12 dBm/1k ohm Digital Audio : 0.5Vp-p/75 ohm
Pickup:	CD : Wavelength: 775 - 805 nm Maximum output power: 0.5 mW DVD : Wavelength: 640 - 660 nm Maximum output power: 1.0 mW





Spanish Quick Use Guide (Guía para rápida consulta)

Conexiones basicos

El DVD/VCR debe conectarse "entre" la antena y el televisor. Primero, desconecte la antena del televisor y conéctela al DVD/VCR. Luego, conecte el DVD/VCR al televisor. Una vez que haya conectado la antena al DVD/VCR, usted tendrá que conectar el DVD/VCR al televisor.

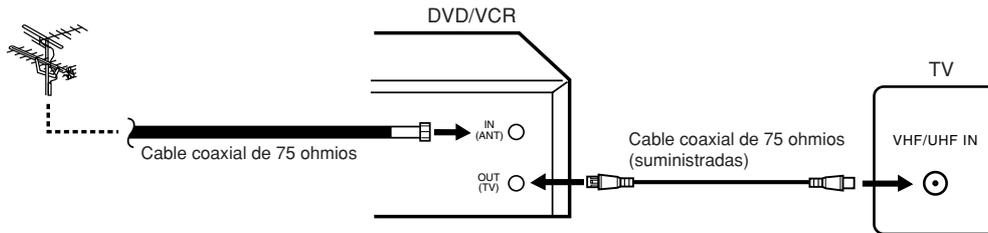

Conexiones de TV Cable

Muchas compañías de TV cable ofrecen servicios que permiten recibir canales adicionales, incluyendo canales pagados o por suscripción. Al tener una gama de sintonización ampliada, este DVD/VCR puede sintonizar la mayoría de los canales de TV cable sin necesidad de usar un caja convertidora proporcionada por la compañía de TV cable, salvo aquellos canales que han sido intencionalmente codificados.

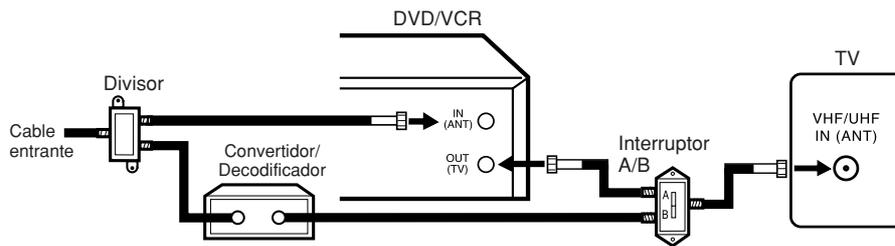

Ajuste del reloj automatico

ESPERE 30 MINUTOS cuando esté desconectado el interruptor, después de la conexión de la antena y del cable de alimentación, ya que la función Auto Clock está activa. Después del ajuste automático del reloj, puede que tenga que ajustar la Zona horaria y la Hora de verano. Pulse **POWER** para encender el DVD/VCR después de completarse la operación de ajuste automático del reloj.

Ajuste del reloj manual

EJEMPLO: Ajuste del reloj a miércoles, 8:30 AM 30 (SAB) octubre, 2004.

- Presione el botón **VCR MENU**. Aparece la pantalla del menú de la VCR.
- Presione el botón **SET +** ó **-** para seleccionar la opción **SYSTEM SETUP**, luego presione el botón **ENTER**.
- Presione el botón **SET +** ó **-** para seleccionar la opción **CLOCK SET**, luego presione el botón **ENTER**.

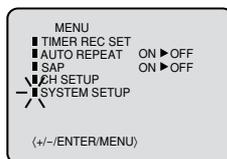

- Presione el botón **SET +** ó **-** para establecer el mes, y a continuación presione el botón **ENTER**.

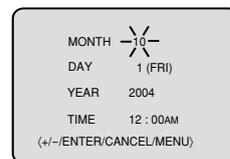

- Ajuste el día, año y hora de acuerdo con el procedimiento del paso 4.

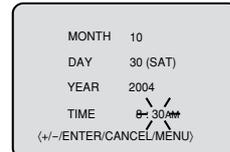

Spanish Quick Use Guide (Guía para rápida consulta)

Ajuste del reloj manual (continuación)

- 6 Una vez ajustado el reloj, la fecha y la hora empiezan a funcionar automáticamente.



Ajuste del canal de video

Para visualizar la reproducción de una cinta grabada, o para ver un programa seleccionado por el selector de canal del videograbador, el televisor deberá estar ajustado al canal 3 ó 4 (canal de video).

Cuando se conecta el TV sólo con un cable de antena.

- 1 Mantenga presionado **3** ó **4** en el control remoto durante 3 segundos en el modo espera para seleccionar CH 3 ó 4. El número del canal seleccionado parpadeará en la pantalla durante 4 segundos.

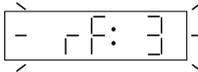

- 2 Encienda el televisor y ajústelo al canal 3 ó 4, en correspondencia con el canal seleccionado en el paso 1.
- 3 Presione el botón **POWER** para encender el DVD/VCR.
- 4 Presione **VCR/DVD** para seleccionar el modo VCR. El indicador VCR del panel frontal se iluminará.
- 5 Presione el botón selector **TV/VCR** para seleccionar la posición VCR. El indicador VCR se iluminará.
- 6 Presione el botón selector de canal en **▲** ó **▼** (CH **▲/▼**) para recibir una estación de TV de su área. El número de canal aparecerá en la pantalla durante unos 4 segundos.

Selección de idioma en pantalla

- 1 Presione el botón **VCR MENU**. Aparece la pantalla del menú de la VCR. Presione el botón **SET +** ó **-** para seleccionar la opción **SYSTEM SETUP**, luego presione el botón **ENTER**. Si utiliza la unidad por primera vez y presiona **VCR MENU**, es posible que aparezca la pantalla de menú **SYSTEM SETUP** del paso 2 en lugar de la pantalla del menú principal.

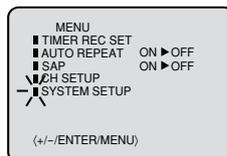

- 2 Presione el botón **SET +** ó **-** para seleccionar el modo **LANGUAGE**, luego presione el botón **ENTER**.

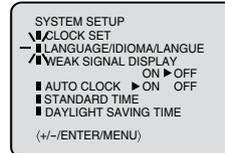

- 3 Presione el botón **SET +** ó **-** para seleccionar el idioma deseada: inglés (**ENGLISH**), español (**ESPAÑOL**) o francés (**FRANCAIS**), luego presione el botón **ENTER**.



- 4 Presione el botón **VCR MENU** para volver a la imagen normal de TV.

SELECCION DE TV/CABLE

- 1 Presione el botón **VCR MENU**. Aparece la pantalla del menú de la VCR. Presione el botón **SET +** ó **-** para seleccionar la opción **CH SETUP**, luego presione el botón **ENTER**.

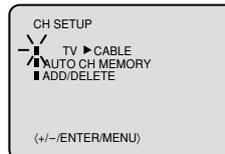

- 2 Presione el botón **SET +** ó **-** para seleccionar el modo TV/CABLE.

- 3 Presione el botón **ENTER** para seleccionar el modo TV o CABLE. La flecha indica el modo seleccionado.



TV - Canales de VHF/UHF
CABLE - Canales de TV Cable

- 4 Presione el botón **VCR MENU** dos veces para volver a la imagen normal de TV.

Ajuste automático de los canales

- 1 Repita el paso 1 anterior y presione el botón **SET +** ó **-** para seleccionar la opción **AUTO CH MEMORY**.



- 2 Luego presione el botón **ENTER**. Empieza la sintonización automática. La indicación de canal irá subiendo y cuando termina, la pantalla vuelve a su estado normal.





Spanish Quick Use Guide (Guía para rápida consulta)

COLOCACION

Presione en el centro del videocassette hasta que se retraiga automáticamente.

EXTRACCION

Presione el botón **EJECT** del DVD/VCR o control remoto. Extraiga el videocassette.



PARA INICIAR LA REPRODUCCION

Presione el botón **PLAY**. La reproducción comenzará. "▶" aparecerá en pantalla durante 4 segundos aproximadamente.

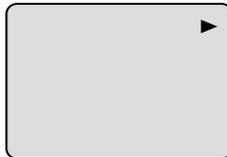

PARA INTERRUPIR REPRODUCCION

Presione el botón **STOP** (PARADA) una vez. La cinta parará, pero permanecerá cargada y lista para reproducir. "■" aparecerá en pantalla durante 4 segundos aproximadamente.



PARA REBOBINAR O AVANZAR LA CINTA RAPIDAMENTE

Detenga la reproducción o la grabación mediante **STOP**.

Para rebobinar la cinta:
Presione **REW**.

Para avanzar la cinta:
Presione **FF**.

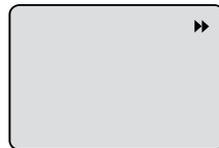

Para detener el bobinado de la cinta, presione **STOP**. Para pasar directamente a reproducción (sin presionar **STOP**), presione **PLAY**.

Modo de búsqueda de imagen hacia delante/atrás
Mientras se bobina la cinta, puede pasar al modo de búsqueda de imagen (ver página siguiente). Para ello, presione **REW** o **FF** y manténgalo presionado. La unidad volverá a bobinar la cinta en cuanto se suelte el botón.

Grabacion de un programa de TV

- 1 Coloque un cassette en el cual la lengüeta de protección contra borrados accidentales esté intacta. El DVD/VCR se encenderá automáticamente.
- 2 Presione el botón selector **SPEED** para seleccionar la velocidad de cinta deseada SP o SLP. El contador y SP o SLP se aparecerá en la pantalla durante 4 segundos aproximadamente.

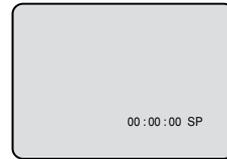

- 3 Ajuste la opción TV/CABLE en la posición apropiada.

TV - Canales de VHF/UHF
CABLE - Canales de TV Cable

- 4 Presione los botones de selección directa de canal para seleccionar el canal o **CH** ▲/▼ a grabar.

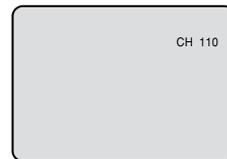

- 5 Presione el botón **REC/OTR**. "●" aparecerá en la pantalla durante 4 segundos aproximadamente. El indicador REC aparecerá en pantalla.

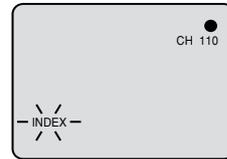

PARA DETENER LA GRABACION

Presione el botón de parada **STOP** para detener la grabación. "■" aparecerá en pantalla durante 4 segundos aproximadamente.



PARA DETENER TEMPORALMENTE LA GRABACION

Presione el botón **PAUSE/STILL** para evitar grabar material no deseado. "●||" aparecerá en pantalla durante 4 segundos aproximadamente. Presione nuevamente para continuar la grabación.





Spanish Quick Use Guide (Guía para rápida consulta)

Grabacion por temporizador de un solo toque (OTR)

EJEMPLO: Una grabación por temporizador de un solo toque para 30 minutos.

- 1 Coloque un cassette con la lengüeta de protección contra borrados accidentales esté intacta. El DVD/VCR se encenderá automáticamente.

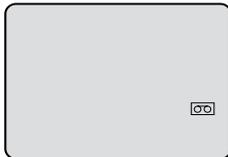

- 2 Presione el botón **SPEED** para seleccionar la velocidad de la cinta deseada SP o SLP. El contador y SP o SLP aparecerán en pantalla durante 4 segundos aproximadamente.



- 3 Ajuste la opción TV/CABLE en la posición apropiada.



- 4 Presione el botones de selección de canales directos o botón **CH ▲/▼** para seleccionar el canal a ser grabado.

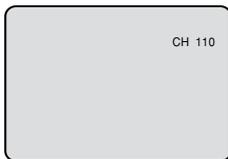

- 5 Presione el botón **REC/OTR** para comenzar la grabación. Presione el botón nuevamente para detener la grabación después de 30 minutos. Cada presión de el botón **REC/OTR** aumentará el tiempo de grabación tal como se muestra en el cuadro a continuación, hasta un máximo de 6 horas. OTR y el tiempo de grabación aparecerá en pantalla durante 4 segundos. Y REC seguirá parpadeando en el visualizador.

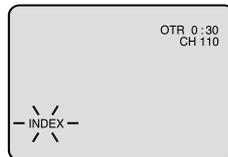

Para cancelar OTR

Presione el botón **STOP (PARADA)** para apagar la energía. "■" aparecerá en pantalla durante 4 segundos aproximadamente.



Grabacion por temporizador

EJEMPLO: Programe una grabación con temporizador para el día 26, canal 125 (TV Cable), 11:00 - 11:30 hrs. PM en el programa de temporización número 1 (VELOCIDAD DE CINTA: SLP).

- 1 Presione el botón de **VCR MENU**. Seleccione la opción **TIMER REC SET** y presione el botón **ENTER**.

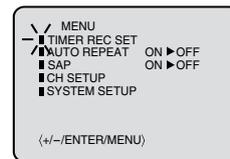

- 2 Presione el botón **SET + o -** para seleccionar el N° de programa, luego presione el botón **ENTER**.

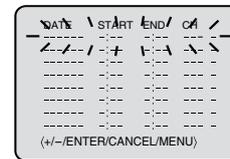

- 3 Presione el botón **SET + o -** para seleccionar la fecha deseada, luego presione el botón **ENTER**.

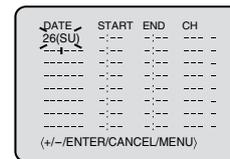

- 4 Ajuste el tiempo de partida, tiempo de término, canal y velocidad de cinta como en paso 3.

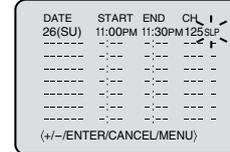

NOTAS:

- Presione el botón **CANCEL** para mover el cursor hacia atrás para hacer una corrección.
- Para grabar de una fuente externa, ajuste el canal a "L1" o "L2". "L1" o "L2" aparecerá al lado del canal 125 (o 69).

- 5 Para fijar otros programas, repita los pasos 2 al 4 para fija el otro programas. Para volver a la pantalla normal, presione dos veces **VCR MENU**.

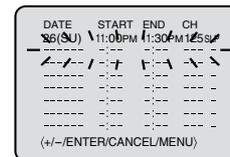

- 6 Presione y mantenga **PROG TIMER** durante mas de 1 segundo. El símbolo de reloj (🕒) aparecerá en el visualizador y el VCR quedará en modo de espera para grabación. Al mismo tiempo, el modo VCR cambiará automáticamente a modo DVD. Es posible utilizar el DVD incluso cuando el VCR está en modo de grabación por temporizador. Si no utiliza el DVD, apáguelo. La grabación por temporizador se iniciará 5 segundos antes de la hora predeterminada.





Spanish Quick Use Guide (Guía para rápida consulta)

Ajuste de la selección de idioma

- 1 Presione **SETUP** en el modo de parada. El MENÚ DE AJUSTE de DVD aparecerá en pantalla. Presione **▶** para seleccionar Other.

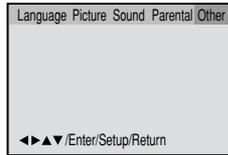

- 2 Presione **▼** o **ENTER** para seleccionar OSD Language.

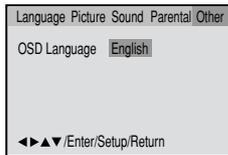

- 3 Presione **▶** o **ENTER** y presione **▲** o **▼** para seleccionar el idioma deseado (porejemplo English) y presione **ENTER**.

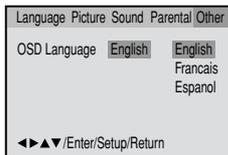

- 4 Para que desaparezca la pantalla SETUP, presione **SETUP** (o **RETURN**).

Procedimiento de reproducción

- 1 Presione **OPEN/CLOSE**. Se abrirá la bandeja del disco.



- 2 Coloque un disco en la bandeja. Sujete el disco, colóquelo con el lado de etiqueta impresa hacia arriba, alinee en las guía y coloque el disco en su posición correcta.

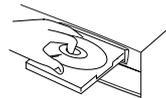

- 3 Presione **PLAY** u **OPEN/CLOSE**. La bandeja del disco se cierra automáticamente. En la pantalla del TV la indicación "▲" cambia a "Reading" y empieza la reproducción.



- Aparece la pantalla del menú en la pantalla de TV, si el disco tiene una función de menú. En este caso, presione **▲**, **▼**, **◀**, **▶** o **ENTER** para activar una función de menú.

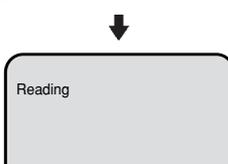

- 4 Presione **STOP** para terminar la reproducción.
 - El aparato graba el punto de parada, según el disco. Aparece "■" en la pantalla. "▶" sigue parpadeando en el visualizador hasta que se detenga por completo la reproducción. Presione **PLAY** para continuar reproduciendo (desde el mismo punto).
 - Si presiona nuevamente **STOP** o se retira el disco (Aparece "■" en la pantalla), el aparato borrará el punto de parada.

- 5 A continuación presione **OPEN/CLOSE**. Se abre la bandeja del disco. Saque el disco y **POWER**. La bandeja del disco se cierra automáticamente y se desconecta el aparato.

Reproducción con avance rápido

Presione **FF** (▶▶) durante la reproducción normal. Cada vez que presione el botón de **FF** (▶▶), aumentará la velocidad de la búsqueda ▶▶ (x2), ▶▶▶▶ (x4), ▶▶▶▶▶▶ (x8), ▶▶▶▶▶▶▶▶ (x20).

- Para seguir con la reproducción normal, presione **PLAY**.

Reproducción con retroceso rápido

Presione **REW** (◀◀) durante la reproducción normal. Cada vez que presione el botón de **REW** (◀◀), aumentará la velocidad de la búsqueda ◀◀ (x2), ◀◀◀◀ (x4), ◀◀◀◀◀◀ (x8), ◀◀◀◀◀◀◀◀ (x20).

- Para seguir con la reproducción normal, presione **PLAY**.

Reproducción Fija

Presione **PAUSE/STILL** durante la reproducción normal para hacer una pausa en la reproducción. Para seguir con la reproducción normal, presione **PLAY**.

Avance cuadro por cuadro

Presione **PAUSE/STILL** durante la imagen fija. Avanza un cuadro cuando presione **PAUSE/STILL** una vez. Para seguir con la reproducción normal, presione **PLAY**.

Reproducción de cámara lenta

Presione **SLOW** (◀1/▶) durante la reproducción normal o cuadro a cuadro. Cada vez que presione **SLOW**, cambiará la velocidad del slow x1/2, x1/4, x1/6, x1/7.

- Para seguir con la reproducción normal, presione **PLAY**.
- Para volver a la imagen fija, presione **PAUSE/STILL**.

Búsqueda de un capítulo o canción o canción

Presione **SKIP** (▶▶▶) en avance o **SKIP** (◀◀◀) en retroceso durante la reproducción para buscar un capítulo que desea ver. Cada vez que presione el botón, se salta un capítulo o canción.





Limited Warranty

PANASONIC CONSUMER ELECTRONICS COMPANY,
 DIVISION OF MATSUSHITA ELECTRIC
 CORPORATION OF AMERICA
 One Panasonic Way
 Secaucus, New Jersey 07094

PANASONIC SALES COMPANY,
 DIVISION OF MATSUSHITA
 ELECTRIC OF PUERTO RICO, INC.,
 AVE. 65 de Infantería, Km. 9.5
 San Gabriel Industrial Park
 Carolina, Puerto Rico 00985

Panasonic DVD/VCR Deck Limited Warranty

Limited Warranty Coverage

If your product does not work properly because of a defect in materials or workmanship, Panasonic Consumer Electronics Company or Panasonic Sales Company (collectively referred to as "the warrantor") will, for the length of the period indicated on the chart below, which starts with the date of original purchase ("Limited Warranty period"), at its option either (a) repair your product with new or refurbished parts, or (b) replace it with a new or a refurbished product. The decision to repair or replace will be made by the warrantor.

Product or Part Name	Parts	Labor
DVD/VCR Deck	One (1) Year	Ninety (90) Days
Rechargeable Batteries (in exchange for defective item)	Ten (10) Days	Not Applicable

During the "Labor" Limited Warranty period there will be no charge for labor. During the "Parts" warranty period, there will be no charge for parts. You must mail-in your product during the warranty period. If non-rechargeable batteries are included, they are not warranted. This Limited Warranty only applies to products purchased and serviced in the United States or Puerto Rico. This Limited Warranty is extended only to the original purchaser and only covers product purchased as new. A purchase receipt or other proof of original purchase date is required for Limited Warranty service.

Mail-In Service

For assistance in the continental U.S.A. in obtaining repairs please ship the product to:

Panasonic Services Company
Customer Servicer
Suite B
4900 George McVay Drive
McAllen, TX 78503

For assistance in Puerto Rico call Panasonic Sales Company (787)-750-4300 or fax (787)-768-2910.

When shipping the unit carefully pack and send it prepaid, adequately insured and preferably in the original carton. Include a letter detailing the complaint and provide a day time phone number where you can be reached.

IF REPAIR IS NEEDED DURING THE LIMITED WARRANTY PERIOD THE PURCHASER WILL BE REQUIRED TO FURNISH A SALES RECEIPT/PROOF OF PURCHASE INDICATING DATE OF PURCHASE, AMOUNT PAID AND PLACE OF PURCHASE. CUSTOMER WILL BE CHARGED FOR THE REPAIR OF ANY UNIT RECEIVED WITHOUT SUCH PROOF OF PURCHASE.





Limited Warranty Limits And Exclusions

This Limited Warranty ONLY COVERS failures due to defects in materials or workmanship, and DOES NOT COVER normal wear and tear or cosmetic damage. The Limited Warranty ALSO DOES NOT COVER damages which occurred in shipment, or failures which are caused by products not supplied by the warrantor, or failures which result from accidents, misuse, abuse, neglect, mishandling, misapplication, alteration, faulty installation, set-up adjustments, misadjustment of consumer controls, improper maintenance, power line surge, lightning damage, modification, or commercial use (such as hotel, office, restaurant, or other business), rental use of the product, or service by anyone other than a Factory Servicenter or other Authorized Servicer, or damage that is attributable to acts of God.

THERE ARE NO EXPRESS WARRANTIES EXCEPT AS LISTED UNDER "LIMITED WARRANTY COVERAGE". THE WARRANTOR IS NOT LIABLE FOR INCIDENTAL OR CONSEQUENTIAL DAMAGES RESULTING FROM THE USE OF THIS PRODUCT, OR ARISING OUT OF ANY BREACH OF THIS WARRANTY. (As examples, this excludes damages for lost time, cost of having someone remove or re-install an installed unit if applicable, travel to and from the servicer, loss of or damage to media or images, data or other recorded content. The items listed are not exclusive, but are for illustration only.)

ALL EXPRESS AND IMPLIED WARRANTIES, INCLUDING THE WARRANTY OF MERCHANTABILITY, ARE LIMITED TO THE PERIOD OF THE LIMITED WARRANTY.

Some states do not allow the exclusion or limitation of incidental or consequential damages, or limitations on how long an implied Limited Warranty lasts, so the exclusions may not apply to you. This Limited Warranty gives you specific legal rights and you may also have other rights which vary from state to state. If a problem with this product develops during or after the Limited Warranty period, you may contact your dealer or Servicenter. If the problem is not handled to your satisfaction, then write to the warrantor's Consumer Affairs Department at the addresses listed for the warrantor.

PARTS AND SERVICE, WHICH ARE NOT COVERED BY THIS LIMITED WARRANTY, ARE YOUR RESPONSIBILITY.

Customer Services Directory

For Product Information, Operating Assistance, Literature Request, Dealer Locations, and Customer Service inquiries please visit Web Site:

<http://www.panasonic.com>

You can purchase parts, accessories, locate your nearest servicenter and more by visiting our Web Site

or E-mail us via web:

http://www.panasonic.com/consumer_electronics/support/customerfeedback.asp

Contact:

1-800-211-PANA (7262),

Monday-Friday 9 am-9 pm; Saturday-Sunday 10 am-7 pm, EST.

For hearing or speech impaired TTY users, TTY : 1-877-833-8855

Accessory Purchases

1-800-332-5368 (Customer Orders Only)

1-800-237-9080 (Fax Only)

(Monday-Friday 9 am-8 pm, EST.) Panasonic Services Company

20421 84th Avenue South, Kent, WA 98032

(Accepts Visa, MasterCard, Discover Card, American Express, and Personal Check)

<http://www.pasc.panasonic.com> or email to parts@panasonic.com

For hearing or speech impaired TTY users, TTY : 1-866-605-1277

Service in Puerto Rico

Matsushita Electric of Puerto Rico, Inc. Panasonic Sales Company/ Factory Servicenter:

Ave. 65 de Infantería Km. 9.5, San Gabriel Industrial Park, Carolina, Puerto Rico 00985

Phone (787)750-4300 Fax (787)768-2910





Index

A		
Accessory	7	
Add/Delete Channels	23	
Angle	43	
Aspect Ratio of TV Screen	52	
Audio CD	6,41	
Auto CH memory	22	
Auto Clock	18	
Auto Repeat	26	
Auto Rewind	29	
Automatic Playback	24	
Automatic Power On	24	
Automatic Tape Eject	24	
A-B Repeat Playback	40	
B		
Battery	11	
C		
Chapter	6	
CH ▲/▼	28	
Clock/Counter	27	
Commercial Skip	26	
Condensation	5	
Connection	12-17	
Counter Reset	27	
Customer Services Directory	65	
D		
Daylight Saving Time	19	
Digital Audio Out	17	
Disc Information	6	
Display	29,53	
Duplicating a Video Tape	34	
DVD Menu	43	
Dynamic Range Control (DRC)	54	
E		
Erase Prevention Tab	24	
F		
Fast Forward Playback	26,37	
Forward	25	
Frame advance	26,37	
I		
Important Safeguards	3	
J		
JPEG	44	
Jump	38	
K		
Karaoke	42	
L		
Language	21, 35, 49, 50, 51	
Language Code List	55	
Letter Box	52	
Limited Warranty	64	
Loading	24	
Locating a Chapter or Track	37	
M		
Manual Clock Setting	20	
Marker	39	
MP3	44	
O		
One-touch Timer Recording (OTR)	30	
P		
Pan Scan	52	
Parental Control	47	
Parts and Functions	8	
Picture Search	26	
Playback	25,36	
Power Source	11	
Problems and Troubleshooting	56	
Program Playback	41	
Progressive Scan	35	
R		
Random Playback	41	
Recording	28	
Region Number	6	





Remote Control	10
Repeat Playback	40
Review Playback	26,37
Rewind	25

S

Second Audio Program (SAP)	33
Slide-show	46
Slow Motion	26,37
Spanish Quick Use Guide	59
Specifications	58
Standard Time	18
Stereo Recording and Playback	33
Still	26
Stop	25, 36
Subtitle	42
Soundtrack	42

T

Timer Recording	31
Title	6
Title Selection	43
Track	6
Tracking	26
Tuner Setting	22
TV/CABLE Selection	22

U

Unloading	24
-----------------	----

V

Video Channel	21
Video Head Cleaning	57
Video Index Search System	27

W

Weak Signal Display	23
Wide	52

Z

Zero Search	27
Zooming	38





Panasonic Consumer Electronics Company,
Division of Matsushita Electric Corporation of America
 One Panasonic Way Secaucus,
 New Jersey 07094
Panasonic Sales Company ("PSC"),
Division of Matsushita Electric of Puerto Rico, Inc.
 Ave. 65 de Infanteria. Km. 9.5
 San Gabriel Industrial Park, Carolina, Puerto Rico 00985



J2D81601A

04/09 



Printed in Thailand





IMPORTANT NOTICE

To ensure the AUTO CLOCK setup will be completed, please do the following:

- Make sure to connect the Antenna or Cable to this deck before plugging the AC cord.
- Plug in the AC Cord. **DO NOT TURN ON** the Deck yet.
- Wait until the Auto Clock set up is completed. Once clock is set, you can turn the unit ON.
- If, after more than 30 minutes, the CLOCK was not set, please set the clock manually following the procedures on page 20 of the Operating Manual.



Printed in Thailand

