



DRAFT

TOSHIBA



Hi-Fi VCR & DVD VIDEO RECORDER

D-VRW1SU

OWNER'S MANUAL

VHS Hi-Fi

Introduction	2
Various settings	23
Disc playback	33
Tape playback	48
Recording	52
Editing the disc	61
Dubbing	76
Additional information	79



©2005 Toshiba Corporation
This device does not tape-record copy protected DVD Video Discs.

SAFTY PRECAUTIONS



The lightning flash with arrowhead symbol, within an equilateral triangle is intended to alert the user to the presence of uninsulated dangerous voltage within the product's enclosure that may be of sufficient magnitude to constitute a risk of electric shock to persons.



The exclamation point within an equilateral triangle is intended to alert the user to the presence of important operating and maintenance (servicing) instructions in the literature accompanying the appliance.

WARNING: TO REDUCE THE RISK OF FIRE OR ELECTRIC SHOCK, do not expose this appliance to rain or moisture.

CAUTION: TO PREVENT ELECTRIC SHOCK DO NOT USE THIS POLARIZED PLUG WITH AN EXTENSION CORD, RECEPTACLE OR OTHER OUTLET UNLESS THE BLADES CAN BE FULLY INSERTED TO PREVENT BLADE EXPOSURE.

FCC NOTICE: This equipment has been tested and found to comply with the limits for a Class B digital device, pursuant to Part 15 of the FCC Rules. These limits are designed to provide reasonable protection against harmful interference in a residential installation. This equipment generates, uses and can radiate radio frequency energy and, if not installed and used in accordance with the instructions, may cause harmful interference to radio communications.

However, there is no guarantee that interference will not occur in a particular installation. If this equipment does cause harmful interference to radio or television reception, which can be determined by turning the equipment off and on, the user is encouraged to try to correct the interference by one or more of the following measures:

- Reorient or relocate the receiving antenna.
- Increase the separation between the equipment and receiver.
- Connect the equipment into an outlet on a circuit different from that to which the receiver is connected.
- Consult the dealer or an experienced radio/TV technician for help.

CAUTION: Changes or modifications not expressly approved by the party responsible for compliance with the FCC Rules could void the user's authority to operate this equipment.

CAUTION: THIS DIGITAL VIDEO PLAYER EMPLOYS A LASER SYSTEM.

TO ENSURE PROPER USE OF THIS PRODUCT, PLEASE READ THIS USER'S GUIDE CAREFULLY AND RETAIN FOR FUTURE REFERENCE. SHOULD THE UNIT REQUIRE MAINTENANCE, CONTACT AN AUTHORIZED SERVICE LOCATION.

USE OF CONTROLS, ADJUSTMENTS OR THE PERFORMANCE OF PROCEDURES OTHER THAN THOSE SPECIFIED HEREIN MAY RESULT IN HAZARDOUS RADIATION EXPOSURE.

TO PREVENT DIRECT EXPOSURE TO LASER BEAM, DO NOT TRY TO OPEN THE ENCLOSURE. VISIBLE LASER RADIATION MAY BE PRESENT WHEN THE ENCLOSURE IS OPENED. DO NOT STARE INTO BEAM.

Location of the required Marking

The rating sheet and the safety caution are on the rear of the unit.

CERTIFICATION: COMPLIES WITH FDA RADIATION PERFORMANCE STANDARDS, 21 CFR SUBCHAPTER J.

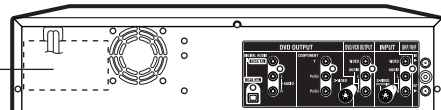

IMPORTANT SAFEGUARDS

1. READ INSTRUCTIONS

All the safety and operating instructions should be read before the unit is operated.

2. RETAIN INSTRUCTIONS

The safety and operating instructions should be retained for future reference.

3. HEED WARNINGS

All warnings on the unit and in the operating instructions should be adhered to.

4. FOLLOW INSTRUCTIONS

All operating and use instructions should be followed.

5. CLEANING

Unplug this unit from the wall outlet before cleaning. Do not use liquid cleaners or aerosol cleaners.

Use a soft dry cloth for cleaning the exterior cabinet only.

6. ATTACHMENTS

The manufacturer of this unit does not make any recommendations for attachments, as they may cause hazards.

7. WATER AND MOISTURE

Do not use this unit near water. For example, near a bathtub, washbowl, kitchen sink, laundry tub, in a wet basement, or near a swimming pool.

8. ACCESSORIES

Do not place this unit on an unstable cart, stand, tripod, bracket, or table.

The unit may fall, causing serious injury, and serious damage to the unit.

- 8A.** An appliance and cart combination should be moved with care. Quick stops, excessive force, and uneven surfaces may cause the appliance and cart combination to overturn.

9. VENTILATION

Slots and openings in the cabinet back or bottom are provided for ventilation, to ensure reliable operation of the unit, and to protect it from overheating.

These openings must not be blocked or covered. The openings should never be blocked by placing the unit on a bed, sofa, rug, or other similar surface. This unit should never be placed near or over a radiator or heat source. This unit should not be placed in a built-in installation such as a bookcase or rack unless proper ventilation is provided and/or the manufacturer's instructions have been adhered to.

10. POWER SOURCE

This unit should be operated only from the type of power source indicated on the rating plate. If you are not sure of the type of power supply to your home, consult your appliance dealer or local power company.

11. GROUNDING OR POLARIZATION

This unit is equipped with a polarized alternating-current line plug (a plug having one blade wider than the other). This plug will fit into the power outlet only one way. This is a safety feature. If you are unable to insert the plug fully into the outlet, try reversing the plug. If the plug should still fail to fit, contact your electrician to replace your obsolete outlet. Do not defeat the safety purpose of the grounding-type plug.

12. POWER-CORD PROTECTION

Power-supply cords should be routed so that they are not likely to be walked on or pinched by items placed upon or against them, paying particular attention to cords at plugs, convenience receptacles, and the point where they exit from the appliance.

PORTABLE CART WARNING
(symbol provided by RETAC)



S3125A

IMPORTANT SAFEGUARDS

13. LIGHTNING

To protect your unit from a lightning storm, or when it is left unattended and unused for long periods of time, unplug it from the wall outlet and disconnect the antenna or cable system. This will prevent damage to the unit due to lightning and power line surges.

14. POWER LINES

An outside antenna system should not be located in the vicinity of overhead power lines or other electric light or power circuits, or where it can fall onto or against such power lines or circuits. When installing an outside antenna system, extreme care should be taken to keep from touching such power lines or circuits, as contact with them might be fatal.

15. OVERLOADING

Do not overload wall outlets and extension cords, as this can result in a risk of fire or electric shock.

16. OBJECT AND LIQUID ENTRY

Do not push objects through any openings in this unit, as they may touch dangerous voltage points or short out parts that could result in fire or electric shock. Never spill or spray any type of liquid into the unit.

17. OUTDOOR ANTENNA GROUNDING

If an outside antenna or cable system is connected to the unit, be sure the antenna or cable system is grounded to provide some protection against voltage surges and built-up static charges, Section 810 of the National Electrical Code, ANSI/NFPA 70, provides information with respect to proper grounding of the mast and supporting structure, grounding of the lead-in wire to an antenna discharge unit, size of grounding conductors, location of antenna discharge unit, connection to grounding electrodes, and requirements for the grounding electrode.

EXAMPLE OF ANTENNA GROUNDING AS PER THE NATIONAL ELECTRICAL CODE

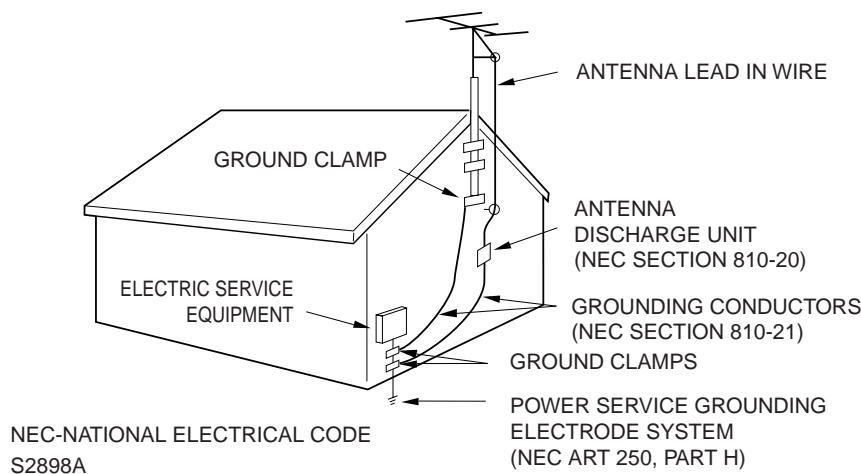

18. SERVICING

Do not attempt to service this unit yourself as opening or removing covers may expose you to dangerous voltage or other hazards. Refer all servicing to qualified service personnel.

For example:

- a. When the power-supply cord or plug is damaged.
- b. If liquid has been spilled, or objects have fallen into the unit.
- c. If the unit has been exposed to rain or water.
- d. If the unit does not operate normally by following the operating instructions. Adjust only those controls that are covered by the operating instructions, as an improper adjustment of other controls may result in damage and will often require extensive work by a qualified technician to restore the unit to its normal operation.
- e. If the unit has been dropped or the cabinet has been damaged.
- f. When the unit exhibits a distinct change in performance, this indicates a need for service.

IMPORTANT SAFEGUARDS

19. REPLACEMENT PARTS

When replacement parts are required, be sure the service technician uses replacement parts specified by the manufacturer or those that have the same characteristics as the original part.

Unauthorized substitutions may result in fire, electric shock or other hazards.

20. SAFETY CHECK

Upon completion of any service or repairs to this unit, ask the service technician to perform safety checks to determine that the unit is in proper operating condition.

21. HEAT

The product should be situated away from heat sources such as radiators, heat registers, stoves, or other products (including amplifiers) that produce heat.

22. DISC TRAY

Keep your fingers well clear of the disc tray as it is closing. It may cause serious personal injury.

23. CONNECTING

When you connect the product to other equipment, turn off the power and unplug all of the equipment from the wall outlet. Failure to do so may cause a product damage. Read the owner's manual of the other equipment carefully and follow the instructions when making any connections.

24. LASER BEAM

Do not look into the opening of the disc tray or ventilation opening of the product to see the source of the laser beam. It may cause sight damage.

25. DISC

Do not use a cracked, deformed, or repaired disc. These discs are easily broken and may cause serious personal injury and product malfunction.

26. NOTE TO CABLE TV SYSTEM INSTALLER

This reminder is provided to call the Cable TV system installer's attention to Article 820-40 of the NEC that provides guidelines for proper grounding and, in particular, specifies that the cable ground shall be connected to the grounding system of the building, as close to the point of cable entry as practical.

CONDENSATION

Moisture will form in the operating section of the DVD/VCR if the unit is brought from cool surroundings into a warm room or if the temperature of the room rises suddenly. When this happens, the DVD/VCR's performance will be impaired.

To prevent this, let the DVD/VCR stand in its new surroundings for about an hour before switching it on, or make sure that the room temperature rises gradually.

Condensation may also form during the summer if the DVD/VCR is exposed to the breeze from an air conditioner. In such cases, change the location of the DVD/VCR.

* This product incorporates copyright protection technology that is protected by method claims of certain U.S. patents and other intellectual property rights owned by Macrovision Corporation and other rights owners. Use of this copyright protection technology must be authorized by Macrovision Corporation and is intended for home and other limited viewing uses only unless otherwise authorized by Macrovision Corporation. Reverse engineering or disassembly is prohibited.

Consumers should note that not all high definition television sets are fully compatible with this product and may cause artifacts to be displayed in the picture. In case of 525 progressive scan picture problems, it is recommended that the user switch the connection to the "STANDARD DEFINITION" output. If there are questions regarding our TV set compatibility with this model 525p DVD player, please contact our customer service center.

* Manufactured under license from Dolby Laboratories. "Dolby" and the double-D symbol are trademarks of Dolby Laboratories.

* "DTS" and "DTS Digital Out" are trademarks of Digital Theater Systems, Inc.

* Unauthorized recording of copyrighted television programs, films, video cassettes and other materials may infringe the rights of copyright owners and be contrary to copyright laws.

* Certain audio features of this product manufactured under a license from Desper Products, Inc. Spatializer®, N-2-2™ and the circle-in-square device are trademarks owned by Desper Products, Inc.

* Windows Media and the Windows logo are either registered trademarks or trademarks of Microsoft Corporation in the United States and/or other countries.

Contents

Introduction

● SAFTY PRECAUTIONS	2
● IMPORTANT SAFEGUARDS	3
● Contents	6
● Features	8
● Disc	9
Handling discs	9
Discs which can be played back	9
Discs on which video can be recorded	10
DVD-RW	10
DVD-R	10
Recording format	10
Disc playback in other players	11
On Video CDs	11
● Parts and functions	12
Front	12
Rear	12
Display window	13
Remote control	14
Power Source	15
● Antenna connections	16
● Cable TV connections	18
● Connections with the TV or audio	
component	20
● Auto clock setting	22
● Setting the video channel	22

Various settings

● SETUP MENU	23
Using the SETUP MENU	23
● Setting the language	24
OSD LANGUAGE	24
DVD MENU	24
AUDIO	24
SUBTITLE	24
● Setting the parental control	25
Selecting parental control	25
Temporarily cancelling parental control	25
● Setting the clock	26
CLOCK (manually)	26
AUTO CLOCK	26
STANDARD TIME (Time zone)	26
DAYLIGHT SAVING TIME	26
● Setting the disc	27
REFORMAT	27
NEW DISC FORMAT	27
FINALIZE	27
PROTECT DISC	28
UNDO FINALIZE	28
● Other (SYSTEM SETUP)	28
DIMMER (Brightness of the display window) ...	28
DISPLAY/CALL (Turning the screen display	
"ON" or "OFF")	28

● Setting the screen	29
TV SCREEN	29
STILL MODE	29
LINE1 INPUT/LINE2 INPUT	29
● Setting the image quality	30
BRIGHTNESS	30
E.B.L.	30
● Setting the audio	30
DRC	30
VIRTUAL SURROUND (Spatializer N-2-2™) ...	30
EXTERNAL AUDIO INPUT	30
SAP (Second Audio Program)	31
● Setting the recording	31
INITIAL REC TO	31
INITIAL REC MODE	31
AUTO CHAPTER	31
INDEX PICTURE	31
BLACK LEVEL (REC)	31
● Setting the channel	32
TV/CABLE SELECT	32
AUTO CH MEMORY	32
ADD/DELETE (channels)	32
● Setting other items	32
JPEG INTERVAL	32

Disc playback

● Playback procedure	33
● Playback by selecting a title	34
● Checking media information	35
● Special playback	36
Fast forward playback	36
Review playback	36
Still playback	36
Frame advance	36
Slow motion playback	36
Locating a chapter or track	36
● Instant skip	37
● Locating a specific scene	37
● Repeat playback	38
Instant replay	38
A-B repeat playback	38
Title, Chapter repeat playback	38
● Title selection	39
● DVD menu	39
● Changing angles	40
● Zooming	40
● Karaoke playback	40
● Changing soundtrack language	41
● Subtitles	41
Changing soundtrack language	41
Turning the subtitles On and Off	41
● To turn off the PBC	41
● Various operations on CD	42
● MP3/WMA/JPEG playback	44
● Progressive scan	47

Contents

Tape playback

- **Loading and unloading a cassette tape** 48
- **Cassette tape playback** 49
- **Special playback** 50
 - Picture search 50
 - Still picture 50
 - Slow motion 50
 - Frame by frame picture 50
 - Adjusting tracking condition 50
 - Repeat playback 50
 - Instant skip 50
 - To display VCR operation status 50
- **ZERO RETURN function** 51
- **Video index search system** 51

Recording

- **Read this before recording on disc** 52
 - Types of disc 52
 - Recording modes 52
 - Disc remaining time 52
 - Images that cannot be recorded 53
- **Recording a TV program** 54
- **One-touch Timer Recording (OTR)** 56
- **Timer recording** 57
- **Stereo recording and playback** 60

Editing the disc

- **Editing the disc** 61
- **Editing a playlist** 62
 - Creating a playlist 62
 - Changing a title name 63
 - Erasing a scene (Edit title) 64
 - Combining the title 66
 - Erasing a playlist 67
- **Editing an original title** 68
 - Adding a chapter mark 68
 - Combining chapters 69
 - Changing an original title name 70
 - Erasing a scene (Edit title) 71
 - Erasing an original title 72

- **Changing a disc name** 73
 - Changing a disc name 73
 - Using the keyboard screen 74

Dubbing

- **Dubbing a tape onto a disc** 76
- **Dubbing a disc onto a tape** 77
- **Dubbing using other equipment** 78







Introduction

Additional information

- **Glossary** 79
- **Language code list** 81
- **Problems and troubleshooting** 82
- **Video head cleaning** 83
- **Error/Warning message list** 84
- **Specifications** 85

Media mark

Each applicable media are indicated using the symbol shown below.

	: DVD-Video		: DVD-R
	: DVD-RW in VR mode		: Audio/Video CD and CD-R/CD-RW
	: DVD-RW in Video mode		: Video tape

Features

Not only can you playback and record video tapes, but you can also playback DVD discs or make recordings using DVD-RW or DVD-R discs with this unit. In addition, you can enjoy editing the programs you record.

Playback function

A realistic, powerful, Movie Theater sound



When connected to Dolby Digital and DTS compliant devices, you can enjoy realistic, powerful surround sound.

Playback the scene you want to see immediately



As DVD's do not require rewinding like video tapes, you can get to the scene you wish to watch immediately. A variety of search functions allow you to find the scene you wish to watch.

Title menu



As thumbnail images are displayed in the title menu, you can find the title you want to play back quickly.

- Thumbnail image will not appear after finalizing and DVD-R

Video CD/SVCD/MP3/WMA/JPEG playback



Video CD/SVCD/MP3/WMA files can be played back. Also, you can display JPEG files on the TV screen and enjoy them as a slide show.

Progressive scan



This unit supports the progressive scanning system. If your TV is equipped with component video input jacks which support the progressive video input, you can enjoy high quality picture.

Recording function

Timer recording



The timer recording system allows you to select the date, time and channel and record the desired programs. Up to 12 timer programs within a month can be stored in this unit.

One-touch Timer Recording (OTR)



The One-touch Timer Recording feature provides a simple and convenient way to make a timed recording.

Edit function

Editing recorded material without changing the original titles



You can create a playlist based on the original titles. The playlist won't affect the original titles. If you erase the playlist, the original titles remain. It is recommended to create and edit the playlist to prevent important titles from being erased accidentally.

Chapter mark



You can add (or delete) a chapter mark to (from) the original title. This function is useful when searching for the scene you wish to watch that you have marked with the Chapter mark function.

Erasing scenes



You can erase an unnecessary scene from the created playlist or the original titles.

Combining titles



You can combine several original titles or playlists to a separate playlist.

Dubbing function

Dubbing a tape onto a disc or a disc onto a tape



With just this one unit, you can dub however you like, from video tape to disc, or from disc to video tape.

- Dubbing cannot be carried out when attempting to copy a "copy guarded" video tape or disc.



Disc

Handling discs

Removing the Disc from its case

Be sure to hold the disc by its edges. Do not touch the surface of the disc. Take the disc carefully from its case.



- Do not scratch the disc.
- Do not get dirt on the surface of the disc.
- Do not stick labels or adhesive tapes on the disc.
- Do not drop or bend the disc.

Storing discs

- Store the disc in the case to avoid any risk of scratches, dirt or damage.
- Do not leave the disc exposed to direct sunlight or in hot or humid places.

Cleaning discs

Wipe the disc with a clean, dry cloth from the center outward toward the edges.

- Do not wipe the disc in a circular motion around the center.
- Do not use liquid or aerosol cleaners.

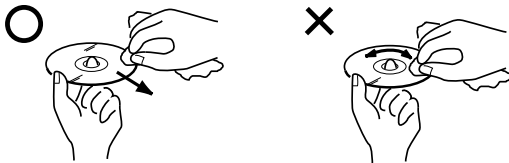

Discs which can be played back

In this unit, use only discs that meet the standard, such as those bearing the below logo marks on the disc label surface. If you use a non-standard disc, we cannot guarantee playback. Even if such a disc can be played back, we cannot guarantee the image or sound quality. The DVD logo is a registered trademark.

Media type	Logo mark
DVD-Video	
DVD-R W Ver.1.0 Ver.1.2 Ver.1.1 CPRM support	
DVD-R Ver.2.0(Ver.2.0/4x/8x)	
Audio CD*	
Video CD SVCD	
CD-R/CD-RW	

* This unit is designed to playback music Compact Discs (CD) that conform to the CD standard. CDs that contain (copy-restriction) signals to protect copyrights cannot be played back.

Notes on DVDs and Video CDs

Because of problems and errors that can occur during the creation of DVD and Video CD software and/or the manufacture of DVD and Video CD discs, Toshiba cannot guarantee that this DVD/VCR will play every feature of every DVD bearing the DVD logo and/or every Video CD bearing the CD logo. As one of the creators of DVD technology, Toshiba DVD players are manufactured using the highest standards of quality, and as a result, such incompatibilities are rare. If you happen to experience any difficulty playing a DVD or a Video CD on this DVD/VCR, please feel free to call our Consumer Solution Center (see page 87).

Region management information

This unit is designed and manufactured to support the region management information that is recorded on a DVD disc. If the region number written on the DVD disc does not correspond to the region number of this unit, this unit cannot play that disc.

- The region number of this unit is "1".
- The unit will play DVD-Video discs marked with labels containing "1" or "ALL".



Operating DVD-Video

- Some operations of DVD-Video may be prohibited by the manufacturer, or some operation methods or functions of the DVD-Video may be different from the description in this manual.
- If you attempt an operation that is prohibited by either the disc or the unit, a "⚡" mark will appear on the TV monitor. For operations prohibited by the disc, see the information that came with the disc.
- When the menu screen or the operation guide appears during disc playback, follow the displayed information.

Discs which cannot be played back

The discs listed below cannot be played back in general. Even if one of these can be played back, it may not be played back correctly. If a disc is played back by mistake, extensively loud sounds may blow the speakers or may damage the hearing of those in hearing range. Do not playback the discs listed below.

CDG, Photo-CD, CD-ROM, CD-TEXT, CD-EXTRA, SACD, PD, CDV, DVD-ROM, DVD-RAM, DVD+R/RW, DVD audio, etc.

The below DVD-Video may not be played back.

- DVD-Video that do not have the region number "1" or "ALL".
- PAL or SECAM DVD-Video.
- Prohibited or business-use DVD-Video.

CD-R/CD-RWs cannot be played back for the following reasons.

- Compatibility of the disc and this unit.
- Compatibility of the disc and the recorder used.
- Unfinalized discs.



Do not playback the following discs. Playback of these discs may cause a failure.

- Discs on which paper, labels or stickers are affixed.
- Discs that have sticky areas left by adhesive tape.
- Special-shaped discs.

Disc

Discs on which video can be re-recorded

To record video with this unit, use the discs below:

Media type	Logo mark
DVD-RW Ver.1.0 Ver.1.1 Ver.1.2 Ver.1.1CPRM support	
DVD-R Ver.2.0 (Ver.2.0/4x/8x)	

DVD-RW

- The disc can be erased and used again about 1,000 times.
- Only the VR mode can be used for Ver.1.0 discs.
- With Ver.1.1/1.2 discs, you can record by selecting the VR mode or Video mode.
- When you record in the VR mode, you can repeatedly record and erase. By erasing unnecessary titles, you effectively increase remaining time.
- When you record in the Video mode, you can record until the disc becomes full.
- When you use the Video mode, you can newly record on the disc by formatting the disc. However, if the disc is formatted, all the recorded contents will be erased.

DVD-R

- You can record on the disc only in the Video mode.
- You can record until the disc becomes full.
- Finalizing the discs allows playback on other DVD players. However, the finalized discs can no longer be recorded.
- Discs can be recorded to repeatedly until they are finalized.

NOTES:

- There are some players that cannot playback discs that were recorded with this unit. We cannot guarantee the playback with other units.
- This unit cannot record on DVD-RW/R discs that are 8 cm in diameter.
- This unit cannot record on CD-RW/R.

Recording format

This unit has two modes for formatting discs for recording: VR mode and Video mode.

When a blank, new disc is loaded into this unit, the automatic format function starts to format the disc. (For the disc format setting in this step, see page 27.)

VR mode

- This mode can be used for DVD-RW.
- In this mode, the discs can be recorded and edited repeatedly.
- The disc recorded in this mode can be played back with other DVD-RW-compatible players.
- When a Ver.1.1 CPRM or Ver. 1.2 disc is used, you can record a "Copy Once" program (see page 53).

Video mode

- This mode can be used for DVD-R and DVD-RW (Ver.1.1/1.2).
- When you finalize the disc after recording, the disc recorded with this unit can be played back with other DVD players.
- Recording, editing or playback of an unfinalized disc can be done only with this unit. However, there are some limitation to editing operations.
- In this mode, you cannot record a "Copy Once" program (see page 53).
- When you record a TV program of a bilingual broadcast, only one of the audio modes can be recorded. You have to select it.

Format modes that can be used with each disc

The usable format depends on the media type as shown in the below table.

Media type	Format	Available functions
DVD-RW (Ver.1.0)	VR mode	Playback, recording and editing (Original/playlist)
DVD-RW (Ver.1.1 and 1.2)	VR mode	Playback, recording and editing (Original/playlist)
	Video mode	Playback and recording Editing (with limitation)
DVD-R (Ver.2.0/4x/8x)	Video mode	Playback and recording Editing (with limitation)



Disc

Title/Chapter/Track

A DVD-Video has large partitions called "Titles", and smaller partitions within them called "Chapters".

A music CD has other partitions called "Tracks". A number is allotted to each partition and these numbers are called "title numbers", "chapter numbers" or "track numbers".

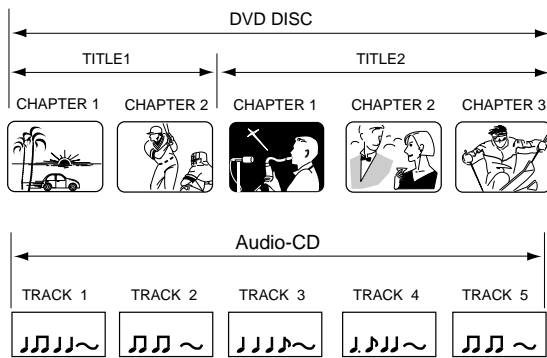

When recording in the VR mode

One-time recording is set to 1 title (1 chapter). However, if you stop recording temporarily or erase scenes by editing, the chapter will automatically be partitioned. The interval between chapters can be specified. (See page 31.)

When recording in the Video mode

One-time recording is set to 1 title. In recording, chapters are set automatically. The interval between chapters can be specified. (See page 31.)

NOTES:

- The title, chapter and track are numbered, but some discs may not record the numbers.
- Recording on DVD-R/RW in the Video mode is a new standard approved at the 2000 DVD forum. Conformity to this standard varies with each DVD player manufacturer. Some models of DVD player or DVD-ROM drive, therefore, will not playback recorded videos.

Disc playback in other players

DVD-RW/R recorded in this unit can be finalized. The disc can be played back in other players that can playback DVD-RW and DVD-R.

For more information on finalization, see "FINALIZE" in "Setting the disc" (page 27).

When recording in the VR mode

Even if a DVD-RW disc recorded in the VR mode is finalized, you can record or edit by cancelling the finalization. (See "UNDO FINALIZE" on page 28.)

When you playback the disc with another player, make sure that the DVD player supports DVD-RW.

When recording in the Video mode

When a disc recorded in the Video mode is finalized, it cannot be recorded onto any more. Therefore, before finalization, be sure to perform all desired recording. After finalization, a title list that can be used by the DVD player is automatically created.

NOTES:

- The finalization process may require from a few minutes up to 1 hour depending on the disc type and the amount of free space on the disc.
- A DVD-RW Ver.1.1/1.2 recorded in the Video mode cannot be recorded or edited after finalization, but if you format the disc by erasing all the content, you can again record on this disc.
- A finalized disc may not play because of the condition of the DVD or the compatibility with the player used for playback.
- Some players may not playback the discs recorded with this unit. We cannot guarantee the playback using other players.

On Video CDs

This DVD supports Video CDs equipped with the PBC (Version 2.0) function. (PBC is the abbreviation of Playback Control.) You can enjoy two playback variations depending on types of discs.

• Video CD not equipped with PBC function (Version 1.1)

Sound and movie can be played on this DVD in the same way as an audio CD.

• Video CD equipped with PBC function (Version 2.0)

In addition to operation of a Video CD not equipped with the PBC function, you can enjoy playback of interactive software with search function by using the menu displayed on the TV screen (Menu Playback). Some of the functions described in this owner's manual may not work with some discs.

- Toshiba is not liable for any damage or loss caused directly or indirectly by the malfunction of this DVD/VCR, including, without limitation, any one of the following:
- Failure to record contents intended to be recorded by the consumer.
- Failure to edit contents as intended by the consumer.
- When a DVD-R disc created on this recorder is used (e.g., insertion, playback, recording or editing) in another DVD player, recorder or personal computer drive.
- When a DVD-R disc that is used in the manner described in the immediately preceding bullet point is used again in this recorder.
- When a DVD-R disc that was recorded in another DVD recorder, or in a personal computer drive is used in this recorder.
- Discs recorded in this recorder may not operate as expected on other DVD players, recorders or personal computer drives.



Parts and functions

Front

* This unit has a door on the front panel.

Please open it to access the S-VIDEO jack and the AUDIO (L/R)/VIDEO IN (INPUT 2) jacks.

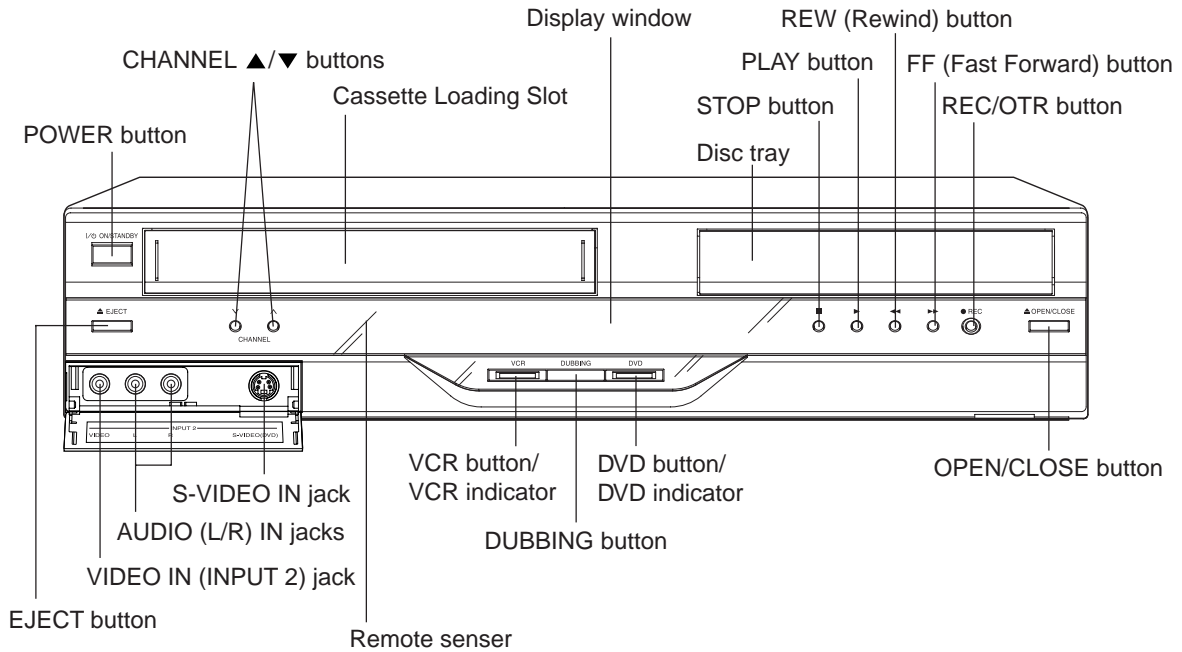

Rear

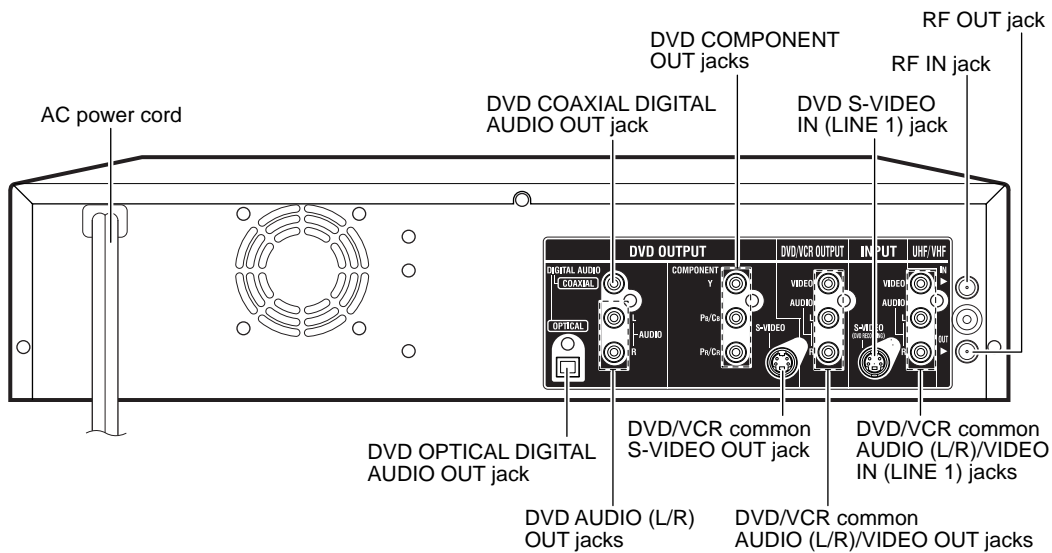



Parts and functions

Display window

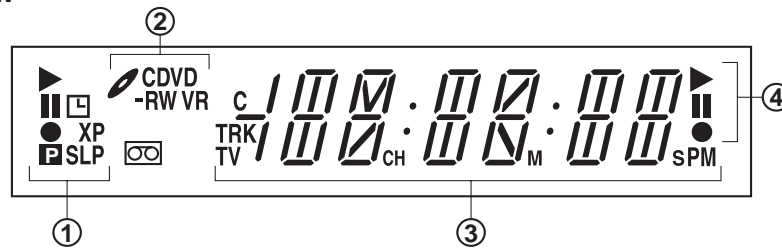

No.	Display	Description
①		Lights during video tape playback.
		Video tape is temporarily stopped.
		Lights during video tape recording.
		Progressive scanning mode.
		Timer recording display.
	XP/SP/LP/SLP	4 DVD recording modes. XP, SP, LP or SLP can be selected in turn by pressing the REC MODE/SPEED repeatedly.
	SP/SLP	2 VCR recording modes. SP or SLP can be selected in turn by pressing the REC MODE/SPEED repeatedly.
②		Appears when a CD is inserted.
		Appears when a CD-R is inserted.
		Appears when a CD-RW is inserted.
		Appears when a DVD-Video is inserted.
		Appears when a DVD-R is inserted.
		Appears when a DVD-RW is inserted.
	VR	Appears when a DVD-RW in VR mode is inserted. When the disc is set to video mode, VR does not appear.
		Video tape is in the unit.
③	10:00	Clock display (Colon [:] flashes).
	01h00m00s	Counter display in hour/minute/second for VCR/DVD, minute/second for CD.
	C 36CH	Cable TV channel display.
	2CH	TV channel display.
	TRK 002	Track number display for CD.
	TV	Appears when the tuner built into this unit is not selected. When you press TV/VIDEO disappears.
	PM	Display for afternoon (out in the morning).
	L1/L2	The external input channel (L1 or L2) display.
	Err	Error display.
④		Lights during playback of DVD and CD. Flashes in auto resume.
		DVD or CD is temporarily stopped.
		Lights during DVD recording.

NOTE:

Some discs may not playback correctly, or chapter number, playback time, etc may not be displayed.

Parts and functions

Remote control

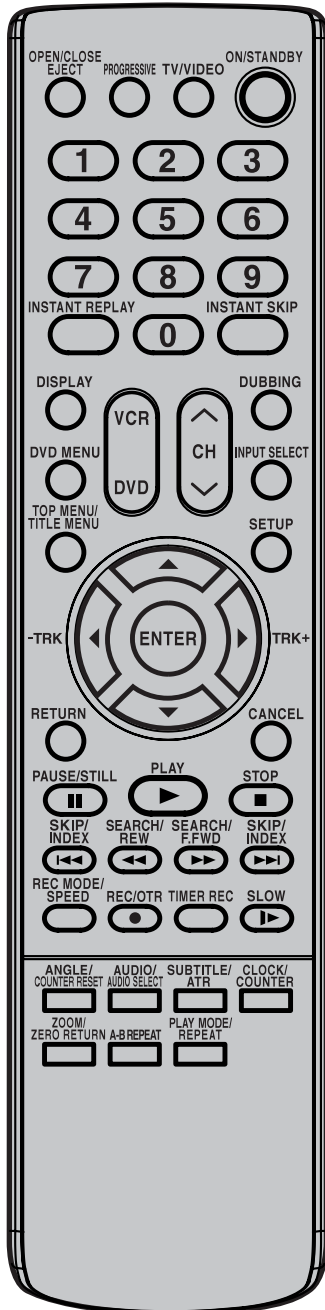

		Page
OPEN/CLOSE	Opens or Closes the tray.	33
EJECT	Ejects the cassette tapes	48
PROGRESSIVE	Activates the progressive scanning mode.	47
TV/VIDEO	Select to operate TV/VIDEO	22, 55
ON/STANDBY	Turns power on/off.	22
0-9	Direct channel selection of TV	54
	Setting input	37, 73
	Entering a password	25
INSTANT REPLAY	Repeats playback between the section played 10 seconds before and present section.	38
INSTANT SKIP	Skips commercial breaks.	37, 50
DISPLAY	Displays VCR or DVD operation status.	35, 51
DVD	Switches to operation between VCR and DVD.	33, 49, 76, 77
VCR		
CH ^/v	Channel selection for the connected TV or VCR	54
DUBBING	Copies VCR to DVD or DVD to VCR.	76
DVD MENU	Displays the menu of the DVD disc.	39
INPUT SELECT	Switches the connected TV to external inputs.	78
TOP MENU/TITLE MENU	Selects titles of a DVD disc.	34, 39, 42, 62
SETUP	Display the setup menu	23, 57
▲ / ▼	Cursor buttons	23, 33, 37, 57
TRK +/-	Manual tracking in the playback mode for VCR	50
◀ / ▶	Cursor buttons	33, 37
ENTER	Option selection in the menu	23, 33, 37, 57
RETURN	Close the menu window.	23, 45
CANCEL	Deletes the Timer recording program. Cancels input data in the setting mode.	59 25
PAUSE/STILL	Still picture/Recording pause on/off	36, 50
PLAY	Playback	33, 49
STOP	Stop	33, 49, 55
SKIP ◀▶	Skips chapters in the forward or reverse direction	36
INDEX -◀ / ▶+	Searches for the INDEX mark of a tape	51
SEARCH ◀◀/REW	Rewind/Review playback	36, 49, 50
SEARCH ▶▶/F.FWD	Fast Forward/Forward search playback	36, 49, 50
REC MODE/SPEED	Selects the recording mode.	54, 56
REC/OTR	Recording	54, 56, 78
TIMER REC	Sets the unit to start recording at a preset time.	59
SLOW	Slow motion playback	36, 50
ANGLE	Changes playback angle.	40
COUNTER RESET	Resets the counter to 00H 00M 00S .	51
AUDIO	Switches sound between mono and stereo.	60
AUDIO SELECT	Changes the language of the DVD.	41
SUBTITLE	Selects subtitles of the DVD disc.	41
ATR	Digital AUTO TRACKING	50
CLOCK/COUNTER	Changes the front panel display mode.	51
ZOOM	Zoom (for DVD/Video CD)	40
ZERO RETURN	Stops the tape when the counter reaches 00H 00M 00S .	51
A-B REPEAT	Repeats playback between A and B.	38
PLAY MODE	Selects the playback mode.	37
REPEAT	Repeats playback.	38, 50



Parts and functions

Inserting Batteries into the Remote Control:

- 1** Open the battery compartment cover in the direction of the arrow.

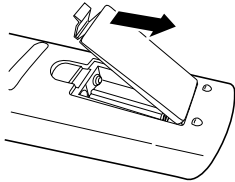

- 2** Install two "AAA" batteries, paying attention to the polarity diagram in the battery compartment.

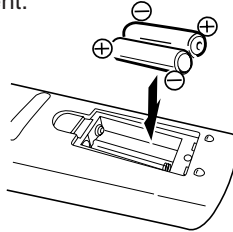

- 3** Replace the compartment cover.

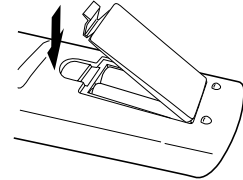

Caution:

Never throw batteries into a fire.

Note:

- Be sure to use AAA size batteries.
- Dispose of batteries in a designated disposal area.
- Batteries should always be disposed of with the environment in mind. Always dispose of batteries in accordance with applicable laws and regulations.
- If the remote control does not operate correctly, or if the operating range becomes reduced, replace batteries with new ones.
- When necessary to replace batteries in the remote control, always replace both batteries with new ones. Never mix battery types or use new and used batteries in combination.
- Always remove batteries from remote control if they are dead or if the remote control is not to be used for an extended period of time. This will prevent battery acid from leaking into the battery compartment.

Remote control basics

- Press **ON/STANDBY** to turn the DVD/VCR on or off.
- Press **CH ^** or **CH v** to move through the channels one channel at a time.
- The **▲/▼/◀/▶** are also used to navigate on-screen menu system.
- You can directly access specific channels using **numeric keys**.
- Each press of **DVD** or **VCR**, switches the screen between the DVD screen (DVD mode) and the VCR screen (VCR mode).

Operation

- Aim the remote control at the remote sensor and press control buttons to operate.
- Operate the remote control within 30° angle on either side of the remote sensor, up to a distance of approximately 7 meters (23 feet).

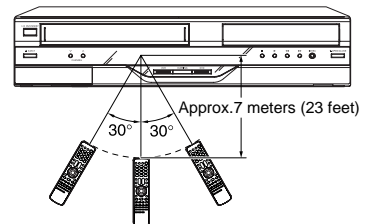

Power Source

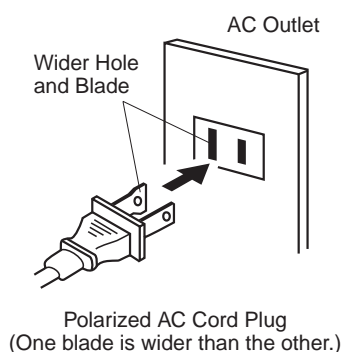

TO USE AC POWER SOURCE

Use the AC polarized line cord provided for operation on AC. Insert the AC cord plug into a standard 120V 60Hz polarized AC outlet.

NOTES:

- Never connect the AC line cord plug to other than the specified voltage (120V 60Hz). Use the attached power cord only.
- If the polarized AC cord does not fit into a non-polarized AC outlet, do not attempt to file or cut the blade. It is the user's responsibility to have an electrician replace the obsolete outlet.
- If you cause a static discharge when touching the unit and the unit fails to function, simply unplug the unit from the AC outlet and plug it back in. The unit should return to normal operation.
- If the AC cord plug is plugged in for the first time, wait for approximate 3 minutes before operating the unit.

Antenna connections

If you are using an antenna system, follow these instructions. If you are a Cable TV subscriber, skip ahead to page 18 for the proper connections.

ANTENNA TO DVD/VCR CONNECTION

The DVD/VCR must be connected "between" the antenna and the TV. First, disconnect the antenna from the TV and connect it to the DVD/VCR. Then connect the DVD/VCR to the TV. Below are 3 common methods of connecting an antenna system to a DVD/VCR. Find the type of antenna system you are using and follow the connection diagram.

1

Combination UHF/VHF antenna with 75 ohm coaxial cable

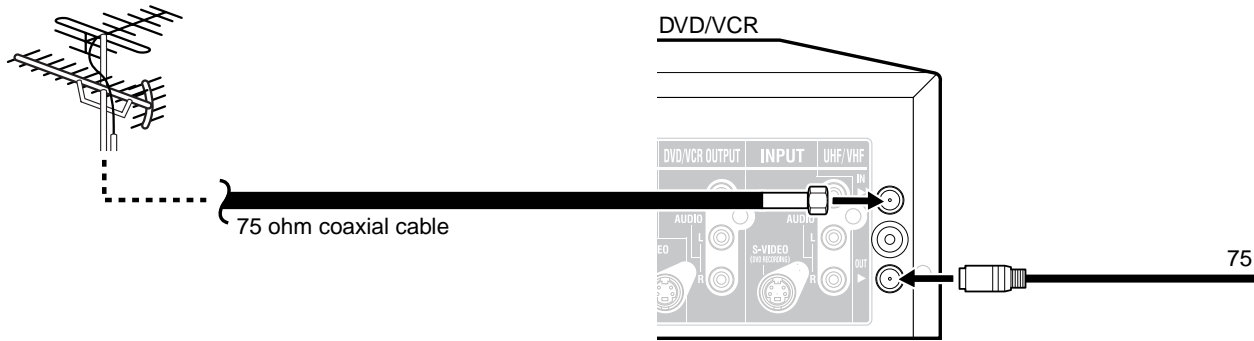

2

Combination UHF/VHF antenna with 300 ohm twin lead (flat) wire

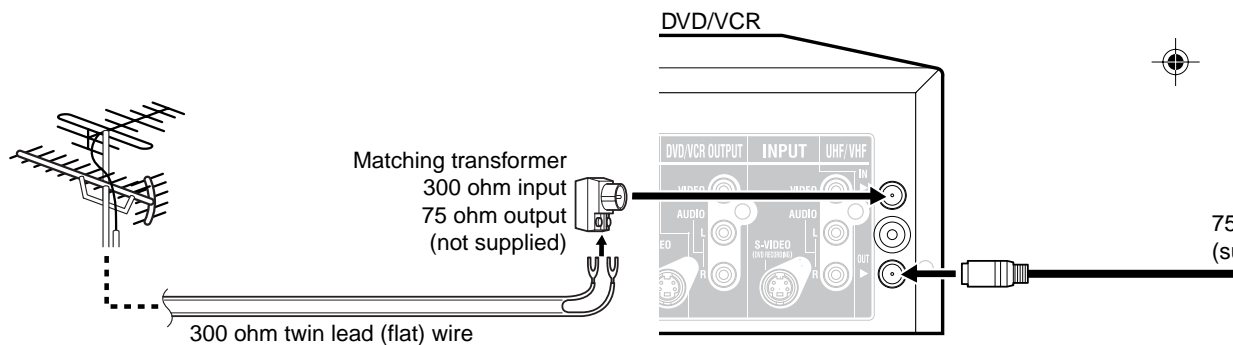

3

Separate UHF and VHF antennas

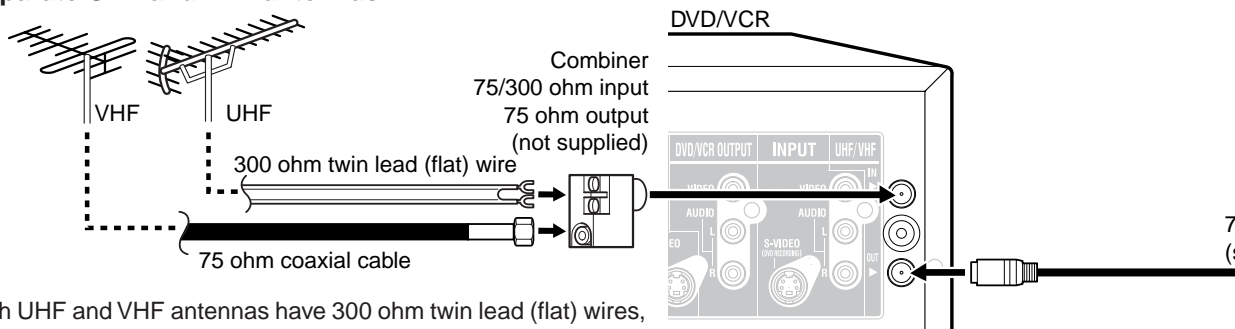

NOTE: If both UHF and VHF antennas have 300 ohm twin lead (flat) wires, use a combiner having two 300 ohm inputs and one 75 ohm output.

- NOTES:**
- A clear picture will not be obtained by the DVD/VCR unless the antenna signal is good. Connect the antenna to the DVD/VCR properly.
 - For better quality recording, an indoor antenna or a telescopic antenna is not recommended. The use of an outdoor type antenna is required.
 - If you are not sure about the connection, please refer to qualified service personnel.



Antenna connections

DVD/VCR TO TV CONNECTION

After you have connected the antenna to the DVD/VCR, you must connect the DVD/VCR to the TV. Below are 3 common methods of connecting your DVD/VCR to a TV. Find the type of TV you are using and follow the connection diagram.

This DVD/VCR has a single 75 ohm output for connection to a TV. If your TV has separate UHF and VHF antenna inputs (numbers 2 and 3 below), use a splitter to connect the DVD/VCR to the TV for UHF and VHF reception.

Introduction

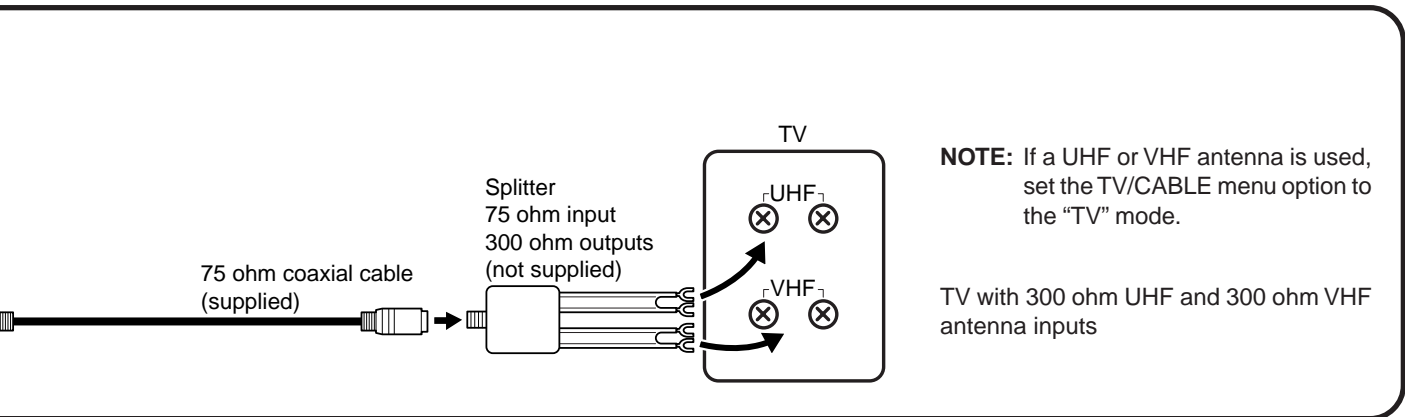
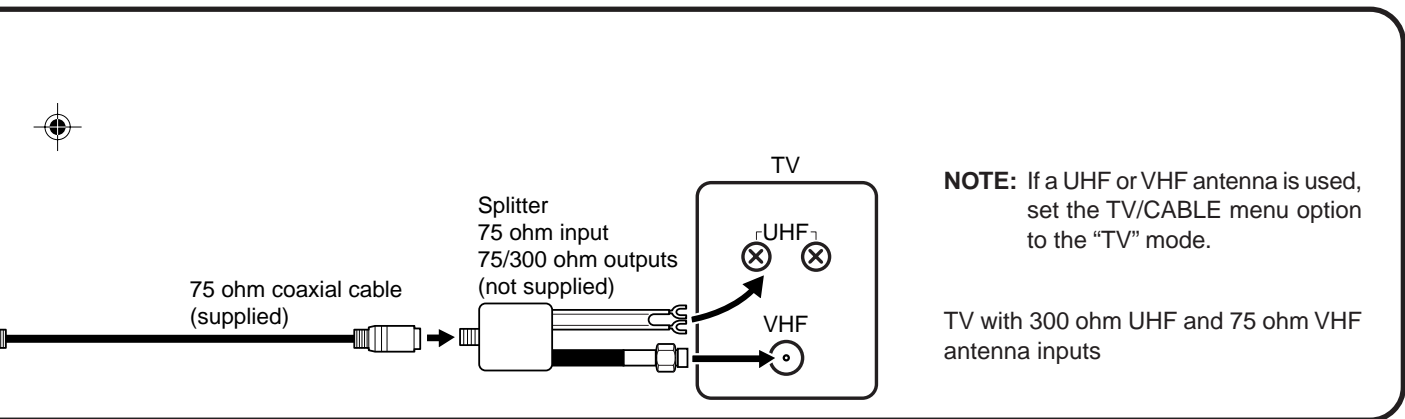
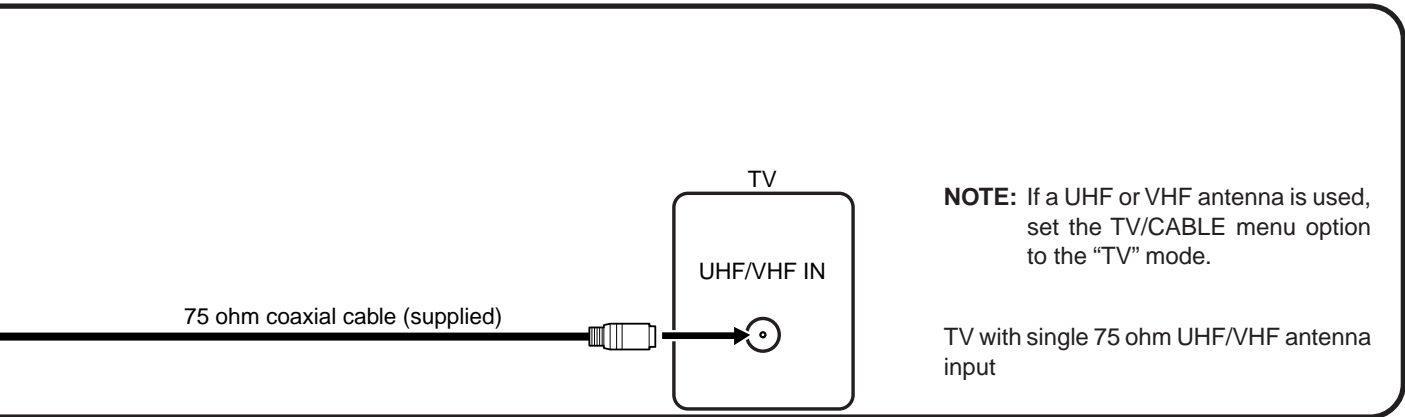

The unauthorized recording, use, distribution, or revision of television programs, videotapes, DVDs and other materials, is prohibited under the Copyright Laws of the United States and other countries, and may subject you to civil and/or criminal liability.



Cable TV connections

Many cable companies offer services permitting reception of extra channels including pay or subscription channels. This DVD/VCR has an extended tuning range and can be tuned to most cable channels without using a cable company supplied converter box, except for those channels which are intentionally scrambled. If you subscribe to a special channel which is scrambled, you must have a descrambler box for proper reception.

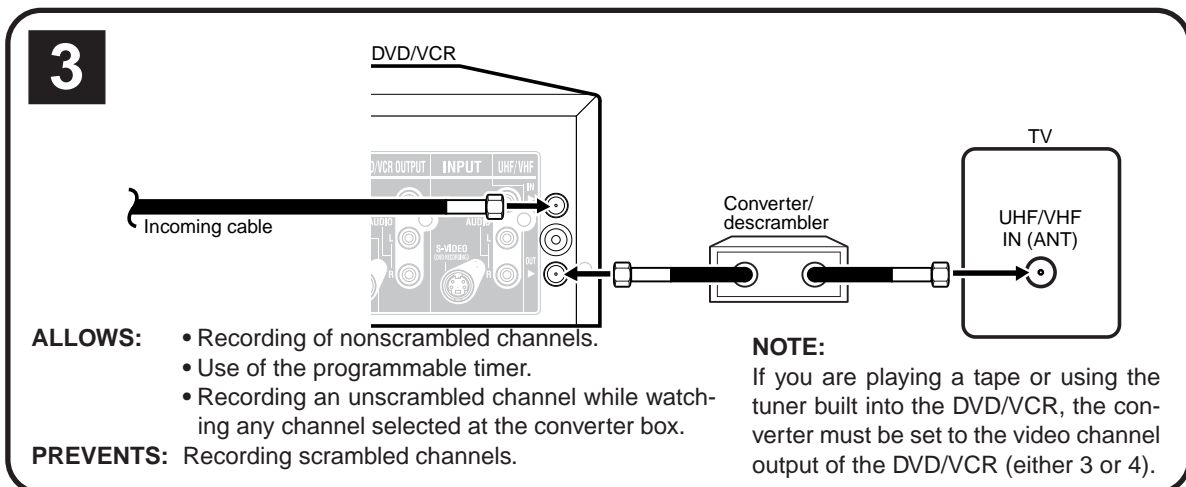
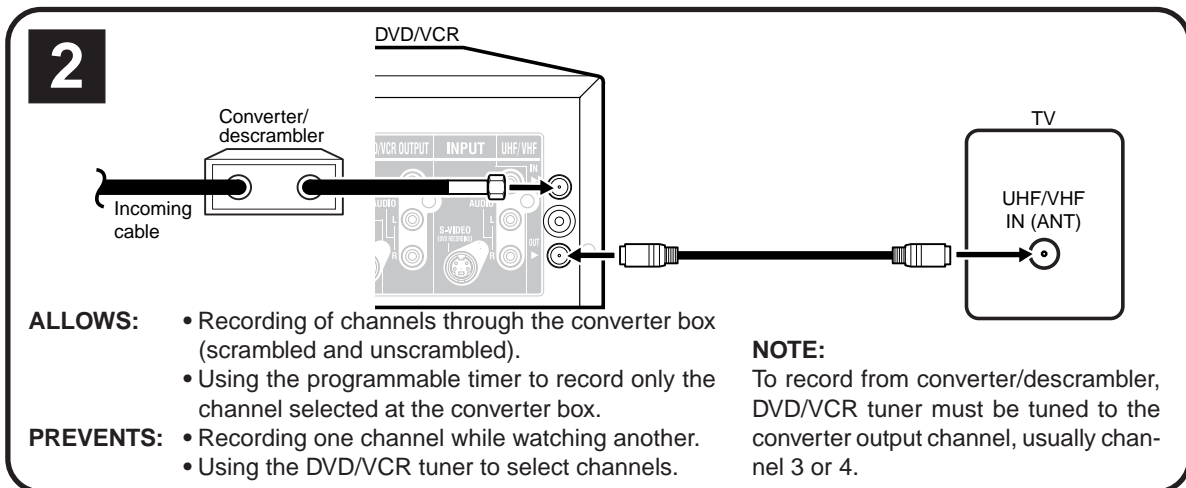
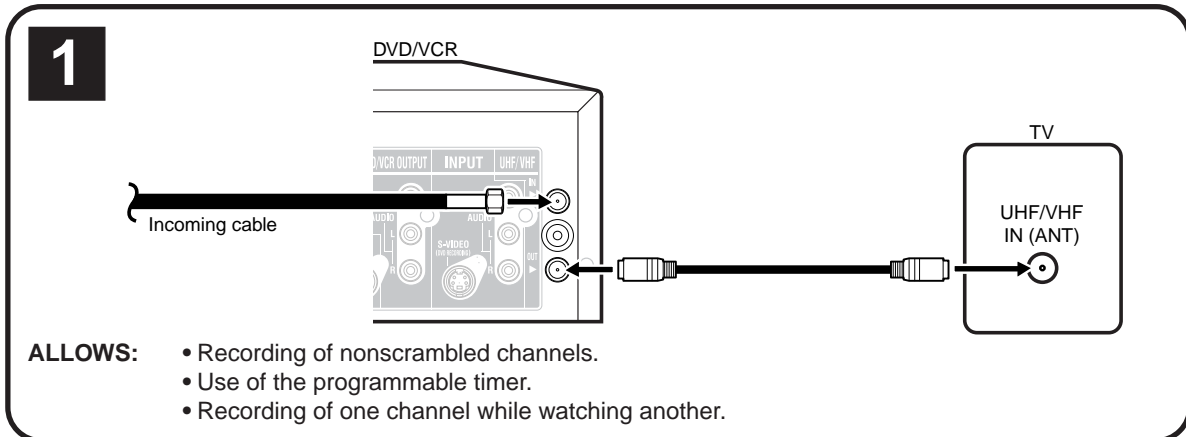

NOTE: Whenever a converter/descrambler box is placed before the DVD/VCR, you must tune the DVD/VCR to the output of the converter/descrambler box, usually channel 3 or 4.

Cable TV connections

IMPORTANT: Make sure the TV/CABLE menu option is set to the "CABLE" mode.

This DVD/VCR cannot receive scrambled programs since it does not contain a descrambler. In order to receive scrambled programs, your existing descrambler must be used. Descrambler boxes are available from cable companies. Consult your local cable company for more information concerning connection to their descrambler equipment. There are many ways to connect your DVD/VCR to a cable system. Below are six common methods of connection.

Introduction

4

ALLOWS:

- Recording of one channel while watching another.
- Using the programmable timer to record only the channel selected at the converter box.
- Recording of all channels through the converter box.

PREVENTS:

- Watching scrambled channels while recording another channel.
- Using the DVD/VCR tuner to select channels.

5

ALLOWS:

- Recording of nonscrambled channels.
- Recording of one channel while watching another.
- Watching premium channels through the converter while recording nonscrambled channels.
- Using the programmable timer.

PREVENTS: Recording scrambled channels.

6

ALLOWS:

- Recording of all channels through the converter box.
- Recording a scrambled or unscrambled channel while watching another (scrambled or unscrambled) channel.
- Using the programmable timer to record only the channel selected at the converter box.

PREVENTS: Using the DVD/VCR tuner to select channels.

The unauthorized recording, use, distribution, or revision of television programs, videotapes, DVDs and other materials, is prohibited under the Copyright Laws of the United States and other countries, and may subject you to civil and/or criminal liability.

Connections with the TV or audio component

The exact arrangement you use to interconnect various video and audio components to the DVD/VCR is dependent on the model and features of each component. Check the Owner's Manual provided with each component for the location of video and audio inputs and outputs.

The unauthorized recording, use, distribution, or revision of television programs, videotapes, DVDs and other materials, is prohibited under the Copyright Laws of the United States and other countries, and may subject you to civil and/or criminal liability.

Connect to a TV with Audio/Video output

You can enjoy playback by connecting the unit to a TV.

Connect the unit to a TV equipped with audio input (L/R) and video input jacks using the supplied audio/video cable.

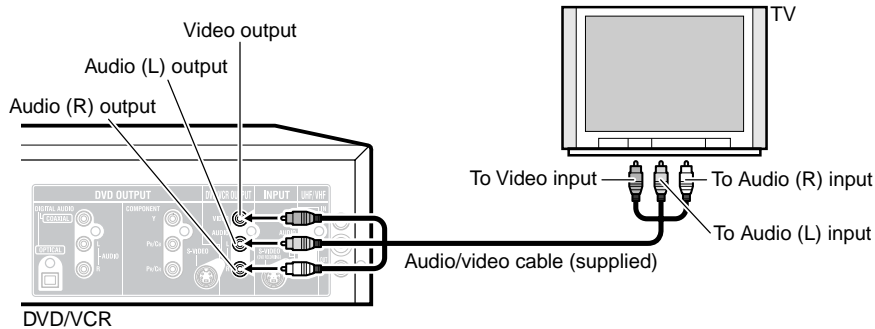

Connect to a TV with S-Video output

If your TV has an S-Video input, you can get higher quality by connecting it with the S-Video output of the unit using the S-Video cable instead of connecting the video input of the TV to the video output jack of the unit.

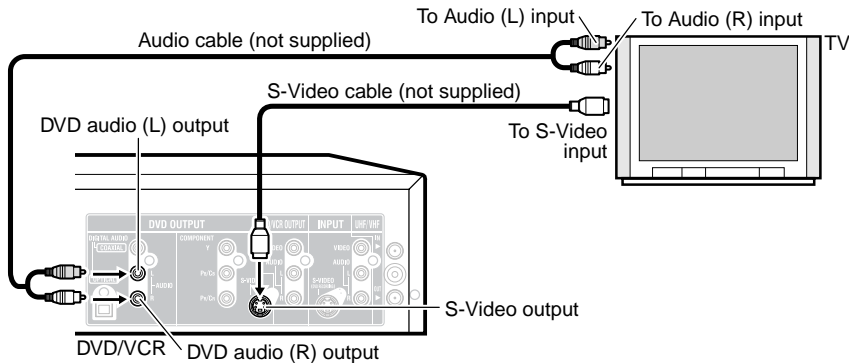

Connect to a TV with Component video output (for DVD/CD playback)

You can enjoy the highest quality picture by connecting the unit's component video out jacks to the component video input jacks of your TV, with component video cables (not supplied).

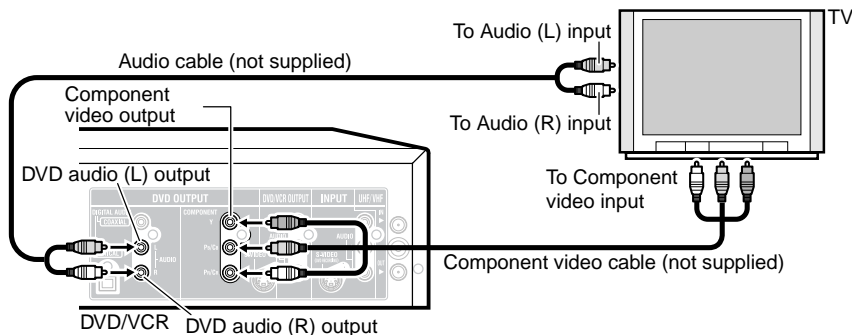

NOTES:

- When connecting to a TV using the video or S-Video jack, make sure that the progressive indicator on the display window is not lit. If it is lit, the video and S-Video outputs do not feed the correct signals and you cannot see any picture. To turn off the progressive indicator, make the progressive scanning mode inactive (see page 47).
- If the component video input jacks on a TV are the BNC type, use an adapter to convert the RCA jacks from the component video cables to BNC (not supplied).



Connections with the TV or audio component

Connect to a stereo amplifier with audio output

You can enjoy high quality audio by connecting the audio output to your amplifier.

Connect the audio output jacks to any line-level inputs (such as AUX, DVD, CD, etc.) of an audio amplifier.

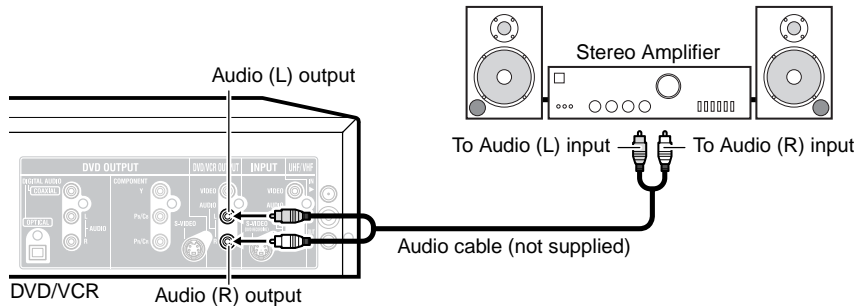

Connect to an AV Amplifier with built-in digital surround

If you are using an Amplifier with a built-in digital surround as follows, you can enjoy the various audio systems such as Dolby Digital and DTS by using the optical or coaxial digital output.

Use this connection to connect an:

- AV amplifier with built-in *Dolby Digital decoder
- AV amplifier with built-in *DTS decoder

NOTE:

You may connect to a TV with a component video cable (not supplied) or S-Video cable (not supplied) instead of a video cable (not supplied).

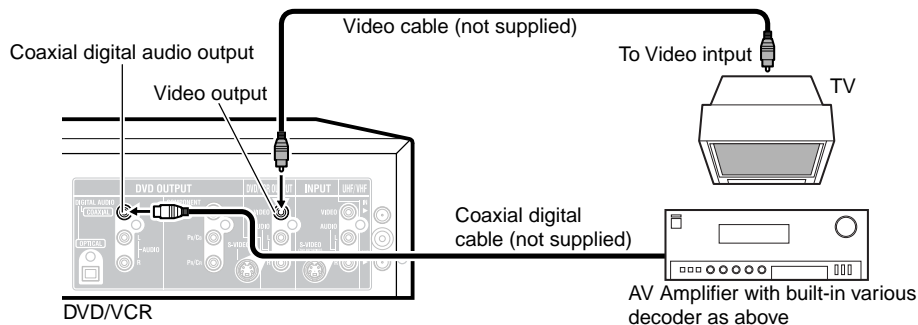

Connecting the optical digital cable

You may connect to an AV Amplifier with an optical digital cable (not supplied) instead of a coaxial digital cable.

When you connect the optical digital cable (not supplied), remove the dust protection cap from the rear panel.

When not using the optical digital cable, attach the dust protection cap to protect against dust.

NOTES:

- The DVD OUTPUT jacks (OPTICAL, COAXIAL, AUDIO L/R and COMPONENT) are useful only for DVD section. The VHS signal is output only from the S-Video output jack, composite jacks (DVD/VCR OUTPUT) and UHF/VHF OUT.
- When you make the connections above, do not set DOLBY DIGITAL to DOLBY DIGITAL or DTS to ON on the AV amplifier. If you do, a loud noise will suddenly come out from the speakers, affecting your ears or causing the speakers to be damaged.
- Caution for the optical digital audio output connector: Do not connect to an amplifier (with an optical digital input connector) which does not contain a Dolby Digital or DTS decoder. Otherwise, any attempt to play DVDs may cause such a high level of noise that it may be harmful to your ears and damage your speakers.
- DTS audio will be output only from the COAXIAL or OPTICAL output. To hear DTS audio, DTS-Decoder is necessary.
- When playing DTS-encoded CDs, only noise will be heard from the speakers or analog stereo outputs.
- Some DTS decoders which do not support DVD-DTS interface may not work properly with the unit.
- The optical or coaxial digital output jack output sounds in the bitstream.

Auto clock setting / Setting the video channel

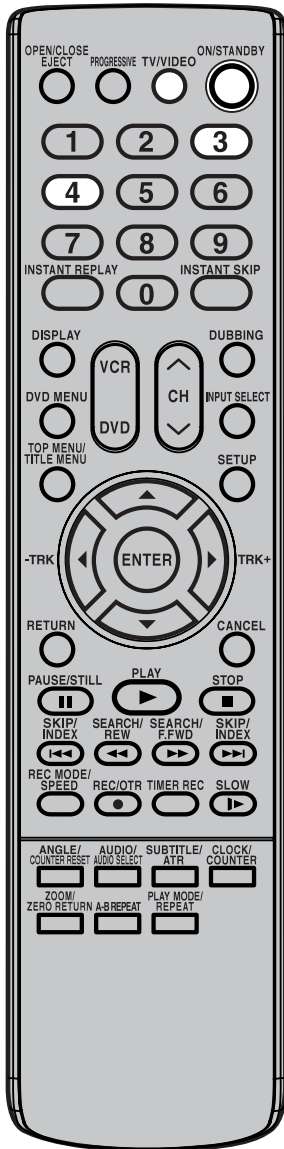

NOTES:

- When shipped from factory, the video channel is set to CH 3.
- If the unit does not operate properly, or there is no key operation from the unit and/or the remote control: Static electricity, etc., may affect the operation. Disconnect the AC power cord once, then connect it again.

Auto clock setting

Preparation:

You must connect the antenna or cable before connecting the AC cord to the power source.

Wait at least 3 minutes with the power turned off, after the antenna or cable is connected, for the auto clock feature to activate.

After the clock is set automatically, you may have to set the time zone and daylight saving time. (See page 26.)

Press **ON/STANDBY** to turn on the DVD/VCR after the auto clock operation completed.

- When shipped from factory, the "AUTO CLOCK" option is set to "ON" position.
- If you turn the DVD/VCR on during auto clock setting, the clock is not set.
- Depending on the reception condition, auto clock setting may take approx. 30 minutes.
- After a power failure or disconnection of the power plug, the clock will be lost. In this case, wait 3 minutes before turning the DVD/VCR on.
- With cable box connection, if the auto clock setting is unsuccessful, select the PBS channel carrying the XDS information, then turn the DVD/VCR off. After 3 minutes, turn the DVD/VCR on.
- If the clock is not set automatically, set the clock manually. (See page 26.)

Setting the video channel

To view playback of a recorded tape or DVD disc, or to watch a program selected by the VCR's channel selector, the TV must be set to channel 3 or 4 (video channel).

When a TV is connected with the 75 ohm coaxial cable only:

- 1 Press and hold **3** or **4** on the remote control for 3 seconds in the **standby mode** to select CH **3** or **4**. The selected channel number will flash on the display for about 4 seconds.
- 2 Turn **ON** the TV and set to CH **3** or **4** to correspond with the channel selected in step 1.
- 3 Press **ON/STANDBY** to turn on the DVD/VCR.
- 4 Press **TV/VIDEO** to select the VIDEO position. The TV indicator will disappear in the display.
- 5 Select any channel to receive a TV station in your area. The channel number will appear on the screen for about 4 seconds.

For a push-button TV tuner

If CH **3** or **4** corresponding to the video channel cannot be tuned on your TV, proceed as follows: set the VCR 3/4 channel selector and the TV to CH **3** or **4**, playback a prerecorded tape and tune the TV to receive a sharp color picture from the video cassette recorder. Refer to your TV owner's manual for details.

SETUP MENU

The **SETUP MENU** consists of several menus where you can make various settings concerning language, audio functions, and images. In addition, this menu includes a clock, channel and other things that require setting just after purchase.

For details of each menu, see the corresponding section in this chapter.

Using the SETUP MENU

The following example shows the basic setting procedure of the SETUP MENU. The remote control keys that operate the SETUP MENU are displayed at the bottom of the screen.

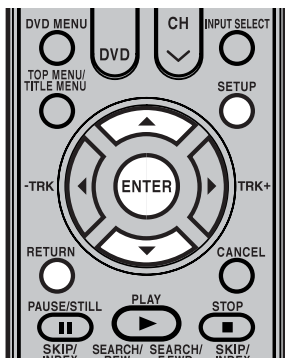

- 1 Press **SETUP** while the DVD or video tape is stopped. The **SETUP MENU** screen will appear.

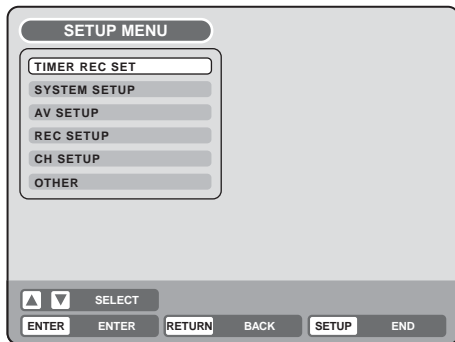

- 2 Press **▲** or **▼** to select the desired menu and press **ENTER**. The submenu screen of the selected menu will appear.

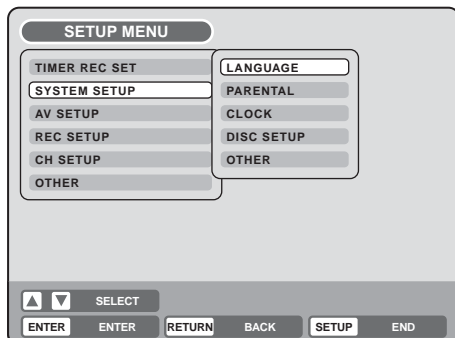

- 3 Press **▲** or **▼** to select the desired submenu and press **ENTER**. The screen for the selected submenu will appear.

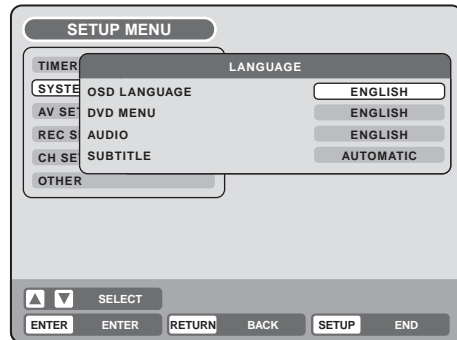

- 4 Press **▲** or **▼** to select the desired item you want, and press **ENTER**. Selectable items will be listed.

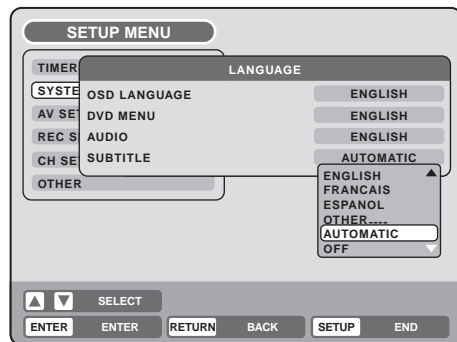

- 5 Press **▲** or **▼** to select the desired item and press **ENTER**. This completes the setting procedure.
 - To return to the previous screen, press **RETURN**.
 - To close the **SETUP MENU**, press **SETUP**.

NOTES:

- For items that require different operations from the basic setting procedure, the setting procedure is described in each individual section.
- The item which is indicated by blue color cannot be selected.

Various settings

Setting the language

You can choose the language of the menu screen, DVD menu, DVD audio and subtitles.

Preparation:

- Turn ON the TV and set it to the video input mode.
- Select “LANGUAGE” from “SYSTEM SETUP”. For the procedure, see steps 1 to 3 in “Using the SETUP MENU” on page 23.

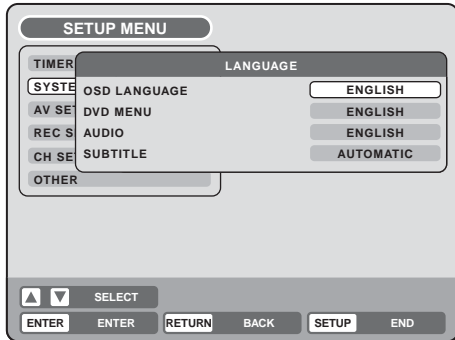

OSD LANGUAGE

You can set the language for on screen display. Select “OSD LANGUAGE” and select the language from the below.

Selectable languages:

ENGLISH, FRANCAIS, ESPANOL

DVD MENU

When several menu languages are recorded on a DVD, you can select the language to be used for the DVD menu.

Select “DVD MENU” and select the language from the below.

Selectable languages:

ENGLISH, FRANCAIS, ESPANOL

The selected language is the first priority menu language.

OTHER

If you want to select another language, before pressing **ENTER**, input the language code by using the **numeric keys**. (See the Language code list on page 81). Then press **ENTER**.

- If you input a wrong number, press **CANCEL**.

AUDIO

When several audio languages are recorded on a DVD, you can select the audio language to be played back. The selected language remains in effect after the power is turned off or the disc is replaced.

Select “AUDIO” and select the audio language from the below.

Selectable languages:

ENGLISH, FRANCAIS, ESPANOL

The language you have selected will play if it is recorded on the disc.

ORIGINAL

The unit will select the first priority language of each disc.

OTHER

If you want to select another language, before pressing **ENTER**, input the language code by using the **numeric keys**. (See the Language code list on page 81). Then press **ENTER**.

- If you input a wrong number, press **CANCEL**.

NOTE:

If the selected language is not recorded on the disc, the first-priority language is selected.

SUBTITLE

When several subtitles languages are recorded on DVD, you can select the language to be used for the subtitles. The selected language remains in effect after the power is turned off or the disc is replaced.

Select “SUBTITLE” and select the menu language from the below.

Selectable languages:

ENGLISH, FRANCAIS, ESPANOL

The subtitle is displayed with the selected language if it is recorded on the disc.

OTHER

If you want to select another language, before pressing **ENTER**, input the language code by using the **numeric keys**. (See the Language code list on page 81). Then press **ENTER**.

- If you input a wrong number, press **CANCEL**.

AUTOMATIC

- The unit will automatically select the same language in the AUDIO setting.
- When the unit selects the same language as the AUDIO setting, the subtitles will not appear during playback.
- When you do not use the same language as the AUDIO setting, the subtitles will appear during playback.

OFF

Subtitles do not appear.

NOTE:

If the selected language is not recorded on the disc, the first-priority language is selected.



Setting the parental control

Some discs are specified as not suitable for children. This unit can prevent playback of such discs.

Preparation:

- Turn ON the TV and set it to the video input mode.
- Select "PARENTAL" from "SYSTEM SETUP". For the procedure, see steps 1 to 3 in "Using the SETUP MENU" on page 23.

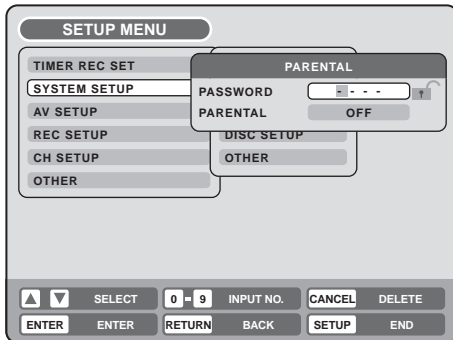

Selecting parental control

Select "PARENTAL" and select the parental control level from the below.

- Level Off:** Parental control is turned off.
- Level 1:** Adult discs and general discs (R-rated discs included) cannot be played back.
- Level 2 to 3:** Adult discs and R-rated discs cannot be played back.
- Level 4 to 7:** Adult discs cannot be played back. (Level 4 to 7 discs contain content children age 15 and younger may not see.)
- Level 8:** All discs can be played back without restriction.

Select from level 1 to level 8. On a scale of 1- 8, "1" is the most restrictive.

To lock the selected parental control level

- 1 To lock the selected parental control level, press ▲ or ▼ to select "PASSWORD".
- 2 Use the **numeric keys** to input a 4-digit password.
 - If you input a wrong number, press **CANCEL**.
 - Be sure to remember this number!
- 3 Press **ENTER**.

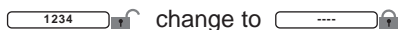

To cancel the locked parental control level

- 1 Select "PASSWORD" shown in step 1 of the above section and use the **numeric keys** to input the password.
- 2 Press **ENTER**. The locked mark "🔒" will change to an unlocked mark "🔓". Then, you can change the parental control level, or enter a new password.

NOTES:

- The selected level will apply to operations executed after this.
- The unit cannot restrict playback of some discs.
- Some discs may not be encoded with specific rating level information though its disc jacket says "adult". Parental control will not work with those discs.
- If you forget your password, open the disc tray; if there is a disc inside then remove it and close the tray. To reset the code press and hold **number 7** on the remote control, then press and hold **STOP** on the front panel at the same time. The On-Screen Display will show "PARENTAL UNLOCK". You can now set a new password.

Temporarily cancelling parental control

Parental control can temporarily be cancelled with some DVDs.

- 1 Playback a DVD. (See page 33.)
- 2 If the DVD disc has been designed to temporarily cancel the rating level, the screen that follows the "READING" screen will change. If you select "YES" with the **ENTER**, the message "YOUR DISC EXCEEDS THE PARENTAL CONTROL LEVEL 1." (e.g.) will then appear.

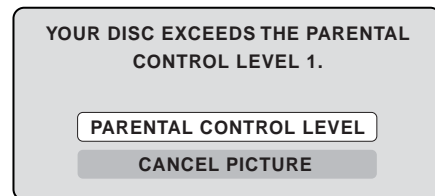

- 3 If you wish to cancel the set rating level temporarily, select "PARENTAL CONTROL LEVEL" with ▲ or ▼, then press **ENTER**. If the password has been selected, the password input screen will appear. Alternatively, if the password has not been set, playback will commence. If you don't know (or have forgotten) the password, select "CANCEL PICTURE". The setting screen will disappear. Press **OPEN/CLOSE** to remove the disc.

- 4 Use the **numeric keys** to input the password.
 - To interrupt the input process, press **RETURN**.

- 5 Press **ENTER**.

- 6 Playback will commence if the entered password was correct.

NOTE:

This temporary cancellation of the rating level will remain active until the disc is ejected. When the disc is ejected, the original rating level will be set again automatically.

Various settings

Setting the clock

The clock is set to the correct time automatically, but it can also be set manually. The clock can be set for daylight saving time and time zone.

Preparation:

- Turn ON the TV and set it to the video input mode.
- Select "CLOCK" from "SYSTEM SETUP". For the procedure, see steps 1 to 3 in "Using the SETUP MENU" on page 23.

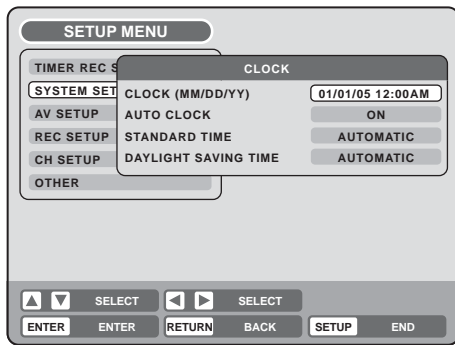

CLOCK (manually)

You can manually set the date, year and present time with the remote control.

Ex.: Setting the clock to "10:20AM" March, 30th, 2005.

- 1 Select "CLOCK" and press **ENTER**.
01/01/05 12:00AM
- 2 Select the desired items using ◀ or ▶ (month, date, year, hour, minute and AM/PM), then press **ENTER**.
- 3 Press ▲ or ▼ to set the value of the selected item.
03/30/05 10:20AM
- 4 Repeat steps 2 and 3 to set the date, year and present time, and press **ENTER**. The SETUP MENU will close.
 This completes clock time setting.

AUTO CLOCK

You can automatically set the clock by turning "ON" the AUTO CLOCK function.

When you want to set the auto clock function to "OFF", select "AUTO CLOCK", press **ENTER** and select "OFF". For more information see page 22.

STANDARD TIME (Time zone)

In the rare event that you live within the broadcast range of two stations in two different time zones, the DVD/VCR may recognize the wrong station for the auto clock set. To correct the situation:

Select "STANDARD TIME" and select the time zone from the below.

Selectable time zones and correction times

- ATLANTIC:** GMT - 4 hours
(GMT: Greenwich Mean Time)
- EASTERN:** GMT - 5 hours
- CENTRAL:** GMT - 6 hours
- MOUNTAIN:** GMT - 7 hours
- PACIFIC:** GMT - 8 hours
- ALASKA:** GMT - 9 hours
- HAWAII:** GMT - 10 hours
- AUTOMATIC:** AUTO SET

NOTES:

- When shipped from the factory, the "STANDARD TIME" is set to "AUTOMATIC".
- After making the auto clock setting, in some cases the clock may display another time zone. You can correct the clock by selecting your time zone setting above.
- When the clock is not set or you set the clock manually, the time zone setting is not available.

DAYLIGHT SAVING TIME

You can set the clock to daylight saving time automatically or manually.

To select daylight saving time, select "DAYLIGHT SAVING TIME" and select "ON", while to cancel the daylight saving time, select "OFF".

- ON:** For manual setting (forward 1 hour)
- OFF:** For manual setting (back 1 hour)
- AUTOMATIC:** For automatic setting (read XDS in the signal)

NOTES:

- When you want to set daylight saving time, on the first Sunday in April you set it to "ON", and on the last Sunday in October you set it to "OFF".
- When shipped from the factory, the "DAYLIGHT SAVING TIME" option is set to "AUTOMATIC".
- When the clock is not set, the daylight saving time setting is not available.
- When there is no daylight saving time in your area, always select "OFF".

Setting the disc

You can format, protect, or finalize a disc.

Preparation:

- Turn ON the TV and set it to the video input mode.
- Select **"DISC SETUP"** from **"SYSTEM SETUP"**. For the procedure, see steps 1 to 3 in "Using the SETUP MENU" on page 23.

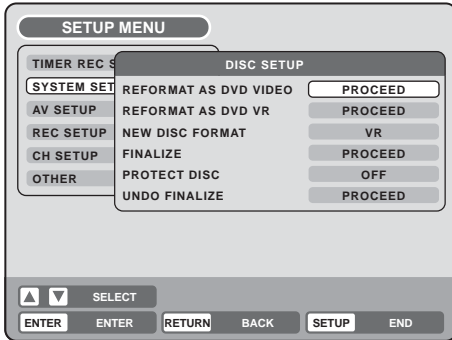

REFORMAT

You can format a recorded DVD-RW. Check the content of the disc before format. If you format the disc, the recorded content of the disc will be erased.

To format a disc in the Video mode, select "REFORMAT AS DVD VIDEO", and to format it in the VR mode, select "REFORMAT AS DVD VR". The screen below will appear.



- When you select "START" and press **ENTER**, format will start. The screen below will appear.

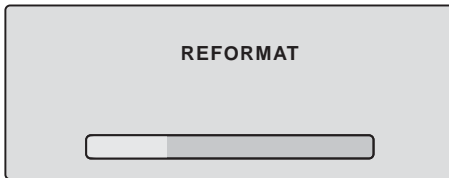

- When you select "CANCEL" and press **ENTER**, the DISC SETUP screen will appear.

NOTES:

- You cannot format Ver. 1.0 DVD-RW and DVD-R.
- You cannot format a disc if the disc protection is "ON". In such a case, be sure to cancel the disc protection (see page 28) before format.

NEW DISC FORMAT

If you insert an unused DVD-RW disc, the disc is automatically formatted.

If you use the DVD-RW (Ver.1.1/1.2), you can select the mode to be used for automatic format. Select "NEW DISC FORMAT" and select the mode from the list below.

- VR:** Format the disc in the VR mode.
- VIDEO:** Format the disc in the Video mode.

When you insert an unused disc, the following message screen will appear.

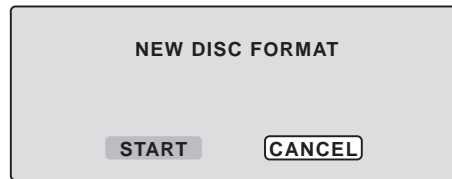

- When you select "START" and press **ENTER**, format will start. The screen below will appear.

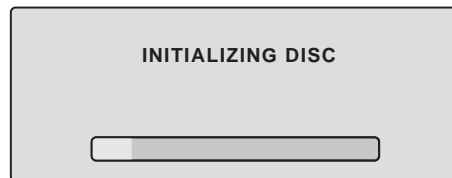

- When you select "CANCEL" and press **ENTER**, the normal TV screen will appear.

NOTE:

If a recorded disc has scratches or contamination on it, the "NEW DISC FORMAT" screen may appear. If this happens, select "CANCEL".

FINALIZE

To play a DVD disc recorded on this unit you must finalize the disc to insure compatibility with other DVD players. In addition if you are using a DVD-RW disc you must record in Video mode.

When "FINALIZE" is selected, the screen below will appear.

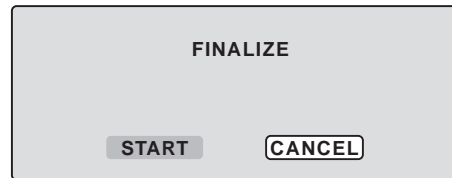

- When you select "START" and press **ENTER**, finalization will start. The screen below will appear.

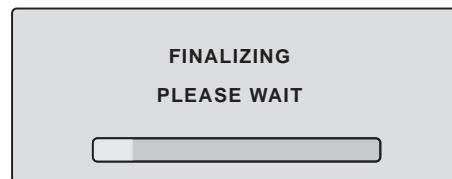

- When you select "CANCEL" and press **ENTER**, the DISC SETUP screen will appear.

Various settings

Setting the disc / Other (SYSTEM SETUP)

NOTES:

- During the finalization the cursor will move repeatedly. When the finalization finished, "DISC FINALIZED" will appear.
- The finalization process may require a few minutes to about 1 hour according to disc type or the amount of free space on the disc.
- You can record or edit a finalized DVD-RW (in VR mode) by cancelling the finalizing, but you cannot do these operations with a DVD-RW (Video mode), or with a DVD-R.
- You cannot playback a disc recorded on VR mode on a unit that does not support DVD-RW.
- Even if you finalize a disc in the Video mode, the disc cannot be played back in some DVD players.
- A DVD-R disc cannot be named after it is finalized.

PROTECT DISC

You can protect a disc to prevent the content recorded on it from being erased, edited or re-recorded. Only DVD-RW (in VR mode) can be protected. Select "PROTECT DISC" and select "ON" to protect the disc.

To cancel the disc protection, select "OFF".

UNDO FINALIZE

You can cancel the finalization of a finalized DVD-RW (in VR mode).

You cannot cancel the finalization for discs other than above. You can record or edit on a disc whose finalization has been cancelled.

Select "UNDO FINALIZE", and the screen below will appear.

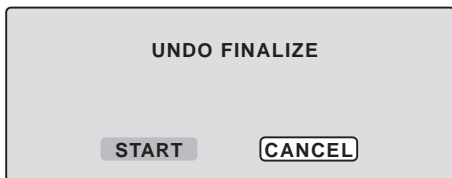

- When you select "START" and press **ENTER**, the cancelling finalization will start. The screen below will appear.

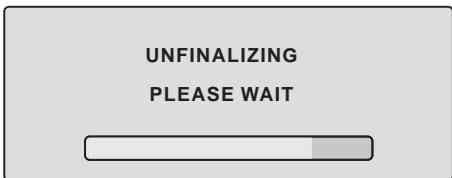

- When you select "CANCEL" and press **ENTER**, the DISC SETUP screen will appear.

NOTES:

- During the cancelling finalization the cursor will move repeatedly.
- The cancelling finalization process may require a few minutes to about 1 hour according to disc type or the amount of free space on the disc.
- When the disc's finalization cannot be cancelled, you cannot select "UNDO FINALIZE".

This section describes the other setting in SYSTEM SETUP

Preparation:

- Turn ON the TV and set it to the video input mode.
- Select "OTHER" from "SYSTEM SETUP". For the procedure, see steps 1 to 3 in "Using the SETUP MENU" on page 23.

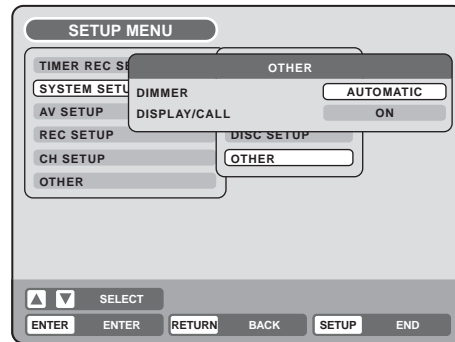

DIMMER (Brightness of the display window)

You may adjust the brightness or turn off the display on the front panel of the unit. Select "DIMMER" and select the display window status from the below.

- AUTOMATIC:** When the power is on, the display window appears bright. When the power is off, it appears dark.
- DIM:** The window display always appears dark.
- OFF:** When the power is on, the display window appears dark. When the power is off, it is turned off.

DISPLAY/CALL (Turning the screen display "ON" or "OFF")

You can turn off the screen display that is output to the TV screen by this unit. Select "DISPLAY/CALL", and select "ON" or "OFF".

- ON:** The screen display appears.
- OFF:** Nothing but the SETUP MENU and error messages appear.



Setting the screen

This section describes settings about the screen.

Preparation:

- Turn ON the TV and set it to the video input mode.
- Select “AV SETUP 1” from “AV SETUP”. For the procedure, see steps 1 to 3 in “Using the SETUP MENU” on page 23.

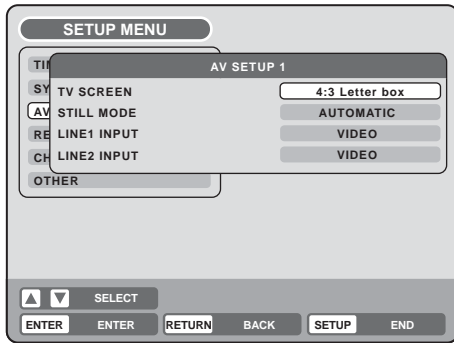

TV SCREEN

You can select the TV screen size to suit the screen image.

Select “TV SCREEN” and select screen size from the below.

4:3 Pan scan

It displays a wide picture across the whole screen with left and right edges automatically cut off.

4:3 Letter box

Select this mode when connecting to a conventional TV. When playing back a wide screen DVD disc, it displays a wide picture with black bands at the top and bottom of screen.

16:9

Select this mode when connecting to a wide-screen TV. A wide-screen picture is displayed in full size.

NOTE:

If the DVD disc is not formatted in the pan scan format, it displays a 4:3 aspect ratio.

STILL MODE

You can set the type of image displayed on the TV screen when the playback of the DVD is stilled.

Select “STILL MODE” and select the image to be displayed from the below.

AUTOMATIC

The field still or frame still is automatically selected. (For normal use.)

STILL BY FRAME

The frame still is set.

Note for the field still and frame still:

(with 480i interlaced scanning mode)

- Field* still (240 lines)
Since only one field (half of the video information) is shown on the TV screen, the picture appears rough but does not shake.
- Frame* still (480 lines)
Two fields are alternatively shown on the TV screen. The picture shakes but the resulting picture quality is superior to the field still pictures.

Field*: A field refers to the video information in one-half of a frame. 1 frame (screen) consists of 2 fields.

Frame*: A frame refers to the total area occupied by each picture on the TV screen.

LINE1 INPUT/LINE2 INPUT

This unit comes with an S-Video input jack and Video input jack. When you use an S-Video or Video input jack, you must select the input mode.

Select “LINE1 INPUT” (“LINE2 INPUT”) and select the mode from the below.

S-VIDEO

The Video signal is input only from the S-Video input jack.

VIDEO

The video signal is input only from the video input jack.

Various settings

Setting the image quality / Setting the audio

This section describes image quality settings.

Preparation:

- Turn ON the TV and set it to the video input mode.
- Select "AV SETUP 2" in "AV SETUP". For the procedure, see steps 1 to 3 in "Using the SETUP MENU" on page 23.

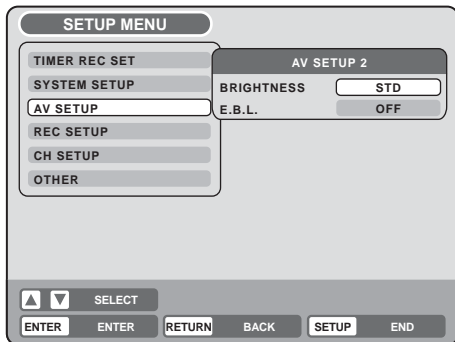

BRIGHTNESS

You can control the brightness level of the image. Select "BRIGHTNESS" and select the level from the below.

- MAX:** The image becomes brighter.
- STD:** The image is of standard brightness.
- MIN:** The image becomes darker.

E.B.L.

To select the black level of playback pictures, set your preference and monitor's ability.

- ON:** Enhanced grey scale (0 IRE cut off)
- OFF:** Standard grey scale (7.5 IRE cut off)

NOTE:

The E.B.L. function only works when playing back DVD-Video, DVD-RW/R or Video-CDs.

This section describes audio settings.

Preparation:

- Turn ON the TV and set it to the video input mode.
- Select "AUDIO" from "AV SETUP". For the procedure, see steps 1 to 3 in "Using the SETUP MENU" on page 23.

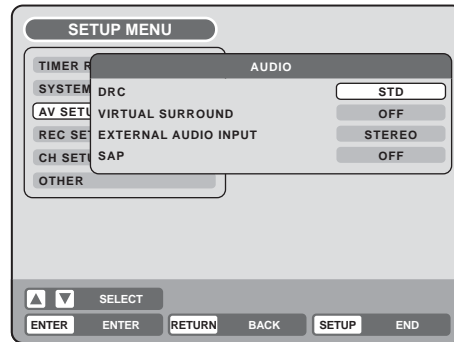

DRC

DRC (Dynamic Range Control) enables you to control the dynamic range so as to achieve a suitable sound for your equipment.

Select "DRC" and select the level from the below.

- MAX:** Full dynamic range is maintained.
- STD:** Full dynamic range is reduced.
- TV:** Dynamic range is reduced.

NOTES:

- This function works only during playback of Dolby Digital recorded discs.
- When you listen to the sound from TV's speaker, we recommend that you select "TV".
- The level of Dynamic Range Reduction may differ depending on the DVD.

VIRTUAL SURROUND (Spatializer N-2-2™)

Sound that is not recorded in the surround mode will be changed to artificial surround sound and output. Select "VIRTUAL SURROUND" and select "ON" to activate the virtual surround function. To not use the virtual surround, select "OFF".

NOTE:

This function does not work with a video tape.

EXTERNAL AUDIO INPUT

The audio mode for the audio input jack can be selected, choosing either stereo or monaural. Select "EXTERNAL AUDIO INPUT" and select from the below.

- STEREO:** The sound is treated as stereo sound.
- L CH:** The sound is treated as the monaural sound of the left channel.
- R CH:** The sound is treated as the monaural sound of the right channel.



Setting the audio / Setting the recording

SAP (Second Audio Program)

This unit is fitted with an SAP broadcast system that enables you to switch to a second audio program while viewing a selected channel.

This function applies only when the program is broadcast in multiple languages through the SAP broadcast system.

Select "SAP" and select "ON" to use SAP, and to not use it, select "OFF".

Listening to SAP

When the unit is turned on or a channel selection is made, make certain the letters "SAP" appear on the screen. This means that "Second Audio Program" broadcasting is available.

This section describes recording settings.

Preparation:

- Turn ON the TV and set it to the video input mode.
- Select "REC SETUP". For the procedure, see steps 1 to 3 in "Using the SETUP MENU" on page 23.

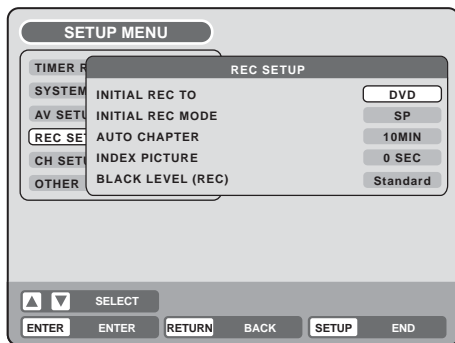

INITIAL REC TO

You can select the recording media that is first displayed in the item "REC TO" on the timer recording screen. Select "INITIAL REC TO" and select "DVD" or "VCR".

INITIAL REC MODE

You can select the recording mode that is first displayed in the item "REC MODE" on the timer recording screen. Select "INITIAL REC MODE" and select XP, SP, LP, or SLP.

NOTES:

- For the DVD recording mode, see page 52. And for the VCR recording mode, see page 48.
- Even if you select the recording mode by "INITIAL REC MODE", the recording mode on the display window does not change. If you want to change the recording mode, press **REC MODE/SPEED** on the remote control.

AUTO CHAPTER

You can automatically make chapter marks on the DVD to be recorded.

Select "AUTO CHAPTER" and select the interval between chapter marks from the below.

- OFF:** The automatic chapter is not used.
- 5 MIN:** The interval is set to 5 minutes.
- 10 MIN:** The interval is set to 10 minutes.
- 15 MIN:** The interval is set to 15 minutes.
- 30 MIN:** The interval is set to 30 minutes.

INDEX PICTURE

You can set the time that the thumbnail image is registered in the title menu of DVD-RW (VR mode).

Select "INDEX PICTURE" and select from the below.

- 0 SEC:** The image of a recording start point is registered.
- 1 MIN:** The image 1 minute after a recording start is registered.
- 3 MIN:** The image 3 minutes after a recording start is registered.

NOTE:

You cannot select the thumbnail image for Video mode.

BLACK LEVEL (REC)

You can set the black level for when you record.

- Standard :** Records at the level of the input source.
- Enhanced :** Lowers the level 7.5IRE and records.

The unauthorized recording, use, distribution, or revision of television programs, videotapes, DVDs and other materials, is prohibited under the Copyright Laws of the United States and other countries, and may subject you to civil and/or criminal liability.

Various settings

Setting the channel / Setting other items

This DVD/VCR is equipped with a channel memory feature that allows you to skip channels up or down to the next channel set in memory, hence skip over unwanted channels.

Before selecting channels, they must be programmed into the DVD/VCR's memory. In addition to normal VHF and UHF channels, this DVD/ VCR can receive up to 113 Cable TV channels. To use this DVD/VCR with an antenna, set the TV/CABLE menu option to the TV mode. When shipped from the factory, this menu option is in the CABLE mode.

Preparation:

- Turn ON the TV and set it to the video input mode.
- Select "CH SETUP". For the procedure, see steps 1 to 3 in "Using the SETUP MENU" on page 23.

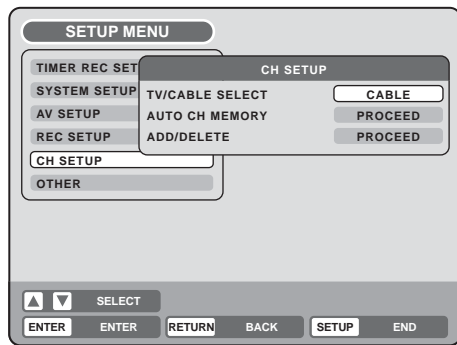

TV/CABLE SELECT

Select "TV/CABLE SELECT" and select "TV" or "CABLE".

- TV:** VHF/UHF channels
- CABLE:** CABLE TV channels

AUTO CH MEMORY

The VCR can receive a maximum of 181 channels by presetting the channels into memory.

When you select "AUTO CH MEMORY" and press **ENTER**.

The AUTO CH MEMORY function will be activated. The channel display will count up and, when finished, the screen returns to normal.

ADD/DELETE (channels)

You can add the channels you want or delete the channels you do not want manually.

Select "ADD/DELETE" and select "ADD" or "DEL." for each channel.

- Press **CH** \wedge/\vee to select the channel. The **numeric keys** can also be used for selection.
- When you want to delete the selected channel, press \blacktriangleright to select "DEL" and press **ENTER**.
- When you want to use the selected channel, press \blacktriangleleft to select "ADD" and press **ENTER**.

32

You can set the switching interval between played back images in the slide show mode.

Preparation:

- Turn ON the TV and set it to the video input mode.
- Select "OTHER". For the procedure, see steps 1 to 3 in "Using the SETUP MENU" on page 23.

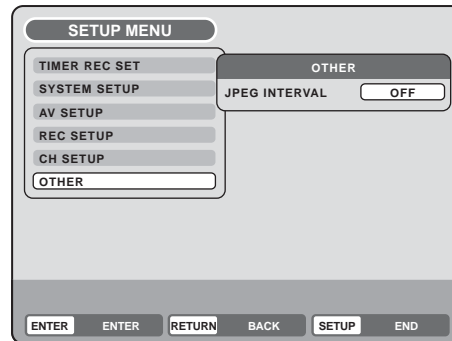

JPEG INTERVAL

You can select the interval time for JPEG slide show (page 46).

Select "JPEG INTERVAL" and select the switching interval between images from the below.

- OFF:** The slide show mode is not used.
- 5 SEC:** The interval is set to 5 seconds.
- 10 SEC:** The interval is set to 10 seconds.
- 15 SEC:** The interval is set to 15 seconds.

Playback procedure

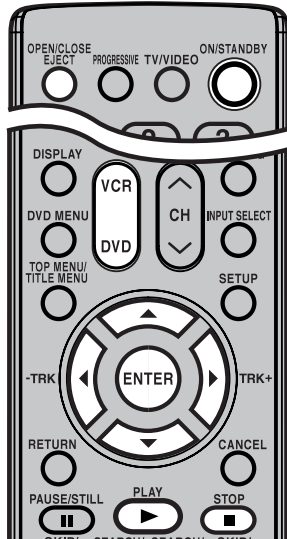

NOTES:

- If a non-compatible disc is loaded, "INCORRECT DISC", "REGION CODE ERROR" or "PARENTAL ERROR" will appear on the TV screen according to the type of loaded disc. In this case, check your disc again (See pages 9 and 25).
- Some discs may take a minute or so to start playback.
- A prohibition symbol "⊞" may appear at the upper right of the screen. This symbol means either the feature you tried is not available on the disc, or the DVD/VCR can not access the feature at this time. This does not indicate a problem with the DVD/VCR.
- When you set a single-faced disc label downwards (ie. the wrong way up) and press **PLAY** or **OPEN/CLOSE**, "READING" will appear and then it will change to "NO DISC".
- Some playback operations of DVDs may be intentionally fixed by software producers. Since this DVD/VCR plays DVDs according to the disc contents the software producers designed, some playback features may not be available. Also refer to the instructions supplied with the DVDs.
- When playing DTS-encoded Audio CDs, excessive noise will be heard from the analog stereo outputs. To avoid possible damage to the audio system, the consumer should take proper precautions when the analog stereo outputs of the DVD/VCR are connected to an amplification system.

Preparation:

- Turn ON the TV and set to the video input mode.
- Press **DVD** to select the DVD mode. (The DVD indicator will light.)

1 Press **OPEN/CLOSE**.
The disc tray will open.



2 Place a disc onto the tray.
Hold the disc, position it with the printed label side up, align it with the guides, and place it in its proper position.

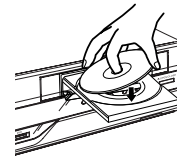

3 Press **OPEN/CLOSE** to close the disc tray.
"READING" appears on the screen and some discs start playback automatically.

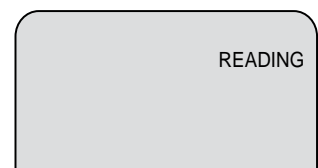

- A menu screen may appear on the TV screen, if the disc has a menu feature. In this case, press **▲**, **▼**, **◀**, **▶** or **ENTER** to operate a menu feature.

4 Press **PLAY** to start playback.

5 Press **STOP** to end playback.

- The DVD/VCR memorizes the stopped point, depending on the disc. "■" appears on the screen for approx. 4 seconds. "▶" keeps blinking in the display until the playback is stopped completely. Press **PLAY** to resume playback (from the scene point).
- If you press **STOP** again ("■" appears on the screen), the DVD/VCR will clear the stopped point.

6 Then press **OPEN/CLOSE**.

The disc tray opens.

Remove the disc and press **ON/STANDBY**.

The disc tray closes automatically and DVD/VCR turns off.

Disc playback

Playback by selecting a title



When playing back a recorded disc, you can display the title menu and select the title to be played back.

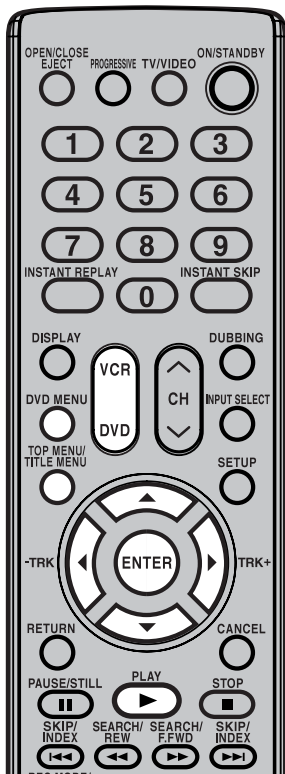

NOTE:

When a disc that has been recorded in the Video mode is finalized, the title menu is automatically changed that can be played back even with other DVD players. Thumbnail image and recording information will not appear in the title menu after finalizing

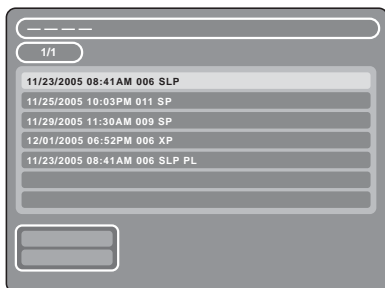

Preparation:

- Turn ON the TV and set to the video input mode.
- Load a recorded DVD.
- Press **DVD** to select the DVD mode. (The DVD indicator will light.)

1 Press **TITLE MENU**.
The title menu will appear.

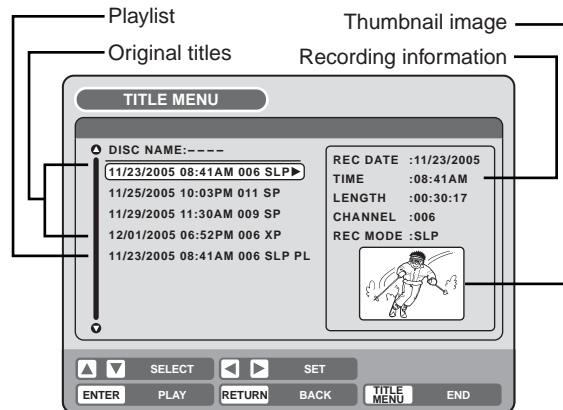

If there are many original titles and playlists... Before pressing **TITLE MENU**, press **DVD MENU** until "VR ORG" or "VR PL" will appear on the upper right of the TV screen, then press **TITLE MENU**.

The first original title or playlist will be highlighted.

2 Press **▲** or **▼** to select the title you want to playback.

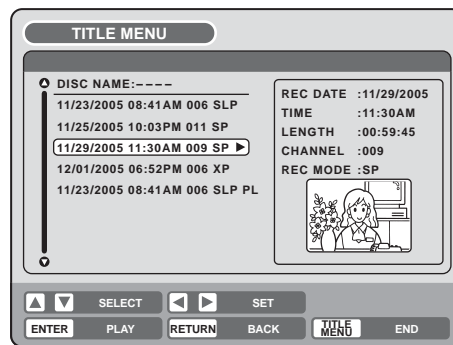

3 Press **ENTER**.
The selected title is played back.

NOTES:

- If you don't display the title menu and press **PLAY**, the first title is played back.
- The title menu is used not only for playing back titles but also for editing various discs and titles. For details of editing operation, see page 61.
- If you create a playlist, an original title and playlist appear in the title menu. For creating a playlist, see page 62.
- In case the disc includes more than 10 titles, you can turn to the next or the previous page. Press **◀**, then press **▼** or **▲** to display next/previous page. To return to normal use, press **▶**.
- You cannot switch to the VCR mode when the title menu is showing. Press **TITLE MENU** to clear the title menu, then press **VCR** to switch to the VCR mode.

Checking media information



Various information on the loaded disc can be displayed on the TV screen.

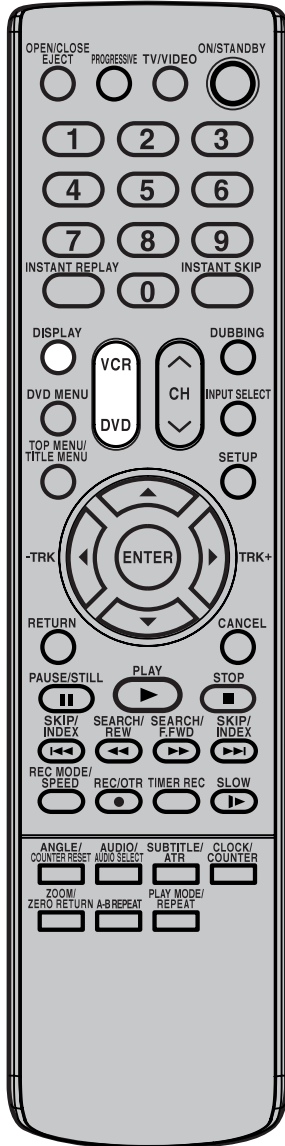

Preparation:

- Turn ON the TV and set it to the video input mode.
- Load the disc.
- Press **DVD** to select the DVD mode. (The DVD indicator will light.)

1 Press **DISPLAY**.
Media information will appear.

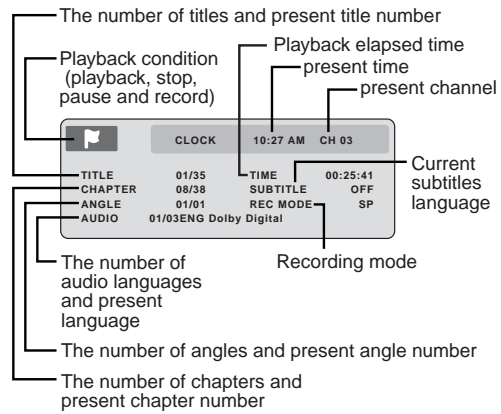

Disc playback

2 Press **DISPLAY** while the media information above is displayed.
The next media information will appear.

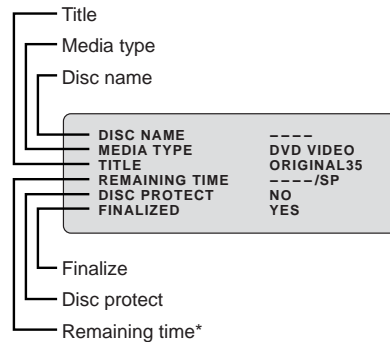

*The remaining time displayed during recording may be different from the actual remaining time. When you want to check the correct remaining time, stop recording and display the media information again.

3 Press **DISPLAY** again while the media information above is displayed. The media information will disappear.

NOTES:

- The displayed information varies with the type of media.
- Some information may not appear due to media type or operating conditions.
- In stop mode, some information does not appear.

Special playback



NOTE: There may be a slight delay between pressing the button and the function activation.

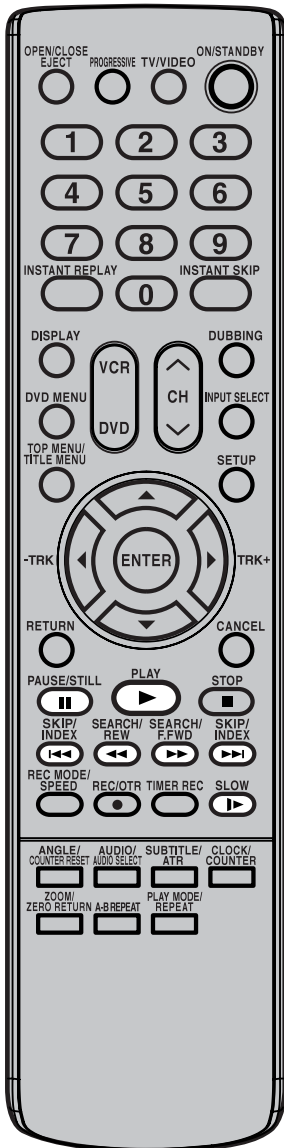

Fast forward playback

Press **SEARCH** **▶▶** during normal playback. Each press of **SEARCH** **▶▶** will increase the speed of the search **▶▶** (x2), **▶▶▶▶** (x12), **▶▶▶▶▶▶** (x24), **▶▶▶▶▶▶▶▶** (x60). (The speed of the search is increased up to only 2 steps in Audio CD.)

- To resume normal playback, press **PLAY**.

Review playback

Press **SEARCH** **◀◀** during normal playback. Each press of **SEARCH** **◀◀** will increase the speed of the search **◀◀** (x2), **◀◀◀◀** (x12), **◀◀◀◀◀◀** (x24), **◀◀◀◀◀◀◀◀** (x60). (The speed of the search is increased up to only 2 steps in Audio CD.)

- To resume normal playback, press **PLAY**.

Still playback

Press **PAUSE/STILL** during normal playback.

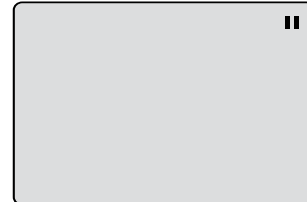

To resume normal playback, press **PLAY**.

Frame advance

Press **PAUSE/STILL** during still playback. One frame is advanced each time you press **PAUSE/STILL**.



To resume normal playback, press **PLAY**.

Slow motion playback

Press **SLOW** during normal playback or still playback. Each press of **SLOW** will change the speed of the slow "▶▶1/2", "▶▶1/4", "▶▶1/8".

- To resume normal playback, press **PLAY**.
- To resume the still playback, press **PAUSE/STILL**.

Locating a chapter or track

Press **SKIP** **▶▶** Forward or **SKIP** **◀◀** Reverse during playback to locate a chapter that you want to watch. Each time you press the button, a chapter or track is skipped.

- When you press **SKIP** **◀◀** once, playback starts from the beginning of the current chapter or track. If you want to play the preceding chapter or track, press **SKIP** **◀◀** twice in quick successions.

NOTES:

- The unit is capable of holding a still video image or On screen display image on your television screen indefinitely. If you leave the still video image or On screen display image displayed on your TV for an extended period of time, you risk permanent damage to your television screen. Projection televisions are very susceptible.
- Fast forward and review playback does not work with a MP3/WMA/JPEG-CD.
- Frame advance and slow motion does not work with a CD.

Instant skip / Locating a specific scene

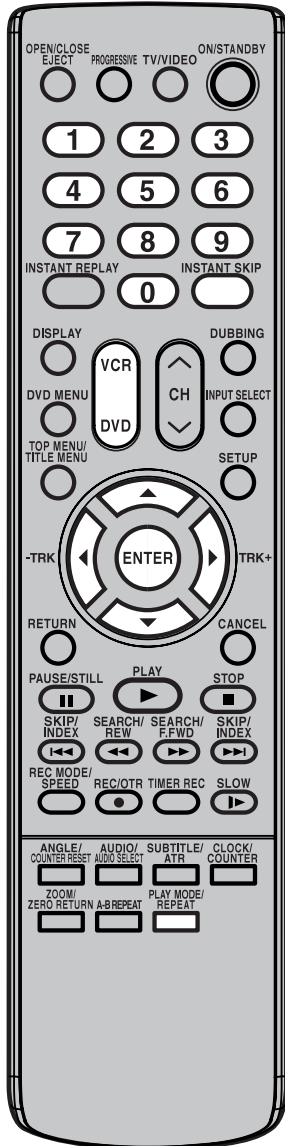

Instant skip

Use this function to skip commercials while you playback.

Press **INSTANT SKIP** during playback.

The time jumps to a point approx. 30 seconds later and playback resumes.

NOTE:

With some DVD-Video, the Commercial skip operation may not work.

Locating a specific scene

Specify the time recorded on the disc, chapter or title to playback.

- 1 Press **PLAY MODE**.
The play mode screen will appear.

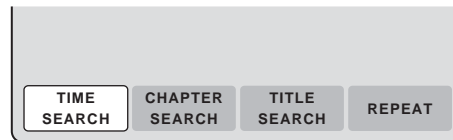

- 2 Press **◀** or **▶** to select "TIME SEARCH", "CHAPTER SEARCH" or "TITLE SEARCH", and press **ENTER**.

TIME SEARCH: Input the time to be played back.
CHAPTER SEARCH: Select the chapter number to be played back.
TITLE SEARCH: Select the title number to be played back.

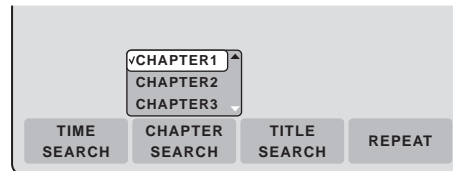

The screen above shows the display when "CHAPTER SEARCH" is selected.

- 3 When selecting "TIME SEARCH", input the time to be played back with the **numeric keys**. When selecting "CHAPTER SEARCH" or "TITLE SEARCH", press **▲** or **▼** to select the chapter number or title number.
- 4 Press **ENTER**.
The playback starts at the point you selected.

NOTE:

For "REPEAT", see "Title, Chapter repeat playback" (page 38).

Disc playback

Repeat playback

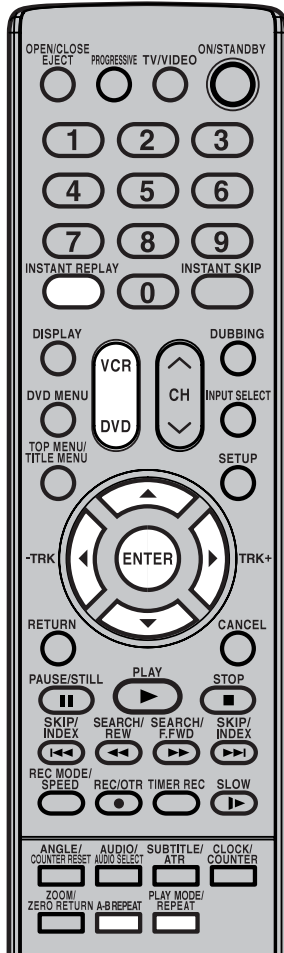

NOTES:

- Some discs may not work with the repeat operation.
- In A-B repeat mode, subtitles near point A or B may not appear.
- A-B repeat does not work during the Title and the Chapter repeat playback.
- You may not be able to set A-B repeat, depending on the scenes of the DVD.
- A-B repeat and Title, Chapter repeat does not work with a MP3/WMA/JPEG-CD and Video CD.

Instant replay

This feature can be used to repeat the last 10 seconds of viewed material, and continues to play as normal.

Press **INSTANT REPLAY** during playback. The video returns to a point 10 seconds before and playback resumes.

NOTES:

- If the time from the title top is less than 10 seconds when **INSTANT REPLAY** is pressed, the title top is repeated and then the video is played back.
- With some DVD-Video, the one touch repeat operation may not work.

A-B repeat playback

A-B repeat playback allows you to repeat material between two selected points.

- 1 Press **A-B REPEAT** during playback. The start point is selected.
- 2 Press **A-B REPEAT** again. The end point is selected. Playback starts at the point that you selected. Playback stops at the end point, returns to point A automatically, then starts again.



To resume normal playback press **A-B REPEAT** again. "OFF" appears on the screen.

Title, Chapter repeat playback

- 1 Press **REPEAT**. The play mode screen will appear.

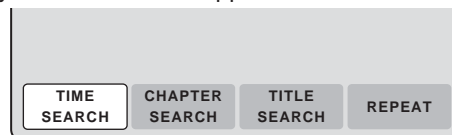

- 2 Press **◀** or **▶** to select "REPEAT" and press **ENTER**.



- 3 Press **▲** or **▼** to select "OFF", "CHAPTER" or "TITLE".
OFF: Playback is not repeated.
CHAPTER: The chapter in playback is repeatedly played back.
TITLE: The title in playback is repeatedly played back.

- 4 Press **ENTER**. To cancel the repeat playback, select "OFF" in step 3.



Title selection / DVD menu

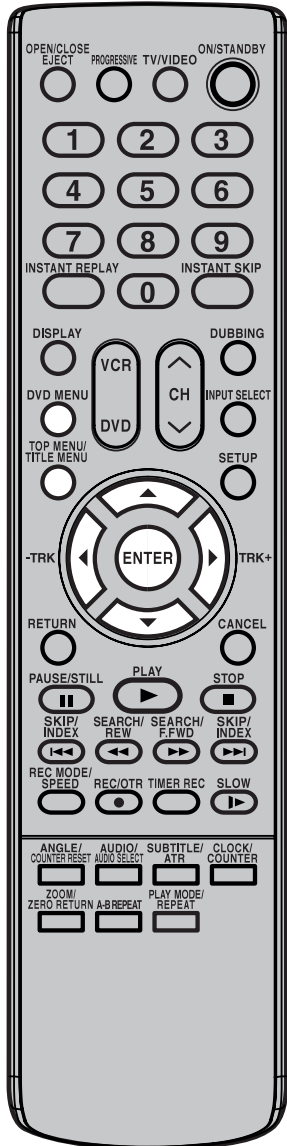

Title selection

Two or more titles are recorded on some discs. If the title menu is recorded on the disc, you can select the desired title.

- 1 Press **TOP MENU/TITLE MENU** during playback.
The title menu appears on the screen.
 - Press **TOP MENU/TITLE MENU** again to resume playback at the scene when you pressed **TOP MENU/TITLE MENU**.
- 2 Press **▲/▼** or **◀/▶** to select the desired title.
- 3 Press **ENTER**.
The playback of the selected title will start.

DVD menu

Some DVDs allow you to select the disc contents using the menu. When you playback these DVDs, you can select the subtitles language and soundtrack language, etc. using the DVD menu.

- 1 Press **DVD MENU** during playback.
The DVD menu appears on the screen.
 - Press **DVD MENU** again to resume playback at the scene when you pressed **DVD MENU**.
- 2 Press **▲/▼** or **◀/▶** to select the desired item.
- 3 Press **ENTER**.
The menu continues to another screen. Repeat steps 2 and 3 to set the item completely.

Disc playback

NOTE:

Depending on the DVD, you may be unable to select the title, and a "title menu" may simply be called a "menu" or "title" in the instructions supplied with the disc.

Changing angles / Zooming / Karaoke playback

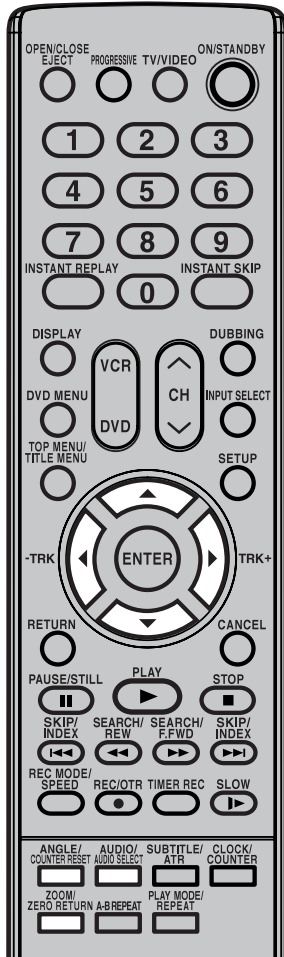

Changing angles

When playing back a disc recorded with multi-angle facility, you can change the angle that you are viewing the scene from.

- 1 Press **ANGLE** during playback. The current angle will appear.

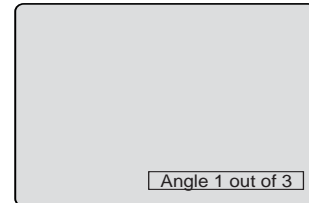

- 2 Press **ANGLE** repeatedly until the desired angle is selected.

Zooming

This unit will allow you to zoom in on the frame image. You can then make selections by switching the position of the frame.

- 1 Press **ZOOM** during playback. The center part of the image will be zoomed in. Each press of **ZOOM** will change the ZOOM "x2", "x3" and "x4".

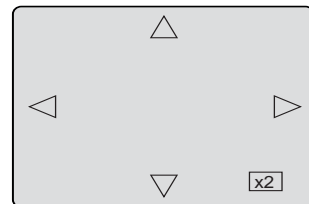

- 2 Press **▲/▼** or **◀/▶** to view a different part of the frame. You may move the frame from the center position to UP, DOWN, LEFT or RIGHT direction.

- 3 In the zoom mode press **ZOOM** repeatedly to return to a 1:1 view "x1".

Karaoke playback

You can turn the vocal on or off recorded on the DVD KARAOKE.

During DVD KARAOKE disc playback, press **AUDIO** repeatedly until the desired setting is selected.

- Vo. ON** : The primary vocal is output when it is recorded on the disc.
- Vo. OFF** : The primary vocal is not output.

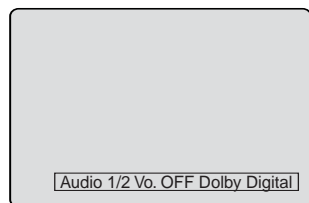

Notes :

- Some Karaoke discs may not have the vocal on/off function.
- The on screen display will disappear after a few seconds.

NOTES:

- Depending on the DVD, you may not be able to change the angles even if multi-angles are recorded on the disc.
- You can use the Pause, Slow, Search or Skip feature in the zoom mode.
- The vocal output feature is used during playback of Dolby Digital (multi-channel) recorded DVD KARAOKE discs. This feature allows you to turn off vocal audio tracks, or restore them for background accompaniment.
- When playing Karaoke, connect appropriate audio equipment such as an amplifier to this unit.