

ORION®

OWNER'S MANUAL
MANUAL DE INSTRUCCIONES

VIDEO CASSETTE RECORDER VIDEOGRABADOR DE CASSETTE

XS-XN

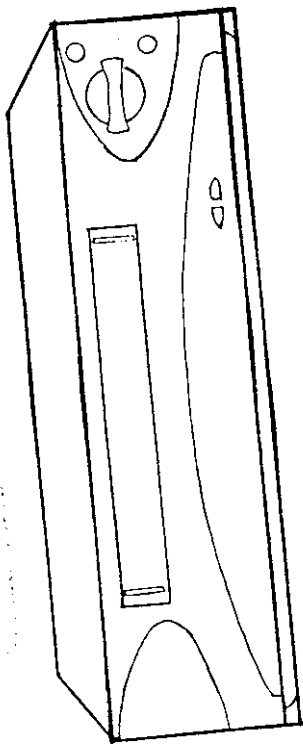
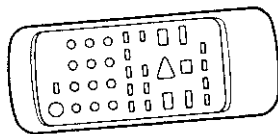

ATTENTION ATENCIÓN

If you purchase a universal remote control from your local retailer, please contact the remote manufacturer for the required programming code.
Si usted compró un control de remoto universal, por favor comuníquese con el fabricante para el código de programación requerido.

TV/CATV MODE SELECTION SELECCIÓN DE MODO DE TV/CATV

When shipped from the factory, this switch is in the "CATV" position.
If not using CATV (Cable TV), slide this switch to the "TV" position.
Al salir la unidad de fábrica, el interruptor selector TV/CATV se ajusta al modo de "CATV" (Televisión por cable).
Si no utiliza CATV, ajuste esta opción de menú al modo de "TV".

ATTACHMENT N
USER MANUAL (DRAFT)

VHS

Before operating the unit, please read this manual thoroughly.
Antes de usar la unidad, lea detenidamente este manual de instrucciones.

ENGLISH



CAUTION
RISK OF ELECTRIC SHOCK
DO NOT OPEN



CAUTION: TO REDUCE THE RISK OF ELECTRIC SHOCK, DO NOT REMOVE COVER (OR BACK). NO USER-SERVICEABLE PARTS INSIDE. REFER SERVICING TO QUALIFIED SERVICE PERSONNEL.



The lightning flash with arrowhead symbol within an equilateral triangle is intended to alert the user to the presence of uninsulated dangerous voltage within the product's enclosure that may be of sufficient magnitude to constitute a risk of electric shock to persons.

The exclamation point within an equilateral triangle is intended to alert the user to the presence of important operating and maintenance (servicing) instructions in the literature accompanying the appliance.

WARNING: TO REDUCE THE RISK OF FIRE OR ELECTRIC SHOCK, DO NOT EXPOSE THIS APPLIANCE TO RAIN OR MOISTURE.

WARNING: This equipment has been tested and found to comply with the limits for a Class B digital device, pursuant to Part 15 of the FCC Rules. These limits are designed to provide reasonable protection against harmful interference in a residential installation. This equipment generates, uses, and can radiate radio frequency energy and, if not installed and used in accordance with the instructions, may cause harmful interference to radio communications. However, there is no guarantee that interference will not occur in a particular installation. If this equipment does cause harmful interference to radio or television reception, which can be determined by turning the equipment off and on, the user is encouraged to try correcting the interference by one or more of the following measures:

- Reorient or relocate the receiving antenna.
- Increase the separation between the equipment and receiver.
- Connect the equipment into an outlet on a circuit different from that to which the receiver is connected.
- Consult the dealer or an experienced radio/TV technician for help.

CAUTION: Changes or modifications not expressly approved by the party responsible for compliance with the FCC Rules could void the user's authority to operate this equipment.

IMPORTANT SAFEGUARDS

1. **READ INSTRUCTIONS**
All the safety and operating instructions should be read before the unit is operated.
2. **RETAIN INSTRUCTIONS**
The safety and operating instructions should be retained for future reference.
3. **HEED WARNINGS**
All warnings on the unit and in the operating instructions should be adhered to.
4. **FOLLOW INSTRUCTIONS**
All operating and use instructions should be followed.
5. **CLEANING**
Unplug this unit from the wall outlet before cleaning. Do not use liquid cleaners or aerosol cleaners. Use a damp cloth for cleaning.
6. **ATTACHMENTS**
Do not use attachments not recommended by the unit's manufacturer as they may cause hazards.
7. **WATER AND MOISTURE**
Do not use this unit near water. For example, near a bathtub, washbowl, kitchen sink, or laundry tub, in a wet basement, or near a swimming pool.
8. **ACCESSORIES**
Do not place this unit on an unstable cart, stand, tripod, bracket, or table. The unit may fall, causing serious injury, and serious damage to the unit. Use only with a cart, stand, tripod, bracket, or table recommended by the manufacturer.

PORTABLE CART WARNING
(Symbol provided by RETAC)



- 8A. An appliance and cart combination should be moved with care. Quick stops, excessive force, and uneven surfaces may cause the appliance and cart combination to overturn.
9. **VENTILATION**
Slots and openings in the cabinet and in the back or bottom are provided for ventilation and to ensure reliable operation of the unit and to protect it from overheating. These openings must not be blocked or covered. The openings should never be blocked by placing the unit on a bed, sofa, rug, or other similar surface. This unit should never be placed near or over a radiator or heat source. This unit should not be placed in built-in installations such as a bookcase or rack unless proper ventilation is provided or the manufacturer's instructions have been adhered to.
10. **POWER SOURCES**
This unit should be operated only from the type of power source indicated on the rating plate. If you are not sure of the type of power supply to your home, consult your appliance dealer or local power company. For units intended to operate from battery power, or other sources, refer to the operating instructions.
11. **GROUNDING OR POLARIZATION**
This unit is equipped with a polarized alternating-current line plug (a plug having one blade wider than the other). This plug will fit into the power outlet only one way. This is a safety feature. If you are unable to insert the plug fully into the outlet, try reversing the plug. If the plug should still fail to fit, contact your electrician to replace your obsolete outlet. Do not defeat the safety purpose of the polarized plug. If your unit is equipped with a 3-wire grounding-type plug, a plug having a third (grounding) pin, this plug will only fit into a grounding-type power outlet. This too, is a safety feature. If you are unable to insert the plug into the outlet, contact your electrician to replace your obsolete outlet.
Do not defeat the safety purpose of the grounding-type plug.

IMPORTANT SAFEGUARDS

(CONTINUED)

12. POWER-CORD PROTECTION

Power-supply cords should be routed so that they are not likely to be walked on or pinched by items placed upon or against them, paying particular attention to cords at plugs, convenience receptacles, and the point where they exit from the appliance.

13. LIGHTNING

To protect your unit from a lightning storm, or when it is left unattended and unused for long periods of time, unplug it from the wall outlet and disconnect the antenna or cable system. This will prevent damage to the unit due to lightning and power line surges.

14. POWER LINES

An outside antenna system should not be located in the vicinity of overhead power lines or other electric light or power circuits, or where it can fall into such power lines or circuits. When installing an outside antenna system, extreme care should be taken to keep from touching such power lines or circuits, as contact with them might be fatal.

15. OVERLOADING

Do not overload wall outlets and extension cords, as this can result in a risk of fire or electric shock.

16. OBJECT AND LIQUID ENTRY

Do not push objects through any openings in this unit as they may touch dangerous voltage points or short out parts that could result in fire or electric shock. Never spill or spray any type of liquid into the unit.

17. OUTDOOR ANTENNA GROUNDING

If an outside antenna or cable system is connected to the unit, be sure the antenna or cable system is grounded so as to provide some protection against voltage surges and built-up static charges. Section 810 of the National Electrical Code, ANSI/NFPA 70, provides information with respect to proper grounding of the mast and supporting structure, grounding of the lead-in wire to an antenna discharge unit, size of grounding conductors, location of antenna discharge unit, connection to grounding electrodes, and requirements for the grounding electrode.

18. SERVICING

Do not attempt to service this unit yourself as opening or removing covers may expose you to dangerous voltage or other hazards. Refer all servicing to qualified service personnel.

19. DAMAGE REQUIRING SERVICE

Unplug this unit from the wall outlet and refer servicing to qualified service personnel under the following conditions:

- When the power-supply cord or plug is damaged.
- If liquid has been spilled, or objects have fallen into the unit.
- If the unit has been exposed to rain or water.
- If the unit does not operate normally by following the operating instructions. Adjust only those controls that are covered by the operating instructions, as an improper adjustment of other controls may result in damage and will often require extensive work by a qualified technician to restore the unit to its normal operation.
- If the unit has been dropped or the cabinet has been damaged.
- When the unit exhibits a distinct change in performance, this indicates a need for service.

20. REPLACEMENT PARTS

When replacement parts are required, be sure the service technician uses replacement parts specified by the manufacturer or those that have the same characteristics as the original parts. Unauthorized substitutions may result in fire, electric shock or other hazards.

21. SAFETY CHECK

Upon completion of any service or repairs to this unit, ask the service technician to perform safety checks to determine that the unit is in proper operating condition.

22. WALL OR CEILING MOUNTING

The product should be mounted to a wall or ceiling only as recommended by the manufacturer.

23. HEAT

The product should be situated away from heat sources such as radiators, heat registers, stoves, or other products (including amplifiers) that produce heat.

24. NOTE TO CATV SYSTEM INSTALLER

This reminder is provided to call the CATV system installer's attention to Article 820.40 of the NEC that provides guidelines for proper grounding and, in particular, specifies that the cable ground shall be connected to the grounding system of the building, as close to the point of cable entry as practical.

EXAMPLE OF ANTENNA GROUNDING AS PER THE NATIONAL ELECTRICAL CODE

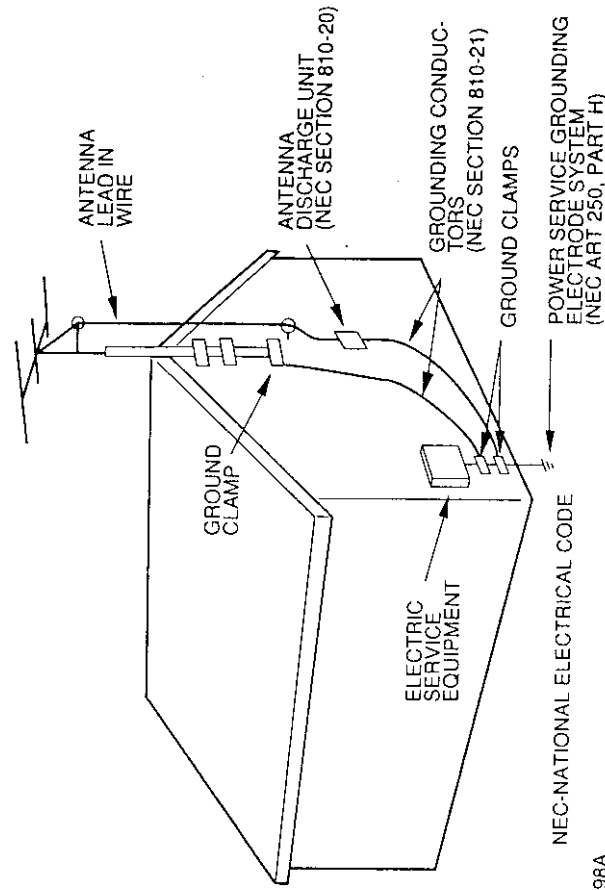

S2898A

FEATURES

High Quality Picture Technology - This video cassette recorder marked "HQ" incorporates VHS high quality technology. A built-in detail enhancer is used to boost the recorded signal and provide maximum picture quality in playback. It is compatible with other VHS video cassette recorders.

Frequency Synthesized Tuning - Quartz locked direct access tuner automatically locks in each channel for perfect reception. No presetting or channel tuning adjustments are required.

4 Video Heads - Provides optimal picture quality for special effects playback.

Full Load Tape Transport - Permits rapid access between modes.

8-Program/1-Month Programmable Timer with Every Day/Every Week Capability - The built-in timer allows automatic absentee recording of up to 8 TV programs within 1 month. It is also possible to record a program which is broadcast at the same time every day or every week.

On-Screen Display and Programming - When you select a channel or make other changes, the TV will show an indicator on the screen for a few seconds. Clock settings, timer setting and other set-up operations can be carried out using the on-screen display menu system.

Wireless Infrared Remote Control - The wireless infrared remote control allows operating the various functions from the comfort of your favorite viewing position.

Digital Auto Tracking - Automatically adjusts tracking during playback for the best possible picture.

181 Channel Tuner - Receives standard VHF and UHF broadcast channels and up to 113 cable channels.

One-Touch Timer Recording (OTR) - Simply by pressing the REC/OTR button, the VCR can be programmed for up to 5 hours of recording with an immediate start.

Automatic Power On - When loading a cassette tape, this VCR will automatically turn on.

Automatic Playback - When loading a cassette tape without the erase prevention tab, this VCR will automatically turn on and play back the cassette tape at the correct speed.

Automatic Rewind-Stop-Eject-Power Off - When a tape reaches its end during playback and recording, it will automatically stop, rewind, stop, eject the tape and the VCR will turn off.

Automatic Repeat Play System - When the AUTO REPEAT option is turned on, this VCR will automatically play back the same cassette tape repeatedly.

On-Screen 3 Language Display - You can select one of 3 languages: English, Spanish or French, for on-screen programming.

Slow Motion - This VCR provides slow motion which offers steady, noise-free playback at 1/10 normal speed.

Real Time Tape Counter - The counter displays on the screen the elapsed time in hours, minutes and seconds and can be used to locate programs.

Channel Skip - An unwanted channel can be deleted when using the CHANNEL UP or DOWN button.

2 Speed Picture Search - 3 or 5 times normal speed in SP mode (7X or 9X in LP and 9X or 15 X in SLP).

3 Speed Record/Playback - Records and plays three tape speeds (SP, LP, SLP).

Auto Head Cleaning System - Cleans the video heads automatically when a cassette tape is loaded and ejected.

TABLE OF CONTENTS

We recommend that you carefully read the descriptions and operating procedures contained in this Owner's Manual prior to operating your new VCR.

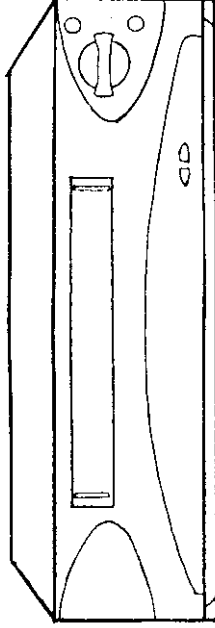

PRECAUTIONS

PRECAUTIONS	8
LOCATION OF CONTROLS	10
REMOTE CONTROL	12
BASIC CONNECTIONS	14
CATV (CABLE) CONNECTIONS	18
AUDIO/VIDEO CONNECTIONS	22
SETTING THE VIDEO CHANNEL	23
ON-SCREEN LANGUAGE SELECTION	24
SETTING THE NOISE MUTE	25
SETTING THE CLOCK	26

PLAYBACK

LOADING AND UNLOADING VIDEO CASSETTE TAPES	27
PLAYBACK	28
SPECIAL PLAYBACK	30

RECORDING

RECORDING A TV PROGRAM	32
ONE TOUCH TIMER RECORDING (OTR)	35
SETTING THE TIMER RECORDING	36

ADDITIONAL INFORMATION

ON-SCREEN FUNCTION DISPLAY	39
DUPLICATING A VIDEO TAPE	40
VIDEO HEAD CLEANING	41
VIDEO GLOSSARY	42
BEFORE REQUESTING SERVICE	44
SPECIFICATIONS	46

PRECAUTIONS

MOISTURE CONDENSATION

DO NOT OPERATE THIS VCR FOR AT LEAST TWO OR THREE HOURS WHEN MOISTURE IN THE AIR CONDENSES ON THE VCR.

■ WHAT IS MOISTURE CONDENSATION?

When a cold liquid is poured into a glass, for example, water vapor in the air will condense on the surface of the glass. This is called moisture condensation.

■ MOISTURE WILL CONDENSE ON THE UNIT IN THE FOLLOWING CASES:

- When you move this VCR from a cold to a warm place.
- After heating a cold room or under extremely humid conditions.

■ WHEN YOU EXPERIENCE THE ABOVE CONDITIONS,

Plug the power cord into an AC outlet, set the power switch to ON and leave the unit at room temperature until moisture condensation disappears.

Depending on the surrounding conditions, this may take two or three hours.



If you cause a static discharge when touching the VCR, and the VCR fails to function, simply unplugging the unit from the wall outlet, wait a few minutes and plug it back in. The VCR should return to normal operation.

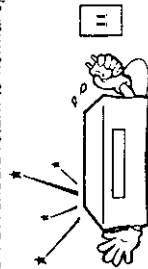

Avoid extreme heat.

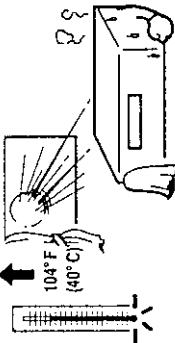

Do not place the VCR on or near appliances which may cause electromagnetic interference, e.g. TV, speakers, etc. Doing so may cause erratic operation of the VCR including picture and/or sound distortion or noise.

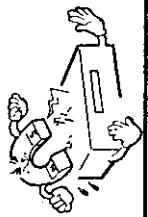

Avoid extreme cold.

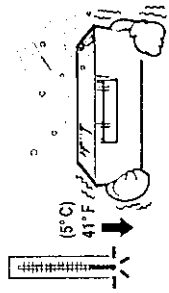

Avoid extreme moisture and dust.

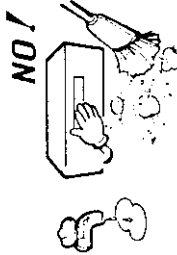

Do not insert fingers or any other objects into the cassette loading slot. Do not spray cleaner or wax directly on the VCR or use forced air to remove dust.

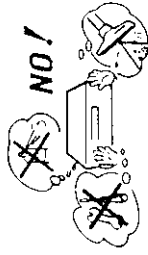

Keep the VCR away from flower vases, sinks, etc. If liquids should be spilled into the VCR, serious damage will result. If you spill any liquids into the VCR, unplug the AC power cord immediately and consult qualified service personnel before attempting to use the VCR again.



When you leave your home for a long time, unplug the AC power cord.

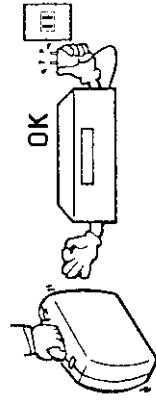

The ventilation holes prevent overheating. Do not block or cover these holes. Especially avoid covering the holes with soft materials such as cloth or paper.

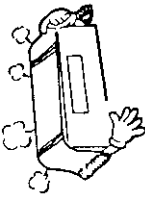

Avoid places subject to strong vibration. Use in a horizontal (flat) position only.

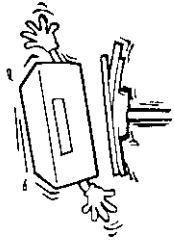

When you finish operating the VCR, always unload the cassette and turn off the power.

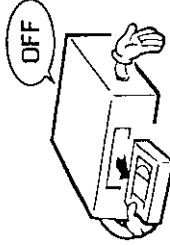

To protect the VCR from a lightning storm, unplug the AC power cord from the wall outlet and disconnect the antenna.



POWER SOURCE

IF THE POLARIZED AC CORD DOES NOT FIT INTO A NON-POLARIZED AC OUTLET, DO NOT ATTEMPT TO FILE OR CUT THE BLADE. IT IS THE USER'S RESPONSIBILITY TO HAVE AN ELECTRICIAN REPLACE THE OBSOLETE OUTLET.

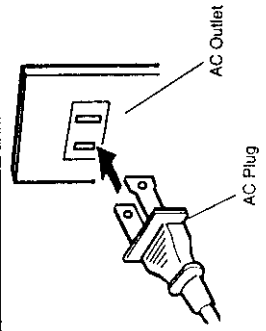

FRONT

LOCATION OF CONTROLS

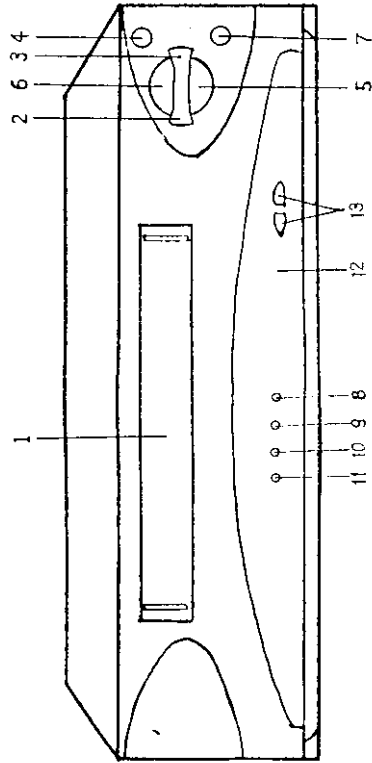

DESCRIPTION OF CONTROLS

1. **Cassette Loading Slot** - To insert or remove a video tape.
2. **REW button** - In the STOP mode, this button rapidly winds the tape backwards. In the PLAY mode, this button activates Reverse Search.
3. **FWD button** - In the STOP mode, this button rapidly winds the tape forward. In the PLAY mode, this button activates Forward Search.
4. **POWER button** - Turns the VCR power on and off.
5. **STOP/EJECT button** - Press once to stop the tape in any mode. Press again (on the VCR) to eject the tape.
6. **PLAY button** - Press to play a pre-recorded tape.
7. **REC/OTR button** - Press once to start normal recording. Additional presses activate One Touch Recording.
8. **POWER indicator** - Lights when the power is turned on.
9. **REC/OTR indicator** - Lights during recording.
10. **T-REC indicator** - Lights when the TIMER REC button is pressed.
11. **TV/VCR indicator** - Lights when the TV/VCR selector button is selected to the VCR mode.
12. **Remote Sensor** - Signals from the Remote Control are received here.
13. **CHANNEL UP/DOWN buttons** - Used to select a channel for viewing or recording.

REAR

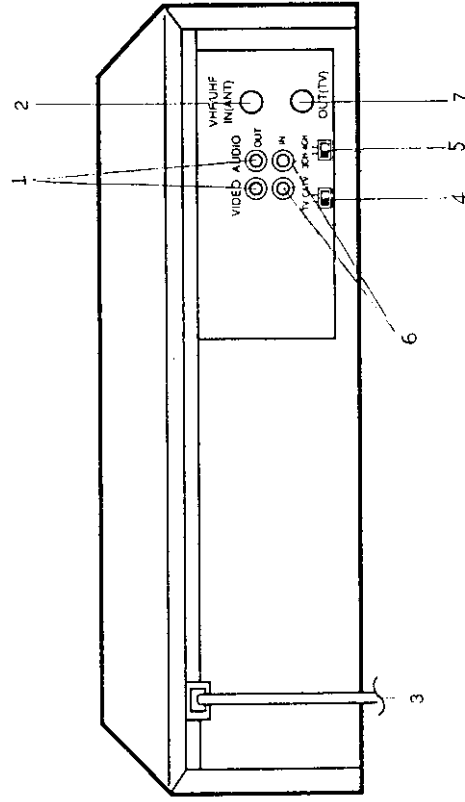

DESCRIPTION OF CONTROLS

1. **AUDIO/VIDEO OUT Jacks** - Used to output audio and video signals to a TV, amplifier or VCR.
2. **VHF/UHF IN Antenna Jack** - Connect a VHF/UHF antenna or CATV cable to this jack.
3. **AC POWER CORD** - Connect to a 120V 60Hz outlet.
4. **TV/CATV Selector Switch** - Selects antenna (TV) or (CATV) operation.
5. **3/4 Channel Selector Switch** - Selects the channel through which the VCR outputs its signal to a TV.
6. **AUDIO/VIDEO IN Jacks** - Audio and video signal cables from an external source can be connected here.
7. **VHF/UHF OUT Antenna Jack** - Used to output VHF/UHF or CATV signals to a TV.

When shipped from the factory, this switch is in the "CATV" position. If not using CATV (Cable TV), slide this switch to the "TV" position.

REMOTE CONTROL

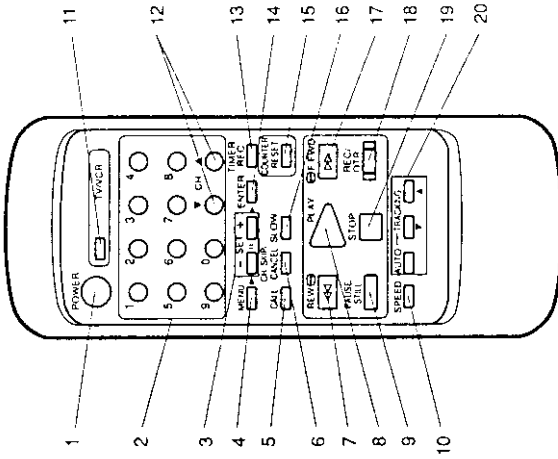

DESCRIPTION OF BUTTONS

- POWER button** - Turns the VCR power on and off.
- Direct Channel Selection buttons (0-9)** - Allow direct access to any channel.
- SET +/- buttons** - Used to set the clock, timer recording, auto repeat, language and noise mute.
- MENU button** - Press to display the on-screen menu function.
- CALL button** - Displays the present time/day of the week, channel, counter, speed selection and VCR mode on the TV screen.
- CH SKIP/CANCEL button** - Used to skip over unwanted channels, and used to clear the selected timer recording program.
- REW button** - In the STOP mode, this button rapidly winds the tape backwards. In the PLAY mode, this button activates Reverse Search.
- PLAY button** - Press to play a prerecorded tape.
- PAUSE/STILL button** - During recording, this button temporarily stops the tape. The PAUSE will appear on the screen. During playback, it stops the tape and displays a still image on the TV screen.
- TAPE SPEED (SP/LP/SLP) selector button** - Sets the tape speed for recording.
- TV/VCR selector button** - Switches between TV and VCR.
- CHANNEL UP/DOWN buttons** - Used to select a channel for viewing or recording.
- TIMER REC button** - Used to set the VCR to start recording at a preset time.
- ENTER button** - Used to enter information for timer recording, auto repeat, language, clock setting and sound mute.
- COUNTER RESET button** - Resets the Real Time Counter to 00:00:00.
- SLOW button** - Press to play back a tape in slow motion or to advance the tape one frame at a time during still playback.
- F. FWD button** - In the STOP mode, this button rapidly winds the tape forward. In the PLAY mode, this button activates Forward Search.
- REC/OTR button** - Press once to start normal recording. Additional presses activate One-touch Timer Recording.
- STOP button** - Press once to stop the tape. automatic or manual adjustment of tracking to minimize picture noise during playback.

BATTERY INSTALLATION

- 1 Open the battery compartment cover.

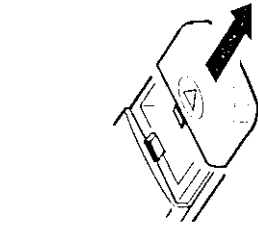

- 2 Install two "AAA" (penlight size) batteries.

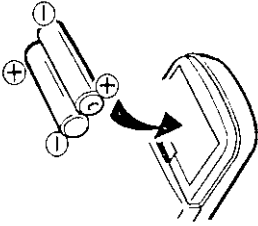

- 3 Replace the cover.

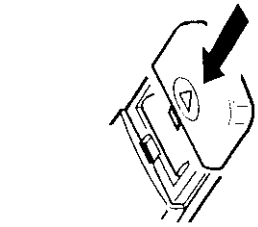

BATTERY CAUTIONS

Follow these precautions when using batteries in this device:

1. Use only the size and type of batteries specified.
2. Be sure to follow the correct polarity when installing the batteries as indicated in the battery compartment. Reversed batteries may cause damage to the device.
3. Do not mix different types of batteries together (e.g. Alkaline and Carbon-zinc) or old batteries with fresh ones.
4. If the device is not to be used for a long period of time, remove the batteries to prevent damage or injury from possible battery leakage.
5. Do not try to recharge batteries not intended to be recharged; they can overheat and rupture. (Follow battery manufacturer's directions.)

EFFECTIVE DISTANCE OF THE REMOTE CONTROL TRANSMITTER

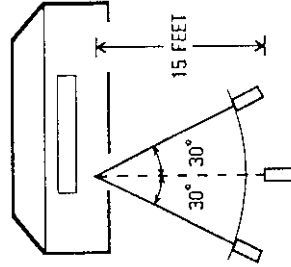

NOTE: • When direct sunlight, an incandescent lamp, fluorescent lamp or any other strong light shines on the Remote Sensor, the remote operation may be unstable.

- When there is an obstacle between the VCR and the transmitter, the remote control transmitter may not operate.

BASIC CONNECTIONS

If you are using an antenna system, follow the instructions on pages 14-17. If you are a cable (CATV) subscriber, skip ahead to page 18 for the proper connections.

ANTENNA TO VCR CONNECTION

The VCR must be connected "between" the antenna and the TV. First, disconnect the antenna from the TV and connect it to the VCR. Then connect the VCR to the TV. Below are 3 common methods of connecting an antenna system to a VCR. Find the type of antenna system you are using and follow the connection diagram. After you have connected the antenna to the VCR, follow the instructions on pages 16-17 to connect the VCR to the TV.

1 COMBINATION VHF/UHF ANTENNA WITH 75 OHM COAXIAL CABLE

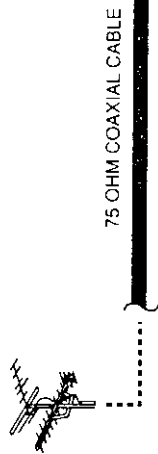

VCR

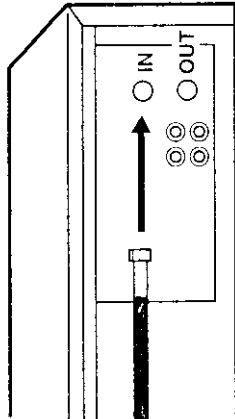

NOTE: IF A VHF OR UHF ANTENNA IS USED, SET THE TV/ CATV SELECTOR SWITCH TO THE "TV" POSITION.

This VCR has a single 75 ohm antenna input for connection to an antenna (VHF/UHF) or cable (CATV) system. If you have separate VHF and UHF antennas (number 3 below), use a combiner to connect the antennas to the VCR.

2 COMBINATION VHF/UHF ANTENNA WITH 300 OHM TWIN LEAD (FLAT) WIRE

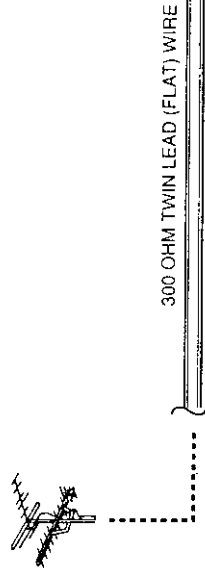

VCR

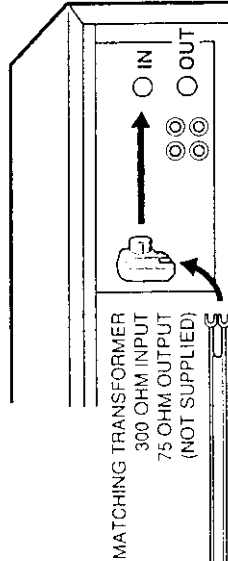

NOTE: IF A VHF OR UHF ANTENNA IS USED, SET THE TV/ CATV SELECTOR SWITCH TO THE "TV" POSITION.

3 SEPARATE VHF AND UHF ANTENNAS

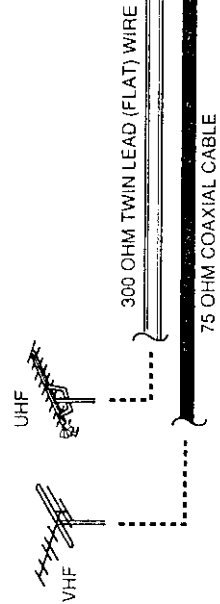

VCR

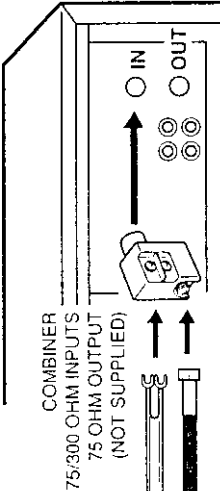

NOTE: IF A VHF OR UHF ANTENNA IS USED, SET THE TV/ CATV SELECTOR SWITCH TO THE "TV" POSITION.

NOTE: If both VHF and UHF antennas have 300 ohm twin lead (flat) wires, use a combiner having two 300 ohm inputs and one 75 ohm output.

NOTE: • A clear picture will not be obtained by the VCR unless the antenna signal is good. Connect the antenna to the VCR properly.

• For better quality recording, an indoor antenna or a telescopic antenna is not recommended. The use of an outdoor type antenna is required.

• If you are not sure about the connection, please refer to qualified service personnel.

BASIC CONNECTIONS

(CONTINUED)

VCR TO TV CONNECTION

After you have connected the antenna to the VCR (see pages 14 & 15), you must connect the VCR to the TV. Below are 3 common methods of connecting your VCR to a TV. Find the type of TV you are using and follow the connection diagram.

1

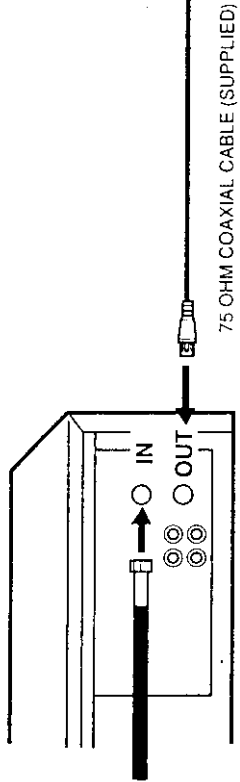

NOTE: IF A VHF OR UHF ANTENNA IS USED, SET THE TV/CATV SELECTOR SWITCH TO THE "TV" POSITION.

TV with single 75 ohm VHF/UHF antenna input

2

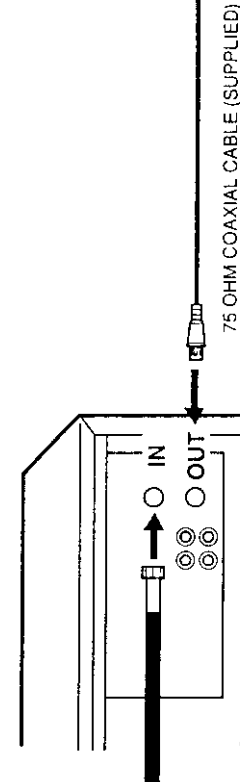

NOTE: IF A VHF OR UHF ANTENNA IS USED, SET THE TV/CATV SELECTOR SWITCH TO THE "TV" POSITION.

TV with 300 ohm UHF and 75 ohm VHF antenna inputs

3

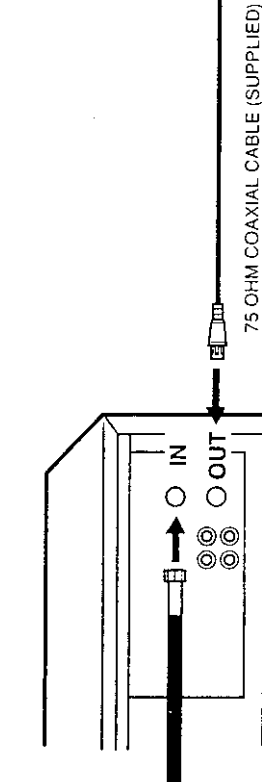

NOTE: IF A VHF OR UHF ANTENNA IS USED, SET THE TV/CATV SELECTOR SWITCH TO THE "TV" POSITION.

TV with 300 ohm UHF and 300 ohm VHF antenna inputs

CATV (CABLE) CONNECTIONS

Many cable companies offer services permitting reception of extra channels including pay or subscription channels. This VCR has an extended tuning range and can be tuned to most cable channels without using a cable company supplied converter box, except for those channels which are intentionally scrambled. If you subscribe to a special channel which is scrambled, you must have a descrambler box for proper reception.

This VCR cannot receive scrambled programs since it does not contain a descrambler. In order to receive scrambled programs, your existing descrambler must be used. Descrambler boxes are available from cable companies. Consult your local cable company for more information concerning connection to their descrambler equipment. There are many ways to connect your VCR to a cable system. Below are six common methods of connection.

1 IMPORTANT: MAKE SURE THE TV/CATV SELECTOR SWITCH IS SET TO THE "CATV" POSITION.

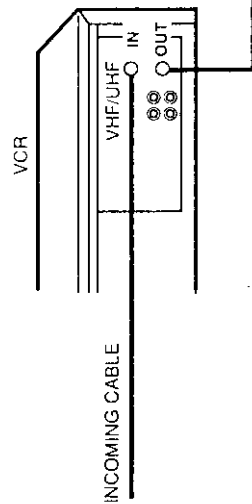

For basic cable service, no premium (scrambled) channels. **ALLOWS:**

- Recording of nonscrambled channels.
- Use of the programmable timer.
- Recording of one channel while watching another.

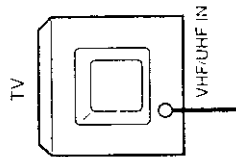

2 IMPORTANT: MAKE SURE THE TV/CATV SELECTOR SWITCH IS SET TO THE "CATV" POSITION.

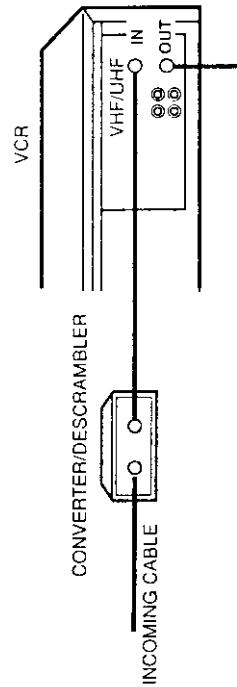

ALLOWS:

- Recording of channels through the converter box (scrambled and unscrambled).

• Using the programmable timer to record only the channel selected at the converter box.

PREVENTS:

- Recording one channel while watching another.
- Using the VCR tuner to select channels.

NOTE:

To record from converter/descrambler, VCR tuner must be tuned to the converter output channel, usually channel 3 or 4.

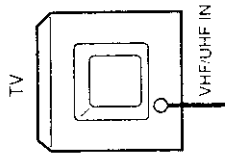

3 IMPORTANT: MAKE SURE THE TV/CATV SELECTOR SWITCH IS SET TO THE "CATV" POSITION.

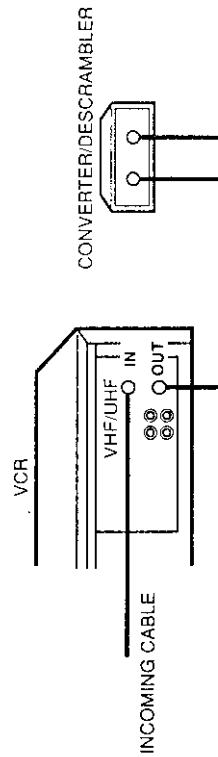

ALLOWS:

- Recording of unscrambled channels
- Using the programmable timer.
- Recording an unscrambled channel while watching any channel selected at the converter box.

PREVENTS:

- Recording scrambled channels.

NOTE:

If you are playing a tape or using the tuner built into the VCR, the converter must be set to the video channel output of the VCR (either 3 or 4).

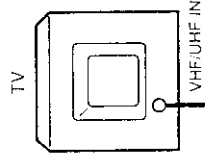

NOTE: WHENEVER A CONVERTER/DESCRAMBLER BOX IS PLACED BEFORE THE VCR, YOU MUST TUNE THE VCR TO THE OUTPUT OF THE CONVERTER/DESCRAMBLER BOX, USUALLY CHANNEL 3 OR 4.

CATV (CABLE) CONNECTIONS

(CONTINUED)

1 IMPORTANT: MAKE SURE THE TV/CATV SELECTOR SWITCH IS SET TO THE "CATV" POSITION.

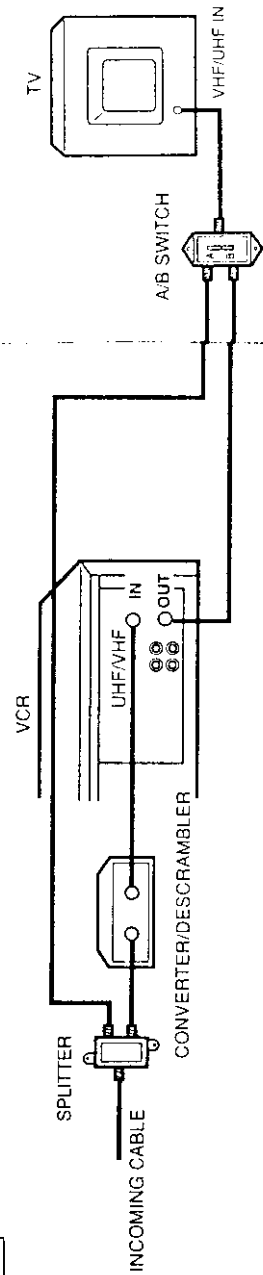

ALLOWS:

- Recording of all channels through the converter box.
- Recording of one channel while watching another.
- Using the programmable timer to record only the channel selected at the converter box.

PREVENTS:

- Watching scrambled channels while recording another channel.
- Using the VCR tuner to select channels.

NOTE:

To record from converter/descrambler, VCR tuner must be tuned to the converter output channel, usually channel 3 or 4.

2 IMPORTANT: MAKE SURE THE TV/CATV SELECTOR SWITCH IS SET TO THE "CATV" POSITION.

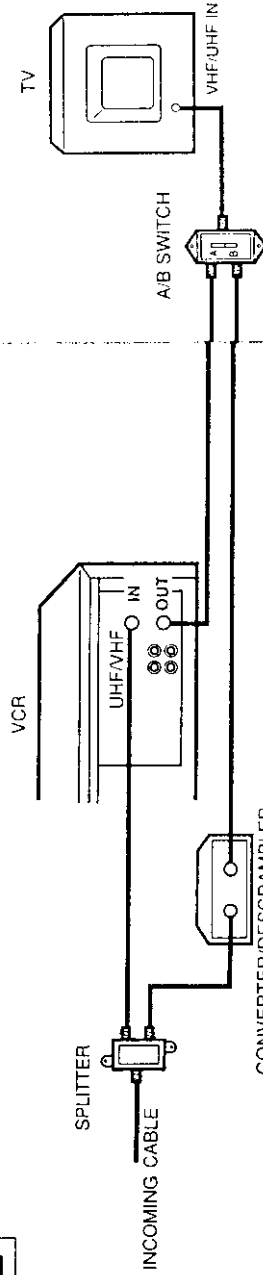

ALLOWS:

- Recording of nonscrambled channels.
- Recording of one channel while watching another.
- Watching premium channels through the converter while recording nonscrambled channels.
- Using the programmable timer.

PREVENTS:

- Recording scrambled channels.

3 IMPORTANT: MAKE SURE THE TV/CATV SELECTOR SWITCH IS SET TO THE "CATV" POSITION.

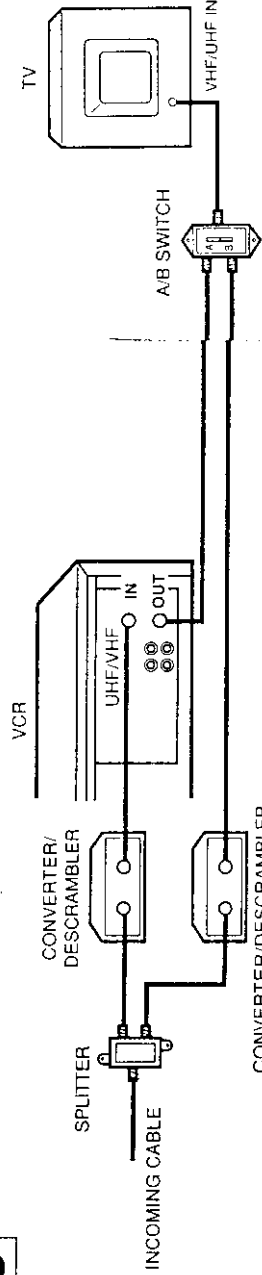

ALLOWS:

- Recording of all channels through the converter box.
- Recording a scrambled or unscrambled channel while watching another (scrambled or unscrambled) channel.
- Using the programmable timer to record only the channel selected at the converter box.

PREVENTS:

- Using the VCR tuner to select channels.

NOTE:

To record from converter/descrambler, VCR tuner must be tuned to the converter output channel, usually channel 3 or 4.

NOTE: WHENEVER A CONVERTER/DESCRAMBLER BOX IS PLACED BEFORE THE VCR, YOU MUST TUNE THE VCR TO THE OUTPUT OF THE CONVERTER/DESCRAMBLER BOX, USUALLY CHANNEL 3 OR 4.



SETTING THE VIDEO CHANNEL

To view playback of a recorded tape, or to watch a program selected by the VCR's channel selector, the TV must be set to channel 3 or 4 (video channel).

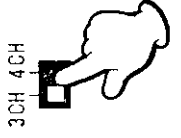
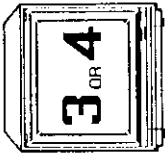
When a TV is connected with an antenna cable only.

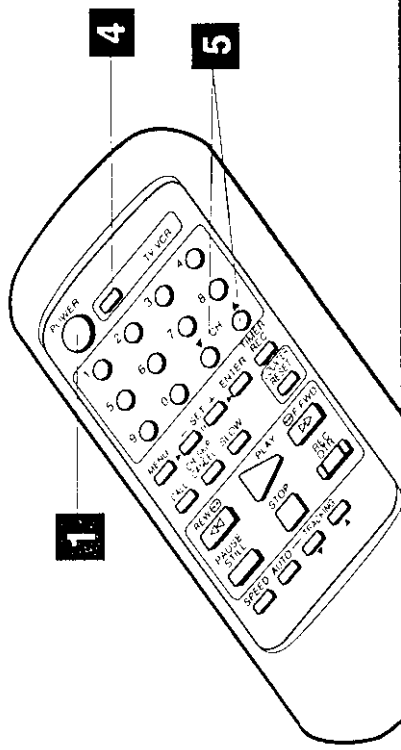
- 1** Turn ON the VCR POWER button. 
- 2** Set the 3/4 Channel selector switch (Rear of the VCR) to CH 3 or 4. 
- 3** Turn ON the TV and set to CH 3 or 4 to correspond with the channel selected in **2**. 



- 4** Press the TV/VCR selector button to select the VCR position. 
- 5** Select any channel to receive a TV station in your area. 

The TV/VCR indicator will light. 

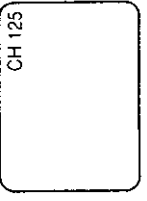
The channel number will appear on the screen about 4 seconds. 

For a push-button TV tuner

If CH 3 or 4 corresponding to the video channel cannot be tuned on your TV, proceed as follows: set the VCR 3/4 channel selector and the TV to CH 3 or 4, play back a prerecorded tape and tune the TV to receive a sharp color picture from the video cassette recorder. Refer to your TV owner's manual for details.

AUDIO/VIDEO CONNECTIONS

If your TV has AUDIO IN and VIDEO IN jacks, you can connect your VCR to them to receive a higher quality picture and sound. If you have a stereo, you can connect a stereo amplifier to enjoy powerful sound.

AUDIO/VIDEO CONNECTION

1. Connect the VIDEO OUT jack on the VCR to the VIDEO IN jack on the TV.
2. Connect the AUDIO OUT jack on the VCR to the AUDIO IN jack on the TV.
3. Set the VIDEO/TV selector of your TV to "VIDEO".

STEREO AMPLIFIER CONNECTIONS

When you connect your VCR to a Stereo Component System, you can view the picture from the VCR while enjoying powerful sound from your audio system.

NOTE: Sound will be monaural.

Connect the AUDIO OUT jack on the VCR to the AUDIO IN jack on the stereo.

ON-SCREEN LANGUAGE SELECTION

This VCR can display on the TV screen in the English, Spanish or French languages.

CHECK BEFORE YOU BEGIN

- Turn ON the TV and set to the video channel 3 or 4.
- Turn ON the VCR POWER button.
- Press the TV/VCR selector button to select the VCR mode.

When a TV is connected with an audio/video cable, turn the TV and this VCR on and select the video input mode on the TV.

- 1 Press the MENU button. Press the SET + or - button to select the LANGUAGE option, then press the ENTER button.

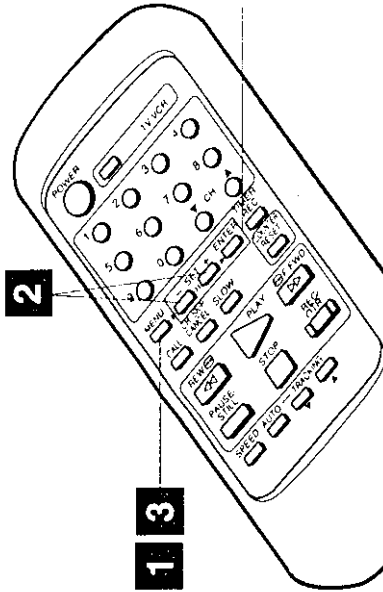
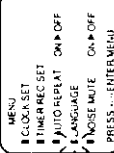

- 2 Press the SET + or - button to select the desired language: English, Spanish or French.

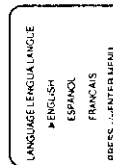
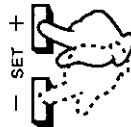

- 3 Press the MENU button twice.



SETTING THE NOISE MUTE

When you don't want to receive a weak signal broadcast, the Blue back screen can be obtained by selecting the NOISE MUTE "ON". When the unit is shipped from the factory, the NOISE MUTE is set to the "ON"

CHECK BEFORE YOU BEGIN

- Turn ON the TV and set to the video channel 3 or 4.
- Turn ON the VCR POWER button.
- Press the TV/VCR selector button to select the VCR mode.

When a TV is connected with an audio/video cable, turn the TV and this VCR on and select the video input mode on the TV.

- 1 Press the MENU button, then press the SET + or - button to select the NOISE MUTE option.

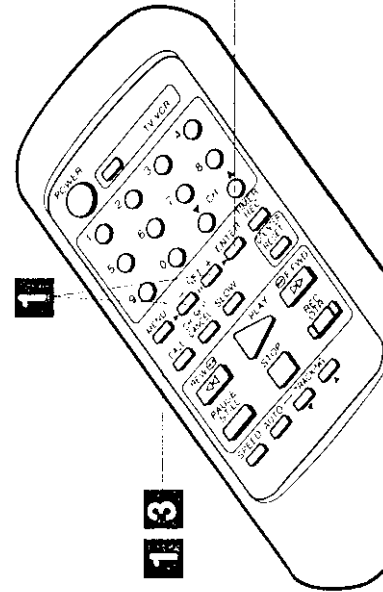
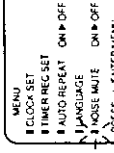

- 2 Press the ENTER button to select the ON position.

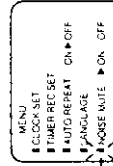

- 3 Press the MENU button twice.



SETTING THE CLOCK

You must set the date and time for timer recordings.

EXAMPLE: Setting the clock to "8:30 AM" October, 23(FRI), 1998.



1 Press the MENU button.

CHECK BEFORE YOU BEGIN

- Turn ON the TV and set to the video channel 3 or 4.
- Turn ON the VCR POWER button.
- Press the TV/VCR selector button to select the VCR mode.

When a TV is connected with an audio/video cable, turn the TV and this VCR on, and select the video input mode on the TV.

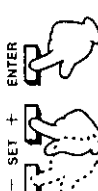
2 Press the SET + or - button to select the CLOCK SET option, then press the ENTER button.

MENU
 1. CLOCK SET
 2. AUDIO REPEAT ON/OFF
 3. PAUSE/PAUSE ON/OFF
 4. NOISE MUTE ON/OFF
 5. PRESS - ENTER/MENU

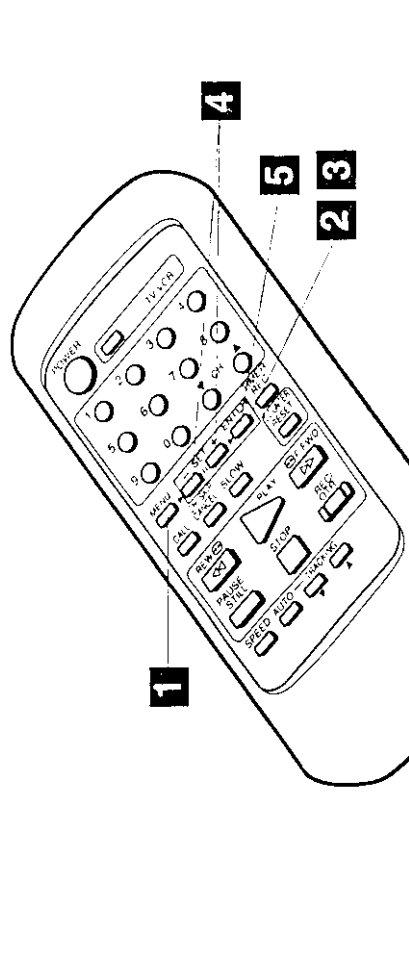

3 Press the SET + or - button to set the month, then press the ENTER button.

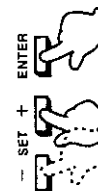

MONTH 10
 DAY 23(FRI)
 YEAR 1998
 TIME 12:00AM
 PRESS - ENTER/MENU

4 Set the day, year and time as in Step 3.

- The day of the week will automatically appear when you set the year.
- Press and hold down the button to increase/decrease the minute by 10.

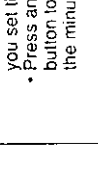

MONTH 10
 DAY 23(FRI)
 YEAR 1998
 TIME 12:00AM
 PRESS - ENTER/MENU

5 Press the ENTER button to start the clock.



8:30 AM FRI

NOTE: After a power failure or disconnection of the power, the timer will be lost. In this case, reset the present time.

LOADING AND UNLOADING VIDEO CASSETTE TAPES

Use only video cassette tapes marked VHS.

LOADING

Push the center of the tape until it is automatically retracted.

AUTOMATIC POWER ON
The VCR will turn on automatically and the POWER indicator will light.

AUTOMATIC PLAY
When loading a cassette tape without the erase prevention tab, playback will start immediately.

Insert the cassette with its labeled side facing you.
An inverted cassette cannot be inserted.

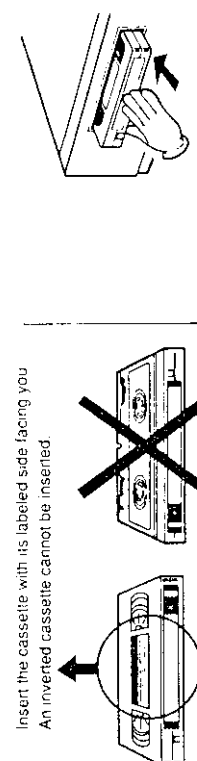

ENGLISH

UNLOADING

1 To unload a cassette, press the STOP/EJECT button on the VCR twice. The first press will stop the tape in any mode. The second press will eject the tape. The "EJECT" appear on the screen.

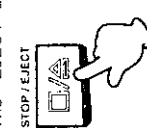

STOP/EJECT
 EJECT

2 Pull the cassette out.

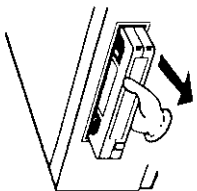

AUTOMATIC EJECT
If the VCR automatically rewinds the tape to the beginning (AUTO REWIND FEATURE), the tape will be ejected automatically (see the NOTE on page 33).

NOTE: • Always eject the tape when not in use.
• The cassette can be ejected even if the POWER switch is "OFF".

PLAYBACK

To play a prerecorded cassette tape.

TO START PLAYBACK

CHECK BEFORE YOU BEGIN

- Turn ON the TV and set to the video channel 3 or 4.
- When a TV is connected with an audio/video cable, turn the TV and this VCR on and select the video input mode on the TV.

1 Load a prerecorded tape. (When loading a cassette tape without the erase prevention tab, playback will start automatically.)

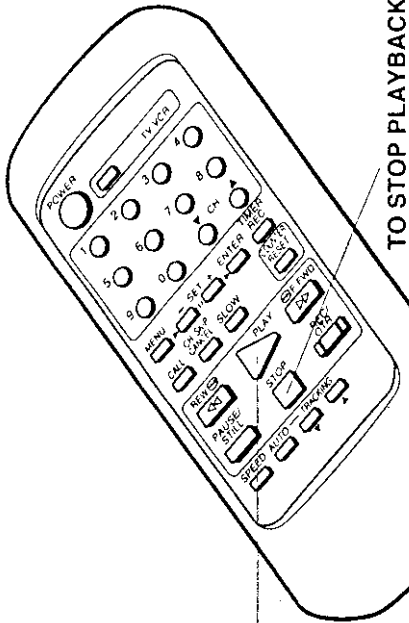
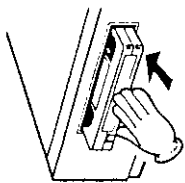

TO STOP PLAYBACK

Press the STOP button once. The tape will stop but remain fully loaded and ready to play.

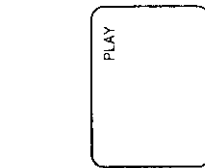

The "PLAY" will appear on the screen about 4 seconds.

The "STOP" will appear on the screen about 4 seconds.

TO REWIND OR FORWARD THE TAPE RAPIDLY

Press the REW button in the STOP mode.



Press the F.FWD button in the STOP mode.



The "REW" will appear on the screen about 4 seconds.

The "FF" will appear on the screen about 4 seconds.

DIGITAL TRACKING CONTROL

When a tape is played, the Digital Auto Tracking System automatically adjusts the tracking to obtain the best possible picture. If noise bars appear during playback, adjust the tracking manually:

- Press the MANUAL TRACKING UP or DOWN button to obtain the best possible picture. To resume automatic tracking, press the AUTO TRACKING button.

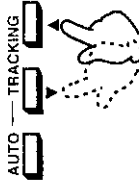
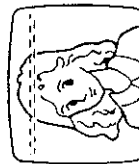

FORWARD/REVERSE PICTURE SEARCH

If you want to see the tape program during REW (F.FWD) mode, press and hold the REW (F.FWD) button again. The backward (forward) visual search picture will be seen on the screen. Release to return to the REW (F.FWD) mode.

SPECIAL PLAYBACK

TO VISUALLY SEARCH FOR DESIRED POINTS

When either the F.FWD or REW button is pressed in the PLAYBACK mode, the speed search picture will appear. When pressed twice, the search picture will increase speed. Speed search time depends upon the speed used (SP, LP or SLP) during recording. To rewind or fast forward a tape, press the STOP button, and then press the REW or F.FWD button.

To visually search backward, press the REW button once or twice in the PLAYBACK mode.



To visually search forward, press the F.FWD button once or twice in the PLAYBACK mode.

Press the PLAY button to resume normal viewing speed.

Press the PLAY button to resume normal viewing speed.

SLOW MOTION PLAYBACK

Press the SLOW button in the PLAYBACK mode. Playback will proceed at 1/10th of the normal speed.



Press the PLAY button again to resume normal playback.

NOTE: SLOW TRACKING AND VERTICAL LOCK ADJUSTMENT

If noise bars appear in the picture during slow motion, press the MANUAL TRACKING buttons to reduce the noise bars. If the still picture jitters excessively, press the MANUAL TRACKING buttons to stabilize the still picture.

TO WATCH A STILL PICTURE

Press the PAUSE/STILL button in the PLAYBACK mode.



Press the PAUSE/STILL button again to resume normal playback.

NOTE: • Best results during speed search playback can be obtained with cassette tapes recorded in the "SP" or "SLP" mode.

- The audio output is muted during SPEED SEARCH, SLOW, FRAME ADVANCE and STILL.
- A few noise bars will appear on the picture during SPEED SEARCH and STILL.
- To prevent damage to the tape, CUE, REVIEW and STILL playback is automatically changed to the PLAYBACK mode.

TO WATCH A TAPE REPEATEDLY

CHECK BEFORE YOU BEGIN

- Turn ON the TV and set to the video channel 3 or 4.
- Turn ON the VCR POWER button.
- Press the TV/VCR selector button to select the VCR mode.

When a TV is connected with an audio/video cable, turn the TV and this VCR on, and select the video input mode on the TV.

1 Press the MENU button.

- Press the SET + or - button to select the AUTO REPEAT option.

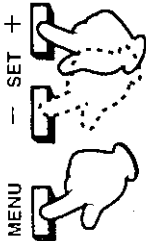

MENU
 CLOCK SET
 TIMER REC SET
 AUTO REPEAT ON/OFF
 LANGUAGE
 NOISE MUTE ON/OFF
 PRESS ENTER/MENU

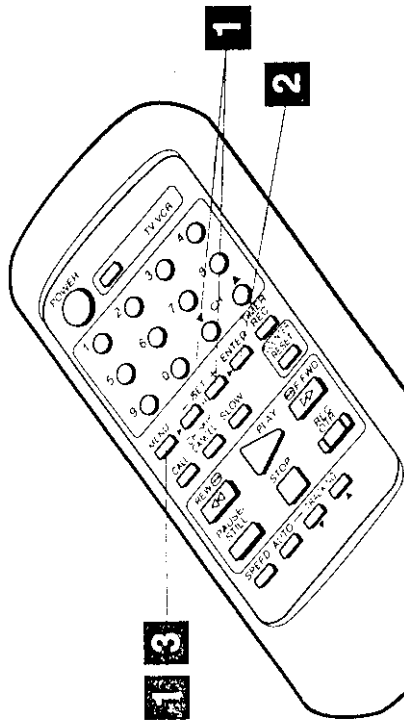

2 Press the ENTER button to select the ON position.



MENU
 CLOCK SET
 TIMER REC SET
 AUTO REPEAT ON/OFF
 LANGUAGE
 NOISE MUTE ON/OFF
 PRESS ENTER/MENU

3 Press the MENU button.

If you press the PLAY button, the tape will play over and over until the repeat mode is canceled.



NOTE: To cancel repeat mode, follow the above steps 1 and 2, then press the ENTER button to select the OFF position. Press the MENU button to return to the TV.

RECORDING A TV PROGRAM

RECORDING AND VIEWING THE SAME TV PROGRAM

CHECK BEFORE YOU BEGIN

- Turn ON the TV and set to the video channel 3 or 4.
- Turn ON the VCR POWER button.
- Press the TV/VCR selector button to select the VCR mode.

When a TV is connected with an audio/video cable, turn the TV and this VCR on and select the video input mode on the TV.

1 Load a cassette tape with the erase prevention tab intact. The VCR will automatically turn on.

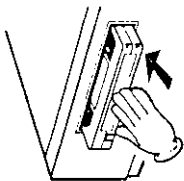

4 Press the REC/OTR button. The REC and channel number will appear on the screen about 4 seconds.



TO STOP RECORDING

Press the STOP button to stop recording. The STOP will appear on screen about 4 seconds.



TV	CATV
VHF 2-13	VHF 2-13
UHF 14-69	STD/IRC/IRC
	14-36
	(A) (W)
	37-59
	(AA) (WW)
	60-85
	(AAA) (ZZZ)
	86-94
	(BB) (94)
	95-99
	(A-5) (A-1)
	100-125
	(100)(125)
	01
	(5A)

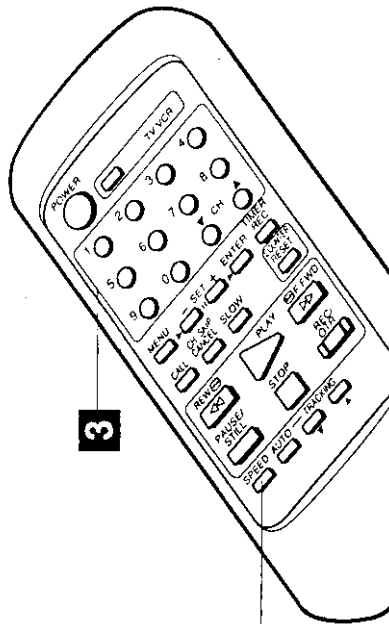

2 Press the TAPE SPEED selector button to select the desired tape speed SP, LP or SLP.



The SP, LP or SLP will appear on the screen about 4 seconds.

3 Press the direct channel selection buttons to select the channel to be recorded.

- 1-9 Press 0 twice and then 1-9 as required. (Example: to select 2, press 002.)
- 10-19 Press 0 first and then the remaining 2 digits in order from left to right. (Example: press 018 for 18.)
- 20-99 Press 2 digits in order. (Example: press 22 for 22.)
- 100-125 Press the 3 digits in order. (Example: press 110 for 110.)

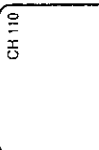

Or press the CHANNEL UP (or DOWN) button to select the channel to be recorded.

NOTE: Since the VCR has its own TV tuner, it is not actually necessary to have the TV turned on in order to make a recording. Turning on the TV merely allows confirmation of the proper channel settings on your VCR.

TO STOP RECORDING TEMPORARILY TO SKIP UNUSED CHANNELS

Press the PAUSE/STILL button to avoid recording unwanted material. Press again to continue the recording. The PAUSE will appear on screen about 4 seconds and the REC indicator will blink to continue pause mode.

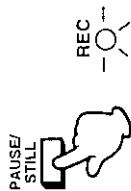

NOTE: The pause function will be released after 5 minutes to prevent damage to the tape or the VCR. The VCR will change to the STOP mode.

If you wish to skip an unwanted channel press the CH SKIP/CANCEL button. The channel number will blink to indicate that this channel cannot be selected by using the CHANNEL UP or DOWN button. If you press the CH SKIP/CANCEL button once, the channel will be deleted. If you wish to restore the deleted channel, press the DIRECT CHANNEL SELECTION button and then press CH SKIP/CANCEL button. The deleted channel will be restored.



NOTE: • AUTO REWIND FEATURE
This VCR will automatically rewind the tape when the tape has ended (except during OTR and TIMER REC). It will also eject the tape and turn the VCR's power OFF.
• ENSURE ALL CABLES FROM THE VIDEO IN AND AUDIO IN JACKS ON THE VCR ARE DISCONNECTED. OTHERWISE IT IS IMPOSSIBLE TO RECORD TV PROGRAMS.

RECORDING A TV PROGRAM

(CONTINUED)

ONE-TOUCH TIMER RECORDING (OTR)

The one-touch timer recording feature provides a simple and convenient way to make a timed recording.

RECORDING ONE PROGRAM WHILE WATCHING ANOTHER

1 While the VCR is recording, press the TV/VCR selector button to select the TV position. The TV/VCR indicator will go off and recording will continue.

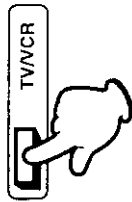

2 Select the TV channel you want to watch by using the TV channel selector.

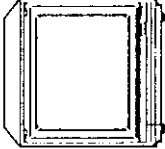

EXAMPLE: One-touch timer recording for 30 minutes.

CHECK BEFORE YOU BEGIN

- Turn ON the TV and set to the video channel 3 or 4.
- Turn on the VCR power button.

When a TV is connected with an audio/video cable, turn the TV on and select the video input mode on the TV.

1 Load a cassette tape with the erase prevention tab intact.



2 Press the TAPE SPEED selector button to select the desired tape speed SP, LP or SLP. The SP, LP or SLP will appear on the screen about 4 seconds.



SPEED

00 : 00 : 00 SP

NOTE: Some CATV hookups do not permit viewing one channel while recording another. See pages 18-21.

TO PREVENT AN ACCIDENTAL RECORDING TO RECORD AGAIN

After recording, break off the erase prevention tab if you do not wish to record over the tape.

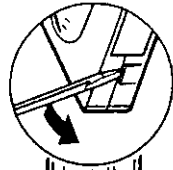

Erase prevention tab

Cover the hole with adhesive tape. Be careful the tape does not extend past the edges of the cassette housing.

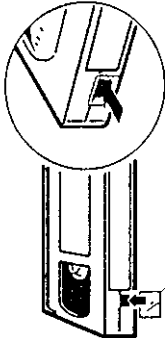

Adhesive tape

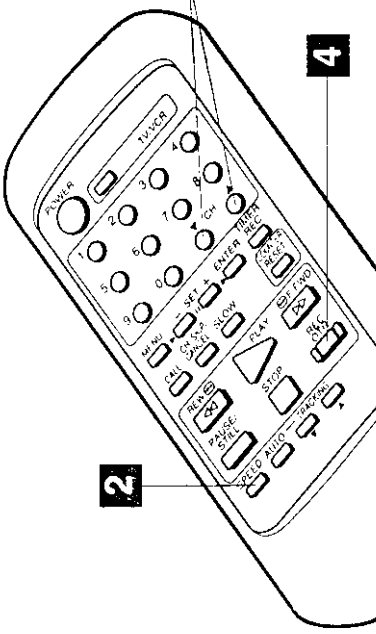

1 Press the CHANNEL UP (or DOWN) button to select the channel to be recorded.

2 Press the REC/OTR button to begin recording. Press the button again to stop recording after 30 minutes. Each additional press of the REC/OTR button will increase recording time as shown in the chart below, up to a maximum of 5 hours. The OTR, channel number and recording time will appear on screen about 4 seconds.

3 Press the REC/OTR button to increase the time needed for recording. (See the chart below.)

4 Press the CH button to increase the channel number. The channel number will appear on the screen.

TAPE SPEED AND MAXIMUM RECORDING/PLAYBACK TIME

TAPE SPEED	VIDEO CASSETTE TAPE					
	T-210	T-160	T-120	T-90	T-60	T-30
SP (Standard Play)	3-1/2 hours	2 hours	1-1/2 hours	1 hour	30 minutes	
LP (Long Play)	7 hours	4 hours	3 hours	2 hours	1 hour	
SLP (Super Long Play)	10-1/2 hours	6 hours	4-1/2 hours	3 hours	1-1/2 hours	

NOTE: Press the REC/OTR button to increase the time needed for recording. (See the chart below.)

Press	once	twice	3 times	4 times	5 times	6 times	7 times	8 times	9 times
Recording time	NORMAL REC	0:30	1:00	1:30	2:00	3:00	4:00	5:00	NORMAL REC

• To cancel OTR, set the OTR recording time to normal recording (present time will be displayed) and

SETTING THE TIMER RECORDING

Timer recording can be programmed on-screen with the remote control. The built-in timer allows automatic unattended recording of up to 8 programs within 1 month.

EXAMPLE: Program a timer recording for the 26th day, channel 125 (CATV), 11:00 - 11:30 PM on timer program number 1. (Tape speed: SLP)

1 Press the MENU button. Check the **TIMER REC SET** option is selected, then press the **ENTER** button.

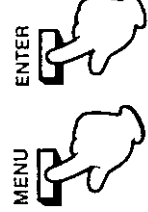
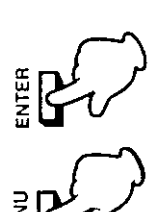

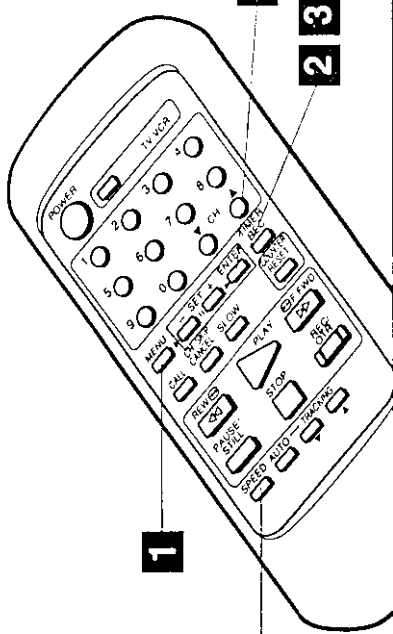

MENU
▲ CLOCK SET
▼ TIMER REC SET
▲ AUTO REPEAT ON+OFF
▼ LANGUAGE ON+OFF
▲ NOISE MUTE ON+OFF
▼ PRESS...ENTER MENU

When a TV is connected with an audio/video cable, turn the TV and this VCR on and select the video input mode on the TV.

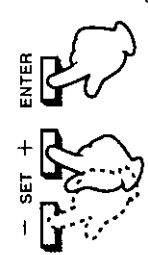

2 Press the **SET + or -** button to select the **PROGRAM**, then press the **ENTER** button.



3 Press the **SET + or -** button to select the date, then press the **ENTER** button and press the **SPEED** button to select the desired tape speed.

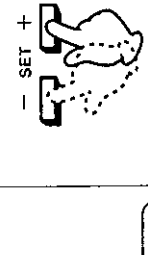
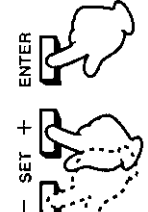
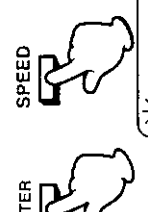





TIMER PROG. NO.
1
2
3
4
5
6
7
8

DATE
1
2
3
4
5
6
7
8
9
0
SP
1
2
3
4
5
6
7
8
9
0

NOTE: To set the timer for other programs, press the **MENU** button. Check that the **TIMER REC. SET** option is selected, then press the **ENTER** button. Press the **SET + or -** button until the next program blinks, then press the **ENTER** button. Repeat steps 3 to 4 to set the second program.

4 Set the start time, end time, and channel as in step 3.

26th
125
11:00
11:30
PM
CH
125

5 Press the **MENU** button twice to return to the normal screen.



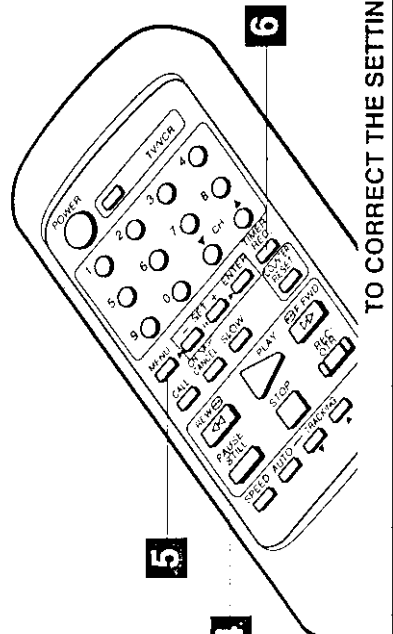

6 Press the **TIMER REC** button. The power will go off, the **T. REC** indicator will light and the VCR stands by for recording.



TO CORRECT THE SETTINGS

While setting, press the **ENTER** button to flash the item to correct, then re-enter the setting with the **SET + or -** button.

When finished, press the **ENTER** button.



NOTE:

- The VCR cannot be used while the **T. REC** indicator is lit.
- After a power failure or disconnection of the power plug, all programmed recording settings must be reset upon resumption of power. In this case, reset the clock (see page 26) and reprogram any timer recordings.

SETTING THE TIMER RECORDING (CONTINUED)

ON-SCREEN FUNCTION DISPLAY

Press the CALL button. Each press changes the on-screen function display as follows:

WHILE WATCHING TV

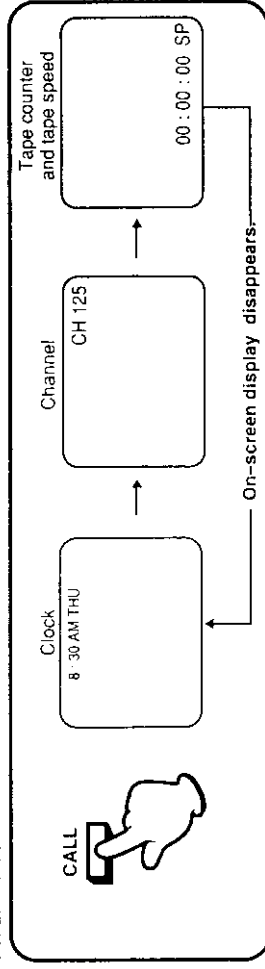

WHILE OPERATING A TAPE

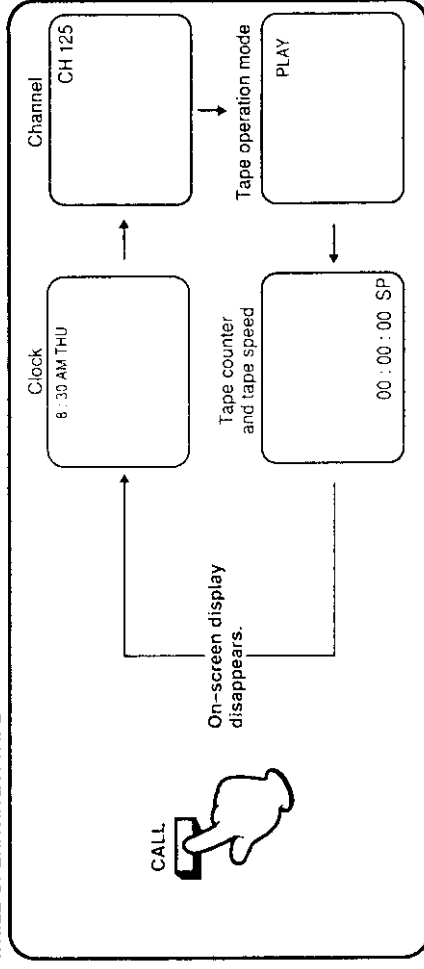

TO SET THE COUNTER TO '00:00:00'

Press the COUNTER RESET button.

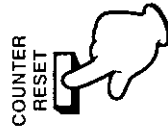

TO CONFIRM THE SETTINGS

Press the SET + or - button to select the TIMER REC SET option in the MENU.

Then press the ENTER button to display the timer program list.

Press the MENU button twice to return to the normal screen.

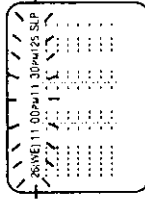

TO SET DAILY/WEEKLY TIMER

When setting the date in step 3, press the SET - button repeatedly when the current day is displayed. The setting changes as follows:

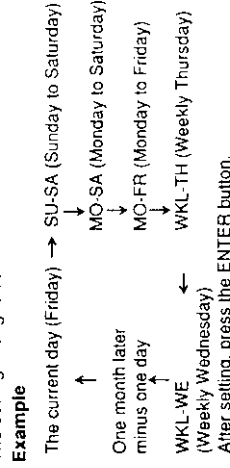

After setting, press the ENTER button.

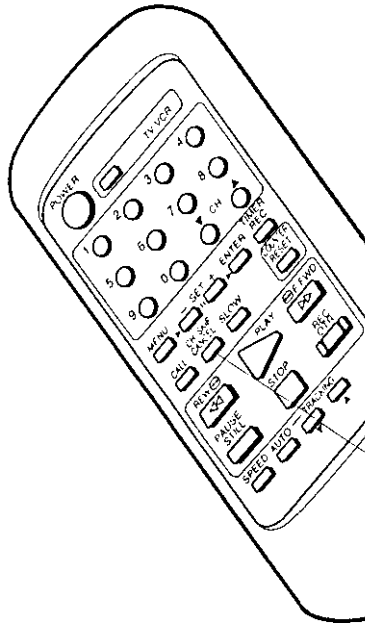

TO CANCEL A PROGRAM

Press the SET + or - button to select the TIMER REC SET option in the MENU.

Then press the SET + or - button to select the unnecessary program, and press the CH.SKIP/CANCEL button to cancel the program.

CH.SKIP/
CANCEL



NOTE: Do not overlap programs as portions of the conflicting programs will be lost. The first recording time has priority over the next recording time as shown in the diagram.

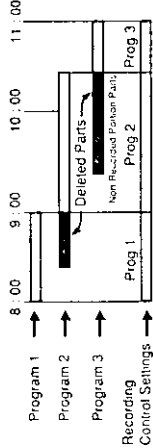

NOTE: • The every day/every week recording can be made continuously until the recording is canceled or the tape reaches the end.

• During timer recording, the automatic rewinding mechanism does not function.

NOTE: • If you rewind the tape from "00:00:00", a minus sign ("-") will be displayed in front of the time.

• When you load a tape, the counter will change to "00:00:00".

• The counter does not function on nonrecorded (blank) sections of the tape. When you rewind, fast forward or play tapes through blank sections, the counter stops.

DUPLICATING A VIDEO TAPE

If you connect the VCR to another VCR or camcorder, you can duplicate a previously recorded tape. Make all connections before turning on the power.

1 Load a blank cassette tape with the erase prevention tab intact into the recording VCR. Load a previously recorded tape into the playback VCR or CAMCORDER.

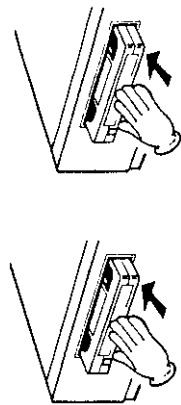

2 Press the REC/OTR button on the recording VCR, then press the PAUSE/STILL button.

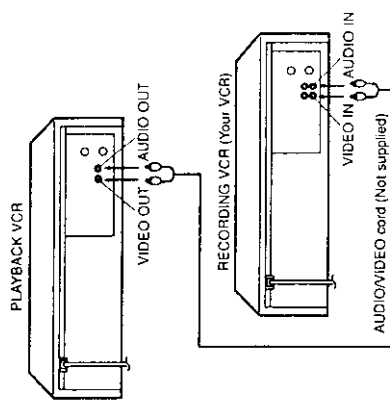
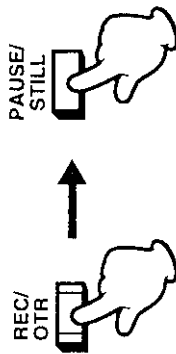

For duplicating a previously recorded tape from a camcorder, follow the camcorder manufacturer's instructions. A typical camcorder dubbing hookup is shown above.

3 Press the PLAY button on the playback VCR, then press the PAUSE/STILL button.

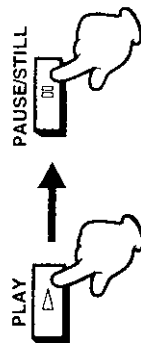

4 Press the PAUSE/STILL button on both the VCRs simultaneously to begin the duplicating process.

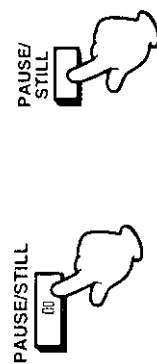

NOTE:

- It is recommended that you set the TAPE SPEED to the SP mode on the recording VCR for best results.
- After duplicating, disconnect the cables from the AUDIO/VIDEO IN jacks. If the cable remains plugged into the AUDIO and VIDEO IN jacks, you will not be able to record TV programs.
- Unauthorized recording of copyrighted television programs, films, video tapes and other materials may infringe on the rights of copyright owners and violate copyright laws.

VIDEO HEAD CLEANING

VIDEO HEAD CLOGGING

The video heads are the means by which the VCR reads pictures from the tape during playback. In the unlikely event that the heads become dirty enough to be clogged, no picture will be played back. This can easily be determined if, during playback of a known good tape, there is good sound, but no picture (picture is extremely snowy). If this is the case, have the video cassette recorder checked by qualified service personnel.



Good Picture



Snowy Picture

AUTO HEAD CLEANING

The AUTO HEAD CLEANING system cleans the video heads automatically when a cassette is inserted or ejected to prevent dirt from accumulating on the heads. However, manual head cleaning is needed if the picture on playback is still unclear although the picture on program is normal. This failure signifies that the head is getting dirty and occurs when playing poor quality or damaged tapes. If the heads require cleaning, use a high quality head cleaning system or have them cleaned professionally.

DO NOT ATTEMPT TO CLEAN THE VIDEO HEADS OR SERVICE THE UNIT BY REMOVING THE TOP COVER.

NOTE:

- Video heads may eventually wear out and should be replaced when they fail to produce clear pictures.
- To help prevent video head clogging, use only good quality VHS tapes. Discard worn out tapes.

VIDEO GLOSSARY

This video glossary is provided to help you become familiar with video terms, equipment and accessories you may encounter or require in the future.

A/B SWITCH - A device that allows you to select from two video sources for output to your VCR or TV. (Not included)



A/B SWITCH

ANTENNA ADAPTER or ANTENNA MATCHING UNIT - See matching transformer.

BALUN - See matching transformer.

BANDS - Groups of TV channels which fall within certain frequencies.

All the channels your TV/VCR receives can be tuned on one of three bands:

V₁ - VHF channels 2-6 and cable A-5-A-3

V₂ - VHF channels 7-13 and cable A-2-A-1, A-1, J-W and AA-FFF

U - UHF channels 14-69 and cable GGG-125

CATV - Cable TV, a method of transmitting TV signals through cable. This usually involves a monthly service charge. CATV is usually transmitted by one of three systems: HRC, IRC or STD.

COAXIAL CABLE (75 ohm) - A special type of round wire used for antenna or cable systems, or for connecting a VCR to a TV.



COAXIAL CABLE WITH
THREADED F CONNECTOR



COMBINER (or COUPLER) - A device used to combine two or more incoming antenna wires or cables into a single output (not included).

CONVERTER BOX/DESCRAMBLER - A device supplied by cable companies for receiving or descrambling cable signals. Often used for TV sets that cannot receive cable channels, or when pay stations are desired by the customer (not included).



A CONVERTER/
DESCRAMBLER

DIGITAL - Special circuitry using microchips to store images enables a VCR to perform viewing effects like strobe, and high quality still picture.

DIGITAL AUTO TRACKING - Automatically adjusts the playback tracking for the best possible picture.

DUBBING - A method of recording from one video cassette tape to another by connecting a VCR with another VCR, VCP or camcorder.

FS TUNER - A quartz-locked, frequency synthesized tuning system that electronically locks in stations for optimal reception. Eliminates the need for presetting channels into the TV/VCR.



F CONNECTOR JACK

F-TYPE CONNECTOR JACK - A threaded input jack designed to accept coaxial cable (75 ohm) using either a 'push-on' or 'screw-on' F connector.

FULL LOADING TAPE TRANSPORT - Keeps video cassette tape fully loaded in VCR for rapid access between modes.

H.Q. - High Quality picture. Special circuitry designed to improve VHS picture quality. Includes 'white clip expansion' and one or more additional special circuits.

REAL TIME COUNTER - A real time counter that displays the elapsed time during recording or playback in hours, minutes and seconds. The counter does not function on nonrecorded (blank) sections of tape.

MATCHING TRANSFORMER - An adapter used to convert 75 ohm cable to 300 ohm twin lead wire, or 300 ohm to 75 ohm.



2 TYPES OF MATCHING
TRANSFORMERS

MTS - Multichannel TV Sound. A stereo broadcast sound system used for transmitting stereo sound signals on TV, usually broadcast with another channel (SAP).

PRESET - A method of programming channels and channel numbers into the memory of the VCR.

PUSH ON CONNECTOR - Made to fit over an F connector jack without threading. Many matching transformers use push on connectors.

RF CONVERTER - A device built into VCRs and converter/descramblers which converts all signals into the video channel (either 3 or 4) for viewing on a TV.

SAP-SEPARATE AUDIO PROGRAM - A third audio channel under the MTS system frequently used for bilingual broadcasts.

SPECIAL EFFECTS - Picture features available on some VCRs such as still frame, and picture search.

SPLITTER - A device used to divide an incoming antenna wire or coaxial cable into two or more wires or cables (not included).



TWO TYPES OF SPLITTERS

STROBE PLAYBACK - A special digital playback feature in which still frames are displayed in rapid succession for a strobe effect.

TWIN LEAD WIRE (300 ohm) - A two conductor flat wire used for connecting an antenna to a TV set or VCR.

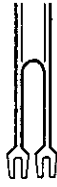

TWIN LEAD WIRE
WITH TERMINALS

UHF - Ultra High Frequency. The band of frequencies used for UHF channels 14-69. (Cable companies sometimes transmit UHF channels on other bands.)

VCP - Video cassette player. A device which can play video cassettes but cannot record.

VCR - Video cassette recorder. A device that can record and playback video cassettes.

VHF - Very High Frequency. The band of frequencies used to transmit VHF channels 2-13. Also used by cable companies to transmit their own channel.

VHS-C - A popular video cassette format used in many video camcorders. VHS-C cassettes can be loaded into a video cassette adapter which makes the tape fully compatible with the standard VHS format.

VHS - Video Home System. The video tape format most commonly used in the U.S.

VHS Hi-Fi - A superior method of recording stereo audio signals on video tape, resulting in very high quality audio recording.

VIDEO CHANNEL - The TV broadcast channel (usually 3 or 4) used to output signals from a VCR or cable box.

VIDEO INPUTS/OUTPUTS - RCA type jacks in back of the VCR used for dubbing or providing audio or video signals from other sources.



INPUT/OUTPUT JACKS

BEFORE REQUESTING SERVICE

Make sure by first checking the following points.

SYMPTOMS	CAUSE	POSSIBLE SOLUTIONS	PAGE
POWER			
No power.	The AC power cord is not connected.	Connect the AC power cord to the AC outlet.	9
Although the power is on, it does not operate.	Cassette is not inserted.	Insert a video cassette.	27
TV BROADCAST RECEPTION			
A TV program that is selected by the VCR does not appear on the screen.	Antenna connection is not correct.	Connect it correctly.	14
	Antenna cable is disconnected.	Reconnect the antenna cable.	14
	The video channel is not in the correct position.	Set it to CH 3 or 4.	23
	The TV is not set to the video channel 3 or 4.	Set the TV channel selector to the 3 or 4 position.	23
	The TV/VCR selector is set at TV mode. (The TV/VCR indicator is not lit.)	Press the TV/VCR selector button. (The TV/VCR indicator will light.)	23
A TV program selected by the VCR does not appear in color.	VIDEO/AUDIO in cables are connected to the VCR.	Remove cables.	22
	The TV/CATV selector switch setting.	Set the TV/CATV selector switch to select TV or CATV operation	14-21
RECORDING			
TV recording does not work.	The erase prevention tab of the video cassette is broken off.	Place a piece of vinyl tape over the gap.	34
	VIDEO/AUDIO in cables are connected to the VCR.	Remove cables.	22
Timer recording does not work.	The time is not set correctly.	Reset the present time.	26
	The recording start/end time is not set correctly.	Set the start/end time.	37
	The TIMER REC button has not been pressed (The T.REC indicator is not lit.)	Press the TIMER REC button. (The T.REC indicator will light.)	37

SYMPTOMS	CAUSE	POSSIBLE SOLUTIONS	PAGE
PLAYBACK			
No picture on screen when playing back a recorded tape.	The TV is not set to the video channel 3 or 4.	Set to the video channel 3 or 4 or adjust the fine tuning button on your TV set.	23
Noise bars on screen.	Tracking adjustment beyond range of automatic tracking circuit.	Adjust tracking manually using the TRACKING UP and DOWN buttons on remote control.	29
	Video heads are dirty.	Have the video heads cleaned.	41
	The tape is worn or damaged.	Try another tape.	-
REMOTE CONTROL			
Remote control does not work.	It is not aimed at the remote sensor.	Aim it at the remote sensor.	13
	Distance too far or too much light in the room.	Operate within 15 feet (5 meters) reduce the light in the room.	13
	There is an obstacle in the path of the beam.	Clear the path of the beam.	13
	The batteries are weak.	Replace the batteries.	13
TV programs cannot be seen using the TV selector.	The +, - polarity of the batteries are not inserted correctly.	Insert correctly.	13
	The TV/VCR function is in the VCR mode.	Set to TV, or turn off the VCR power button.	-

ORION®

FOR ADDITIONAL SET-UP OR OPERATING ASSISTANCE,
PLEASE CALL:
1-800-289-0980

FOR CUSTOMER SERVICE, PLEASE CALL OR WRITE TO:
ORION SALES, INC.
3471 NORTH UNION DRIVE
OLNEY, ILLINOIS 62450
Phone: (618) 392-7000

SPECIFICATIONS

Video Head:

4 Rotary Heads

Audio Track:

1 Track

Power Source:

120V, 60Hz

Power Consumption:

Approx. 16 watts

Tuner:

181 Channel Freq. Synthesized

VHF 2-13

UHF 14-69

CATV 14-36 (A)-(W)

37-59 (AA)-(WW)

60-85 (AAA)-(ZZZ)

86-94 (86)-(94)

95-99 (A-5)-(A-1)

100-125 (100)-(125)

01 (5A)

RF Channel Output:

Channel 3 or 4, Switchable

Inputs/Outputs:

Video: In (RCA) 1Vp-p 75 ohm

Out (RCA) 1Vp-p 75 ohm

Audio: In (RCA)-8dB/50K ohm

Out (RCA)-6dB/1K ohm

Antenna: VHF/UHF IN 75 ohm coaxial

VHF/UHF OUT 75 ohm coaxial

F. FWD/REW Time:

Approx. 2 minutes 30 seconds
(with T-120 Cassette Tape)

Speed Search:

SP - 3 & 5 X Normal Speed

LP - 7 & 9 X Normal Speed

SLP - 9 & 15 X Normal Speed

Dimensions:

13-15/16" W X 3-5/8" H X 10-13/16" D

Weight:

8.8 lbs

Supplied accessories

Remote Control (1)

75 ohm Coaxial Cable (1)

Specifications are subject to change without notice.

MEMO