

User Manual

Internet Radio



WR-230

Please read this user manual carefully before using the receiver.

Welcome

Thank you for purchasing Internet Radio. Your Internet Radios designed as a digital music radio to add to your existing Audio system and to provide you with hours of music enjoyment with simple, convenient access to thousands of Internet radio stations worldwide and furthermore music streaming options.

Table of contents

Welcome	1
Location of Controls	2
Remote control	3
Enter encryption code of the Wi-Fi router	4
Connect the radio with your Wi-Fi Router	6
Start using internet radio	7
My Favorite	7
Internet Radio	8
Media Centre	9
AUX-in	12
Alarm Setting	12
Snooze	13
Sleep Timer Seting	13
Configuration	13
Add your favorite URL	15
Music Streaming from mobile devices	16
Helpful Tips	17
Technical Specification	18

Location of Controls

Front

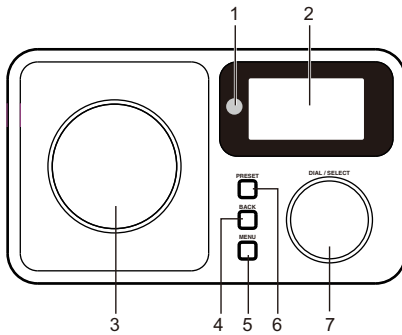

1. Remote sensor

2. LCD display

- On Standby mode, rotate the Tune/Select knob to adjust the brightness level or using the up/down key on remote control

3. Speaker

4. Back

- Back to previous menu

5. Menu

- Press to enter main menu

6. Preset

- Long press to add station to favourite;
- Short press to recall list of favorite stations

7. Dial/ Select control

- Rotate to up/down or volume control; push to select / confirm OK

8. Standby Should show icon only

- Press to turn on the radio/standby

9. Mode

- Switch between modes of Internet radio /UPnP/Aux-in, and press Dial/Select to confirm.

10. Local

- Quick access the local station in your country after setting up in Configuration

11. Right

- Right cursor
- Under Favorite list, press to enter the edit menu

12. Sleep

- Set the Sleep Timer

13. Left/EQ

- Left cursor
- When listening to music, press to access the EQ setting menu

14. Alarm/Snooze

- Set Alarm 1 and 2
- When alarm sounds, press to delay the alarm for 9 minutes

15. Aux-In jack

16. 3.5 mm Line out jack

17. 3.5 mm Earphone jack

18. DC jack 9V

Top

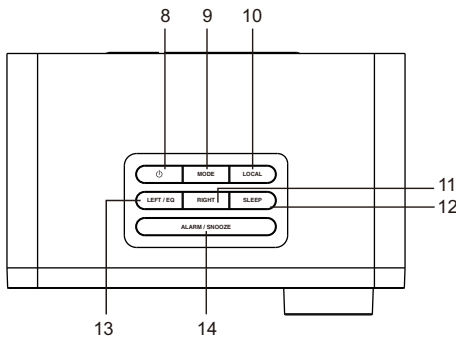

Back

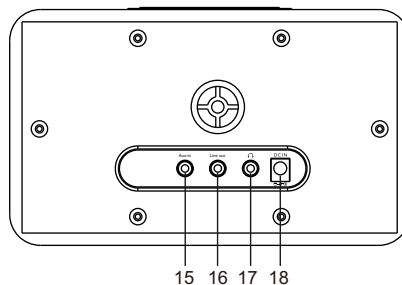

Remote Control

1. : Mute
2. **0-9**: Favorite station key / input letters and numbers for WiFi Encryption code
3. : Preset the current playing station to Favorite
4. : Cursor up
5. : Cursor left / back to previous menu
6. : Alarm button
7. : Sleep Timer
8. **Mode**: Switch between Internet radio/UPnP/Aux-in
9. : Main Menu
10. : Previous station on the list/previous track on UPnP
11. **Local**: Access the local station list (Local area set up in Configuration)
12. : Standby button
13. : Recall the favorite list
14. **OK**: confirm button
15. : Cursor right
16. : Cursor down
17. **Vol+**: Volume up
18. **Vol-**: Volume down
19. **EQ**: Equalizer
20. : Next station on the list/next track on UPnP
21. : Play/pause for internet radio
22. **Dimmer**: Access the Dimmer menu to adjust the brightness of the display
23. **Info**: Quick access to Network and System information

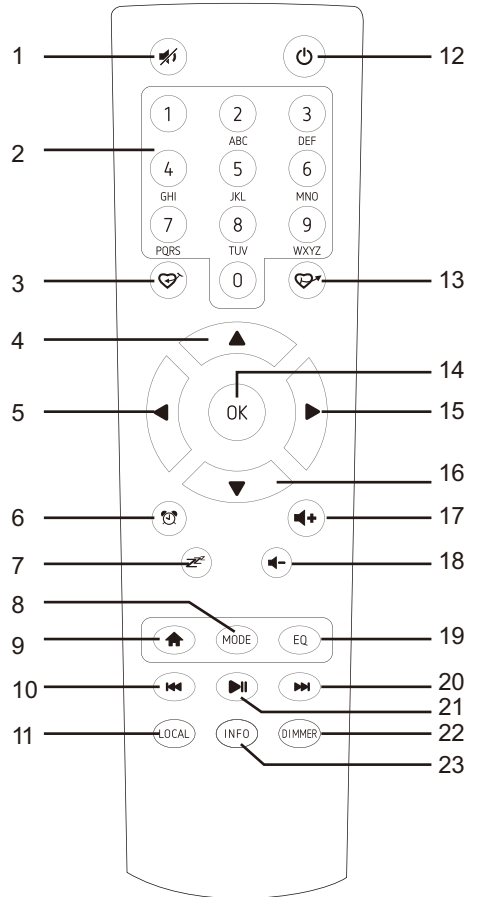

Enter encryption code of the Wi-Fi router

Using remote control

When you want to enter letters, numbers or symbols for the encryption code, using remote control would be easy to complete the job. Here is the definition of each key and toggle the same numeric key to cycling through different letters / symbol available. After each entry, press the right key to input the next. When it is done, press <OK > to confirm.

Key 1: 1 and different kind of symbols !@#\$%^&*()_+[]{};:"'\|,./<>?

Key 2: 2ABCabc

Key 3: 3DEFdef

Key 4: 4GHIghi

Key 5: 5JKLjkl

Key 6: 6MNOmno

Key 7: 7PQRSpqrs

Key 8: 8TUVtuv

Key 9: 9WXYZwxyz

Key 0: 0

Using buttons on the radio

Use the Dial control to scroll through the letters or symbols, press right key to input the next entry, press left key to delete the wrong entry. Push the knob when it is done.

Before you start

Please ensure the following is ready:

- You have a broadband internet connection.
- A wireless (Wi-Fi) broadband router (2.4GHz) is connected to the internet successfully.
The radio supports Wireless B, G and N connection (Wireless N router can also be used with the setting on B or G).
- You know the Wired Equivalent Privacy (WEP) or Wi-Fi Protected Access (WPA) data encryption code/password. You need to enter the correct code when the radio is connected to the wireless router for network connection.
If you do not know the code/password, please contact the person /technician who set up the router/network for you.
- The radio supports Wireless network connection (Wi-Fi connection).

Precautions

- The radio should not be used in a high temperature or high humidity environment over prolonged periods of time as this may damage the unit.
- Keep the radio away from liquids as it may get damaged. Please switch off the radio immediately if water or liquids is spilled into the radio. Consult with the shop you bought this radio for any question.
- Avoid using or storing the unit in dusty or sandy environment.
- Do not open and repair the radio by yourself.
- Use only the AC adaptor supplied with the radio.
Connecting a power supply with a different rating will cause permanent damage to the radio and may be hazardous.
- Clean only with dry cloth

WARNING: TO PREVENT FIRE OR ELECTRIC SHOCK HAZARD,
DO NOT EXPOSE THIS PRODUCT TO RAIN OR MOISTURE.



CAUTION: TO REDUCE THE RISK OF ELECTRIC SHOCK, DO NOT REMOVE THE RADIO BACK. NO USER SERVICEABLE PARTS INSIDE. REFER SERVICING TO QUALIFIED SERVICE PERSONNEL.



THE LIGHTNING FLASH AND ARROWHEAD WITHIN THE TRIANGLE IS A WARNING SIGN ALERTING YOU OF "DANGEROUS VOLTAGE" INSIDE THE RADIO.



THE EXCLAMATION POINT WITHIN THE TRIANGLE IS A WARNING SIGN ALERTING YOU OF IMPORTANT INSTRUCTIONS ACCOMPANYING THIS RADIO.

Connect the radio with your Wi-Fi Router

1. Use the AC adaptor supplied with the product, one end to the DC socket located at the rear side of the radio and the other end to the wall socket outlet.

Caution: Use only the adaptor supplied with the radio. Connecting a power supply with a different rating will cause permanent damage to the radio and may be hazardous.

2. The radio will power on and display as follow. Choose **<Yes>** to start configuring network.

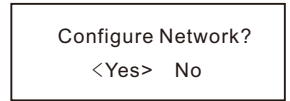
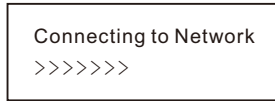

3. Select **<Add/Remove AP>** and **<Add AP>**:

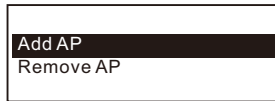
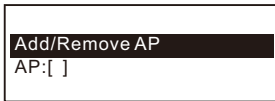

4. It will start scanning the available AP (Access points /Wi-Fi routers) nearby. Choose to connect your AP and enter the encryption code. Press 'OK' on remote, or **<Dial/Select>** on unit to confirm.

Remark: The encryption codes are case sensitive to upper and lower case.

5. When the Wi-Fi connection is done, the display shows:



 When this symbol appears, the radio is trying to connect to the Wi-Fi network

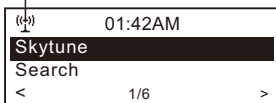

If you try to select Skytune when the Wi-Fi network is not connected, it will show the message below:

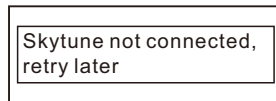

When the "No internet warning icon" appears, it means the Wifi connection is there but there is problem in the internet connection. Please check your internet connection if this icon appears.

After the Wi-Fi network is connected, you will see the Wi-Fi signal bar here.

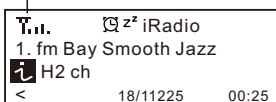

No internet warning icon

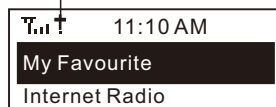

Start using internet radio

Press **<Menu>** to return to the main menu or press the  key on the remote control. You will see the item list below:

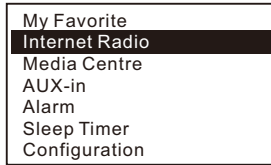

My Favorite - To show the list of favorite stations which have been assigned to the presets. There are up to 99 presets available.

Internet Radio - Start exploring the worldwide radio stations and music here

Media Centre - Music streams from the UPnP servers/ devices under the same Wi-Fi network

AUX-in - Play from other audio devices by connecting the audio cable.

Alarm - To set alarms

Sleep Timer - You can set the timer to turn the radio standby after certain time elapsed



Configuration - More settings available for you to configure the radio as you desire

My Favorite

This is to show the list of your Favorite stations which have been assigned to the presets.

■ Preset a station

The radio can store up to **99 preset stations** for each Internet radio and FM radio.

While you are playing a radio station, press the  button on the remote control or long press the **<PRESET>** key on the unit, you will see the  icon appears as below. It means the station is added to the Favorite list.

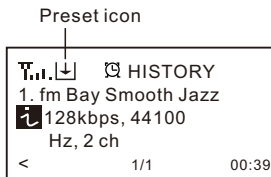

The new added stations will always appear in the last item on the Favorite list. You can store up to 99 presets

■ Recall a station

To recall the full list of your Favorite station, simply press the **<PRESET>** button on the radio or use the remote control button .

You can enter the Index number to quickly scroll to the radio station you want to listen. e.g., on the remote control, press 2 8 and **<OK>**, it will scroll to the station no. 28.

■ Edit your favorite list

On the Favorite list, choose the radio station you want to edit then press the right ► key on the remote control, or the <RIGHT> button on the radio. It will enter the Edit menu with the following options:

Move down – To move down the ranking of a station

Move up – To move up the ranking of a station

Delete – To delete a particular station

Internet Radio

On the main menu, choose <Internet Radio> and you will find the options below:

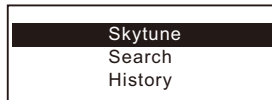

Skytune

Select Skytune to start enjoying thousands of radio stations over the world. You can filter your search by Region, Music genre and Talks. The <Local Radio> let you access quickly the stations available in your local area.

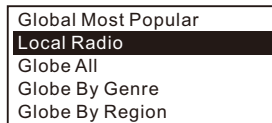

 You can change the Local Radio area under **Configuration> Local radio setup**.

Search

Instead of browsing the radio station list, you can access the desired station by performing search and input the name of the station.

History

The radio will memorize the stations you have listened on the radio. It can memorize up to 99 stations.

If you have listened more than 99 stations, it will supersede the first station that you have listened.

Media Centre

UPnP (Universal Plug and Play)

You can stream music from the Networked device which supports UPnP function to the radio to play.

For instance, most of the latest computer laptop supports UPnP, and you can stream music from Windows Media Player application on the computer and listen on your radio.



Please make sure your computer laptop is on the same Wi-Fi network as the Radio before you start using this function

1. If your PC is running Microsoft Windows XP, then you can use Windows Media Player 11(WMP11) to act as your UPnP (Universal Plug and Play) media server. (For Windows 7 or above, please download the correspond version of Windows Media Player). The latest Windows Media Player may be downloaded from Microsoft's website and install by following the instructions detailed in its installation wizard.
2. Once installed, Windows Media Player will create a library from all the media files available to it on your PC.

2.1 Windows XP / Windows Media 11

- 2.1.1 To add new media files to the library, select 'File > Add to Library...> Advanced Options', Click 'Add' and choose the files you wish to add and click 'OK'.
- 2.1.2 Now you need to connect your Internet radio to Windows Media Player 11 and configure it to allow the radio to access your media library. In order to this, you will need to do the following:
 - a. On the radio, go to the main menu and select <Media Centre> <UPnP>.
 - b. It will scan for all available UPnP servers. Note, this may take a few seconds for the radio to complete its scan and before the scan has completed, the radio will display '[Empty]'. The radio will continue to display '[Empty]' if no UPnP servers and found.
 - c. After a successful scan. Select your UPnP server, by rotating the dial if there is more than one UPnP server, and then press SELECT.
- 2.1.3 Your PC will now prompt you that a device has attempted to connect to your UPnP server. In order to allow the radio to have access to the media files, you will need to click the 'Library' tab from Windows Media Player 11 and select the <Media Sharing> item to open the 'Media Sharing' window.

Selecting 'Media Sharing...' for Windows Media Player11:



2.1.4 From the 'Media Sharing' windows, the radio will be listed as an unknown device. Click on the unknown device listed, then click the 'Allow' button and then click 'OK'. Allowing the Radio to Connect:

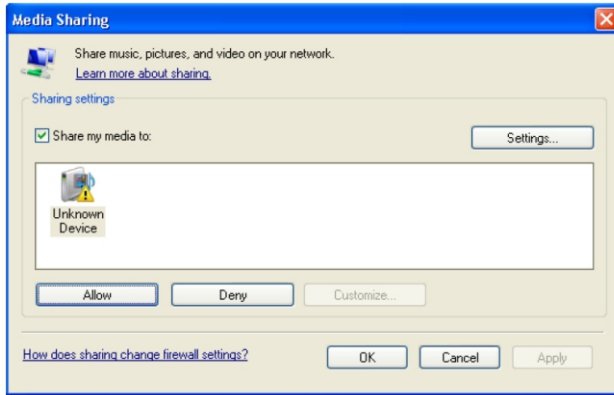

2.2 Windows 7 / Windows Media Player 12

2.2.1 If you are using WMP 12, simply go to <File> and choose <Open> to retrieve the music files you would like to add to library.

2.2.2 Windows 7 or above requires the PC to be set as **Home network** and also with the **Homegroup** enabled to allow devices to access/ play the media files on your Windows Media Player. Please find the steps below:

i) Go to <Control Panel>, select <Network and Internet>

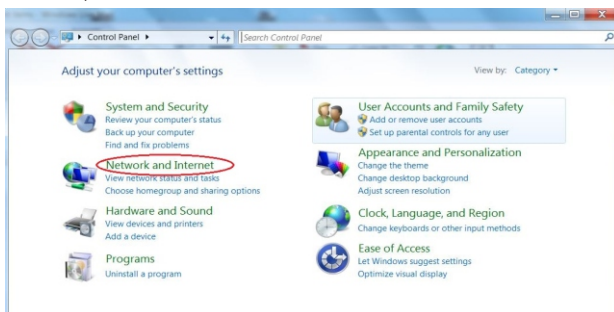

ii) Choose <HomeGroup>

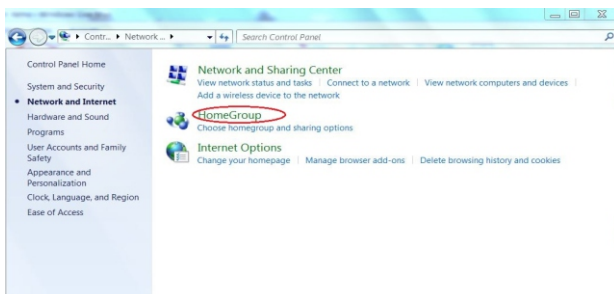

iii) Set the network location



iv) Choose Home network

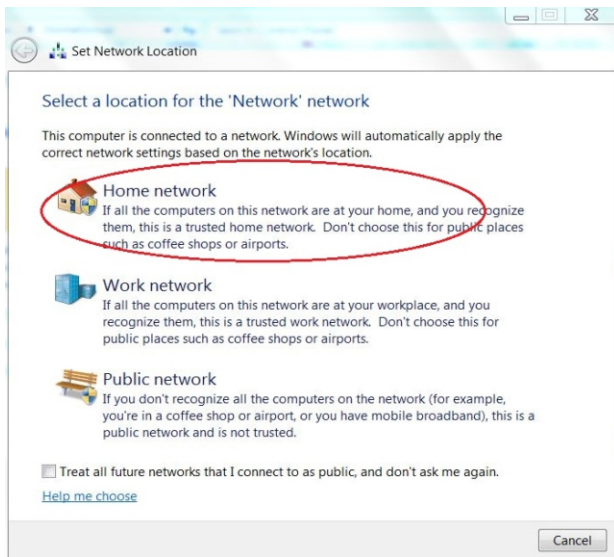

v) Create a homegroup, then choose the kind of media file to be accessed, such as music..etc.

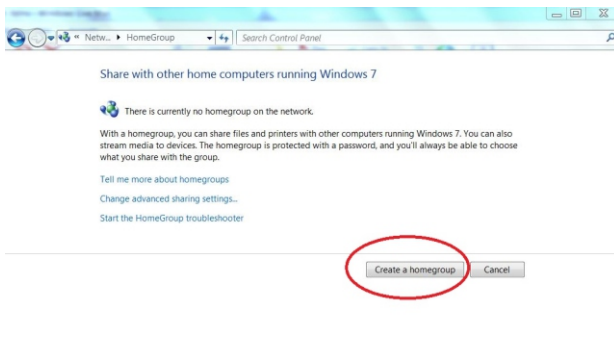

vi) Launch the Windows Media Player, select <Stream> and choose <Automatically allow devices to play my media> from the drop down list.

vii) You can now enjoy the music streaming from the windows media player.

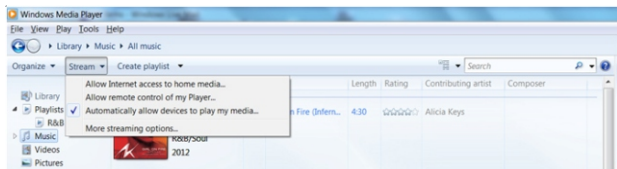

Music streaming via UPnP

1. Once the UPnP server is configured to share media files with your radio, you can start music streaming.
 2. On the main menu, select <Media Centre> and choose <UPnP>
 3. It may take a few seconds for the radio to complete the scan for available UPnP servers. If no UPnP servers are found, it will show <Empty List>.
 4. After a successful scan is done, select your UPnP server.
 5. The radio will show the media categories available from the UPnP server, e.g. 'Music', 'Playlists' etc.
 6. Choose the media files that you wish to play.
- You can set the mode of playback under <Configuration → Playback setup>.

My Playlist

You can make your own playlist for the UPnP music files. Choose the song you want to add to playlist, long pressing the Dial until the sign  appears. The song will be added to "My playlist". You can add up to 99 songs to "My Playlist".

The UPnP playlist will be erased when the radio is powered off.

Clear My Playlist

Remove all songs in "My Playlist" to allow a new playlist to be prepared.

AUX-in

You can enjoy the music from other audio devices by connecting the audio cable (with 3.5mm pin) to the AUX IN connector at the rear side of the unit, such as mobile phone, MP3 player, etc.

Alarm Setting

1. Choose <Alarm> from the main menu or press the <Alarm/Snooze> button on unit or press the <Alarm> button on the remote controller.
2. Select either Alarm 1 or Alarm 2, and choose <Turn on> to activate the Alarm.
3. Follow the alarm wizard instructions to set the alarm.

The wizard will guide you through the settings below:

Time – Set the time for the alarm

Sound – You can choose wake to <Melody> or Wake to <My Favourite> as the alarm source.

■ Wake to Melody- The Melody tone is default by system.

■ Wake to My Favourite – only stations on favourite list can be used to set alarm.

Please preset your favorite station before setting the alarm.

Repeat – You can schedule the alarm as you desire – Everyday, Once or multiple days.

Alarm Volume – Adjust the volume of the alarm as you like by rotating the dial.

4. After the above settings are completed, press the left ← button to exit and make sure the Alarm is turned on. You will see the Alarm icon  appeared on the display if it is activated.

Snooze

When the alarm sounds, the Snooze button will delay the alarm for 9 minutes every time the Snooze button is pressed.

To cancel the Snooze, long pressing the Alarm/Snooze button until the display shows the cancel dialogue box.

Sleep Timer Setting

You can set the timer to let the radio go standby after certain time elapsed in the range of 15 minutes to 180 minutes.

You can press <Sleep> button on the remote control to set the timer or press the <SLEEP> button on the unit. You will see the icon  appeared on the display if the timer is set.

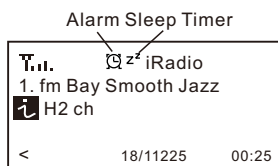

Configuration

Network

There are two options under this setting: Wi-Fi Network and Wi-Fi Channels

Wi-Fi Network

■Add / Remove AP

Add AP – It will scan out a list of routers available nearby

Remove AP – If you have already added a router and want to remove it, choose this option.

■AP: []

If you have added more than one routers on the radio and want to switch to another one, select this option to change.

■Signal

This is to show the strength of the Wi-Fi Signal of the Wi-Fi router as received by the radio.

Usually signal levels lower than -70dBm is at weaker level and if it affects the reception of your radio, you may need to optimize the router location or check any problem of the router itself.

■IP

The IP is set <Dynamic> by default. Select to change <Fixed> IP according to your network condition.

■DNS

The DNS is set <Dynamic> by default. Select to change <Fixed> DNS according to your network condition.

Wi-Fi Channels

Not all of the Wi-Fi channels are available in every country. There may be variation between different countries. Therefore it is necessary to choose the Wi-Fi channels to ensure the Wi-Fi performs satisfactory.

We have already set the channels according to the requirement in different countries. Choose the country you are staying from the list to get the correct channel.

The default country is set <Europe/United Kingdom>, press <Enter> on the Remote controller or push the <Dial> to edit the country selection.

Date and Time

You can easily set to your local time by choosing **<Set Time Zone>**. Choose your local area and the time will adjust to your local time automatically.

If you want the time to be synchronized with the network time, choose **<Use Network Time>** from the menu

You can set Date & Time manually, choose the date and time format under this option. Daylight saving setting is available.

 *If you choose to use Network time, the manual setting of Date and Time will be disabled.*

Language

English, French, Spanish, Italian, German and Simplified Chinese are available.

Local Radio Setup

This is to set the country of **<Local Radio>** that you want to access when you select **<Local Radio>**. When you press the **<Local>** on the remote control or choose **<Local Radio>** under "Skytune", it will give one-touch access the radio stations in the country that you have selected on this setting.

The **<Local Radio>** is set in **<Europe/United Kingdom>** by default. Select the **<Europe/United Kingdom>** and press **<OK>** to change the country you want.

Playback Setup

This is to set the mode of playback under UPnP streaming: Repeat All, Repeat Once or Shuffle.

DLNA Setup

Our radio supports streaming from DLNA devices and you can rename your radio for easy recognition by the DLNA servers.

Resume when Power on

This function is ON by default. The radio will connect to the last listened station automatically

when the radio is power on.

Dimmer

You can set the display backlight level as you prefer. There are two settings available: Mode and Level setting

Mode: Normal or Dim

Normal – the display will stay with the same level of brightness all the time without dim down.

Dim – the display will dim down after 15 seconds if no operation is made on the radio.

Level: Bright and Dim

Bright - the display will stay at the selected level when there is operation on the radio or if the mode is selected in <Normal> as described above.

Dim - the display will dim to the selected level when <Dim> mode is selected.

Dimmer on Standby

When the radio is on Standby, rotate the dial to adjust your prefer brightness level which you feel comfortable especially during night time.

EQ

The radio provides several choices of equalizers for you to apply to the type of music playing. There is **<Advanced>** level if you want to apply your customized setting on the sound effects.



The EQ does not apply to Aux-in playback.

Information

View the Network and System Information of your radio.

To access quickly to this information, press the **<Info>** button on the remote control.



When you use your PC to manage the My favorite stations, you have to use the IP address and you can view this info from here. Then type in the IP address (Configuration>Information>Network>IP) to your PC's browser input window

Software Update

There may be software release time to time to provide better features of the radio and continue improvement. Check the update regularly to keep your radio up to date with the latest software.

Reset to Default

You can do the reset to clear all the settings and return to default settings.

****Please note all the Station presets, Settings and configuration will be lost after you have performed the Reset.**

Add your favorite URL

You can add your favorite radio station if you know the published URL of the radio.

We provide an embedded server for your radio and you can manage your favorite stations anytime to add or edit the list. Follow the steps below to access the embedded server:

1. Connect your PC to the same Wi-Fi network as your radio.

2. Locate the IP address in either way as follow:

- Press the <Info> button on the remote controller, choose <Network> and scroll to <IP> to view the IP address
 - On the main menu, go to Configuration>Information> Network>IP
3. Open the web browser (we support Internet Explorer and Chrome) in your PC and type the IP address of the radio (e.g. 192.168.1.11). **Ensure your PC is on the same Wi-Fi network as the radio.** The screen will pop up as below:

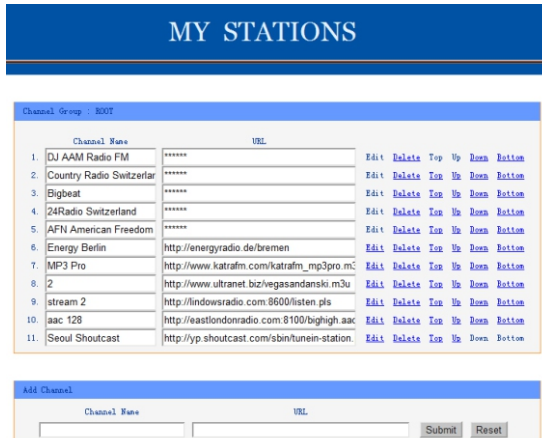

4. You can input the name and URL of a new radio station under the Add channel section, then click Submit. The new station will sync to the Favorite list of your radio immediately.

You can add up to 99 radio stations.

Music Streaming from mobile devices

The radio supports playing music streams from mobile device which use UPnP or iOS streaming.

Note: Ensure your mobile devices are on the same Wi-Fi network as the radio.

The radio will be discovered as the Speaker source with name <iRadio-xxxxx> on your mobile devices.

Choose the <iRadio-xxxxx> to be the speaker to play music; our radio will start playing the selected music from your mobile device.

When the radio is playing streams from the remote devices, below message will appear:

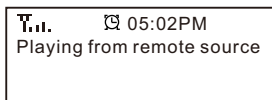

- ⚠ If you are using iOS devices and you want to switch back to listen the internet radio, remember to disable the <iRadio-xxxxx> as the speaker and resume the iOS device as the source of speaker.



1. If the Internet Radio keeps re-buffering radio station:

The Internet Radio is streaming the data from the radio station via your broadband connection, if there is a high error rate on your broadband connection, or the connection is intermittent, then it will cause the Internet Radio to pause until the connection is re-established and it has received enough data to start playing again.

If your Internet Radio keeps stopping, please check the DSL modem to ensure that the Broadband line is not suffering a high error rate or disconnections. If you are experiencing these problems, you will need to contact your broadband supplier.

2. What is Buffering?

When playing a stream, the Internet Radio/Media player, downloads a small amount of the stream before it starts playing. This is used to fill in any gaps in the stream that may occur if the internet or the wireless network is busy.

The Internet Radio streams music data from the PC while you are listening. If a stream gets blocked or experiences Internet congestion while transferring it may stop/interfere with the quality of play. If this happens, check your internet connection speed- it must be faster than the speed of the streams.

Technical Specification

Model: WR-232

Power input: 9V  0.8A

Power voltage: 100-240V~50/60Hz

Wireless Network: IEEE802.11b/g/n

Security Protocol: WEP/WPA/WPA2

Audio output power: 3W (RMS)

Audio sockets: 3.5mm earphone jack, 3.5mm Line-out jack, 3.5mm Aux-in jack.

Unit Dimension: 195 x 115 x 115 mm (L x D x H)

Remark: Specification may vary without notice

What's included in the box

- * Internet Radio
- * Power adaptor
- * Remote control
- * User manual

FCC Warning

This device complies with Part 15 of the FCC Rules. Operation is subject to the following two conditions:

(1) This device may not cause harmful interference, and (2) this device must accept any interference received, including interference that may cause undesired operation.

NOTE : Any changes or modifications to this unit not expressly approved by the party responsible for compliance could void the user's authority to operate the equipment.