



User Manual

Internet radio with bluetooth



WR-210CB

Please read this user manual carefully before using the receiver.

Location of Controls

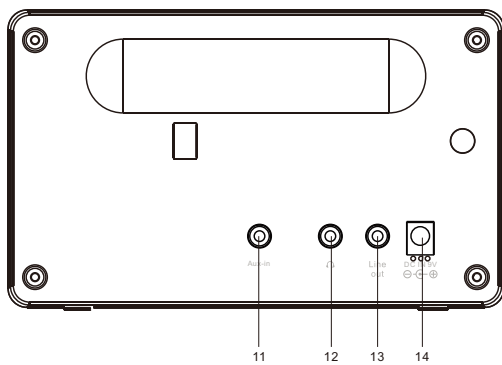
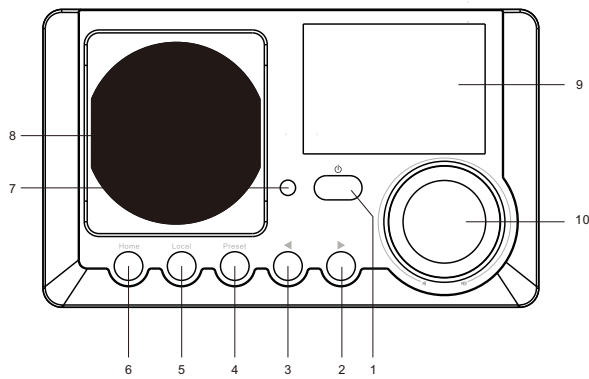

1. Standby button
2. Right button
3. Left / Back button
4. Preset button
5. Local button
6. Home
7. Infrared remote sensor
8. Speaker
9. TFT display 2.4"
10. Rotary control knob for
Volume/Dial/Select – Rotate
to adjust the volume/browsing
menu, press the knob to select
for confirmation
11. Aux-in jack
12. Earphone jack
13. Line out jack
14. DC IN jack

Remoter control

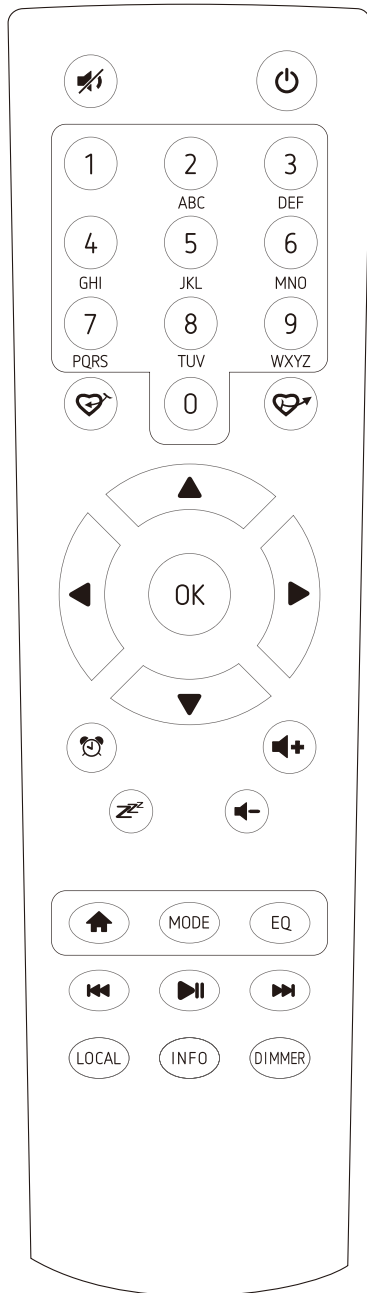

1. : Mute
2. : Standby button
3. **0-9**: Favorite station key / input letters and numbers for WiFi Encryption code
4. : Preset the current playing station to Favorite
5. : Recall the favorite list
6. : Cursor up
7. : Cursor left / back to previous menu
8. : Cursor right
9. : Cursor down
10. **OK**: confirm button
11. : Alarm button
12. : Sleep Timer
13. **Vol+**: Volume up
14. **Vol-**: Volume down
15. : Main Menu
16. **Mode**: Switch between the modes of radio
17. **EQ**: Equalizer
18. : Previous station on the list/previous track on UPnP
19. : Play/pause for internet radio
20. : Next station on the list/next track on UPnP
21. **Local**: Access the local station list (Local area set up in Configuration)
22. **Info**: View the detailed info of the radio channel or the music info under UPnP.
23. **Dimmer**: Dim down the backlight of display

Remote control character list

Key“0”—— 0,‘DEL’

Key“1”—— ‘1’->‘@’->‘ ’ (space) ->‘!’ ->“ (double quotes)

->‘#’->‘\$’->‘%’->‘&’->’ (single quotes) ->‘ (’

->‘)’ ->‘*’->‘+’->‘,’ ->‘-’->‘.’->‘/’->‘:’->‘;’->‘<’->‘=’->‘>’->‘?’-

>‘[’->‘\’->‘]’->‘^’->‘_’->‘`’->‘{’->‘|’->‘}’->‘~’

Key“2”—— 2,A,B,C,a,b,c

Key“3”—— 3,D,E,F,d,e,f

Key“4”—— 4,G,H,I,g,h,i

Key“5”—— 5,J,K,L,j,k,l

Key“6”—— 6,M,N,O,m,n,o

Key“7”—— 7,P,Q,R,S,p,q,r,s

Key“8”—— 8,T,U,V,t,u,v

Key“9”—— 9,W,X,Y,Z,w,x,y,z

Remark: press ‘→’ to move to next character and press ‘OK’ button to confirm.

You can also press ↑ ↓ to change the character /number, then press the right key to confirm the entry.

After you finish the entry, press the select button to confirm.

Switching on the radio

Connect the mains adaptor to the radio unit, one end to the DC IN on the radio and the other end to the AC mains wall socket.

Caution: Use only the mains adaptor supplied with the radio. Connecting a power supply with a different rating will cause permanent damage to the radio and may be hazardous.

The display on the front of the radio will light up and show:



Then you can select your prefer language on the radio.

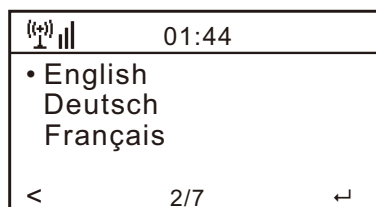

It will ask you if you want to Enable the **<Check Network when Power on>**, it is suggested to choose **<Yes>**. Then the radio will always check the available WiFi network automatically.

Connecting to your WiFi Network

The screen below will appear. You can choose **<Yes>** to proceed to search for the available WiFi network. If your router has the WPS function, you can select **<Yes(WPS)>** to proceed.

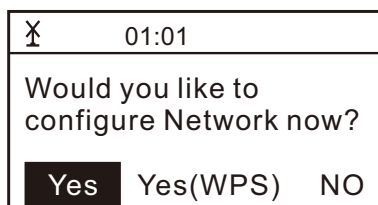

It will then start scanning the network. After the search is done, it will display a list of the available router.

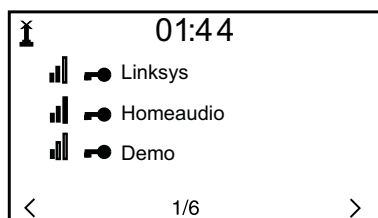

Choose your router from the list, enter the WEP (Wired Equivalent Privacy) or WPA(Wi-Fi Protected Access) code. If your network is not encrypted with the WEP or a WPA code, the unit will connect to the router automatically.

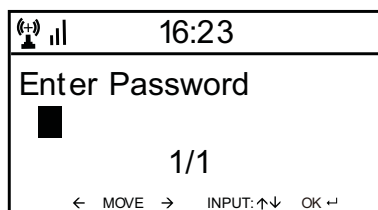

Note: The encryption code would have been set up by the person who set up and configured your network.

Please follow the steps below to enter the encryption code of your router.

- Rotate the rotary knob to browse the character
- Press the **→ right** button to skip to the next entry
- After you finish with the entries, press the Rotary knob to confirm.

The radio will start connecting to the network.

After the router is connected successfully, it will display the main menu as follow:

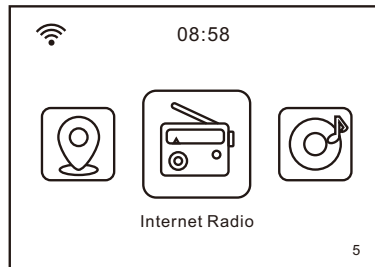

You can now start enjoying the internet radio.

Internet Radio

Choose **<Internet Radio>** from the menu, you can see several listed options.

To start listening the radio stations worldwide, select **<Radio Station/Music>**.

My Favorite

This is to show the list of your Favorite stations which have been assigned to the presets.

To preset a station:

While you are playing the favorite station, long pressing the **<Preset>** button and the **<Add to My Favorite>** menu will display. Press the rotary knob to confirm. The playing station will be added to the preset list automatically.

Press rotary knob to confirm

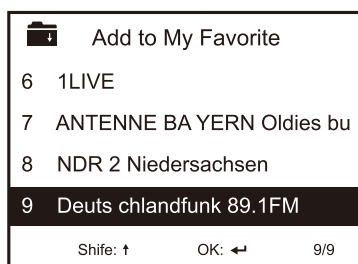

The symbol  on the top row means station is added to preset list

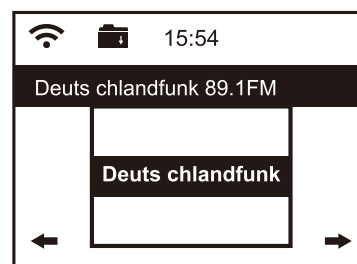

The presets will be stored in ascending order. You can store up to 250 presets.

Note: Preset 1 to 5 are reserved for your own choice of the dedicated radio channels. The preset will be intended to store from no. 6 onwards, you can scroll to choose no. 1-5 at your preference.

You can edit your favorite list anytime. Go to **<My Favourite>** on the menu or press the **<Preset>** button when it displays the list of favorite stations, then press the **-> right button**. The following options will display:

Delete – To delete the selected station

Shift up- To shift the selected station by one level up on the ranking
Shift down – To shift the selected station by one level down on the ranking
Rename – To rename the selected station
Play – press and play the selected station

Choose the radio station that you want to make with the above changes. Then press the Right key, it will enter into the list with the options listed above. Then choose your desire action.

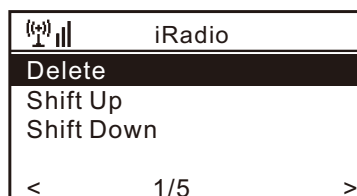

To recall a preset station:

Press the **<Preset>** button briefly and choose your desire station.

Radio Station / Music

Select this option, then you can select your desired radio station by Genre, Location., etc.

Local Radio

If you want to access quickly the radio station located in your area, select this function and it will display the list of the stations available in your area.

History

The radio will memorize the last 10 listened stations.

Service

Search Stations

You can find your desire radio station by entering the name of the radio.

Add New Radio Station

If you cannot find your desire station from the Radio station list and you have the streaming URL address, you can input the link here and add to your favorite list.

When the radio station is playing, the display will show a color image transmitted from the radio station.



Aux In

You can enjoy the music from other audio devices by connecting the audio cable to the AUX IN connector at the rear of the unit, such as smart phone, MP3 player, etc.

DLNA

The Internet radio can play music stream from DLNA compatible device, provided that the Internet radio and other DLNA devices are under the same Wi-Fi network.

The radio will be discovered as “AirMusic” when you try to search it on other devices. If you want to change other name from AirMusic, go to Configuration and DLNA setup to make the change.

Bluetooth

1. The radio can receive and play music streamed by other Bluetooth device.

Choose Bluetooth mode on the radio, it will be discoverable on other Bluetooth devices.

2. Turn on Bluetooth on your device and look up the device named “**WR-210**” from the list. Select it to start pairing.

3. If the connection is successful, it will show “**Connected**” on your Bluetooth device list.

4. You can start playing music from your Bluetooth device now.

Media Center

UPnP (Universal Plug and Play)

You can stream music from the Networked device which supports UPnP function to the radio to play.

For instance, most of the latest computer laptop supports UPnP, and you can stream music from Windows Media Player application on the computer and listen on your radio.

 ***Please make sure your computer laptop is on the same Wi-Fi network as the Radio before you start using this function***

1. If your PC is running Microsoft Windows XP, then you can use Windows Media Player 11(WMP11) to act as your UPnP (Universal Plug and Play) media server. (For Windows 7 or above, please download the correspond version of Windows Media Player). The latest Windows Media Player may be downloaded from Microsoft’s website and install by following the instructions detailed in its installation wizard.

2. Once installed, Windows Media Player will create a library from all the media files available to it on your PC.

2.1 Windows XP / Windows Media 11

2.1.1 To add new media files to the library, select 'File > Add to Library...> Advanced Options', Click 'Add' and choose the files you wish to add and click 'OK'.

2.1.2 Now you need to connect your Internet radio to Windows Media Player 11 and configure it to allow the radio to access your media library. In order to this, you will need to do the following:

a. On the radio, go to the main menu and select **<Media Centre>** **<UPnP>**.

b. It will scan for all available UPnP servers. Note, this may take a few seconds for the radio to complete its scan and before the scan has completed, the radio will display '[Empty]'. The radio will continue to display '[Empty]' if no UPnP servers and found.

c. After a successful scan. Select your UPnP server, by rotating the dial if there is more than one UPnP server, and then press SELECT.

2.1.3 Your PC will now prompt you that a device has attempted to connect to your UPnP server. In order to allow the radio to have access to the media files, you will need to click the 'Library' tab from Windows Media Player 11 and select the **<Media Sharing>** item to open the 'Media Sharing' window.



2.1.4 From the 'Media Sharing' windows, the radio will be listed as an unknown device. Click on the unknown device listed, then click the 'Allow' button and then click 'OK'. Allowing the Radio to Connect:

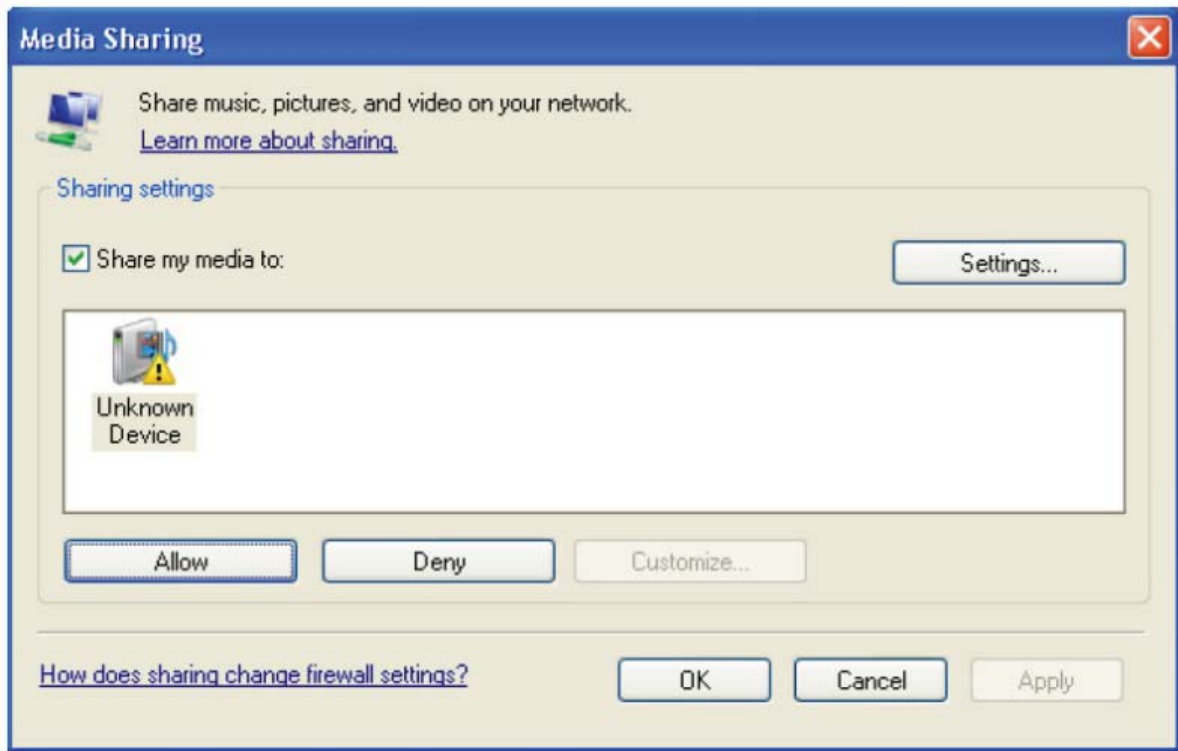

2.2 Windows 7 / Windows Media Player 12

2.2.1 If you are using WMP 12, simply go to **<File>** and choose **<Open>** to retrieve the music files you would like to add to library.

2.2.2 Windows 7 or above requires the PC to be set as **Home network** and also with the **Homegroup** enabled to allow devices to access/ play the media files on your Windows Media Player. Please find the steps below:

i) Go to **<Control Panel>**, select **<Network and Internet>**



ii) Choose **<HomeGroup>**

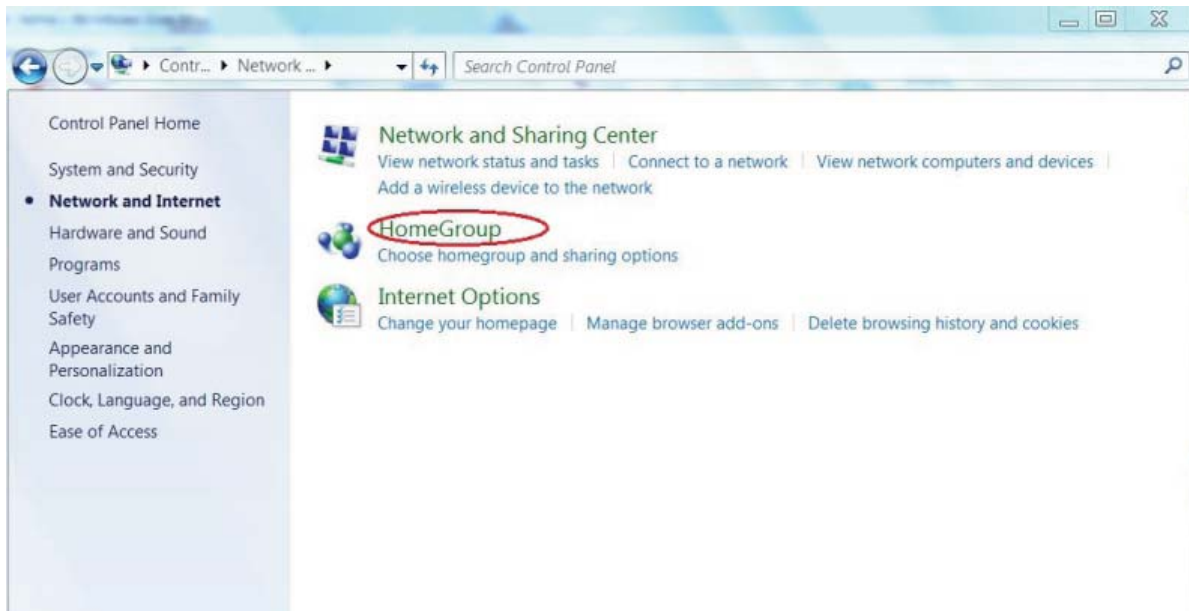

iii) Set the network location

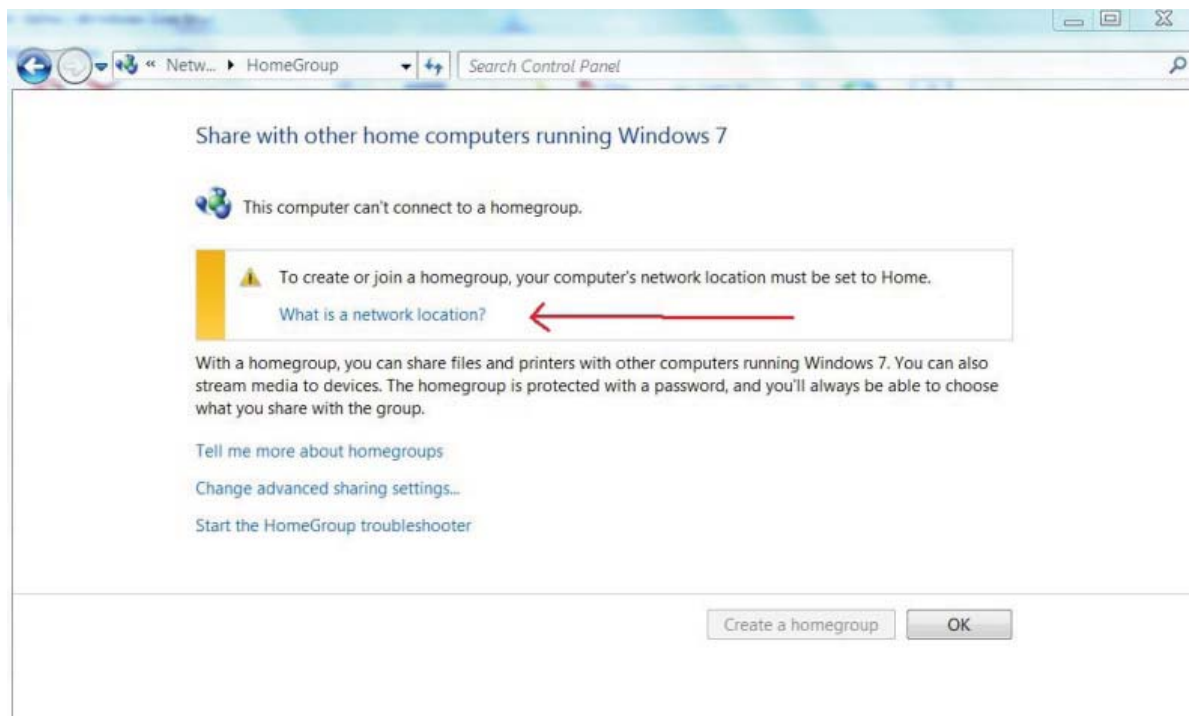

iv) Choose Home network

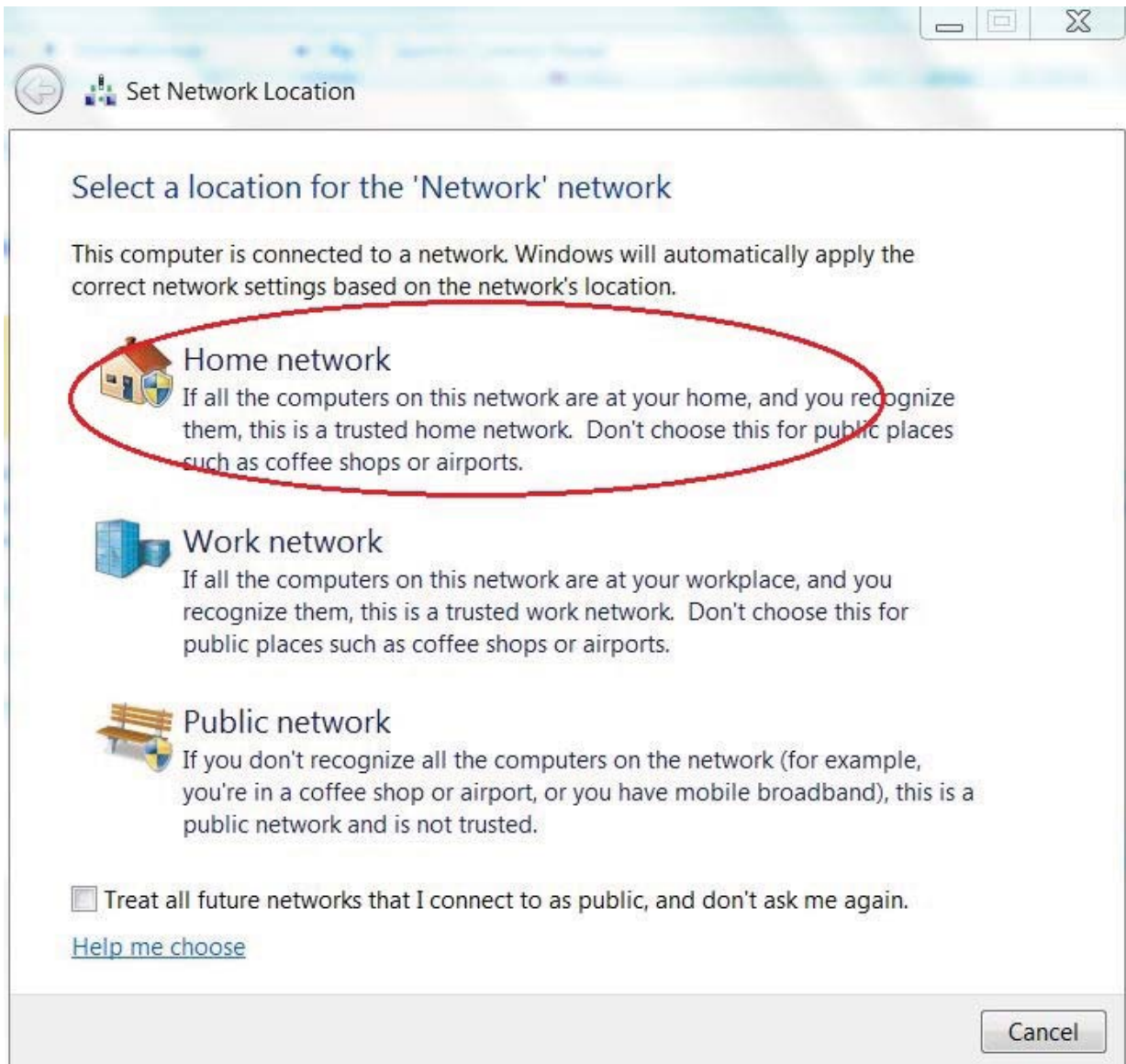

v) Create a homegroup, then choose the kind of media file to be accessed, such as music..etc.



vi) Launch the Windows Media Player, select **<Stream>** and choose **<Automatically allow devices to play my media>** from the drop down list.

vii) You can now enjoy the music streaming from the windows media player.

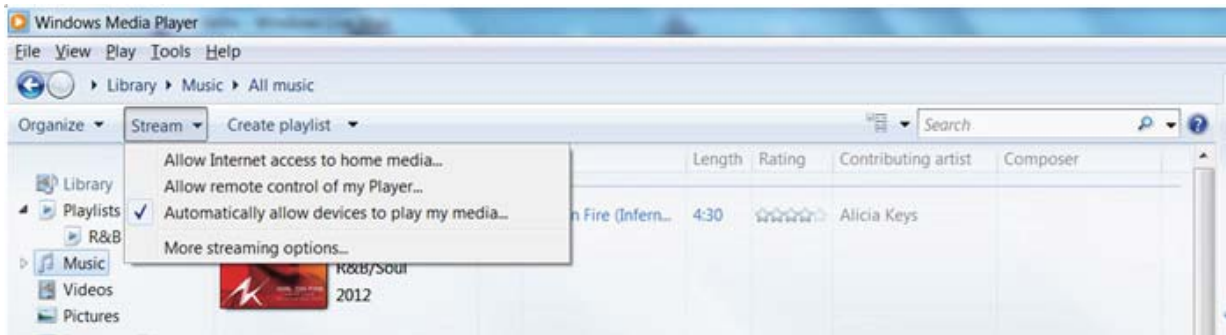

Music streaming via UPnP

1. Once the UPnP server is configured to share media files with your radio, you can start music streaming.
 2. On the main menu, select **<Media Centre>** and choose **<UPnP>**
 3. It may take a few seconds for the radio to complete the scan for available UPnP servers. If no UPnP servers are found, it will show **<Empty List>**.
 4. After a successful scan is done, select your UPnP server.
 5. The radio will show the media categories available from the UPnP server, e.g. 'Music', 'Playlists' etc.
- Choose the media files that you wish to play.

Information Center

Weather

The radio provides weather information in Standby mode. To enable this feature, follow the steps below:

Go to **Information Center> Weather Information**, choose the region you want it to display the weather information. After region is selected, keep pressing OK (press the rotary knob) until it shows **<Add to Standby Display>**, press the rotary knob to confirm.

The date/time and weather info will appear alternatively every 10 seconds under the standby mode.

In standby mode, press **→ right button** to see the real time weather information.

Press the **→ button** again will show the forecast for the next 4 days.

Continue to press the **→ button** will display the detailed weather information for each of the next 4 days. To view more details for a particular day, rotate the rotary knob to scroll down for more information.

Remark: The weather is just for reference only. It may have deviation to the actual weather.

System Information

You can view the information of the radio such as the Version of the software / Wlan Mac / IP address..etc.

Configuration

Manage my mediaU

You can tailor made your own favorite station list using your computer.

- 1) Go to <http://www.mediaU.net/> and sign up to become a member.
- 2) Then you have to find out the Mac Address to register on the Media U website.

To locate the MAC address, please follow the path below:

2a) Go to Main Menu and select **<Information Center>**

2b) Go to **<System Information>**

2c) Choose **<Wireless Info>** and you will find your Mac address.

- 3) Log-in Media U on your computer, click **My Media U > Radio**, then input the Radio name and Serial number (i.e. MAC Address) and save it.

The screenshot displays the 'my mediaU radio' configuration page. At the top, there is a search bar with the text 'Search station, genre / location / city / callsign...' and a 'Search' button. Below the search bar are three tabs: 'Genre', 'Location', and 'DAB'. The main navigation bar includes 'Home', 'my mediaU', 'Manage', and 'Radio'. The 'Radio' tab is selected. The page title is 'my mediaU radio'. A blue banner contains the text: 'By registering your radio that support 'my mediaU' function, You can :'. Below this are two numbered steps: '1. Organize favorite stations for your radios.' and '2. Manually add stations on your radios.'. A blue bar below the steps contains the text: 'Add radio (PC and mobile phone users not required)'. The form has two input fields: 'Radio Name' with the placeholder text 'Name your radio here.' and 'Serial Number' with the placeholder text 'Enter radio's access code here.'. To the right of the 'Serial Number' field is a link with an information icon: 'Where and how to get serial number.'. A blue 'Save' button is located at the bottom of the form.

You can then organize your own favorite stations or add any new station which is currently not found on the station list. Once the changes are done, your radio will synchronize the changes immediately and you will find your favorite list under **<My MediaU>** on the radio menu.

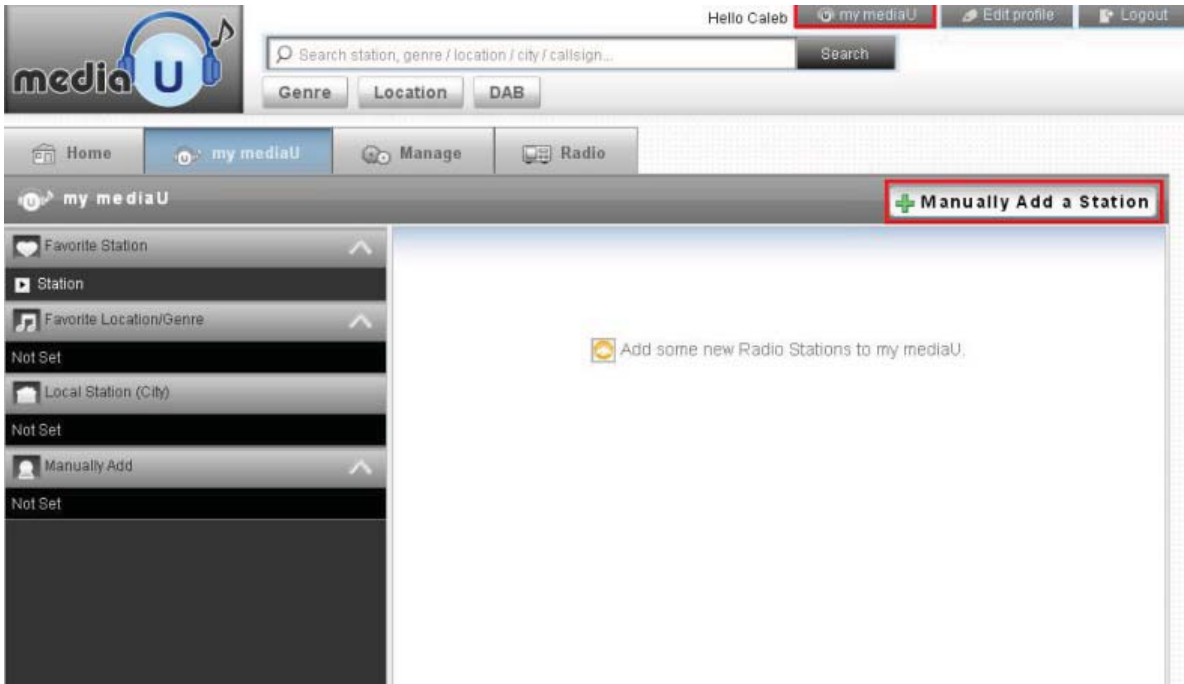

Note: If you are going to add URL which is not on Media U database, ensure the URL is a streaming URL or contact Media U to add it for you.

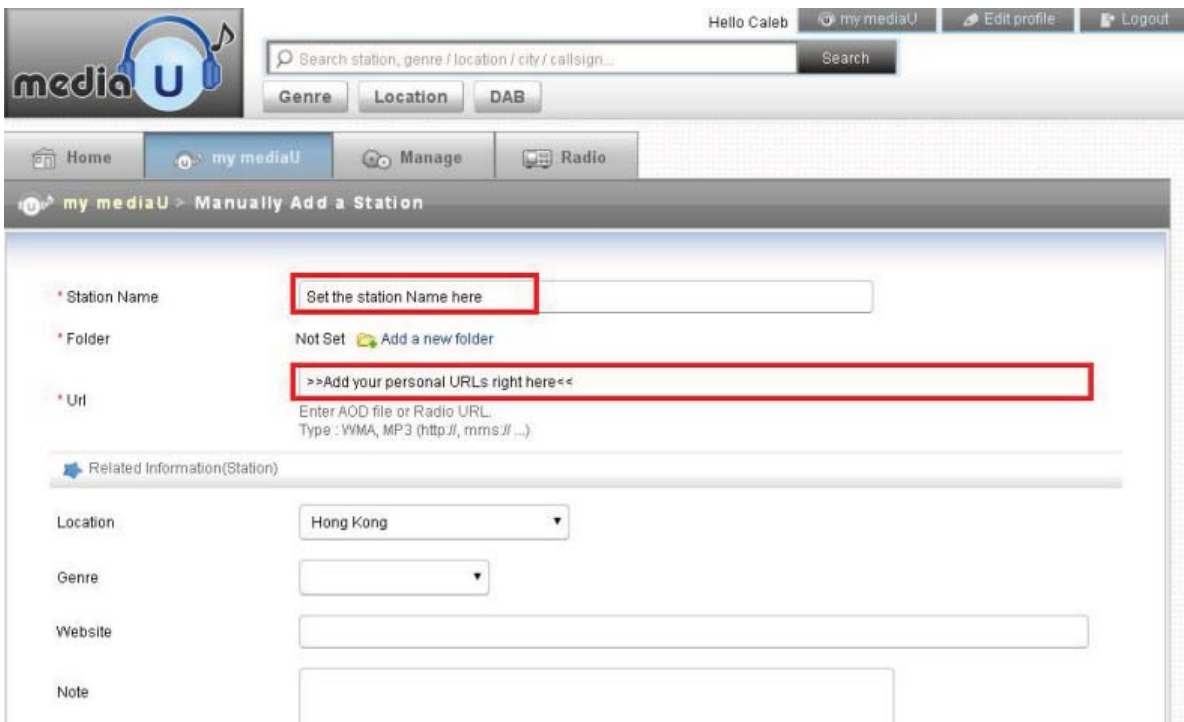

It allows maximum 5 users to register with the same radio and you can switch to listen the favorite list under one user at a time

To find your added station / custom favorite list on the radio, go to **Configuration > Manage my mediaU > Enable**
Then go to main menu and choose **<My Media U>**.

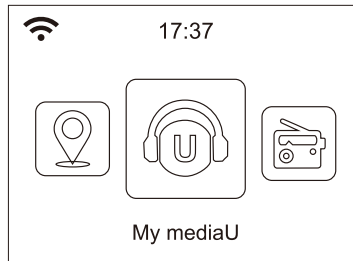

You will find listed options with your favorite list.

Whenever any update is done on **your <My Media U> account**, you have to disable the My Media U and enable it again to refresh and get the latest updated list. **(Configuration> Manage my mediaU > Disable>Enable)**

Network

Wireless Network Configuration

Press **<Enter>** to scan for wireless network list.

Wireless Network (WPS PBC)

The WPS allows to connect the radio with your router by pressing one key on the radio and a WPS key on your router for wifi connection, provided that your router has the WPS function.

Manual Configuration

You can set the DHCP on or off, and enter the SSID name, or delete the connected SSID.

Check network when power on

This is set to enable or disable **<Check network when power on>**.

Date & Time

The time is set automatically to your local area.

You can choose to manual set the time if you want.

Time Format setting

Time format setting: 12hours / 24hours

Date Format setting

Date format: YYYY/MM/DD, DD/MM/YYYY and MM/DD/YYYY

If manual setup is selected, you will see an added item **Daylight Saving Time(DST)** setting appeared on the list.

Alarm

Dual alarm clock

There are 2 alarm clocks available and settings as follow:

Scheduling alarm: You can schedule the alarm repeated for every day, particular day in the week or just once.

Alarm sound: Wake to Radio (must be the preset station), Wake to Melody and Wake to Beeping sound.

Alarm Volume: adjust your desire volume level.

NAP Alarm

If you would like to take a nap or need an alarm to due in short time, you can use this function.

You can select the time from 5 minutes up to 120 minutes. No Snooze function available for the NAP alarm.

Remark: The NAP Alarm will only release beeping sound.

Snooze

When the Alarm sounds, press any key except **<Power>** button will enter into **<Snooze>** mode. The alarm will come on again 5 minutes later. You can always press **<Power>** button to cancel the alarm.

Remark: In case there is network issue renders the wake to radio not working, it will auto release beeping sound after 1 minute.

Language

There are 17 Languages available, such as English, German, French, Norwegian, Italiano, Svenska, Dansk and others.

Dimmer

You can adjust the backlight of the LCD with below settings:

Power Saving

You can set the backlight to dim down when there is no operation for a certain time of period.

Turn on

You can adjust the backlight level for the operation mode, i.e. when you are operating the radio or checking on the menu.

Display

You can choose the display in color or monochrome style.

Power Management

This function is to allow the radio to go to Standby if there is no internet signal received in order to save power. The default setting is 30 minutes. When the radio does not receive any internet signal, the radio will go into Standby after 30 minutes. Other time frame for 5 minutes and 15 minutes are available.

Sleep Timer

You can set the timer to put the radio in standby after certain time

elapsed, from 15 minutes to 180 minutes with the step of every 15 minute. You also can do the setting with the **<Sleep>** button from remote control, when you press **<Sleep>**, then you can see the sleep timer on the top right corner of the display.

Buffer

Sometimes you may experience uneven playback of the internet radio. This can happen if the internet connection is slow or network congestion occurs. To help improving the situation, you can choose longer buffer time to get a few seconds of radio stream before beginning to play. The default value is 2 seconds. You can choose 4 or 8 seconds if you prefer to have a longer buffering time.

Weather

You can set to display the weather information in standby mode by choosing different regions and the temperature unit.

Local Radio Setup

The radio will detect your local area stations automatically and simply press the **<Local>** on the radio to access the radio stations in your local area. You can find it under the **<Internet radio>** menu too.

If you would like to change the Local area stations to other countries, you can choose “Manual setup” to make the change.

Playback Setup

This is to set the preference of UPnP playback. You can set the playback as Off, Repeat one, Repeat all, Shuffle.

DLNA Setup

The radio can play music from DLNA compatible devices which connected to the same wifi network as the radio. The radio will be discovered by the DLNA devices with the name as “AirMusic”. This is the name by default. You can change other name here as you desire.

Remark: The DLNA feature is compatible and works with corresponding 3rd party Apps on Android platform. Apple devices are not supported.

Equalizer

Select your prefer music styles.

Resume When Power On

The radio will resume playing the last listened station when you power it on next time if ON is selected in this option. The ON is set by default.

Software update

Upgrade information will pop up on the display when there is update version available.

It is suggested to check if there is latest software available from time to time.

Reset to default

You can do this factory reset to empty all of the settings and it comes back to default settings.

*****Please note all the Station presets, Settings and configuration will be lost after you have performed the “Factory Reset”.***

Trouble Shooting

1. If you have trouble connecting the radio to your wireless network, these steps may help to resolve the problem:

- Confirm that a Wi-Fi or Ethernet Wired connected PC can access the internet (i.e. can browse the web) using the same network.
- Check that a DHCP server is available, or that you have configured a static IP address on the radio.
- Check that you firewall is not blocking any outgoing ports.
- Some access points may be set so that only equipment with registered MAC addresses can connect to them. This is one possible cause of the Internet Radio being unable to connect to the Wi-Fi network, and the Internet Radio display will show Bad ESSID or key. To overcome this problem you will need to add the Internet Radio's MAC address to the list of allowed equipment in your access point. The Internet Radio's MAC address can be found using the menu **Information Center > System Information > Wireless Info > MAC address**. You will need to refer to the guide for you Access Point in order to enter the Internet Radio as an allowed piece of equipment.
- If you have an encrypted network, check that you have entered the correct key or passphrase into the radio. Remember that text-format keys are case sensitive.
- If your wireless network name(ESSID) is 'Hidden'(a setting on the wireless access point), then you can either turn on the name, or you can manually enter the name into the internet radio and media player, Select <Configure -> Network -> Manual Configuration-> Wireless -> Enter ESSID>. Confirm if the Network is encrypted, e.g. requires a WEP or WPA key, then enter the network name.

2. If your radio can connect to the network successfully, but is unable to play particular stations, it may be due to one of the following reasons:

- The station is not broadcasting at this time of the day (remember it may be located in a different time zone).

- The station has too many people trying to attach to the radio station server and the server capacity is not large enough.
- The station has reached the maximum allowed number of simultaneous listeners.
- The station is not broadcasting anymore.
- The link on the radio is out of date. This is updated automatically every day, so the next time you turn on the link will be recognised. In case it is still not updated, please contact MediaU for the update
<http://www.mediayou.net/web/index.php>
- The internet connection between the server (often located in a different country) and yours is slow. Some internet service providers may fail to stream in certain geographical areas. Try using a PC to play back the stream via the broadcaster's web site. If you can play back the station with a PC, please report to the customer service where you bought this radio. If you have a laptop, try connecting it if your Internet Radio cannot find the station.

3. When you scan for PCs under UPnP function, none can be found, or the PC you are looking for does not appear in the list:

- You have not connected to the wireless Access point. On the internet radio, select 'Configuration', 'Network', 'Wireless network connection' and then select your Wireless network. (You may need to enter a security key to access the network wirelessly).
- You have a firewall set on your PC which is stopping you accessing shared files.
- If you have a third party firewall (Like Norton, or Zone Alarm) that will have its own control panel and you will need to consult the manual for your firewall.
- If your PC is connected to a managed network, with a server sometimes the PC being searched for needs to be set to Home group. See the instructions under Media Center.

4. You can see the PC you want to play music from, but cannot find any folders on the PC:

- You have a firewall running which is preventing the internet radio from seeing the shared folder. As a quick check, you can disable firewalls like Norton to see if this overcomes the problem, if this resolves the issue then you can either leave the firewall off, or allow file sharing through the fire wall.

Note: If you firewall is required to provide security for your system, it should not be left off.

5. I can't share a folder , as the option is not highlighted:

The share folder option will not be available until you have turned simple file sharing on. Run the wizard.

Scan Error:

When the internet radio is scanning the content of the folders on a PC, it is possible that a scan error may occur if the windows file sharing application times out. This is most likely to occur if both the PC with the media content and the Internet Radio are connected wirelessly.

Try re-connecting the PC with the media content into the network via cable. This will dramatically increase the speed at which the Internet Radio is able to scan the content of the Media PC.

Playlists:

Some media ripping applications allow 'Playlists' to be created. The Internet Radio is able to detect and stream these playlists, but they must be stored in the folder with the rest of the Media content and they must have the file extension.m3u.

Windows Media player can create suitable playlist, just select 'create new playlist', drag and drop the tracks you want into the playlist, then use 'Save as' to ensure the file type is .m3u. (Existing play lists can be opened and re-saved in this format) When the Internet Radio detects you have playlists, it will enable a new menu option allowing the playlist to be selected and added to the queue.

If you re-connect to another PC of folder, which does not have any Playlists in the .m3u. format, the playlist option will not be presented in the menu.

6. If the Internet Radio keeps re-buffering radio station:

-The Internet Radio is streaming the data from the radio station via your broadband connection, if there is a high error rate on your broadband connection, or the connection is intermittent, then it will cause the Internet Radio to pause until the connection is re-established and it has received enough data to start playing again.

-If your Internet Radio keeps stopping, please check the DSL modem to ensure that the Broadband line is not suffering a high error rate or disconnections. If you are experiencing these problems, you will need to contact your broadband supplier.

7. What is Buffering?

When playing a stream, the Internet Radio/Media player, downloads a small amount of the stream before it starts playing. This is used to fill in any gaps in the stream that may occur if the internet or the wireless network is busy.

If a stream gets blocked or experiences Internet congestion while transferring it may stop/interfere with the quality of play. If this happens, check your internet connection speed- it must be faster than the speed of the streams.

Technical Specification

Model: WR-210CB

Power input: 9V $\overline{\text{=}}$ 800mA

Power voltage: 100-240V~50/60Hz

Wireless Network: IEEE802.11b/g/n

Security Protocol: WEP/WPA/WPA2

Audio output power: 2.5W (RMS)

Audio sockets: 3.5mm earphone jack, 3.5mm Aux-in jack, 3.5mm Line out jack

Unit Dimension: 164 x 98 x 98 mm (L x D x H)

Remark: Specification may vary without notice

What is included in the box

- * Internet Radio
- * Power adaptor
- * Remote control
- * User manual

WEEE and Recycling

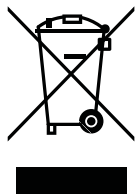

The European laws do not allow any more the disposal of old or defective electric or electronic devices with the household waste. Return your product to a municipal collection point for recycling to dispose of it. This system is financed by the industry and ensures environmentally responsible disposal and the recycling of valuable raw materials.

Ocean Digital Technology Ltd.
Flat B, 12/F., Yeung Yiu Chung (No.8) Ind. Bldg.,
20 Wang Hoi Road, Kowloon Bay,
Hong Kong
Email: support@oceandigital.com.hk

FCC Notice

This device complies with Part 15 of the FCC Rules. Operation is subject to the following two conditions:

(1) This device may not cause harmful interference, and (2) this device must accept any interference received, including interference that may cause undesired operation.

NOTE 1: This equipment has been tested and found to comply with the limits for a Class B digital device, pursuant to part 15 of the FCC Rules. These limits are designed to provide reasonable protection against harmful interference in a residential installation. This equipment generates, uses and can radiate radio frequency energy and, if not installed and used in accordance with the instructions, may cause harmful interference to radio communications. However, there is no guarantee that interference will not occur in a particular installation. If this equipment does cause harmful interference to radio or television reception, which can be determined by turning the equipment off and on, the user is encouraged to try to correct the interference by one or more of the following measures:

- Reorient or relocate the receiving antenna.
- Increase the separation between the equipment and receiver.
- Connect the equipment into an outlet on a circuit different from that to which the receiver is connected.
- Consult the dealer or an experienced radio/TV technician for help.

NOTE 2: Any changes or modifications to this unit not expressly approved by the party responsible for compliance could void the user's authority to operate the equipment.

FCC Radiation Exposure Statement:

This equipment complies with FCC radiation exposure limits set forth for an uncontrolled environment. This equipment should be installed and operated with minimum distance 20cm between the radiator & your body.