



APPENDIX G
: USER'S MANUAL

MFS-8 Network Switch

Installation Manual



MFS-8 Installation Manual ©2010 URC, Inc.

The information in this manual is copyright protected. No part of this manual may be copied or reproduced in any form without prior written consent from Universal Remote Control, Inc.

UNIVERSAL REMOTE CONTROL, INC. SHALL NOT BE LIABLE FOR OPERATIONAL, TECHNICAL OR EDITORIAL ERRORS/OMISSIONS MADE IN THIS MANUAL.

The information in this manual may be subject to change without prior notice.

All other brand or product names are trademarks or registered trademarks of their respective companies or organizations.



500 Mamaroneck Avenue, Harrison, NY 10528
Phone: (914) 835-4484 Fax: (914) 835-4532

TABLE OF CONTENTS

| | |
|--|----|
| Introduction | 1 |
| Features and Benefits | 1 |
| Parts Guide | 1 |
| Front and Rear Panel Descriptions | 2 |
| MFS-8 Installation Considerations | 4 |
| MFS-8 Installed in a Small System | 5 |
| MFS-8 Installed in a Large System | 6 |
| MFS-8 Installed in the area with the Network Distribution | 7 |
| Frequently Asked Questions | 8 |
| Specifications | 8 |
| USA Limited Warranty Statement | 9 |
| Federal Communication Commission Interference Statement | 10 |
| Regulatory Information to the user | 11 |
| Declaration of Conformity | 12 |

Introduction

The MFS-8 Network switch is the ideal "Plug-n-Play" solution to protect network WAP's (Wireless Access Points) from multicast audio streams.

Total Control products, like the DMS-1200 (Digital Multi-zone Amplifier), DMS-100 (Digital Single-Zone Digital Amplifier) and the SNP-1 (Streaming Network Player), all multicast audio streams onto the LAN. The nature of a "multicast" will shut down all wireless access to the network. The MFS-8 was specifically designed for use with Total Control Systems and incorporates **pre-configured MAC filtering**. MAC Filtering completely solves the issue by confining multicast streams to the switch itself, never allowing streams to affect network traffic in the rest of the house. Pre-configuration means you don't have to be a Network Engineer to configure this switch, simply plug your Total Control products into any port and you're ready to go. "Plug-n-Play" integration produces reliable, predictable network performance.

Warning: NEVER plug a WAP (Wireless Access Point) into the MFS-8, since URC multicast audio streams will shut down any brand or model of WAP.

Features

- ◆ Eight (8) ports plus one LAN port.
- ◆ Mac filtering prevents audio streams from consuming network bandwidth.
- ◆ Activity and Status LEDs plus Connectivity indicator.
- ◆ Includes 12 volt power supply.

Parts Guide

- 1 - MFS-8 MAC Filtering Switch
- 1 - 1.5M CAT5 Ethernet Cable
- 1 - 12V AC Power Adapter
- 1 - Wall Mount Plate and Four Mounting Screws
- 1 - Quick Install Guide

Front and Rear Panel Descriptions

Front Panel:

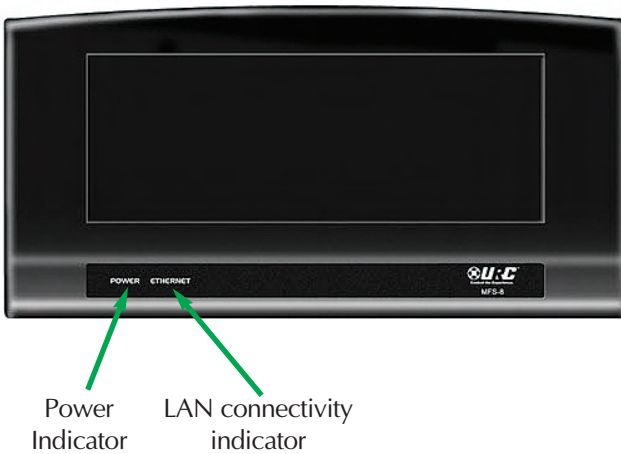

Power Indicator: Illuminates when the MFS-8 Power Supply is connected to AC outlet.

Ethernet Network Connectivity Indicator: Illuminates when the MFS-8 is connected to a LAN and has received an IP Address.

Rear Panel:

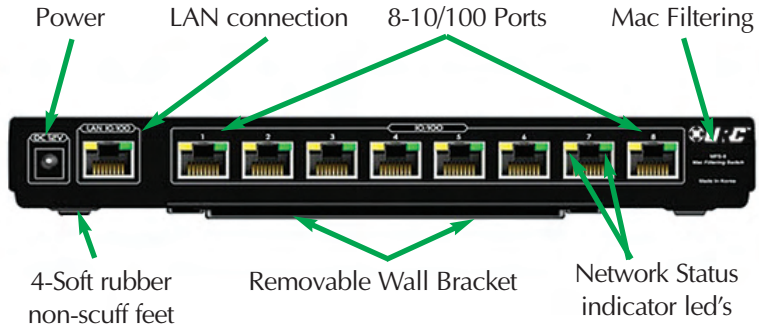

Power: Provides connection to Included 12V Power Supply.

LAN Connection: Provides connection to the LAN (Local Area Network).

10/100 Ports: 8 - 10/100 Ports provide network connectivity to Total Control streaming products like the DMS-1200, DMS-100 and SNP-1.

MAC Filtering: MAC Filtering prevents audio and video streams from consuming network bandwidth. Streams are confined to the switch, optimizing local area network performance.

Network Connectivity and Activity Status Indicators (port specific): Status indicator LEDs display network connectivity, and network traffic feedback, for easy troubleshooting.

Wall Mount Bracket: Convenient removable wall bracket allows the MFS-8 to be mounted to the back of a cabinet or rack. Remove the wall bracket when placing the MFS-8 on a shelf or stand.

MFS-8 Installation Considerations

Only one MAC Filtering switch should be used in a typical Total Control system. All streaming products like the DMS-1200, DMS-100 and SNP-1 must be connected to the switch.

You cannot daisy-chain MFS-8 MAC Filtering switches; communication between switches will be blocked. If you have more than eight of the above streaming components, simply connect a standard network switch to any port on the MFS-8 and then connect the additional components to the standard switch. This allows the additional components to benefit from the MFS-8's MAC Filtering, without affecting communication between devices.

Warning: NEVER plug a WAP (Wireless Access Point) into the MFS-8, it will not function correctly

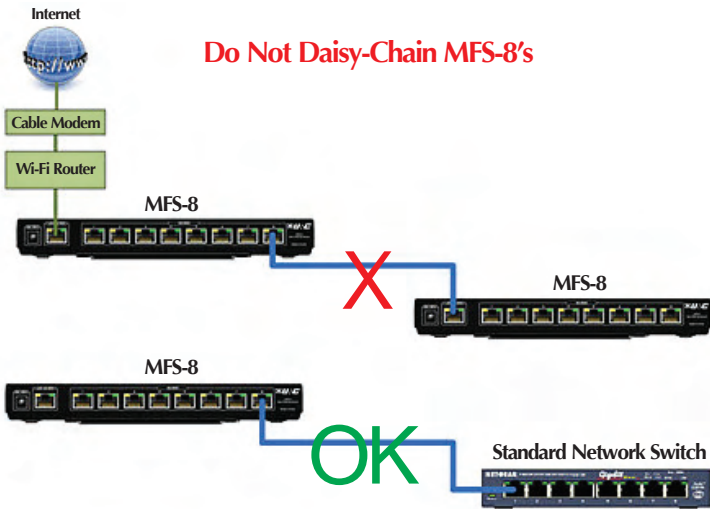

Installation

1. On the back of the MFS-8, connect one end of a CAT5 cable to the port labeled LAN 10/100.
2. Connect the other end of the CAT5 cable to the LAN(Local Area Network).
3. Connect Total Control and standard network devices to any of the eight 10/100 Smart Ports.
4. Connect the supplied 12V Power Supply to the MFS-8 and then plug it into an unswitched AC outlet.
5. Once powered up, the unit begins working in approximately 30 seconds.

MFS-8 Installed in a Small System

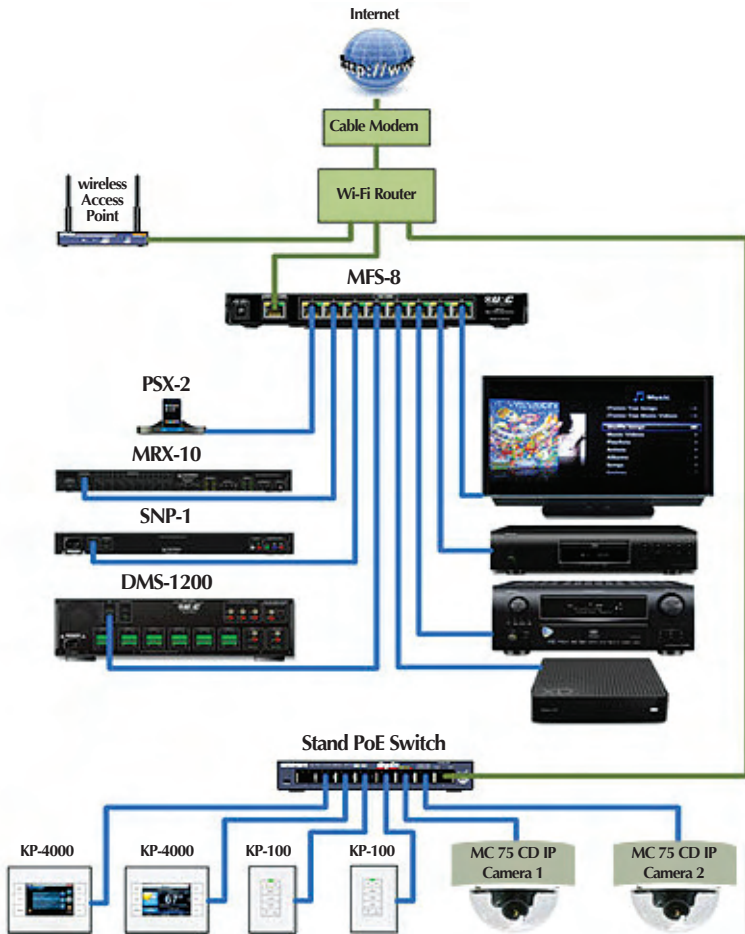

The Wireless Access Point CANNOT be connected to the MFS-8; it must be connected to the Router in the LAN.

MFS-8 Installed in a Large System

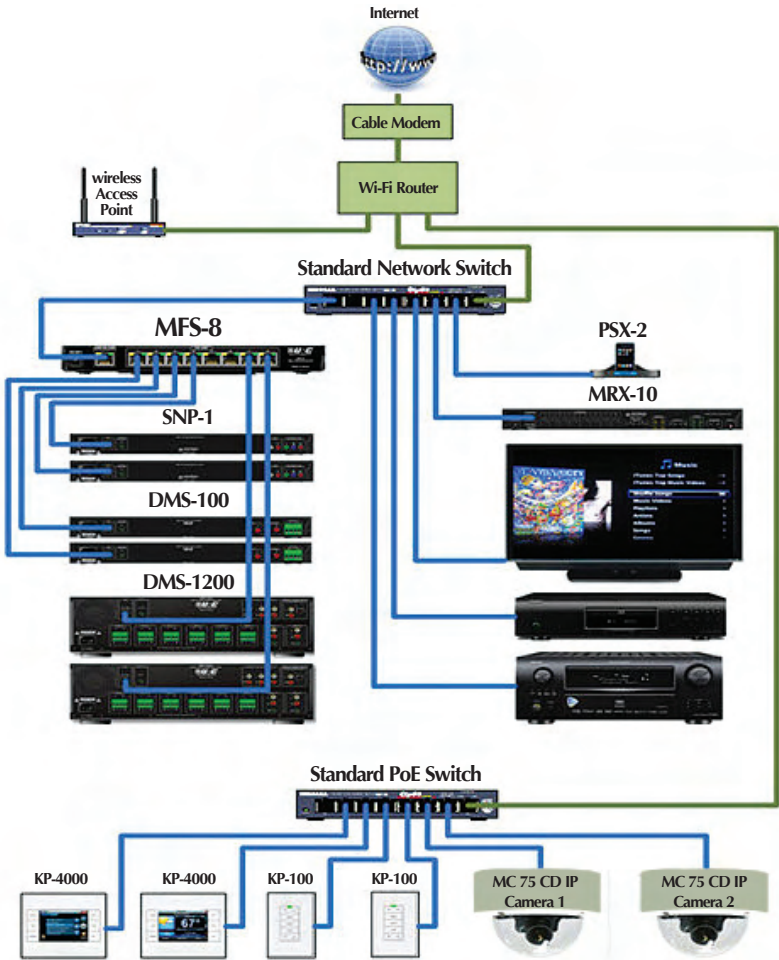

Notes:

- The Wireless Access Point CANNOT be connected to the MFS-8; it must be connected to the Router in the LAN (Local Area Network).
- A standard network switch is used to connect the MFS-8 to the LAN.
- A MRX-10 doesn't have to be connected to the MFS-8, but can be connected to a MFS-8 when convenient to do so.

MFS-8 Installed in the area with the Network Distribution

Occasionally you get a retrofit installation where only one CAT5 wire has been run to a room, and there's no way to run another one. In this case, locate the MFS-8 in the Utility Room, Garage, or where ever the central distribution point for the Network is located, and install standard network switches in rooms where you plan to locate a DMS-1200, DMS-1200 or SNP-1.

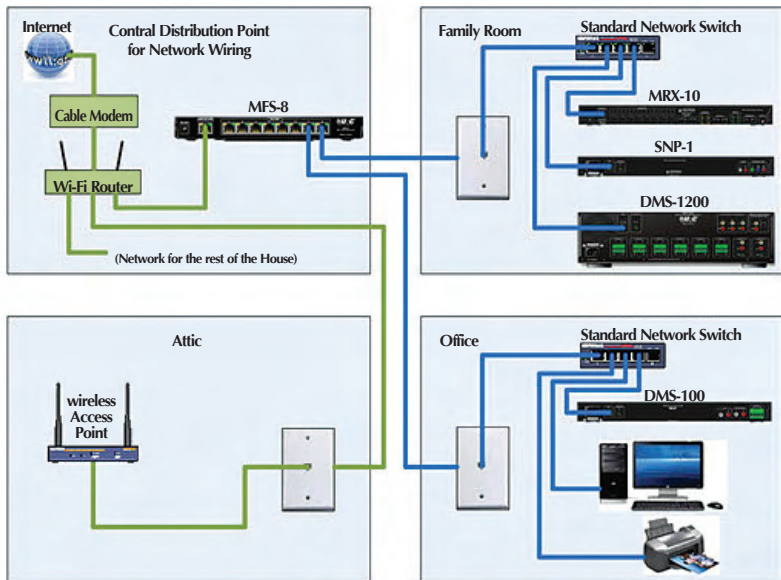

Notes:

- The Wireless Access Point CANNOT be connected to the MFS-8; it must be connected to the Router in the LAN.
- Standard network switches are used to connect the DMS-1200, DMS-100 and SNP-1 to the MFS-8. This configuration provides MAC Filtering to the Total Control streaming components, while freeing up additional ports on the MFS-8 to connect PoE devices like Keypads and IP Cameras.
- A MRX-10 doesn't have to be connected to the MFS-8, but can be connected to a MFS-8 when convenient to do so.

Frequently Asked Questions

1. Do I need to use a MFS-8 in a Total Control system?

If you are only controlling a Home Theater with a MRX-10, and there are no Total Control streaming sources like the DMS-1200 or DMS-100 in the system, then the answer is NO, you do not need to use a MFS-8. If you have DMS-1200(s) or DMS-100(s) in the system, then the answer is YES, you must use a MFS-8 in the system, connected to those components.

2. Can I connect both PoE (Power over Ethernet) devices like KP-4000 keypads and Non-PoE devices to the MFS-8?

No, the MFS-8 is not a PoE switch. You may use the MFS-8 to power Keypads and IP Cameras.

3. What if I have more than eight streaming devices?

You can connect a standard network switch to the MFS-8 to expand the MAC Filtering capabilities of the MFS-8.

4. Can I connect a WAP (Wireless Access Point) to the MFS-8?

No, the WAP will not function properly when multiple streams are occurring in the system. Connect the WAP to a standard PoE network switch, outside of the MFS-8. Never connect a WAP to the MFS-8.

5. I have one CAT5 cable going to a room where my client has a network printer and a PC and I need to install a DMS-100 Single Zone Amplifier, via the same CAT5 cable, in the room. How do I connect everything?

In the room where you plan to install the DMS-100, connect a standard network switch to the incoming CAT5, and then connect the DMS-100, PC and Printer to the switch. It is not recommended to connect PC's used for internet gaming to a MFS-8, as this may affect the performance of video gaming during heavy stream usage.

Specifications

Microprocessor: 55MHz RISC

Memory: 4 Megabits of Serial Flash, 512KB Flash, 128KB SRAM

Network: Switching - Eight 10/100 Ethernet ports, LAN - One 10/100 Ethernet port

Power Supply: 12V External Power Supply

Size: 1.5" x 9.8" x 4.9" (H X W x D)

Weight: 0.78 lbs. (0.35kg)

USA Limited Warranty Statement

Your Universal Remote Control, when delivered to you in new condition, is warranted against defects in materials or workmanship as follows: **UNIVERSAL REMOTE CONTROL, INC.** warrants this product against defects in material or workmanship for a period of one (1) year and as set forth below. Universal Remote Control will, at its sole option, repair the product using new or comparable rebuilt parts, or exchange the product for a comparable new or rebuilt product. **In the event of a defect, these are your exclusive remedies.**

This Limited Warranty covers only the hardware components packaged with the Product. It does not cover technical assistance for hardware or software usage and it does not cover any software products whether or not contained in the Product; any such software is provided "AS IS" unless expressly provided for in any enclosed software Limited Warranty.

To obtain warranty service, you must deliver the product, freight prepaid, in its original packaging or packaging affording adequate protection to Universal Remote Control at the address provided in the Owner's Manual. **It is your responsibility to backup any macro programming, artwork, software or other materials that may have been programmed into your unit. It is likely that such data, software, or other materials will be lost during service and Universal Remote Control will not be responsible for any such damage or loss.** A dated purchase receipt, Bill of Sale, Installation Contract or other verifiable Proof of Purchase is required. For product support and other important information visit Universal Remote Control's website: <http://www.UniversalRemote.com> or call the Customer Service Center (914) 835-4484.

This Limited Warranty only covers product issues caused by defects in material or workmanship during ordinary consumer use. It does not cover product issues caused by any other reason, including but not limited to product issues due to commercial use, acts of God, third-party installation, misuse, limitations of technology, or modification of or to any part of the Universal Remote Control product. This Limited Warranty does not cover Universal Remote Control products sold as USED, AS IS, REFURBISHED, so-called "B STOCK" or consumables (such as batteries). This Limited Warranty is invalid if the factory-applied serial number has been altered or removed from the product. This Limited Warranty is valid only in the United States of America. **This Limited Warranty specifically excludes products sold by unauthorized resellers.**

Federal Communication Commission Interference Statement

This equipment has been tested and found to comply with the limits for a Class B digital device, pursuant to part 15 of the FCC Rules. These limits are designed to provide reasonable protection against harmful interference in a residential installation. This equipment generates, uses and can radiate radio frequency energy and, if not installed and used in accordance with the instructions, may cause harmful interference to radio communications. However, there is no guarantee that interference will not occur in a particular installation. If this equipment does cause harmful interference to radio or television reception, which can be determined by turning the equipment off and on, the user is encouraged to try to correct the interference by one more of the following measures:

- ◆ Reorient or relocate the receiving antenna.
- ◆ Increase the separation between the equipment and receiver.
- ◆ Connect the equipment into an outlet on a circuit different from that to which the receiver is connected.
- ◆ Consult the dealer or an experienced radio/TV technician for help.

Warning!

Changes or modifications not expressly approved by the manufacturer could void the user's authority to operate the equipment.

Note : The manufacturer is not responsible for any Radio or TV interference caused by unauthorized modifications to this equipment. Such modifications could void the user's authority to operate the equipment.

FCC Caution

This device complies with Part 15 of the FCC Rules. Operation is subject to the following two conditions: (1) this device may not cause harmful interference, and (2) this device must accept any interference received, including interference that may cause undesired operation.

Any changes or modifications not expressly approved by the party responsible for compliance could void the authority to operate equipment.

Regulatory Information to the user

■ CE conformity Notice

Products with "CE" marking comply EMC Directive 2004/108/EC issued by the commission of the European Community.

1) EMC Directive

- Emission : EN 55022
- Immunity : EN 55024
- Power : EN-61000-3-2, 3

■ Declaration of Conformity

"Hereby, Universal Remote Control Inc. declares that this MFS-8 is in compliance with the Essential requirements and other relevant provisions of EMC Directive 2004/108/EC."



Universal Remote Control®

| | |
|---------------------|--|
| Certification | CE |
| Type No.(Model No.) | MFS-8 |
| Batch/Serial No. | - |
| Power Rating | 12.0V  , 1.0A |

Declaration of Conformity

Company Name : Universal Remote Control Inc.
 Company Address : 500Mamaroneck Avenue, Harrison, NY 10528, U.S.A
www.universalremote.com
 Contact Information : Phone: (914)835-4484 Fax: (914)835-4532
 Brand Name : UNIVERSAL remote control
 Product Name : Mac Filtering Switch
 Model Name : MFS-8

This product herewith complies with the requirements of EMC Directive (2004/108/EC) issued by the Commission of the European Community

Compliance with these directives implies conformity to the following European Community

- EMC Directive
 - EN 55022
 - EN 55024
 - EN 61000-3-2
 - EN 61000-3-3

List of test reports and/or certificate verified compliance with the standards above

- EMC Directive
 - Report No.
 - Testing Laboratory : Gumi College EMC Center

Date of issue : November 09, 2010

Name and signature of authorized person : James Novak
 Senior Product Manager
 Universal Remote Control Inc.



500 Mamaroneck Avenue, Harrison, NY 10528

Phone: (914) 835-4484 Fax: (914) 835-4532

www.universalremote.com