

MRF-250 INSTALLATION MANUAL



Multi-Room “No-Pointing” RF Control of
Audio/Video Components

MRF-250 Installation Manual © 2004 Universal Remote Control, Inc.

The information in this manual is copyright protected. No part of this manual may be copied or reproduced in any form without prior written consent from Universal Remote Control, Inc.

UNIVERSAL REMOTE CONTROL, INC. SHALL NOT BE LIABLE FOR OPERATIONAL, TECHNICAL OR EDITORIAL ERRORS/OMISSIONS MADE IN THIS MANUAL.

The information in this manual may be subject to change without prior notice.

*Home Theater Master is a registered trademark of Universal Remote Control, Inc.
Entertainment Made Simple is a trademark of Universal Remote Control, Inc.*

All other brand or product names are trademarks or registered trademarks of their respective companies or organizations.



Universal Remote Control®

500 Mamaroneck Avenue, Harrison, NY 10528

Phone: (914) 835-4484 Fax: (914) 835-4532

TABLE OF CONTENTS

Introduction	1
Features and Benefits	2
Parts Guide	2
Front Panel	3
Mounting Plate	3
Power LED	3
Status LED	3
Front Blaster	3
Rear Panel	4
Flashers	4
Power Supply	4
Bottom Panel	4
Receiver ID#	4
A Standard MRF-250 System	5
Standard Installation — Step by Step	5
Front Blaster Overload	7
Disabling the Front Blaster - Step by Step	7
Controlling An Array of Identical TV's	8
Identical Components - Step by Step	8
Programming For Multiple Equipment Locations	11
Frequently Asked Questions	12
Specifications	12

Introduction

The combination of the MX-3000 with its companion MRF-250 base station will enable you to place your audio/video components out of sight behind closed doors and/or in another room of your house. The MX-3000 sends radio signals to the MRF-250 throughout your house (50-100' away, indoors or outdoors). The MRF-250 converts your commands to the infrared signals that control your A/V components.

1. The MX-3000 remote control sends radio waves in every direction, so you don't have to point the remote anymore!



2. The MRF-250's built-in Front Blaster sends commands to components in the same cabinet space as the MRF-250.



3. Self-adhesive "Flashers" affix to the Infrared sensors on the front panels of your components. The Flashers relay commands to components out of sight of the MRF-250's Front Blaster. The flashers plug in to the MRF-250's rear flasher line outputs via their 10 foot cables.



Features and Benefits

No More Pointing - Radio Waves Penetrate Walls, Doors and Floors

The MRF-250 receives the RF signals of the MX-3000 remote control from any direction. You no longer need to point the remote control at any of your A/V components. You can also place the components distracting blinking lights and displays behind closed doors and/or in another room!

Reliable Control Throughout Your House

The MRF-250 receives RF signals from your MX-3000 from within a radius of 50 to 100 feet enabling you to control out of sight audio/video components behind walls and closed doors. Range depends on the structure of your home and the amount of interference generated by computers, microprocessors and other devices within and nearby your home.

Up To Sixteen Equipment Locations Controlled From Any MX-3000

Each MX-3000 can be programmed to operate equipment placed throughout the house, by installing an MRF-250 base station at each location. Each MRF-250 is assigned one of 16 unique ID#'s. In operation it's simple: when you select a device located in the Den, the MX-3000 only talks to the MRF-250 in the Den. When you select a device located in the Family Room, the MX-3000 only talks to it!

No Pointing Remote Controls In Every Room

You can opt to control a multi-room or multi-zone system via RF remote control by placing an MX-3000 in each room of your home.

Control A Media Room Array of Identical TV's

The MRF-250's unique assignable IR flashers enable your installation to control up to six identical TV's. The intelligent routing of the MRF-250 will send your commands only to the TV you select on your MX-3000. The other identical TV's will not receive commands. Of course, if your system utilizes identical satellite receivers, cable boxes, VCR's or disc changers you can utilize IR routing just as easily for them. If you have more than six identical components, up to 16 additional MRF-250's can be installed to control them (thus allowing up to 96 identical components in one house).

Parts Guide

The MRF-250 RF Base Station includes:

- 1 - MRF-250 Receiver with integrated antenna
- 1 - Mounting Plate for wall mounting the MRF-250
- 4 - Screws for wall mounting the mounting plate
- 1 - 9V-300mA Power Supply
- 6 - Flashers with 10 foot plug in cables.

MRF-250 Details

Red POWER LED lights when the MRF-250's power supply is plugged into an active AC outlet.

Red STATUS LED lights when the MRF-250 receives an RF signal from the MX-3000.

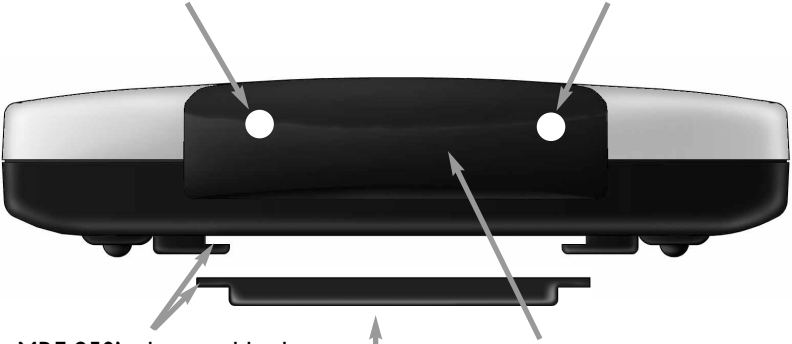

The MRF-250's slots enable the Mounting Plate's matching guides to slide and "snap" into place for mounting on the wall.

Front Blaster sends Infrared commands to all A/V components in the same cabinet space.

The MRF-250 Mounting Plate

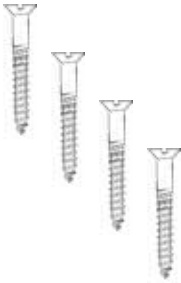

Using the four enclosed screws, you can choose to fix the mounting plate to a wall or the back of your component cabinet.

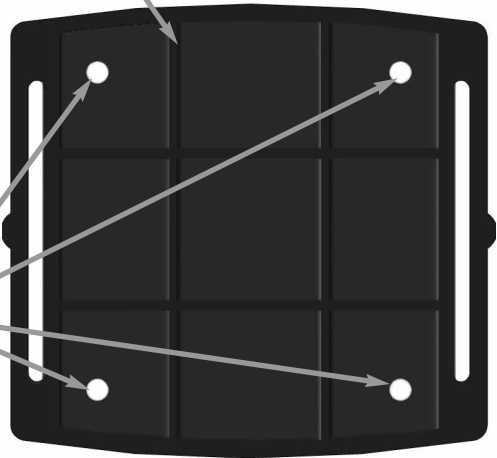

Integrated Antenna swings in any direction to optimize RF reception and range.



Included 9V power supply plugs into the MRF-250's power connector.

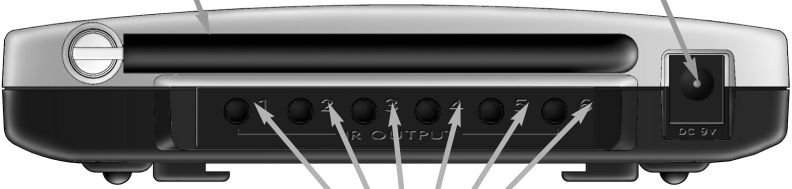

Six Rear Flasher Line Output Jacks connect flashers for control of A/V components out of sight of the MRF-250's Front Blaster.



Six Plug-In Flashers are supplied with 10 foot cables and six extra self-adhesive pads (in case a flasher has to be repositioned).

Bottom panel Dial sets the Receiver ID# when more than one MRF-250 receiver is used.



A Standard MRF-250 System

A standard system utilizes no identical components and only one equipment location. However, you can add any number of MX-3000 remote controls to your home! MX-3000's are available as an accessory purchase without an MRF-250 for standard system installations that already have an MRF-250.

You can add any number of MRF-250 base stations in a standard system as well. If you need more than six flasher outputs you may add additional MRF-250 receivers as needed by ordering an accessory MRF-250 base station.

Do not change the factory default settings in RF Control section of MX-3000 Editor when you download to your MX-3000's. You do not need to utilize MX3000 Editor's Program Step 9 (RF Control), since the factory settings will work fine!

Standard Installation — Step by Step

Step 1 - Program and Download to the MX-3000

Connect your MX-3000 to your PC and program the IR commands and macros as you like. Since your MX-3000 sends both IR and RF, you can test your programming as you go by pointing the MX-3000 at the components and using MX-3000 Editor's TEST and Macro Play features if you place your laptop PC in the same room as the components (with the cabinet doors open and in line of sight).

For a detailed explanation of how to program, use the downloadable Programming Manual or the animated Tutorial. Both are available as free downloads from the www.hometheatermaster.com website.

Important Note: Do NOT power up the MRF-250 at this point. You need to test your IR commands and Macros line of sight via IR only at this point!

Once you have completed and downloaded your programming to the MX-3000 remote control, you are ready to test RF operation via the Front Blaster and (if necessary) the self-adhesive flashers that connect to the MRF-250's flasher line outputs.

Step 2 - Place the MRF-250

The MRF-250 should be placed so that the Front Blaster will control as many of the system's A/V components as possible. If you are connecting the out-board flashers to the rear Flasher outputs only, the MRF-250 may be concealed and mounted to the rear wall or back of the system cabinet. The

mounting plate slides apart from the receiver, screws to the wall or cabinet with the enclosed screws, then the receiver is slid back into place.

Step 3 - Connect the Power Supply and Insert the Batteries

Connect the 9V power supply to an active UNSWITCHED AC outlet. The MRF-250 must always be powered up to operate. The red POWER LED should light. Insert the batteries in the MX-3000 remote control.

Step 4 - Test the MX-3000

Observe the MRF-250's STATUS LED blinking while you press and hold a programmed button (one with an actual command). This tells you that the MRF-250 is receiving the RF commands of the MX-3000. However, if the LED continues to flicker after you release the button, you are receiving RF Interference and you must move the MRF-250 to another location.

Step 5 - Orient the Antenna for Optimum Range

If you need to extend the range of the remote, try adjusting the angle of the MRF-250 receiving antenna via its pivoting ball mount.

Step 6 - Test Operation Without Flashers

With the MX-3000's IR output blocked by a jacket or pillow, test the control of your components using just the Front Blaster. In most cabinets, the MRF-250's Front Blaster will control any A/V components in the same cabinet space by reflections from the cabinet walls and doors. Make sure that the components operate with the cabinet doors closed or open. If a component is placed too far away from the front blaster, you will need to utilize the included Flashers plugged into the MRF-250's rear Flasher Line Output jacks.

If you have problems with components that are close to the Front Blaster, see the next page and the section on Front Blaster Overload.

Step 7 - Connect Flashers to Out of Sight A/V Components

Important Note: Test the operation BEFORE sticking the flasher in place.

Use a flashlight to identify the correct location of the component's IR sensor, then try a few commands while moving the flasher around the face plate of the component. The most reliable operation typically occurs a half inch or so away from the IR sensor.

Once you have found the spot that gives the most reliable operation, peel off the protective backing of the self-adhesive tape on the included Flashers and stick them in place.

Important Note: Always replace the self-adhesive tabs if you have to reposition a flasher. Six extra self-adhesive tabs are supplied for this purpose.

Front Blaster Overload

A few models of audio/video components can be OVERLOADED by the Front Blaster. If you are having intermittent or inconsistent results with a particular component, try repositioning the MRF-250 and facing the Front Blaster in a different direction. If this improves the situation but is impractical, it may be necessary to utilize the self-adhesive flashers only and follow the steps below to Disable the Front Blaster. This will limit the number of components your MRF-250 can control to six. If you have more than six components you can purchase an additional MRF-250 (available as an accessory alone from your Home Theater Master dealer). Do not change the receiver ID# (use the same ID # as the first unit) then follow the steps on the following pages:

Disabling the Front Blaster - Step by Step

Plug the MX-3000 back into the PC. Open your saved configuration and follow these steps to turn off the front blaster:

Step 1 - Open the RF Setup Window

The RF Setup window opens after selecting RF Control from the Program Menu.

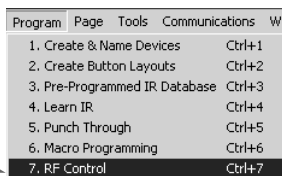

Step 2 - Reveal the Receiver settings

Extend the RF Setup window by clicking on the Receivers button.

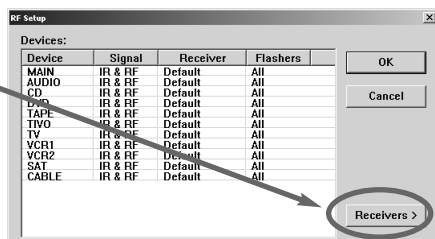

Step 3 - Turn off the Front Blaster

Click on the cell in the IR Blaster column. A list box will appear. Select OFF from the list.

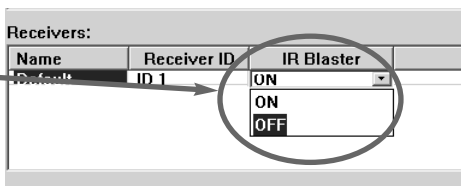

Next, click on OK to apply your change.

Step 4 - Save and Download to the MX-3000

SAVE your changes using File|Save and DOWNLOAD to the MX-3000.

Controlling An Array of Identical TV's (or VCR's, Receivers, CD players etc.)

There are several considerations to take into account when you are installing an MRF-250 to control an array of identical components:

1. You cannot use the Front Blaster to control identical components. You must use Flashers instead. You can still use the Front Blaster in a cabinet that is out of sight of the identical components to control the rest of your system.
2. Each identical component must receive IR commands ONLY from a dedicated Flasher affixed to its front panel. The IR output of the MX-3000 should be disabled for each identical component. It can still be utilized for the rest of your system!
3. You must note the NUMBER of the Flasher Output you have utilized for EACH of the identical components.

NOTE: If the identical components are near each other the Flashers and the actual sensor window of the component should be blocked with black electrical tape (sometimes more than one layer is needed).

Identical Components - Step by Step

Step 1 - Create a Device for Each TV in MX-3000 Editor

The MX-3000 can control up to 20 devices. You must create one device for each of your identical TV's.

In this example, six identical TV's are utilized in a Media Room array.

The programmer has created devices for all of the equipment in the cabinet on Main Page 1. On Main Page 2, he/she has created a device for each of the TV's.

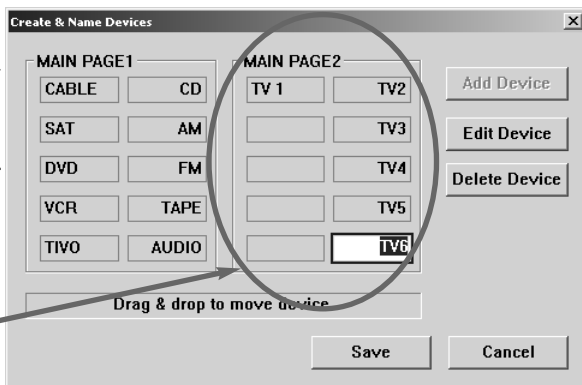

Step 2 - Program One Device With IR commands.

Using either the IR Database or Learning, program one of the identical devices to operate one of TV's (leave the others powered off right now). Test all commands and Save your work.

Step 3 - Copy The Programmed Device

In tree view, right click on the device you programmed. From the context menu that appears, select COPY.

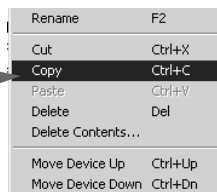

Step 4 - Paste The Programmed Device

In tree view, right click on the first device that is NOT PROGRAMMED. From the context menu that appears, select PASTE.

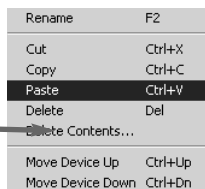

Repeat this PASTE on all of the other identical device. Save your work.

Step 5 - Open the RF Setup Window

The RF Setup window opens after selecting RF Control from the Program Menu.

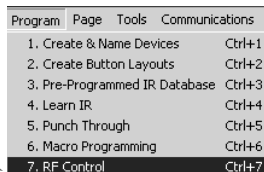

The RF Setup window is composed of a “spread sheet” of options for EACH of your devices. By looking at the Signal column, you can see that the factory default programming sets all of the devices to send both IR and RF commands. If you look at the column for Flashers, you can see that the default sends IR commands for all devices to ALL of the flashers. Both options must be changed for identical components. Additionally, if you are not using it, you may wish to disable the Front Blaster (see page 7 for directions).

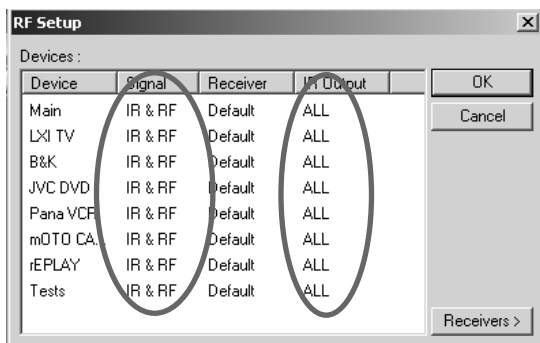

Step 6 - Adjust the Signal For Each of the Identical Devices

The RF Setup window enables you to adjust the Signal output by the MX-3000 for each device individually, by clicking on the intersection of a row and a column and then selecting RF from the three options shown in the pull down list box.

Click on the “cell” for the first identical TV, by crossing the device row with the Signals column.

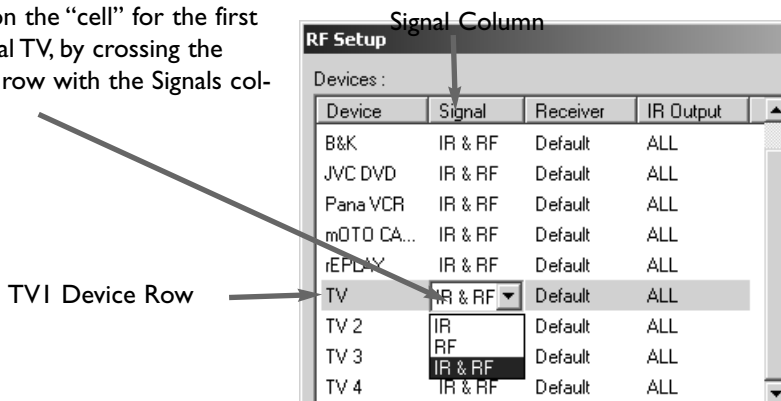

Select RF from the three options shown for EACH of the identical TV's. You may leave the other components of the system set to IR & RF.

Step 7 - Adjust the Flashers For Each of the Identical Devices

The RF Setup window enables you to adjust which Flashers output by the MX-3000 for each device individually, by clicking on the intersection of a row and a column and then selecting 1-6 from the seven options shown in the pull down list box.

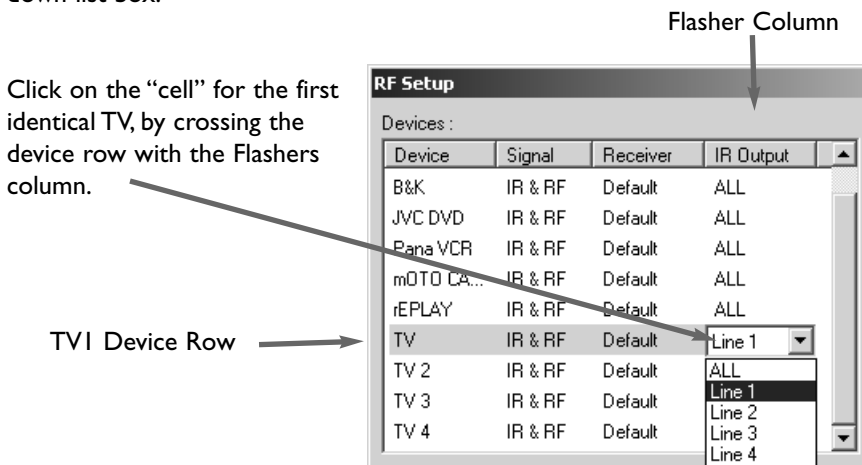

Select the correct Flasher (refer to your connection notes) for EACH of the identical TV's. You may leave the other components of the system set to ALL.

Step 8 - Apply, Save, Download and Test

First click on the OK button of the RF Setup window. Next, Save your work. Finally, download to your MX-3000. When you select TV1 with your MX-3000, commands are only sent to it. Likewise for the rest of your identical TV's!

Programming For Multiple Equipment Locations

You can operate up to 16 different equipment locations, each with an MRF-250 assigned a unique Receiver ID#. You program each of your MX-3000's to talk to the equipment locations you want by assigning each of your devices to a receiver. First, you must add and name your receivers for the locations they are placed in:

Step 1 - Open the RF Setup Window

The RF Setup window opens after selecting RF Control from the Program Menu.

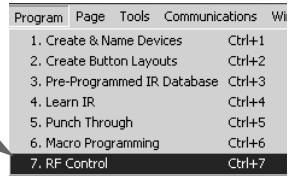

Step 2 - Reveal the Receiver settings

Extend the RF Setup window by clicking on the Receivers button of the RF setup window.

Step 3 - Add, Name and Assign Receiver ID#

Using the controls at the bottom extended portion of the RF Control window, add new receivers and rename them for the

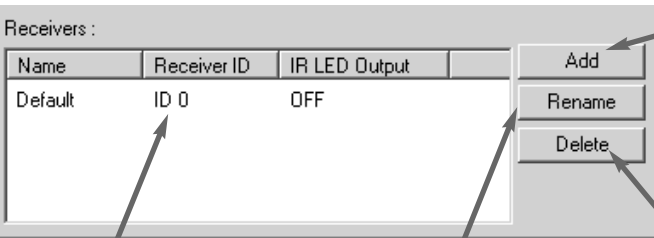

Add new receivers by clicking on the Add button.

Delete receivers by selecting them first by clicking on their Name, then clicking the Delete button.

Assign the correct Receiver ID# for each LOCATION by clicking on the desired CELL and selecting the ID# you want from the pull down list. Each LOCATION should have a unique ID#. It is ok to install multiple MRF-250's in one location.

You may rename the Default receiver to something more descriptive by clicking on the Rename button.

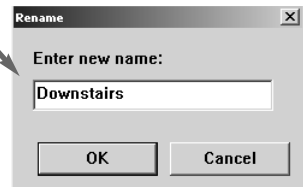

Step 4 - Save and Download to your MX-3000.

Frequently Asked Questions

Can I use flasher/emitters that I have already installed in the system to connect to the MRF-250?

Yes, the flashers are compatible, however flashers from other companies are equipped with a mini plug that is too large to fit the MRF-250's flasher jacks. Use Radio Shack part # 274-327 to convert 3.5mm plug Flasher/Emitters to the MRF-250.

I have a row of identical TV's. I've correctly set the flasher outputs using MX-3000 Editor, yet when I send a command to one of them, the TV next to the selected TV also responds. How do I stop this?

Use an opaque material like electrical tape to cover the flasher and the front panel sensor of each of the TV's. Sometimes several layers are necessary.

How can I increase the range of the MX-3000?

Often, you can increase range by repositioning the MRF-250 and/or by re-orienting the antenna. Try to avoid placing the MRF-250 directly adjacent to satellite receivers, personal computers or any other component using high speed microprocessors if possible.

Warranty

The MRF-250 is covered against any manufacturers defects or workmanship for a period of one year from the date of purchase if purchased from an authorized Home Theater Master dealer. Units purchased from online auction sites or other unauthorized resellers have no warranty. This warranty does not cover the following items:

- Damage from misuse, neglect, or acts of nature.
- Products that have been modified or incorporated into other products.
- Products purchased more than 12 months ago.
- Units purchased from unauthorized dealers or companies.

Specifications

MRF-250

Power Supply: 9V 300mA

IR Flasher Line Outputs: 2.5mm Mono Mini Jack

RF Frequency: 418MHz

Size: 5 1/8" x 3.5" x 1.25" (4.5" antenna up)

