



INSTRUCTIONS FOR USE

ELECTROSURGICAL GENERATOR

CELON Precision

CELON

DRAFT – 2017-01-17

CE₀₁₉₇

WA90008A
WA90009A

Caution: Federal (USA) law restricts this device to sale by or on the order of a physician.

DRAFT – 2017-01-17

Contents

1 General information	9
1.1 User instructions	9
1.2 Signal words.....	9
1.3 Conventions throughout this document.....	9
1.4 List of abbreviations	10
1.5 Manufacturer	10
2 Safety information	11
2.1 Intended use	11
2.2 Contraindications	11
2.3 High frequency surgery.....	11
2.4 User qualification	11
2.5 Environment of use	12
2.6 General dangers, warnings and cautions.....	12
2.6.1 User-related error prevention	12
2.6.2 Risks regarding environmental conditions	13
2.6.3 Risks regarding accessories	14
2.6.4 Risks regarding electric shock	14
2.6.5 Risks regarding burns	15
2.6.6 Potential hazards to the heart	16
2.6.7 Risks regarding fire and explosion	17
2.6.8 Procedural hazards and complications	18
3 Product description and functional principles	20
3.1 Scope of delivery	20
3.2 Symbols	20
3.3 Nomenclature and functional principles of the software features.....	21
3.3.1 CQM – Contact Quality Monitoring for the neutral electrode	22
3.3.2 HPCS – High Power Cut Support	22
3.3.3 Autostart for the bipolar mode SoftCoag.....	22
3.3.4 FSM – Fast Spark Monitor	22
3.4 Features for selected CELON bipolar applicators	22
3.4.1 RFITT – Radiofrequency Induced Thermotherapy.....	23
3.4.2 Automatic instrument recognition.....	23
3.4.3 Automatic wear-out detection.....	23
3.5 Nomenclature and functional principles of the hardware	24
3.5.1 The front panel.....	24
3.5.2 The rear panel.....	25
3.5.3 The double pedal foot switch	26
3.5.4 The connecting cable for the neutral electrode	26
3.6 Nomenclature and functional principles of the touch screen.....	27
3.6.1 The All Screen	27
3.6.2 The Set Screen	29
3.6.3 The Mode Screen	30
3.6.4 The screens for system settings	30
3.6.5 Icons displayed on the touch screen.....	32
3.7 Warranty.....	33
4 Installation	34
4.1 General inspection	34
4.2 Placement of the electrosurgical generator.....	34
4.3 Connecting the electrosurgical generator to the mains electricity	34

4.3.1 Before connecting	35
4.3.2 Connecting	35
4.4 Connecting the double pedal foot switch	36
4.4.1 Before connecting	36
4.4.2 Connecting	36
5 System settings.....	38
5.1 Operation of the touch screen	38
5.2 Overview of system settings	38
5.3 Select Procedure settings	39
5.4 Foot switch assignment and Autostart	40
5.5 Select Menu settings.....	41
5.5.1 Save Procedure - Saving and overwriting procedure settings	41
5.5.2 Delete Procedure	43
5.5.3 Languages	43
5.5.4 Touch Tone	44
5.5.5 Autostart Setup	44
5.5.6 Software Version.....	44
5.5.7 Safety Test	45
5.5.8 Bipolar Cut Setup.....	45
5.5.9 Service	45
5.5.10 Volume control	46
5.5.11 Brightness control	46
6 Connecting HF instruments.....	48
6.1 Safety information for connecting HF instruments	48
6.2 Description of the output sockets	49
6.3 Connecting	50
7 Neutral electrode operation	52
7.1 Safety information for neutral electrode operation	52
7.2 Split type and non-split type neutral electrodes and CQM.....	53
7.3 Meaning of CQM indicator condition	54
7.4 Correct usage of neutral electrodes.....	54
7.5 Connecting to the electrosurgical generator	55
7.5.1 Connecting a neutral electrode with a pre-attached cable.....	55
7.5.2 Connecting a neutral electrode without a pre-attached cable.....	56
7.6 Verifying the contact quality monitor indicator.....	57
8 Output settings.....	58
8.1 Safety information on output settings	58
8.2 Overview of output modes	58
8.2.1 Monopolar modes	58
8.2.2 Bipolar modes	58
8.3 Tissue effects depending on the output power level	59
8.3.1 Monopolar modes	59
8.3.2 Bipolar modes	60
8.4 Selecting the appropriate output settings.....	60
8.5 The bipolar RFITT coagulation modes.....	62
8.6 Output settings for selected CELON bipolar applicators	63
9 Inspection before operation.....	65
9.1 Inspecting the supply of power.....	65
9.2 Inspecting the touch screen	65
9.3 Inspecting the foot switch assignment	66
9.4 Inspecting the alarm system	67

10 Operation	68
10.1 Safety information for operation	68
10.2 Activating.....	69
10.2.1 Prior to activating	69
10.2.2 Limited activation time	69
10.2.3 Functional principles of activation	70
10.3 After use.....	72
10.3.1 Disconnecting	73
11 Reprocessing	74
11.1 General information for reprocessing	74
11.2 Cleaning.....	74
11.3 Disinfection.....	75
11.4 Other HF equipment.....	75
12 Troubleshooting	76
12.1 General problems.....	76
12.2 Error messages.....	78
12.2.1 Overview of error messages	80
13 Maintenance, repair and shipment.....	84
13.1 Annual safety check	84
13.2 Repair.....	84
13.3 Shipment.....	84
14 Storage and disposal.....	85
14.1 Storage.....	85
14.2 Disposal	85
15 Compatible equipment	86
15.1 System chart.....	86
15.2 Compatible neutral electrodes	87
16 Specifications.....	88
16.1 Specifications for the CELON Precision.....	88
16.2 Specifications for the double pedal foot switch (WB50402W).....	89
16.3 Specifications for the cord set.....	89
17 Electromagnetic compatibility	90
Appendix A	95
Alarm system	95
Output tone information.....	96
Touch tone and start melody.....	97
Appendix B	99
Mode characteristics according to IEC 60601-2-2	99
Characteristics of High Power Cut Support (HPCS)	100
Output characteristics	101

Figures

Figure 3.1	Front panel of the CELON Precision.....	24
Figure 3.2	Rear panel	25
Figure 3.3	Double pedal foot switch	26
Figure 3.4	Cable for neutral electrode, MAJ-814.....	26
Figure 3.5	BIPOLAR pane.....	27
Figure 3.6	MONOPOLAR pane	27
Figure 3.7	Buttons for system settings.....	28
Figure 3.8	Buttons and symbols on the All Screen	28
Figure 3.9	Set Screen.....	29
Figure 3.10	Mode Screen for monopolar cutting	30
Figure 3.11	Hierarchy list of the 3 right-hand sided buttons on the All Screen	31
Figure 4.1	Connecting the cord set to the electrosurgical generator	35
Figure 4.2	Connecting the foot switch to the electrosurgical generator	37
Figure 5.1	Buttons for system settings.....	38
Figure 5.2	Screen [Select Procedure].....	39
Figure 5.3	Screen [Assign Foot Switch].....	40
Figure 5.4	Screen [Select Menu]	41
Figure 5.5	Onscreen keyboard (letters and numbers)	42
Figure 5.6	Onscreen keyboard (upper/lower key and backspace key)	42
Figure 5.7	Volume control.....	46
Figure 5.8	Brightness control.....	47
Figure 6.1	CAUTION - Correct connection of a monopolar 1-pin plug with a 4 mm pin diameter.....	48
Figure 6.2	CAUTION - Do not connect a 2-pin plug with 4 mm pin diameters to the MONOPOLAR socket.....	49
Figure 6.3	MONOPOLAR output socket specifications for WA90008A	50
Figure 6.4	MONOPOLAR output socket specifications for WA90009A	50
Figure 6.5	Bipolar output socket specifications.....	50
Figure 7.1	Error message E0202 "Insufficient neutral electrode contact".....	53
Figure 7.2	Message box "Neutral electrode".....	53
Figure 7.3	Connecting the plug of the neutral electrode.....	56
Figure 7.4	Fixing the neural electrode to the connecting cable	56
Figure 7.5	Split type indicator for CQM shining red on the Set Screen and on the All Screen	57
Figure 8.1	All Screen	61
Figure 8.2	Set Screen for monopolar modes.....	61
Figure 8.3	Mode Screen for monopolar cutting modes.....	61
Figure 8.4	Counters on the Set Screen and during activation	62
Figure 8.5	Error message E0660 "No bipolar cutting"	63
Figure 8.6	Automatic instrument recognition	63
Figure 8.7	Incompatible settings.....	64
Figure 9.1	Changing from the All Screen to the Set Screen	65
Figure 9.2	Changing from the All Screen to the screen [Select Menu]	66
Figure 9.3	Changing from the All Screen to the screen [Assign Foot Switch]	66
Figure 9.4	Error message E0202 "Insufficient neutral electrode contact".....	67
Figure 10.1	Error message E0115: "Application time limit exceeded"	70
Figure 10.2	Background color for active coagulation on the All Screen	71
Figure 10.3	Background color for active coagulation on the Set Screen	71
Figure 10.4	Error message E0141 "Power set to zero (--)".....	72
Figure 12.1	Error message E0002 "Short circuit"	79
Figure 15.1	System chart for CELON Precision	86
	Characteristics of HPCS	100

DRAFT – 2017-01-17

DRAFT – 2017-01-17

1 General information

1.1 User instructions



- Before use, thoroughly read these instructions for use, and the instructions for use of all other products that will be used during the procedure.
- If the required instructions for use are missing, immediately contact an Olympus representative.
- Keep the instructions for use in a safe, accessible location.

1.2 Signal words

The following signal words are used throughout this document.

DANGER

Indicates a hazardous situation which, if not avoided, will result in death or serious injury.

WARNING

Indicates a potentially hazardous situation which, if not avoided, could result in death or serious injury.

CAUTION

Indicates a potentially hazardous situation which, if not avoided, may result in minor or moderate injury. It may also be used to alert against unsafe practices or potential equipment damage.

NOTICE

Indicates a property damage message.

1.3 Conventions throughout this document



This is the safety alert symbol. It is used to alert the user to potential physical injury hazards. Observe all safety messages that follow this symbol to avoid possible injury.



This symbol indicates additional helpful information.

1. A numeration indicates a sequence of actions.
2. ...

- Bullet points indicate individual actions or different options for action.
- Dashes indicate the listing of data, options or objects.

1) Numbers with right parenthesis name elements in illustrations.

[example]

Bracketed terms refer to elements in the graphical user interface. Such elements can be:

- icons
- buttons
- menu items
- dialog elements

1.4 List of abbreviations

AC	Alternating current
CQM	Contact Quality Monitor
DC	Direct current
EMC	Electromagnetic compatibility
ESD	Electrostatic discharge
FSM	Fast Spark Monitor
GSM	Global system for mobile communication
HF	High frequency
HPCS	High Power Cut Support
ICD	Implanted cardioverter defibrillator
IED	Implanted electronic device
RFID	Radio-frequency identification
RFITT	Radiofrequency Induced Thermotherapy
UDI	Unique device identifier

1.5 Manufacturer



Olympus Winter & Ibe GmbH
Kuehnstr. 61
22045 Hamburg
Germany

DRAFT – 2017-01-17

2 Safety information

2.1 Intended use

Electrosurgical generator intended for tissue cutting and coagulation in conjunction with electrosurgical accessories and ancillary equipment.

2.2 Contraindications

Electrosurgical interventions are contraindicated if, in the judgment of the physician, tissue coagulation and cutting could have a negative effect on the state of the patient. Electrosurgical interventions may be contraindicated for patients with implanted electronic devices (e.g. pacemakers or cardioverter-defibrillators), a weakened immune system or blood coagulation disorders.

2.3 High frequency surgery

If there is an official standard on the applicability of high frequency treatment as defined by a national or local medical administration or other institutions, such as an academic society, follow that standard when performing the procedure.

Before performing any high frequency treatment, thoroughly study the properties, purposes, and effects as well as the nature, extent, probability and imminence of possible risks associated with the planned treatment. Furthermore, study any alternative therapeutic method that can be performed.

Carry out high frequency treatment only when its benefits outweigh its risks. Fully explain to the patient the possible benefits and risks of high frequency treatment as well as those of any therapeutic method that can be performed instead of electrosurgery. Perform high frequency treatment only after patient consent is granted.

During high frequency treatment, continue to evaluate the potential benefits and risks. Stop the treatment if the risks become greater than the possible benefits to the patient.

2.4 User qualification

Medical use

If the required qualification for medical personnel who uses electrosurgical generators is defined by a national or local medical administration or other institutions, such as an academic society, then follow that standard.

If there is no such standard:

- The user must be a physician or medical personnel under supervision of a physician.
- The user must have experience with electrosurgical procedures that are used for the therapy.
- The user must have received appropriate training in using this electrosurgical generator. This training is provided during installation and commissioning of the CELON Precision by trained qualified personnel that has been authorized by Olympus.

These instructions for use do not explain or discuss clinical procedures.

Commissioning

The electrosurgical generator must be properly installed and commissioned by trained qualified personnel that has been authorized by Olympus.

Annual safety check

The annual safety check may only be carried out by a qualified electrician with sufficient experience in maintaining medical electrical devices.

Repair

Repair of the product may only be performed by authorized service centers. Otherwise, Olympus cannot be held responsible for the safety and performance of the product.

2.5 Environment of use

Medical use

This product is intended to be used in operating rooms or physicians' offices.

Annual safety check

Appropriate equipment for performing the safety check must be available. Refer to the section "Annual safety check" on page 84.

2.6 General dangers, warnings and cautions

High frequency leakage current or spark discharge may cause burns to the user and the patient. Always prepare for an emergency operation if unintentional burns, bleeding and perforation occur.

The following dangers, warnings and cautions apply to the general handling of the product. This information is to be supplemented by the dangers, warnings and cautions given in each chapter in this document or in the instructions for use of any product being used with this product.

2.6.1 User-related error prevention



WARNING Improper use

Safety and effectiveness of electrosurgery do not only depend on the design of the used equipment. To a major extent, the success of electrosurgical interventions depends on factors that are under the control of the user. Therefore, it is particularly important to read, understand and follow the instructions that are supplied with the electrosurgical generator and with the accessories. Improper use can cause severe procedural complications and equipment damage and could result in injuries to the patient, the user and the medical personnel.

Only use the electrosurgical generator as outlined in these instructions for use.

- Before each use, inspect the electrosurgical generator and all accessories according to the corresponding instructions for use.



CAUTION Annual safety checks

To maintain device performance and electrical safety, annual safety checks must be carried out on the electrosurgical generator and the foot switch. Otherwise, malfunction of the devices could occur which may result in injury to the patient.

- Make sure that the annual safety check is carried out regularly.
- Refer to the information in the section "Annual safety check" on page 84.
- Observe national statutory regulations.

2.6.2 Risks regarding environmental conditions



DANGER **Explosive atmosphere**

The electrosurgical generator is not explosion proof. Using the electrosurgical generator in explosive atmosphere will result in serious injury to the patient, the user and the medical personnel.

- Do not use the electrosurgical generator within an explosive atmosphere.



CAUTION **The electrosurgical generator can disturb other equipment**

The electrosurgical generator complies with the standards as described in the chapter "Electromagnetic compatibility" on page 90. However, during activation, high frequency signals or spark discharge noise generated by the electrosurgical generator can disturb neighboring electrical equipment. Malfunction of the devices could occur, e.g. the monitor of endoscopic imaging equipment might freeze or black out, which may result in injury to the patient.

- Follow the instructions regarding electromagnetic ambient conditions given in the chapter "Electromagnetic compatibility" on page 90.
- Make sure that electrosurgical generator is not used adjacent to or stacked with equipment that is not part of this electrosurgical generator or system.
- Before use, thoroughly confirm the compatibility of all equipment.
- Do not use the electrosurgical generator in conjunction with:
 - Electrical equipment for which the safety against leakage current is not confirmed.
 - Electrosurgical equipment for which the safety in combined use is not confirmed.
- Do not loop cables.
- Do not bundle cables together with cables belonging to other medical equipment.



CAUTION **Strong electromagnetic radiation can disturb the electrosurgical generator**

Equipment that produces strong electromagnetic radiation can cause malfunction of the electrosurgical generator which may result in injury to the patient. Equipment that produces strong electromagnetic radiation is, e.g. microwave medical treatment equipment, short-wave medical treatment equipment, magnetic resonance imaging equipment, radio or mobile phones.

- Do not use the electrosurgical generator in a location exposed to strong electromagnetic radiation.



CAUTION **Unsuitable operating conditions**

Using the electrosurgical generator under conditions other than specified can compromise the performance and can damage the equipment which may result in patient injury.

- Only use the electrosurgical generator according the operating conditions as described in the chapter "Specifications" on page 88.

2.6.3 Risks regarding accessories



WARNING
Mechanical stress

Excessive mechanical stress applied to the cords can damage the cords and its insulations. This can result in electric shock and thermal injury to the patient, the user and the medical personnel. Furthermore, mechanical stress to the cords can cause malfunction of the electrosurgical equipment which can result in patient injury.

- Do not excessively bend, strain or squeeze the cords.



WARNING
Damaged equipment and accessories

The use of damaged equipment or of equipment with improper functioning may cause electric shock, mechanical injury, infection and thermal injury to the patient and the user.

- Before each use, observe the instructions in the section "Inspection before operation" on page 65.
- Do not use damaged equipment or equipment with improper functioning.
- Replace damaged equipment or equipment with improper functioning.



WARNING
Risk of sparkover

There is a risk of sparkover leading to electrical injury, thermal injury and/or unintended nerve stimulation.

- Check the maximum rated voltage of the other HF equipment.
- Make sure that the maximum output voltage of the electrosurgical generator does not exceed the lowest maximum rated voltage of any of the HF equipment used during the procedure.



CAUTION
Incompatible equipment

Using incompatible equipment may lead to injury of the patient and/or the user as well as damage to the product.

- For information on compatible equipment, refer to the chapter "Compatible equipment" on page 86.

2.6.4 Risks regarding electric shock



WARNING
Grounding failure

There is a risk of electric shock if the housing of the electrosurgical generator is not grounded.

- Only connect the cord set to a properly grounded fixed socket-outlet.
- Do not use an adapter for an incompatible grounded fixed socket-outlet as it can impair safe operation of the electrosurgical generator.



WARNING
Liquids

If liquids get on or into the electrosurgical generator, then this could cause electric shock to the user as well as damage to the electrosurgical generator which could result in injury to the user.

- Keep liquids away from all electrical equipment.
- If liquids get on or into the electrosurgical generator, then immediately stop the operation.

**CAUTION**
Opening the housing

There is a risk of electric shock when opening the housing of the electrosurgical generator.

- Do not open the housing of the electrosurgical generator.
- Repair and service of the electrosurgical generator may only be performed by trained qualified servicing personnel that has been authorized by Olympus.

2.6.5 Risks regarding burns**WARNING**
Power settings

The selected output power should be as low as possible for the intended purpose. If the output power initially is set to a level that is too high, then the electrode's insulation can be damaged. This could result in burns to the patient and the user.

However, all RFITT modes present an unacceptable risk when used with power settings that are too low. The risk of excessive thermal effects rises if the output power setting is too low when using these modes.

- For appropriate power settings refer to the tables with the modes characteristics in the "Appendix A" on page 95.
- Prior to the procedure, perform basic testing with the electrosurgical generator.

**WARNING**
Unintended tissue contact

When the output of the electrosurgical generator is active, then unintended contact between tissue and the active part of the HF instrument can cause burns to the patient, the user and the medical personnel.

- Store temporarily unused HF instruments in an electrically insulated container.
- Do not place unused HF instruments on the patient.

**WARNING**
Unintended current flow

Unintended current flow may cause injury to the patient and the user. The patient must be insulated against all electrically conductive parts.

- Make sure that the patient does not come in contact with any metal parts.
- Ground the operating table.
- Place the patient on a dry, electrically insulating surface.
- Make sure that the patient's clothes are dry.
- Prevent any contact between different skin surfaces (arms, legs) of the patient. Place dry gauze between the body and arms and between the legs to prevent such contact.
- Prevent any skin contact between the patient and the user.
- Remove any metallic items from the patient, e.g. wristwatches, jewelry.

**WARNING**
Using two electrosurgical generators

Using the electrosurgical generator in conjunction with another electrosurgical generator could result in patient and user injury due to the concentration of electric current.

- Keep HF instruments that are connected to the unused electrosurgical generator away from the target area while the other generator is in operation.
- Do not activate output of both generators simultaneously.



WARNING
Using physiological monitoring equipment

Current may flow to the monitoring electrodes and can cause thermal injury where the monitoring electrodes are attached. Especially, the use of needle electrodes can result in burns to the patient.

- Place the physiological monitoring electrodes as far away as possible from the electrodes of the HF instrument.
- Do not use needle monitoring electrodes.
- Use physiological monitoring equipment with HF current limiting measures.



WARNING
Surgical gloves

During operation, HF current, especially leakage current, could flow via the user and the assistant. This could result in burns to the user and the assistant.

- The user and the assistant must wear surgical gloves.



CAUTION
Unintended current flow and HF leakage current

Unintended current flow and HF leakage current may cause thermal injury to the patient. The patient must be insulated against all electrically conductive parts.

- Ground the operating table.
- Make sure that the patient does not come in contact with metal parts, e.g. the operating table.
- Place the patient on a dry, electrically insulating surface.
- Make sure that the patient's clothes are dry.
- Prevent any contact between different skin surfaces (arms, legs) of the patient. Place dry gauze between the body and arms and between the legs to prevent such contact.
- Prevent any skin contact between the patient and the user.
- Remove any metallic items from the patient, e.g. wristwatches, jewelry.
- Route all connecting cables so that they are not in direct contact with the patient.
- Route all connecting cables so that they are not in contact with other cables.

2.6.6 Potential hazards to the heart



DANGER
Malfunction of pacemakers and defibrillators

Using HF equipment on patients with implanted electronic devices, e.g. cardiac pacemakers or cardioverter defibrillators, can cause failure of the implanted electronic device. Failure of the implanted electronic device will affect the heart and could result in cardiac arrest.

- Prior to the HF procedure, confirm its safety with a cardiologist or the manufacturer of the implanted electronic device.
- For monopolar procedures, position the neutral electrode so that the current pathway does not pass through or near the implanted electronic device and its lead system.
- Do not apply the HF instrument in close proximity to the implanted electronic device.



WARNING
Electric shock hazard

When using the electrosurgical generator for procedures in the vicinity of the heart, note that spark discharge can affect the heart and could result in cardiac arrest.

- Make sure to use the lowest necessary output power for procedures in the vicinity of the heart.

**WARNING****Cardiac emergency**

- Keep ready a defibrillator.
- Before operating the defibrillator, remove all electrosurgical equipment from the patient.

2.6.7 Risks regarding fire and explosion

The surgical application of electrical energy can ignite flammable gases, substances and materials.

**DANGER****Ignitable anaesthetics and gases**

The igniting of flammable gases, especially anaesthetics, will cause serious injuries to the patient, the user and the medical personnel.

- Take precautionary measures to keep away flammable gases from the site of intervention.
- Do not use flammable anaesthetics, e.g. nitrous oxygen or oxygen.

**WARNING****Ignitable agents for cleaning and disinfection and other substances**

The igniting of flammable substances, e.g. agents for cleaning and disinfection, can cause serious injuries to the patient, the user and the medical personnel.

- If possible, only use non-flammable agents for cleaning and disinfection.
- Before the electrosurgical generator is used, allow flammable substances to evaporate.
- Make sure that there are no flammable solutions on the patient's skin, e.g. under the neutral electrode.
- Make sure that there are no flammable solutions in the body cavity of the patient.

**WARNING****Ignitable materials**

Sparks that occur during normal operation of the HF equipment can ignite flammable materials, e.g. absorbent cotton or gauze and also body hair. This could result in serious injuries to the patient, the user and the medical personnel.

- Use soluble surgical lubricating jelly to cover hair close to the site of intervention.
- Do not apply materials like cotton or gauze simultaneously with the HF instrument to the site of intervention.

**WARNING****Ignitable gas in the gastrointestinal tract**

Flammable gases within the intestines of the patient could cause fire or explosion when applying HF current. This could result in serious injury to the patient.

- Prior to the HF procedure, replace intestine gases by air or by other non-flammable gases.

**WARNING****Fuses**

Using inadequate fuses can cause electrical fire within the electrosurgical generator. This could result in injury to the patient, the user and the medical personnel.

- Fuses must only be replaced by a qualified electrician with sufficient experience in maintaining medical electrical devices.
- Only use fuses as specified in the section "Specifications for the CELON Precision" on page 88.
- Before changing the fuses, disconnect the electrosurgical generator from the mains electricity.

2.6.8 Procedural hazards and complications



DANGER

Procedural hazards and complications

Insufficient knowledge of the user about the medical literature and about the specific procedural hazards will result in severe complications that can result in death of the patient.

- The electrosurgical generator must only be used by physicians who have experience with the electrosurgical procedure that is used for the specific therapy.
- To respond to possible complications during the procedure consider the following:
 - Prepare at least one hemostatic procedure: coagulation, clipping or local injection.
 - Make sure that emergency equipment for life-saving, intubation and appropriate pharmaceuticals are located in or near the procedure room.
 - Prepare a spare electrosurgical generator or an alternative procedure to avoid interruption of treatment due to an unexpected electrosurgical generator failure during the treatment.
 - If any abnormal output is suspected during the operation, immediately terminate the use of the equipment.
 - If the foot switch does not react, switch off the electrosurgical generator. Malfunction of the equipment can cause an unintended increase of output energy.
 - Use physiological monitoring equipment throughout the entire procedure.
 - Consider the use of a bipolar mode for procedures where the HF current could flow through parts of the body with a relatively small cross sectional area.
 - It is not recommended to use electrosurgery for circumcisions because of the risk of thermal injuries. The risk can be reduced if metal parts of any kind (e.g. clamps) or monopolar HF instruments are avoided.



WARNING

Electrosurgical smoke

Electrosurgical interventions produce smoke. When unfiltered smoke is inhaled, then this can affect the health of the user and the medical personnel.

- Wear surgical masks during the procedure.
- Make sure that adequate ventilation, surgical smoke evacuators or other means is provided in the operating room.



WARNING

Output performance

Tissue coagulum that builds up at the HF instrument can impede the output performance of the electrosurgical generator. Increasing the output level can damage the electrosurgical generator and can result in injury to the patient.

- Carefully clean eschar affected areas of the HF instrument. Refer to the instructions for use of the HF instrument.
- If necessary, replace the HF instrument.

If non-insulated grasping forceps are used during endoscopic interventions, then the HF current is dispersed via the endoscope which impedes the output performance and which can result in injury to the patient.

- Only use isolated grasping forceps during endoscopic interventions.

**WARNING****Electrical stimulation of nerves and muscles**

Low frequency electrical currents or intense high frequency electrical currents can stimulate nerves and muscles which may result in violent spasms or muscle contractions of the patient. Low frequency electrical currents may be generated by a partial rectification of intense high frequency electrical current, in particular when there is a spark discharge to the tissue or to another metallic object. Intense high frequency electrical currents can occur at the beginning of an electrosurgical cut or when using high output power settings.

- Use the lowest appropriate output power level. Be aware that certain modes present an unacceptable risk with power settings that are too low. With all RFITT modes the risk of excessive thermal effects rises if the output power setting is too low.
- For appropriate power settings refer to the tables with the modes characteristics in the "Appendix B" on page 99.

**CAUTION****Generator defect**

Short circuits can cause malfunction or damage of the electrosurgical generator which may cause an undesirably high output of power. This could result in injury to the patient.

- Make sure that the electrodes of an HF instrument do not come in contact with each other.
- Do not touch metallic parts with the HF instrument.

DRAFT – 2017-01-17

3 Product description and functional principles

3.1 Scope of delivery

- Before use, check that all items listed below are available.
- Contact an Olympus representative or an authorized service center if any items are missing or damaged.

WA90008A or WA90009A

- Electrosurgical generator CELON Precision
- Foot switch including connecting cable (WB50402W)
- Instructions for use



A cord set for connecting the electrosurgical generator to the mains electricity is not included as the plug types depend on national standards. Refer to the section "Specifications for the cord set" on page 89.

3.2 Symbols

This section gives an explanation for each symbol used on the product and on the packaging of the product.



Caution, consult accompanying documents



Follow instructions for use



HF isolated patient circuit – symbol for patient circuit where there are no components installed to provide a low-impedance path to earth for HF currents



Defibrillation proof type CF applied part (cardiac application)



Non-ionizing electromagnetic radiation



CE certification mark – symbol for the compliance with the Medical Device Directive 93/42/EEC



In accordance with European Directive 2002/96/EC on Waste Electrical and Electronic Equipment, this symbol indicates that the product must not be disposed of as unsorted municipal waste, but should be collected separately.





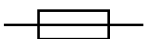













cTUVus certification mark



Fuse rating



Potential equalization terminal

-  REF Catalog number
 -  SN Serial number
 -  LOT Batch code
 -  QTY Quantity of content
 -  Manufacturer
 -  Date of manufacture
 -  Do not use if package is damaged
 -  Fragile, handle with care
 -  Indicates the range of humidity to which the medical device can be safely exposed
 -  Indicates the temperature limits to which the medical device can be safely exposed
 -  Keep away from rain. Keep dry
 -  Type CF applied part
 -  Indicates the stacking limit of a package by mass
 -  Storage conditions
 -  Transport conditions
 -  Indicates a recovery/recyclable package or package material
- Rx only** Federal (USA) law restricts this device to sale by or on the order of a physician.

DRAFT – 2017-01-17

3.3 Nomenclature and functional principles of the software features

The electrosurgical generator is equipped with the following features:

- Contact Quality Monitor (CQM)
- High Power Cut Support (HPCS)
- Autostart
- Fast Spark Monitor (FSM)

For selected CELON bipolar applicators the electrosurgical generator also provides:

- Radiofrequency Induced ThermoTherapy (RFITT)
- Automatic instrument recognition
- Automatic wear-out detection

The functional principles of these features are described in the sections below.

3.3.1 CQM – Contact Quality Monitoring for the neutral electrode

When using split type neutral electrodes for monopolar electrosurgery, the CELON Precision is able to detect unintended detachment of the neutral electrode from the patient. The indicator for the contact quality monitor (CQM) shines green while the contact between the split type neutral electrode and the skin of the patient is within an acceptable resistance range. If the contact between the split type neutral electrode and the patient's skin is insufficient, then an alarm tone sounds, a warning message is displayed and the contact quality monitor indicator shines red.

Using non-split type neutral electrodes is not as safe as using split-type ones as CQM is not able to detect any detachment of the neutral electrode from the patient.

For detailed information on the safe and correct use of neutral electrodes refer to the chapter "Neutral electrode operation" on page 52.

3.3.2 HPCS – High Power Cut Support

All cutting modes are supported by HPCS. This feature optimizes the start of the cutting procedure by applying high power to the tissue to support immediate spark ignition and to reduce the risk of mechanical cutting.

3.3.3 Autostart for the bipolar mode SoftCoag

If the impedance is within a defined range, then Autostart feature permits automatic activation of the output power as soon as both electrodes of the electrosurgical instrument touch the tissue. It is possible to set a time delay so that the automatic activation does not start immediately when the electrodes are in contact with the tissue but only after a certain time. Consequently, activating by foot switch is not necessary.

Autostart is available only for the bipolar mode SoftCoag.

3.3.4 FSM – Fast Spark Monitor

This feature ensures smooth and reproducible cutting although the tissue characteristic are varying, e.g. in muscle and fat.

3.4 Features for selected CELON bipolar applicators

The following features are compatible only with selected CELON bipolar applicators, e.g. CelonProCurve V.

DRAFT – 2017-01-17

3.4.1 RFITT – Radiofrequency Induced Thermotherapy

The medical purpose of the Radiofrequency Induced Thermotherapy, RFITT, is to achieve controlled tissue coagulation. The CELON Precision offers 3 different RFITT modes that are used in conjunction with the CELON bipolar applicators. For further information refer to the section “The bipolar RFITT coagulation modes” on page 62.

3.4.2 Automatic instrument recognition

The electrosurgical generator is equipped with a radio transmitting and receiving technology. Therefore, the selected CELON bipolar applicator that is connected to the electrosurgical generator is recognized automatically. This means:

- The name of the connected CELON bipolar applicator is displayed in the BIPOLAR pane of the touch screen, e. g. [ProCurve V].
- Only compatible modes and output power settings are available.
- The user can select one of these compatible modes and can change the output power level within a restricted range.

Other radio transmitters and receivers, e. g. mobile phones, may interfere with the automatic instrument recognition.

- To avoid interference observe the instructions in the chapter “Electromagnetic compatibility” on page 90.

3.4.3 Automatic wear-out detection

To protect the patient from a worn-out instrument the bipolar applicators are equipped with memory chips that record the usage. When the permitted usage span is nearly reached, the electrosurgical generator alerts the user by emitting an alarm tone and displaying the following error message:



At this stage and as soon as the treatment situation allows, the user needs to replace the bipolar applicator.

When the permitted usage span is exceeded, the following error message is displayed:



When this error message is displayed, it is impossible to activate the bipolar applicator anymore.

3.5 Nomenclature and functional principles of the hardware

3.5.1 The front panel

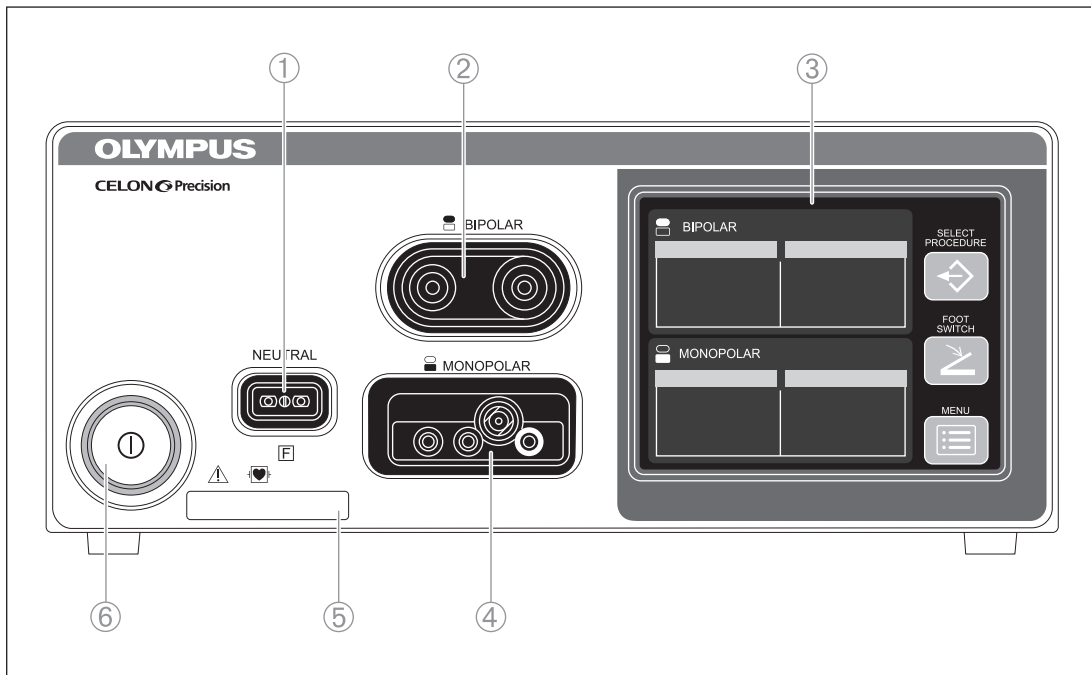

Figure 3.1 Front panel of the CELON Precision

- 1) ***Neutral electrode socket**
To connect a neutral electrode.
- 2) ***BIPOLAR output socket**
To connect a bipolar HF instrument.
- 3) **Touch screen**
To display the status of connected accessories.
To show and modify settings.
- 4) ***MONOPOLAR output socket**
To connect a monopolar HF instrument.

- 5) **UDI (unique device identifier)**
- 6) **Power switch**
To switch the electrosurgical generator on and off.

*Applied part according to standard IEC 60601-1.

3.5.2 The rear panel

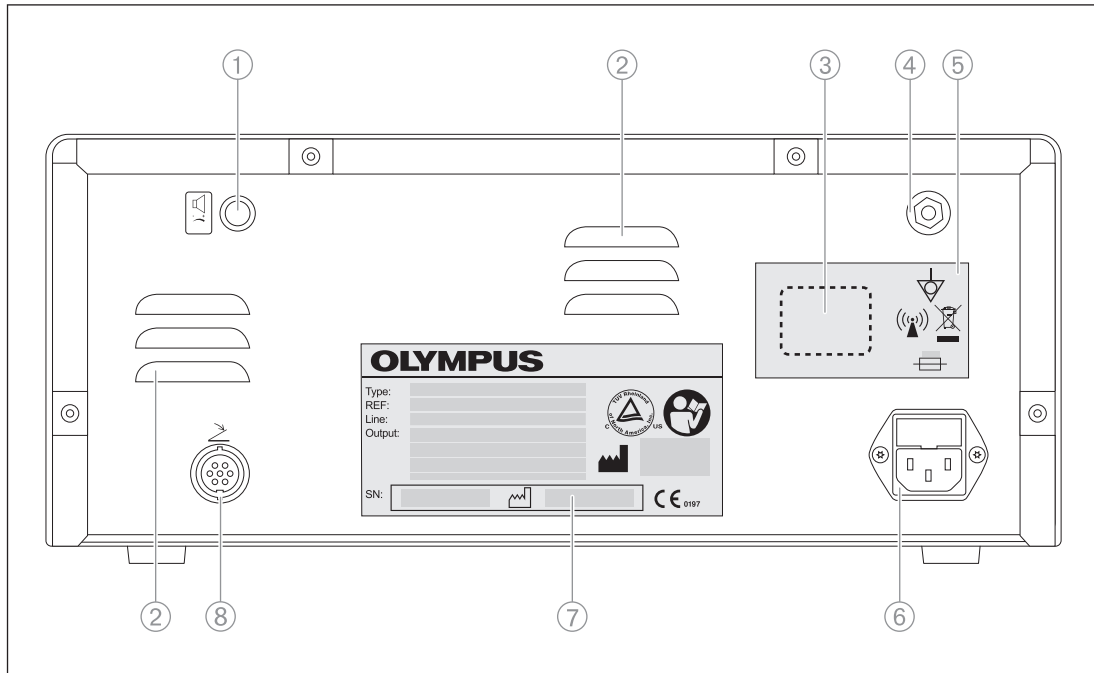

Figure 3.2 Rear panel

- 1) **Volume control**
To adjust the volume of the output tone.
- 2) **Ventilation slots**
- 3) **Place holder for country specific RFID symbol and registration number**
Only applicable for specific countries. Not applicable for the European Union.
- 4) **Equipotential bonding point**
To increase electrical safety by potential equalization
- 5) **Symbol plate**
- 6) **Power socket with fuse holder**
- 7) **Rating plate**
- 8) **Foot switch socket**
To connect the double pedal foot switch.

DRAFT - 2017-01-17

3.5.3 The double pedal foot switch

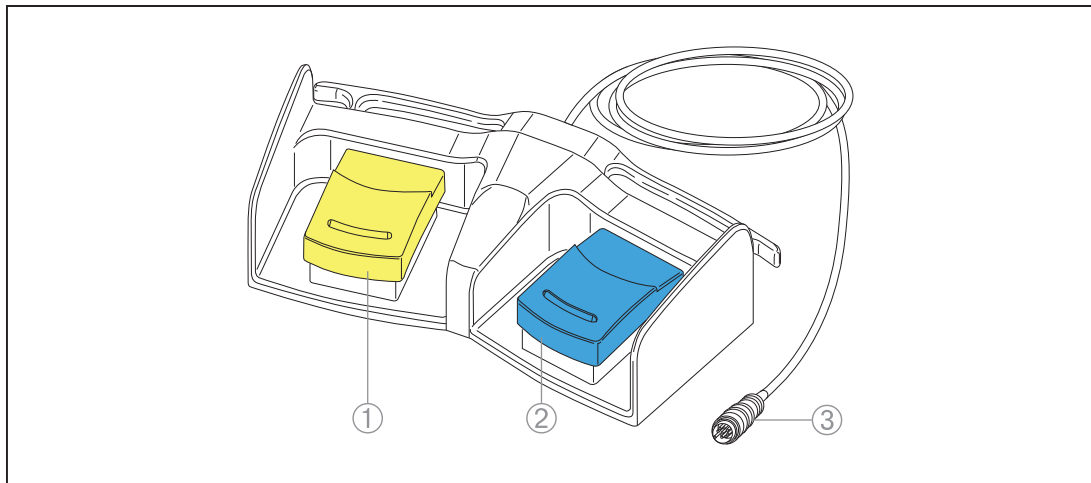

Figure 3.3 Double pedal foot switch

- 1) Cut pedal (yellow)**
To activate the selected cutting mode.
- 2) Coagulation pedal (blue)**
To activate the selected coagulation mode.
- 3) Foot switch plug**
To connect the foot switch to the foot switch socket.

3.5.4 The connecting cable for the neutral electrode

This cable is not included in the delivery scope and may be purchased separately.

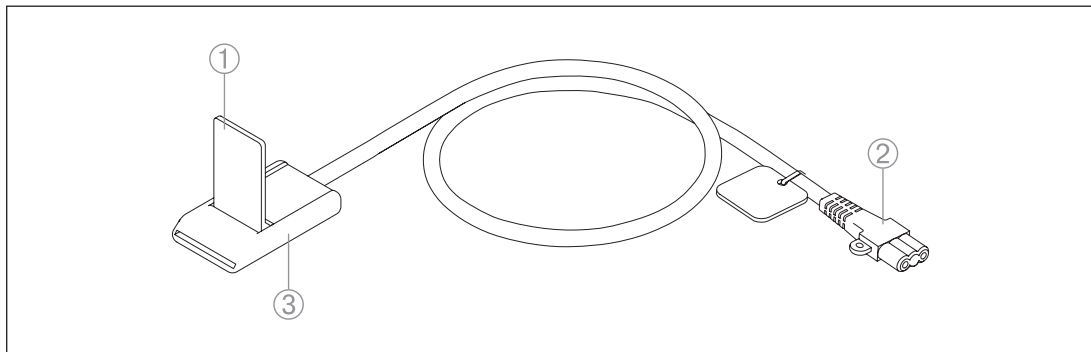

Figure 3.4 Cable for neutral electrode, MAJ-814

- 1) Locking lever**
To lock the neutral electrode in the clamp.
- 2) Plug to front panel of electrosurgical generator**
To connect the neutral electrode to the neutral electrode socket.
- 3) Clamp**
To connect the neutral electrode to the cable.

3.6 Nomenclature and functional principles of the touch screen

The electrosurgical generator is equipped with a user friendly touch screen. The control buttons are activated by tapping the corresponding part on the screen with the finger tip.

3.6.1 The All Screen

The All Screen is the initial screen of the electrosurgical generator. The All Screen displays the current settings of the selected modes as well as the 3 buttons on the right-hand side for system settings.

MONOPOLAR pane, BIPOLAR pane and buttons for system settings

Each pane covers all output socket related information as described below. Tap into the pane to switch to the corresponding Set Screen. On the Set Screen the mode and the output power levels for the corresponding output socket can be set.

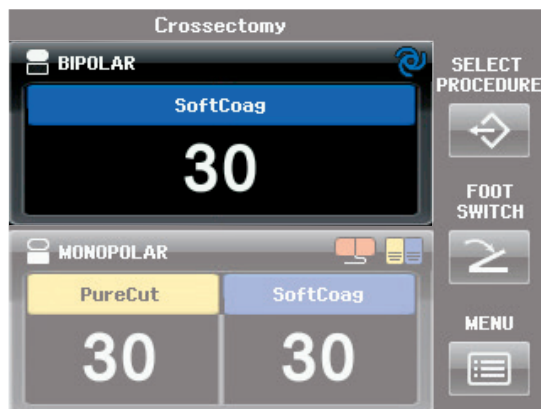

Figure 3.5 BIPOLAR pane



As a default setting the cutting modes for the BIPOLAR socket are switched off, i.e. only the blue coagulation button is displayed in the BIPOLAR pane. It is impossible to access and activate any bipolar cutting mode.

- To switch on the bipolar cutting modes refer to the section “Bipolar Cut Setup” on page 45.

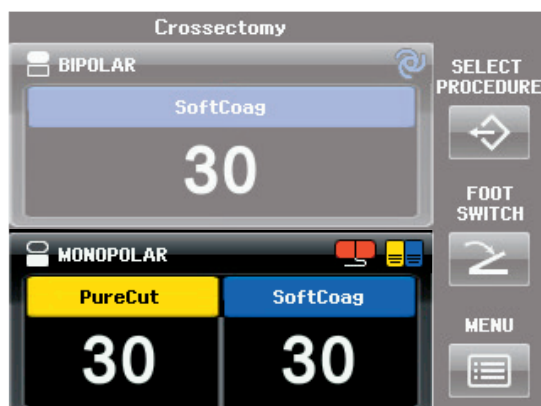

Figure 3.6 MONOPOLAR pane

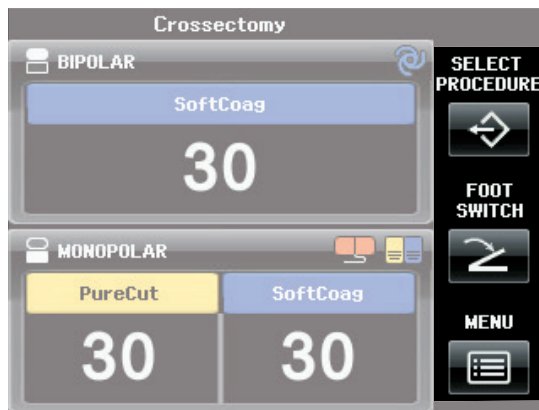

Figure 3.7 Buttons for system settings

Single elements of the All Screen

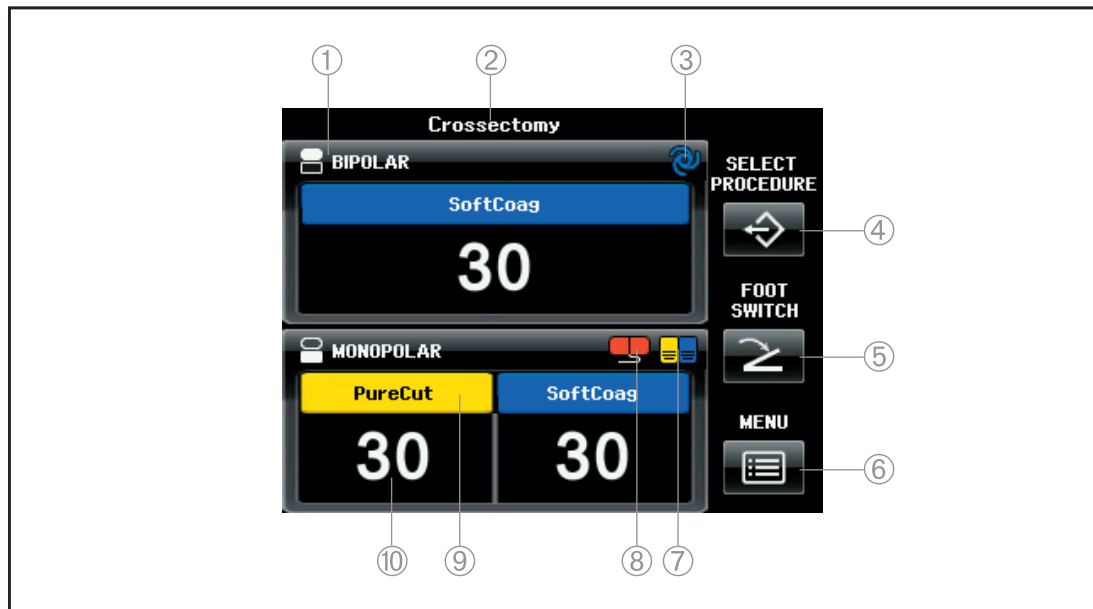

Figure 3.8 Buttons and symbols on the All Screen

- 1) **Output socket indicator and output socket name**
Displays the symbol and the name of the corresponding output socket.
- 2) **Procedure name**
Displays the selected procedure. If no procedure is selected, then this line is blank.
- 3) **Autostart indicator**
Indicates that the Autostart feature is assigned to the corresponding output socket.
- 4) **Button [SELECT PROCEDURE]**
To open the screen [Select Procedure screen] for recalling saved settings.
- 5) **Button [FOOT SWITCH]**
To open the screen [Assign Foot Switch] for assigning the foot switch or the Autostart feature to an output socket.
- 6) **Button [MENU]**
To open the screen [Select Menu] for controlling several functions.
- 7) **Foot switch indicator**
Indicates that a foot switch is assigned to the corresponding output socket.

- 8) **CQM indicator for neutral electrodes**
Indicates the connection status of a neutral electrode.
- 9) **Mode name**
Displays the selected mode.
- 10) **Output power level**
Displays the selected output power level.

3.6.2 The Set Screen

On the Set Screen the mode and the output power levels for the corresponding output socket are set. The Set Screen is displayed when tapping into the pane [BIPOLAR] or [MONOPOLAR] on the All Screen.

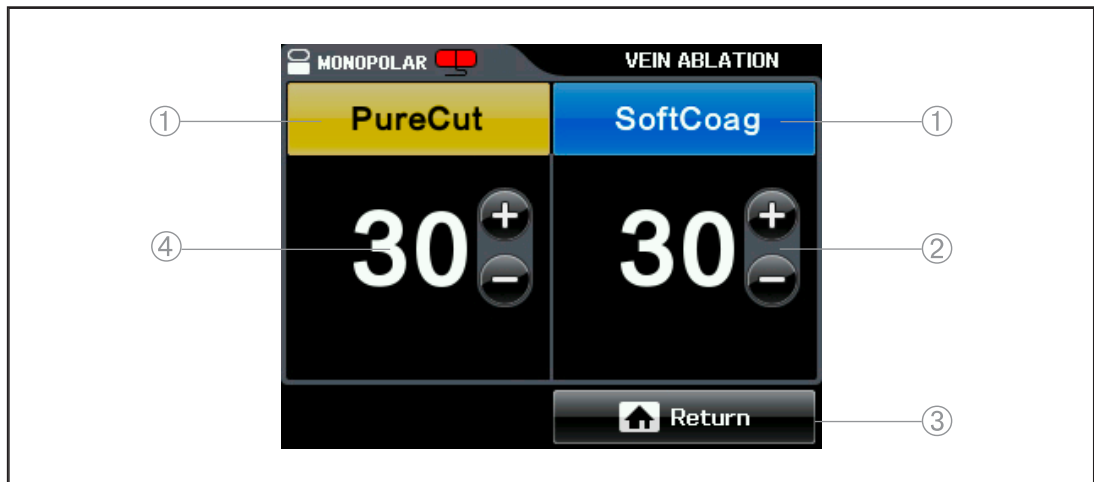

Figure 3.9 Set Screen

- 1) **Mode button**
Displays the name of the output mode as selected in the Mode Screen.
- 2) **Plus and minus button**
To increase and decrease the level of output power.
- 3) **Return button**
To save the settings and to return to the All Screen.
- 4) **Output power level**
To show the selected level of output power.

DRAFT -- 2017-01-17

3.6.3 The Mode Screen

On the Mode Screen the output mode is selected. The Mode Screen is displayed when tapping either the yellow area (cut) or blue area (coagulation) on the Set Screen.

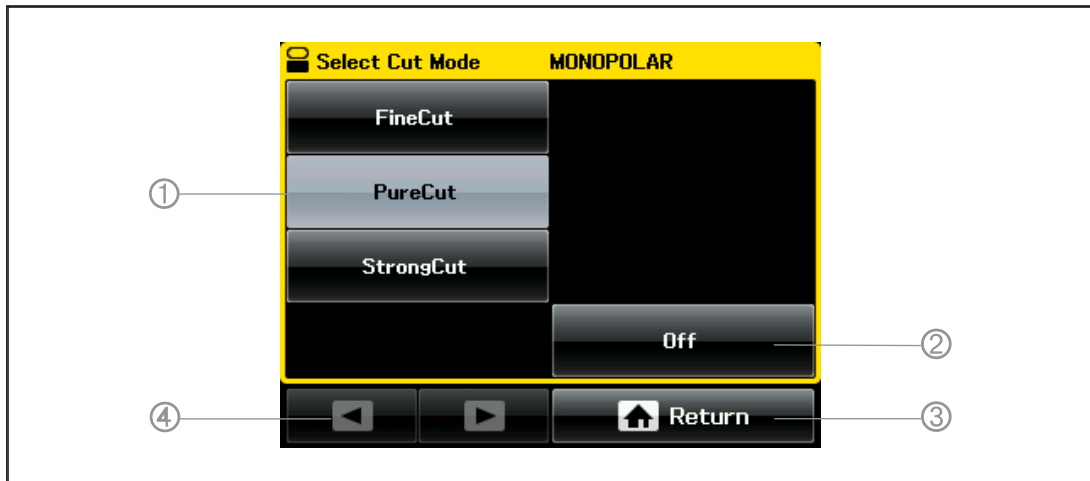

Figure 3.10 Mode Screen for monopolar cutting

- 1) **Mode buttons**
To select a mode for the corresponding output socket (BIPOLAR or MONOPOLAR).
- 2) **Button [Off]**
To completely deactivate cutting/coagulation for the output socket (BIPOLAR or MONOPOLAR).
- 3) **Return button**
To return to the Set Screen.
- 4) **Arrow buttons**
To browse the pages of the Mode Screen.

3.6.4 The screens for system settings

The 3 buttons on the right-hand side of the All Screen give access to the settings of the following screens:

- Select Procedure
- Assign Foot Switch
- Select Menu

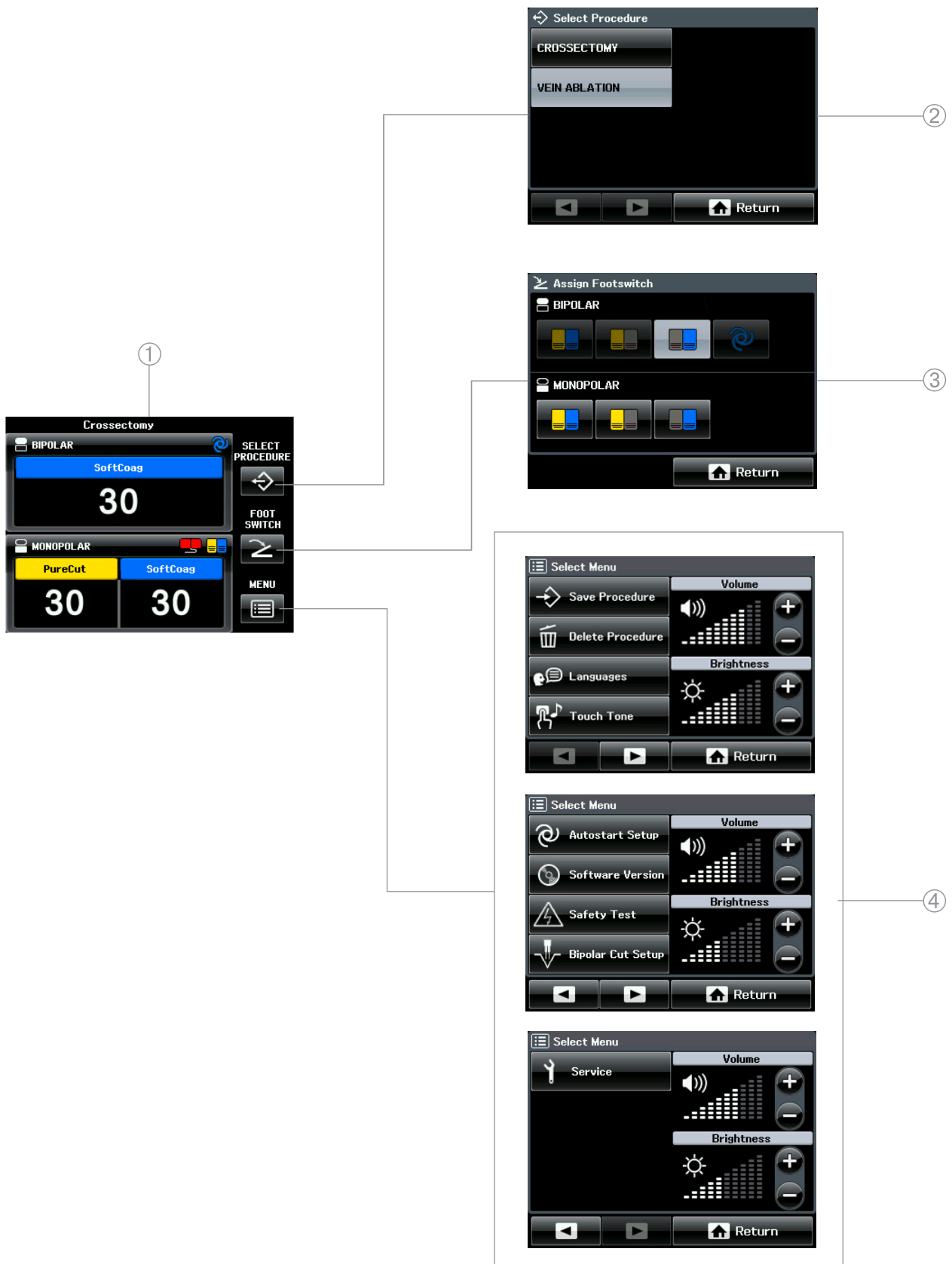

DRAFT - 2017-01-17

Figure 3.11 Hierarchy list of the 3 right-hand sided buttons on the All Screen

- 1) All Screen
- 2) Screen [Select Procedure]
- 3) Screen [Assign Foot Switch]
- 4) Screen [Select Menu]

For detailed information on system settings refer to the chapter “System settings” on page 38.

3.6.5 Icons displayed on the touch screen

	SELECT PROCEDURE		FOOT SWITCH
	MENU		Return
	BIPOLAR output socket		MONOPOLAR output socket
	Non-split type neutral electrode		Split type neutral electrode
	Double pedal foot switch		Autostart
	Plus		Minus
	Previous		Next
	Volume		Brightness
	Save Procedure		Delete procedure
Az a	Upper case/lower case	ABC	Alphabetic
123	Numeric		Back space
	Languages		Software version
	Touch tone on		Touch tone off
	Safety test		Service
	Bipolar cutting on		Bipolar cutting off
	OK		Cancel
	Caution		Reset

Table: Icons displayed on the touch screen

3.7 Warranty

Any warranty claims towards Olympus are forfeited if the user or unauthorized persons attempt repair or modification of the product. No warranty is provided for any damage due to misuse of the product.

DRAFT – 2017-01-17

4 Installation

4.1 General inspection

Before installing and connecting, inspect the electrosurgical generator and its equipment as follows:

- Check that the electrosurgical generator, its equipment and all accessories do not have:
 - any dents, cracks, kinks, or deformations
 - any deep scratches
 - any corrosion
 - any missing or loose parts
- Check all markings on the electrosurgical generator, its equipment and all accessories for clear visibility.

4.2 Placement of the electrosurgical generator

To prevent malfunction or damage of the electrosurgical generator and its accessories take account of the following circumstances when placing the electrosurgical generator:

- Place the electrosurgical generator on a stable, level surface.
- Put the electrosurgical generator upright onto its feet. Do not install the electrosurgical generator on its side or upside down.
- If the electrosurgical generator is placed on a trolley, the trolley must be of adequate strength and size to hold the electrosurgical generator securely.
- Make sure that there is sufficient space at the back of the electrosurgical generator to allow air circulation at the ventilation slots.
- Only use the electrosurgical generator in compliance with the environmental conditions as specified in the chapter "Specifications" on page 88.
- When lifting up, grip the electrosurgical generator at its sides with both hands. Do not hold the electrosurgical generator at its fuse holder.

Interference and automatic instrument recognition

The electrosurgical generator is equipped with a radio transmitting and receiving technology. Other radio transmitters and receivers, e. g. mobile phones, may interfere with the automatic instrument recognition.

- To avoid interference observe the instructions in the chapter "Electromagnetic compatibility" on page 90.

4.3 Connecting the electrosurgical generator to the mains electricity



WARNING Electric shock

In case that a damaged electrosurgical generator is connected inadequately to the mains electricity, there is the risk that internal electrical components conduct voltage to the housing. This could result in electric shock to the user.

- Connect the mains plug of the cord set directly to a grounded fixed socket-outlet.
- If a multiple socket-outlet is used take account of the following:
 - The multiple socket-outlet must be equipped with an insulating transformer of protection class I, conforming to IEC 60601-1.
 - Observe the maximum permitted current or power loading of the multiple socket-outlet and the insulating transformer.



WARNING **Device blackout**

Be aware that the electrosurgical generator immediately turns off if the mains plug is disconnected or if the fuses blow. During a procedure, this could result in severe complications for the patient.

- Make sure that the mains plug is securely connected to the socket-outlet.
- Do not place portable socket-outlets on the floor to avoid trip hazards which could unplug the cord set.
- Only use power cords as specified in the section “Specifications for the cord set” on page 89.
- Make sure that the circuit breaker is sufficient for the power requirements of the electrosurgical generator and additional equipment.

4.3.1 Before connecting

- Make sure that the fixed socket-outlet is grounded.
Only connect the electrosurgical generator to a grounded fixed socket-outlet.
- Make sure that the fixed socket-outlet meets the power requirements as specified on the rating plate of the electrosurgical generator.
Only connect the electrosurgical generator if the power specifications of the fixed socket-outlet match the specifications on the rating plate.

4.3.2 Connecting

To connect the electrosurgical generator to the mains electricity proceed as follows:

1. Make sure that the electrosurgical generator is turned off, i.e. the power switch must not be depressed.

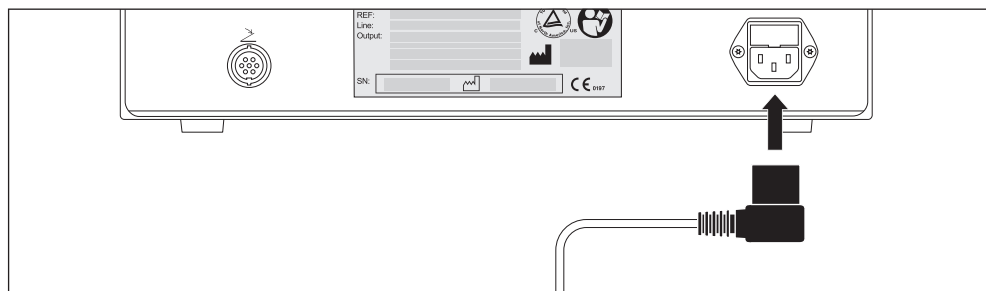

Figure 4.1 Connecting the cord set to the electrosurgical generator

2. Connect one plug of the cord set to the power socket on the rear panel of the electrosurgical generator.
3. Connect the other plug of the cord set to the socket-outlet of the mains electricity.

Equipotential bonding point

The purpose of additional equipotential bonding is to equalise potentials between different metal parts that can be touched simultaneously in the medical environment. Equipotential bonding increases electrical safety.

- Connect the pin at the rear panel of the electrosurgical generator to an equipotential bonding lead, which should be provided by the hospital's technical department.

4.4 Connecting the double pedal foot switch



WARNING

Secure connection of the plug

If the foot switch plug is not connected securely, then the energy output may not be activated. There is the risk that the HF instrument cuts tissue mechanically. This could result in bleeding and perforation of the tissue.

- Securely connect the foot switch plug to the foot switch socket at the electrosurgical generator as described below.



CAUTION

Not waterproof

The foot switch plug is not waterproof. Any liquid, e.g. water, that gets into the plug can damage the foot switch.

- Take care that the foot switch plug does not get wet.



CAUTION

Proper disconnection of the plug

Tugging and pulling at the foot switch cable can break the electric circuit and can damage the foot switch.

- When disconnecting the foot switch plug, directly pull at the plug.
- Do not tug or pull at the cable.



CAUTION

Compatible foot switch

If a non-compatible foot switch is connected to the electrosurgical generator, then the foot switch might not function correctly. This could cause equipment damage which might result in patient injury.

- Only use the compatible foot switch (WB50402W) which is within the scope of delivery.

4.4.1 Before connecting

- Inspect the foot switch and its cord set for scratches, cracks, and other damages.
Do not use the foot switch if any kind of damage is observed.
- Check that the each pedal of the foot switch runs smoothly.
Do not use the foot switch if any kind of problem with the pedals is observed.

4.4.2 Connecting

To connect the double pedal foot switch to the electrosurgical generator proceed as follows:

1. Correctly align the pins inside the foot switch plug with the receptacles of the foot switch socket.

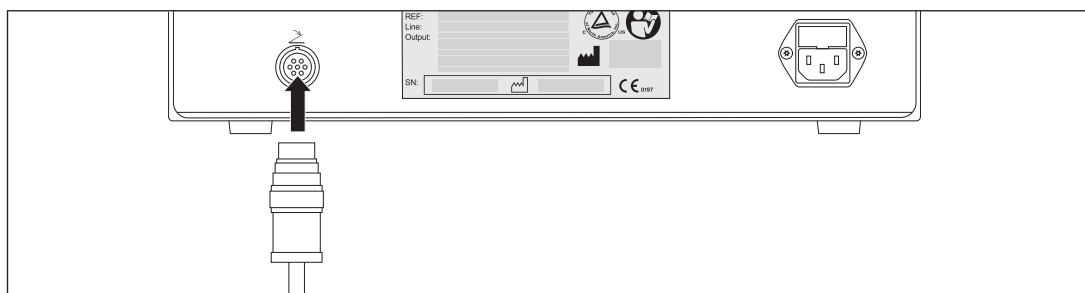

Figure 4.2 Connecting the foot switch to the electrosurgical generator

2. Insert the foot switch plug into the foot switch socket.
3. Rotate the retaining ring clockwise until it is completely tight.

DRAFT – 2017-01-17

5 System settings

5.1 Operation of the touch screen



CAUTION

Operation of the touch screen

Wrong operation of the touch screen can cause malfunction or damage to the touch screen.

- Only tap one button or pane at a time.
- Only tap the touch screen from the front. Avoid oblique angles when tapping the touch screen.
- Do not use pointed objects, e.g. a pen, to tap the touch screen.
- Do not tap the touch screen unintentionally.
- Do not apply excessive loads on the surface of the touch screen.
- Remove dust and dirt by wiping the touch screen with a cloth.

Operator's position

- The operator of the touch screen must be in front of the electrosurgical generator.
- For parameter settings the viewing distance must not exceed 50 cm.
- For watching the touch screen the viewing distance must not exceed 100 cm.
- All viewing angles, i.e. left, right, upper, lower angle, must not exceed 70°.

5.2 Overview of system settings

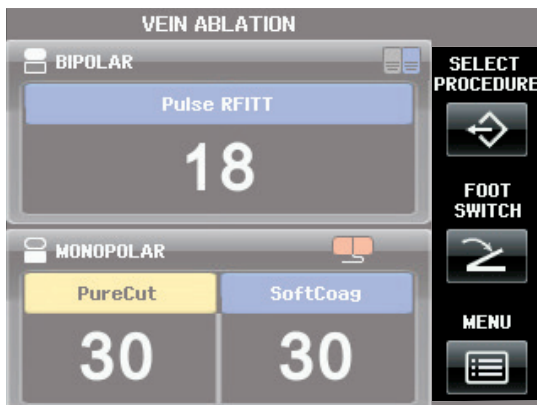

Figure 5.1 Buttons for system settings

The 3 buttons on the right-hand side of the All Screen give access to various system settings. The following table gives a short introduction to system settings. Detailed information on the single settings are give in the following sections.

Buttons		Function
SELECT PROCEDURE		Selecting previously saved, preferred settings.
FOOT SWITCH		Assigning the foot switch and Autostart.
MENU	Save Procedure	Saving or overwriting of output settings.
	Delete Procedure	Deleting previously saved settings.
	Languages	Selecting the preferred language. Available languages: English, Japanese, German, Chinese, French, Italian, Spanish and Portuguese.
	Touch Tone	Activating or deactivating the audible feedback when tapping the touch screen.
	Autostart Setup	Setting a time delay for Autostart.
	Software Version	Showing information about the installed software version.
	Safety Test	Opening or closing the output relays. Required for the annual safety check.
	Bipolar Cut Setup	Switching the cutting modes for the BIPOLAR socket on or off.
	Service	Accessing the service screen. For the technical service only. This screen is password protected.
	Volume	Increasing or decreasing of the volume of the output tone.
	Brightness	Increasing or decreasing of the brightness of the touch screen.

Table: Overview of system settings

5.3 Select Procedure settings

Use this function to select procedure settings that were saved previously.



Figure 5.2 Screen [Select Procedure]

i There are no factory settings provided for this function. If no settings are saved, the message [No procedure saved] is displayed on the screen [Select Procedure]. Refer to the section "Save Procedure - Saving and overwriting procedure settings" on page 41.

To select one of the saved procedure settings proceed as follows:

1. Tap [SELECT PROCEDURE] on the All Screen.
 - The screen [Select Procedure] is displayed with a list of saved procedure settings.
 - An already selected procedure is indicated by a highlighted button.
 - If no procedure settings are saved, the message [No procedure saved] is displayed.
 - To return to the All Screen tap [Return].
2. Tap the button of the procedure to be selected.
 - The All Screen is displayed which shows the settings of the selected procedure.
 - In the headline of the All Screen the name of the selected procedure is displayed.

5.4 Foot switch assignment and Autostart

Foot switch pedals

Use this function to assign the double pedal foot switch either to the BIPOLAR output socket or to the MONOPOLAR output socket. It is also possible to assign one pedal of the foot switch to the BIPOLAR output socket and the other pedal to the MONOPOLAR output socket.



As a default setting the cutting modes for the BIPOLAR socket are switched off. Therefore, it is impossible to assign the yellow cut pedal to the BIPOLAR socket.

- To switch on the bipolar cutting modes refer to the section “Bipolar Cut Setup” on page 45.

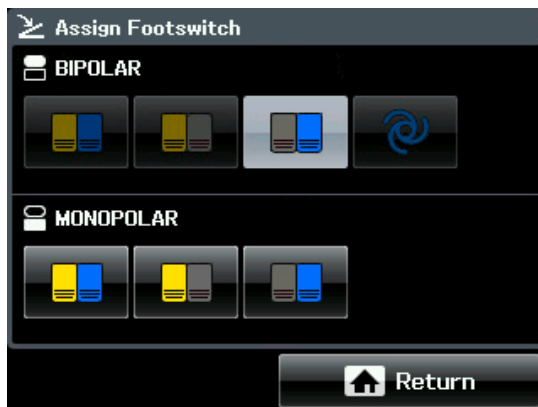

Figure 5.3 Screen [Assign Foot Switch]

Autostart and time delay

For the bipolar mode SoftCoag the feature Autostart can be assigned to the BIPOLAR output socket. Refer to the sections “Autostart for the bipolar mode SoftCoag” on page 22 and “Autostart Setup” on page 44.

Highlighted buttons

The chosen assignments are indicated by highlighted buttons. The figure above shows that the blue coagulation pedal is assigned to the BIPOLAR output socket. To the MONOPOLAR output socket nothing is assigned. If the foot switch is not connected properly, then no button is highlighted and it is impossible to assign the foot switch or Autostart.

To assign the foot switch or Autostart to the output sockets proceed as follows:

1. Tap [FOOT SWITCH] on the All Screen.

- The screen [Assign Foot Switch] is displayed.
- In the BIPOLAR pane of the screen tap the button for the required function, i.e. double pedal, only yellow pedal, only blue pedal or Autostart.
 - In the MONOPOLAR pane tap the button for the required foot switch, i.e. double pedal, only yellow pedal or only blue pedal.
 - Tap [Return] to confirm the settings.
The All Screen is displayed.



Limited power for Autostart

If the output power level is above 50 when selecting Autostart, then the output power level is reduced to 50 automatically.

5.5 Select Menu settings

Use this function to adjust the menu settings as summarized in the table “Overview of system settings” on page 38.

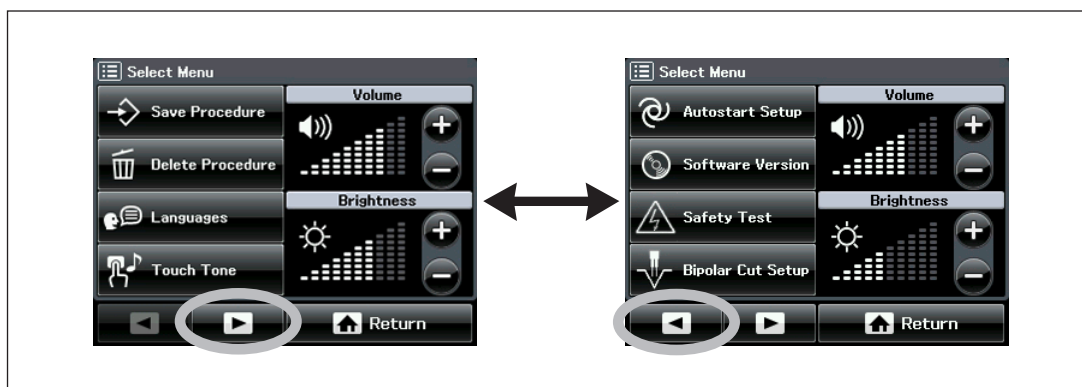

Figure 5.4 Screen [Select Menu]

When opening the screen [Select Menu] there are 2 arrow buttons at the bottom.

- Tap [MENU] on the All Screen.
The screen [Select Menu] is displayed.
- Use the arrow buttons to browse back and forth between the pages of the screen [Select Menu].



Cancel button

For most of the following menu settings it is possible to interrupt the operation by tapping [Cancel] until the screen [Select Menu] is displayed again.

5.5.1 Save Procedure - Saving and overwriting procedure settings



The delay for Autostart cannot be saved within a procedure setting.

Use this function to save all output settings that are currently displayed on the All Screen under a certain procedure name. In detail this is:

- The bipolar modes for cutting and coagulation and their output levels.
- The monopolar modes for cutting and coagulation and their output levels.
- The assignment of the foot switch or Autostart for the bipolar mode SoftCoag.

It is possible to save up to 39 different procedure settings and to overwrite existing settings.

The onscreen keyboard

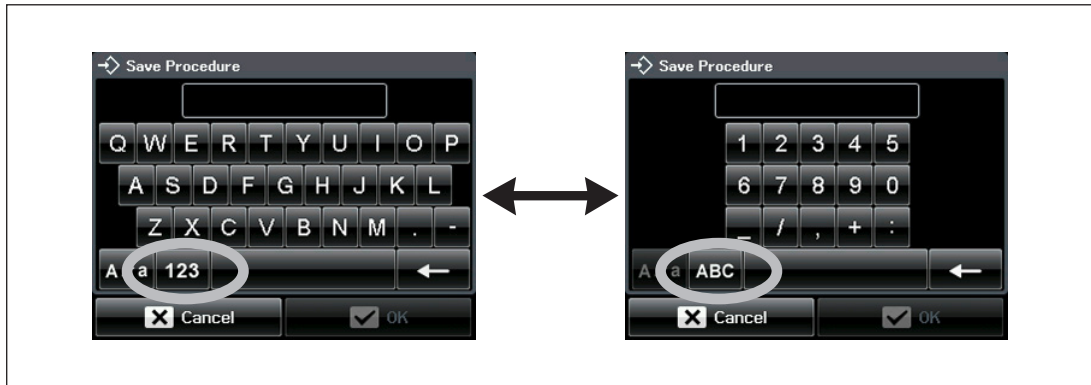

Figure 5.5 Onscreen keyboard (letters and numbers)

- To switch between letters and numbers tap [123] or [ABC] at the bottom of the keyboard.

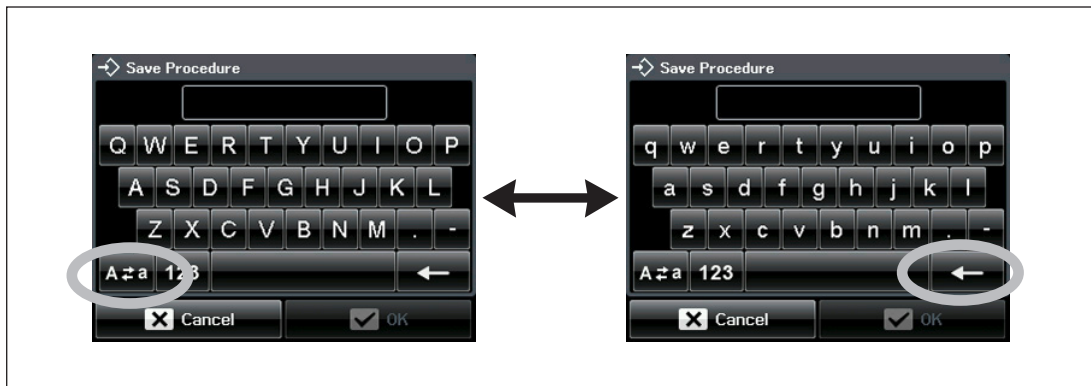

Figure 5.6 Onscreen keyboard (upper/lower key and backspace key)

- To switch between upper-case letters and lower-case letters tap the shift key at the bottom left of the keyboard.
- To delete characters tap the backspace key on the bottom right of the keyboard.

Saving a new procedure setting

To save the current output settings proceed as follows:

1. Tap [MENU] on the All Screen.
The screen [Select Menu] is displayed.
2. Tap [Save Procedure].
The screen [Save Procedure] is displayed.
3. Tap [New Procedure].
The screen changes to an onscreen keyboard.
4. Enter a name for the procedure setting.
5. Tap [OK] to save the procedure name.
 - A message box is displayed which confirms that the procedure settings are saved.
 - Then the All Screen is displayed.
 - In the headline of the All Screen the procedure name is displayed.

i If a procedure name already exists, then a message box is displayed that asks for confirmation to overwrite the existing procedure settings. Refer to the section below.

Overwriting a procedure setting

1. Tap [MENU] on the All Screen.
The screen [Select Menu] is displayed.
2. Tap [Save Procedure].
The screen [Save Procedure] is displayed.
3. Use the arrow buttons to browse back and forth the pages of the screen.
4. Tap the name of the procedure settings to be overwritten.
A message box with a request for confirmation is displayed.
5. To overwrite the existing procedure settings tap [OK] in the message box.
 - Another message box is displayed which confirms that the procedure settings are saved.
 - Then the All Screen is displayed.

5.5.2 Delete Procedure

To delete an existing procedure setting from the memory proceed as follows:

1. Tap [MENU] on the All Screen.
The screen [Select Menu] is displayed.
2. Tap [Delete Procedure].
The screen [Delete Procedure] is displayed.
3. Use the arrow buttons to browse back and forth the pages of the screen.
4. Tap the procedure name of the settings to be deleted.
A message box with a request for confirmation is displayed.
5. Tap [OK] to delete the procedure settings.
 - Another message box is displayed which confirms that the procedure settings are deleted.
 - Then the screen [Select Menu] is displayed.

5.5.3 Languages

Use the language function to select the preferred language. The text on the touch screen can be displayed in 8 different languages:

- English
- German
- French
- Italian
- Japanese
- Chinese
- Spanish
- Portuguese

To select the preferred language proceed as follows:

1. Tap [MENU] on the All Screen.
The screen [Select Menu] is displayed.
2. Tap [Languages].
 - The screen [Select Language] is displayed.
 - The language currently selected is highlighted.
3. Tap the button of the preferred language.
A message box with a request for confirmation is displayed.
4. Tap [OK] to change the language setting.
 - The language is changed.
 - Then the screen [Select Menu] is displayed.

5.5.4 Touch Tone

Use this function to turn on or off the audible feedback when tapping the touch screen. As a default setting the audible feedback is turned off.

To turn the audible feedback on or off proceed as follows:

1. Tap [MENU] on the All Screen.
The screen [Select Menu] is displayed.
2. Tap [Touch Tone].
 - The screen [Touch Tone] is displayed.
 - The current setting is highlighted.
3. Tap [On] or [Off] to turn the touch tone on or off.
The selected choice is highlighted.
4. Tap [OK].
The screen [Select Menu] is displayed.

5.5.5 Autostart Setup

Use this function to set a time delay for the feature Autostart. With a time delay the electrosurgical generator does not activate immediately when the HF instrument touches the tissue but waits until the specified time has expired.

The time delay is specified in seconds. It is possible to enter a value between 0.0 and 9.9 seconds. The default setting is 1.0 s.



- The Autostart feature is available only for the bipolar coagulation mode SoftCoag.
- Precondition: The Autostart feature is assigned to the BIPOLAR output socket. Refer to section "Foot switch assignment and Autostart" on page 40.

To set the time delay for the Autostart feature proceed as follows:

1. Tap [MENU] on the All Screen.
The screen [Select Menu] is displayed.
2. Tap the arrow button [Next] to browse to the next page of the screen [Select Menu].
3. Tap [Autostart Setup].
 - The screen [Autostart Setup] is displayed.
 - The current time delay is displayed in seconds.
4. Tap [+] or [-] to modify the current setting.
5. Tap [OK] to save the current setting.
The screen [Select Menu] is displayed.

5.5.6 Software Version

This function displays the currently installed software version of the electrosurgical generator.

To display the software version proceed as follows:

1. Tap [MENU] on the All Screen.
The screen [Select Menu] is displayed.
2. Tap the arrow button [Next] to browse to the next page of the screen [Select Menu].
3. Tap [Software Version].
The currently installed software version is displayed.
4. Tap [OK] to return to the screen [Select Menu].

5.5.7 Safety Test

This function is required for the annual safety check. Refer to the chapter “Maintenance, repair and shipment” on page 84. This function is used to close the output relays which disables the electrosurgical generator for normal operation. Closed output relays are needed to perform measurements.

- The default setting is [Relays Off]:
The relays are open and the electrosurgical generator is enabled for normal operation.
 - The setting [Relays On]:
The relays are closed. The electrosurgical generator is disabled for normal operation.
- As soon as the user exits this menu function, the relay setting is automatically set to default, i.e. normal operation of the electrosurgical generator.

To open or close the output relays proceed as follows:

1. Tap [MENU] on the All Screen.
The screen [Select Menu] is displayed.
2. Tap the arrow button [Next] to browse to the next page of the screen [Select Menu].
3. Tap [Safety Test].
 - The screen [Safety Test] is displayed.
 - The current setting is highlighted.
4. Tap [Relays On] or [Relays Off].
The new setting is highlighted.
5. Tap [Cancel] to return to the screen [Select Menu].

5.5.8 Bipolar Cut Setup

The electrosurgical generator provides the options to switch the bipolar cutting modes on or off. If the bipolar cutting modes are switched on, the BIPOLAR pane is divided into a yellow button for cutting and a blue button for coagulation. The user can access and activate all bipolar cutting modes.

As a default setting the cutting modes for the BIPOLAR socket are switched off, i.e. only the blue coagulation button is displayed in the BIPOLAR pane. It is impossible to access and activate any bipolar cutting mode.

To switch the bipolar cutting modes on or off proceed as follows:

1. Tap [MENU] on the All Screen.
The screen [Select Menu] is displayed.
2. Tap the arrow button [Next] to browse to the next page of the screen [Select Menu].
3. Tap [Bipolar Cut Setup].
 - The screen [Bipolar Cut Setup] is displayed.
 - The current setting is highlighted.
4. Tap [On] or [Off].
The new setting is highlighted.
5. Tap [OK] to return to the screen [Select Menu].

5.5.9 Service

This function is not intended for customer use. It is password protected and only accessible for authorized service centers.

5.5.10 Volume control



WARNING

The output tones play an important role to notice the output power when the electrosurgical generator is activated. If the output tones are inaudible, then activation may not be recognized by the user. This could result in injury to the patient.

- Make sure that the output tones are at an audible volume level.
- Adjust the volume level of the output tones to the ambient noises.

The volume of the output tone can be adjusted either with the volume control on the rear panel of the electrosurgical generator or via touch screen. However, during activation, it is impossible to enter the screen [Select Menu]. Therefore, the volume needs to be adjusted with the volume control at the rear panel during activation.

The volume settings range from 1 to 10. The default setting is 7.

To set the volume for the output tone via the touch screen proceed as follows:

1. Tap [MENU] on the All Screen.
The screen [Select Menu] is displayed.



Figure 5.7 Volume control

2. In the volume pane tap [+] to increase the volume. Tap [-] to decrease the volume of the output tone.



Volume of error tones

The volume of the error tones (low, medium and high priority errors) are not adjustable. Refer to the chapter “Troubleshooting” on page 76 and to the sections “Alarm system” on page 95 and “Output tone information” on page 96 in the Appendix A.

5.5.11 Brightness control

Use this function to control the brightness of the touch screen. The brightness settings range from 1 to 10. The default setting is 5.

To set the brightness proceed as follows:

1. Tap [MENU] on the All Screen.
The screen [Select Menu] is displayed.

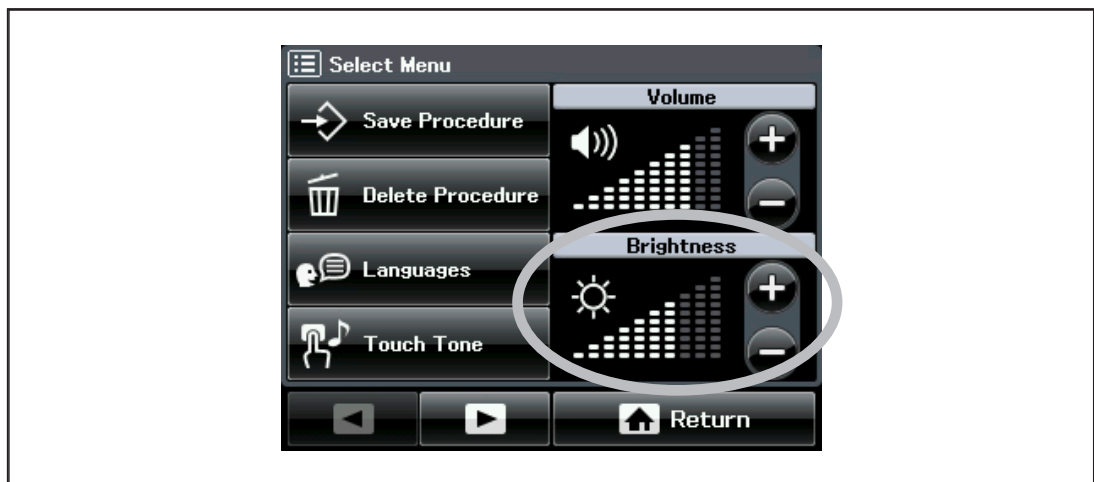

Figure 5.8 Brightness control

2. In the brightness pane tap [+] to increase the brightness. Tap [-] to decrease the brightness of the touch screen.

6 Connecting HF instruments

6.1 Safety information for connecting HF instruments



WARNING

Proper connection of the plug

If the HF instrument's plug is not connected properly, then the energy output may not be sufficient. There is the risk that the HF instrument cuts tissue mechanically. This could result in bleeding and perforation of the tissue.

- Properly connect the plug of the HF instrument to the corresponding output socket of the electro-surgical generator as described in the following sections.



CAUTION

Correct connection of a monopolar 1-pin plug with 4 mm pin diameter



Figure 6.1 CAUTION - Correct connection of a monopolar 1-pin plug with a 4 mm pin diameter

If a 1-pin plug with a pin diameter of 4 mm is connected to any other receptacle than the right-hand receptacle of the MONOPOLAR output socket, then the output socket may be destroyed during activation.

- Connect a 1-pin plug with a 4 mm pin diameter only the right-hand receptacle as shown in the figure above.



CAUTION
No connection of a 2-pin plug with 4 mm pin diameters

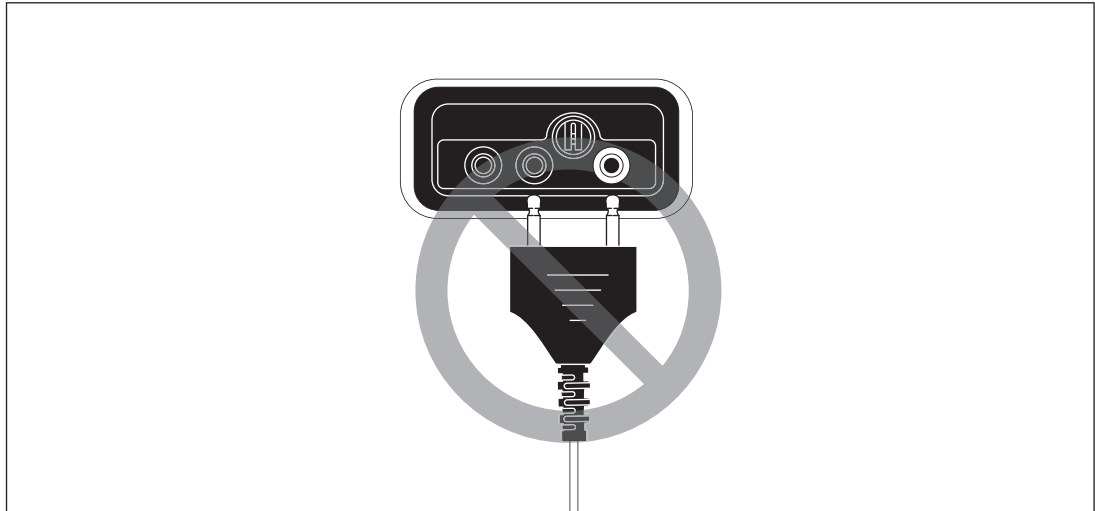

Figure 6.2 CAUTION - Do not connect a 2-pin plug with 4 mm pin diameters to the MONOPOLAR socket

Connecting a 2-pin plug with pin diameters of 4 mm, e.g. hand switch activated monopolar forceps, to the MONOPOLAR output socket can damage the electrosurgical generator.

- Do not connect monopolar HF instruments with 2-pin plugs.
- Only connect plugs to the MONOPOLAR output socket as specified in the section "Description of the output sockets" on page 49.



CAUTION
No connection of plugs with single connecting pins

If bipolar HF instruments are used, that have single plugs for each connecting pin, then there is the risk that the single plugs are connected accidentally to the wrong receptacles. This could result in damage of the electrosurgical generator.

- Only use bipolar HF instruments that have plugs as described in the section "BIPOLAR output socket specifications (applied part)" on page 50.

6.2 Description of the output sockets

Monopolar and bipolar instruments

The electrosurgical generator can be used with monopolar cutting and coagulation instruments as well as with bipolar cutting and coagulation instruments. The HF instruments must have an appropriate plug to connect either into the MONOPOLAR socket or the BIPOLAR socket, see socket descriptions below.

Maximum output voltage

When connecting HF instruments avoid generator settings, e.g. mode, effect, where the maximum output voltage exceeds the allowed peak voltage of the HF instrument. Refer to the sections about mode and output characteristics in the "Appendix A" on page 95. Also refer to the instructions for use of the HF instrument.

MONOPOLAR output socket for WA90008A (applied part)

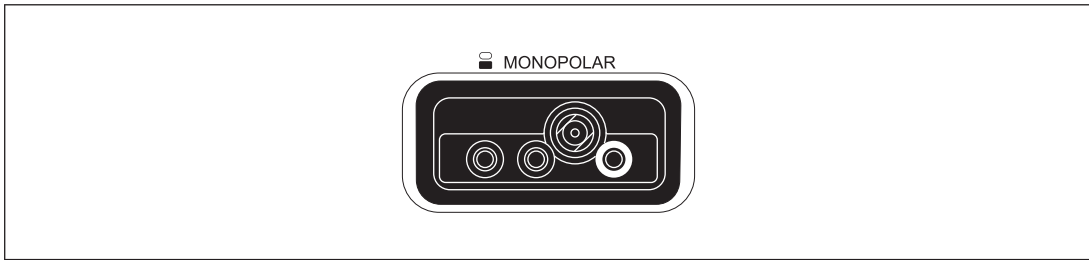

Figure 6.3 MONOPOLAR output socket specifications for WA90008A

This MONOPOLAR output socket is suitable for the following monopolar plugs:

- 3-pin plug with 4 mm pin diameter (international /Valleylab standard)
- Coaxial plug with 9/5 mm pin diameter (Erbe standard)
- 1-pin plug with 4 mm pin diameter

MONOPOLAR output socket for WA90009A (applied part)

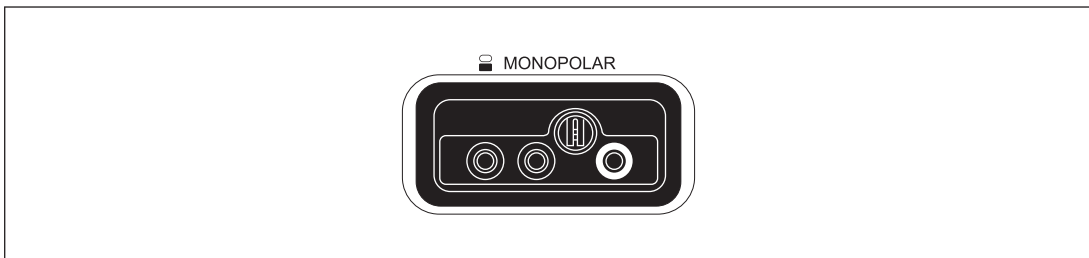

Figure 6.4 MONOPOLAR output socket specifications for WA90009A

This MONOPOLAR output socket is suitable for the following monopolar plugs:

- 3-pin plug with 4 mm pin diameter (international/Valleylab standard)
- 1-pin plug with 8 mm pin diameter (Bovie standard)
- 1-pin plug with 4 mm pin diameter

BIPOLAR output socket specifications (applied part)

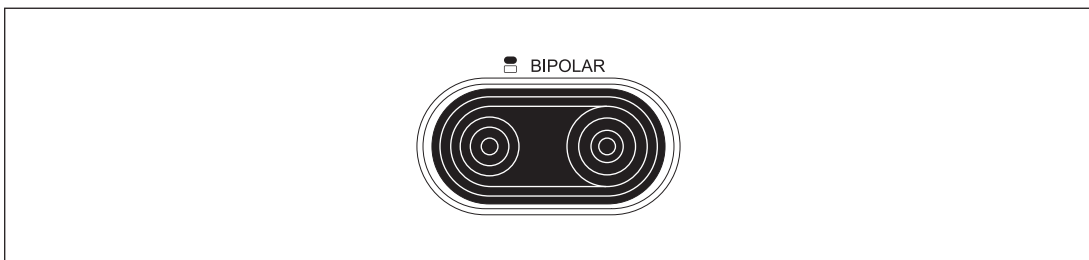

Figure 6.5 Bipolar output socket specifications

The BIPOLAR output socket is suitable for the following bipolar plugs:

- 2-pin plug with 4 mm pin diameter, fixed pin spacing 28.6 mm (international /Valleylab standard)
- Coaxial plug with 8/4 mm pin diameter (Erbe standard)

6.3 Connecting

To connect an HF instrument to the electrosurgical generator proceed as follows:

1. Refer to the instructions for use of the HF instrument.
2. Inspect the HF instrument, its connection cable and plug for scratches, cracks, and other damages.
Do not use the HF instrument if any kind of damage is observed.
3. Properly insert the plug of the HF instrument into the corresponding output socket on the front panel of the electrosurgical generator.

DRAFT – 2017-01-17

7 Neutral electrode operation

Only for monopolar treatments

Only for monopolar treatments neutral electrodes are required to return the HF current from the active electrode of the HF instrument back to the electrosurgical generator. In bipolar electrosurgery both electrodes, the active and the return electrode, are implemented within the HF instrument.

7.1 Safety information for neutral electrode operation

Improper connection between the neutral electrode and the patient's skin surface may cause burns.

- When attaching a neutral electrode, consider the safety notes as described below.
- For further details on neutral electrodes, refer to the specific instructions for use of the neutral electrode.



DANGER

Neutral electrodes for infants

If the output power of the electrosurgical generator exceeds the permissible power of a neutral electrode for infants (patient weight 0...15 kg), then this will result in severe burns to the patient.

- Only use output settings within the permissible range of output power for the neutral electrode. Refer to the instructions for use of the neutral electrode.



WARNING

Size of neutral electrodes

If the size of the neutral electrode is too small for the patient, then this could result in burns to the patient.

- Choose the largest possible neutral electrode that is adequate for the patient.
- Consider the size of the neutral electrode particularly for obese patients.
- Consider the size of the neutral electrode particularly if high output power levels are needed.



WARNING

Non-split type neutral electrodes

If non-split type neutral electrodes are used, then the contact quality monitor does not work. In case that the non-split type neutral electrode detaches from the patient, then no warning signal sounds. This could result in burns to the patient.

- Only use split type neutral electrodes. Refer to the section "Compatible neutral electrodes" on page 87.



WARNING

Mechanical tissue cutting

If the HF instrument is at the treatment site when a neutral electrode failure is indicated, then tissue might be cut mechanically with the HF instrument. This could result in bleeding and perforation.

- Note that the output of energy automatically stops when the CQM indicates a neutral electrode failure.

7.2 Split type and non-split type neutral electrodes and CQM

Contact quality monitoring (CQM) for split type neutral electrodes

If a split type neutral electrode is connected to the electrosurgical generator, it is possible to detect unintended detachment of the neutral electrode from the patient. If the contact between the neutral electrode and the patient's skin is insufficient, the split type CQM indicator shines red. Furthermore, an alarm tone sounds and the following error message is displayed on the touch screen:

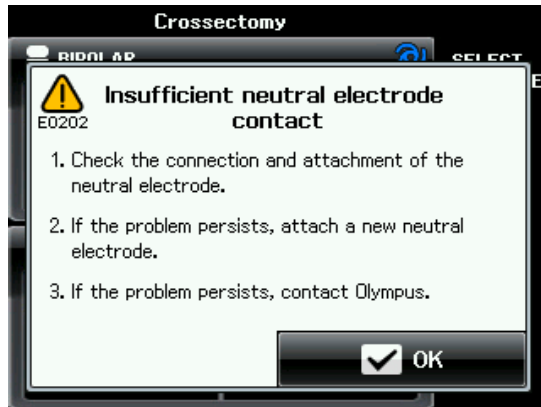

Figure 7.1 Error message E0202 “Insufficient neutral electrode contact”

In this case, the activation of the electrosurgical generator is stopped automatically. The neutral electrode must be reattached or a new one must be used. The split type CQM indicator will only shine green while the contact between the neutral electrode and the skin of the patient is within an acceptable resistance range, see section “Specifications for the CELON Precision” on page 88.

No contact quality monitoring for non-split type neutral electrodes

If a non-split type neutral electrode is connected to the electrosurgical generator, it is impossible to detect any detachment of the neutral electrode from the patient. When connecting a non-split type neutral electrode, the following message box is displayed on the touch screen:



Figure 7.2 Message box “Neutral electrode”

To avoid unintended use of a non-split type neutral electrode the displayed message must be confirmed by the user.

The CQM indicator for non-split type neutral electrodes shines green if a non-split type neutral electrode is detected.

7.3 Meaning of CQM indicator condition

The CQM indicator can take on the following conditions:



Indicator for split type neutral electrodes shines green

- CQM detects a split type neutral electrode.
- Sufficient contact between the neutral electrode and the patient's skin.
- Activation is possible.
- Continue with the procedure.



Indicator for split type neutral electrodes shines red

During activation:	During standby:
<p>1) Insufficient contact between the neutral electrode and the patient's skin.</p> <p>2) The connection between the neutral electrode and the electrosurgical generator is interrupted.</p> <ul style="list-style-type: none"> - Activation stops automatically. - An alarm tone sounds and the error message E0202 "Insufficient neutral electrode contact" is displayed. <ul style="list-style-type: none"> • Follow the instructions given in the error message. 	<p>1) No neutral electrode connected.</p> <p>2) Insufficient contact between the neutral electrode and the patient's skin.</p> <ul style="list-style-type: none"> - Activation is disabled.



Indicator for non-split type neutral electrodes shines green

! If a split type neutral electrode is connected:	If a non-split type neutral electrode is connected:
<p>1) CQM cannot detect the split type neutral electrode.</p> <p>2) The split type neutral electrode has a short circuit.</p> <ul style="list-style-type: none"> - The message box "Neutral electrode" (Figure 7.2) is displayed. <ul style="list-style-type: none"> • Tap [OK] to confirm the message. • Replace the split type neutral electrode. 	<p>1) CQM detects a non-split type neutral electrode.</p> <ul style="list-style-type: none"> - Activation is possible. <ul style="list-style-type: none"> • Continue with the procedure.

7.4 Correct usage of neutral electrodes

For the safe use of neutral electrodes refer to the instructions for use of the correspondent neutral electrode and take account of the following:

Compatible neutral electrodes

The section "Compatible neutral electrodes" on page 87 lists different neutral electrodes that are compatible for the use with the electrosurgical generator.

- Only use compatible neutral electrodes as listed in the section “Compatible neutral electrodes” on page 87.
- Only use self-adhesive neutral electrodes to prevent compression necrosis.
- Do not use capacitive coupling neutral electrodes.

Immaculate neutral electrodes

- Check the use by date of the neutral electrode. Only use neutral electrodes with an unexpired use by date.
- Check the packaging of the neutral electrode. Only use neutral electrodes with an immaculate packaging.
- Check the neutral electrode for damages, modifications and sharp edges. Only use immaculate neutral electrodes.

Safe attachment

- Do not fold or wrinkle the neutral electrode. Only attach neutral electrodes that have a smooth surface.
- Make sure that the site to which the neutral electrode is attached is clean, dry and free from hair.
- Make sure that the entire surface of the neutral electrode is in direct contact with the patient's skin.
- Do not attach the neutral electrode in the vicinity of a metal implant.
- Do not place the neutral electrode over bony prominences or on scar tissue.
- Apply the long edge of the neutral electrode to face the surgical site.
- If the patient is repositioned during surgery, confirm proper contact between the neutral electrode and the patient's skin as well as the integrity of cable and clamp connections before continuing.
- Do not reposition or relocate a the neutral electrode after initial application.

Removing

- When removing, start at the corner and gently peel of the neutral electrode from the patient's skin.

7.5 Connecting to the electrosurgical generator

Neutral electrode socket specifications

The neutral electrode socket at the electrosurgical generator is suitable for the following plugs:

- Plugs with 2 sockets
- 2.5 mm socket diameter
- Socket spacing: 10 mm

7.5.1 Connecting a neutral electrode with a pre-attached cable

- To connect a neutral electrode with a pre-attached cable refer to the instructions for use of the neutral electrode.

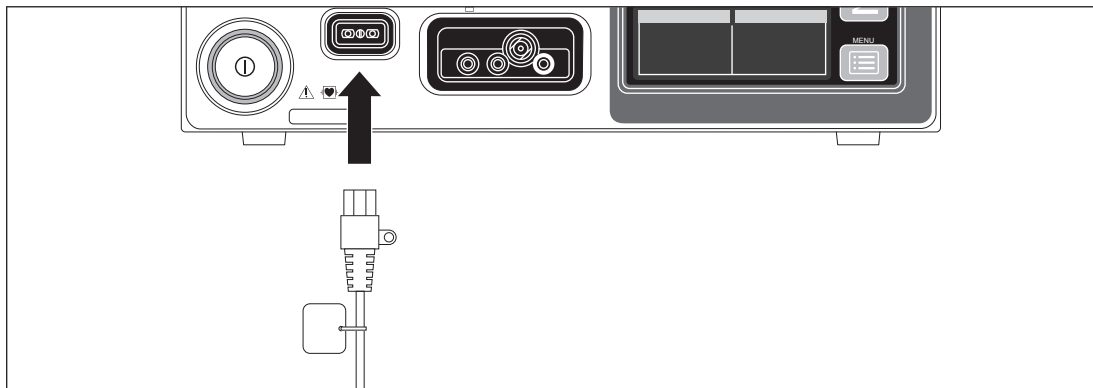

Figure 7.3 Connecting the plug of the neutral electrode

- Insert the plug of the neutral electrode into the neutral electrode socket on the front panel of the electrosurgical generator.

7.5.2 Connecting a neutral electrode without a pre-attached cable

To connect a neutral electrode without a pre-attached cable proceed as follows:

- Refer to the instructions for use of the connecting cable and of the neutral electrode.

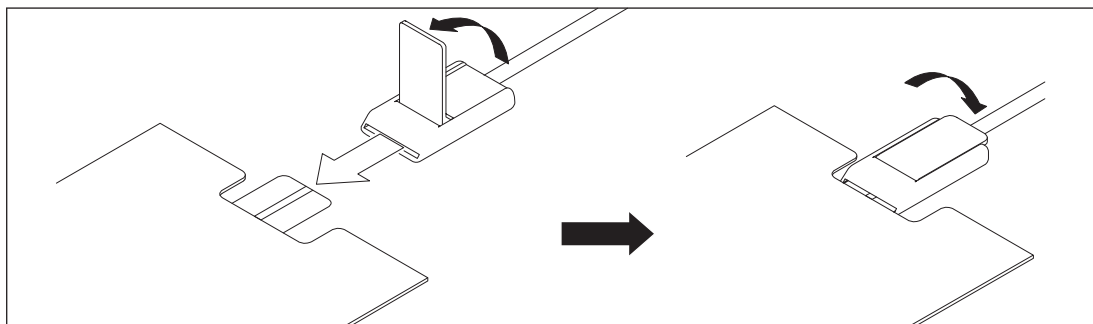

Figure 7.4 Fixing the neutral electrode to the connecting cable

1. Lift the locking lever of the connecting cable.
2. Position the tab of the neutral electrode evenly between the clamp jaws of the connecting cable.
3. Completely push down the locking lever to lock the clamp.
4. Insert the plug of the connecting cable into the neutral electrode socket on the front panel of the electrosurgical generator.

7.6 Verifying the contact quality monitor indicator

If the indicator shines green although there is no neutral electrode attached, there is a malfunction of the electrosurgical generator. In this case, do not use this electrosurgical generator.



Figure 7.5 Split type indicator for CQM shining red on the Set Screen and on the All Screen

- After attaching a neutral electrode to the patient, check the CQM indicator:

When using a split type neutral electrode

The split type indicator must shine green. Refer to the section “Split type and non-split type neutral electrodes and CQM” on page 53.

When using a non-split type neutral electrode

The non-split type indicator must shine green. Refer to the section “Split type and non-split type neutral electrodes and CQM” on page 53.

8 Output settings

8.1 Safety information on output settings



CAUTION

Conscious patients and muscle stimulation

All cutting modes are supported by High Power Cut Support (HPCS). HPCS generates high current densities which result in nerve and muscle stimulation. This can cause pain and discomfort to patients without sedation, pain medication or general anesthesia.

- Use output modes without HPCS for conscious patients. Refer to the section “Overview of output modes” on page 58.

8.2 Overview of output modes

8.2.1 Monopolar modes

Mode name	Application/HF instrument	Specific technical features
FineCut	<ul style="list-style-type: none"> - Cutting of varying tissue structures. - Monopolar cutting electrodes, e.g. needle electrodes. 	<ul style="list-style-type: none"> - Low spark intensity for small thermal effect. - High Power Cut Support (HPCS). - Fast Spark Monitor (FSM) ensures smooth and reproducible cutting in varying tissue, e.g. muscle and fat.
PureCut	<ul style="list-style-type: none"> - Cutting of varying tissue structures. - Monopolar cutting electrodes, e.g. needle electrodes. 	<ul style="list-style-type: none"> - Medium spark intensity for medium thermal effect. - High Power Cut Support (HPCS). - Fast Spark Monitor (FSM) ensures smooth and reproducible cutting in varying tissue, e.g. muscle and fat.
StrongCut	<ul style="list-style-type: none"> - Cutting of varying tissue structures. - Monopolar cutting electrodes, e.g. needle electrodes. 	<ul style="list-style-type: none"> - High spark intensity for big thermal effect. - High Power Cut Support (HPCS). - Fast Spark Monitor (FSM) ensures smooth and reproducible cutting in varying tissue, e.g. muscle and fat.
SoftCoag	<ul style="list-style-type: none"> - Coagulation of tissue with little sticking and carbonization. - Monopolar coagulation electrodes, e.g. coagulation forceps, ball electrodes. 	<ul style="list-style-type: none"> - Little carbonization and adhesion.
ForcedCoag	<ul style="list-style-type: none"> - Fast and effective coagulation. - Monopolar coagulation electrodes, e.g. coagulation forceps, ball electrodes. 	<ul style="list-style-type: none"> - Spark allows coagulation also with relatively small electrodes.

Table: Overview of monopolar cut and coagulation modes

8.2.2 Bipolar modes

Mode name	Application/HF instrument	Specific technical features
FineCut	<ul style="list-style-type: none"> - Cutting of tissue. - Bipolar cutting electrodes, e.g. needle electrodes. 	<ul style="list-style-type: none"> - Low spark intensity for small thermal effect. - High Power Cut Support (HPCS).

Mode name	Application/HF instrument	Specific technical features
PureCut	<ul style="list-style-type: none"> - Cutting of tissue. - Bipolar cutting electrodes, e.g. needle electrodes. 	<ul style="list-style-type: none"> - Medium spark intensity for medium thermal effect. - High Power Cut Support (HPCS).
StrongCut	<ul style="list-style-type: none"> - Cutting of tissue. - Bipolar cutting electrodes, e.g. needle electrodes. 	<ul style="list-style-type: none"> - High spark intensity for big thermal effect. - High Power Cut Support (HPCS).
Pulse RFITT	<ul style="list-style-type: none"> - Controlled tissue coagulation, radiofrequency ablation. - Dedicated bipolar coagulation electrodes, e.g. RFITT electrodes. 	<ul style="list-style-type: none"> - Automatic end-of-procedure detection. - Audible feedback.
RFITT	<ul style="list-style-type: none"> - Controlled tissue coagulation, radiofrequency ablation. - Dedicated bipolar coagulation electrodes, e.g. RFITT electrodes. 	<ul style="list-style-type: none"> - Automatic end-of-procedure detection. - Audible feedback.
Power RFITT	<ul style="list-style-type: none"> - Controlled deep tissue coagulation, radiofrequency ablation. - Dedicated bipolar coagulation electrodes, e.g. cooled RFITT electrodes. 	<ul style="list-style-type: none"> - Automatic end-of-procedure detection. - Audible feedback.
SoftCoag	<ul style="list-style-type: none"> - Coagulation of tissue. - Bipolar coagulation electrodes, e.g. coagulation forceps. 	<ul style="list-style-type: none"> - Little carbonization and adhesion. - Autostart selectable.

Table: Overview of bipolar cut and coagulation modes

8.3 Tissue effects depending on the output power level

8.3.1 Monopolar modes

Mode name	Effect on tissue
FineCut	<ul style="list-style-type: none"> - Increasing the output power level results in an increased thermal effect and an increased cutting capability. - Decreasing the output power level results in a decreased thermal effect and a decreased cutting capability.
PureCut	
StrongCut	
SoftCoag	<ul style="list-style-type: none"> - Increasing the output power level results in an increased coagulation depth for short time applications. - Decreasing the output power level results in a decreased coagulation depth for short time applications. - Nevertheless, to achieve the full potential coagulation depth, a long application time with a low power setting is necessary.
ForcedCoag	<ul style="list-style-type: none"> - Increasing the output power level results in an increased thermal effect. - Decreasing the output power level results in a decreased thermal effect.

Table: Tissue effects depending on output power level in monopolar modes

8.3.2 Bipolar modes

Mode name	Effect on tissue
FineCut	<ul style="list-style-type: none"> - Increasing the output power level results in an increased thermal effect and an increased cutting capability. - Decreasing the output power level results in a decreased thermal effect and a decreased cutting capability.
PureCut	
StrongCut	
Pulse RFITT	<p>For short time applications that end significantly earlier than the automatic end-of-procedure detection:</p> <ul style="list-style-type: none"> - Increasing the output power level results in an increased coagulation depth. - Decreasing the output power level results in a decreased coagulation depth. <p>For application times until automatic end-of-procedure detection:</p> <ul style="list-style-type: none"> - Increasing the output power level results in faster coagulation, a quicker end of procedure and a decreased coagulation depth. - Decreasing the output power level results in slower coagulation, a later end of procedure and an increased coagulation depth. • Refer to the section “The bipolar RFITT coagulation modes” on page 62.
RFITT	
Power RFITT	
SoftCoag	<ul style="list-style-type: none"> - Increasing the output power level results in an increased coagulation depth for short time applications. - Decreasing the output power level results in a decreased coagulation depth for short time applications. - Nevertheless, to achieve the full potential coagulation depth, a long application time with a low power setting is necessary.

Table: Tissue effects depending on output power level in bipolar modes

8.4 Selecting the appropriate output settings

Appropriate selections

- Select a mode according to the type of procedure that will be performed and according to the HF instruments that will be used.
- For details on the applications, HF instruments and specific technical features of the different modes and for the impact of output power levels refer to the section “Overview of output modes” on page 58.

Output power level and applied power

The output power levels that are displayed on the All Screen or on the Set Screen represent the maximum possible output power levels in watts. The actually applied power depends on the tissue characteristics, e.g. resistance.

Minimum output power level

If the output power level of a mode is set below the minimum allowed value by the user, then the electrosurgical generator automatically sets the output power level to 0. Instead of a number for the output power level, [--] is displayed. Each mode has specific minimum output power levels. Refer to the section “Mode characteristics according to IEC 60601-2-2” on page 99 in the Appendix B. It is impossible to change the mode or the output power level during activation.

Selecting the settings on the touch screen

To set the required output settings proceed as follows:

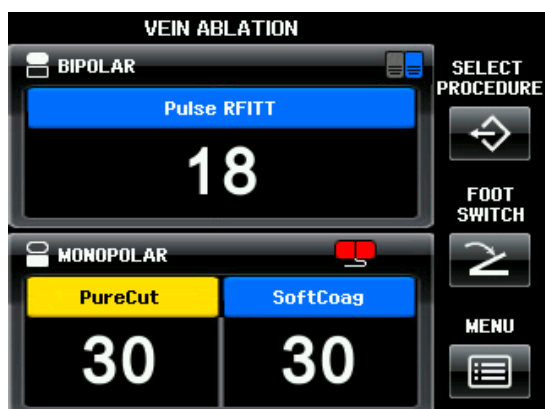

Figure 8.1 All Screen

1. On the All Screen tap into the pane for the required output socket, i.e. either [MONOPOLAR] or [BIPOLAR].
The Set Screen is displayed.

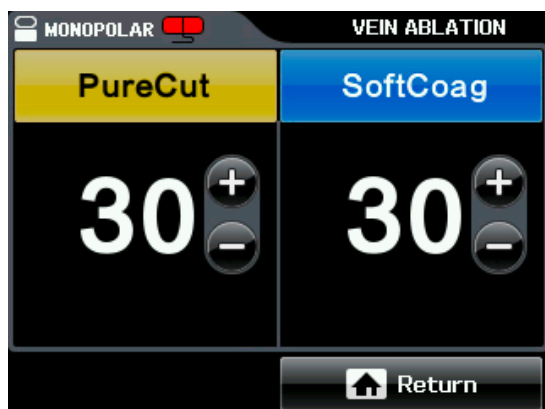

Figure 8.2 Set Screen for monopolar modes

2. Tap the yellow button for selecting a cutting mode or tap the blue button for selecting a coagulation mode.
The Mode Screen is displayed. The currently selected mode is highlighted.



Figure 8.3 Mode Screen for monopolar cutting modes

3. Tap the button of the required mode, e.g. [FineCut].

- The display changes back to the Set Screen and shows the chosen mode.
- Increase or decrease the output power level by tapping [+] or [-] of the chosen mode.

i Tapping [Off] on the Mode Screen completely deactivates cutting or coagulation for this output socket. Then, instead of a number for the output power level, [--] is displayed.

8.5 The bipolar RFITT coagulation modes

The medical purpose of the Radiofrequency Induced Thermotherapy (RFITT) is to achieve controlled tissue coagulation. The electrosurgical generator offers 3 different RFITT modes as mentioned in the table above.

i The RFITT modes are available only for selected CELON bipolar applicators, e.g. CelonProCurve V.

RFITT modes

During activation, the electrosurgical generator provides audible feedback of the coagulation status. The frequency of the output tone is proportional to the tissue resistance at any particular moment. As the measured tissue resistance increases, the frequency of the output tone also increases. This permits audible monitoring of the coagulation status since the latter is directly connected with the tissue resistance.

Energy is applied until the tissue resistance exceeds a limit value, i.e. automatic end-of-procedure detection. Then the power output is automatically stopped or reduced to a minimum, because the coagulation process is completed due to desiccation of the tissue. This is indicated by an intermittent audible signal.

Detailed information on output limits and output characteristics are given in the “Appendix A” on page 95.

Application time and energy counter for RFITT modes

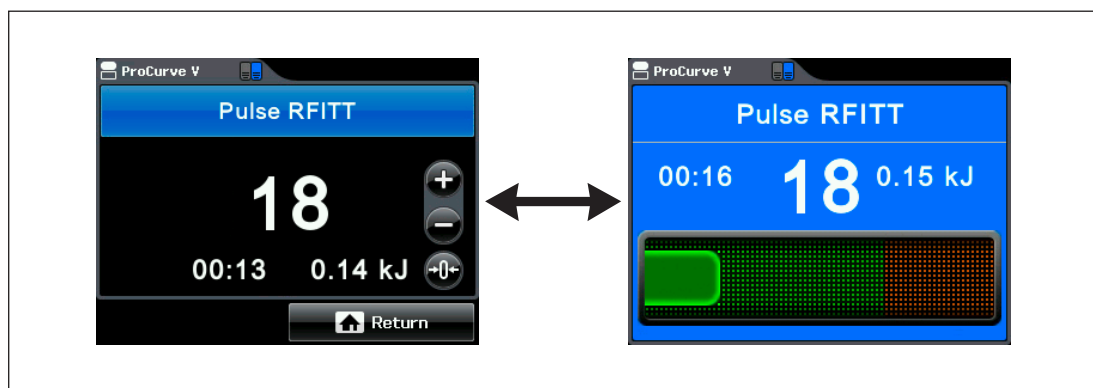

Figure 8.4 Counters on the Set Screen and during activation

On the Set Screens of RFITT modes an application time counter and an energy counter are displayed. The counters indicate previous treatment parameters. During activation of the electrosurgical generator these counters are constantly updated.

- The application time counter shows the total application duration of output power in minutes and seconds in the format [00:00]. After 999 minutes and 59 seconds the application time counter starts counting from 0.

- The energy counter shows the total amount of energy emitted in kilojoules in the following formats:
 - [0.00 kJ] for up to 9.99 kJ
 - [00.0 kJ] for up to 99.9 kJ
 - [000 kJ] for up to 999 kJ
 - When exceeding an energy amount of 999 kJ the electrosurgical generator continues to count in Megajoules (MJ).



- To reset the counters to 0 either switch off the electrosurgical generator or tap [Reset] on the Set Screen.



To avoid patient injury and damage of bipolar RFITT applicators by unintended activation of bipolar cutting, no bipolar cutting mode can be activated while an RFITT mode is selected. If the yellow cut pedal is pressed by mistake then the following error message is displayed:

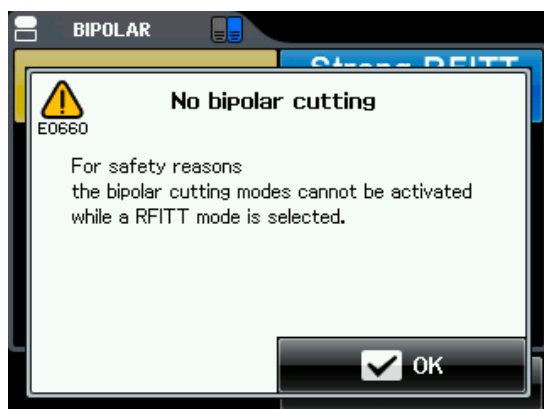

Figure 8.5 Error message E0660 “No bipolar cutting”

8.6 Output settings for selected CELON bipolar applicators



Figure 8.6 Automatic instrument recognition

The electrosurgical generator recognizes the CELON bipolar applicator that is connected. This means:

- The name of the connected CELON bipolar applicator is displayed in the BIPOLAR pane of the touch screen, e. g. [ProCurve V].
- Only compatible modes and output power settings are available.

- The user can select one of these compatible modes and can change the output power level within a restricted range.

Incompatible settings

If the selected settings are not compatible with the bipolar applicator, the electrosurgical generator automatically switches to settings that are compatible with the connected bipolar applicator. The user is informed by a message box, e.g. the following:



Figure 8.7 Incompatible settings

9 Inspection before operation



WARNING Irregularities and damage

Any irregularity or damage of the electrosurgical generator and its equipment compromises the safety and can result in injury to the patient, the user and the medical personnel.

- Prior to every operation, inspect the electrosurgical generator as described in this chapter.
- Prior to every operation, inspect all equipment for irregularity or damage.
- Do not use the electrosurgical generator if any irregularity or damage is suspected.
- Do not use the equipment if any irregularity or damage is suspected.
- Refer to the chapter “Troubleshooting” on page 76.

9.1 Inspecting the supply of power

Power switch and start screen

To test the power connection of the electrosurgical generator proceed as follows:

1. Switch on the electrosurgical generator.
2. Check that the power switch lights up.
3. Check that the touch screen lights up.
The start screen with the Olympus logo is displayed shortly and the start melody is played.
4. Check that the All Screen is displayed after the start screen.
The All Screen recalls the last settings of all output sockets.

9.2 Inspecting the touch screen



CAUTION Operation of the touch screen

Wrong operation of the touch screen can cause malfunction or damage to the touch screen.

- Only tap one button or pane at a time.
- Only tap the touch screen from the front. Avoid oblique angles when tapping the touch screen.
- Do not use pointed objects, e.g. a pen, to tap the touch screen.
- Do not tap the touch screen unintentionally.
- Do not apply excessive loads on the surface of the touch screen.
- Remove dust and dirt by wiping the touch screen with a cloth.

Testing the setting of output power levels

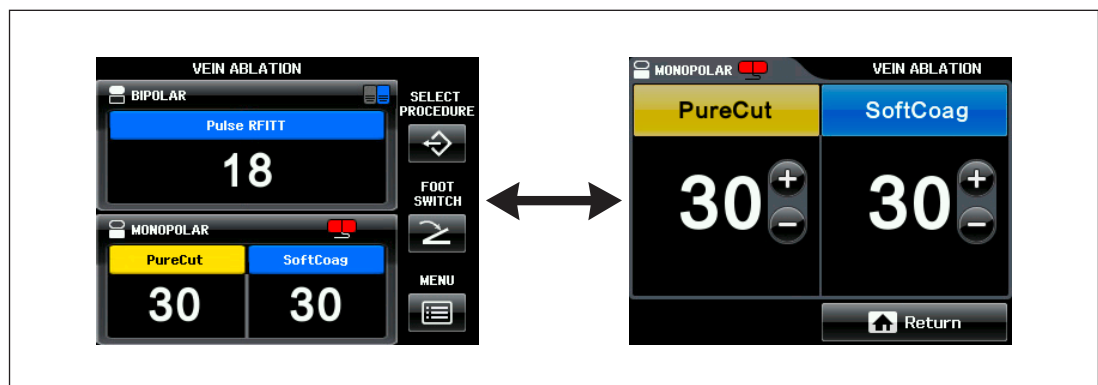

Figure 9.1 Changing from the All Screen to the Set Screen

To test the functionality of the output power settings proceed as follows:

1. Tap into the pane [MONOPOLAR].
Check that the screen changes from the All Screen to the Set Screen, displaying the settings of the MONOPOLAR output socket.
2. Test the plus buttons by tapping [+].
For values up to 50 the output power level increases in steps of 1 per tap.
For values above 50 the plower level increases in steps of 5 per tap.
3. Test the minus buttons by tapping [-].
For values up to 50 the output power level decreases in steps of 1 per tap.
For values above 50 the plower level decreases in steps of 5 per tap.
4. Touch and hold [+] and then [-] to check that the output power level increases/ decreases fast.
5. Tap [Return] to return to the All Screen.

Testing the screen [Select Menu]

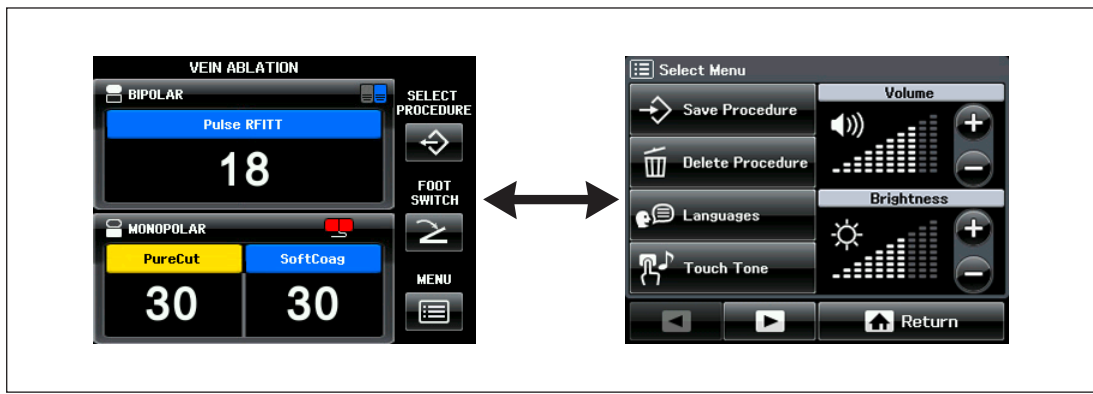

Figure 9.2 Changing from the All Screen to the screen [Select Menu]

To test the functionality of the screen [Select Menu] proceed as follows:

1. Tap [MENU] on the All Screen.
Check that the screen changes from the All Screen to the screen [Select Menu].
2. Tap [Return] to return to the All Screen.

9.3 Inspecting the foot switch assignment

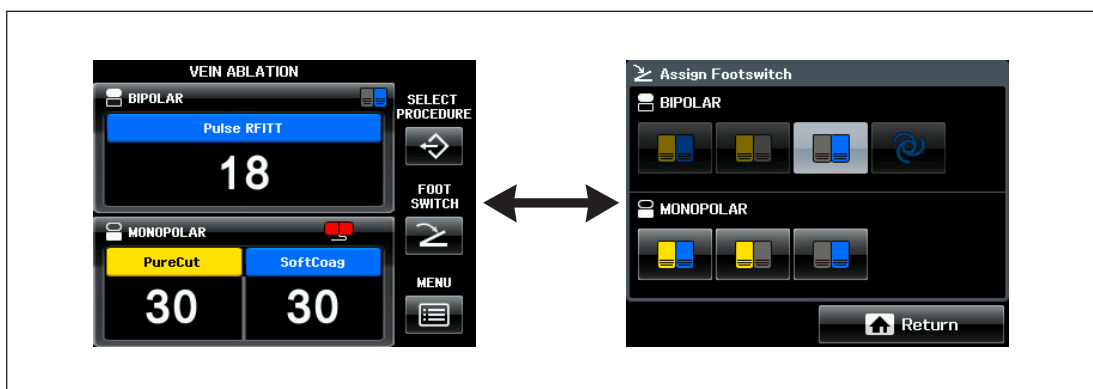

Figure 9.3 Changing from the All Screen to the screen [Assign Foot Switch]

To test the functionality for the foot switch assignment proceed as follows:

1. Tap [FOOT SWITCH] on the All Screen.
The screen changes from the All Screen to the screen [Assign Foot Switch].
2. In the MONOPOLAR pane tap the button [double pedal foot switch].
Check that this button is highlighted.
3. Disconnect the foot switch plug from the electrosurgical generator.
Check that no foot switch buttons are highlighted anymore.
4. Tap [Return] to return to the All Screen.

9.4 Inspecting the alarm system

This section describes how to test the functionality of the neutral electrode alarm substitutionally for the whole alarm system.



WARNING Alarm function

If the alarm function is not normal, the electrosurgical generator might fail to detect an equipment error. This may result in unexpected burns, perforation or bleeding.

- Inspect the alarm function before each use.

Neutral electrode warning

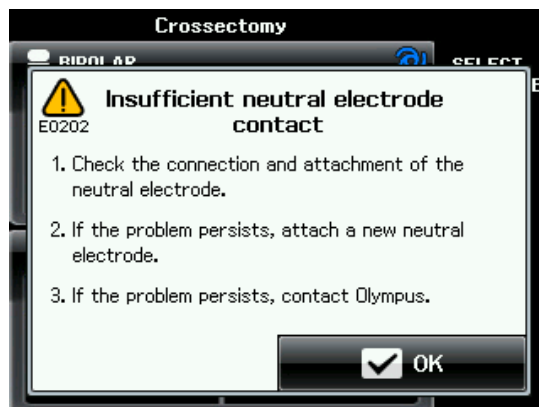

Figure 9.4 Error message E0202 “Insufficient neutral electrode contact”

To test the functionality of the neutral electrode alarm proceed as follows:

1. Make sure that no neutral electrode is connected to the electrosurgical generator.
2. Check that the contact quality monitor indicator shines red.
3. Try to activate any monopolar mode by pressing the corresponding foot switch pedal.
 - Check that the output power cannot be activated.
 - Check that the error message E0202 is displayed and that an alarm tone sounds.
 - Check that the alarm tone stops and that the error message E0202 is closed after approximately 10 seconds.

10 Operation

10.1 Safety information for operation

**DANGER**

Inadequate output of the electrosurgical generator could result in death or serious injury to the patient.

- Immediately stop the activation of output power as soon as inadequate output is observed.
- If that the foot switch or the hand switch of the HF instrument do not react, then use the power switch as emergency stop.

**WARNING****Irregularities and damage**

Any irregularity or damage of the electrosurgical generator and its equipment compromises the safety and can result in injury to the patient, the user and the medical personnel.

- Prior to every operation, inspect the electrosurgical generator as described in this chapter.
- Prior to every operation, inspect all equipment for irregularity or damage.
- Do not use the electrosurgical generator if any irregularity or damage is suspected.
- Do not use the equipment if any irregularity or damage is suspected.
- Refer to the chapter "Troubleshooting" on page 76.

**WARNING****Autostart**

When using Autostart for the bipolar mode SoftCoag, then unintended tissue contact of the HF instrument can cause burns to the user and the patient.

- When using Autostart, be aware that the output of power starts as soon as the HF instrument is in contact with tissue.
- Avoid unintended tissue contact with the HF instrument.

**WARNING****Visibility of the activated HF instrument**

During endoscopic procedures, losing sight of the tip of the activated HF instrument can result in bleeding, perforation and burns to the patient.

- Make sure that the tip of the activated HF instrument is always visible in the endoscopic image.

**WARNING****Metal clips**

If the tip of the activated HF instrument is in close to a metal clip or another metallic object within the patient, then the tissue around this metallic object could be burned.

- Make sure that the activated HF instrument does not get close to metallic objects.

**WARNING****Accidental activation**

Accidentally activating the output of the electrosurgical generator with the foot switch or the hand switch can result in burns to the patient or the user.

If output power is not needed:

- Completely remove the foot from the foot switch.
- Make sure that the fingers do not touch the hand switches of the HF instrument.

**WARNING****Correct foot switch or hand switch**

Pressing the wrong foot pedal or hand switch can result in bleeding, perforation and burns to the patient.

- Make sure to press the correct foot switch or hand switch, i.e. yellow switch for cutting modes and blue switch for coagulation modes.
- Make sure that the required foot switch pedal is assigned to the correct output socket.



WARNING
Increasing the output

Increasing the output of energy if the electrosurgical generator does not perform as expected can result in bleeding, perforation and burns to the patient. Prior to increasing the output:

- Check the connections of the cords.
- Check the attachment of the neutral electrode.
- Check the settings at the electrosurgical generator.



WARNING
Confirm display settings

Inappropriate output of power can result in bleeding, perforation and burns to the patient.

- Before activating, confirm that the displayed settings are correct for the intended procedure.



WARNING

When using a bipolar HF instrument for coagulation only, then unintended activation of a cutting mode could result in bleeding, perforation and damage to the bipolar HF instrument.

- Prior to activation, switch off all bipolar cutting modes via the Mode Screen.
- Alternatively, reduce the output power level of all bipolar cutting modes to 0 on the Set Screen.

10.2 Activating

10.2.1 Prior to activating

- Confirm that the displayed settings are correct for the intended procedure.
- For monopolar treatments: Confirm that the CQM indicator for the neutral electrode shines green.
- Make sure to use the correct foot switch pedal, i.e. the yellow pedal for cutting and the blue pedal for coagulation.
- Make sure to use the correct hand switch, i.e. the cutting trigger or the coagulation trigger.

10.2.2 Limited activation time

The activation time is limited to 60 seconds, except for the RFITT modes. This safety measure is implemented to restrict patient injury or property damage due to unintended activation. If the time limit is exceeded:

- An alarm tone sounds.
- The output power stops automatically.

- The following error message is displayed:

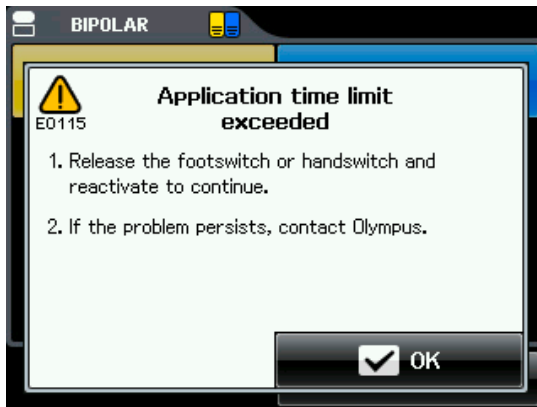

Figure 10.1 Error message E0115: "Application time limit exceeded"

To reactivate the electrosurgical generator proceed as follows:

1. Release the foot switch or hand switch.
 - If Autostart is used, release the contact between the HF instrument and the tissue.
2. Then activate again.
 - If Autostart is used, re-establish the contact between the HF instrument and the tissue.



The activation time limit does not apply to RFITT modes.

10.2.3 Functional principles of activation

Screens for activation

Activation of power is possible only if the All Screen or the Set Screen is displayed on the touch screen.

Activation of cutting and coagulation modes

All monopolar and bipolar cutting modes are activated as follows:

- By depressing the yellow cut pedal of the foot switch.
- By pressing the yellow cut trigger directly at the HF instrument.

All monopolar and bipolar coagulation modes are activated as follows:

- By depressing the blue coagulation pedal of the foot switch.
- By pressing the blue coagulation trigger directly at the HF instrument.

The output power is activated as long as the foot switch pedal or the hand switch at the HF instrument is pressed.

Background color

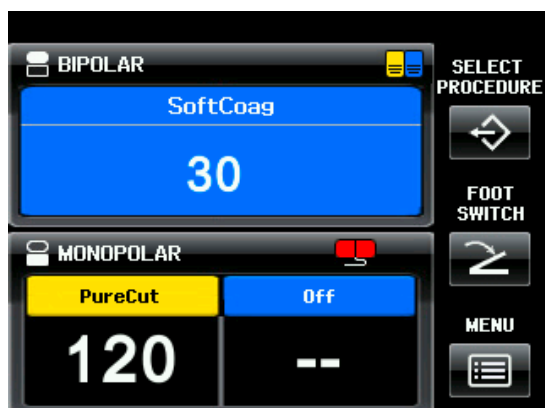

Figure 10.2 Background color for active coagulation on the All Screen

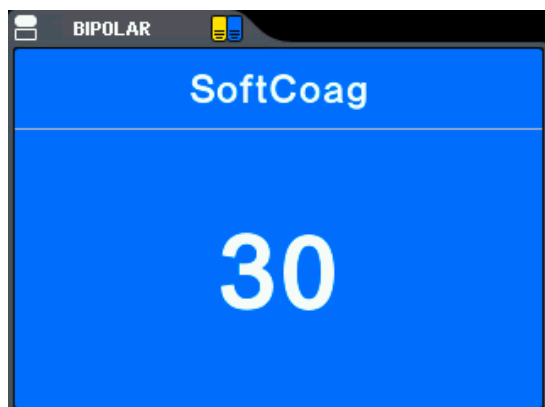

Figure 10.3 Background color for active coagulation on the Set Screen

During activation the background color of the touch screen adapts to the kind of output power.

- For all cutting modes the background color changes to yellow.
- For all coagulation modes the background color changes to blue.

Output tone

During activation an output tone sounds.

DRAFT -- 2017-01-17



When attempting to activate although the output power level is set to 0, then an alarm tone sounds and the following error message is displayed:

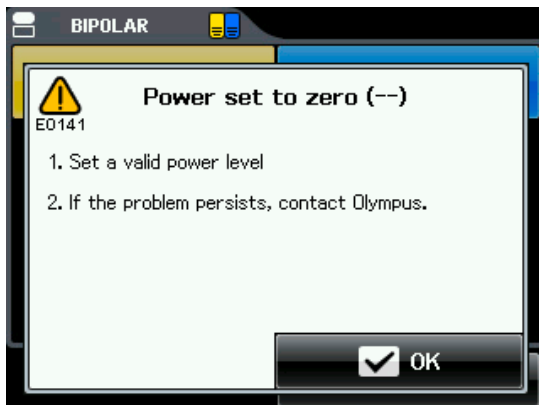

Figure 10.4 Error message E0141 "Power set to zero (--)"

- Confirm the message by tapping [OK] or wait for a few seconds and then continue.

Activation with Autostart for bipolar SoftCoag

The bipolar SoftCoag mode can be activated via Autostart if this is assigned to the corresponding output socket.

- Refer to the section “Autostart for the bipolar mode SoftCoag” on page 22 for more details on the Autostart feature.
- Refer to the section “Foot switch assignment and Autostart” on page 40 for instructions on assigning Autostart.
- Refer to the section “Autostart Setup” on page 44 for instructions on setting a time delay to Autostart.

Stopping activation

The output of power stops as soon the foot switch pedal or the hand switch is released.

When using Autostart for the bipolar mode SoftCoag, the output of power stops as soon as the HF instrument is removed from the tissue.

10.3 After use

After each use, immediately perform the procedures as described in the following paragraphs. If cleaning is delayed, debris encrustation may become a source of infection. Encrustation may also result in malfunction of the electro-surgical generator.



WARNING Protective clothing for cleaning and disinfection

Tissue debris and reprocessing chemicals represent a risk of infection for the reprocessing personnel.

- During cleaning and disinfection wear appropriate personal protective clothing such as eye wear, face mask, moisture-resistant clothing and surgical gloves that fit properly.
- Before leaving the reprocessing area, remove the contaminated protective clothing.



WARNING Drying

If the electro-surgical generator is stored or used after cleaning while still damp, then this can result to electric shock to the patient and the user.

DRAFT – 2017-01-17

- Thoroughly dry the electrosurgical generator after cleaning.

**CAUTION**
Disconnection of plugs

Tugging and pulling at the cords can break the electric circuit and can damage the equipment.

- When disconnecting equipment, directly pull at the plug.
- Do not tug or pull at the cords.

**CAUTION**
Cleaning and disinfecting

Immersing in liquids, gas sterilization or autoclaving will damage the electrosurgical generator.

- Only use the cleaning and disinfection methods as described in the section "Reprocessing" on page 74.

**CAUTION**
Sockets

Cleaning the sockets of the electrosurgical generator can deform and corrode the contacts which will result in damage to the electrosurgical generator.

- Do not clean the output sockets, the power socket or the foot switch sockets.

**CAUTION**

Wiping the surface of the electrosurgical generator with abrasive cloths or abrasive detergents damages the touch screen and rubs off the markings on the housing.

- Only use detergents as described in the section "Reprocessing" on page 74.

10.3.1 Disconnecting

To disconnect the electrosurgical generator from the mains electricity and to disconnect all accessories from the electrosurgical generator proceed as follows:

1. Switch off the electrosurgical generator by pressing the power switch.
The light of the power switch and the touch screen turn off.
2. Disconnect all HF instruments from the corresponding output sockets.
3. Disconnect the connecting cable of the neutral electrode from the neutral electrode socket.
4. Disconnect the cord set from the mains electricity.
5. Disconnect the foot switch from the socket at the rear panel of the electrosurgical generator.

11 Reprocessing

11.1 General information for reprocessing

Brand-new products

Treat brand-new products as if they have been used. Brand-new products must be reprocessed using a complete reprocessing cycle.

The reprocessing cycle

- Reprocess the product according to the instructions in this chapter.
- To minimize the risk of infecting patients, users or third parties, reprocess the product before each use.
- Contact your local hygiene representative for local standards and regulations.

Validated for efficacy

Validated for efficacy means that the efficacy of the method or agent has been validated for reprocessing this product as described in this document.

Verified for material compatibility

Verified for material compatibility means that according to current knowledge the reprocessing method or agent does not negatively affect materials or functional performance of the product.

Verified for material compatibility does not mean that microbiological efficacy can be guaranteed.

Instructions for using reprocessing agents

- The reprocessing agent must be approved by the manufacturer for cleaning and disinfection of medical devices and for the material to be reprocessed.
- Refer to national and local guidelines regarding the approval of using alcohol as reprocessing agent.
- Select contact times and concentrations of the reprocessing agent in accordance with the instructions given by the manufacturer.
- The reprocessing agent must be approved and validated by the FDA, the EPA, the DGHM or a comparable institution for its efficiency.
- Reprocessing may lead to an increased wear of the product. Before use, thoroughly inspect the products for traces of wear.

11.2 Cleaning

Suitable reprocessing agents for cleaning

Cleaning efficacy has been validated with an alkaline disinfectant based on low alcohol (<20%) and quaternary ammonium compounds (Sani-Cloth® Plus manufactured by PDI Professional).

Material compatibility has been verified with the following reprocessing agents:

- Alkaline agents, max. pH value of 12,0
- Neutral agents

Cleaning procedure

Perform the following cleaning procedure immediately after use. If cleaning is delayed, debris will solidify and it may be difficult to effectively clean the surfaces.

1. Take a soft, lint-free cloth that is soaked with a suitable reprocessing agent.
2. Thoroughly wipe the surfaces of the electrosurgical generator until visibly clean.

3. In case of heavy soiling, use additional cloths.
4. Before disinfection, let the surfaces dry or wipe them dry using a lint-free cloth.

Inspection before disinfection

- Visually inspect the product thoroughly after cleaning.
The product must be visually clean.
- If there are any signs of debris, repeat the cleaning process.

11.3 Disinfection

Suitable disinfectants

Low-level disinfection efficacy has been validated with an alkaline disinfectant based on low alcohol (<20%) and quaternary ammonium compounds (Sani-Cloth® Plus manufactured by PDI Professional at 3 minutes contact time.)

Material compatibility has been verified with disinfectants based on the following as active ingredients:

- Low alcohol
- Quaternary ammonium compounds
- Amine derivatives
- Sodium hypochlorite

Disinfection procedure

1. Take a soft, lint-free cloth that is soaked with a suitable disinfectant.
2. Thoroughly wet the surfaces of the electro-surgical generator.
3. The surfaces must remain visibly wet for the contact time that is designated by the disinfectant's manufacturer.
4. Use additional cloths to assure the designated continuous wet contact time.
5. Let the surfaces dry or wipe them dry using a lint-free cloth.

11.4 Other HF equipment

- For the reprocessing or disposal of other HF equipment, e.g. neutral electrodes and HF instruments, refer to the corresponding instructions for use of these products.

12 Troubleshooting

- If the problem cannot be resolved by the described remedial actions, stop using the electro-surgical generator and contact Olympus.
- Be aware that repairs may only be performed by authorized service centers.

12.1 General problems

Check the following table to identify and correct failures. If the problem cannot be resolved by the described remedial actions, contact Olympus.

Problem	Cause	Remedy
The electro-surgical generator does not respond when pressing the power switch.	Improper connection of the cord set to the socket on the rear panel of the electro-surgical generator or to the grounded mains electricity socket.	Check the cord set and the grounded fixed socket-outlet for correct connection.
	The grounded fixed socket-outlet has wrong or no output voltage.	Check the grounded fixed socket-outlet or use an alternative grounded fixed socket-outlet.
	The cord set is damaged.	Check the cord set for damages and, if necessary, replace the cord set.
	Malfunction of the electro-surgical generator.	Do not use this electro-surgical generator. Contact Olympus.
After switching on the electro-surgical generator the touch screen remains dark but sounds are audible.	Malfunction of the touch screen.	Do not use this electro-surgical generator. Contact Olympus.
The touch screen cannot be controlled.	An object is in contact with the touch screen.	Remove the object.
	Malfunction of the touch screen.	Do not use this electro-surgical generator. Contact Olympus.
There is no sound coming from the electro-surgical generator during activation.	The volume for the output tone is set to an inaudible level, e.g. due to high environmental noise.	Increase the volume either on the screen [Select Menu] or use the volume control on the rear panel of the electro-surgical generator.
	Malfunction of the electro-surgical generator.	Do not use this electro-surgical generator. Contact Olympus.
The volume cannot be adjusted on the screen [Select Menu] or via the volume control on the rear panel of the electro-surgical generator.	The volume of error-related alarm tones is not adjustable.	No action required.
	Malfunction of the electro-surgical generator.	Do not use this electro-surgical generator. Contact Olympus.

DRAFT -- 2017-01-17

Problem	Cause	Remedy
The electrosurgical generator does not respond to foot switch or hand switch activation.	Improper contact of the connection cable of the foot switch or the HF instrument to the corresponding socket of the electrosurgical generator.	Check the connection cable of the foot switch and the HF instrument for correct connection.
	The foot switch, the hand switch of the HF instrument or their connection cables are damaged.	Observe the foot switch, the hand switch of the HF instrument and their connection cables for damages. If necessary, replace the foot switch, the HF instrument or the corresponding connection cable.
	The wrong foot switch pedal or the wrong hand switch is pressed.	Press the correct foot switch pedal or the correct hand switch of the HF instrument.
	The electrosurgical generator is not switched on.	Switch on the electrosurgical generator with the power switch.
	2 switches for activating the output power are pressed simultaneously, e.g. another foot switch pedal or hand switch of an HF instrument.	Release all switches for activation and check that no switch is pressed unintentionally. Then activate the output power using only 1 switch.
	A message box is displayed on the touch screen.	Tap [OK] or [Cancel] to close the message box or wait until the message box closes automatically after a few seconds.
	It is possible to activate the output power only if either the All Screen or the Set Screen is displayed on the touch screen.	Return to the All Screen or the Set Screen.
	The output mode is deactivated ([Off] is displayed) or the output power level is set to 0 ([--] is displayed).	Activate the output mode on the Mode Screen or increase the output power level on the Set Screen. Refer to the section "Selecting the appropriate output settings" on page 60.
Autostart is selected and the HF instrument has contact with the tissue, but the electrosurgical generator does not activate.	Malfunction of the electrosurgical generator.	Do not use this electrosurgical generator. Contact Olympus.
	A long time delay for Autostart is set.	Reduce the time delay for Autostart. Refer to the section "Autostart Setup" on page 44.
	Malfunction of the electrosurgical generator.	Do not use this electrosurgical generator. Contact Olympus.

DRAFT -- 2017-01-17

Problem	Cause	Remedy
Foot switch pedal or hand switch of the HF instrument is pressed and the output tone sounds but no output power is delivered.	The foot switch is assigned to another output socket.	Check the correct assignment of the foot switch. Refer to the section “Foot switch assignment and Autostart” on page 40.
	Improper connection of the HF instrument plug with the output socket of the electrosurgical generator.	Check the plug of the HF instrument for correct connection.
	Malfuction of the electrosurgical generator.	Do not use this electrosurgical generator. Contact Olympus.
No output power is delivered when an RFITT mode is selected. The end-of-procedure signal sounds immediately after activation.	The electrode has no contact with the tissue.	Check that the electrode has contact with the tissue.
	Improper connection of the HF instrument's plug with the output socket of the electrosurgical generator.	Check the plug of the HF instrument for correct connection.
	The HF instrument or its connection cable is damaged.	Replace the HF instrument or its connection cable.
	Malfuction of the electrosurgical generator.	Do not use this electrosurgical generator. Contact Olympus.
It is impossible to stop the output power of the electrosurgical generator.	Autostart is assigned to the currently used output socket and both electrodes touch the tissue.	Remove the electrodes of the HF instrument from the tissue.
	Malfuction of the foot switch or hand switch.	Immediately switch off the electrosurgical generator by pressing the power switch. Replace the foot switch or the HF instrument with hand switch.
	Malfuction of the electrosurgical generator.	Do not use this electrosurgical generator. Contact Olympus.
Its impossible to switch off the electrosurgical generator.	Malfuction of the electrosurgical generator.	Disconnect the cord set plug from the socket on the rear panel of the electrosurgical generator and/or from the grounded mains electricity socket. Contact Olympus. Do not use this electrosurgical generator.

Table: Troubleshooting – General problems

12.2 Error messages

The electrosurgical generator is equipped with an intelligent alarm system. The alarm system determines alarm conditions on the base of multiple variables.

Alarm priorities

Depending on the potential risks, the alarms are classified in high, medium and low priority alarms. An alarm of higher priority overrides an existing alarm of lower priority. If more than one alarm condition of equal priority is determined, only the one that occurred first is reported.

The following table explains the three different conditions.

Alarm priority	Alarm tone	Display of caution symbol	Meaning
High	3 short honks and 2 long honks for 2 cycles	The caution symbol is red and flashes.	<ul style="list-style-type: none"> - Serious system error. - The output power is stopped automatically. - The electrosurgical generator automatically restarts. - If the restart runs successfully, then the user can continue to use this electrosurgical generator.
Medium	3 short honks	The caution symbol is yellow and flashes.	<ul style="list-style-type: none"> - With most medium priority alarms the output power stops automatically. - The user immediately needs to resolve the cause of the error as explained in the error message. - As soon as the error is resolved, the user can continue to use this electrosurgical generator.
Low	2 short honks	The caution symbol is yellow without flashing.	<ul style="list-style-type: none"> - The user needs to take notice of the error message. - Possibly, the output power is stopped automatically and the user needs to resolve the cause of the error as explained in the error message. - As soon as the error is resolved, the user can continue to use this electrosurgical generator.

Table: Meaning of alarm priorities

Error messages

If an alarm condition occurs, then an alarm tone sounds and an error message is displayed on the touch screen of the electrosurgical generator. The following figure shows an example:

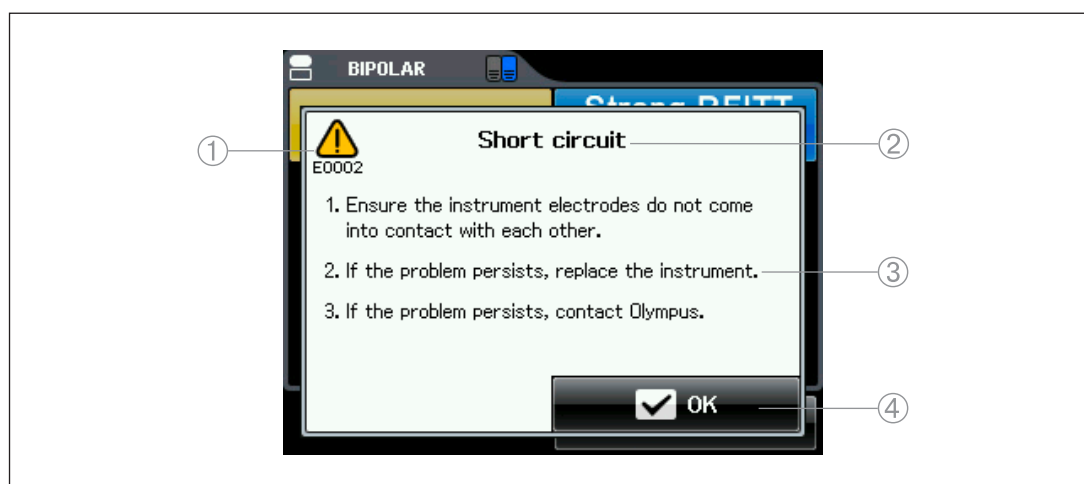

Figure 12.1 Error message E0002 “Short circuit”

- 1) Caution symbol and error code
- 2) Error title

DRAFT – 2017-01-17

- 3) Remedial actions
- 4) Confirmation button

If the cause that released the alarm is cleared, then the error message is closed automatically after approximately 10 seconds. If the cause of the alarm is not cleared, then the error message stays on the touch screen.

- To clear the alarm, follow the instructions that are given in the error message.

It is possible to tap [OK] in the error message to close the error message faster.

12.2.1 Overview of error messages

The following table gives an overview of all error messages that possibly can be displayed. The error messages are sorted numerically according to the error code.

Error code	Message	Cause	Remedial action
E0001	Open circuit 1. Check if the electrodes of the instrument have proper tissue contact. 2. If the problem persists, replace the instrument. 3. If the problem persists, contact Olympus.	The electrodes of the HF instrument have no tissue contact.	Ensure that the electrodes of the HF instrument have proper tissue contact.
		Malfunction of the HF instrument or its connection cable.	Replace the HF instrument or its connection cable.
		Malfunction of the electro-surgical generator.	Do not use this electro-surgical generator. Contact Olympus.
E0002	Short circuit 1. Ensure the instrument electrodes do not come into contact with each other. 2. If the problem persists, replace the instrument. 3. If the problem persists, contact Olympus.	The electrodes of the HF instrument touch each other.	Ensure that the electrodes of the HF instrument do not touch each other.
		Malfunction of the HF instrument or its connection cable.	Replace the HF instrument or its connection cable.
		Malfunction of the electro-surgical generator.	Do not use this electro-surgical generator. Contact Olympus.
E0012	Adjustment incomplete If the problem persists, contact Olympus.	Malfunction of the electro-surgical generator.	Do not use this electro-surgical generator. Contact Olympus.
E0016	Burn-in incomplete If the problem persists, contact Olympus.	Malfunction of the electro-surgical generator.	Do not use this electro-surgical generator. Contact Olympus.
E0019	Connection of Footswitch 1. You can connect a double pedal footswitch only. 2. If the problem persists, contact Olympus.	A single pedal foot switch is connected.	Disconnect the single pedal foot switch. Only connect the supplied double pedal foot switch (WB50402W).
		Malfunction of the foot switch.	Replace the foot switch.
		Malfunction of the electro-surgical generator.	Do not use this electro-surgical generator. Contact Olympus.

Error code	Message	Cause	Remedial action
E0104 E0105	Footswitch pedal pressed 1. Release the footswitch pedal to continue. 2. If the problem persists, contact Olympus.	The foot switch pedal is depressed while switching on the electrosurgical generator.	Release the foot switch pedal.
		Malfuction of the foot switch.	Replace the foot switch.
		Malfuction of the electrosurgical generator.	Do not use this electrosurgical generator. Contact Olympus.
E0108 E0109	Handswitch pressed 1. Release the handswitch of the instrument to continue. 2. If the problem persists, replace the instrument. 3. If the problem persists, contact Olympus.	The hand switch of the HF instrument is pressed while switching on the electrosurgical generator.	Release the hand switch of the HF instrument.
		Malfuction of the HF instrument.	Replace the HF instrument.
		Malfuction of the electrosurgical generator.	Do not use this electrosurgical generator. Contact Olympus.
E0115	Application time limit exceeded 1. Release the footswitch or handswitch and reactivate to continue. 2. If the problem persists, contact Olympus.	The maximum time limit for the application has been exceeded.	Release the foot switch or hand switch and reactivate by pressing the foot switch or hand switch again.
		Malfuction of the electrosurgical generator.	Do not use this electrosurgical generator. Contact Olympus.
E0136	Double pedal footswitch not assigned 1. Assign the double pedal foot switch to the designated output socket. 2. If the problem persists, contact Olympus.	The double pedal foot switch is not assigned to the corresponding output socket.	Assign the double pedal foot switch to the corresponding output socket. Refer to section "Foot switch assignment and Autostart" on page 40.
		Malfuction of the electrosurgical generator.	Do not use this electrosurgical generator. Contact Olympus.
E0140	No mode selected 1. Select a mode. 2. If the problem persists, contact Olympus.	No mode has been selected.	Select an appropriate mode. Refer to the chapter "Output settings" on page 58.
		Malfuction of the electrosurgical generator.	Do not use this electrosurgical generator. Contact Olympus.
E0141	Power set to zero (--) 1. Set a valid power level. 2. If the problem persists, contact Olympus.	The output power level for the chosen mode is set to 0.	Increase the output power level on the Set Screen. Refer to section "Selecting the appropriate output settings" on page 60.
		Malfuction of the electrosurgical generator.	Do not use this electrosurgical generator. Contact Olympus.

DRAFT -- 2017-01-17

Error code	Message	Cause	Remedial action
E0179	Temperature below limit 1. Switch off the electrosurgical generator and wait until operating temperature is reached. 2. If the problem persists, contact Olympus.	The minimum operating temperature of the electrosurgical generator has fallen below the limit.	Switch off the electrosurgical generator and wait until the specified operating temperature is reached. Refer to the section "Specifications for the CELON Precision" on page 88.
		Malfunction of the electrosurgical generator.	Do not use this electrosurgical generator. Contact Olympus.
E0180	Temperature above limit 1. Switch off the electrosurgical generator and wait until it has cooled down. 2. If the problem persists, contact Olympus.	The maximum operating temperature of the electrosurgical generator has been exceeded.	Switch off the electrosurgical generator and let it cool down until the specified operating temperature is reached. Refer to the section "Specifications for the CELON Precision" on page 88.
		Malfunction of the electrosurgical generator.	Do not use this electrosurgical generator. Contact Olympus.
E0187	Increased HF leakage current 1. Check if an instrument, the neutral electrode or patient is unintentionally grounded. 2. If the problem persists, contact Olympus.	The high frequency leakage current has exceeded the limit of 150 mA for monopolar applications or 100 mA for bipolar applications.	Check if the electrosurgical generator or the patient is grounded unintentionally.
		Malfunction of the electrosurgical generator.	Do not use this electrosurgical generator. Contact Olympus.
E0188	Excessive HF leakage current 1. Check if an instrument, the neutral electrode or patient is unintentionally grounded. 2. If the problem persists, contact Olympus.	The high frequency leakage current has exceeded the limit of 300 mA for monopolar applications or 200 mA for bipolar applications.	Check if the electrosurgical generator or the patient is grounded unintentionally.
		Malfunction of the electrosurgical generator.	Do not use this electrosurgical generator. Contact Olympus.
E0202	Insufficient neutral electrode contact 1. Check the connection and attachment of the neutral electrode. 2. If the problem persists, attach a new neutral electrode. 3. If the problem persists, contact Olympus.	The contact resistance of the neutral electrode is too high or the neutral electrode is not connected.	Check the connection and attachment of the neutral electrode.
		Malfunction of the neutral electrode or its connection cable.	Replace the neutral electrode or its connection cable.
		Malfunction of the electrosurgical generator.	Do not use this electrosurgical generator. Contact Olympus.

Error code	Message	Cause	Remedial action
E0214	Low battery If the problem persists, contact Olympus.	Malfunction of the electrosurgical generator.	Do not use this electrosurgical generator. Contact Olympus.
E0438	Procedure data error 1. One or more procedures have been deleted. Press OK to continue. 2. If the problem persists, contact Olympus.	One or more saved procedures are deleted.	Tap [OK] to close the error message and to continue.
		Malfunction of the electrosurgical generator.	Do not use this electrosurgical generator. Contact Olympus.
E0441	Device setting error Device settings have been set to default. If the problem persists, contact Olympus.	All settings of the electrosurgical generator are set to default.	The electrosurgical generator is ready for use after the error message is closed.
		Malfunction of the electrosurgical generator.	Do not use this electrosurgical generator. Contact Olympus.
E0660	No bipolar cutting For safety reasons the bipolar cutting modes cannot be activated while an RFITT mode is selected.	A bipolar cutting mode as well as a bipolar RFITT mode are selected.	Switch off the bipolar RFITT mode or select the mode SoftCoag.
E0683	No compatible RFITT instrument connected RFITT modes can only be activated if a compatible RFITT instrument is connected.	There is no or an incompatible HF instrument connected.	Connect an HF instrument that is compatible with this electrosurgical generator and its RFITT modes.
E0687	Instrument wearout note The instrument is about to reach its maximum usage time. Replace the instrument if possible.	The permitted usage span of the HF instrument is nearly reached. The error message is repeated after every new activation.	Replace the HF instrument as soon as the treatment situation allows.
E0688	Instrument wearout warning The instrument has exceeded its maximum usage time. Replace the instrument to proceed.	The permitted usage span of the HF instrument is exceeded. It is impossible to activate this HF instrument anymore.	Replace the HF instrument.
E0689		Refer to error code E0687.	
E0690		Refer to error code E0688.	
E0###	Error Electrosurgical generator will automatically restart. If the problem persists, contact Olympus.	Malfunction of the electrosurgical generator.	The electrosurgical generator automatically restarts. If any error occurs permanently or repetitively, contact Olympus.

Table: Troubleshooting – Overview of error messages

13 Maintenance, repair and shipment

13.1 Annual safety check

The electrosurgical generator as well as the foot switch must go through an annual safety check in accordance with the national statutory regulations.

The annual safety check may only be carried out by a qualified electrician with sufficient experience in maintaining medical electrical devices. Furthermore, the appropriate equipment for performing the safety check must be available. Details on the annual safety check are described in the maintenance manual for the CELON Precision.

- Contact the local Olympus representative for the latest version of the maintenance manual.

Alternatively, the electrosurgical generator can be sent to an authorized service center where the annual safety check is carried out.

- Contact the local Olympus representative for information on authorized service centers.
- When sending the electrosurgical generator to an authorized service center, take account of the information in the section "Shipment" on page 84.

13.2 Repair

Repairs may only be performed by authorized service centers.

- Do not attempt to modify or repair the electrosurgical generator or the foot switch.
- Contact the local Olympus representative center for repair and warranty information.
- When sending the electrosurgical generator to an authorized service center, take account of the information in the section "Shipment" on page 84.

13.3 Shipment

When sending products to an authorized service center for repair, maintenance or warranty claims, note the following:

Risk of infection

Used products represent a risk of infection for the servicing personnel. Service centers are entitled to refuse the service for soiled or contaminated products for reasons of safety.

- Clean and disinfect the product as thoroughly as possible and mark it accordingly.

Packaging

Service centers do not accept warranty claims for damage caused by inadequate packaging.

- Use the original cardboard packaging for the transport of the product.
- If this is not possible, wrap each component individually in sufficient paper or sheets of foamed material and place them in a cardboard box.

Description of malfunction and contact person

When returning the electrosurgical generator:

- Include a description of the malfunction or damage.
- State the name and telephone number of a contact person.

14 Storage and disposal

14.1 Storage



CAUTION Storage

Exposing the electrosurgical generator to strong impacts, direct sunlight, x-rays, radioactivity, liquids or strong magnetic radiation can damage the electrosurgical generator.

- Do not store the electrosurgical generator in a location that is exposed to direct sunlight, x-rays, radioactivity or liquids.
- Do not store the electrosurgical generator in a location that is exposed to strong electromagnetic radiation, e.g. microwave medical treatment equipment, short-wave medical treatment equipment, magnetic resonance imaging equipment, radio or mobile phones.
- Do not subject the electrosurgical generator to strong impacts during storage.

During storage

- Place the electrosurgical generator and the foot switch on a stable, level surface.
- Store the electrosurgical generator and the foot switch according to the environmental conditions described in the chapter "Specifications" on page 88.

14.2 Disposal

When disposing of the product or any of its components, e.g. fuses or packaging material, follow all applicable national and local laws and guidelines.

Waste electrical and electronic equipment

In accordance with European Directive 2002/96/EC on waste electrical and electronic equipment (WEEE), the product must not be disposed of as unsorted municipal waste, but should be collected separately.

For nationally available return or collection systems contact the Olympus representative.

DRAFT -- 2017-01-17

15 Compatible equipment

Olympus recommends the use of equipment as listed in this chapter. If combinations are used that are not listed in this chapter, the user takes the full responsibility.

Future equipment may also be compatible. For more information, contact an Olympus representative.

Some of the products listed in this chapter may not be available in all sales territories.

15.1 System chart

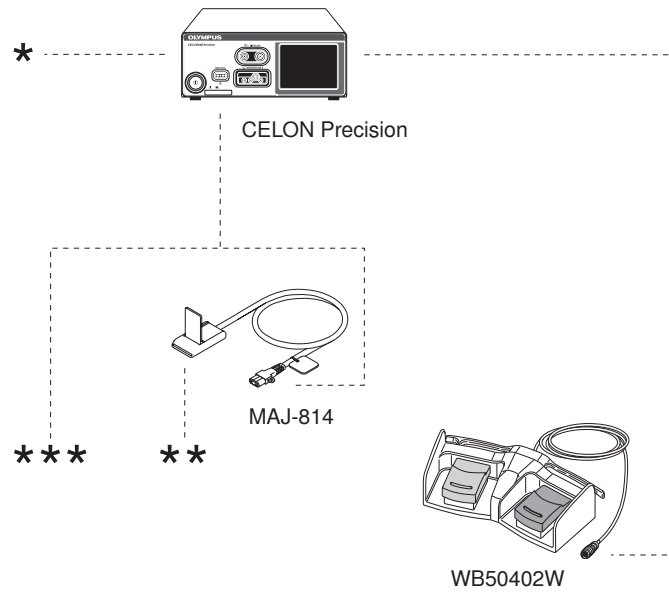

Figure 15.1 System chart for CELON Precision

- * Bipolar and monopolar HF instruments including compatible HF cables
- ** Split type neutral electrodes without connecting cable
- *** Split type neutral electrodes with connecting cable

15.2 Compatible neutral electrodes

Name	Description
3M 1180	- Patient weight >15 kg - Split type - White foam
3M 1179	- Patient weight >15 kg - Split type - White foam - With cable
3M 8180	- Patient weight >15 kg - Split type - Teal foam - Soft conductive adhesive
3M 9160	- Patient weight <15 kg - Split type - Safety ring - Soft backing
3M 9165	- Patient weight <15 kg - Split type - Safety ring - Soft backing - With cable
Valleylab E7509	- Patient weight >15 kg - Split type - Soft conductive adhesive
Valleylab E7507	- Patient weight >15 kg - Split type - Soft conductive adhesive - With cable
Valleylab E7510-25	- Patient weight <15 kg - Split type - Soft conductive adhesive
Conmed SureFit 410-2000/410-2100	- Patient weight <15 kg - Split type - With cable
Conmed SureFit 410-2200/410-2400	- Patient weight <15 kg - Split type

Table: Compatible neutral electrodes

DRAFT – 2017-01-17

16 Specifications

Specifications, design and accessories are subject to change without any notice or any obligation of the manufacturer.

16.1 Specifications for the CELON Precision

Size

Width.....	295 mm
Height.....	115 mm
Depth.....	400 mm
Volume	13,570 cm ³
Weight.....	6.61 kg

Packaging

Weight of packaging.....	1.5 kg
Type of packaging	cardboard and expanded polypropylene material

Power supply

Voltage range.....	AC 100 V to 120 V/AC 220 V to 240 V
Frequency	50 Hz/60 Hz
Maximum input power	650 VA
Fuse	T 6.3 A

Classifications

According to IEC 60601-1, protection against electric shock:	
Medical electrical equipment.....	Class I
Applied parts	Type CF

Protection against harmful ingress of water	IPX0
Mode of operation	Continuous operation with intermittent loading

According to Medical Device Directive 93/42/EEC.....IIb

Output

High frequency functions.....	Monopolar and bipolar
High frequency	356 kHz \pm 20%
Maximum HF power	120 W
All modes	25% duty cycle (e.g. activated for 10 s, deactivated for 30 s)
All RFITT modes	100% duty cycle

RFID technology

The device contains radio-frequency identification (RFID) technology.	
Frequency band:	13,56 MHz (internationally harmonized)

Ambient conditions for operation, storage and transport

Operating temperature	+10 to +40 °C (+50 to +104 °F)
Storage and transport temperature	-25 to +60 °C (-13 to +140 °F)

Relative operating humidity	30 to 85 %, non-condensing
Relative storage and transport humidity.....	10 to 85 %, non-condensing

Atmospheric operating pressure	70 to 106 hPa
Atmospheric storage and transport pressure	50 to 106 hPa

DRAFT - 2017-01-17

Plug requirements for the MONOPOLAR output socket**WA90008A**

3-pin plugs.....PinØ 4 mm (international/Valleylab standard)

Coaxial plugs..... PinØ 9/5 mm (Erbe standard)

1-pin plugs..... PinØ 4 mm

WA90009A

3-pin plugs.....PinØ 4 mm (international/Valleylab standard)

1-pin plugs..... PinØ 8 mm (Bovie standard)

1-pin plugs..... PinØ 4 mm

Plug requirements for the BIPOLAR output socket

2-pin plugs.....PinØ 4 mm

28.6 mm pin spacing (international/Valleylab standard)

Coaxial plugs..... PinØ 4/8 mm (Erbe standard)

Plug requirements for the neutral electrode socket

..... 2 pins, Ø 2.5 mm, 10 mm pin spacing

Allowable resistance range for the Contact Quality Monitor – CQM

For split type neutral electrodes 10 ±5 Ω to 155 ±15 Ω

For non-split type neutral electrodes <10 ±5 Ω

16.2 Specifications for the double pedal foot switch (WB50402W)**Manufacturer**

Olympus Winter & Ibe GmbH, Kuehnstr. 61, 22045 Hamburg, Germany

Power

Voltage DC 24 V

Electric current 0.1 A

Classifications

Protection class according to IEC 60529 IPX8 (except the plug sections)

Size

Width 350 mm

Height..... 65 mm

Depth..... 185 mm

Weight 1.9 kg

Length of connection cable 4 m

Packaging

Weight of packaging..... 0.5 kg

Type of packaging cardboard material

16.3 Specifications for the cord set

WA95621A (for many European countries)..... Type E/F

WA95622A (for Canada, USA and other countries)..... Type B

WA95623A (for United Kingdom and other countries) Type G

Length 4.5 m

Plug on device side angled

17 Electromagnetic compatibility

Le présent appareil est conforme aux CNR d'ISED applicables aux appareils radio exempts de licence.

L'exploitation est autorisée aux deux conditions suivantes :

1. l'appareil ne doit pas produire de brouillage,
2. l'appareil doit accepter tout brouillage radioélectrique subi, même si le brouillage est susceptible d'en compromettre le fonctionnement.

Precautionary measures

Electromedical devices are subject to special precautionary measures concerning electromagnetic compatibility (EMC). This device is to be used only for the purposes described in these instructions for use and has to be installed, set up, and operated in compliance with the EMC guidelines.

Impact of mobile and portable RF communication devices

The emission of radio frequency energy by mobile communication devices may impact the function of the electromedical device. Operating such mobile communication devices (e.g. cell phones, GSM phones) in the proximity of the electromedical device is prohibited.



Electrical connections

Electrical connections bearing this warning symbol may not be touched. Connections between such plugs and sockets may not be established without first implementing ESD precautionary measures.

ESD precautionary measures

The following are ESD precautionary measures:

- Connect all electrical equipment to be connected to the device to a potential equalisation system (via PE).
- Use only the equipment and accessories mentioned in these instructions for use.
The staff have to be informed about and trained in ESD precautionary measures.

Guidelines and manufacturer's declaration – electromagnetic emissions		
This device is intended for use in the electromagnetic environment specified below. The customer or the user of this device should assure that it is used in such an environment.		
Emissions test	Compliance	Electromagnetic environment – guidance
RF emissions CISPR 11	Group 1	During standby this device uses RF energy only for its internal function. Therefore, its RF emissions are very low and are not likely to cause any interference in nearby electronic equipment.
RF emissions CISPR 11	Class B	This device is suitable for use in all facilities including those in residential areas and those directly connected to a public supply network that also supplies buildings used for residential purposes.
Harmonic emissions IEC 61000-3-2	Class B	
Voltage fluctuations/ flicker emissions IEC 61000-3-3	In compliance	

Guidelines and manufacturer's declaration – electromagnetic immunity			
This device is intended for use in the electromagnetic environment specified below. The customer or the user of this device should assure that it is used in such an environment.			
Immunity test	IEC 60601 test level	Compliance level	Electromagnetic environment – guidance
Electrostatic discharge (ESD) IEC 61000-4-2	± 6 kV contact discharge ± 8 kV air discharge	Identical to test level	Floors should be wood, concrete or ceramic tile. If floors are covered with synthetic material, the relative humidity should be at least 30%.
Electrical fast transient/burst IEC 61000-4-4	± 2 kV for power supply lines ± 1 kV for input/output lines	Identical to test level	Mains power quality should be that of a typical commercial or hospital environment.
Surges according to IEC 61000-4-5	± 1 kV line(s) to line(s) ± 2 kV line(s) to earth	Identical to test level	Mains power quality should be that of a typical commercial or hospital environment.
Voltage dips, short interruptions and voltage variations on power supply input lines according to IEC 61000-4-11	$< 5\% U_T^*$ ($> 95\%$ dip in U_T) for 0.5 cycle $40\% U_T$ (60% dip in U_T) for 5 cycles $70\% U_T$ (30% dip in U_T) for 25 cycles $< 5\% U_T$ ($> 95\%$ dip in U_T) for 5 s	Identical to test level	Mains power quality should be that of a typical commercial or hospital environment. If the user of this device requires continuous operation during power mains interruptions, it is recommended that the device is powered from an uninterruptible power supply or a battery.
Magnetic fields of mains frequency (50/60 Hz) magnetic field IEC 61000-4-8	3 A/m	Identical to test level	Power frequency magnetic fields should be at levels characteristic of a typical location in a typical commercial or hospital environment.

*Note: U_T is the a.c. mains voltage prior to application of the test level.

DRAFT – 2017-01-17

Guidance and manufacturer’s declaration – electromagnetic immunity			
This device is intended for use in the electromagnetic environment specified below. The customer or user of this device should assure that it is used in such an environment.			
Immunity test	IEC 60601 test level	Compliance level	Electromagnetic environment – guidance
Conducted RF according to IEC 61000-4-6	3 V _{eff} 150 kHz to 80 MHz	3 V	Portable and mobile RF communications equipment should be used no closer to any part of the Olympus CELON Precision, including cables, than the recommended separation distance calculated from the equation applicable to the frequency of the transmitter. Recommended separation distance $d = 1.2 \sqrt{P}$ $d = 1.2 \sqrt{P}$ 80 MHz to 800 MHz $d = 2.3 \sqrt{P}$ 800 MHz to 2.5 GHz where P is the maximum output power rating of the transmitter in watts [W] according to the transmitter manufacturer and d is the recommended separation distance in meters [m]. Field strengths from fixed RF transmitters, as determined by an electromagnetic site survey ^a , should be less than the compliance level in each frequency range ^b . Interference may occur in the vicinity of equipment marked with the following symbol: 
Radiated RF according to IEC 61000-4-3	3 V/m 80 MHz to 2.5 GHz	3 V/m	

Note 1: At 80 MHz and 800 MHz, the higher frequency range applies.

Note 2: These guidelines may not apply in all situations. Electromagnetic propagation is affected by absorption and reflection from structures, objects and people.

^a Field strengths from fixed transmitters, such as base stations for radio (cellular/cordless) telephones and land mobile radios, amateur radio, AM and FM radio broadcast and TV broadcast cannot be predicted theoretically with accuracy. To assess the electromagnetic environment due to fixed RF transmitters, an electromagnetic site survey should be considered. If the measured field strength in the location in which the Olympus CELON Precision is used exceeds the applicable RF compliance level above, the Olympus CELON Precision should be observed to verify normal operation. If abnormal performance is observed, additional measures may be necessary, such as re-orienting or relocating the device.

^b Over the frequency range 150 kHz to 80 MHz, field strengths should be less than 3 V/m.

Recommended separation distances between portable and mobile RF communications equipment and this device
This device is intended for use in an electromagnetic environment in which radiated RF disturbances are controlled. The customer or user of this device can help prevent electromagnetic interference by maintaining a minimum distance between portable and mobile RF communications equipment (transmitters) and this device as recommended below, according to the maximum output power of the communications equipment.

Rated output power of the transmitter P in W	Separation distance (d) according to frequency of the transmitter in meters (m)		
	150 kHz to 80 MHz $d = 1.2 \sqrt{P}$	80 MHz to 800 MHz $d = 1.2 \sqrt{P}$	800 MHz to 2.5 GHz $d = 2.3 \sqrt{P}$
0.01	0.12 m	0.12 m	0.23 m
0.1	0.38 m	0.38 m	0.73 m
1	1.2 m	1.2 m	2.3 m
10	3.8 m	3.8 m	7.3 m
100	12 m	12 m	23 m

For transmitters rated at a maximum output power not listed above, the recommended separation distance [d] in metres [m] can be estimated using the equation applicable to the frequency of the transmitter, where P is the maximum output power rating of the transmitter in watts [W] according to the transmitter manufacturer.

Note 1: For 80 MHz and 800 MHz, the separation distance for the higher frequency range applies.

Note 2: These guidelines may not apply in all situations. Electromagnetic propagation is affected by absorption and reflection from structures, objects and people.

DRAFT – 2017-01-17

DRAFT – 2017-01-17

APPENDIX A

Alarm system

An alarm condition is indicated about one second after detection and securing.

Log file for alarm conditions

The alarm system provides a log of occurrences of alarm conditions. The eldest log is overwritten by the latest log when the capacity of 4098 logs is reached. Only authorized service personnel can read log data.

If the alarm system is powered down, then the log is still maintained by an internal electrical power source. In case of a total loss of power, i.e. mains electricity as well as internal power source, the complete log is erased immediately.

Alarm tones

Depending on the priority of an error, the alarm tones sound different.

High priority errors

E0004, E0008...E0011, E0013, E0015, E0018, E0024...E0037, E0039...E0102, E0116...E0119, E0122...E0133, E0137, E0142...E0178, E0197, E0198, E0203...E0211, E0213, E0216...E0412, E0415...E0437, E0439, E0440, E0443...E0455, E0458...E0484, E0492...E0605, E0620...E0659, E0662...E0664, E0672...E0680, E0682, E0684...E0686, E0691, E0697

For these error codes the following values apply:

Duty cycle..... Intermitting signal (number of burst = 10)
 Frequency 200/300 Hz
 Volume ≥ 65 dB (A)

Medium priority errors

E0012, E0016, E0017, E0019...E0022, E0038, E0104, E0105, E0108, E0109, E0120, E0121, E0134, E0136, E0179...E0186, E0188...E0196, E0199...E0201, E0212, E0215, E0413, E0414, E0438, E0457, E0488, E0489, E0665, E0681

For these errors codes the following values apply:

Duty cycle..... Intermitting signal (number of burst = 3)
 Frequency 200/300 Hz
 Volume ≥ 65 dB (A)

Low priority errors

E0001, E0002, E0006, E0115, E0140, E0141, E0187, E0202, E0214, E0441, E0619, E0660, E0683, E0687...E0690, E0698

For these errors codes the following values apply:

Duty cycle..... Intermitting signal (number of burst = 2)
 Frequency 200/300 Hz
 Volume ≥ 65 dB (A)

Output tone information

Monopolar modes

Mode	Frequency	Duty cycle	Volume
FineCut	587 Hz	Continuous signal	≥40 to ≥65 dB (A)
PureCut	587 Hz	Continuous signal	≥40 to ≥65 dB (A)
StrongCut	587 Hz	Continuous signal	≥40 to ≥65 dB (A)
SoftCoag	440 Hz	Continuous signal	≥40 to ≥65 dB (A)
ForcedCoag	554 Hz	Continuous signal	≥40 to ≥65 dB (A)

Output tone information for monopolar modes

DRAFT – 2017-01-17

Bipolar modes

Mode	Frequency	Duty cycle	Volume
FineCut	587 Hz	Continuous signal	≥40 to ≥65 dB (A)
PureCut	587 Hz	Continuous signal	≥40 to ≥65 dB (A)
StrongCut	587 Hz	Continuous signal	≥40 to ≥65 dB (A)
Pulse RFITT	469 Hz < f < 1038 Hz depending on tissue resistance	Continuous signal	≥40 to ≥65 dB (A)
	End signal: 2000 Hz	Intermitting (500 ms on, 500 ms off)	
RFITT	469 Hz < f < 1038 Hz depending on tissue resistance	Continuous signal	≥40 to ≥65 dB (A)
	End signal: 2000 Hz	Intermitting (500 ms on, 500 ms off)	
Power RFITT	469 Hz < f < 1038 Hz depending on tissue resistance	Continuous signal	≥40 to ≥65 dB (A)
	End signal: 2000 Hz	Intermitting (500 ms on, 500 ms off)	
SoftCoag	440 Hz	Continuous signal	≥40 to ≥65 dB (A)

Output tone information for bipolar modes**Touch tone and start melody****Touch tone**

Duty cycle.....0.09 s
 Frequency 500 Hz
 Volume ≥65 dB (A)

Start melody

Duty cycle.....0.375 s
 Volume ≥65 dB (A)

DRAFT – 2017-01-17

APPENDIX B

Mode characteristics according to IEC 60601-2-2

Mode characteristics of monopolar modes

The waveforms of all monopolar modes are continuous, except of ForcedCoag¹⁾.

Mode	Default power setting	Minimum power level ³⁾	Maximum power level ³⁾	Maximum output voltage	Rated load	End-of-procedure load
FineCut	30	5 W	120 W	580 V _p	500 Ω	—
PureCut	30	5 W	120 W	630 V _p	500 Ω	—
StrongCut	30	5 W	120 W	680 V _p	500 Ω	—
SoftCoag	30	5 W	120 W	250 V _p	100 Ω	—
ForcedCoag ²⁾	30	5 W	120 W	2000 V _p	500 Ω	—

Mode characteristics for monopolar modes

¹⁾ Waveform..... Modulated sinus, 15 kHz

²⁾ Crest factor at rated load.....3.0 to 8.0

³⁾ The power level is the continuous power (Watts) which can be applied during the activation of the electrosurgical generator. The actual applied power depends on the tissue characteristics, e.g. resistance.

Mode characteristics of bipolar modes

The waveforms of all bipolar modes are continuous.

Mode	Default power setting	Minimum power level ¹⁾	Maximum power level ¹⁾	Maximum output voltage	Rated load	End-of-procedure load
FineCut	30	5 W	120 W	470 V _p	500 Ω	—
PureCut	30	5 W	120 W	530 V _p	500 Ω	—
StrongCut	30	5 W	120 W	560 V _p	500 Ω	—
Pulse RFITT	15	1 W	40 W	230 V _p	100 Ω	Resistance threshold defined by instrument
RFITT	20	1 W	40 W	150 V _p	100 Ω	400 Ω
Power RFITT	20	1 W	40 W	260 V _p	100 Ω	900 Ω

Mode	Default power setting	Minimum power level ¹⁾	Maximum power level ¹⁾	Maximum output voltage	Rated load	End-of-procedure load
SoftCoag	30	5 W	120 W	260 V _p	100 Ω	—

Mode characteristics for monopolar modes

¹⁾ The power level is the continuous power (Watts) which can be applied during the activation of the electrosurgical generator. The actual applied power depends on the tissue characteristics, e.g. resistance.

Characteristics of High Power Cut Support (HPCS)

The following is an example of the characteristics of HPCS during FineCut mode:

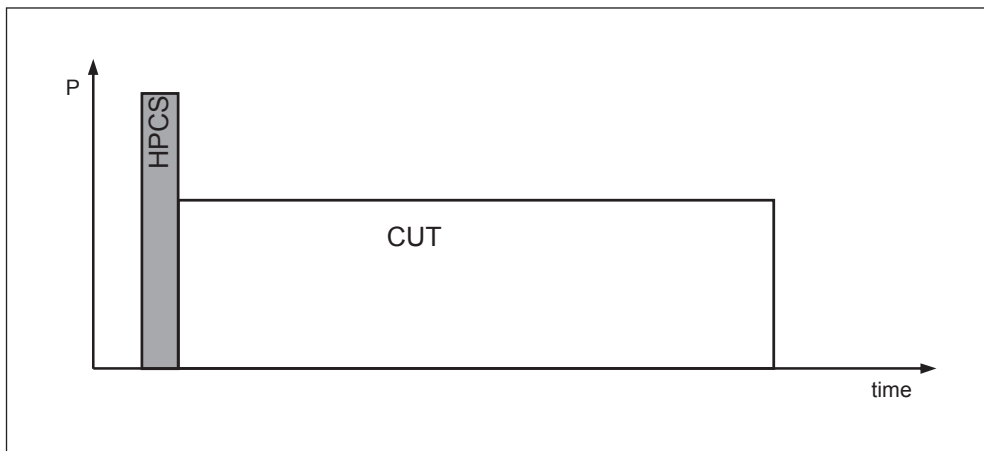

Characteristics of HPCS

Output characteristics

The following diagrams show the output power data for each mode.

- The blue graphs indicate the data for a full output power setting.
- The red graphs indicate the data for a half output power setting.

Output characteristics of monopolar modes

FineCut

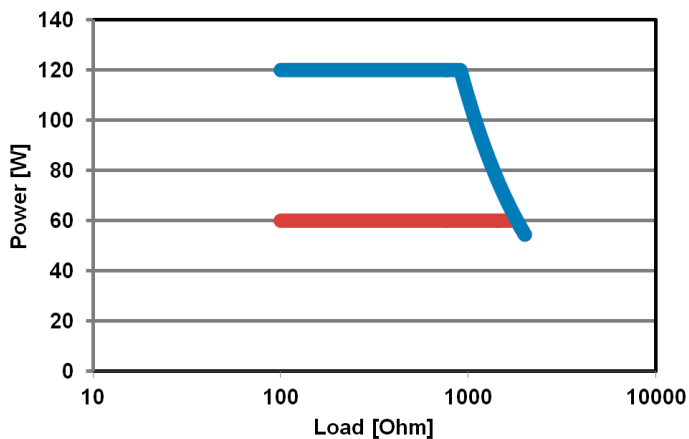

PureCut

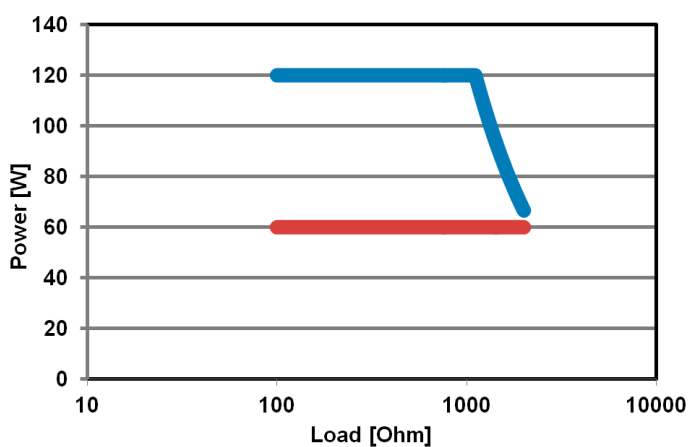

DRAFT – 2017-01-17

StrongCut

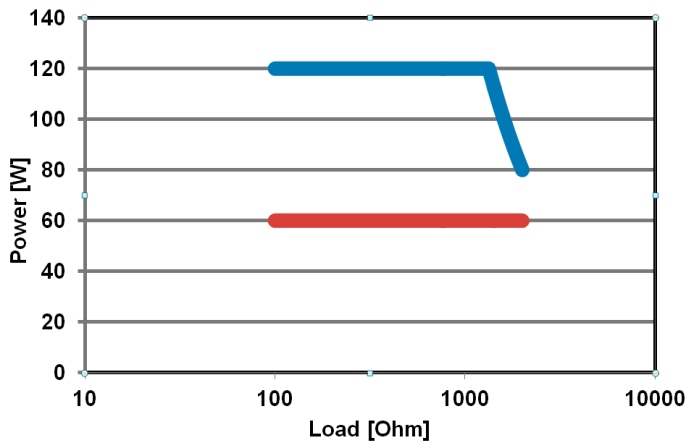

SoftCoag

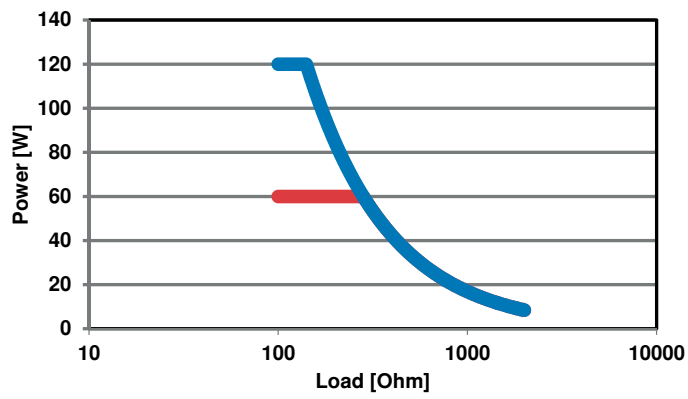

ForcedCoag

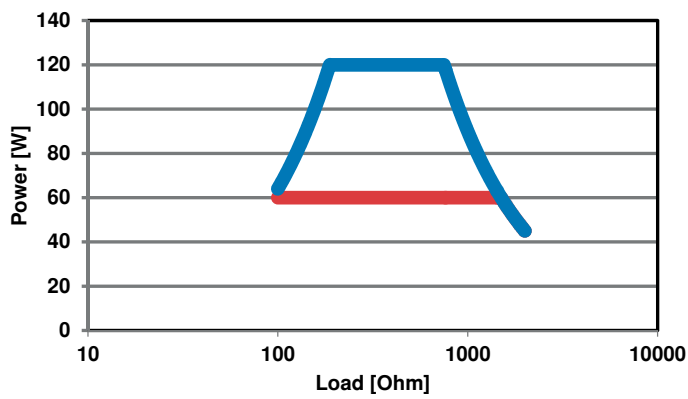

DRAFT - 2017-01-17

Output characteristics of bipolar modes

FineCut

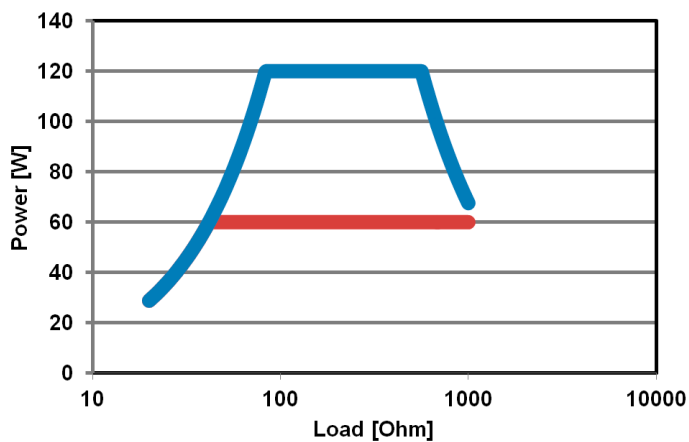

PureCut

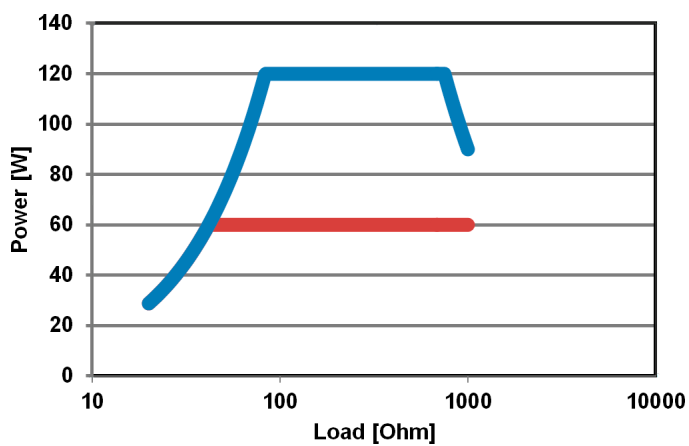

StrongCut

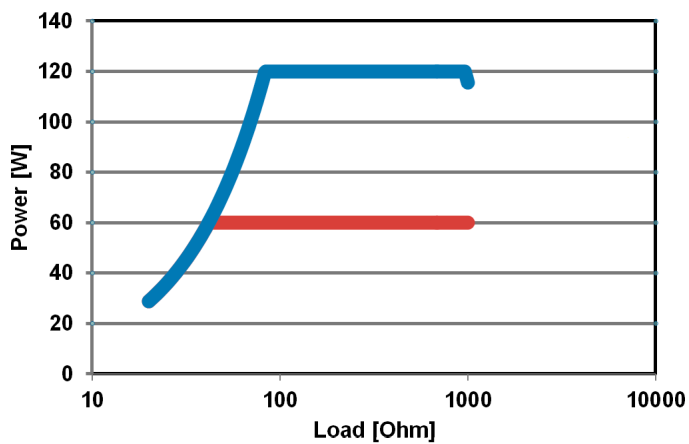

DRAFT - 2017-01-17

Pulse RFITT

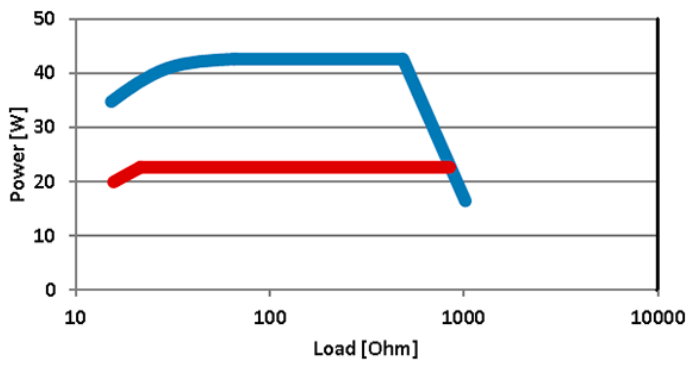

RFITT

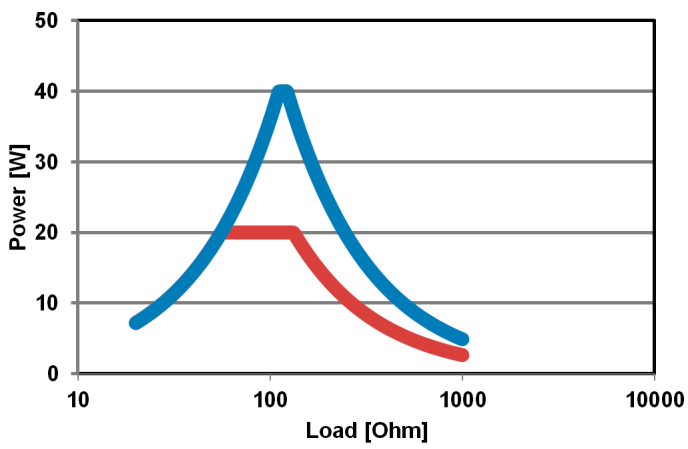

Power RFITT

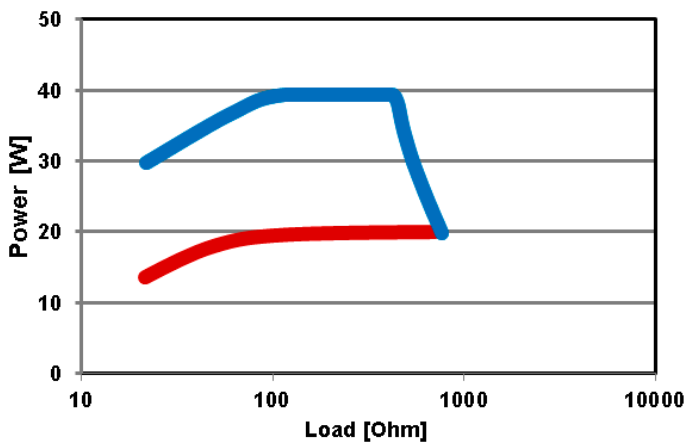

DRAFT - 2017-01-17

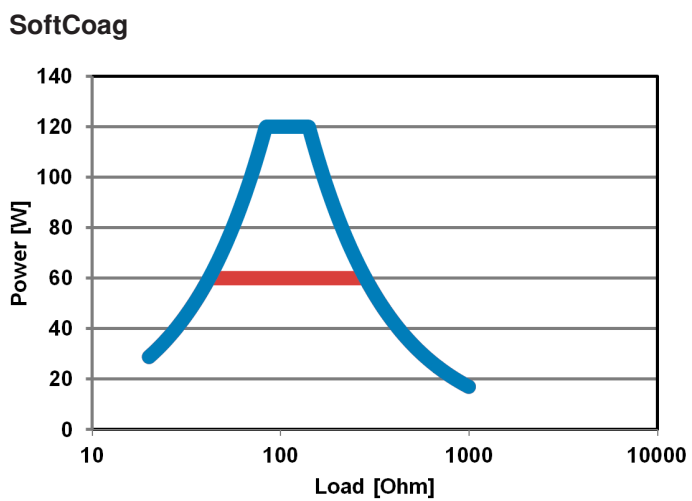

DRAFT – 2017-01-17

DRAFT – 2017-01-17

DRAFT – 2017-01-17

DRAFT – 2017-01-17

OLYMPUS[®]



W7513751_01
2016-09-29
en (US)

© Copyright 2016 Olympus Winter & Ibe GmbH