

DIGITAL CAMERA

E-1

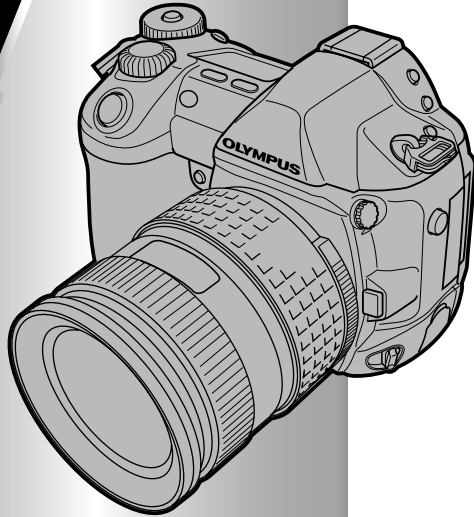

REFERENCE MANUAL

- Thank you for purchasing an Olympus digital camera. Before you start to use your new camera, please read these instructions carefully to enjoy optimum performance and a longer service life. Keep this manual in a safe place for future reference.
- We recommend that you take test shots to get accustomed to your camera before taking important photographs.
- In the interest of continually improving products, Olympus reserves the right to update or modify information contained in this manual.

For customers in North and South America

For customers in USA

Declaration of Conformity

Model Number : E-1

Trade Name : OLYMPUS

Responsible Party : Olympus America Inc.

Address : 2 Corporate Center Drive, Melville, New York
11747-3157 U.S.A.

Telephone Number : 631-844-5000

Tested To Comply With FCC Standards

FOR HOME OR OFFICE USE

This device complies with Part 15 of the FCC rules. Operation is subject to the following two conditions:

- (1) This device may not cause harmful interference.
- (2) This device must accept any interference received, including interference that may cause undesired operation.

For customers in Canada

This Class B digital apparatus meets all requirements of the Canadian Interference-Causing Equipment Regulations.

For customers in Europe



“CE” mark indicates that this product complies with the European requirements for safety, health, environment and customer protection.

“CE” mark cameras are intended for sales in Europe.

Trademarks

- IBM is a registered trademark of International Business Machines Corporation.
- Microsoft and Windows are registered trademarks of Microsoft Corporation.
- Macintosh is a trademark of Apple Computer Inc.
- CompactFlash and CF are trademark of San Disk Inc.
- All other company and product names are registered trademarks and/or trademarks of their respective owners.
- The standards for camera file systems referred to in this manual are the “Design Rule for Camera File System/DCF” standards stipulated by the Japan Electronics and Information Technology Industries Association (JEITA).

Contents
Names of parts

Introduction to the camera's functions	1 <i>Getting started</i> P. 16
	2 <i>Shooting and playback basics</i> P. 29
	3 <i>Buttons and menus</i> P. 32
Find out how to adjust settings manually for more creative control when conditions are unsuitable for auto shooting	4 <i>Focus</i> P. 47
	5 <i>Exposure</i> P. 56
	6 <i>Image, image quality and color</i> P. 79
How to use optional flashes	7 <i>Flash</i> P. 98
View images on your camera and adjust them with built-in image processing	8 <i>Playback</i> P. 107
Personalize your camera for easier operation	9 <i>Function/setting customizing</i> P. 118
How to prepare pictures for printing	10 <i>Print reservation</i> P. 134
How to download images to your PC for editing and more	11 <i>Transferring images to a computer</i> P. 143
Troubleshooting and other information	12 <i>Miscellaneous</i> P. 158

Names of parts	9
Camera	9
Control panel indications	11
Viewfinder indications	12
Monitor indications (only for playback)	13
Battery check indications	14
How to use this manual	15

1 Getting started **16**

Attaching strap	16
Loading the battery	17
Charging the battery	17
Loading the battery	18
Unloading the battery	19
Other power sources	21
Attaching a lens to the camera	21
Inserting a card	23
How to insert/remove the card	24
Power ON/OFF	26
Adjusting the viewfinder's diopter	27
Holding the camera	28

2 Shooting and playback basics **29**









3 Buttons and menus **32**

Functions available using the buttons and menus	32
How to operate the buttons and dials	32
Types of buttons	34
Menus	38
How to use the menus	38
List of menu functions	40









4 Focus **47**

Auto focus (AF)	47
Subjects that are difficult to focus on	48
Focus lock	49
AF frame selection 	50
Focus mode	51
S-AF (single AF) shooting	51
C-AF (continuous AF) shooting	53
RELEASE PRIORITY S & RELEASE PRIORITY C	54
Manual focus (MF)	54
AF ILLUMINATOR	55

5 Exposure **56**

Exposure mode	56
P : Program shooting	57
A : Aperture priority shooting	59
S : Shutter priority shooting	61
M : Manual shooting	63
Preview function	65
Exposure compensation 	65
Metering mode ESP   	68
AE lock 	69
Auto bracketing BKT	70
AE bracketing	70
WB bracketing BKTWB	72
Drive mode DRIVE	73
Sequential shooting 	73
Self-timer shooting 	74
Remote control shooting  (with optional remote control)	75
REC. CANCEL	77
ANTI-SHOCK	78









6 Image, image quality and color **79**

Record mode	79
Selecting a record mode 	81
Setting the SQ mode	81
RAW record mode (RAW+JPEG)	82
ISO sensitivity	83
Setting the ISO sensitivity	83
ISO BOOST	84
White balance	85
Setting the white balance WB	87
Setting the one-touch white balance 	89
WB compensation 	90
SHARPNESS 	92
CONTRAST 	93
SATURATION 	94
NOISE FILTER 	95
NOISE REDUCTION 	95
SHADING COMP. 	97
COLOR SPACE	97





7 Flash **98**

Optional electronic flashes	98
Using the electronic flash	99
Flash mode	100
Types of flash modes	100
Setting the flash mode	103
Super FP flash	104
Flash intensity control	104
Using commercially available flashes	105
Non-specified commercial flashes	106

8 Playback **107**

Single-frame playback 	107
Close-up playback  /Index display 	108
Information display INFO	109
Slideshow 	111
Picture rotation 	111
Playback on a TV	112
RAW DATA EDIT	113
Protecting pictures 	114
Erasing pictures 	115
Single-frame erase 	115
Erasing selected frames 	116
All-frame erase	117

9 Function/setting customizing **118**

CUSTOM RESET SETTING	118
AEL/AFL	122
EV STEP	125
DIAL	126
RESET LENS	127
FOCUS RING	127
ERASE SETTING	127
FILE NAME	128
REC VIEW	129
Beep sound 	129
Monitor brightness adjustment 	129
SLEEP	130
FORMAT (CARD SETUP)	130
VIDEO OUT	131
Language selection 	131
Date/time setting 	132
PC MODE	133

10 Print reservation ————— 134

What is print reservation?  134

Single-frame reservation  135

All-frame reservation  137

Index-printing reservation  138

Resetting print reservation data 139

 Resetting all-frame print reservation data 139

 Resetting single-frame print reservation data 140

 Resetting index-printing reservation data 142

11 Transferring images to a computer ————— 143

How to download images to a computer 143

Flowchart 144

Identifying the OS 146

 Installing the USB driver for Windows 98
 (When using Windows 98/98SE) 146

Connecting the camera to your computer using the cable 148

Downloading image files to your computer 150

 Windows 98/98 SE/Me/2000/XP 150

 Macintosh 152

Disconnecting the camera from your computer 156

12 Miscellaneous ————— 158

Error codes 158

Troubleshooting 160

Menu directory 166

Maintenance 169

 PIXEL MAPPING and dust reduction 170

 CLEANING MODE 171

Specifications 172

Glossary of terms 175

Index 179

Names of parts

Camera

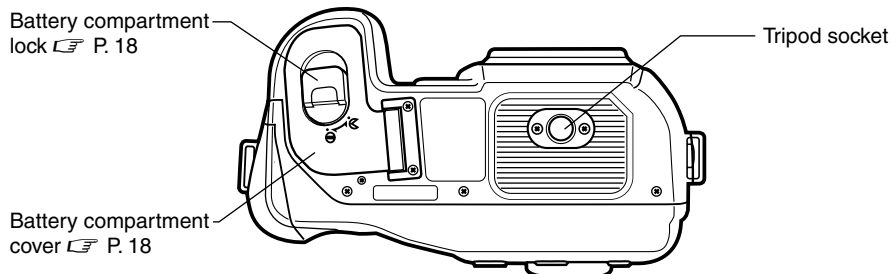
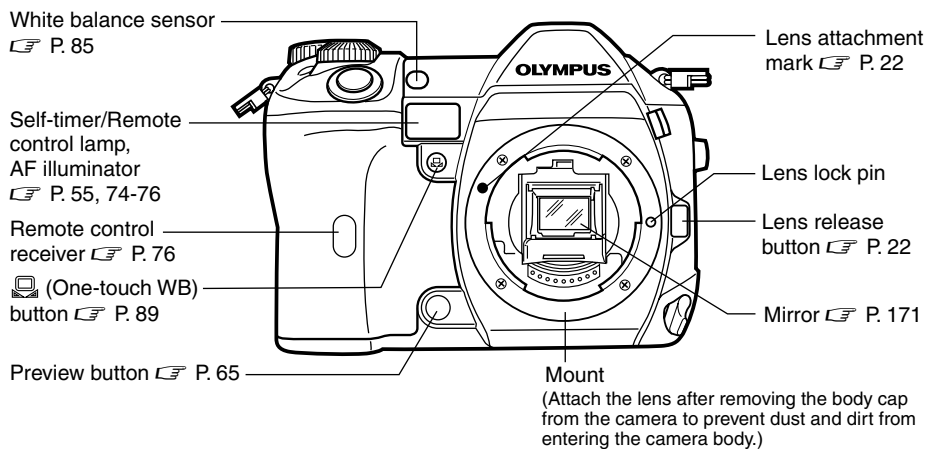
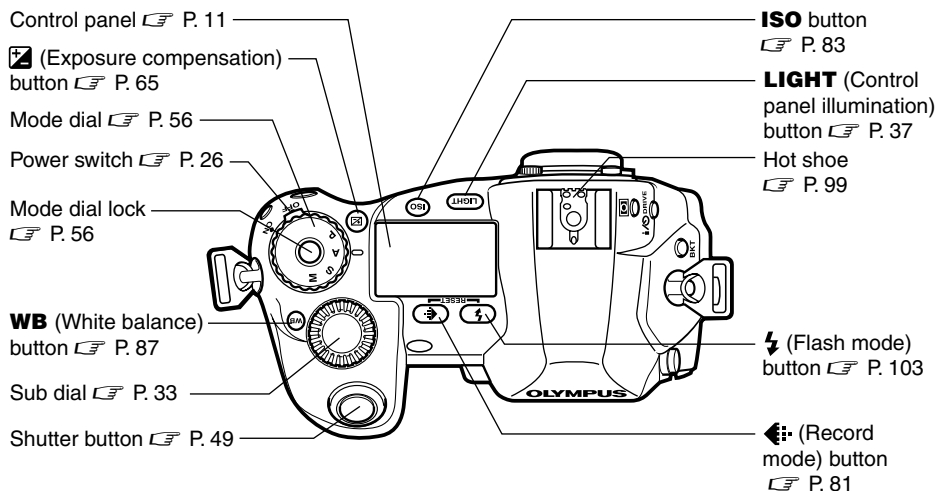

Names of parts

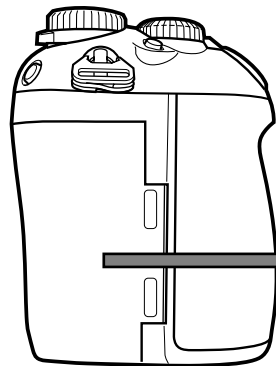
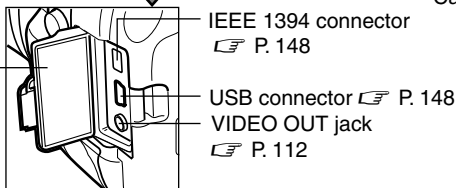
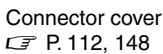
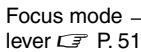
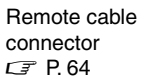
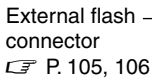
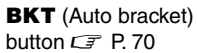
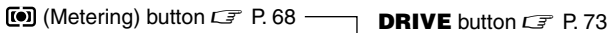
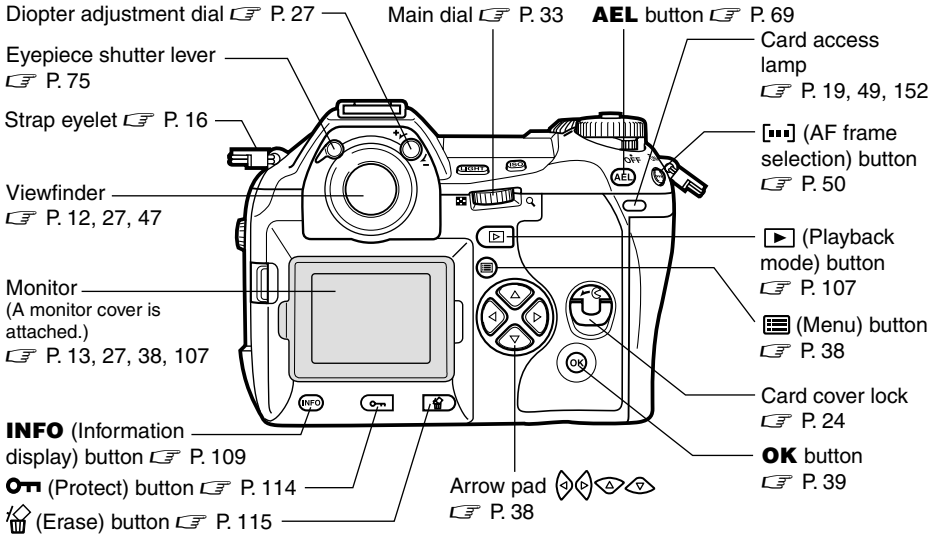

Card slot P. 24

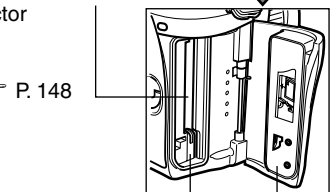

Eject button P. 24

Card cover P. 24

Control panel indications

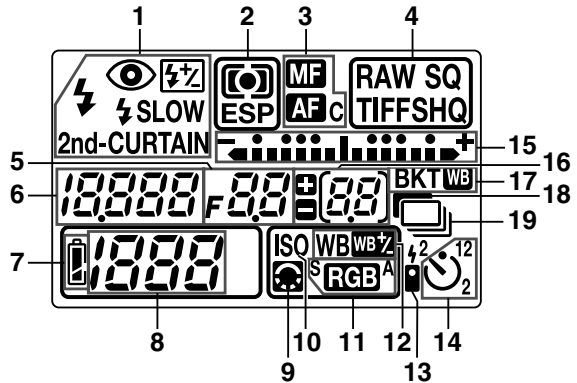

1	Flash mode	P. 102
2	Metering mode	P. 68
3	Focus mode	P. 51
4	Record mode	P. 80
5	Aperture value	P. 57 - 64
6	Shutter speed	P. 57 - 64
7	Battery check	P. 14
8	Number of storable still pictures	P. 57, 80
9	Image quality adjustment.....	P. 92 - 95, 97
10	ISO	P. 83
11	Color space.....	P. 97
12	White balance	P. 88
13	Remote control	P. 75
14	Self-timer	P. 74
15	Exposure level indicator	P. 64
	Exposure compensation indicator.....	P. 66
	AF frame.....	P. 50
16	Number of storable sequential pictures	P. 73
	Exposure compensation value indication [appears only when the <input checked="" type="checkbox"/> (exposure compensation) button has been pressed]	P. 66
17	Auto bracket	P. 70
18	Noise reduction.....	P. 96
19	Sequential shooting	P. 73

Viewfinder indications

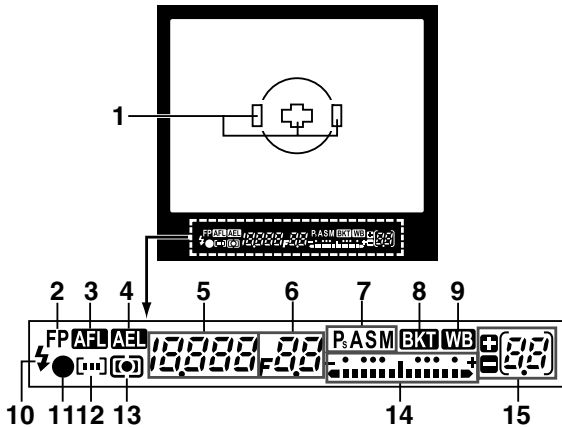

- 1 AF frameP. 49, 50
- 2 Super FP flashP. 104
- 3 AF lockP. 69
- 4 AE lockP. 69
- 5 Shutter speedP. 57 - 64
- 6 Aperture valueP. 57 - 64
- 7 Exposure mode.....P. 58
- 8 Auto bracketP. 70
- 9 White balanceP. 88
- 10 FlashP. 102
- 11 AF confirmation markP. 47
- 12 AF frameP. 50
- 13 Metering modeP. 68
- 14 Exposure level indicator
Exposure compensation indicator.....P. 64
- 15 Number of storable sequential picturesP. 73
Exposure compensation value indication [appears only when the
 (exposure compensation) button has been pressed]P. 66

Monitor indications (only for playback)

You can switch the monitor display using the **INFO** (information display) button and dials.  “Information display” (P. 109)



Single-frame playback information





Shooting information

1	Battery check	P. 14
2	Print reservation	P. 136
	Number of prints	P. 136
3	Protect.....	P. 114
4	Record mode	P. 80
5	Date and time	P. 132
6	File number	P. 110
7	Exposure mode.....	P. 56
8	Metering mode	P. 68
9	ISO sensitivity	P. 83
10	Color space/Saturation	P. 94, 97
11	Focal length	P. 110
12	Shutter speed	P. 57 - 64
13	Aperture value	P. 57 - 64
14	Exposure compensation	P. 65
15	Flash intensity control.....	P. 104
16	White balance	P. 87
17	White balance compensation	P. 90
18	Contrast	P. 93
19	Sharpness.....	P. 92

Battery check indication

When the camera is turned on or if the battery runs out while the camera is being operated, the battery check indication changes on the monitor and control panel as follows:

Battery check	Control panel	Monitor	Viewfinder indications	Remaining power level*
	Lights	Lights (green)	—	High
	Blinks	Lights (red)	Number of storable sequential pictures blinks	Low. Re-charge the battery at once.
No indication	Turns off	Turns off	Turns off	Depleted. Replace the battery with a charged battery.

* The digital camera's power consumption varies greatly depending on usage and operating conditions. Under some operating conditions, the camera may turn off without warning that battery power is low. If this occurs, re-charge the battery.

How to use this manual

This sample page is only for your reference. It may differ from the actual instructions in this manual.

Shows operating procedures.

9 Function/setting customizing

CUSTOM RESET SETTING

Even when the power is turned off, the settings you made while the power was on will be saved. To restore the factory default settings, refer to "How to use reset settings" (P. 119). CUSTOM RESET SETTING allows you to customize and register up to 4 different reset settings for later use.

How to register reset settings

1 In the menu, select **F1** → **CUSTOM RESET SETTING**. Press .

- The CUSTOM RESET SETTING screen appears.
- ↳ "How to use the menus" (P. 38)

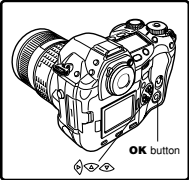

2 Press to select **RESET 1**, **RESET 2**, **RESET 3** or **RESET 4**. Press .

- If menu settings have already been registered, SET is displayed next to the corresponding reset option.

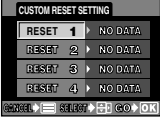

3 Registering:
Press to select **SET**. Press the **OK** button.

- The current settings are registered.

Clearing already registered settings:
Press to select **CLEAR**. Press **OK**.

- Registered settings are canceled.

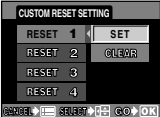

The buttons for various functions and their locations are clearly illustrated.

, , and indicate which button to press on the arrow pad.



• Indications used in this manual

Note	Important information on factors which may lead to a malfunction or operational problems. Also warns of operations that should be absolutely avoided.
TIPS	Useful information and hints that will help you get the most out of your camera.
	Reference pages describing details or associated information.

1 Getting started

Attaching the strap

1

Getting started

- 1 Thread one end of the strap through the strap eyelet on the camera.

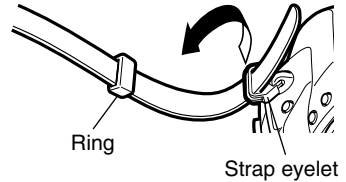

- 2 Thread the end of the strap through the ring, then thread it through the stopper as indicated by the arrows.

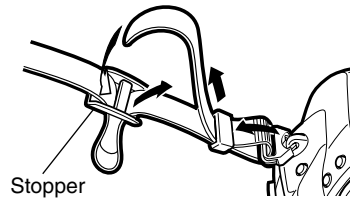

- 3 Thread the strap back through the other hole of the stopper.

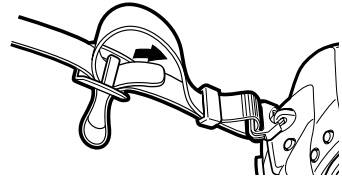

- 4 Pull the other side of the strap tight, making sure that it is fastened securely.

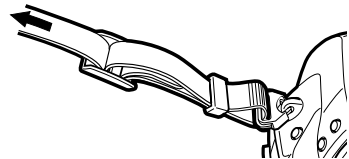

- 5 Repeat steps 1 - 4 to attach the other end of the strap to the other eyelet.

Note

- Be careful with the strap when you carry the camera, since it can easily catch on stray objects, causing injury or damage.
- Attach the strap correctly as shown above so that the camera does not fall off. If the strap is attached incorrectly and the camera falls off, Olympus is not responsible for any damage.

Loading the battery

This camera uses an Olympus lithium ion battery (BLM-1). Never use any other type of battery.

The battery is not fully charged when purchased. Before use, be sure to charge the battery with the specified provided charger (BCM-1).

Note

- Never use a charger other than the one specified. (For details, refer to the charger's manual.)

Charging the battery

- 1** Connect the charger's power cord to the charger.

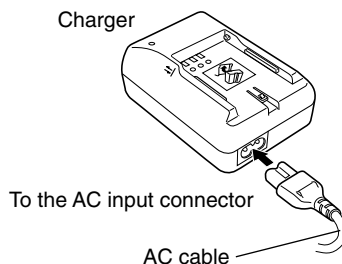

- 2** Plug the power cord into an AC wall outlet.

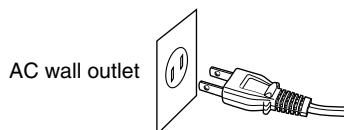

- 3** Remove the battery cap.

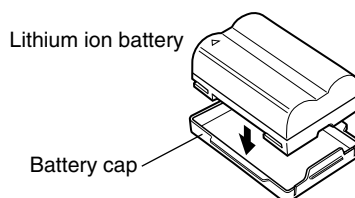

- 4** Hold the battery with its terminals facing the charger and align the battery with the guideline (⇌) on the charger as shown in the illustration. Slide the battery into the charger.

- Charging starts. The battery will be fully recharged in about 2 hours.

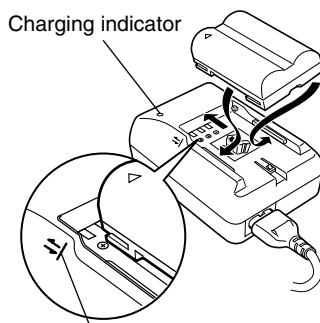

Charging indicator

Charging indicator status	Charging status
Red	Charging
Green	Charging completed
Blinking red	Charging error (time-out, temperature error)

Note

- Be careful not to lose the battery cap, since it is needed when storing the battery.
- In any of the following cases, unplug the power cord from the wall outlet and contact Olympus.
 - Charging has not finished after 6 hours.
 - The indicator blinks red even though the battery is inserted properly as described in the instruction manual.
- Be sure to read the precautions in the battery's manual.

Loading the battery

1 Make sure that the camera's power switch is set to **OFF**.

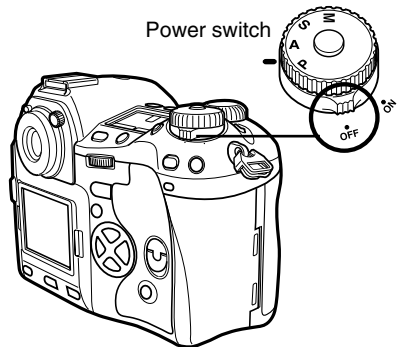

2 Turn the battery compartment lock to \Rightarrow and open the battery compartment cover.

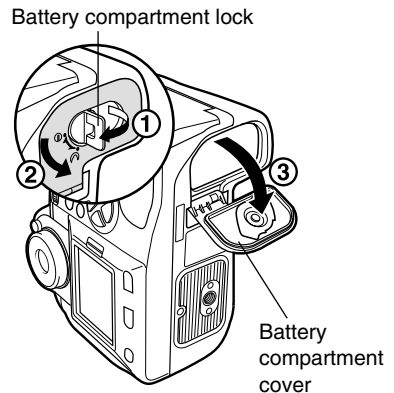

- 3** Load the battery as shown in the illustration.

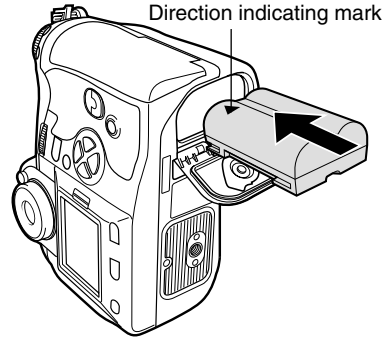

- 4** Push the battery in all the way so that the battery compartment cover closes. Turn the battery compartment lock to \ominus .

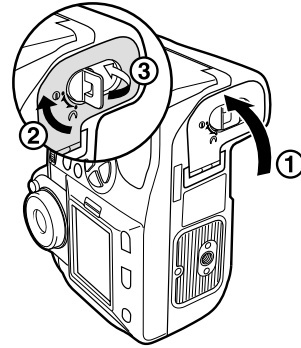

1

Getting started

Unloading the battery

- 1** Make sure the power switch is set to **OFF** and the card access lamp is not blinking.

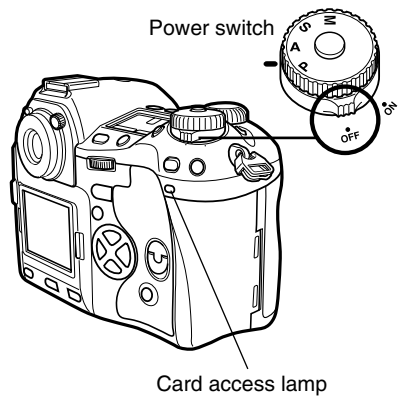

2 Turn the battery compartment lock to \supset and open the compartment cover.

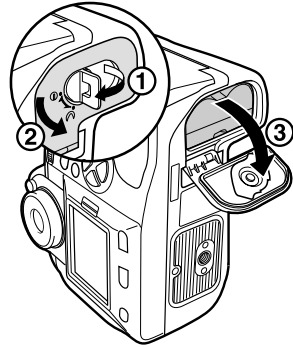

3 Take out the battery.
• Hold the camera sideways or upside down to keep the battery from falling out.

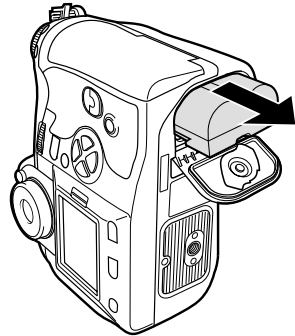

4 Close the battery compartment cover and turn the battery compartment lock to \ominus .

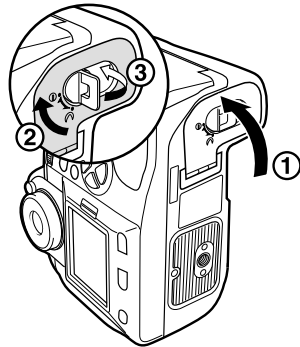

Battery compartment cover

When using the optional power battery holder, remove the battery compartment cover by sliding the pin in the direction of the arrow.

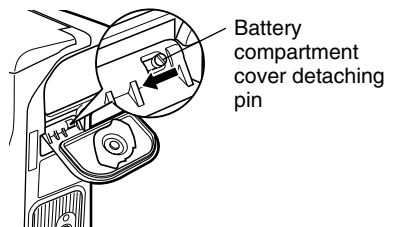

Other power sources

■ AC Adapter

The optional AC Adapter (AC-1) lets you use the camera without worrying about remaining battery power. The AC adapter is useful for time-consuming tasks such as shooting for a long period or downloading images to a personal computer.

■ Power Battery Holder Set

The optional Power Battery Holder Set (SHLD-2) allows you to use the camera for a long period.

For details about attaching the battery holder to the camera, refer to the power battery holder manual.

1

Getting started

Attaching a lens to the camera

Select the lens that you want to shoot with.

Use a specified Four Thirds lens. When a non-specified lens is used, AF (auto focus) and light metering will not function correctly. In some cases, other functions may not work either.

Note

- When you attach or remove the body cap and lens from the camera, keep the lens mount on the camera pointed downward. This helps prevent dust and other foreign matter from getting inside the camera.
- Do not remove the body cap or attach the lens in dusty places.
- Do not point the lens attached to the camera toward the sun. This may cause the camera to malfunction or even ignite due to the magnifying effect of sunlight focusing through the lens.
- Be careful not to lose the body cap and lens cap.
- Attach the body cap to the camera to prevent dust from getting inside when no lens is attached.

■ Attaching the lens to the camera

- 1 Make sure the power switch is set to **OFF**.

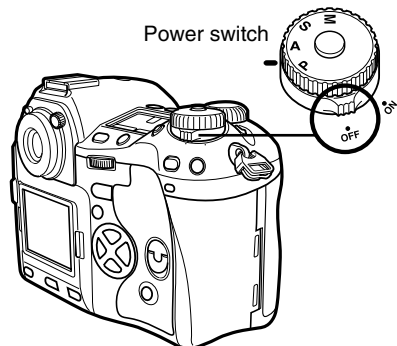

2 Remove the body cap from the camera.

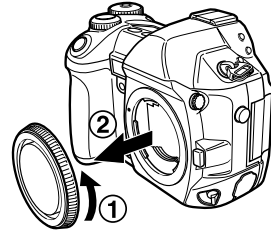

3 Remove the rear cap from the lens.

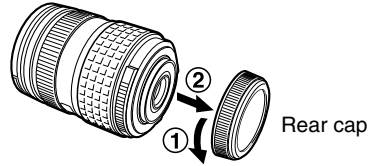

4 Align the lens attachment mark (red) on the camera with the alignment mark (red) on the lens, then insert the lens into the camera's body. Rotate the lens clockwise until you hear it click.

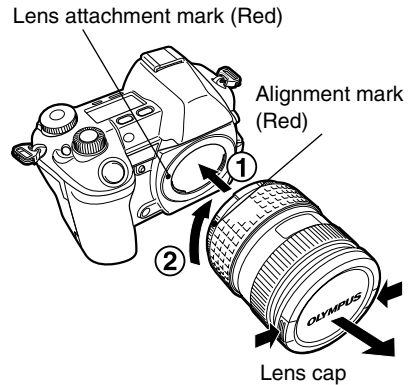

5 Remove the lens cap.

■ Removing the lens from the camera

1 Make sure the power switch is set to **OFF**.

2 While pressing the lens release button, remove the lens from the camera by rotating it counterclockwise.

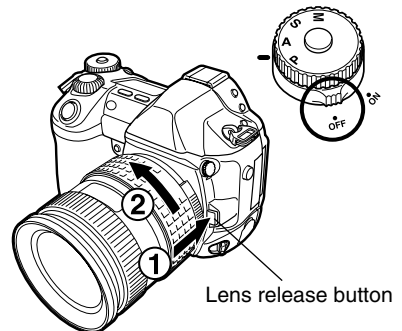

Inserting a card

“Card” in this manual refers to a recording medium. This camera can use a Compact Flash or Microdrive (optional). You can also use xD-Picture Card with a card adapter (optional).

■ Compact Flash

A Compact Flash is a large-capacity solid state flash memory card. You can use commercially available cards.

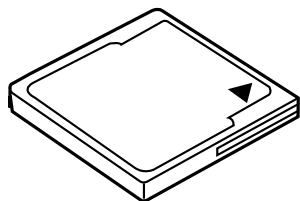

■ Microdrive

A Microdrive is a medium that uses a large-capacity compact hard disk drive. You can use a Microdrive that supports CF+Type II (Compact Flash extension standard).

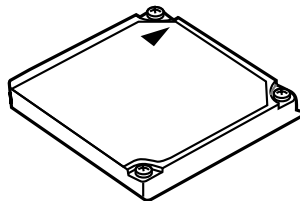

Precautions when using a Microdrive

A Microdrive is a medium that uses a compact hard disk drive. Because the disk drive rotates, a Microdrive is not as resistant to vibration or impact as other cards. Special care is needed when using a Microdrive (especially during recording and playback) to make sure the camera is not subjected to shock or vibrations. Be sure to read the following precautions before using a Microdrive. Also, refer to the manuals provided with your Microdrive.

- Be very careful when putting the camera down during recording. Place it gently on a firm surface.
- Be careful not to hit the camera against anything when carrying it by the strap.
- Do not use the camera in places subject to vibrations or excessive shock, such as at a construction site or in a car while driving along a bumpy road.
- Do not take a Microdrive close to areas where it may be exposed to strong magnetism.
- Microdrives confirmed for use with this camera (as of July, 2003):

Hitachi/IBM

DSCM-1100 (1 GB)

DSCM-10512 (512 MB)

DSCM-10340 (340 MB)

How to insert/remove the card

■ Inserting the card

- 1 Turn the card cover lock in the direction of the arrow and open the card cover.

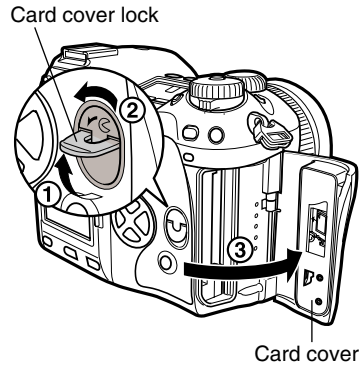

- 2 Insert the card fully with the ◀ mark side facing toward the monitor side (the camera's rear side) as illustrated.

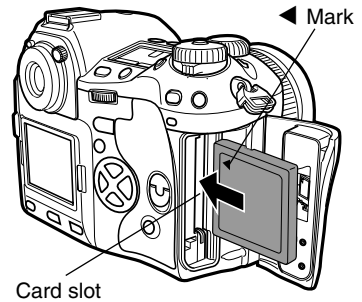

- 3 Close the card cover.

- When the eject button is projecting, push it back in.

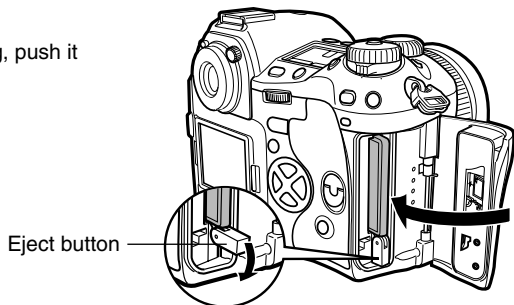

TIPS

After inserting the card, if **CARD ERROR** appears on the monitor, and the camera cannot read the images in the card.

→ Format the card on the camera, or run SCANDISK on a PC.

☞ "FORMAT (CARD SETUP)" (P. 130)

■ Removing the card

1 Make sure that the card access lamp is not illuminated.

2 Open the card cover.

3 Raise the eject button.

4 Press the eject button gently.

- The card comes out.
- If you press the eject button too hard, the card may jump out of the camera.
- Pull out the card.

5 Place the eject button on its side.

6 Close the card cover.

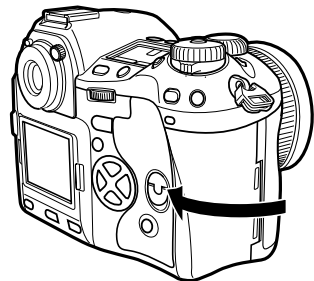
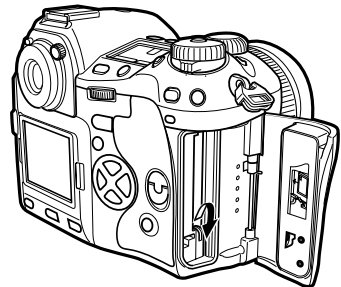
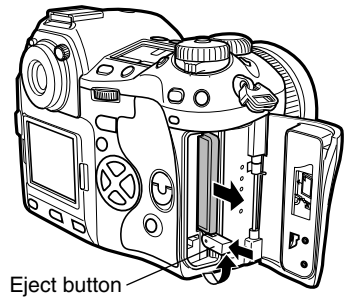
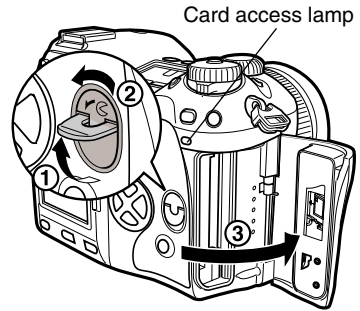

Power ON/OFF

Power ON : Set the power switch to **ON**.

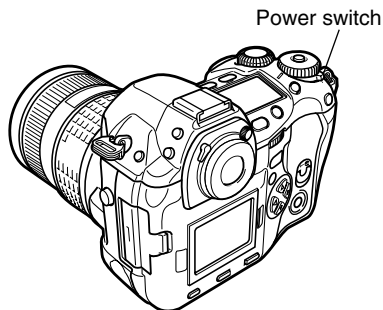
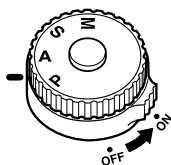

Power OFF : Set the power switch to **OFF**.

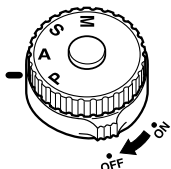

The date/time information is used as the basis for assigning file numbers to recorded images. Make sure the date/time setting is correct after setting the power switch to **ON**.

Battery check indication

When the power switch is set to ON, the battery check indication appears on the control panel.

☞ “Battery check indication” (P. 14)

Control panel

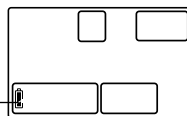

Battery check

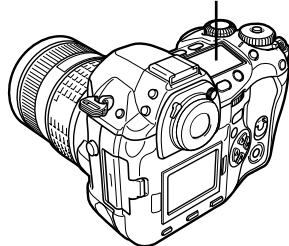

Dust reduction function operation

The dust reduction function is automatically activated when the camera is turned on. Ultrasonic vibrations are used to remove dust and dirt from the CCD surface. ☞ “Maintenance” (P. 169)

Date/time setting

Images will be stored with date/time data. ☞ “Date/time setting” (P. 132)

Selecting a language

You can select the language for on-screen displays. This reference manual shows the English on-screen displays in illustrations and explanations. Available languages vary depending on the area where you purchased the camera. ☞ “Language selection” (P. 131)

Monitor cover

The monitor cover protects the monitor from getting dirty or damaged. Normally keep it attached to the monitor when using the camera as the monitor indications are still visible with the cover attached. If you want to detach it, refer to the illustration on the right.

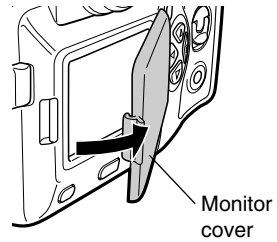

1

Getting started

Adjusting the viewfinder's diopter

While looking through the viewfinder, rotate the diopter adjustment dial little by little to the right or the left.

When you can see the AF frame clearly, adjustment is complete.

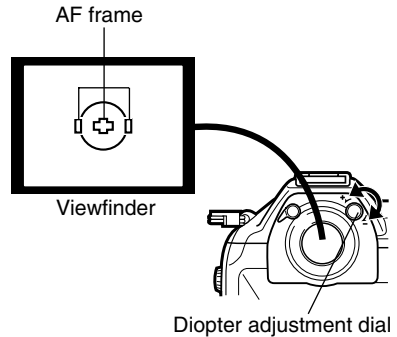

Eyecup

You can also use the optional eyecup to see the viewfinder clearly. The camera is equipped with a standard eyecup. Remove this eyecup from the camera to attach the optional eyecup. To remove the eyecup, turn it as illustrated.

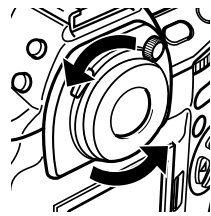

Removing the eyecup

Focusing screen

You can replace the focusing screen with the optional grid screen. When doing this, use the tweezers provided with the screen. For details about replacing the screen, refer to the screen manual.

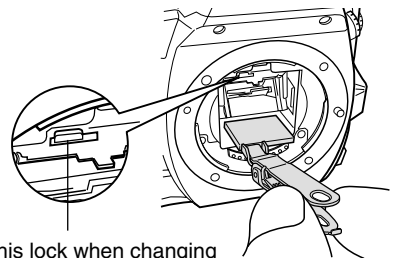

Remove this lock when changing the focusing screen.

Holding the camera

- 1** Hold the camera's grip with your right hand and keep your elbow at your side.
- 2** Rest your elbow gently against your body and hold the lens section firmly from underneath with your left hand.
- 3** Take a picture.
 - Putting one leg a little forward helps stabilize your upper body.



Vertical grip

Note

- Keep your fingers and the strap away from the AF illuminator and white balance sensor.

Bad technique

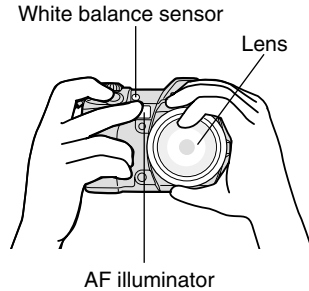

2 Shooting and playback basics

This chapter describes the basic procedures used for shooting and playback. Important useful functions are highlighted in each step.

1 Getting started

- Charge the battery.
- Attach the lens.
- Insert the battery and card into the camera.

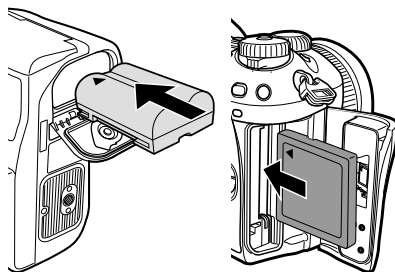

2 Shooting function setting

- Turn on the power.
- Set the date and time.
- Set the exposure mode.

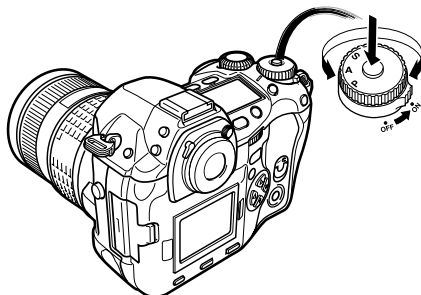

2

Shooting and playback basics

Menus & buttons	(P. 32)
Exposure mode	(P. 56)
Focus mode	(P. 51)
Drive mode	(P. 73)
Record mode (RAW, TIFF, SHQ, HQ, SQ)	(P. 79)
ISO sensitivity	(P. 83)
White balance	(P. 85)
Preview function	(P. 65)
FORMAT (CARD SETUP)	(P. 130)

3 Shooting

Press the shutter button halfway.

- The camera focuses on the subject and the AF confirmation mark lights.

Press the shutter button all the way (fully) to release the shutter.

- A picture is taken. The card access lamp blinks while the picture is being stored on the card.

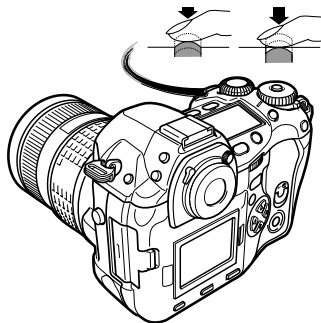

Focus lock	(P. 49)
AE lock	(P. 69)
AF lock	(P. 69)
AF frame selection	(P. 50)
Exposure compensation	(P. 65)
Metering mode (Digital ESP metering, Center weighted averaging metering, spot metering)	(P. 68)
REC VIEW	(P. 129)

4 Playback

Press the  (playback mode) button. Pictures are played back on the monitor.

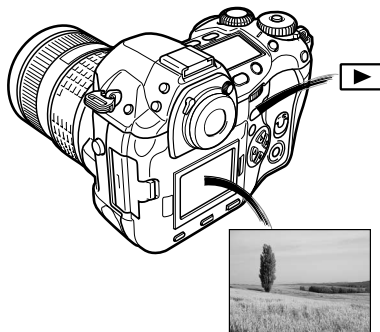

Information display	(P. 109)
Close-up playback	(P. 108)
Index display	(P. 108)
Slideshow	(P. 111)
Picture rotation	(P. 111)
Protecting pictures	(P. 114)
RAW DATA EDIT	(P. 113)
Erasing pictures	(P. 115)
Playback on a TV	(P. 112)

5 Image transfer to a computer

Connect the camera to a computer using the provided USB cable or IEEE1394 cable (Windows 98/98SE/2000/Me/XP, Mac OS 9.0 - 9.2/X).

Turn on the camera's power.

Transfer images to the computer.

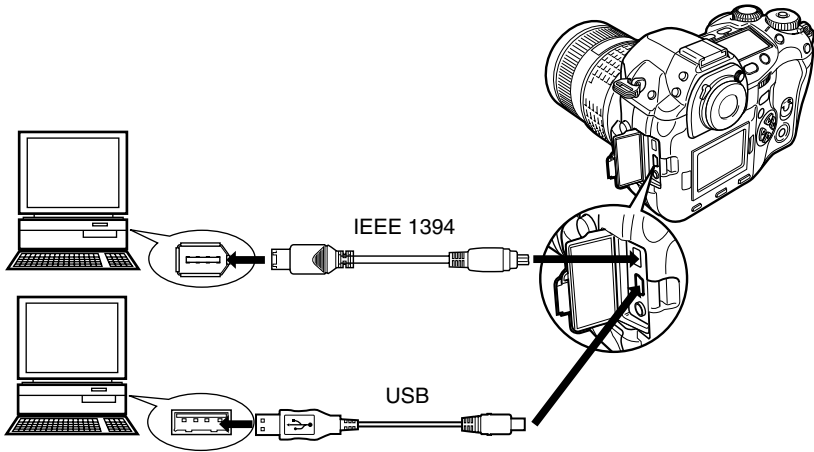

PC MODE (P. 133)

3 Buttons and menus

This camera has a variety of functions to make optimal settings for various shooting conditions. You can set the function settings using the buttons, dials, or menu.

Functions available using the buttons : Change camera settings with the buttons and main dial or sub dial, while referring to the control panel.

This allows for fast camera setting changes without having to use the monitor menus.

Functions available using the monitor menus : Change camera settings with the monitor menus while referring to the monitor.

3

Functions available using the buttons and menus

Buttons and menus

How to operate the buttons and dials

1 Press the button for the function you want to set.

- The control panel indications vary depending on the function.

Control panel

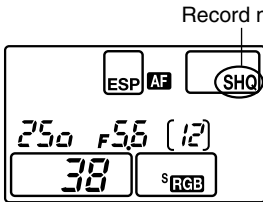

When pressing the  (record mode) button

Exposure compensation value is displayed.

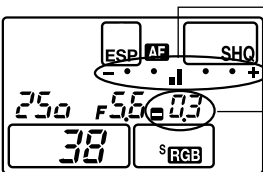

When pressing the  (exposure compensation) button (The function settings are being displayed.)

The ISO sensitivity is displayed.

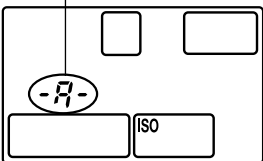

When pressing the **ISO** button (The function settings are being displayed.)

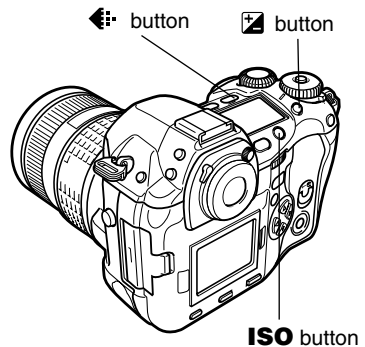

2 While holding down the button, turn the main dial or sub dial.

- The settings will change.

Control panel

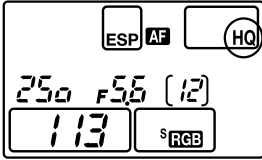

When changing image quality

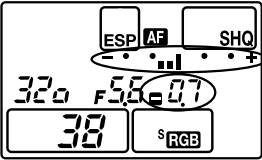

When changing  (exposure compensation)

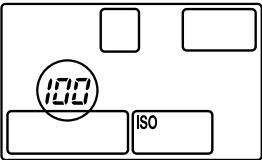

When changing **ISO**

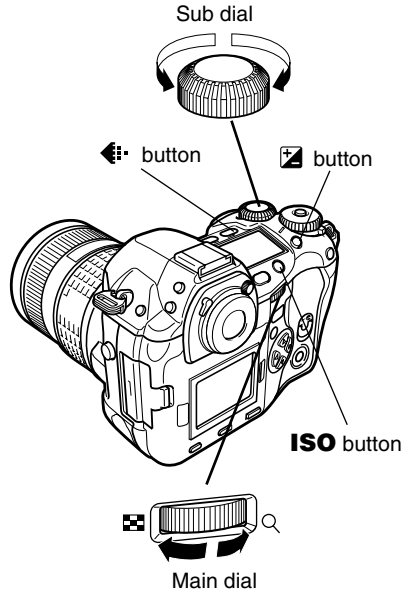

Types of buttons

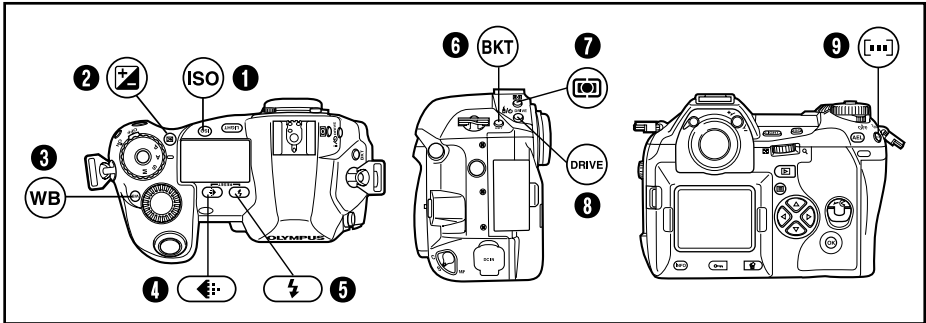

Make function settings by turning the main dial or sub dial while holding down the button.

1 ISO button

P. 83

Sets the ISO sensitivity.

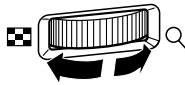

-A- (auto) ↔ 100 ↔ 200 ↔ 400 ↔ 800

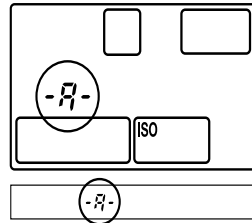

- Setting ISO BOOST allows you to add 1600 and 3200 to the ISO value options.

2 (Exposure compensation) button

P. 65

Sets the exposure compensation value.

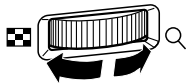

Exposure compensation value:

-1.0 ↔ -0.7 ↔ -0.3 ↔ 0.0 ↔ 0.3 ↔ 0.7 ↔ 1.0

- The exposure can be adjusted within a range of ±5.0 EV. Available EV steps are: 1/3EV, 1/2EV, 1EV. Changing the EV value changes the amount of exposure compensation.
- "EV STEP" (P. 125)

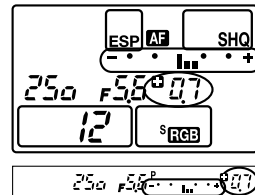

3 WB (White balance) button P. 87

Selects the white balance appropriate to the light source from the following options: Auto, preset white balance settings, registered white balance.

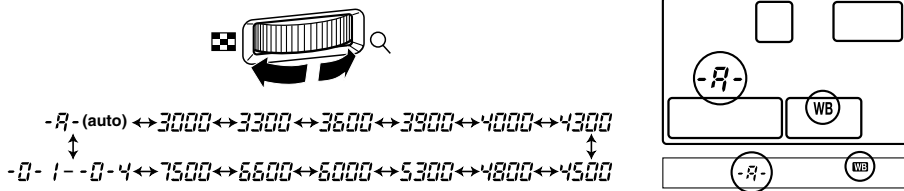

4 (Record mode) button P. 81

Selects image quality.

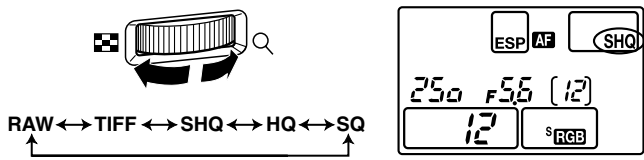

You can select the compression and number of pixels in the SQ mode.

☞ "Setting the SQ mode" (P. 81)

5 (Flash mode) button P. 103

Selects a flash mode from auto-flash, red-eye reduction flash, slow synchronization, or fill-in flash.

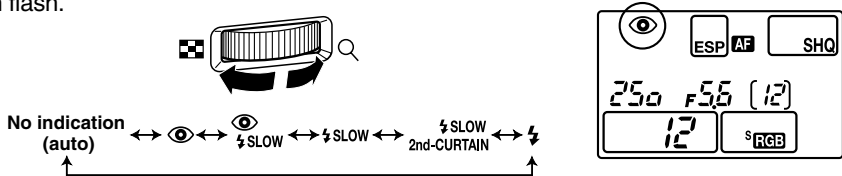

6 BKT (Auto bracket) button P. 70

Selects the number of sequential shooting frames and the exposure compensation value during auto bracketing.

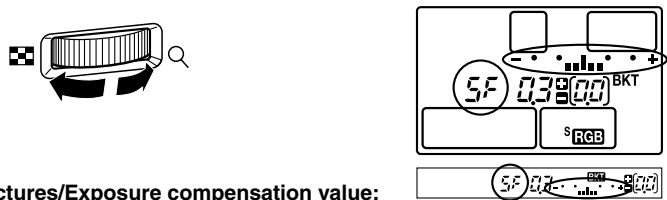

Number of storable pictures/Exposure compensation value:

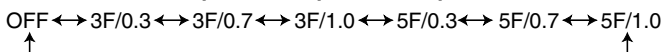

• Changing the EV step changes the compensation level. ☞ "EV STEP" (P. 125)

7 [METERING] (Metering) button P. 68

Selects the metering mode.

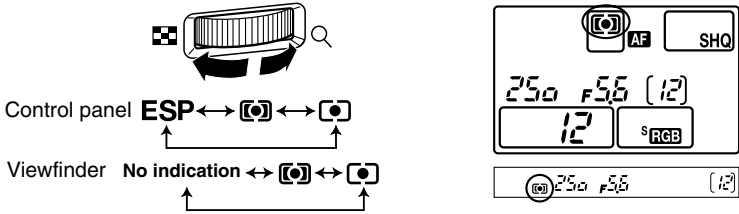

8 DRIVE button P. 73

Selects the drive mode.

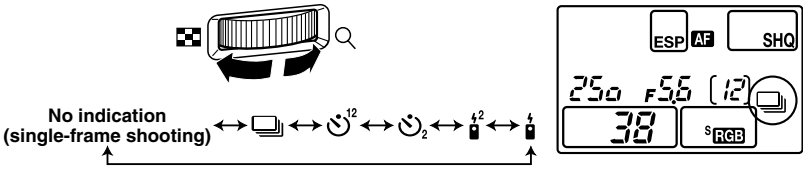

9 [AF] (AF frame selection) button P. 50

Selects the AF frame, allowing you to perform multiple AF or to perform AF using one of the 3 frames.

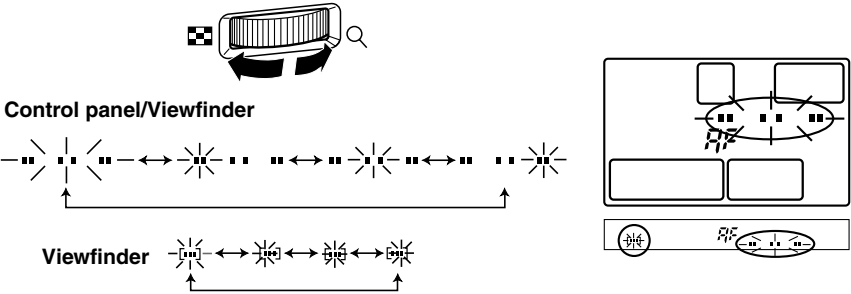

■ Other buttons



(One-touch WB) button

P. 89

Used for registration of one-touch WB settings.

AEL button

P. 69

Locks the exposure.

LIGHT (Control panel illumination) button

Sets the illumination on the control panel to ON/OFF.



(Playback mode) button

P. 107

Plays back images on the monitor.



(Erase) button

P. 77, 115

Erases unwanted pictures. Pressing this button also allows you to playback pictures even while the camera is in the shooting mode.



(Protect) button

P. 114

Protects important pictures from being accidentally erased.

INFO (Information display) button

P. 109

Displays shooting information.

How to use the menu

While viewing the menu screen in the monitor, you can select the function to set using the arrow pad.

1 Press the  (menu) button to display the menu on the monitor.

2 Press  to select a tab, then press .

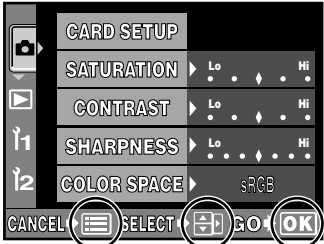

Buttons required for function settings are displayed in the menu screen.

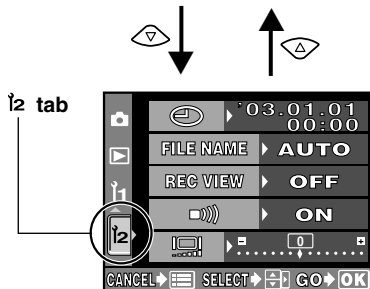
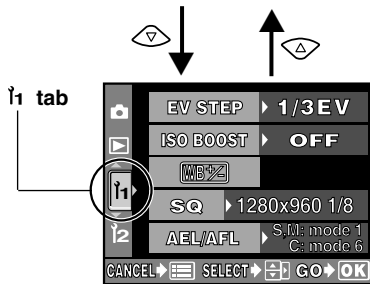
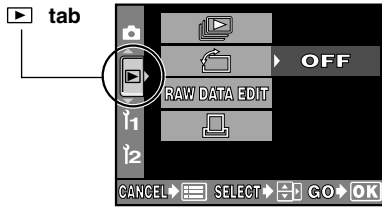
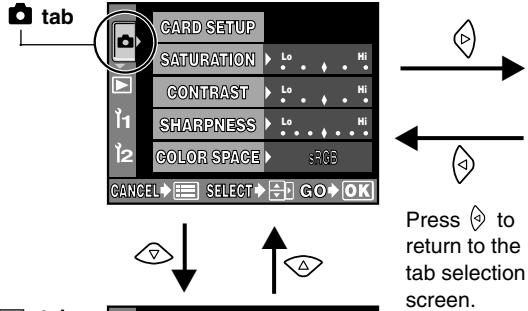
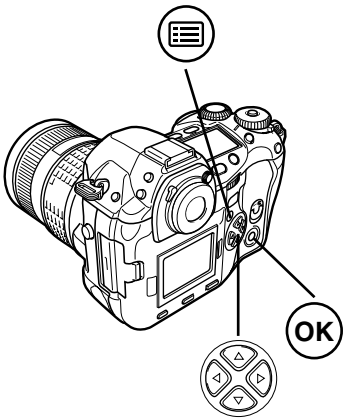

3 Press to select an item, then press .

The sliding bar is displayed when a menu continues on additional screens.

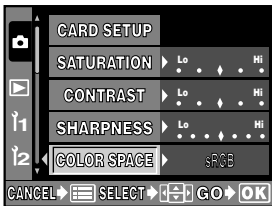
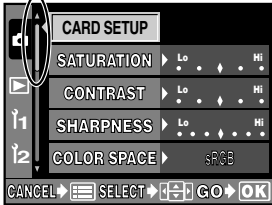

The green frame moves to the selected item.

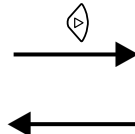

Confirm with the **OK** button. Cancel with or the button.

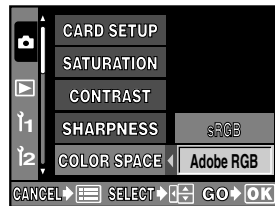
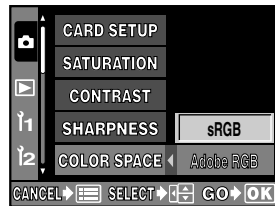

4 Press to change a setting. Press the **OK** button to complete your setting. Press **OK** again to exit the menu and return to shooting.

To cancel the selection, press . If you return to the previous screen by pressing or instead of **OK**, your setting is not saved.



3
Buttons and menus



Note



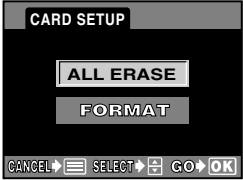
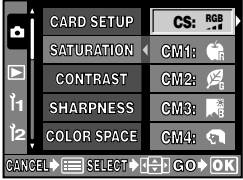
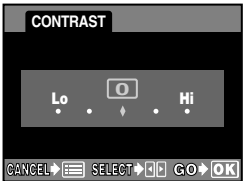

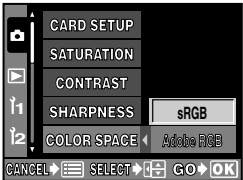
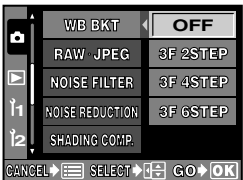

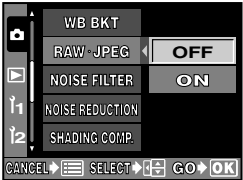
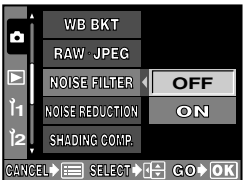
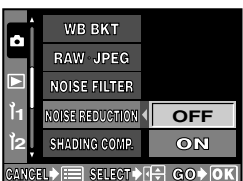

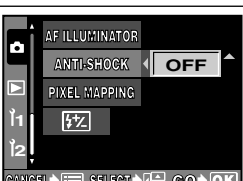

- Some settings may not be available depending on the status of the camera and other current settings.
- Saved settings will be retained even after the camera is turned off.



"CUSTOM RESET SETTING" (P. 118)



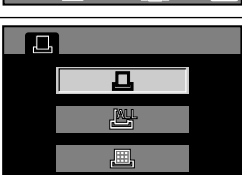

List of menu functions

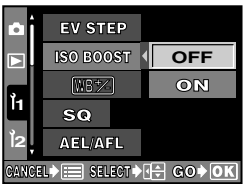
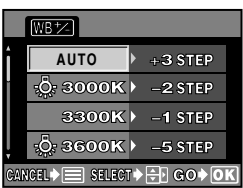
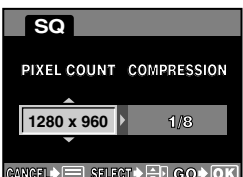
Menu screen	Function	Ref. page
	<p>CARD SETUP</p> <p>Formats the card or erases all pictures.</p>	P. 130
	<p>SATURATION</p> <p>Sets the color tint of images. CS0 - CS4 set the saturation level, while CM1 - CM4 emphasize certain colors. Saturation can be set to 5 levels. With the tint, CM1 stresses red, CM2 - green, CM3 - blue, and CM4 - softer red than CM1. The saturation level and tint cannot be set at the same time.</p>	P. 94
	<p>CONTRAST</p> <p>Sets the contrast (distinction between light and dark) of images. The contrast can be set to 5 levels.</p>	P. 93
	<p>SHARPNESS</p> <p>Sets the sharpness of images. The sharpness can be set to 7 levels.</p>	P. 92
	<p>COLOR SPACE</p> <p>Sets the system that correctly reproduces the color of recorded images on the monitor or printer.</p>	P. 97
	<p>WB BKT</p> <p>Performs WB bracketing. The compensation level can be selected from 3 levels.</p>	P. 72

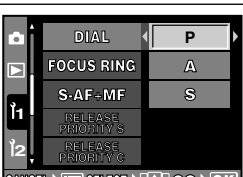



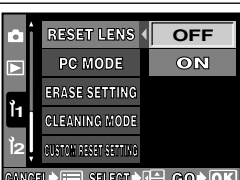
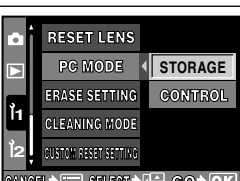

Menu screen	Function	Ref. page
	<p>RAW • JPEG</p> <p>Records images in both the RAW data format and JPEG format when using the SHQ, HQ, or SQ mode.</p>	<p>P. 82</p>
	<p>NOISE FILTER</p> <p>Eliminates the random noise that is generated during normal shooting. This process may take some time.</p>	<p>P. 95</p>
	<p>NOISE REDUCTION</p> <p>Reduces the noise in images that is generated by long exposures when shooting under low-light conditions.</p>	<p>P. 95</p>
	<p>SHADING COMP.</p> <p>Allows you to compensate for the dark areas at image edges caused by the lens's properties.</p>	<p>P. 97</p>
	<p>AF ILLUMINATOR</p> <p>Emits a supplementary light to enable easy AF performance under low light conditions.</p>	<p>P. 55</p>
	<p>ANTI-SHOCK</p> <p>Diminishes camera shake caused by vibrations when the mirror moves. You can select the interval from the time the mirror is raised until the shutter is released.</p>	<p>P. 78</p>

	Menu screen	Function	Ref. page
Shooting menu		PIXEL MAPPING Checks and adjusts the CCD and image processing functions. Dust and dirt are also blown off at the same time.	P. 170
		 Adjusts the amount of light emitted when using the flash unit specified for use with this camera. You can set the intensity within a range of ± 2.0 .	P. 104
Playback menu		 Displays still pictures stored in the card as a slideshow. Slideshow capability is also available using the index display.	P. 111
		 Changes picture orientation to portrait or landscape. You can rotate pictures with the sub dial.	P. 111
		RAW DATA EDIT Performs image processing (such as white balance and sharpness adjustment) on images in the RAW data format, then converts the data to the TIFF or JPEG format for saving to the card.	P. 113
		 Stores print reservation data on the card. You can store print information such as the number of images, date/time data and index prints.	P. 135

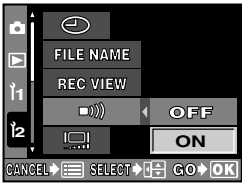
Menu screen	Function	Ref. page
	<p>EV STEP</p> <p>Sets the degree of change for one click of the dial when changing the shutter speed, aperture value, exposure compensation value, etc.</p>	<p>P. 125</p>
	<p>ISO BOOST</p> <p>Allows the use of ISO 1600 and 3200.</p>	<p>P. 84</p>
	<p>WB Z</p> <p>Compensates the auto and preset white balance (3000K - 7500K) respectively within a range of ±7.</p>	<p>P. 90</p>
	<p>SQ</p> <p>Sets the number of pixels and compression for the SQ record mode.</p>	<p>P. 81</p>
	<p>AEL/AFL</p> <p>Allows you to select the AE or AF function that you want performed when you press the AEL (AE lock) button.</p>	<p>P. 122</p>
	<p>DIAL</p> <p>Allows you to select a combination of functions (Program shift (Ps), exposure compensation, aperture setting, or shutter speed setting) to be assigned to the main dial and/or sub dial for each mode (P, A, S).</p>	<p>P. 126</p>

Menu screen	Function	Ref. page
	<p>FOCUS RING</p> <p>You can choose the rotational direction of the focus ring to suit your preference of how the lens adjusts to the focusing point.</p>	<p>P. 127</p>
	<p>S-AF+MF</p> <p>Allows you to finely adjust the focus using the focus ring, after the camera has already adjusted the focus in the S-AF mode.</p>	<p>P. 52</p>
	<p>RELEASE PRIORITY S</p> <p>Allows you to release the shutter in the S-AF mode without waiting until focusing or flash charging finishes.</p>	<p>P. 54</p>
	<p>RELEASE PRIORITY C</p> <p>Allows you to release the shutter in the C-AF mode by pressing the shutter button all the way, even while adjusting the focus.</p>	<p>P. 54</p>
	<p>RESET LENS</p> <p>Resets the focus of the lens when the power is turned off.</p>	<p>P. 127</p>
	<p>PC MODE</p> <p>Selects how the camera is to be operated when it is connected to a PC. You can choose whether to transfer images from the camera to the PC (STORAGE), or control the camera with the dedicated software (CONTROL).</p>	<p>P. 133</p>

	Menu screen	Function	Ref. page
Custom menu		<p>ERASE SETTING</p> <p>Selects the initial cursor position on the YES/NO selection screen for erasing pictures, canceling recording or formatting.</p>	P. 127
		<p>CLEANING MODE</p> <p>When the shutter button is pressed all the way in the cleaning mode, the mirror rises and the shutter curtain opens.</p>	P. 171
		<p>CUSTOM RESET SETTING</p> <p>Up to 4 reset settings can be saved for when the camera is turned off.</p>	P. 118
Setup menu		<p></p> <p>Sets the date and time on the camera. The date/time data is stored together with the corresponding recorded image. File numbers are also assigned to recorded images using date/time information.</p>	P. 132
		<p>FILE NAME</p> <p>Changes how image files are numbered. You can choose whether to retain the file number even if a new card is inserted, or reset it.</p>	P. 128
		<p>REC VIEW</p> <p>Displays the picture you have just taken on the monitor while it is being recorded to the card.</p>	P. 129

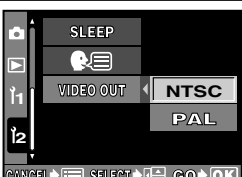
Menu screen	Function	Ref. page
	<p></p> <p>Turns off the beep used for warnings.</p>	<p>P. 129</p>
	<p></p> <p>Adjusts the brightness of the monitor.</p>	<p>P. 129</p>
	<p>SLEEP</p> <p>Sets the time before the sleep mode (idle mode) begins. When OFF is selected, the camera does not enter the sleep mode.</p>	<p>P. 130</p>
	<p></p> <p>Selects the language for on-screen displays.</p>	<p>P. 131</p>
	<p>VIDEO OUT</p> <p>Selects NTSC or PAL according to your TV's video signal. TV video signal types differ depending on the region.</p>	<p>P. 131</p>

4 Focus

Auto focus (AF)

The camera automatically focuses on the subject.

1 Position the AF target mark on the subject you want to focus on. Press the shutter button halfway.

- The focus is locked and the AF confirmation mark lights up (focus lock).
- A beep sound is output when the subject is in focus.

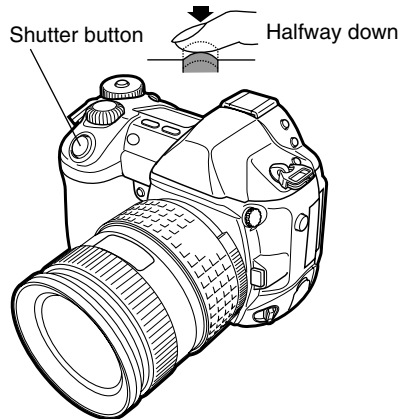
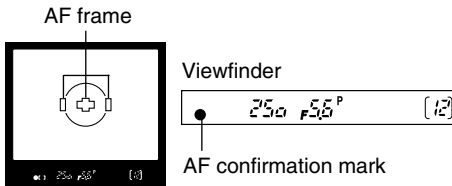

2 Press the shutter button all the way (fully).

- A picture is taken.
- The card access lamp blinks while the picture is being stored on the card.

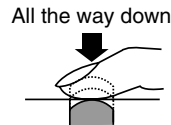

TIPS

The AF confirmation mark blinks.

- The subject is out of focus. ☞ "Focus lock" (P. 49), "AF frame selection" (P. 50)
- There is not enough illumination to focus because the subject is dark. ☞ "AF ILLUMINATOR" (P. 55)
- Depending on the subject, it may not be possible to focus. ☞ "Subjects that are difficult to focus on" (P. 48)
- If AF is not possible, use manual focus (MF). ☞ "Manual focus (MF)". (P. 54)

To turn off the beep sound:

- You can turn off the warning beep sound. ☞ "Beep sound" (P. 129)

To check the picture you have just taken:

- You can view pictures you have taken on the monitor. ☞ "REC VIEW" (P. 129)

How to release the shutter at the right moment:

- Pressing the shutter button all the way allows you to take pictures while adjusting the focus. ☞ "RELEASE PRIORITY S & RELEASE PRIORITY C" (P. 54)

Note

- Press the shutter button gently. If it is pressed hard, the camera may move and pictures may come out blurred.

Subjects that are difficult to focus on

Under the following conditions, AF may not work properly. Take a picture using focus lock (P. 49), manual focus (P. 54), or by selecting an AF frame (P. 50).

The AF confirmation mark blinks. The subject cannot be brought into focus.

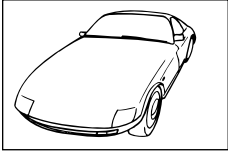

Subject with low contrast

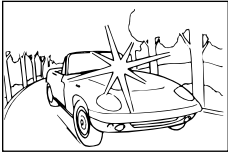

Subject with an extremely bright area in the frame

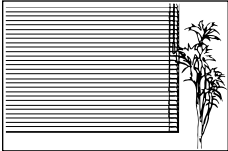

Subject with repeated patterns

The AF mark stays lit, but the subject cannot be brought into focus.



Subjects at different distances

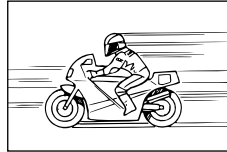

Fast-moving subject



The subject is not positioned within the AF frames.

Focus lock

When the subject cannot be brought into focus, you can lock the focus (focus lock) as shown below.

1 When shooting a hard-to-focus subject or a fast-moving subject, point the camera at another object about the same distance away as the subject. Position the AF target mark on the subject you want to focus on.

2 Press the shutter button halfway until the AF confirmation mark lights.

- The focus is locked.
- If the AF confirmation mark blinks, the focus and exposure are not locked. Remove your finger from the shutter button, re-position your subject and press the shutter button halfway again.

Shutter button

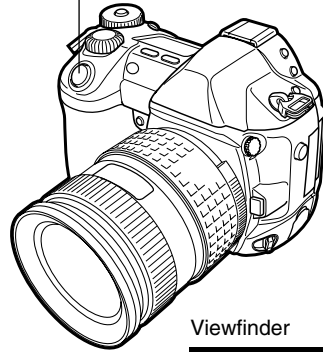

Viewfinder

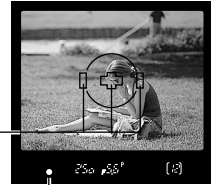

AF frame

AF confirmation mark

3 While keeping the shutter button pressed halfway, re-compose your shot.

Viewfinder



Halfway down

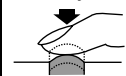

4 Press the shutter button all the way.

- A picture is taken.
- The card access lamp blinks while the picture is being stored on the card.

All the way down

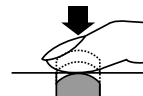

4

Focus



Normally, the camera measures the distance to the subject using the 3 AF frames in the viewfinder and selects the most appropriate point. This function allows you to select only one AF frame.

- No indication : Focuses using the 3 AF frames. (Factory default setting)
- [] : Focuses using the left AF frame.
- [•] : Focuses using the center AF frame.
- [] : Focuses using the right AF frame.

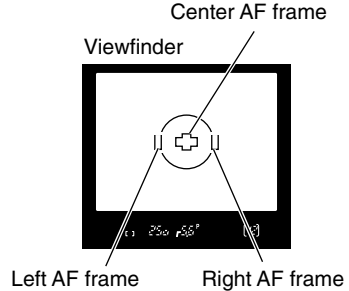

4

Focus

1 While pressing the [] (AF frame selection) button, rotate the main dial or sub dial until the AF frame (blinking) you want to select is displayed.

Viewfinder indications when selecting the AF frame

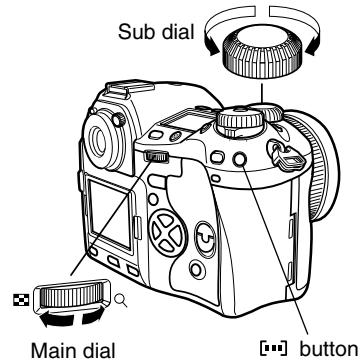
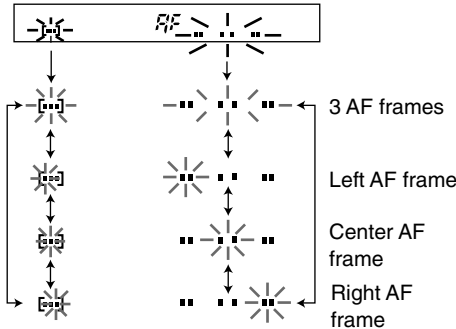

Control panel

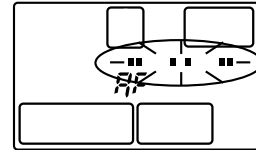

Control panel indications can be switched as well as viewfinder indications.

2 Take a picture.

Focus mode

Three focus modes are available with this camera: S-AF (single AF), C-AF (continuous AF) and MF (manual focus). You can switch focus modes using the focus mode lever.  “S-AF (single AF) shooting” (refer to the instruction below), “C-AF (continuous AF) shooting” (P. 53), “Manual focus (MF)” (P. 54)

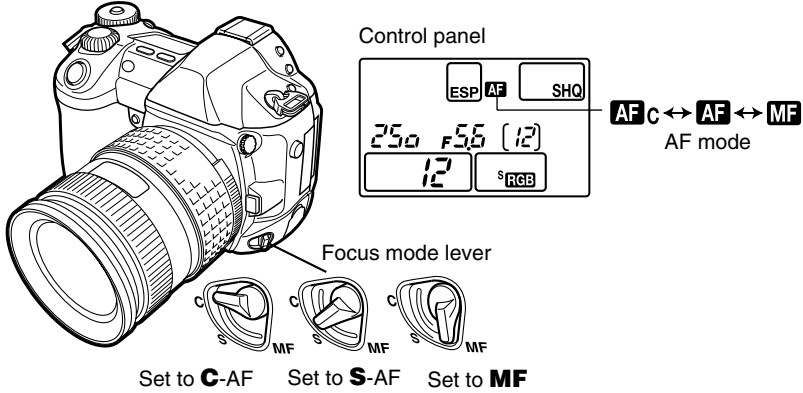

S-AF (single AF) shooting

Focusing is performed one time when the shutter button is pressed halfway. If focusing fails, remove your finger from the shutter button and press it halfway again. This mode is suitable for taking pictures of non-moving subjects or subjects with limited movement.

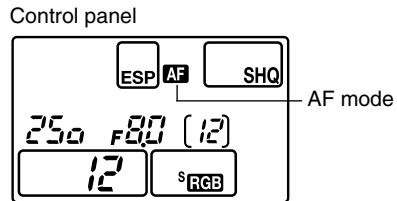

1 Press the shutter button halfway.

- The focus is locked and the AF confirmation mark lights up.
- A beep sound is output when the subject is in focus.

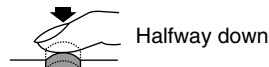

Viewfinder

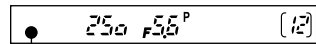

AF confirmation mark

2 Press the shutter button all the way.

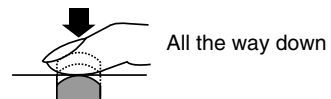

TIPS**How to release the shutter at the right moment:**

- Pressing the shutter button all the way allows you to take pictures while adjusting the focus.
 - ☞ “RELEASE PRIORITY S & RELEASE PRIORITY C” (P. 54)

To adjust focus manually while using AF:

- Focus can also be adjusted manually after using AF. ☞ “Simultaneous use of S-AF mode and MF mode” (refer to the instruction below)

Refer to “TIPS” in “Auto focus (AF)” (P. 47).

■ Simultaneous use of S-AF mode and MF mode

This function allows you to fine-adjust focus manually by turning the focus ring after AF is performed in the S-AF mode.

1 In the menu, select \uparrow 1 → S-AF+MF → ON.

☞ “How to use the menus” (P. 38)

2 Press the shutter button halfway to use AF.

- When the focus is locked, the AF confirmation mark lights.

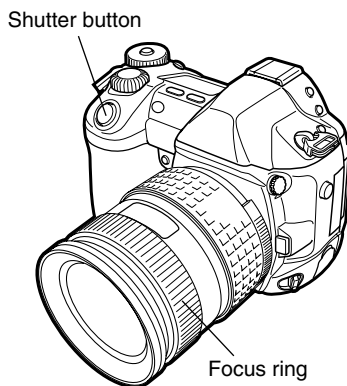
3 Fine-adjust the focus using the focus ring, while keeping the shutter button pressed halfway.**4 Press the shutter button all the way to take the picture.**

Viewfinder

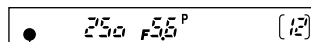

AF confirmation mark

Control panel

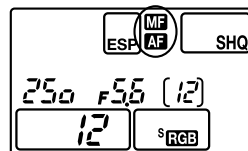
**Note**

- If the shutter button is pressed again after fine-adjusting focus with the focus ring, the AF is activated and your adjustments are canceled.

C-AF (continuous AF) shooting

The camera repeats focusing. When the subject is in motion, the camera focuses on the subject in anticipation of its movement (Predictive AF). Even if the subject moves or you change the composition of the picture, the camera continues trying to focus.

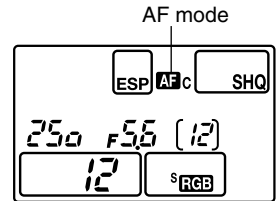

Control panel

1 Press the shutter button halfway and keep it in this position.

- When the subject is in focus and exposure is locked, the AF confirmation mark lights in the viewfinder.
- The shutter speed and aperture value are displayed on the control panel.
- The camera repeats focusing. Even if the subject moves or even if you change the composition of the picture, focusing is tried continuously.
- A beep sound is output when the subject is in focus. The beep sound is not output after the third continuous AF operation, even when the subject is in focus.

Shutter button

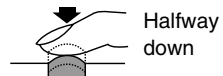

Halfway down

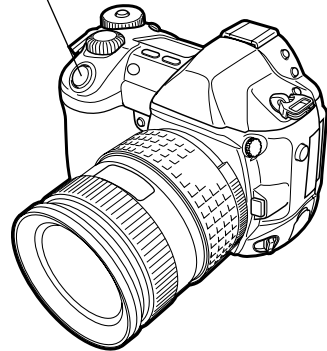

Viewfinder

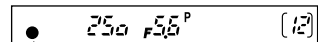

AF confirmation mark

2 Press the shutter button all the way.

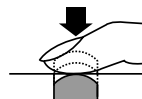

All the way down

RELEASE PRIORITY S & RELEASE PRIORITY C

You can release the shutter button and take a picture without waiting until focusing and flash charge are finished. This function is useful when you need to take advantage of a shutter release opportunity. This function can be set in the S-AF mode and C-AF mode. When RELEASE PRIORITY C is set to ON, Predictive AF is not available.

1 S-AF mode:

In the menu, select \uparrow 1 →
RELEASE PRIORITY S → ON.

C-AF mode:

In the menu, select \uparrow 1 →
RELEASE PRIORITY C → ON.

 "How to use the menus" (P. 38)

Shutter button

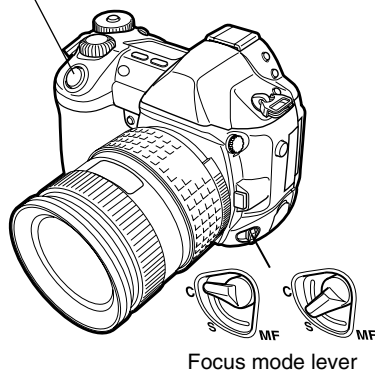

4

Focus

2 Press the shutter button all the way.

- Even when AF is not performed, the shutter is released.

Manual focus (MF)

This function allows you to manually focus on any subject while looking through the viewfinder.

1 Set the focus mode lever to MF.

2 Adjust the focus using the focus ring.

3 Take a picture.

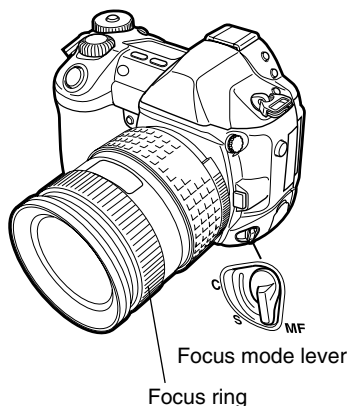

Rotational direction of the focus ring

You can select the rotational direction of the focus ring to suit your preference for how the lens adjusts to the focusing point.  "FOCUS RING" (P. 127)



Focus aid

When you focus the lens on a subject manually (by turning the focus ring), the AF confirmation mark lights.

When 3 AF frames are selected, the camera performs focusing in the center AF frame.

AF ILLUMINATOR

When AF ILLUMINATOR is set to ON, the AF illuminator provides light automatically if a subject is in a dark environment.

- In the menu, select  → **AF ILLUMINATOR** → **ON** or **OFF**.
 "How to use the menus" (P. 38)

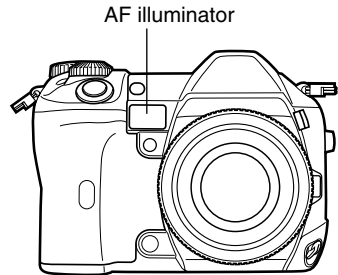

5 Exposure

Exposure mode

This camera has different exposure modes, which can be switched using the mode dial. Rotate the mode dial while holding down the mode dial lock to change the setting.

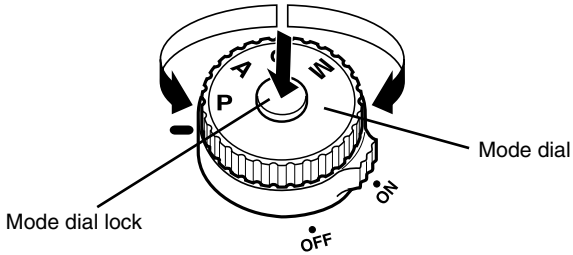

5

Exposure

A Aperture priority shooting (P. 59)

S Shutter priority shooting (P. 61)

P Program shooting (P. 57)

M Manual shooting (P. 63)

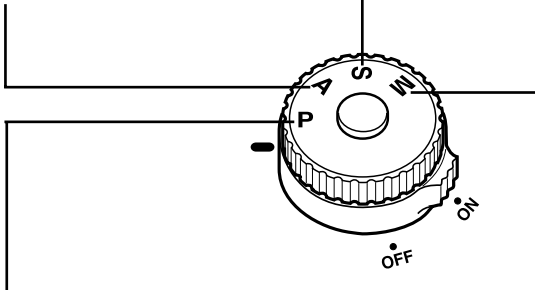

P : Program shooting

The camera sets the optimum aperture value and shutter speed automatically according to the subject brightness.

You can also perform program shift as needed to change the combination of aperture and shutter speed while keeping the correct EV (exposure value).

- 1 While holding down the mode dial lock, set the mode dial to **P**.

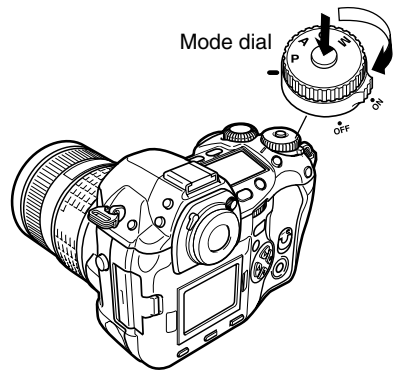

- 2 Press the shutter button halfway.

- Focusing is performed and the AF confirmation mark lights on the viewfinder.
- The shutter speed and aperture value that have been set automatically by the camera are displayed on the control panel and viewfinder.

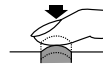

Halfway down

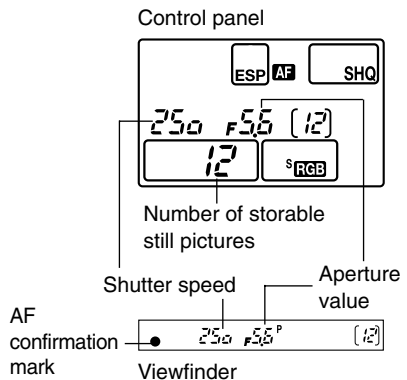

- 3 Press the shutter button all the way.

- A picture is taken.

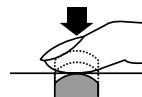

All the way down

Number of storable still pictures

The maximum number of storable still pictures that can be displayed on the control panel is "1999". If the number of storable pictures exceeds 1999, 1999 is displayed.

Aperture values and shutter speeds in the P (Program) mode

In the P (Program) mode, the camera is programmed so that the aperture value and shutter speed are selected automatically according to the subject brightness as shown below. The below diagram depends on the lens.

ED 50mm F2 MACRO

Example: When EV is 7, the aperture value is set to F2 and the shutter speed to 1/30.

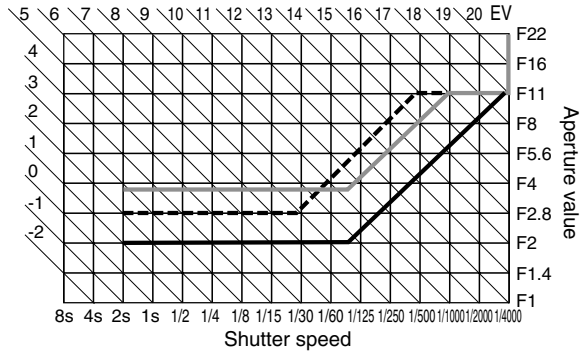

- : When using the fixed focal lens (ED 50mm F2 MACRO)
- - -** : Maximum wide setting when using the zoom lens (14mm-54mm F2.8-F3.5)
- : Maximum tele setting when using the zoom lens (14mm-54mm F2.8-F3.5)

Program shift (Ps)

By rotating the main dial or sub dial in the P mode, you can change the combination of aperture and shutter speed while keeping the optimum exposure.

The program shift setting will not be canceled after shooting. To cancel program shift setting, rotate the main dial or sub dial so that the viewfinder indication Ps changes to P or turn off the power. Program shift is not available when you are using a flash.

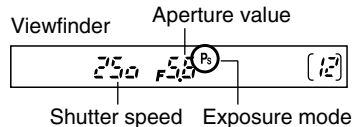

A : Aperture priority shooting

The camera sets the optimum shutter speed automatically for the aperture value you have selected. When you decrease the aperture value (F-number), the camera will focus within a shorter range (shallow depth of field) and produce a picture with a blurred background. Conversely, when you increase the aperture value, the camera will focus over a wider range in the forward and backward directions (more depth of field), producing a picture with clear focus throughout the image area. Before shooting, you can use the preview function to check how the background will look in your picture.



Aperture value (F-number) is decreased



Aperture value (F-number) is increased

- 1 While holding down the mode dial lock, set the mode dial to **A**.

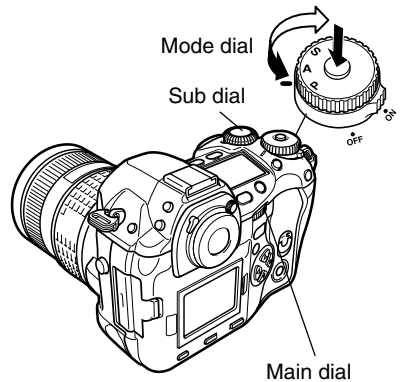

- 2 Rotate the main dial or sub dial to set the aperture value.

Large aperture (F-number is decreased)

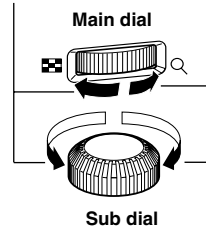

Small aperture (F-number is increased)

3 Press the shutter button halfway.

- Focusing is performed and the AF confirmation mark lights on the viewfinder.
- The shutter speed that has been set automatically by the camera is displayed on the control panel and viewfinder.

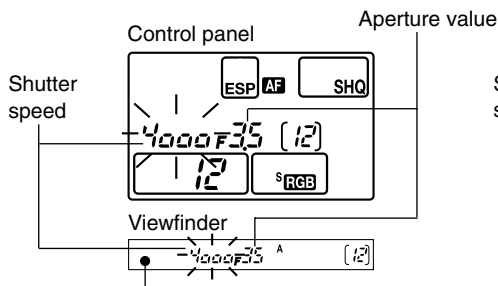
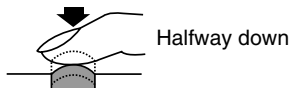

AF confirmation mark

Overexposed when the shutter speed indication is blinking. Increase the aperture value (F-number).

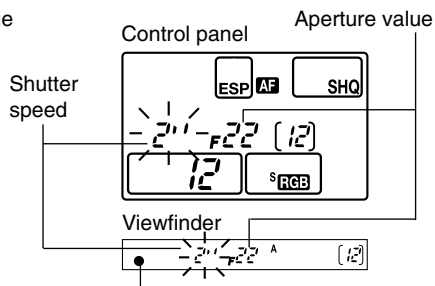

AF confirmation mark

Underexposed when the shutter speed indication is blinking. Decrease the aperture value (F-number).

5

Exposure

4 Press the shutter button all the way.

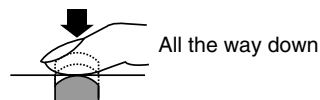

TIPS

The shutter speed indication does not stop blinking after the aperture value is changed.

- If a fast shutter speed is blinking, set the ISO sensitivity to a lower value or use an ND filter (for adjusting the amount of light). [☞](#) "ISO sensitivity" (P. 83)
- If a slow shutter speed is blinking, set the ISO sensitivity to a higher value. [☞](#) "ISO sensitivity" (P. 83)

To change the EV step interval:

- In the menu, set the EV step interval to 1/3EV, 1/2EV or 1EV. [☞](#) "EV STEP" (P. 125)

To check the depth of field with the selected aperture value:

- Press the preview button to check the actual depth of field for the picture in the viewfinder. [☞](#) "Preview function" (P. 65)

S : Shutter priority shooting

The camera sets the optimum aperture value automatically for the shutter speed you have selected. Set the shutter speed depending on the type of effect you want: a higher speed shutter allows you to capture a fast-moving subject without blur, and a slower shutter speed blurs a moving subject, creating a feeling of speed or motion.



A fast shutter speed can freeze a fast action scene without any blur.



A slow shutter speed blurs a moving subject, generating a sense of movement to create a more powerful visual impact.

- 1 While holding down the mode dial lock, set the mode dial to **S**.

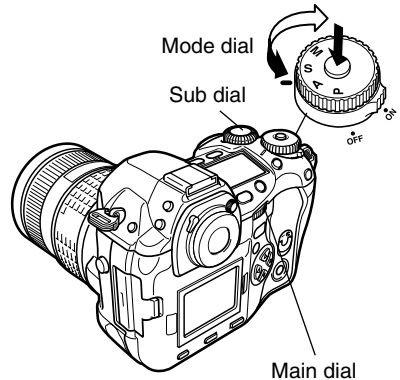

- 2 Rotate the main dial or sub dial to set the shutter speed.

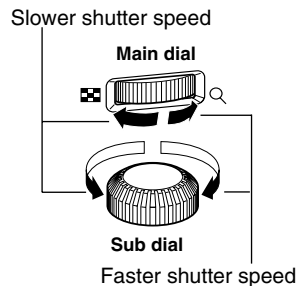

3 Press the shutter button halfway.

- Focusing is performed and the AF confirmation mark lights on the viewfinder.
- The aperture value that has been set automatically by the camera is displayed on the control panel and viewfinder.

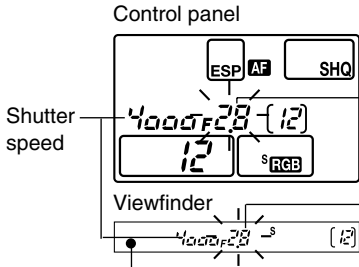
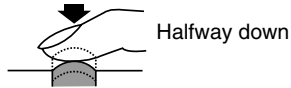

AF confirmation mark

If the aperture value indication at the minimum value is blinking, the correct exposure is not attained (underexposed). Set the shutter speed slower.

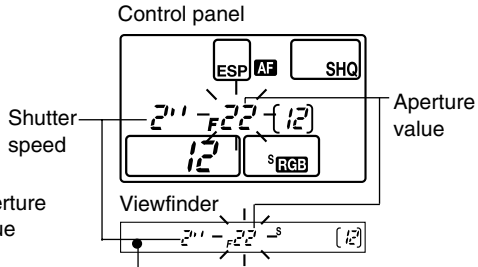

AF confirmation mark

If the aperture value indication at the maximum value is blinking, the correct exposure is not attained (overexposed). Set the shutter speed higher.

5

Exposure

4 Press the shutter button all the way.

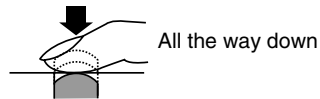

Shutter speed indication

If the selected shutter speed is less than 1 second, only its denominator will be displayed such as 200 for 1/200 sec., and if more than 1 second, a double-quote mark " will be displayed such as 2" for 2 sec.

TIPS

The picture looks blurred.

- The possibility of camera shake spoiling your picture increases greatly during macro or ultra-telephoto shooting. Set the shutter speed higher or use a monopod or tripod to stabilize the camera.

The aperture value indication does not stop blinking after the shutter speed is changed.

- If the aperture value indication at the maximum value is blinking, set the ISO sensitivity to a lower value or use an ND filter (for adjusting the amount of light). ☞ "ISO sensitivity" (P. 83)
- If the aperture value indication at the minimum value is blinking, set the ISO sensitivity to a higher value. ☞ "ISO sensitivity" (P. 83)

To change the EV step interval:

- In the menu, set the EV step interval to 1/3EV, 1/2EV or 1EV. ☞ "EV STEP" (P. 125)

M : Manual shooting

You can set both aperture value and shutter speed manually, while referring to the exposure level indicator. This mode gives you more creative control, allowing you to make whatever settings you like, regardless of the correct exposure. Bulb shooting is also possible, allowing you to take astronomical or fireworks pictures.

- 1 While holding down the mode dial lock, set the mode dial to **M**.

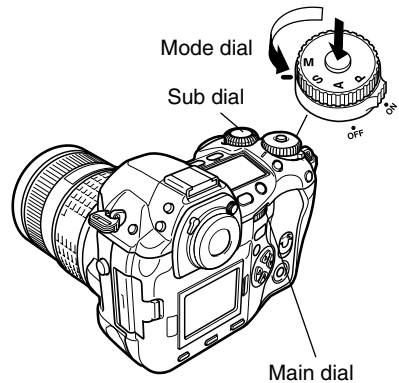

- 2 Rotate the main dial to set the aperture value, and the sub dial to set the shutter speed (60 sec. - 1/4000 sec.).

- The aperture value and shutter speed change in 1/3 EV increments as the dial is rotated.
- The exposure level indicator appears on the control panel and viewfinder, showing the difference (ranging from -2 EV to +2 EV) between the exposure value calculated by the currently selected aperture and shutter speed compared to the exposure value considered optimum by the camera.

Decrease the aperture value (F-number)



Increase the aperture value (F-number)

Slow shutter speed

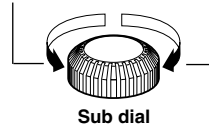

Fast shutter speed

Control panel

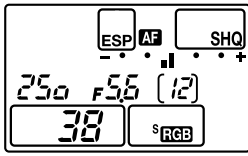

Viewfinder

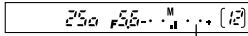

Exposure level indicator

Control panel

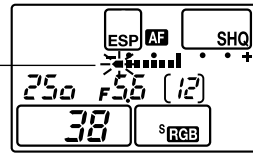

Viewfinder

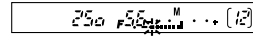

If the difference between the currently set exposure and the optimum exposure is outside the range of available indicator levels, “◀” or “▶” will blink on the left or right end of the exposure level indicator.

- • • ■ • • + Underexposure
- • • ■ • • + Overexposure
- • • ■ • • + Optimum exposure

3 Take a picture.

5

Exposure

Noise in images

During shooting at slow shutter speeds of 30 or more seconds, noise may appear on-screen or the image may be overly bright in the top left part of the screen. These phenomena are caused when current is generated in those sections of the CCD that are not normally exposed to light, resulting in a rise in temperature in the CCD or CCD drive circuit. This can also occur when shooting with a high ISO setting in an environment exposed to heat. The NOISE REDUCTION function helps reduce this noise.

☞ “NOISE REDUCTION” (P. 95)

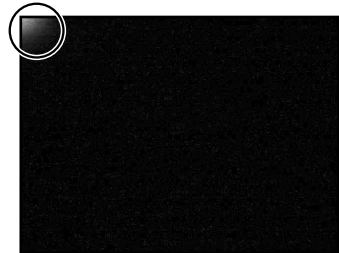

Bulb shooting

You can take a picture with a bulb exposure time in which the shutter stays open as long as you hold down the shutter button (up to 8 minutes). Set the shutter speed to [bulb] in the M mode. Bulb shooting is also possible by using the optional remote cable equipped with a lock function.

TIPS

The picture looks blurred.

- The possibility of camera shake spoiling your picture increases greatly when you take a picture at slow shutter speed. Use a monopod or tripod to stabilize the camera.

To change the EV step interval:

- In the menu, set the EV step interval to 1/3EV, 1/2EV or 1EV. ☞ “EV STEP” (P. 125)

Preview function

When you press the preview button, the viewfinder shows the actual depth of field (the distance from the nearest to the furthest point of perceived “sharp” focus) in a picture, with the selected aperture value.

Note

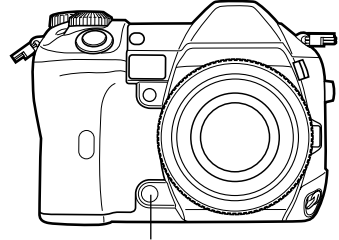

- The metering values cannot be changed in the preview mode.



Preview button

Exposure compensation



In some situations, you may get better results if you manually compensate (adjust) the exposure value set automatically by the camera. In many cases, bright subjects (such as snow) will turn out darker than their natural colors. Adjusting toward + makes these subjects closer to their real shades. For the same reason, adjust toward – when shooting dark subjects. The exposure can be adjusted in range of ± 5.0 EV. Center weighted averaging metering () or spot metering () is recommended for exposure compensation. The EV step interval can be selected from 1/3EV, 1/2EV or 1EV.  “EV STEP” (P. 125)



-2.0 EV





±0

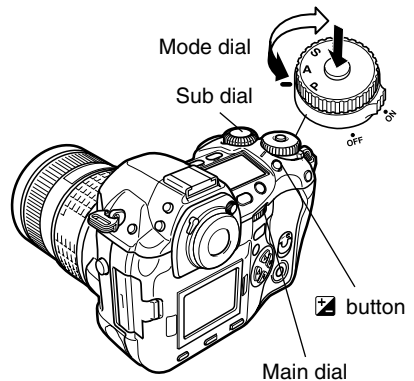

+2.0 EV

- 1 While holding down the mode dial lock, set the mode dial to **P**, **A** or **S**.



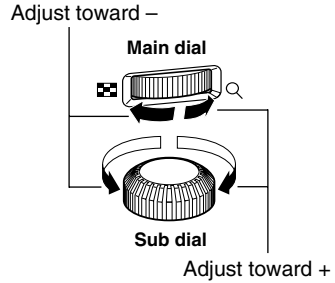

2 While holding down the  (exposure compensation) button, rotate the main dial or sub dial.

- Adjust toward +: up to +5.0 EV
Adjust toward -: up to -5.0 EV
- The exposure compensation indicator appears on the control panel and viewfinder.



Example: When adjusting the exposure in -1/3 step

Press the  button.
Rotate the main dial or sub dial while holding down .

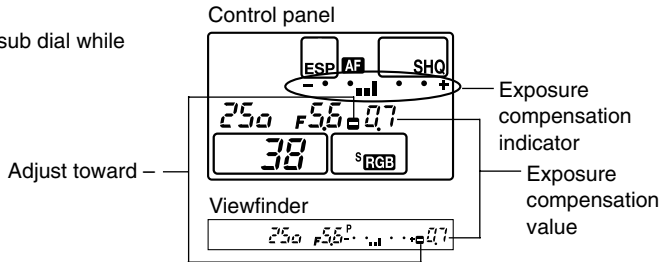

When you finish setting, release .
The exposure compensation indicator disappears if the exposure is compensated by 0.

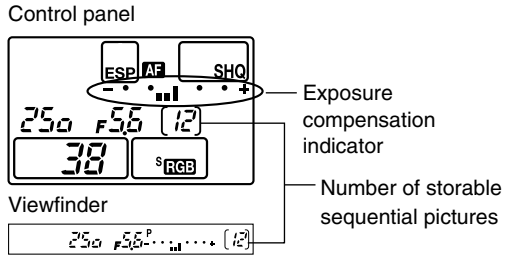

How to adjust the exposure with the dial only

You can assign exposure compensation to the main dial or sub dial by setting DIAL in the $\uparrow 1$ menu. This makes it possible to adjust exposure simply by rotating the assigned dial, without having to press down \square .

TIPS**To change the EV step interval:**

→ In the menu, set the EV step interval to 1/3EV, 1/2EV or 1EV. \leftarrow “EV STEP” (P. 125)

Exposure compensation indicator with “1/3EV” selected

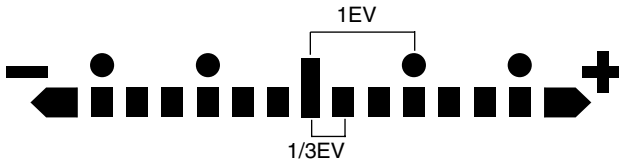

Exposure compensation indicator with “1/2EV” or “1EV” selected

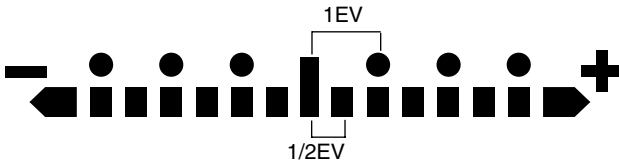
**Note**

- Pressing the \square button has no effect in the M mode.

There are 3 ways of measuring the subject brightness: Digital ESP metering, Center weighted averaging metering and spot metering. Select the most suitable mode depending on the shooting condition.

- While holding down the (metering) button, rotate the main dial or sub dial to select the metering mode you want to use.

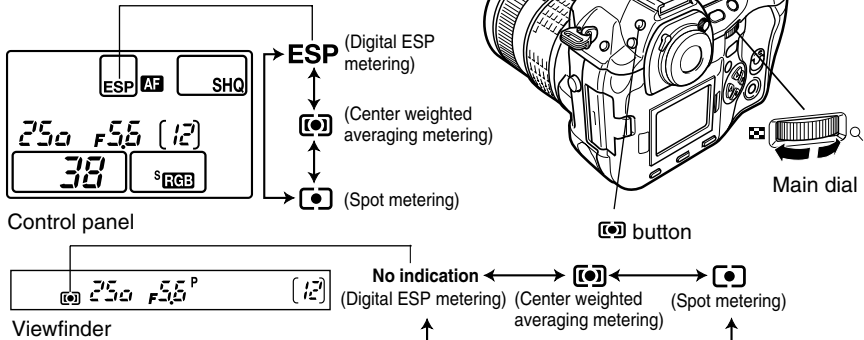

■ Digital ESP metering

The camera meters and calculates the light levels or light level differences in the center and other areas of the image separately. Recommended for shooting under conditions where there is high contrast between the center of the screen and the area around it, such as when shooting backlit subjects or under excessively bright light.

■ Center weighted averaging metering

This metering mode provides the average metering between the subject and the background lighting, placing more weight on the subject at the center. Use this mode when you do not want the light level of background to affect the exposure value.

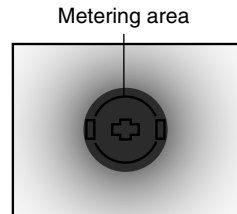

■ Spot metering

The camera meters a very small area around the center of the subject, defined by the spot metering area mark in the viewfinder. Use this mode for intensively backlit subjects, etc.

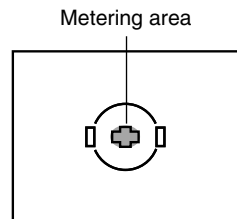

The metered exposure value can be locked with the **AEL** button (AE lock). Use AE lock when you want a different exposure setting from the one that would normally apply under the current shooting conditions.

Normally, pressing the shutter button halfway locks both AF (auto focus) and AE (automatic exposure), but you can lock the exposure alone by pressing **AEL**. The AE and AF lock functions can be customized on this camera. "AEL/AFL" (P. 122)

1 While holding down the mode dial lock, set the mode dial to **P**, **A** or **S**.

2 Aim the camera toward the subject.

3 Hold down **AEL**.

- The exposure is locked.
- **AEL** is displayed in the viewfinder.

Viewfinder

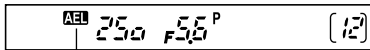

AE lock

4 Compose your shot. While holding down **AEL**, hold down the shutter button halfway.

- The focus is locked.

5 Press the shutter button all the way.

- Releasing **AEL** cancels AE lock.

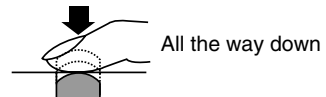
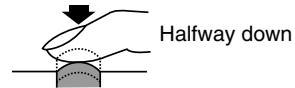
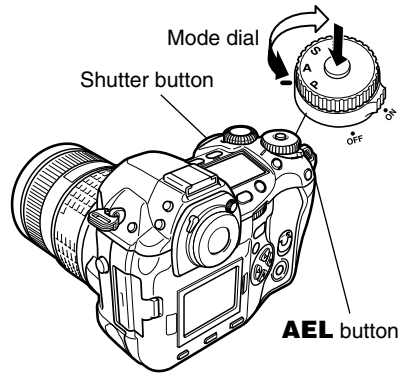

This feature allows you to take a number of pictures of the same scene at different exposures (☞ “AE bracketing” below) or white balance (☞ “WB bracketing”, P.72). Useful when you are not sure what exposure or white balance settings are appropriate and you don’t have time to take several test shots at different settings.

AE bracketing

The camera automatically shoots a number of pictures at different exposure values for each frame. Even in conditions where correct exposure is difficult to obtain (such as a backlit subject or a scene at dusk), you can pick the picture you prefer from a selected number of frames with a variety of different exposure settings (exposure and compensation values). The pictures are taken in the following order: Picture with optimum exposure, picture adjusted in – direction, and picture adjusted in + direction.

Example: When BKT is set to 3F 1.0



-1.0



±0



+1.0

5

Exposure

Compensation value : 0.3, 0.7 or 1.0

The exposure compensation values depend on the EV step interval setting that can be changed in the menu. ☞ “EV STEP” (P. 125)

Number of frames : 3 or 5

- While holding down the **BKT** (auto bracket) button, rotate the main dial or sub dial until the control panel shows the desired mode.

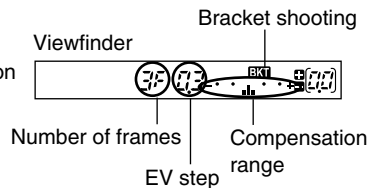
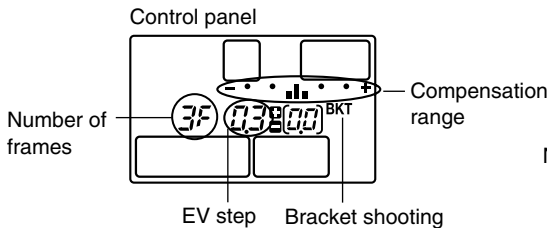
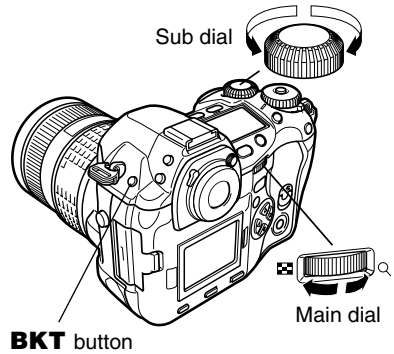

2 Single-frame shooting :
 Each time the shutter button is pressed fully, a picture is taken at a different exposure.

Sequential shooting :
 Hold down the shutter button until the selected number of frames are taken. The camera shoots each frame at a different exposure.

- BKT blinks on the control panel and viewfinder during auto bracketing.
- The exposure level indicator shows the exposure compensation value applied to the next frame.
- Releasing the shutter button stops auto bracketing shooting.

All the way down

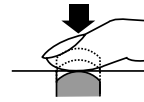

During auto bracketing

Control panel

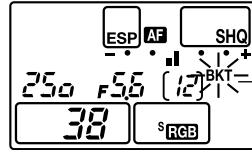

Blinking

Viewfinder

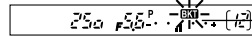

How AE bracketing compensates exposure in each exposure mode

Depending on the selected exposure mode, exposure is compensated in the following way:

- P mode** : Aperture value and shutter speed
- A mode** : Shutter speed
- S mode** : Aperture value
- M mode** : Shutter speed

TIPS

To apply AE bracketing to the exposure value you have compensated:

→ Compensate the exposure value, then use the AE bracketing feature. AE bracketing is applied to the exposure value you have compensated.

If the selected range is beyond the scale of the exposure level indicator, only the part within the scale is displayed.

Auto bracketing compensation range



Exposure compensation value you have adjusted



Exposure compensation value you have adjusted

Auto bracketing compensation range

When set to exposure compensation +1

Control panel

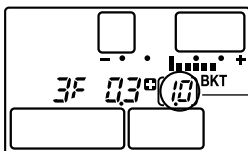

Viewfinder

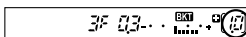

Auto bracketing compensation value applied to exposure value you had compensated

To cancel image recording on the card:

☞ "REC. CANCEL" (P. 77)

Note

- Auto bracketing is not possible in the following cases:
 - When the flash is on.
- During WB bracketing, the camera cannot shoot in sequence if there is not enough memory in the camera and card for storing more than the selected number of frames.
- During sequential shooting, if the battery check blinks due to low battery, the camera stops shooting and starts saving the pictures you have taken on the card. The camera may not save all of the pictures depending on how much battery power remains.

WB bracketing **BKT WB**

Three images with different white balances are automatically created from one shot. One is the image just taken with the specified white balance, one is the same image adjusted in the red direction, and the third the same image adjusted in the blue direction. All three images are saved on the card.

5

Exposure

1 In the menu, select → **WB BKT** → **OFF, 3F 2STEP, 3F 4STEP or 3F 6STEP.**
 “How to use the menus” (P. 38)

2 Take a picture.

- When the shutter button is pressed down all the way, three images are automatically created.

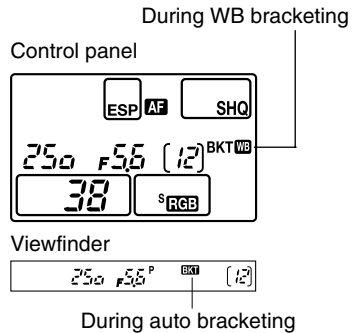
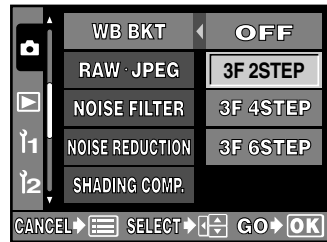





TIPS

To apply WB bracketing to white balance you have adjusted:

- Adjust white balance manually, then use the WB bracketing feature. WB bracketing is applied to your white balance adjustment.

The following drive modes are available with this camera.

- Single-frame shooting (no indication)** : Shoots 1 frame at a time when the shutter button is pressed. (Normal shooting mode, single-frame shooting)
- Sequential shooting**  : Shoots 12 frames at 3 frames/sec. for as long as the shutter button pressed. Focus and exposure are locked at the first frame.
- Self-timer shooting**  : Triggers the shutter after a set time, either 12 sec. or 2 sec.  “Self-timer shooting” (P. 74)
- Remote control shooting**  : Shoots using the optional remote control.  “Remote control shooting (with optional remote control)” (P. 75)

Sequential shooting

- 1** While holding down the **DRIVE** button, rotate the main dial or sub dial so that  appears on the control panel.

Control panel

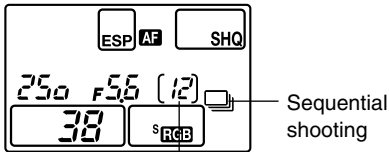

Number of storable sequential pictures

Viewfinder

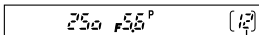

Number of storable sequential pictures

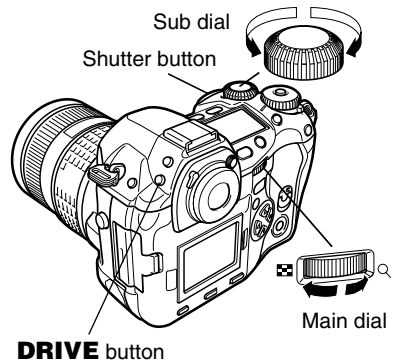

2 Start shooting.

- Press the shutter button fully and keep it pressed. The camera will take pictures in sequence until you release the button.
- If the number of storable sequential pictures reaches 0, you cannot take any more shots.

TIPS

To cancel image recording on the card:



-  “REC. CANCEL” (P. 77)

Note

- Sequential shooting is not possible in the following case:
When NOISE REDUCTION is set to ON.
- During sequential shooting, if the battery check blinks due to low battery, the camera stops shooting and starts saving the pictures you have taken on the card. The camera may not save all of the pictures depending on how much battery power remains.

Self-timer shooting 

This function lets you take pictures using the self-timer. You can set the camera to trigger the shutter after either 12 or 2 seconds. Fix the camera securely on a tripod for self-timer shooting.

- 1** While holding down the **DRIVE** button, rotate the main dial or sub dial so that  or  appears on the control panel.

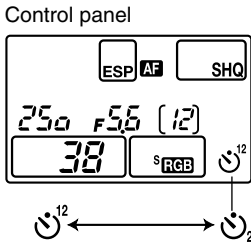

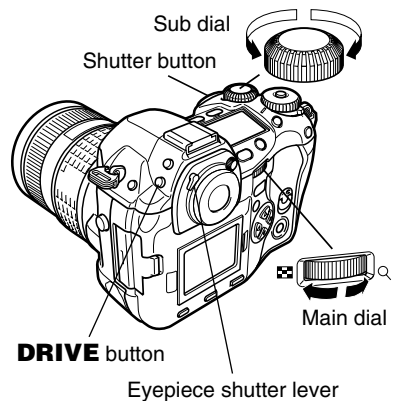

(12-second self-timer) (2-second self-timer)

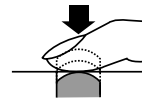

All the way down



- 2** Press the shutter button all the way.

- A picture is taken.
- The focus and exposure are locked when the shutter button is pressed halfway.
- When  is selected: First, the self-timer lamp lights up for approximately 10 seconds, then it blinks for approximately 2 seconds and the picture is taken.
When  is selected: The self-timer lamp lights up for approximately 2 seconds, then the picture is taken.
- To cancel the activated self-timer, press **DRIVE**.

- 3** To exit the self-timer mode, press **DRIVE** while rotating the main dial or sub dial.

Eyepiece shutter

When using the self-timer, close the eyepiece shutter to prevent light passing through the viewfinder. To close the shutter, turn the eyepiece shutter lever in the direction of the arrow.





Eyepiece shutter lever

Note

- Do not press the shutter button while standing in front of the camera; this could result in the subject being out of focus since focusing is performed when the shutter button is pressed halfway.

Remote control shooting (with optional remote control)

By using the optional remote control (RM-1), you can take a picture with yourself in it or a night scene without touching the camera. The camera can be set to trigger the shutter either right away or 2 seconds after the shutter button on the remote control is pressed.

- Mount the camera on a tripod or place it on a stable, flat surface.
- While holding down the **DRIVE** button, rotate the main dial or sub dial so that  or  appears on the control panel.

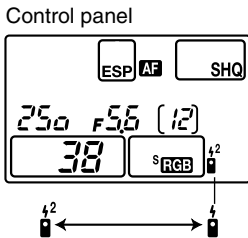

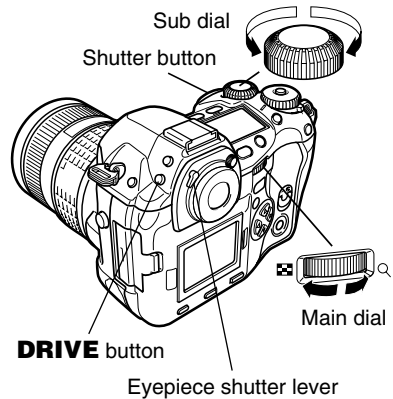

(2-second remote control timer)

- Compose your shot, then turn the eyepiece shutter lever in the direction of the arrow to close the eyepiece shutter.



4 Point the remote control at the remote control receiver on the camera and press the shutter button on the remote control.

- When  is selected: The focus and exposure are locked, the remote control lamp lights up and the picture is taken.
- When  is selected: The focus and exposure are locked, the remote control lamp lights up and the picture is taken after approximately 2 seconds.

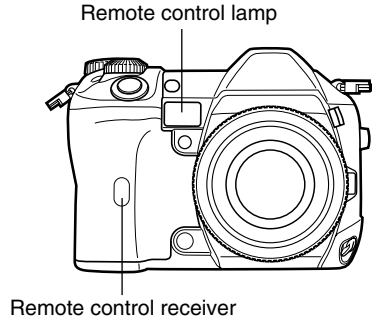

Transmitted signal effective area

Point the remote control at the remote control receiver of the camera within the effective area as shown below.

Powerful lighting such as direct sunlight, fluorescent light or devices emitting electrical or radio waves could narrow the effective area.

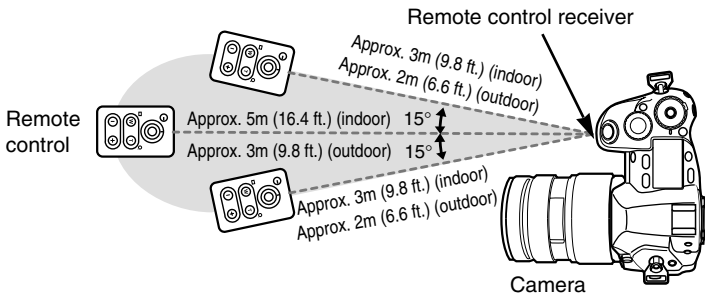



TIPS



The remote control lamp does not blink after the shutter button on the remote control is pressed.

- The transmitted signal may not be effective if the remote control receiver is exposed to powerful lighting. Move the remote control closer to the camera and press the shutter button on the remote control again.
- The transmitted signal may not be effective if the remote control is too far from the camera. Move the remote control closer to the camera and press the shutter button on the remote control again.
- There is signal interference. Change the channel as described in the remote control's instruction manual.

To cancel the remote control shooting mode:

- The remote control shooting mode will not be canceled after shooting. Follow step 2 to select any mode except  and .

To use the shutter button on the camera in the remote control shooting mode:

- The shutter button on the camera still works even if  or  is displayed.

Note

- When using the remote control, set RELEASE PRIORITY S or RELEASE PRIORITY C to OFF.
- The shutter will not be released if the subject is not in focus.
- Under bright light conditions, the remote control lamp may be difficult to see, making it hard to determine whether or not the picture has been taken.
- Zoom is not available on the remote control.

REC. CANCEL

This allows you to cancel image recording on the card. If you do not want to keep the sequential shots you have taken, you can cancel them as long as they are in the camera's memory.

- 1 When the camera is recording shots you have taken, press the  (erase) button.**

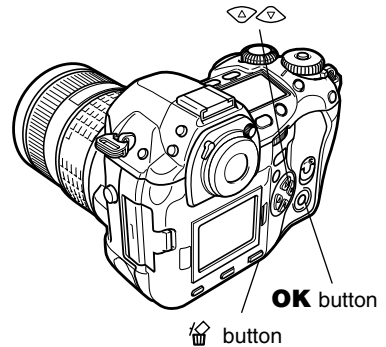

- 2 Press  to select the mode.**

- **REC. CANCEL:** Cancels recording of the last picture taken.
REC. CANCEL ALL: Cancels recording of all the shots stored in the camera's memory.
- The YES/NO selection screen is displayed, giving you the choice of performing or canceling the selected function.



3 Press   to select YES.



4 Press the **OK** button.

- A bar is displayed showing canceling progress.

Note

- Even if YES is selected for REC. CANCEL ALL, images that are currently being recorded cannot be erased.

5

Exposure



ANTI-SHOCK

This diminishes camera shake caused by vibrations when the mirror moves. You can select the interval from the time the mirror is raised until the shutter is released.

1 In the menu, select  → ANTI-SHOCK.

Press .

 “How to use the menus” (P. 38)

2 Press   to select the time from 1 - 30 seconds. Press the **OK** button.

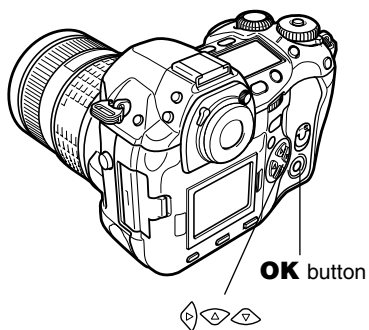

6 Image, image quality and color

Record mode

You can select a record mode in which to take pictures. Choose the record mode that's best for your purpose (printing, editing on a PC, website editing, etc.). For details about record modes and number of pixels, refer to the table on the next page. The numbers in the table are approximate.

Record mode	Description
RAW	Image files recorded in the orf format (orf file extension). This is raw data, i.e. data to which image processing functions such as white balance and contrast have not been applied. RAW pictures can be edited with the RAW DATA EDIT function and saved using one of the record modes below (P. 82). RAW pictures can also be edited on a PC with the provided software. They cannot be open with other graphics software applications or printed.

Application	Quality (Compression)	Non-compression 1/1	High quality 1/2.7	Standard quality 1/8
	Number of pixels			
Select for the print size	2560 x 1920	TIFF	SHQ	HQ
	1600 x 1200	—	SQ	SQ
	1280 x 960			
For small-sized print and website	1024 x 768			
	640 x 480			

← Image becomes clearer

Number of pixels increases (Number of storable pictures decreases)

Number of pixels

The number of pixels (horizontal x vertical) used when saving an image. If the image is going to be printed, higher resolutions (larger numbers) are recommended so that the image will be clearer. However, higher resolutions make the file size (amount of data) larger, so the fewer pictures can be saved.

Compression

In record modes other than RAW/TIFF, image data are compressed. The higher the compression, the less clear the image will be.

Number of pixels and picture size on a computer screen

When a picture is transferred to a computer, the size of the picture on the computer screen varies depending on the computer’s monitor setting. For instance, a picture taken in 1024 x 768 resolution is the same size as the screen if you set the picture to 1x when the monitor setting is 1024 x 768. However, if the monitor setting is over 1024 x 768 (such as 1280 x 1024), the picture only takes up part of the screen.

Record mode and the number of storable pictures

The approximate number of pictures that can be stored is determined by dividing the memory capacity of the card by the file size of the pictures. When a card is inserted into the camera, the number of storable pictures is displayed on the control panel. If the number of storable pictures exceeds 1999, 1999 is displayed on the control panel.

Control panel

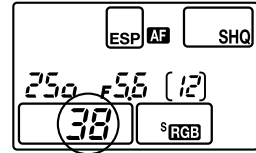

Number of storable still pictures

Number of storable still pictures

The maximum number of storable still pictures displayed that can be displayed on the control panel is “1999”. If the number of storable pictures exceeds 1999, 1999 is displayed.

Record mode

Record mode	Number of pixels (PIXEL COUNT)	Compression	File format	File size (MB)
RAW	2560 x 1920	Uncompressed	ORF	10.2
TIFF	2560 x 1920	Uncompressed	TIFF	14.4
SHQ	2560 x 1920	1/2.7	JPEG	3.8
HQ	2560 x 1920	1/8		1.2
SQ	1600 x 1200	1/2.7		1.4
		1/8		0.5
	1280 x 960	1/2.7		0.9
		1/8		0.3
	1024 x 768	1/2.7		0.6
		1/8		0.2
	640 x 480	1/2.7		0.3
		1/8		0.1

The file size in the table is approximate.

Note

- The number of remaining pictures may change according to the subject or factors like whether print reservations have been made or not. In certain instances, the number of remaining pictures displayed on the control panel or the monitor does not change even when you take pictures or stored images are erased.
- The actual file size varies depending on the subject.

Selecting a record mode

- 1** While pressing the  (record mode) button, rotate the main dial or sub dial until the record mode you want to select is displayed on the control panel.

Record mode

RAW ↔ TIFF ↔ SHQ ↔ HQ ↔ SQ

Control panel

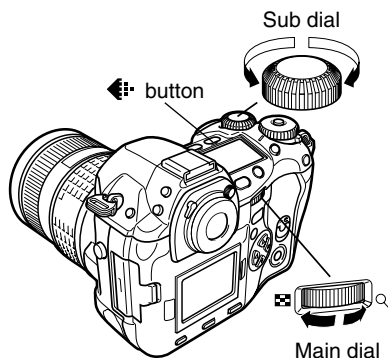
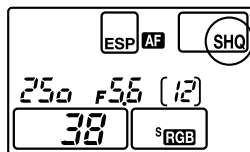

TIPS

To check pictures taken with the RAW data format:

- Pictures taken with the RAW data format are displayed after they have been processed so that they can be checked in the camera's monitor.  "Information display" (P. 109)

Setting the SQ mode



You can select the number of pixels (PIXEL COUNT) and compression in the SQ mode.

Available compression : 1/2.7, 1/8
 Available number of pixels : 1600 x 1200,
 1280 x 960,
 1024 x 768,
 640 x 480

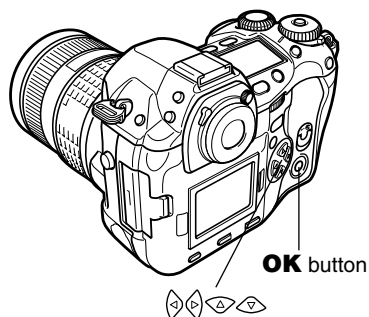

- 1** In the menu, select  → SQ, then press .

- The screen for selecting PIXEL COUNT and COMPRESSION is displayed.
 "How to use the menus" (P. 38)



2 Press   to select **PIXEL COUNT**, then press .

- The highlight moves to the **COMPRESSION** selection item.

3 Press   to select the desired compression. Press the **OK** button.

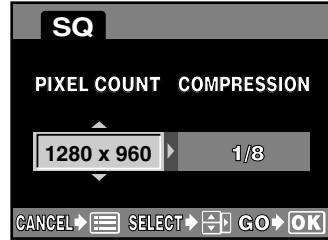

TIPS

After selecting 1/8 compression, the image appears grainy.

- The higher the compression, the less clear the image will be. Select 1/2.7 compression.

RAW record mode (RAW • JPEG)

RAW data can be recorded on a card at the same time as images in the SHQ, HQ and SQ modes.

1 In the menu, select  → **RAW • JPEG** → **ON**.

- [RAW] is displayed on the control panel together with the simultaneous image record mode.

 "How to use the menus" (P. 38)

Control panel

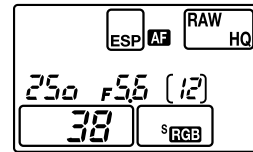

ISO sensitivity

The higher the ISO value, the greater the camera's light sensitivity and the better its ability to shoot in low light conditions. However, higher values may give pictures a grainy appearance.

Setting the ISO sensitivity to ISO BOOST using the menu beforehand allows you to select the high ISO sensitivity (1600 or 3200).  "ISO BOOST" (P. 84)

Auto, 100, 200, 400, 800, 1600, 3200

With a lower ISO setting, you can shoot clear, sharp images in daylight. With a higher ISO setting, you can shoot in darker conditions.

The values can be selected when ISO is set to ISO BOOST in the menu.

Setting the ISO sensitivity

- 1 Press the ISO button.**
 - The current ISO value is displayed on the control panel.
- 2 While pressing ISO, rotate the main dial or sub dial until the ISO value you want to select is displayed on the control panel.**

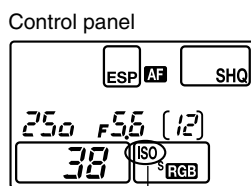
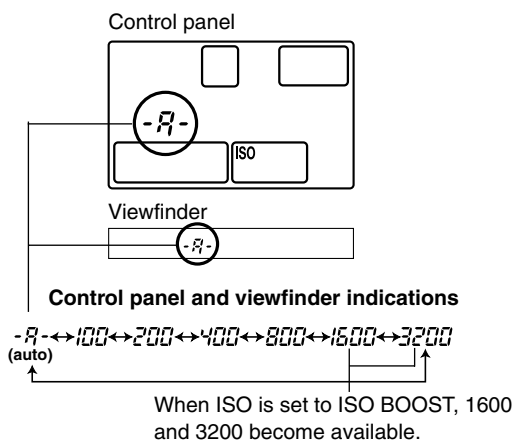
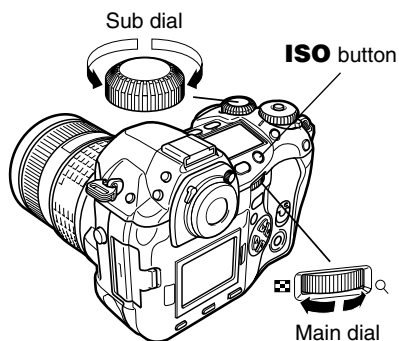

With ISO settings except auto, ISO is displayed on the control panel after the ISO value has been selected.

When the ISO sensitivity is set to 1600 or 3200 (ISO BOOST value), ISO blinks on the control panel.

Note

- The ISO sensitivity when it is set to auto is usually ISO 100. If the subject is too far away for the flash illumination, the sensitivity is automatically increased.

ISO BOOST

This allows you to make ISO 1600 and 3200 available for ISO setting.

- 1 In the menu, select \uparrow → ISO BOOST → ON, then press the **OK** button.
☞ “How to use the menus” (P. 38)

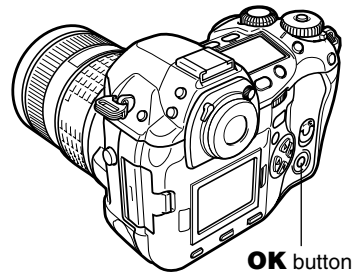

Color reproduction differs depending on the light conditions. For instance, when daylight or tungsten lighting are reflected on white paper, the shade of white produced will be slightly different for each.

With a film camera, you can adjust color balance using different films for different light conditions or by using filters. With a digital camera, on the other hand, white color can be adjusted to reproduce more natural white with a digital processor. This adjusting mechanism is called white balance. There are three options for setting the WB with this camera.

Auto white balance

This function lets the camera automatically determine the amount of white light and adjust the color balance. Auto WB is sufficient for most light conditions. If there is no near white color in the picture, the white balance of the image may not be correct. In such a case, use preset WB or one-touch WB to achieve the correct white balance.

Preset white balance

You can set the white balance by selecting the appropriate color temperature for the light source. For example, use preset WB when you want to reproduce more red in the picture of a sunset, or capture a warmer artistic effect under artificial lighting. You can enjoy creating different color tones by trying the different preset WB settings.

The color temperatures available for preset WB are as follows: 3000, 3300, 3600, 3900, 4000, 4300, 4500, 4800, 5300, 6000, 6600, or 7500.

One-touch white balance "Setting the one-touch white balance" (P. 89)

You can set the optimum white balance for the shooting conditions by pointing the camera at a white object like a sheet of white paper and pressing the  (one-touch WB) button. The white balance achieved with this setting is saved as one of the preset WB settings.

White balance sensor

This camera is equipped with a white balance sensor to detect the light source when pictures are taken. The sensor measures and calculates infrared and visible rays to detect sunlight, fluorescent light, floodlight and blue floodlight. When you take pictures, be careful not to cover or shade the sensor section.

White balance sensor

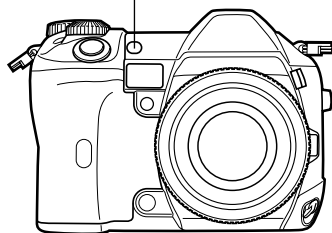

Color temperature

The spectral balance of different white light sources is rated numerically by color temperature—a concept of physics, expressed using the Kelvin (K) temperature scale. The higher the color temperature, the richer the light in bluish tones and the poorer in reddish; the lower the color temperature, the richer the light in reddish tones and the poorer in bluish.

It follows, then, that the color temperatures of fluorescent lights make them unsuitable as artificial light sources. There are gaps in the hues from the color temperatures of fluorescent light. If these differences in hue are small, they can be calculated with color temperature and this is called correlated color temperature.

The 4000K, 4500K and 6600K preset settings in this camera are correlated color temperatures, and should not be considered strictly as color temperatures. Use these settings for shooting conditions under fluorescent lights.

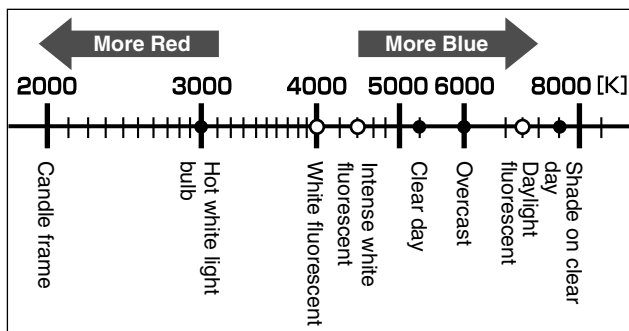

TIPS

White balance with a flash:

→ Auto WB is recommended when taking pictures with the flash. If you intend to use preset WB, select the color temperature 6000K.

When shooting with the flash, be sure to play back your pictures and check the color on the screen. Various conditions affect color temperature and how color is reproduced on the screen.

Note

- The color temperatures for each light source indicated in the above scale are approximate. They are not an accurate indication of color. For example, the actual sunlight is not exactly 5300K, nor fluorescent lights 4000K.

Setting the white balance **WB**

You can adjust the white balance by selecting the appropriate color temperature for the light conditions.

- While pressing the **WB** (white balance) button, rotate the main dial or sub dial until the color temperature you want to select is displayed on the control panel and viewfinder.

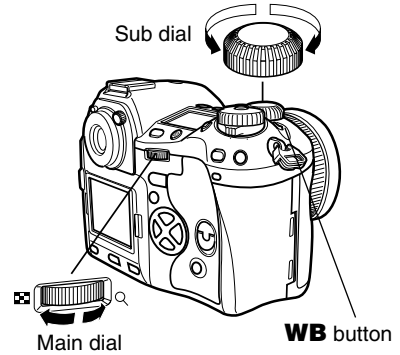

Color temperature. **- -** is displayed when this is set to auto.

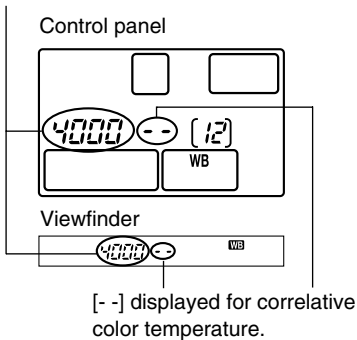

Control panel

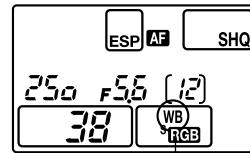

When WB settings except auto are selected, WB is displayed.

Monitor



TIPS

When subjects with no white appear white in the image:

- In the auto WB setting, if there is no near-white color in the image framed in the screen, the white balance will not be correctly determined. In such a case, try preset WB or one-touch WB settings.

Control panel and viewfinder indications

Light conditions

-R- (auto)

Used for most light conditions (when there is a white portion in framed in the viewfinder)

↕
3000

↕
For shooting under a tungsten light

↕
3300

↕
3600

↕
For shooting under incandescent light to preserve the mood of the lighting

↕
3900

↕
4000

↕
For shooting under white fluorescent lighting

↕
4300

↕
4500

↕
For shooting under a neutral white fluorescent lamp

↕
4800

↕
5300

↕
For shooting outdoors on a clear day, or to capture the reds in a sunset or the colors in a fireworks displays

↕
6000

↕
For shooting outdoors on a cloudy day (when using the flash)

↕
6600

↕
For shooting under a daylight fluorescent lamp

↕
7500

↕
For shooting outdoors in the shadows on a clear day

↕
-0- 1 - -0-4

↕
Color temperature set by one-touch WB. When the value has not been set, it is set to 5300K.

☞ "Setting the one-touch white balance" (P. 89)

Setting the one-touch white balance

This function is useful when you need a more precise white balance than preset WB can provide. Point the camera at a white object under the light source you want to use to determine the white balance. The optimum white balance for the current shooting conditions can be saved in the camera. Up to 4 settings can be registered as one-touch WB settings.

This is useful for when shooting a subject under natural light, as well as under various light sources with different color temperatures.

1 Point the camera at a sheet of white paper.

- Position the paper so that it fills the viewfinder. Make sure there are no shadows.

2 Set the aperture and shutter speed to obtain the optimum exposure.

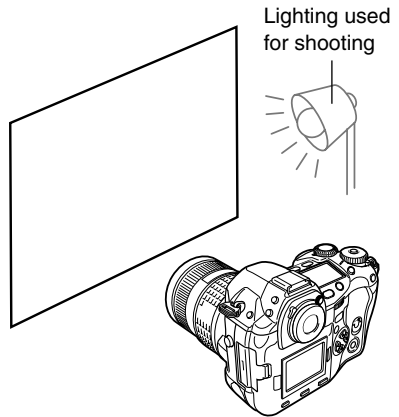

3 Press the (one-touch WB) button.

- The shutter is released, and the WB data is saved.
- Once the appropriate white balance has been determined, the CUSTOM WB screen for registering one-touch WB settings is displayed.

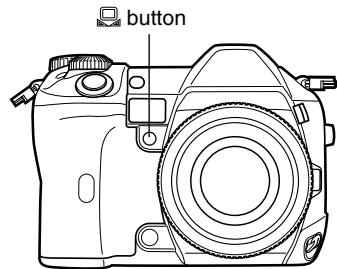

4 Press to select the item number to register the white balance from 1 to 4, then press the **OK** button.

- The white balance is registered.
 - The registered white balance will be stored in the camera as a preset WB setting. Turning the power off does not reset the data.
-  "Setting the white balance" (P. 87)

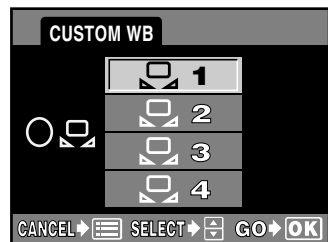



TIPS

After pressing , “WB NG RETRY” is displayed.

→ When there is not enough white in the image, or when the image is too bright, too dark or the colors look unnatural, you cannot register the white balance. Repeat the setting procedure from Step 1.

WB compensation 

This function lets you make fine changes to the auto WB and preset WB settings.

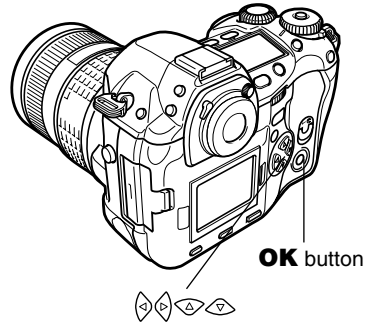

1 In the menu, select  → , then press .

- The screen for selecting the white balance mode in which you want to make WB compensation is displayed.
-  “How to use the menus” (P. 38)





6

Image, image quality and color

2 Press   to select the white balance mode in which you want to make WB compensation, then press .

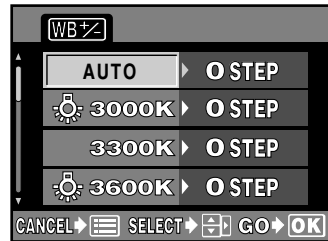
- The setting screen for WB compensation is displayed.



3 The color becomes bluer each time you press , and redder each time you press , depending on the original WB conditions. Press the **OK** button to save the WB compensation value.

- WB compensation can be made in 7 steps in both the RED and BLUE directions.

4 Point the camera at the subject to take test shots.

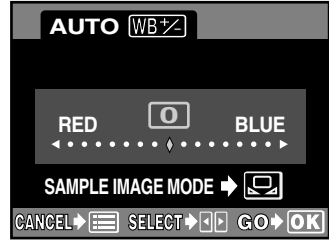

Control panel

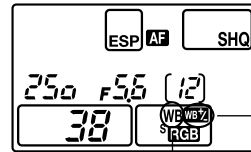

WB is displayed with the WB settings except auto.

WB compensation

5 Press the  (one-touch WB) button.

- Sample images that have been taken with the current WB settings are displayed.
- The WB compensation indicator indicates the current WB compensation value.

6 After checking the sample images, press **OK**.

7 Press **OK** to exit the setting screen for WB compensation.

-  is displayed on the control panel.



This function adjusts the sharpness of the image.

1 In the menu, select → SHARPNESS, and press .

- The setting screen is displayed.
 “How to use the menus” (P. 38)

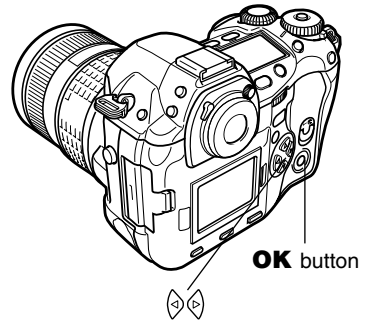

2 Press to move .

To increase the sharpness (Hi):
 Press . The image contours are emphasized, making the image appear sharper and more vivid. Use this setting when you want to print pictures.

To reduce the sharpness (Lo):
 Press . The image contours are softened. Use this setting when you want to edit images on a PC.

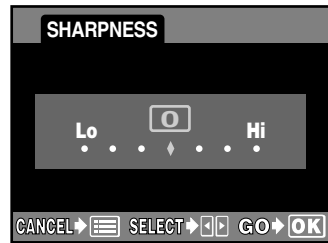

Control panel

3 Press the **OK** button.

- When you have finished adjusting the sharpness, is displayed on the control panel.

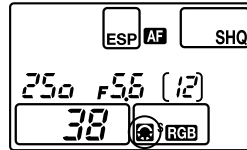

Adjusting image

Note

- Adjusting the sharpness toward Hi may give the picture a grainy appearance.



This function adjusts the contrast (distinction between light and dark) of images. For example, you can make images with marked differences in light and shadow softer, and those with less differences more vivid.

1 In the menu, select → CONTRAST, and press .

- The setting screen is displayed.
 “How to use the menu” (P. 38)

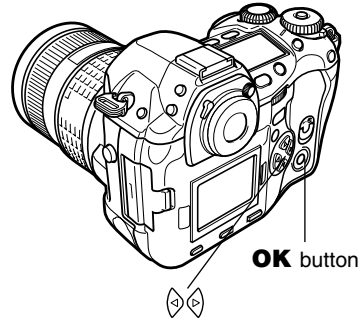

2 Press to move .

To increase the contrast (Hi):
Press . The light and dark areas are defined more clearly, making the image look crisper.

To reduce the contrast (Lo) :
Press . The light and dark areas become less defined, giving the image a softer impression. Use this setting when you want to edit images on a PC.

3 Press the **OK** button.

- When you have finished adjusting the contrast, is displayed on the control panel.

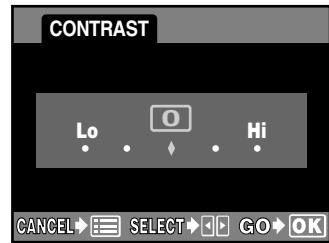

Control panel

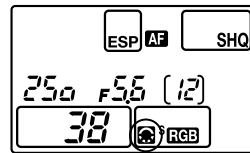

Adjusting image



This function sets the color depth of images. You can select a saturation level from CS0 - CS4 and CM1 - CM4.

CS : Five levels (CS0 - CS4) are available.

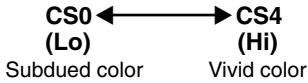

CM1 : Stresses red.

CM2 : Stresses green.

CM3 : Stresses blue.

CM4 : Stresses a softer red than CM1.

1 In the menu, select → **SATURATION**, and press .

- 5 options (CS, CM1, CM2, CM3, CM4) are displayed.

“How to use the menus” (P. 38)

2 Press to select either. When selecting CS: Press .

- The SATURATION LEVEL screen is displayed.

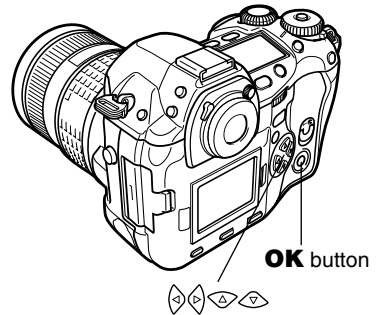

When selecting CM1 - CM4: Go to Step 4.

3 Press to select the saturation level from CS0 - CS4.

4 Press the **OK** button.

- is displayed on the control panel.

Control panel

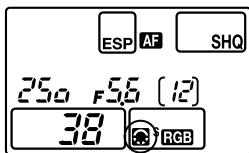

Adjusting image

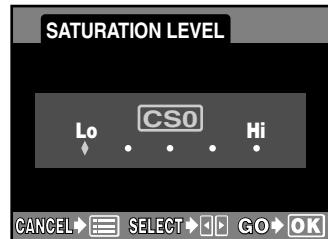
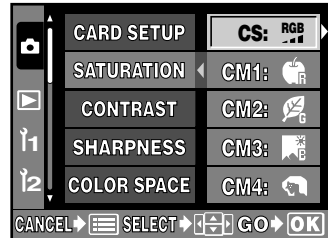



This function eliminates the random noise that may be conspicuous in flat or smooth images such as the sky or a wall. It takes longer to record pictures since the noise-filtering process is activated after each shot.

1 In the menu, select → **NOISE FILTER** → **ON**, and press the **OK** button.

- blinks in the control panel.
- “How to use the menus” (P. 38)

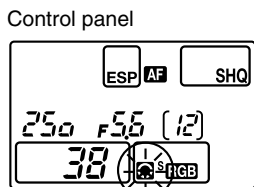
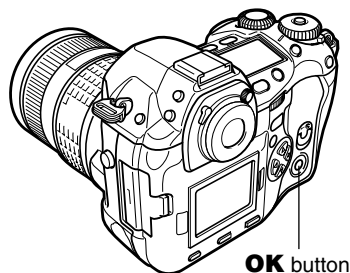

Adjusting image

Note

- This function is not activated when the record mode is set to RAW mode or RAW record mode (RAW • JPEG).

NOISE REDUCTION



This function reduces the noise that is generated during long exposures. When shooting night scenes, shutter speeds are slower and noise tends to appear in images. When **NOISE REDUCTION** is set to **ON**, the camera automatically reduces noise to produce clearer images. However, shooting time is approximately twice as long as usual.

For more information about noise generated in images during long exposures, refer to “Noise in images” (P. 64).



NOISE REDUCTION: OFF



NOISE REDUCTION: ON

- In the menu, select → NOISE REDUCTION → ON, and press the **OK** button.

“How to use the menus” (P. 38)

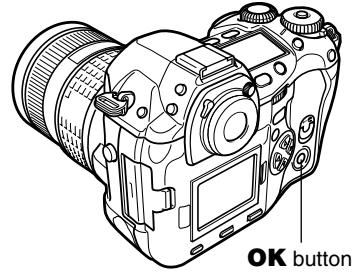

OK button

NOISE REDUCTION mark

When NOISE REDUCTION has been set, the number of storable sequential pictures is set to 1.

Control panel

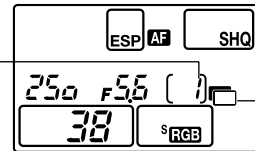

Viewfinder

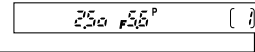

2 Take a picture.

- The noise-reduction process is activated after shooting.
- You cannot take another picture until the noise-reduction process is completed.
- When noise reduction starts, the following indications are displayed on the control panel and viewfinder.
 - The number of storable sequential pictures is indicated as 0.
 - [busy] is displayed.
- The exposure compensation indicator shows each stage of the noise-reduction process.

Control panel

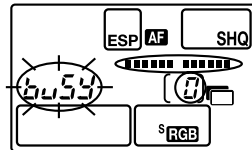

Viewfinder

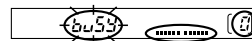

Note

- You cannot take any more pictures until the card access lamp goes out.
- When NOISE REDUCTION is set to ON, sequential shooting is not available.
- This function may not work effectively with some shooting conditions or subjects.



In some cases, the edges of the image may be shadowed due to the properties of the lens. The SHADING compensation function compensates by increasing brightness at the dark edge of the image. Especially when the wide-angle lens is used, this function is able to work effectively.

1 In the menu, select → **SHADING COMP.** → **ON**, and press the **OK** button.

- blinks in the control panel.
- ☞ “How to use the menus” (P. 38)

Control panel

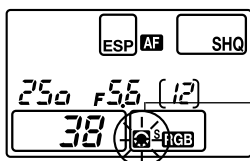

Adjusting image

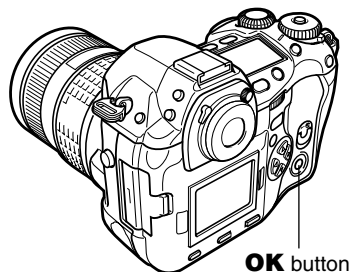

OK button

Note

- This function is not available when a tele converter or inner tube extension is attached to the camera.
- At higher ISO settings, noise in image edges may be conspicuous.
- This function is not activated when the record mode is set to RAW mode or RAW record mode (RAW • JPEG).

COLOR SPACE

This function lets you select how colors are reproduced on the monitor or printer. The first character in image file names indicates the current color space.

☞ “FILE NAME” (P. 128)

Pmdd0000.jpg

└ P : sRGB
└ _ : Adobe RGB

sRGB : Standardized color space for Windows
Adobe RGB : Color space that can be set by Adobe Photoshop

1 In the menu, select → **COLOR SPACE** → **sRGB** or **Adobe RGB**, and press the **OK** button.

☞ “How to use the menus” (P. 38)

Control panel

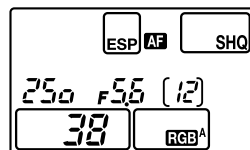

Color space

sRGB: **sRGB**

Adobe RGB: **RGB^A**

7 Flash

Optional electronic flashes

You can take advantage of a variety of flash shooting techniques to suit different shooting conditions with the flash units specified for use with this camera — the Olympus FL-50, FL-40, and FL-20 electronic flashes.

These flashes communicate with the camera to make available various flash modes, such as auto-flash, red-eye reduction flash, slow synchronization, and controlled light emission. The flash can be mounted on the camera by attaching it to the camera's hot shoe. You can also mount the flash on the specified flash bracket using the bracket cable (optional).

Functions available with optional flash units

Optional flash	FL-50	FL-40	FL-20
Flash control mode	TTL-AUTO (Super FP flash), TTL-AUTO, AUTO, MANUAL, MANUAL (Super FP flash)	TTL-AUTO, AUTO, MANUAL	TTL-AUTO, AUTO, MANUAL
GN (guide number) (ISO100)	GN 50 (85 mm*) GN 28 (24 mm*)	GN 40 (80 mm*) GN 26 (28 mm*)	GN 20 (35 mm*)

* Calculated based on 35mm film.

Using the electronic flash

The following instructions describe how to connect and use the FL-50 electronic flash (optional). Be sure to attach the flash to the camera before turning on the flash's power.

1 Remove the hot shoe cover by sliding it in the direction indicated by the arrow in the illustration.

- Keep the shoe cover in a safe place to avoid losing it, and put it back on the camera after flash shooting.

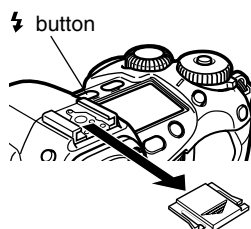

2 Attach the FL-50 electronic flash to the hot shoe on the camera.

- If the lock pin is protruding, turn the shoe lock dial in the direction opposite to ◀ LOCK. This will pull the lock pin back inside.
- For instructions on how to attach the flash, refer to the FL-50's manual.

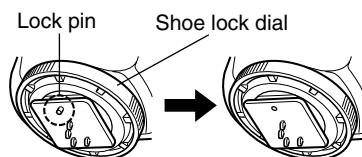

3 Turn on the flash.

- When the charge lamp on the flash lights up, charging is complete.
- The flash will be synchronized with the camera at a speed of 1/180 sec or less.

4 While holding down the ⚡ (flash mode) button, rotate the main dial or sub dial to select the desired flash mode.

☞ “Flash mode” (P. 100)

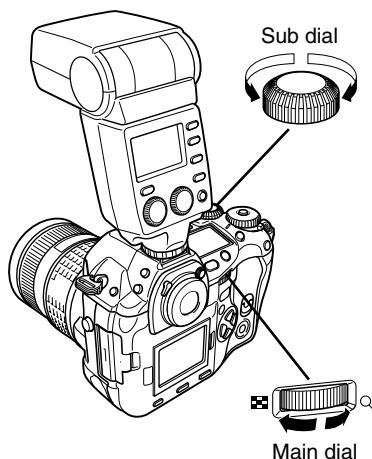

5 Select the desired flash control mode.

6 Press the shutter button on the camera halfway.

- Shooting information such as ISO sensitivity, aperture value, and shutter speed is communicated between the camera and flash.
- ⚡ lights up in the viewfinder.

7 Take a picture.

Viewfinder

⚡ blinks: The flash is charging.

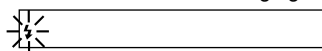

⚡ lights up: Charging is complete.

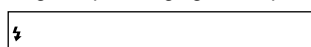

Note

- When shooting with the flash control mode set to TTL-AUTO, pre-flashes are emitted before firing the regular flash.
- When the flash control mode is set to TTL-AUTO, or when shooting a subject at a distance with ISO set to 400 or higher, flash control accuracy will decrease.

Flash mode

The camera sets the flash mode according to various factors such as firing pattern and flash timing. Available flash modes depend on the exposure mode.

You can set the flash mode even when no flash is attached to the camera.

Types of flash modes

■ Auto-flash (no indication)

The flash fires automatically in low light or backlighting conditions.

To shoot a subject with backlighting, position the AF frame over the subject.

When the FP flash mode has been set on the optional electronic flash, the flash fires automatically in backlit conditions.

■ Red-eye reduction flash

The light from the flash may make the subject's eyes appear red in the picture. The red-eye reduction flash mode significantly reduces this phenomenon by emitting pre-flashes before firing the regular flash. This helps accustom the subject's eyes to the bright light and minimizes the red-eye phenomenon.

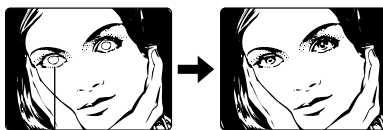

The subject's eyes appear red.

Note

- After the pre-flashes, it takes about 1 second before the shutter is released. Hold the camera firmly to avoid camera movement.
- Effectiveness may be limited if the subject is not looking directly at pre-flashes, or if the shooting range is too far. Individual physical characteristics may also limit effectiveness.

■ Slow synchronization (1st curtain) ⚡ SLOW

The slow synchronization flash is designed for slow shutter speeds. Normally, when shooting with a flash, shutter speeds cannot go below a certain level to prevent camera movement. But when shooting a subject against a night scene, fast shutter speeds can make the background too dark. Slow synchronization allows you to capture both the background and the subject. Since the shutter speed is slow, be sure to stabilize the camera by using a tripod so as not to cause the picture to be blurred.

1st curtain

Usually, regardless of the shutter speed, the flash fires right after the shutter fully opens. This is called 1st curtain. Unless you change it, this is how the flash always fires.

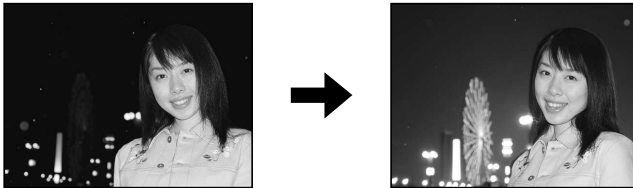

■ Slow synchronization (2nd curtain) ⚡ SLOW 2nd-CURTAIN

2nd curtain flash fires just before the shutter closes. Changing the flash timing can create interesting effects in your picture, such as expressing the movement of a car by showing the tail-lights streaming backwards. The slower the shutter speed, the better the effects turn out. The slowest possible shutter speed depends on the shooting mode.

P mode : 2 sec.

A/S/M mode (Bulb is also available) : 60 sec.

When the shutter speed is set to 2 sec.

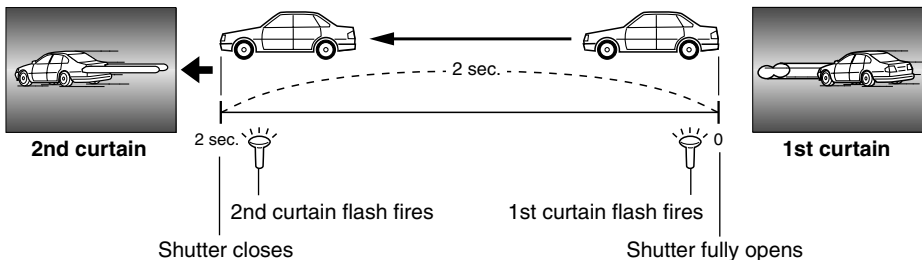

■ Slow synchronization + Red-eye reduction flash ⚡ SLOW

This mode is for when you want to use slow synchronization, yet also reduce the red-eye phenomenon. For instance, when shooting a person against a brightly lit night background. A normal flash might make the person's eyes red, but this mode lets you capture the background correctly and reduce the red-eye phenomenon at the same time. 2nd curtain flash with red-eye reduction is not available.

■ Fill-in flash

The flash fires regardless of the light conditions. This mode is useful for eliminating shadows on the subject's face (such as shadows from tree leaves), in a backlight situation, or for correcting the color shift produced by artificial lighting (especially fluorescent light).



Note

- When the flash fires, the shutter speed is set to 1/180 sec. or less. When shooting a subject against a bright background with the flash, the background may be overexposed. In this case, set the flash (FL-50) to the Super FP flash mode.









■ Fill-in flash + Red-eye reduction flash

This mode makes it possible to fire the flash regardless of the light conditions and also to reduce red-eye phenomenon.

■ Fill-in flash + Slow synchronization (2nd curtain) 2nd-CURTAIN

The flash fires regardless of the light conditions at the timing of the 2nd curtain when shooting at a slow shutter speed.

Flash modes available in the exposure mode

Exposure mode	Control panel indication	Flash mode	Flash timing	Conditions to fire the flash	Shutter speed restrictions
P • A	(No indication)	Auto-flash	1st curtain	Fires automatically in dark/backlit* conditions	1/30 - 1/180 with auto/ 
		Auto-flash (Red-eye reduction)			
	 ⚡ SLOW	Slow synchronization (Red-eye reduction)			
	⚡ SLOW	Slow synchronization			
	 ⚡ SLOW 2nd-CURTAIN	Slow synchronization (2nd curtain)	2nd curtain	Always fires	Restricted to 2 - 1/180 sec.
	Fill-in flash	1st curtain			
S • M		Fill-in flash	1st curtain	Always fires	Restricted to 60 - 1/180 sec.
	 	Fill-in flash (Red-eye reduction)	1st curtain		
	 2nd-CURTAIN	Fill-in flash (2nd curtain)	2nd curtain		

* When the flash is set to the Super FP mode, it detects backlight before emitting light.

 "Super FP flash" (P. 104)

Setting the flash mode

1 While holding down the **⚡** (flash mode) button, rotate the main dial or sub dial to select the desired flash mode.

- The flash mode can be switched depending on the exposure mode currently used to display on the control panel.

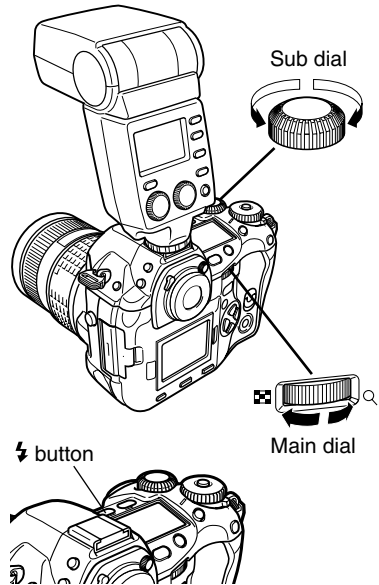
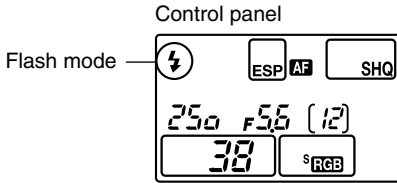

■ When the exposure mode is set to P/A mode

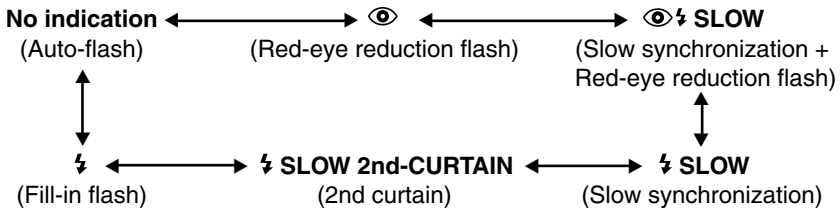

■ When the exposure mode is set to S/M mode

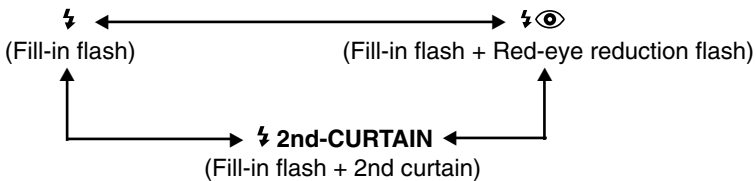

Super FP flash

Super FP flash is available with the FL-50. Super FP flash timing is longer than standard flash timing. This means that pictures can be taken at a higher speed than is possible with normal flashes.

Flash shooting with the aperture open such as in portrait shooting is also possible with Super FP flash. For details, refer to the FL-50 manual.

Viewfinder

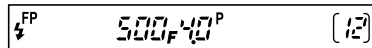

Flash intensity control

This adjusts the amount of light emitted by the flash.

In some situations (e.g., when shooting small subjects, distant backgrounds, etc.), you may get better results by adjusting light emission. It is useful when you intend to increase the contrast (distinction between light and dark) of images to make the images more vivid.

1 In the menu, select → , then press .

“How to use the menus” (P. 38)

- The setting screen is displayed.

2 To increase light emission:
Each time you press , light emission increases in steps of 1/3EV.

To decrease light emission:
Each time you press , light emission decreases in steps of 1/3EV.

- You can select EV steps from 1/3EV, 1/2EV or 1EV. “EV STEP” (P. 125)

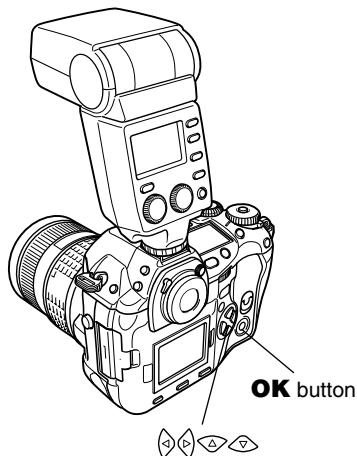

3 Press the **OK** button repeatedly to exit the menu.

- After setting is complete, is displayed on the control panel. disappears when it is set to ± 0 .

TIPS

To adjust light emission without using the menu:

- Rotate the main dial or sub dial while holding down the (flash mode) button and (exposure compensation) button at the same time.

Note

- This does not work when the flash control mode on the electronic flash is set to MANUAL.
- If light emission is adjusted on the electronic flash, it will be combined with the camera's light emission setting.

Using commercially available flashes

The amount of light emitted cannot be adjusted on commercially available flashes except for those specified. The flash can be used by connecting to the hot shoe or by connecting the synchro cable to the external flash connector. A small versatile flash can be synchronized with the camera at a shutter speed of 1/180 sec. or less, whereas a large flash (such as a studio flash) can be synchronized at 1/125 sec. or less. For details on non-specified commercial flashes, refer to the next page.

1 Remove the hot shoe cover to connect the flash unit to the camera.

2 Set the exposure mode to M mode, then set the aperture value and shutter speed.

☞ “Manual shooting” (P. 63)

- A slower shutter speed may produce blurred images.

3 Turn on the flash.

- Be sure to turn on the flash after attaching the flash unit to the camera.

4 Set the flash control mode on the flash to AUTO. Also set the ISO sensitivity and aperture value on the flash to match the camera's settings.

- Refer to the manual for the flash to set its flash control mode.

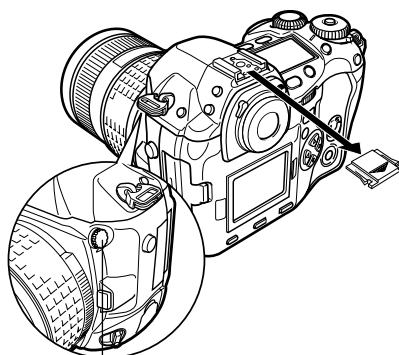

External flash connector

Note

- The camera's flash mode except 2nd curtain will have no effect on the non-specified commercial flashes.
- The flash fires each time the shutter is released. When you do not need to use the flash, turn off the flash's power.
- Check beforehand that the flash you are using is synchronized with the camera.

Non-specified commercial flashes

Before selecting a non-specified commercial flash, be sure to read the following information carefully to determine whether or not it can be used with this camera.

- (1) Some flashes available on the market operate with a synchro terminal with a voltage of 250 V or over. If one of these is used, it may damage the camera, and/or the camera may not function normally. Contact the manufacturer of the flash you are using concerning the specifications of the flash's synchro terminal.
- (2) Some flashes available on the market have the polarity of the synchro terminal reversed. In this case, even if the flash is connected, it will not fire. Contact the manufacturer of the flash for more information.

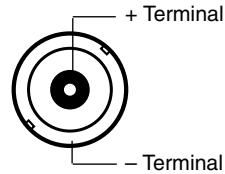

Polarity of the external flash connector

- (3) Exposures when using a flash require that adjustments be made on the flash. If a flash is used in the auto mode, match it with the F value and ISO sensitivity settings on the camera.
- (4) Even if the auto F value and ISO sensitivity of the flash are set to the same conditions as those on the camera, the correct exposure may not be obtained depending on the shooting conditions. In such a case, adjust the auto F value or ISO on the flash or calculate the distance in the manual mode. (Exposure compensation on the camera cannot be used when shooting with the flash.)
- (5) Use a flash with an illumination angle that matches the focal length of the lens. The focal length of the lens for 35 mm film is approximately twice as long as the focal length of the lenses designed for this camera.
- (6) **Do not use a flash unit or other accessory TTL flash that has additional communications functions other than the specified flashes, since it may not only fail to function normally, but may also cause damage to the camera's circuitry.**

8 Playback

Single-frame playback



One frame is displayed on the monitor.

1 Press the (playback mode) button.

- The monitor blinks and displays the last picture taken.

2 Use the arrow pad to select the picture you want to display.

- Detailed information about the picture and histogram can be displayed. “Information display” (P. 109)

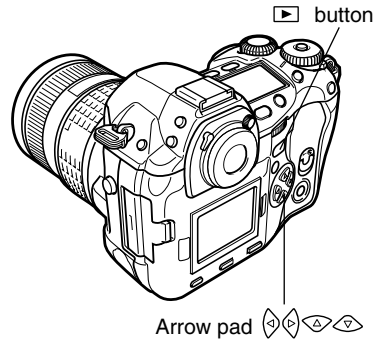

: Displays the frame that is stored 10 frames back.

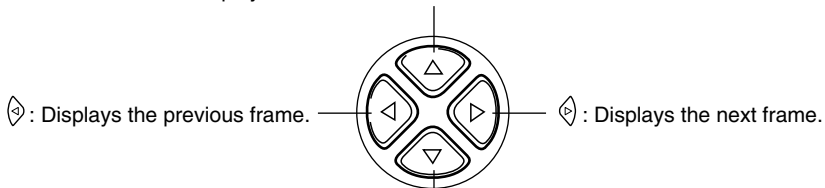

: Displays the frame that is stored 10 frames ahead.



Note

- The maximum number of pictures that can be played back on this camera is “2000”.





■ Close-up playback

This function lets you enlarge pictures displayed on the monitor. It is useful when you want to check the details in an image.



■ Index display

This function lets you show several pictures on the monitor at the same time. It is useful when you want to quickly search a number of pictures to find a particular image.

Each time you rotate the main dial toward , the number of pictures shown changes from 4 to 9 to 16.

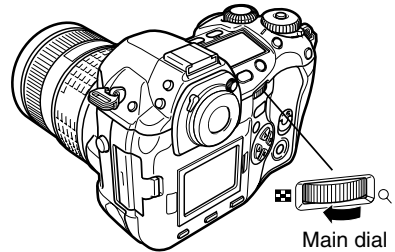
-  : Moves to the previous frame.
-  : Moves to the next frame.
-  : Displays the index previous to the top-left image in the currently displayed index.
-  : Displays the index preceding the lower-right image in the currently displayed index.



 Rotating the dial toward  returns to single-frame playback.

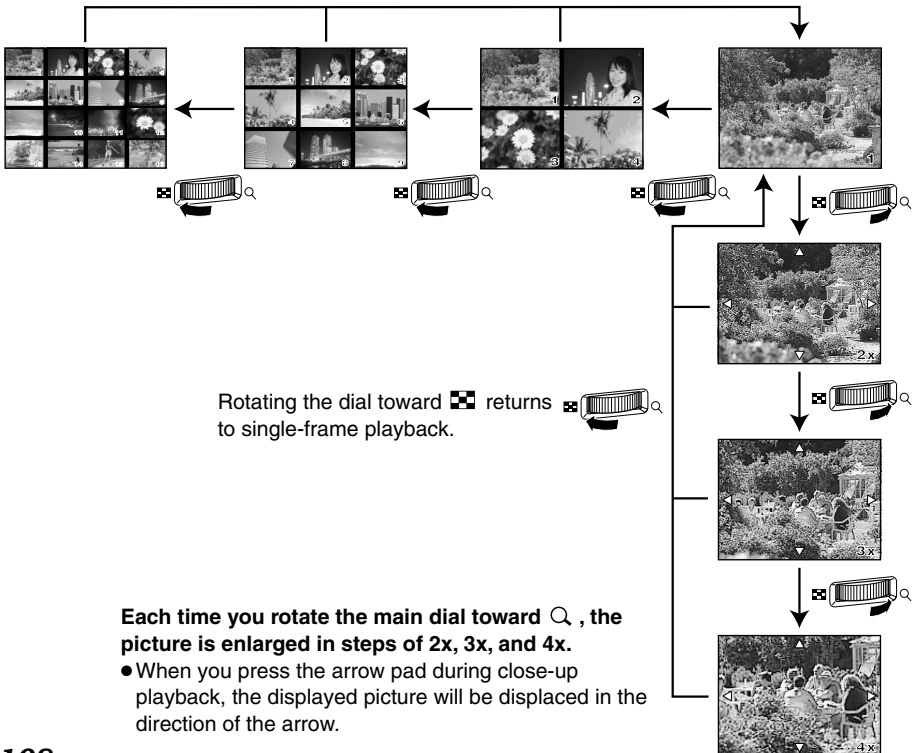

This allows you to display detailed information about the picture. Luminance information can also be displayed with histogram and highlight graphs.

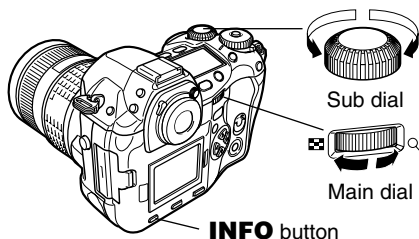

1 While holding down the **INFO** (information display) button, rotate the dial to change the information display type.

- The amount of information displayed changes.
- This setting is stored and will be shown the next time the information display is called up.

2 Press **INFO**.

- Detailed information is displayed.

3 While holding down **INFO**, rotate the dial to change the display type.

- The screen switches between highlight, histogram or shooting information displays.
- This setting is stored and will be shown the next time the information display is called up.

4 Press **INFO**.

- The normal information display is restored.
- Each time **INFO** is pressed, the screen switches between the information display that you set in Step 1 and the information display set in Step 3.

Single-frame playback information

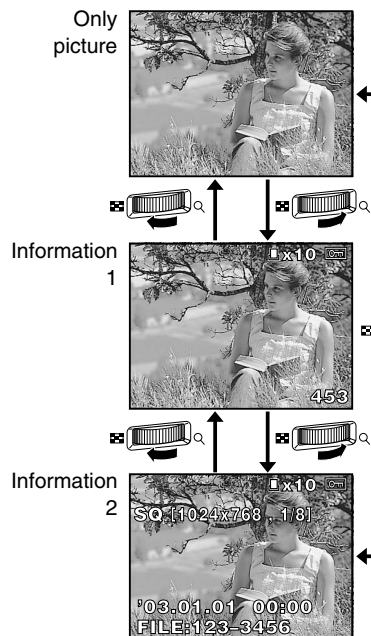

Detailed information

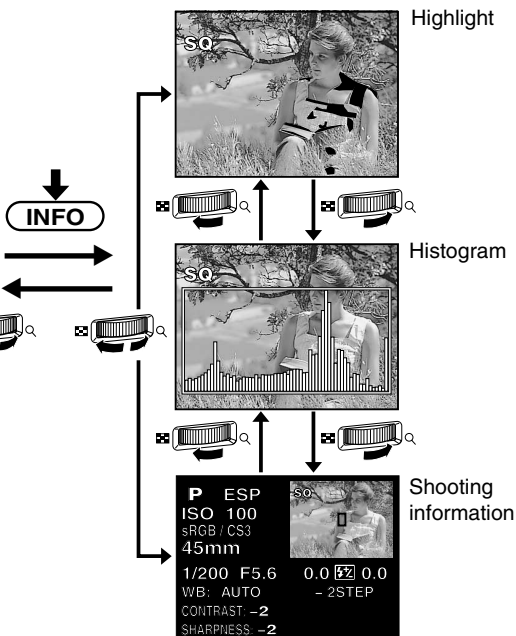

■ **Information 1**

Frame number, print reservation and protect.



■ **Information 2**

Print reservation, protect, record mode, number of pixels, compression, date and time and file number.



■ **Highlight**

The overexposed parts of the recorded image blink.

Overexposed parts



■ **Histogram**

Shows you the distribution of brightness in recorded images. Checking the histogram will enable more precise exposure control for subsequent shots.

How to use the histogram display

The histogram display enables you to check the brightest highlights and darkest shadows which may result in a poor image. If the bars in the histogram are higher towards the right, the image may be too bright. If the bars are higher on the left, the image may be too dark. Compensate the exposure or re-compose, etc. then shoot again.

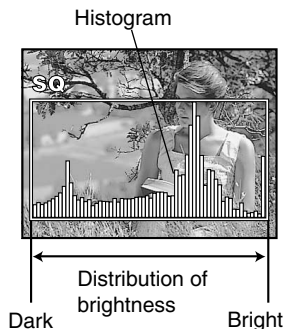

■ **Shooting information**

Displays the exposure mode, metering mode, record mode, ISO sensitivity, color space, saturation and focal length, etc.

☞ "Monitor indications (only for playback)" (P. 13)





This function displays pictures stored on the card one after another in succession. Pictures are displayed one by one for about 5 seconds starting from the currently displayed picture. You can select the number of pictures in the slideshow from 1, 4, 9 or 16.

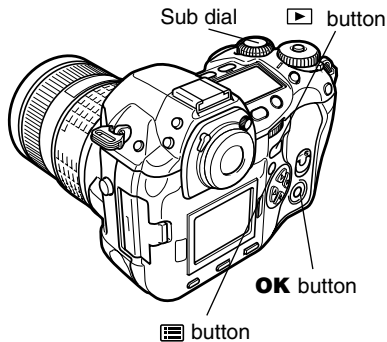

1 In the menu, select → → , , or .

“How to use the menus” (P. 38)

2 Press the **OK** button to start the slideshow.

3 Press the (menu) button or (playback mode) button to stop the slideshow.



When selecting

Note

- If the camera is running on battery power during slideshow operation, the battery will run out in about one hour.

Picture rotation



This function lets you rotate pictures and display them vertically on the monitor. This is useful for viewing pictures that were taken with the camera held vertically.

1 In the menu, select → → **ON** and press the **OK** button.

“How to use the menus” (P. 38)

2 Rotate the sub dial as shown below.

- Each rotation of the sub dial to the right turns the picture 90 degrees clockwise. Rotating the sub dial to the left turns the picture 90 degrees counterclockwise.
- The rotated picture will be recorded on the card.

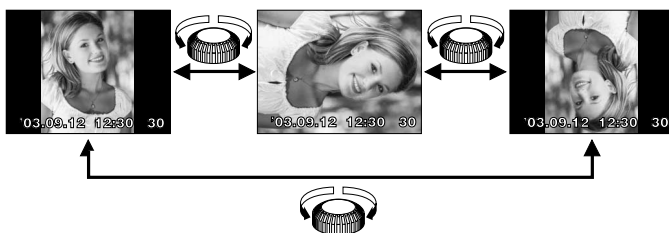

Playback on a TV

Recorded images can be played back on your TV.

- 1 Turn the camera and TV off, and connect the video cable as illustrated.**
- 2 Turn the TV on and switch it to the video input mode.**
- 3 Turn the camera on and press the  (playback mode) button.**
 - The last picture taken is displayed on the TV. Use the arrow pad to select the picture you want to display (P. 107).
 - The close-up playback, index display and slideshow functions can also be used on a TV screen.

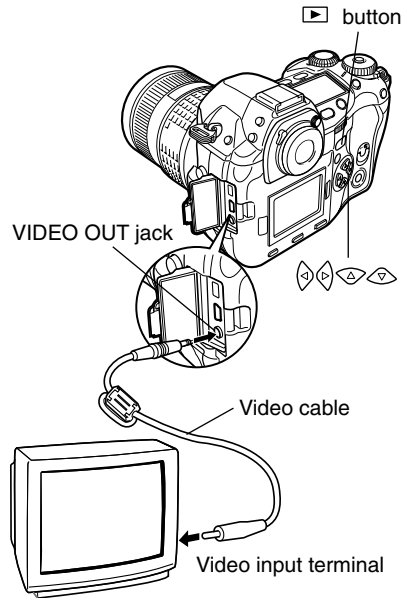



Note

- Use of the optional AC adapter is recommended.
- Make sure that the camera's video output signal type is the same as the TV's video signal type.  "VIDEO OUT" (P. 131).
- The camera's monitor turns off automatically when the video cable is connected to the camera.
- Be sure to use the provided video cable to connect the camera to the TV.
- The picture may appear off-center on the TV screen.
- Pictures will be compressed in order to fit the entire image on the TV screen, and a black frame will appear around the image. If the picture is sent to a video printer via the TV, the black frame may also be printed.

RAW DATA EDIT

This performs image processing (such as white balance and sharpness adjustment) on images in the RAW data format, then saves the data to a new file in the TIFF or JPEG format. While checking recorded pictures, you can edit them to your liking.

1 Image processing is performed based on the current camera settings. Set the items available for editing (refer to the items listed below) beforehand.

2 In the menu, select  → **RAW DATA EDIT**, then press .

- The RAW DATA EDIT screen is displayed.
 “How to use the menus” (P. 38)

3 Press     to select the image, then press the **OK** button.

- The busy bar is displayed on the screen. After the bar disappears, image processing is complete.
- The data will be recorded to the card as a new file.

4 To edit another image, press     to select the desired image.

- To exit the RAW DATA EDIT screen, press the  (menu) button to restore the menu.

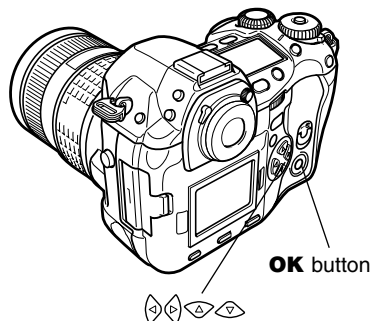

Items that can be set by RAW DATA EDIT

White balance ()	P. 85
SATURATION	P. 94
CONTRAST	P. 93
SHARPNESS	P. 92
Record mode ()	P. 79
COLOR SPACE	P. 97

This function protects pictures from being accidentally erased.

1 Display the picture you want to protect.

2 Press the (protect) button.
• is displayed on the screen.

To cancel the protection:

Display the pictures that are protected and press .

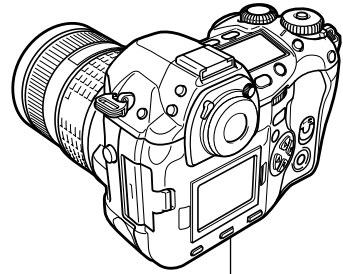

button

Note

- Formatting the card erases all pictures even if they have been protected.
- Picture rotation cannot be applied to protected pictures.

Protect mark





Single-frame erase

This function erases only the picture that is displayed on the monitor.

- 1 Display the picture you want to erase.
- 2 Press the (erase) button.
 - The ERASE screen is displayed.
- 3 Press to select YES, then press the **OK** button.

ERASE SETTING

In the ERASE SETTING screens in the (custom) menu, you can set the screen cursor setting to YES.

"ERASE SETTING" (P. 127)

Note

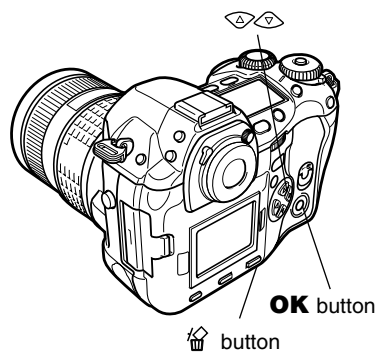

- You cannot erase protected pictures.





ERASE screen

Erasing selected frames

This function lets you erase selected pictures at one time. You can select and erase several pictures from the index display screen.

- 1** Bring up the index display.
- 2** Press  to select the pictures you want to erase, and press the **OK** button.
 - The selected pictures will be shown with red frames.
 - Press **OK** again to cancel your selection.
- 3** After you have selected the frame to erase, press the  (erase) button.
 - The ERASE SELECTED screen is displayed.
- 4** Press  to select YES, then press **OK**.

ERASE SETTING

In the ERASE SETTING screens in the  (custom) menu, you can set the screen cursor setting to YES.
 "ERASE SETTING" (P. 127)

Note

- You cannot erase protected pictures.

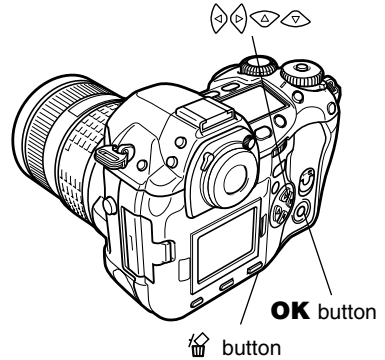

Index display screen

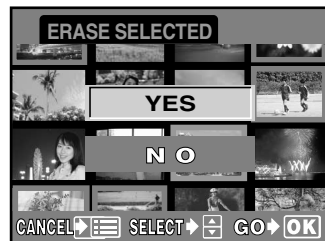

ERASE SELECTED screen

All-frame erase

This function erases all the pictures on the card.

1 In the menu, select → **CARD SETUP**, then press .

- The CARD SETUP screen is displayed.
 “How to use the menus” (P. 38)

2 Press to select **ALL ERASE**, then press the **OK** button.

- The ALL ERASE screen is displayed.

3 Press to select **YES**, then press **OK**.

- All frames will be erased.

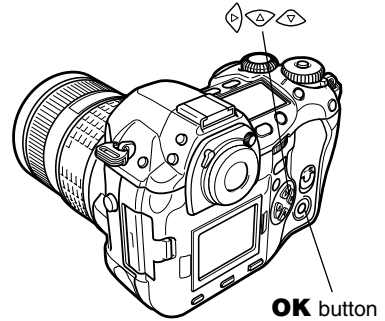

ERASE SETTING

In the ERASE SETTING screens in the (custom) menu, you can set the screen cursor setting to YES.
 “ERASE SETTING” (P. 127)

Note

- You cannot erase protected pictures.

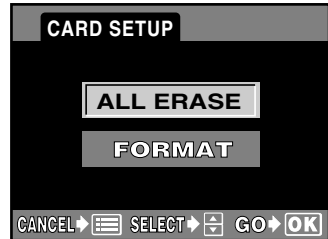

CARD SETUP screen



ALL ERASE screen

9 Function/setting customizing

CUSTOM RESET SETTING

Even when the power is turned off, the settings you made while the power was on will be saved. To restore the factory default settings, refer to “How to use reset settings” (P. 119). CUSTOM RESET SETTING allows you to customize and register up to 4 different reset settings for later use.

How to register reset settings

1 In the menu, select \uparrow 1 \rightarrow **CUSTOM RESET SETTING**. Press \triangleright .

- The CUSTOM RESET SETTING screen appears.
 \leftarrow “How to use the menus” (P. 38)

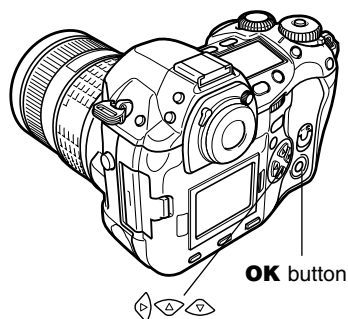

2 Press \triangleleft \triangleright to select **RESET 1, RESET 2, RESET 3 or RESET 4**. Press \triangleright .

- If menu settings have already been registered, SET is displayed next to the corresponding reset option.

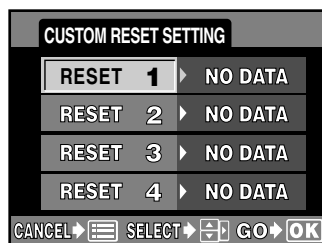

3 **Registering:** Press \triangleleft \triangleright to select **SET**. Press the **OK** button.

- The current settings are registered.



Clearing already registered settings:

Press \triangleleft \triangleright to select **CLEAR**. Press **OK**.

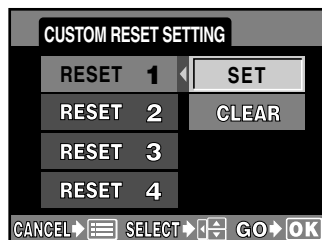
- Registered settings are canceled.





How to use reset settings

- Hold down the  (record mode) button and  (flash mode) button simultaneously.

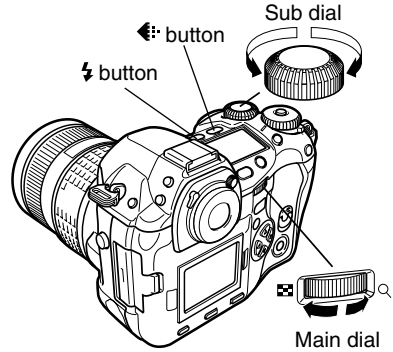
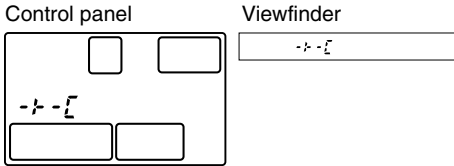
 -  (reset cancel) is displayed on the control panel.
 - If you do not want to use the reset settings, release the buttons.



- While holding  and , rotate the main dial or sub dial.

-  : Resets to the factory default settings.
 -  : Resets to the settings registered in RESET 1.
 -  : Resets to the settings registered in RESET 2.
 -  : Resets to the settings registered in RESET 3.
 -  : Resets to the settings registered in RESET 4.
- If no settings are registered with a RESET number, it will not be displayed.

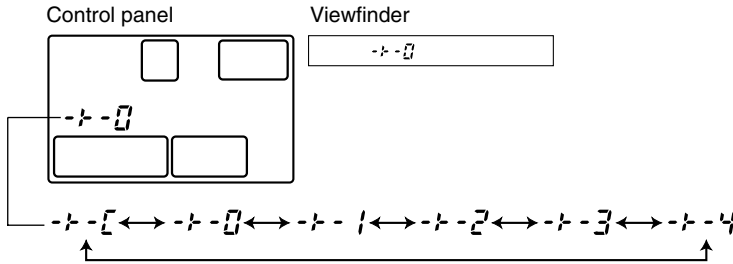

- When the desired RESET number is displayed, release the buttons.

 - The camera will be reset to the settings you selected.

Functions that can be registered in CUSTOM RESET SETTING & functions that reset to factory default settings are listed below

	Functions	Factory default settings (- / - / -)	Registration
Menu function	 (P.104)	0.0	√
	SATURATION (P. 94)	CS2	√
	CONTRAST (P. 93)	0	√
	SHARPNESS (P. 92)	0	√
	COLOR SPACE (P. 97)	sRGB	√
	WB BKT (P. 72)	OFF	√
	RAW•JPEG (P. 82)	OFF	√
	NOISE FILTER (P. 95)	OFF	√
	NOISE REDUCTION (P. 95)	OFF	√
	SHADING COMP. (P. 97)	OFF	√
	AF ILLUMINATOR (P. 55)	ON	√
	ANTI-SHOCK (P. 78)	OFF	√
	 (P. 111)	OFF	—
	EV STEP (P. 125)	1/3EV	√
	ISO BOOST (P. 84)	OFF	√
	 (P. 90)	±0	√
	SQ (P. 81)	1280 x 960, 1/8	—
	AEL/AFL*1 (P. 122)	mode1/mode6	—
	DIAL*2 (P. 126)	Ps/F.No./SHUTTER	—
	FOCUS RING (P. 127)	↻	—
	S-AF+MF (P. 52)	OFF	—
	RELEASE PRIORITY S (P. 54)	OFF	—
	RELEASE PRIORITY C (P. 54)	OFF	—
	RESET LENS (P. 127)	ON	—
	PC MODE (P. 133)	STORAGE	—
	ERASE SETTING (P. 127)	NO	—
FILE NAME (P. 128)	AUTO	—	
REC VIEW (P. 129)	OFF	—	
 (P. 129)	ON	—	
 (P. 129)	0	—	
SLEEP (P. 130)	1min	—	
 (P. 131)	ENGLISH	—	
VIDEO OUT (P. 131)	*3	—	

√ : Can be registered

— : Cannot be registered. When the RESET 1-4 settings are used, functions indicated by — will retain their current settings. The factory default settings are not restored.

*1 Depending on the selected focus mode, the factory default setting changes.

*2 Depending on the selected exposure mode, the factory default setting changes.

*3 The factory default setting varies depending on the area where you purchased this camera.

	Functions	Factory default settings (- / -)	Registration
Settings available using buttons and dials	ISO sensitivity (P. 83)	Auto	√
	Exposure compensation (P. 65)	0.0	√
	White balance (P. 85)	Auto	√
	Record mode (P. 79)	HQ	√
	Flash mode*2 (P. 100)	Auto/Fill-in flash	√
	Auto bracketing (P. 70)	Off	√
	Metering mode (P. 68)	ESP	√
	Drive mode (P. 73)	Single-frame shooting	√
	AF frame selection (P. 50)	[] (3 points)	√
	Shutter speed*2 (P. 61)	1/60	√
	Aperture value*3 (P. 59)	F2.8	√
	Playback mode (P. 107,109)	Single-frame playback (with no information)	—
	Information display (P. 109)	Highlight	—

√ : Can be registered

— : Cannot be registered. When the RESET 1-4 settings are used, functions indicated by — will retain their current settings. The factory default settings are not restored.

*2 Depending on the selected exposure mode, the factory default setting changes.



*3 Depending on the selected exposure mode and attached lens, the factory default setting changes.

This allows you to combine the **AEL** (AE lock) button function with the functions performed when pressing the shutter button halfway (focus lock and AE lock) depending on your preference.

Examples:

- After locking focus, you lock exposure value to take a picture.
- After locking exposure value, you lock focus to take a picture.
- After locking exposure value and focus, you take a picture whenever the opportunity arises.

1 In the menu, select $\bar{1}$ → **AEL/AFL** → **S-AF, C-AF or MF**.
 “How to use the menus” (P. 38)

2 Press   to select a mode. Press the **OK** button.
S-AF : Select one from mode 1- mode 5.
C-AF : Select mode 6 or mode 7.
MF : Select one from mode 1- mode 5.

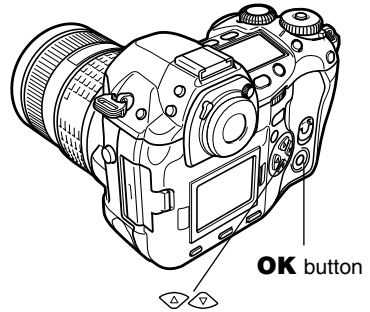

■ Modes available in the S-AF mode



mode 1

Shutter button function: Pressing the shutter button halfway locks focus and exposure value. Pressing it all the way releases the shutter to take the picture.

AEL button function: The exposure value is locked while you hold down the **AEL** button.

- The exposure value locked when **AEL** is pressed has priority over the exposure value locked when the shutter button is pressed halfway.



mode 2

Shutter button function: Pressing the shutter button halfway locks focus and exposure value. Pressing it all the way releases the shutter to take the picture.

AEL button function: The exposure value is locked when the **AEL** button is pressed (AE memory). When **AEL** is pressed again, AE memory is canceled.

- The exposure value stored in AE memory has priority over the exposure value locked when the shutter button is pressed halfway.

**mode 3**

Shutter button function: Pressing the shutter button halfway locks focus and exposure value. Pressing it all the way releases the shutter to take the picture.

AEL button function: The focus is locked when the **AEL** button is pressed (AE memory). When **AEL** is pressed again, AF memory is canceled.

- The focus stored in AF memory has priority over the focus locked when the shutter button is pressed halfway.

**mode 4**

Shutter button function: Pressing the shutter button halfway locks focus. When the shutter button is pressed all the way, the picture is taken using the locked exposure value.

AEL button function: The exposure value is locked while you hold down the **AEL** button.

- The exposure value locked when **AEL** is pressed has priority over the exposure value locked when the shutter button is pressed all the way.

**mode 5**

Shutter button function: Pressing the shutter button halfway locks focus. When the shutter button is pressed all the way, the picture is taken using the locked exposure value.

AEL button function: The exposure value is locked when the **AEL** button is pressed (AE memory). When **AEL** is pressed again, AE memory is canceled.

- The exposure value stored in AE memory has priority over the exposure value locked when the shutter button is pressed all the way.

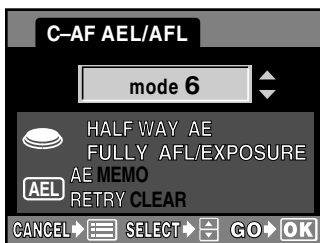
■ Modes available in the C-AF mode**mode 6**

Shutter button function: Pressing the shutter button halfway locks exposure value. When the shutter button is pressed all the way, the picture is taken using the locked focus.

AEL button function: The exposure value is locked when the **AEL** button is pressed (AE memory). When **AEL** is pressed again, AE memory is canceled.

- The exposure value stored in AE memory has priority over the exposure value locked when the shutter button is pressed halfway.

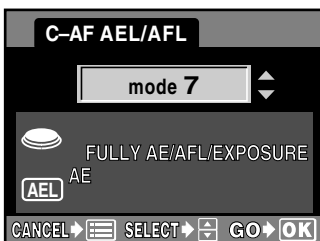
**mode 7**

Shutter button function: When the shutter button is pressed all the way, the picture is taken using the locked focus and exposure value.

AEL button function: The exposure value is locked while you hold down the **AEL** button.

- The exposure value locked when **AEL** is pressed has priority over the exposure value locked when the shutter button is pressed all the way.

■ Modes available in the MF mode

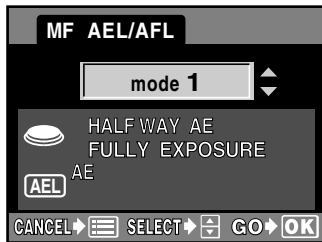

mode 1

Shutter button function: Pressing the shutter button halfway locks exposure value. Pressing it all the way releases the shutter to take the picture.

AEL button function: The exposure value is locked while you hold down the **AEL** button.

- The exposure value locked when **AEL** is pressed has priority over the exposure value locked when the shutter button is pressed halfway.



mode 2

Shutter button function: Pressing the shutter button halfway locks exposure value. Pressing it all the way releases the shutter to take the picture.

AEL button function: The exposure value is locked when the **AEL** button is pressed (AE memory). When **AEL** is pressed again, AE memory is canceled.

- The exposure value stored in AE memory has priority over the exposure value locked when the shutter button is pressed halfway.



mode 3

Shutter button function: Pressing the shutter button halfway locks exposure value. Pressing it all the way releases the shutter to take the picture.

AEL button function: AF operates while you hold down the **AEL** button.

- After releasing the **AEL** button, the focus can be adjusted in either direction with the focus ring.

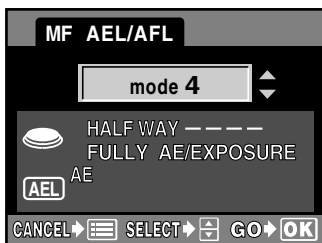

mode 4

Shutter button function: Shooting is performed using the exposure value locked when the shutter button is pressed all the way.

AEL button function: The exposure value is locked while you hold down the **AEL** button.

- The exposure value locked when **AEL** is pressed has priority over the exposure value locked when the shutter button is pressed all the way.



mode 5

Shutter button function: Shooting is performed using the exposure value locked when the shutter button is pressed all the way.

AEL button function: The exposure value is locked when the **AEL** button is pressed (AE memory). When **AEL** is pressed again, AE memory is canceled.

- The exposure value stored in AE memory has priority over the exposure value locked when the shutter button is pressed all the way.

EV STEP

This allows you to change the EV step for exposure parameter setting, such as shutter speed, aperture value or exposure compensation value, etc.

- 1 In the menu, select \mathcal{I}_1 → EV STEP → 1/3EV, 1/2EV or 1EV. Press the **OK** button.

 “How to use the menus” (P. 38)

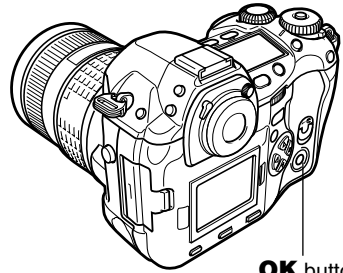

OK button

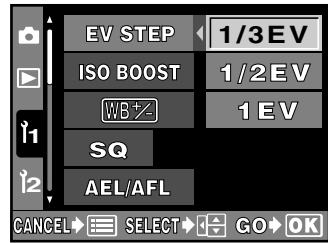

This allows you to select a combination of functions (Program shift (Ps), exposure compensation, aperture setting, or shutter speed setting) to be assigned to the main dial and/or sub dial for each mode (P, A, S).

1 In the menu, select $\bar{1}$ → DIAL → P, A, or S. Press \diamond .

- The DIAL screen appears.
- ☞ “How to use the menus” (P. 38)

2 The following functions can be assigned.

P	Ps, \square
A	F.No., \square
S	SHUTTER, \square

\square : Exposure compensation, F.No.: Aperture setting, SHUTTER: Shutter speed setting

Press \diamond \diamond to select the combination of the functions to be assigned to the main dial and/or sub dial.

3 Press the **OK** button.

- The function assignment is changed.

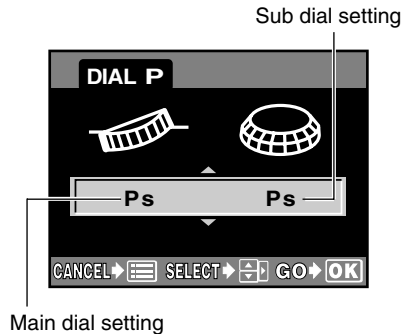
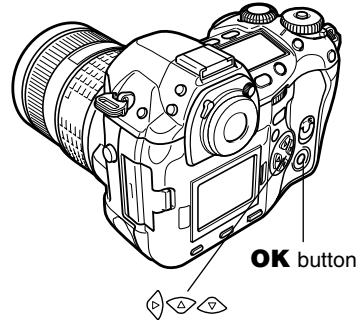

RESET LENS

This allows you to reset the focus of the lens when the power is turned off.

- 1 In the menu, select $\bar{1}$ → **RESET LENS** → **OFF** or **ON**. Press the **OK** button.
☞ “How to use the menus” (P. 38)

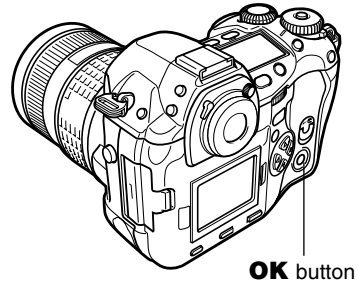

FOCUS RING

This allows you to select the rotational direction of the focus ring to suit your preference of how the lens adjusts to the focusing point.

- 1 In the menu, select $\bar{1}$ → **FOCUS RING** → \curvearrowright or \curvearrowleft . Press the **OK** button.
☞ “How to use the menus” (P. 38)

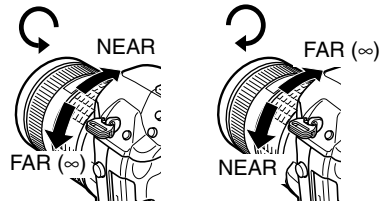

ERASE SETTING

This allows you to customize the cursor position (YES or NO) as the initial position on the ERASE, ALL ERASE, ERASE SELECTED, REC. CANCEL or FORMAT screen.

- 1 In the menu, select $\bar{1}$ → **ERASE SETTING** → **YES** or **NO**. Press the **OK** button.
☞ “How to use the menus” (P. 38)

FILE NAME

When you take a picture, the camera assigns it a unique file name and saves it in a folder. The folder and file name can later be used for file handling on a computer. File names are assigned as shown in the illustration below.

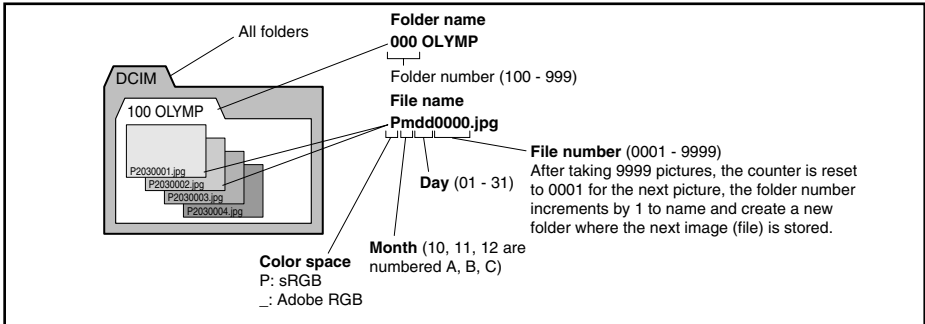

■ File name settings

AUTO

Even when a new card is inserted, the folder numbers are retained from the previous card. If the new card contains an image file whose file number coincides with one saved on the previous card, the new card's file numbers start at the number following the highest number on the previous card.

RESET

When a new card is inserted, folder numbers start at 100 and file numbers start at 0001. If a card containing images is inserted, the file numbers start at the number following the highest file number on the card.

- In the menu, select → FILE NAME → AUTO or RESET. Press the **OK** button.

“How to use the menus” (P. 38)

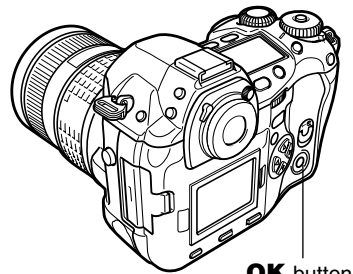

OK button

Note

- When both the Folder and File No. reach their respective maximum number (999/9999), it is not possible to store additional pictures even if the card is not full. No more pictures can be taken. Replace the card with a new one.

REC VIEW

This allows you to display the picture you have just taken on the monitor while it is being recorded to the card, and to select how long the picture is displayed. This is useful for making a brief check of the picture you have just taken. Pressing the shutter button halfway during REC VIEW lets you resume shooting immediately.

OFF : The picture being recorded to the card is not displayed.

AUTO : The picture being recorded to the card is displayed. The display duration is automatically set by the camera and varies depending on the recording time.

5sec : The picture being recorded to the card is displayed for 5 seconds.

20sec : The picture being recorded to the card is displayed for 20 seconds.

- 1 In the menu, select $\mathcal{I}2 \rightarrow$ REC VIEW \rightarrow OFF, AUTO, 5sec or 20sec. Press the **OK** button.

 "How to use the menus" (P. 38)

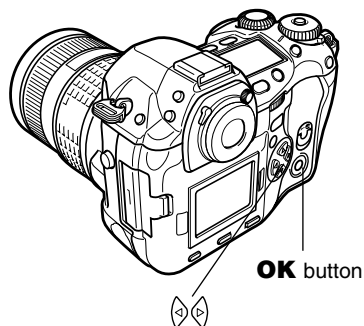

Beep sound



The camera beeps when buttons are pressed. It also beeps to alert you to warnings. You can turn the beep sound on or off with this function.

- 1 In the menu, select $\mathcal{I}2 \rightarrow$  \rightarrow OFF or ON. Press the **OK** button.

 "How to use the menus" (P. 38)

Monitor brightness adjustment



This allows you to adjust the brightness of the monitor for optimal viewing.

- 1 In the menu, select $\mathcal{I}2 \rightarrow$  . Press \diamond .

• The  screen is displayed.

 "How to use the menus" (P. 38)

- 2 Press \diamond to adjust the brightness. Press the **OK** button.



SLEEP

After a specified period of time elapses with no operations being performed, the camera enters the sleep mode (stand-by) to save battery power. SLEEP lets you select sleep timer. OFF cancels the sleep mode.

The camera activates again as soon as you touch any button (the shutter button, arrow pad, etc.)

- 1 In the menu, select $\frac{1}{2}$ → SLEEP → OFF, 1min, 3min, 5min or 10min. Press the **OK** button.

“How to use the menus” (P. 38)

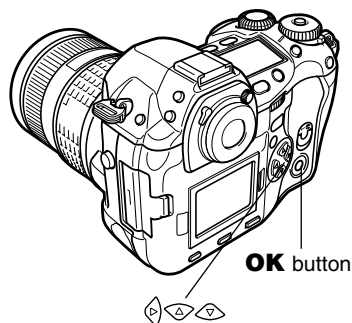

FORMAT (CARD SETUP)

This function lets you format a card. Formatting prepares cards to receive data. Before using cards to be used for the first time with this camera or cards which have been formatted on a PC, you must format them with this camera.

Note

- All existing data, including protected pictures, are erased when the card is formatted. Make sure that you save or transfer important data to a PC before formatting a card.

- 1 In the menu, select → **CARD SETUP**. Press $\frac{1}{2}$.

- The CARD SETUP screen is displayed.
 “How to use the menus” (P. 38)

- 2 Press $\triangleleft \triangleright$ to select **FORMAT**. Press the **OK** button.

- The FORMAT screen is displayed.

- 3 Press $\triangleleft \triangleright$ to select **YES**. Press **OK**.

- FORMAT is performed.

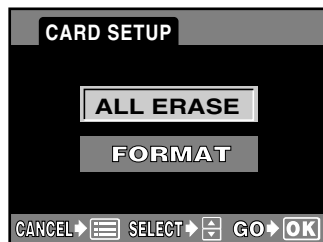

VIDEO OUT

This lets you select NTSC or PAL according to your TV's video signal type. If you use the wrong video signal type, you will not be able to play back the recorded pictures properly on your TV.

- 1 In the menu, select 12 → VIDEO OUT → NTSC or PAL. Press the **OK** button.
☞ “How to use the menus” (P. 38)

TV video signal types & main regions

NTSC	North America, Japan, Taiwan, Korea
PAL	Europe, China

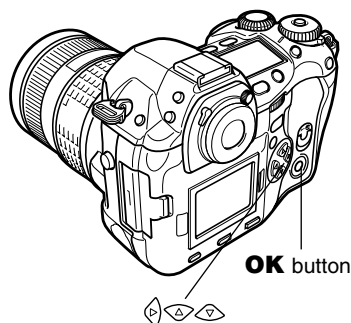

Language selection



This lets you select a language for on-screen display. This reference manual shows the English on-screen display in illustrations and explanations. Available languages vary depending on the area where you purchased this camera.

- 1 In the menu, select 12 → . Press 12 .
☞ “How to use the menus” (P. 38)
- 2 Press 12 to select the language you want to use. Press the **OK** button.





Date and time information is recorded on images. The file No. is also included with the date and time information.

1 In the menu, select \mathcal{Z} → ⌚ . Press ⏏ .

- The ⌚ screen is displayed.
- ☞ “How to use the menus” (P. 38)

2 Press ⏏ to select one of the following date formats:

**Y-M-D (Year/Month/Day),
M-D-Y (Month/Day/Year),
D-M-Y (Day/Month/Year).**

Then press ⏏ .

- The following steps show the procedure used when the date and time settings are set to Y-M-D.

3 Press ⏏ to set the year, then press ⏏ to move to the month setting.

- To return to the previous setting, press ⏏ .
- The first two digits of the year are fixed.

4 Repeat this procedure until the date and time are completely set.

5 Press the **OK** button.

- For a more accurate setting, press **OK** when the time signal hits 00 seconds.
The clock starts when you press the button.

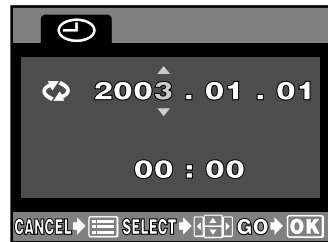
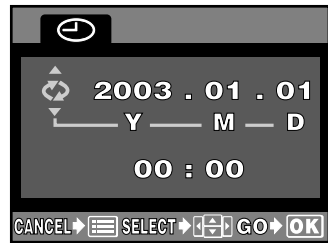
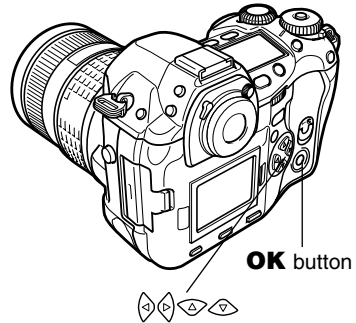

Note

- The date/time setting is saved for approximately 5 months using the built-in battery. Depending on how the camera is used, the date/time setting may be erased earlier. Date/time settings will also be lost if the camera is left for a long period with no battery loaded. The internal battery will be fully recharged in about one day with the the camera' battery loaded.

If the STORAGE mode is set when the camera is connected to a PC (via the provided USB cable), the PC automatically recognizes the camera as an external memory device (such as a hard-disk or CD-R, etc.).

With the camera's PC MODE set to CONTROL, the provided OLYMPUS Studio software (trial version) allows you to control the camera's shutter release from your PC and save recorded images to your PC. The provided OLYMPUS Viewer software allows you to manage or view images, and also to recover RAW image data on your PC.

STORAGE : Allows you to transfer data from the camera to a PC.

CONTROL : Allows you to control the camera from a PC using the optional OLYMPUS Studio.

1 In the menu, select $\bar{1}$ → PC MODE → STORAGE or CONTROL. Press the **OK** button.

 “How to use the menus” (P. 38)

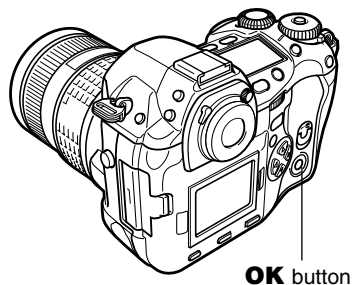

Note

- The provided OLYMPUS Studio software is a trial version.

10 Print reservation

What is print reservation?



Print reservation means saving the desired printing data (number of prints, date/time information) with the pictures stored on the card. This enables printing pictures on a DPOF-compatible printer or at a photo lab that supports DPOF. Print reservation allows you to save printing data with the pictures.

DPOF refers to the print data recording standard used on digital cameras. This enables desired print settings (number of prints, etc.) to be saved along with the pictures to facilitate automatic printing of pictures at a photo lab or on a home printer. Pictures with print reservation data can be printed as follows:

■ Printing at a photo lab that supports DPOF

Pictures are printed according to the saved printing data.

■ Printing on a DPOF-compatible printer

Pictures are printed directly from the card without using a PC. For more details, refer to the printer's manual. A PC card adapter is required depending on the printer.

Olympus Printers and DPOF Compatibility

Printer Name	1 Frame Select	Multiple Frame Select	Trimming	Rotation	Date	Index-Printing
P-400*1	✓	✓	✓*2	—*2	—*3	—*3
P-200	✓	✓	✓*1	—*1	✓*2	—

*1 An optional PC card adapter may be required depending on the printer.

*2 Some printers may allow you to rotate and trim images, but print reservations cannot be made with these functions on this camera.

*3 Index-printing and date/time stamping are not available. However, you may be able to set these features using the printer.

Picture size and printing

The resolution of a computer/printer is generally based on the number of dots (pixel) per inch. This is called dpi (dots per inch). The higher the dpi value, the better the printed results. Keep in mind, however, that the dpi of the picture does not change. This means that when you print an image with a higher resolution, the size of the printed picture will be smaller. Although you can print magnified images, picture quality will decrease.

If you want to print large, high-quality pictures, set the number of pixels as high as possible when taking the pictures. "Record mode" (P. 79)

Be sure to read the following before making print reservations

- DPOF reservations set by another device cannot be changed by this camera. Make changes using the original device.
- If a card contains DPOF reservations set by another device, entering reservations using this camera may overwrite the previous reservations.
- Some functions may not be available on all printers or at all photo labs.
- Some TIFF images cannot be printed.
- Print reservations cannot be made for images recorded in the RAW data mode.
- Print reservation may take a long time when saving printing data to a card.
- The DPOF standard permits printing of either the date or time stamp (not both).
- If you select a large number of pictures, print reservation may take a long time. Before doing so, check the battery level in the viewfinder and make sure sufficient power is available. If possible, connect the optional AC adapter. When selecting pictures for printing, never switch the camera off or open the memory card cover. If picture selection is interrupted, you will have to start over again.
- If you use index-printing, you cannot stamp the prints with the date or time.
- Up to 998 images per card can be selected for printing.

Single-frame reservation



Use this feature to print only the pictures you want. You can set the number of prints and whether or not to include the shooting date and time.

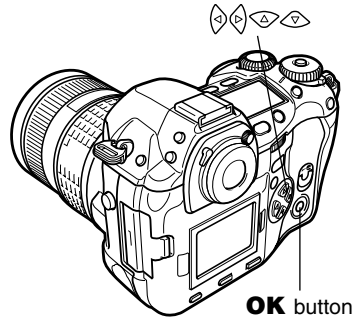

1 In the menu, select → . Press .

- ☞ “How to use the menus” (P. 38)
- If print reservation data is already stored on the card, the RESET/KEEP selection screen appears, giving you the choice of resetting the data or keeping it.
- ☞ “Resetting print reservation data” (P. 139)

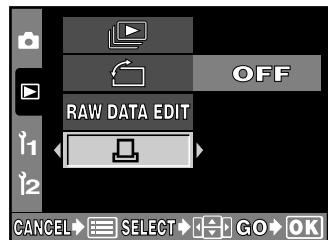

10
Print reservation

2 Press to select , then press the **OK** button.



3 Press to select the frame you want to print, then press to set the desired number of prints.

- The number of prints can be set up to 10.
- If the number of prints is set to 0, print reservation will not be applied.



4 To apply print reservation to other frames, repeat step 3.
If you do not want to make any more print reservations, press **OK**.

- The screen is displayed.

5 Press to set the date/time printing data, then press **OK**.

- **NO** : The pictures are printed without the date and time.
- **DATE** : The shooting date is printed on all pictures.
- **TIME** : The shooting time is printed on all pictures.

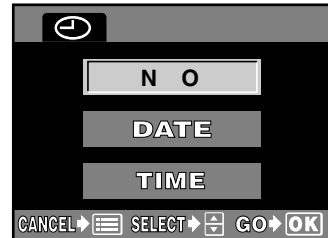

6 Press to select **SET**, then press **OK**.

- The menu is restored.



Use this feature to print all the pictures stored on the card. You can select whether or not to include the shooting date and time.

1 In the menu, select → . Press .

“How to use the menus” (P. 38)

- If print reservation data is already stored on the card, the RESET/KEEP selection screen appears, giving you the choice of resetting the data or keeping it.

“Resetting print reservation data” (P. 139)

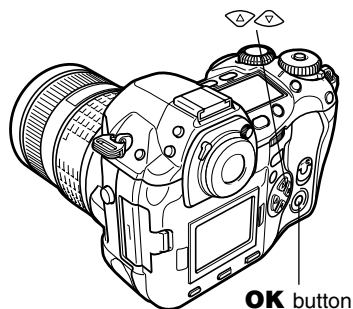

2 Press to select , then press the **OK** button.

- The screen is displayed.



3 Press to set the date/time printing data, then press **OK** (P. 136).

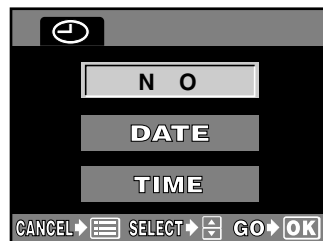

4 Press to select SET, then press **OK**.

- The menu is restored.

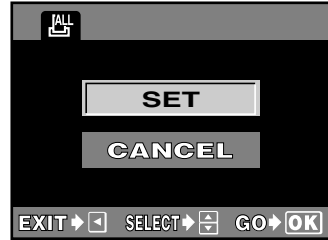

TIPS

Single-frame reservation before all-frame reservation:

→ With single-frame reservation, only one copy of each frame will be printed.

Pictures shot after performing all-frame reservation:

→ After you have done all-frame reservation, any subsequent pictures that are shot and stored in the same card will not be selected for printing. Do all-frame reservation again.

Index-printing reservation



You can select pictures stored on a card as index pictures and print them all on one sheet. The number of possible images per sheet varies depending on the printer.

1 In the menu, select → . Press .

“How to use the menus” (P. 38)

- If print reservation data is already stored on the card, the RESET/KEEP selection screen appears, giving you the choice of resetting the data or keeping it.

“Resetting print reservation data” (P. 139)

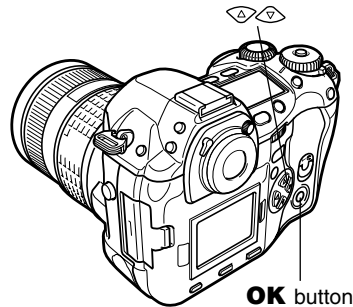

2 Press to select , then press **OK**.



3 Press to select SET, then press **OK**.

- The  menu is restored.

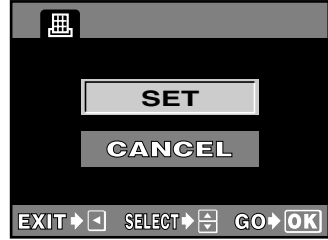

Index print

TIPS

Pictures taken after performing index-printing reservation:

- Index-printing reservation is not applied to any pictures taken after you make the reservations. Do index-printing reservation again.

Resetting print reservation data

This function allows you to reset the print reservation data for pictures stored on the card. There are three ways to reset print reservation: you can reset all print reservation data including index-printing reservation data or you can reset the print reservation data for only the frames you do not need, or you can reset only index-printing reservation data.

Resetting all-frame print reservation data

1 In the menu, select . Press .

 “How to use the menus” (P. 38)

- If print reservation data is already stored on the card, the RESET/KEEP selection screen appears, giving you the choice of resetting the data or keeping it.

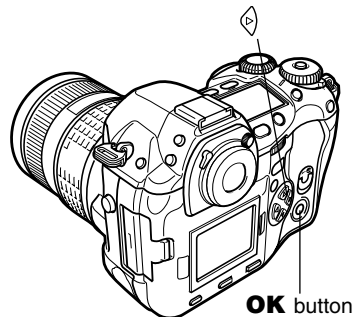



2 Select **RESET**, then press the **OK** button.

3 Press the  (menu) button.

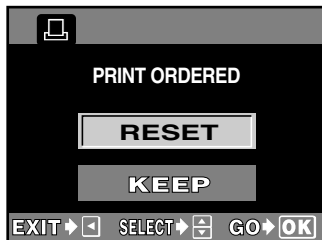
- The  menu is restored.





Resetting single-frame print reservation data

1 In the menu, select  → . Press .

 “How to use the menus” (P. 38)

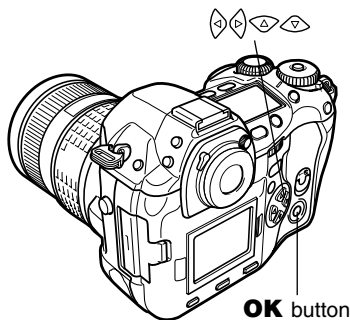

- If print reservation data is already stored on the card, the RESET/KEEP selection screen appears, giving you the choice of resetting the data or keeping it.



2 Press   to select **KEEP**, then press **OK**.

3 Press   to select , then press **OK**.



4 Press   to display the frame whose print reservation data you want to reset, then press  to set the number of prints to 0.

- To reset print reservation data of other frames, repeat this step.



5 Press OK when you are finished.

- The ⌚ screen is displayed.

6 Press ⏪ ⏩ to select NO, DATE or TIME. Press OK.

- This setting is applied to all frames with print reservation data.

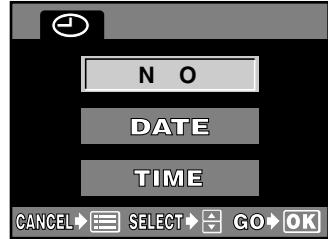
**7 Press ⏪ ⏩ to select SET, then press OK.**

- The setting is saved.
- The 📄 menu is restored.

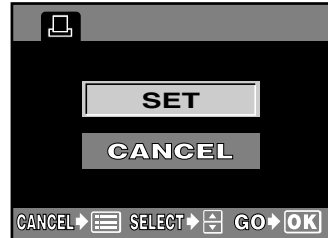

Resetting index-printing reservation data

1 In the menu, select → . Press .
 "How to use the menus" (P. 38)

- If print reservation data is already stored on the card, the RESET/KEEP selection screen appears, giving you the choice of resetting the data or keeping it.

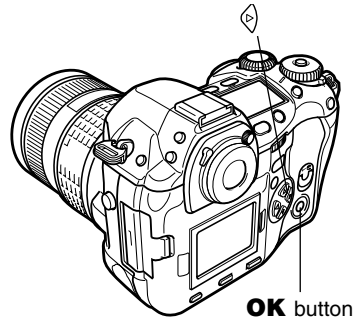

2 Press to select KEEP, then press the **OK** button.



3 Select , then press **OK**.



4 Select **RESET**, then press **OK**.
 • Only the index-printing reservation is canceled, and the menu is restored.

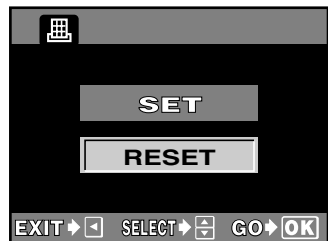

11 Transferring images to a computer

How to download images to a computer

By connecting the camera to a computer with the specified USB cable or IEEE1394 cable, images stored on a card can be transferred to the computer.

If you have graphics applications that support the JPEG file format (such as the software provided or photo-retouching software), you can process images or print them from your computer. When you print images, be sure to check beforehand whether printing is possible with your software. For details on printing images with the software, refer to your software's manual.

Some operating systems (OS) may need to install a driver before connecting to the camera for the first time. Follow the procedure in the "Flowchart" (P. 144).

Screen illustrations in this chapter may differ to those displayed on your computer.

Images files downloaded to your computer

- You can view images using: the software provided; graphics applications that support the JPEG file format (Paint Shop Pro, Photoshop, etc.); Internet browsers (Netscape Communicator, Microsoft Internet Explorer, etc.). For details on using graphics applications, refer to their manuals.
- If you want to process images, be sure to download them to your computer first. Depending on the software, image files may be destroyed if the images are processed (rotated, etc.) while they are on the card.

Connecting cable (provided)

When connecting the camera to your computer, be sure to use the provided cable. Never remove the core attached to the cable.

- USB cable
- IEEE1394 cable [Core (RFI filter): ZCAT2035-0930 TDK]

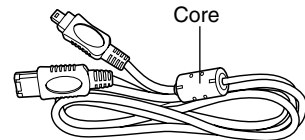

IEEE1394 cable

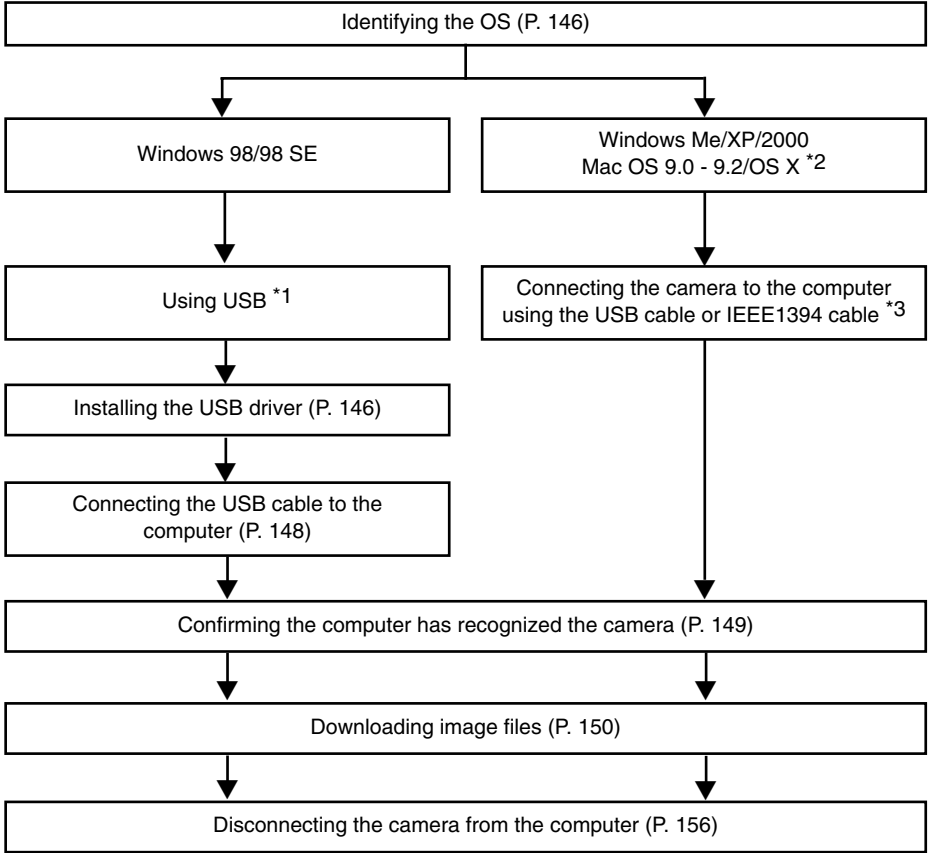

*1 Even if your computer has a USB connector or IEEE1394 connector, data transfer may not function correctly if you are using one of the operating systems listed below or if you have an add-on USB connector or IEEE1394 connector (extension card, etc.).

- Windows 95/NT 4.0
- Windows 98/98 SE upgrade from Windows 95
- Mac OS 8.6 or lower
- Data transfer is not guaranteed on a home-built PC system or PCs with no factory installed OS.

*2 IEEE1394 functionality is assured on Macintosh computers using Mac OS 9.1 - 9.2 or Mac OS X.

*3 The provided IEEE1394 cable has one end with 4 pins to be connected to the camera and the other end with 6 pins to be connected to the port on the computer.

Note

- When connecting the camera to the computer, make sure that there is sufficient remaining battery power. Since the camera does not enter the sleep mode when connected (transmitting) to the computer, the camera may stop operating if battery power runs low. This could cause the computer to malfunction, and any image data (file) being transmitted may be lost. Use the optional AC adapter when downloading files.
- To avoid computer malfunctions, do not turn off the camera when the camera is connected to a computer.
- If the camera is connected to the computer via an IEEE1394 or USB hub, operation may not be stable if there are any compatibility problems between the computer and the hub. In such cases, do not use the hub and connect the camera directly to the computer instead.

Identifying the OS

Identify the OS on your computer before connecting the camera. How to identify the OS depends on the computer.

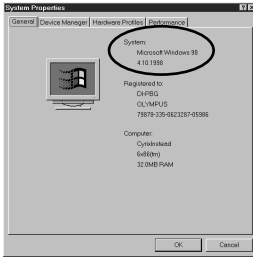

Windows

To confirm, open the System Properties window in the Control Panel.



Mac OS (Macintosh)

To confirm, open [About This Computer] or [About This Mac] from the Apple menu on the menu bar.

If your OS is Windows 98/98 SE, install the USB driver for Windows 98. “Installing the USB driver for Windows 98” (refer to the instruction below)

Users running Windows Me/2000/XP and users running Mac OS 9/X “Connecting the camera to your computer using the cable” (P. 148)

Users running other OS need to use a PC card adapter (optional).

Installing the USB driver for Windows 98 (When using Windows 98/98 SE)

If you connect to the computer using the USB cable, you will need to install the USB driver in your computer. Once it has been installed, this procedure will not need to be repeated.

- 1 Insert the provided software CD into your CD-ROM drive.
- 2 The Olympus Windows Installer should automatically launch. Click [USB Driver for Windows 98].

If the USB driver is already installed in your computer, this option will not appear.

- This option will not appear if you are using Windows Me/2000/XP.
- If the installer is not automatically launched, select [Run...] on the [Start] menu and then execute [(drive letter):/ setup.exe].
- The drive letter of the CD-ROM varies depending on the computer. To identify the drive letter, double-click [My Computer] on the desktop.

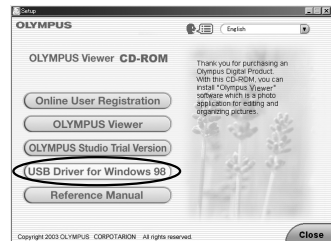

Screen illustrations may differ to those displayed on your computer.

- 3** Click [Continue].
- The installation of the USB driver will start.



- 4** Click [OK] to restart your computer and the installation is complete.



- 5** When the computer has restarted, installation is complete. If the Olympus Windows Installer screen appears, click [Close] and remove the CD-ROM from the CD-ROM drive.

Connecting the camera to your computer using the cable

Connecting the camera to your computer requires the use of the USB cable or IEEE 1394 cable. The camera's PC MODE should be set beforehand to STORAGE.

☞ "PC MODE" (P. 133)

1 Insert the cable into the port on your computer.

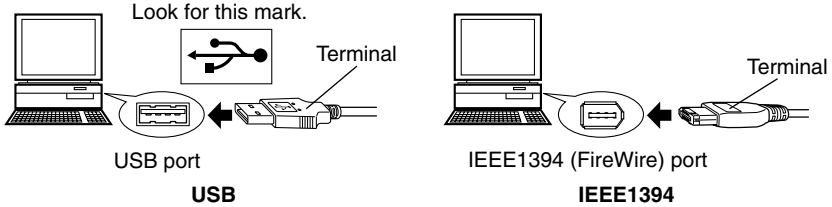

Note

- Do not connect both the USB cable and IEEE1394 cable to the camera at the same time.

2 Make sure that the power switch is set to **OFF**, then insert the cable into the connector on the camera.

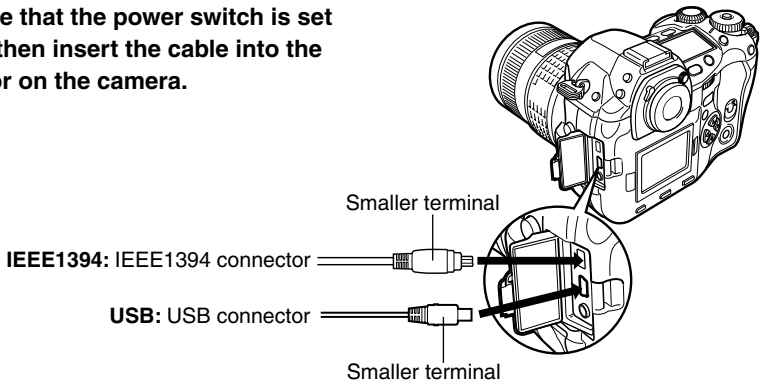

3 Set the camera's power switch to **ON**.

- Nothing is displayed on the control panel of the camera while it is being connected to the computer.

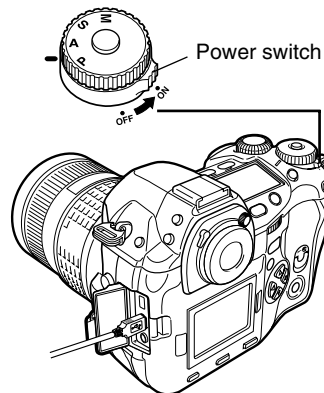

4 The computer recognizes the camera as a new device.

• Windows 98/98 SE/Me/2000

When you connect the camera to the computer for the first time, the computer automatically recognizes the camera. Click [OK] when the message saying that the installation is completed appears. The computer recognizes the camera as a [Removable Disk].

• Windows XP

You can download image files from the camera easily. Select [Copy pictures to folder on my computer using Microsoft Scanner and Camera Wizard], then follow the on-screen instructions. You may also select [take no action] to bypass the Microsoft Scanner and Camera Wizard. You may then use the image-management software provided. For detailed instructions on downloading, refer to the software user's manual.

• Mac OS 9

The [Untitled] icon appears on the desktop. If you cannot find this icon, turn off the camera and connect again.

• Mac OS X

The Apple Image Capture software automatically launches. The [NO_NAME] icon appears on the desktop.

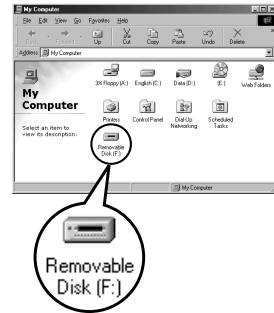
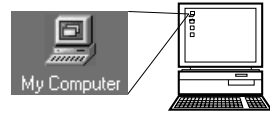

Downloading image files to your computer

Download image files to your computer using the software provided with your computer's OS.

Windows 98/98 SE/Me/2000/XP

1 Double-click the [My Computer] icon on the desktop.

- For users running Windows XP, click [My Computer] from the [Start] menu.

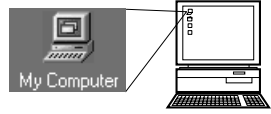

2 Double-click the [Removable Disk] icon.

- If the computer recognizes the camera correctly, the [Removable Disk] icon will appear on the desktop.



3 Double-click the [Dcim] folder.



4 Double-click the [100olymp] folder.

- Image file (JPEG files) with files names such as [P1010001.jpg] are displayed.

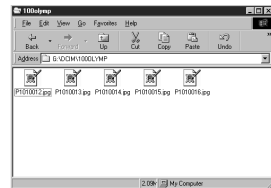

5 Double-click the [My Documents] icon on the desktop.

- If you cannot find this icon, select [Explorer] to display the [Explorer] window on the [Start] menu, then double-click the [My Documents] icon.
- The [My Documents] window is displayed.

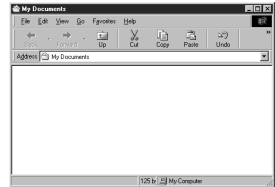
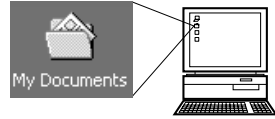

6 Drag and drop the image you want to save in the computer (in this case, P1010012.jpg) to the [My Documents] window.

- The image is saved in the computer (in My Documents folder).

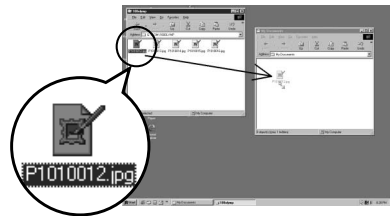

Viewing the image files

When the image file has been downloaded to the computer, you can copy the image to any valid drive or folder on your computer' system, or you can view by double-clicking. The files will be opened in the default image viewer of the operating system. If you want to view the image a different size or process it, you will need to open the image with a graphics application that supports JPEG or TIFF images files, such as Paint Shop Pro, Photoshop.

TIPS

An error message appears when you double-click the [Removable Disk] icon.

→ There may be a problem with the camera's power source (the AC adapter is not properly connected or the battery power is low).

Check whether the AC adapter is properly connected, or the level of remaining battery power.

→ There is no card in the camera or there is a problem with the card.

Check that you can playback pictures on the monitor of the camera.

After recognizing the camera, the computer creates an icon in the [Explorer] window.

However, this icon cannot be opened.

→ The camera's PC MODE has been set to CONTROL.

Disconnect the camera from the computer, and check the PC mode.

Note

- The card access lamp on the camera blinks while the image is being downloaded. Never open the card cover on the camera, load or remove the battery, or connect or disconnect the AC adapter while the lamp is blinking as the image data may be destroyed.

Macintosh

You can download images from the camera and save them in your computer (in this case, in the Hard Disk).

1 Double-click the [untitled] (or [NO_NAME]) icon displayed on the desktop when the camera is connected to the computer.

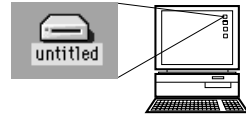

2 Double-click the [DCIM] folder.

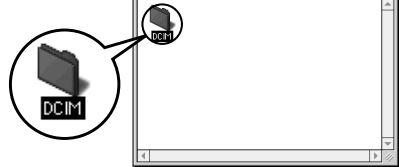

3 Double-click the [100OLYMP] folder.

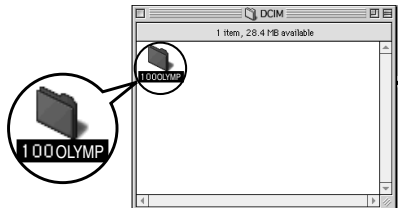

- Image file (JPEG files) with files names such as [P1010001.jpg] are displayed.

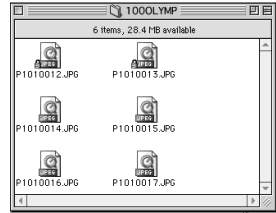

4 Double-click the [Macintosh HD] icon on the desktop.

- The [Hard Disk] window is displayed.

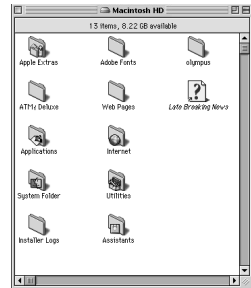
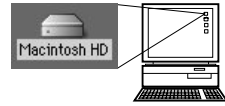

5 Drag and drop the image you want to save in the computer (in this case, P1010012.jpg) to the [Hard Disk] window.

- The image is saved in the computer (in the Hard disk).



Viewing the image files

When the image file has been downloaded to the computer, you can view by double-clicking the image files in the [Hard Disk] folder. The files will be opened in the default image viewer of the operating system. If you want to view the image a different size or process it, you will need to open the image with a graphics application that supports the JPEG or TIFF file format.

TIPS

You cannot find the [untitled] (or [NO_NAME]) icon, or an error message appears when you double-click the icon.

- There may be a problem with the camera's power source (the AC adapter is not properly connected or the battery power is low).
- There is no card in the camera or there is a problem with the card.
Check that you can playback pictures on the monitor of the camera.
- The USB cable is not properly connected between the camera and the computer.

Note

- The card access lamp blinks while the image is being downloaded. Never open the card cover on the camera, load or remove the battery, or connect or disconnect the AC adapter while the lamp is blinking as the image files may be destroyed.

■ Mac OS X

When the computer has recognized the camera, the Apple Image Capture software dialog appears.

- 1 From the [Download To] menu, select a destination folder.

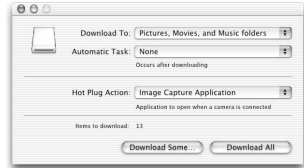

- 2 To download all images, click [Download All]. To selectively download images, click [Download Some] and highlight the desired images.

- The images are transferred from the camera to your computer.

TIPS

To download images using the same procedure as for Mac OS 9:

- Select [File > Close] and exit the Apple Image Capture software. At this time, the camera is indicated as [NO_NAME].

Note

- If you use the Apple Image Capture software, images downloaded to your computer and transferred back to a card may not playback on the camera or may have other problems.

Disconnecting the camera from your computer

- 1 Make sure that the card access lamp goes out.

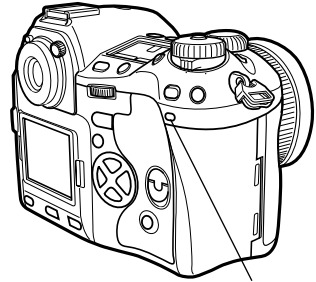

Card access lamp

2 Windows 98:

- 1 Double-click the [My Computer] icon and right-click the [Removable Disk] to display the menu.
- 2 Click [Eject] on the menu.



Windows Me/2000/XP:

- 1 In the System Tray, single-click the Remove Hardware icon.
- 2 Single-click on the message [Stop USB Mass Storage Device]. (with USB connection)
- 3 Click [OK] on the window [USB Mass Storage Device can now be safely removed from the system].

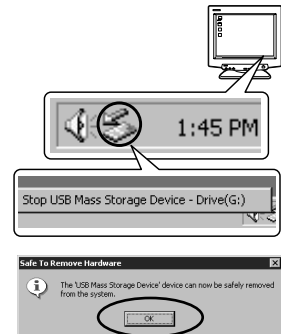

Macintosh:

Drag the [untitled] (or [NO_NAME]) icon on the desktop to [Trash].

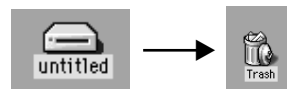

3 Remove the USB cable or IEEE1394 cable from the camera.

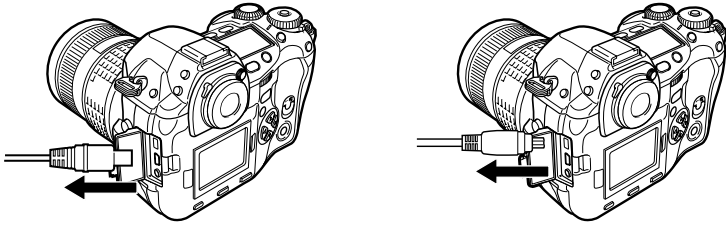

4 Remove the USB cable or IEEE1394 cable from your computer.

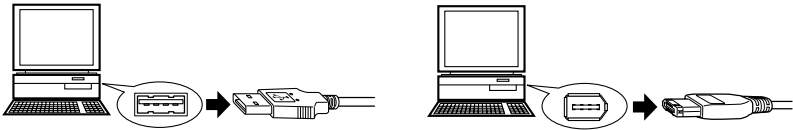









Note





- Windows Me/2000/XP: When you click [Unplug or Eject Hardware], the window may return the following message. In such case, make sure that no image data is being downloaded from the camera, and that there are no applications open that were accessing the camera image files. Close any such applications and click [Unplug or Eject Hardware] again and then remove the cable.



12 Miscellaneous

Error codes

Viewfinder indications	Control panel indications (blinking)	Monitor indications	Possible cause	Corrective action
Normal indication	- - -	 NO CARD	The card is not inserted, or it cannot be recognized.	Insert a card or insert a different card.
	- E -	 CARD ERROR	There is a problem with the card.	Insert the card again. If the problem persists, format the card. If the card cannot be formatted, it cannot be used.
	- P -	 WRITE PROTECT	Writing to the card is prohibited.	The card has been set to read-only setting with the computer. Reset the card with the computer.
No indication		 CARD FULL	The card is full and you cannot continue shooting.	Replace the card or erase unwanted pictures. Before erasing, download important images to a PC.
No indication	No indication	 CARD FULL	The card is full. No more pictures can be taken or no more information such as print reservation can be recorded.	Replace the card or erase unwanted pictures. Before erasing, download important images to a PC.
No indication	No indication	 NO PICTURE	There are no pictures on the card.	The card contains no pictures. Record pictures.

Viewfinder indications	Control panel indications (blinking)	Monitor indications	Possible cause	Corrective action
No indication	No indication	 PICTURE ERROR	The selected picture cannot be displayed for playback due to a problem with this picture. Or the picture cannot be used for playback on this camera.	Use image processing software to view the picture on a PC. If that cannot be done, the image file is damaged.
	-O-	 CARD-COVER OPEN	The card cover is open.	Close the card cover.
	-F-	 CARD ERROR	The card is not formatted.	Format the card.
No indication	-H-	No indication	Camera interior has overheated.	Switch the camera off and allow it to cool, and then switch the camera on again.

● Starting operation

The camera does not turn on or function buttons do not respond.		
Possible cause	Corrective action	Ref. Page
The power is off.	Set the power switch to ON .	P. 26
The camera enters the sleep mode.	Press the shutter button halfway.	P. 130
The remaining power level of the battery is low.	Charge the battery.	P. 17
The battery is temporarily unable to function because of the cold.	Warm the battery by putting it in your pocket for a while.	–
The camera is connected to a PC.	The camera will not operate in the STORAGE mode while it is connected to a PC. The optional OLYMPUS Studio software is required in the CONTROL mode.	P. 133

● Shooting

No picture is taken when the shutter button is pressed.		
Possible cause	Corrective action	Ref. Page
The battery is low.	Charge the battery.	P. 17
Subjects are difficult to focus on (AF do not work properly).	Take a picture using MF (manual focus) or focus lock.	P. 49, 54
Pictures are being recorded to the card.	During sequential shooting, no pictures can be taken when the camera's memory is full. Wait until the sequential shot indication on the control panel and viewfinder is greater than 0.	P. 73
The flash is charging (if the flash is being used).	When RELEASE PRIORITY is set to OFF, no pictures can be taken while the flash is charging in the fill-in flash mode. Wait until charging is complete before taking a picture.	P. 99
The card is full.	Insert a new card or erase unwanted pictures.	P. 23, 115

No picture is taken when the shutter button is pressed.		
Possible cause	Corrective action	Ref. Page
The battery ran out of power during shooting or while the images were being written to the card. (Only the battery check indicator on the control panel blinks.)	Charge the battery. (If images are being recorded, wait until charging is complete.)	P. 17
There is a problem with the card.	Refer to the "Error codes".	P. 158

The viewfinder display is not clear.		
Possible cause	Corrective action	Ref. Page
The diopter is not adjusted.	Adjust the diopter so that the AF frame is clearly visible.	P. 27
Stray light enters through the lens.	Use a sunshade.	–
Stray light enters through the viewfinder.	Use the optional eyecup.	P. 27
There is condensation* in the lens or viewfinder.	Turn off the camera's power and wait until the camera is dry. The camera will dry out as it gets accustomed to the environmental temperature.	–

*Condensation: When it is cold outside, the water vapor in the air is rapidly cooled and turns to droplets of water. Condensation occurs when the camera is suddenly taken from a cold place into a warm room.

The date recorded with the image data is wrong.		
Possible cause	Corrective action	Ref. Page
The date/time is not set.	Set the date/time. The clock adjustment is not factory-preset.	P. 132
The camera was left for a long period with the battery removed.	If the camera is left for a long period with the battery removed, the stored date/time setting will be canceled. Set the date/time again.	P. 132

Turning the camera's power off does not reset the stored settings.		
Possible cause	Corrective action	Ref. Page
This camera retains the saved settings after the camera's power is turned off.	Turning the camera's power off does not reset the saved settings. Reset the camera to clear the saved settings.	P. 118

The picture is out of focus.		
Possible cause	Corrective action	Ref. Page
The subject is too close.	Move back to the closest focusing distance for the lens and take the picture.	–
Subjects are difficult to focus on (AF does not work properly).	Take the picture using MF (manual focus) or focus lock.	P. 49, 54
The subject is dark.	Set AF ILLUMINATOR to ON in the menu.	P. 55
There is condensation* in the lens or viewfinder.	Turn off the camera's power and wait until the camera is dry.	–

*Condensation: When it is cold outside, the water vapor in the air is rapidly cooled and turns to droplets of water. Condensation occurs when the camera is suddenly taken from a cold place into a warm room.

● Playing back pictures

The picture is blurred.		
Possible cause	Corrective action	Ref. Page
The camera moved when the shutter button was pressed.	Camera vibrations will result in a blurred picture. Hold the camera correctly and press the shutter button gently. When a telephoto lens is used, special care is needed.	P. 28
ISO is set to auto in a dark environment.	The camera is more likely to move with slower shutter speeds. Use the flash or set a higher ISO sensitivity. The use of a tripod is also recommended.	P. 83, 98
RELEASE PRIORITY S or RELEASE PRIORITY C is set to ON.	The RELEASE PRIORITY S & RELEASE PRIORITY C functions on this camera allow you to release the shutter at exactly the right moment. However, when RELEASE PRIORITY S or RELEASE PRIORITY C is set to ON, the shutter will be released even if the subject is not in focus. Make sure that RELEASE PRIORITY S or RELEASE PRIORITY C is set to OFF or the AF confirmation mark lights on the viewfinder before pressing the button all the way.	P. 54
The focus mode is set to MF.	Take the picture at the point where the AF correct mark lights up when you are turning the focus ring. Or set the focus mode to the AF mode with the focus mode lever set to S or C.	P. 51

The picture is too bright.		
Possible cause	Corrective action	Ref. Page
There was something dark in the center of the image.	When there is something dark in the center of the image, the edges of the image will be brighter regardless of the metering system. Adjust the exposure toward –.	P. 65
The ISO setting is high.	Set ISO to auto or 100. If there is no improvement, use an ND filter.	P. 83
A low aperture value is set in the A (M) mode.	Increase the aperture value. Or set the exposure mode to the P mode.	P. 57, 59
A slow shutter speed is set in the S (M) mode.	Increase the shutter speed. Or set the exposure mode to the P mode.	P. 57, 61

The picture is too dark.		
Possible cause	Corrective action	Ref. Page
The subject was too small and was backlit.	Set the metering system to spot metering. Or use the flash.	P. 68, 99
There was something bright in the center of the image.	When there is something bright in the center of the image, the whole image will be darker regardless of the metering system. Adjust the exposure toward +.	P. 65
A high aperture value is set in the A (M) mode.	Decrease the aperture value. Or set the exposure mode to the P mode.	P. 57, 59
A fast shutter speed is set in the S (M) mode.	Reduce the shutter speed. Or set the exposure mode to the P mode.	P. 57, 59

The colors of pictures taken indoors look unnatural.		
Possible cause	Corrective action	Ref. Page
Indoor lighting affected the picture's colors.	Set the appropriate white balance for the lighting. More natural-looking colors can be reproduced with the one-touch white balance.	P. 85
The white balance setting is wrong.	Set the appropriate white balance for the lighting again.	P. 85

The picture has obscured edge(s).		
Possible cause	Corrective action	Ref. Page
There is dust on the CCD.	Operate the dust reduction function to clean the CCD.	P. 170

Halation produces unnatural colors in the picture.

Possible cause	Corrective action	Ref. Page
This may be caused by excessively bright ultraviolet light on the subject, such as sunlight shining through the leaves or trees, window frames in bright light at night, reflection of metal in direct sunlight, etc.	<ul style="list-style-type: none"> ● Use a UV filter. As this may upset the overall color balance, it should only be used in the conditions described on the left. ● Process the picture using a graphics application that supports JPEG (Paint Shop Pro, Photoshop, etc.). For example, after picking up unnatural colors with a syringe tool, etc. , you can select color areas, and try color conversion or saturation adjustment. For details, refer to the manual for the graphics application you are using. 	—

The top left part of the picture appears too bright.

Possible cause	Corrective action	Ref. Page
When shooting at slow shutter speeds, noise may be generated due to a rise in temperature in the CCD drive circuit.	Set NOISE REDUCTION to ON before taking pictures.	P. 95

● **Playback**

Pictures cannot be played back on the monitor.

Possible cause	Corrective action	Ref. Page
Pictures are not stored on the card.	NO PICTURE appears on the monitor. Record pictures.	P. 47
The card error occurs.	Refer to "Error codes".	P. 158

No picture is displayed on the TV when connected to the camera.

Possible cause	Corrective action	Ref. Page
The video cable is not connected correctly.	Connect the cable properly according to the instructions.	P. 112
The camera's video output signal is incorrect.	Set the video signal according to the region where used.	P. 131
The TV 's video signal is incorrect.	Set the TV to the video input mode.	—

The monitor is hard to see.		
Possible cause	Corrective action	Ref. Page
The brightness is not adjusted properly.	Adjust the brightness of the monitor using the menu.	P. 129
The monitor is exposed to direct sunlight.	Block the sunlight with your hand.	–
The monitor cover is attached to the camera.	A monitor cover is attached to this camera to protect the monitor. Remove the monitor cover when the picture is hard to see, or when you want to check picture details.	P. 27

● **Connecting the camera to a PC**

The computer does not recognize the camera correctly.		
Possible cause	Corrective action	Ref. Page
The camera's power is turned off.	Set the power switch to ON .	P. 26
The USB driver was not successfully installed.	If your OS is Windows 98/98 SE, install the USB driver again.	P. 146
The camera's PC MODE is set to CONTROL.	When PC MODE is set to CONTROL, images cannot be downloaded with an application (Microsoft Internet Explorer, etc.) on a computer. Set PC MODE to STORAGE.	P. 133

● Shooting Menu

Menu	Function	Setting	Ref. Page	
📷	CARD SETUP	ALL ERASE	ERASE, NO	P. 130
		FORMAT		
	SATURATION	CS	CS0, CS1, CS2, CS3, CS4	P. 94
		CM1, CM2, CM3, CM4		
	CONTRAST	-2 - 0 - +2	P. 93	
	SHARPNESS	-3 - 0 - +3	P. 92	
	COLOR SPACE	sRGB, Adobe RGB	P. 97	
	WB BKT	OFF, 3F 2STEP	P. 72	
		3F 4STEP, 3F 6STEP		
	RAW+JPEG	OFF, ON	P. 82	
	NOISE FILTER	OFF, ON	P. 95	
	NOISE REDUCTION	OFF, ON	P. 95	
	SHADING COMP.	OFF, ON	P. 97	
	AF ILLUMINATOR	OFF, ON	P. 55	
ANTI-SHOCK	OFF, 1sec - 30sec	P. 78		
PIXEL MAPPING		P. 170		
🔍	-2 - 0 - +2	P. 104		

● Playback Menu

Menu	Function	Setting	Ref. Page
▶	📄	📄1, 📄4, 📄9, 📄16	P. 111
		OFF, ON	P. 111
	RAW DATA EDIT		P. 113
	📄	📄, 📄, 📄	P. 135

: Factory default setting

● Custom Menu

Menu	Function	Setting	Ref. Page	
1	EV STEP	1/3EV, 1/2EV, 1EV	P. 125	
	ISO BOOST	OFF, ON	P. 84	
	WB %	AUTO	BLUE7 - ±0 - RED7	P. 90
			3000K	
			3300K	
			3600K	
			3900K	
			4000K	
			4300K	
			4500K	
			4800K	
			5300K	
	6000K			
	6600K			
	7500K			
SQ		1600 x 1200	1/2.7, 1/8 P. 81	
		1280 x 960		
		1024 x 768		
		640 x 480		
AEL/AFL	S-AF	mode1 - mode5	P. 122	
	C-AF	mode6, mode7		
	MF	mode1 - mode5		
DIAL	P	Ps Ps	P. 126	
		Ps		☒
		☒		Ps
	A	F.No.	F.No.	
		F.No.	☒	
		☒	F.No.	
	S	SHUTTER	SHUTTER	
		SHUTTER	☒	
		☒	SHUTTER	

☐ : Factory default setting

● Custom Menu

Menu	Function	Setting	Ref. Page
11	FOCUS RING	⌚, ↻	P. 127
	S-AF+MF	OFF, ON	P. 52
	RELEASE PRIORITY S	OFF, ON	P. 54
	RELEASE PRIORITY C	OFF, ON	P. 54
	RESET LENS	OFF, ON	P. 127
	PC MODE	STORAGE, CONTROL	P. 133
	ERASE SETTING	YES, NO	P. 127
	CLEANING MODE		P. 171
	CUSTOM RESET SETTING	RESET 1 RESET 2 RESET 3 RESET 4	SET, CLEAR

● Setup Menu

Menu	Function	Setting	Ref. Page
12		⊕	P. 132
	FILE NAME	RESET, AUTO	P. 128
	REC VIEW	OFF, AUTO, 5sec, 20sec	P. 129
	🔊	OFF, ON	P. 129
	📷	-7 - 0 - +7	P. 129
	SLEEP	OFF, 1min, 3min, 5min, 10min	P. 130
	🗣️ *	日本語, ENGLISH, FRANCAIS, DEUTSCH, ESPAÑOL, 한국어	P. 131
	VIDEO OUT*	NTSC, PAL	P. 131

⊕ : Factory default setting

* The factory default setting varies depending on the area where you purchased this camera.

■ Cleaning the camera

Turn off the camera and remove the battery before cleaning the camera.

Exterior:

- Wipe gently with a soft cloth. If the camera is very dirty, soak the cloth in mild soapy water and wring well. Wipe the camera with the damp cloth and then dry it with a dry cloth. If you have used the camera at the beach, use a cloth soaked in clean water and well wrung.

Monitor and viewfinder:

- Wipe gently with a soft cloth.

Lens, mirror and focusing screen:

- Blow dust off the lens, mirror and focusing screen with a commercially available blower. For the lens, wipe gently with a lens cleaning paper. Do not use a high-pressure bottled blower. If high-pressure gas is sprayed onto the lens, mirror, or focusing screen by non-authorized service persons, the camera will be damaged.

■ Camera maintenance

If you have not used the camera for a long time, remove the battery and store it in a well-ventilated, cool and dry place.

Cleaning and Checking the CCD

This camera incorporates a dust reduction function to keep dust from getting on the CCD and to remove any dust or dirt from the CCD surface with ultrasonic vibrations. Dust reduction works when the power switch is set to ON. This function also operates whenever PIXEL MAPPING is activated.



Since dust reduction is activated every time the camera's power is turned on, the camera should be held upright for the dust reduction function to be effective.

Note

- Do not use strong solvents such as benzene or alcohol, or chemically treated cloth.
- Avoid storing the camera in places where chemicals are treated, in order to protect the camera from corrosion.
- Mold may form on the lens surface if the lens is left dirty.
- Check each part of the camera before use if it has not been used for a long time. Before taking important pictures, be sure to take a test shot and check that the camera works properly.

PIXEL MAPPING and dust reduction

The PIXEL MAPPING feature allows the camera to check and adjust the CCD and image processing functions. It is not necessary to operate this function frequently. Approximately once a year is recommended. After using the monitor or taking continuous shots, wait for at least one minute before using the PIXEL MAPPING function to ensure that it operates correctly. Dust reduction also works at the same time to remove dust on the CCD.

- 1 In the menu, select  → **PIXEL MAPPING**, and press .
 “How to use the menus” (P. 38)

- 2 Press **OK** button.
 - The busy bar is displayed during PIXEL MAPPING. When PIXEL MAPPING is finished, the menu is restored.

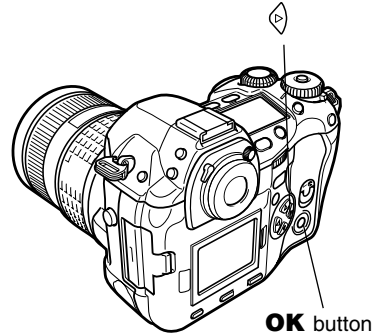

Note

- If you accidentally turn the camera off during PIXEL MAPPING, start again from Step 1.
- The following matter is not removed with the dust reduction function:
 - Sticky matter (solvent, etc.)
 - Lightweight particles such as cotton dust
 - Microscopic dust particles not visible to the naked eye

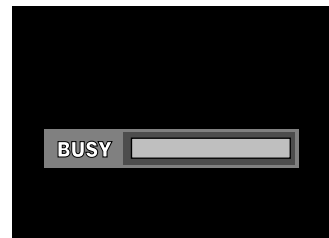
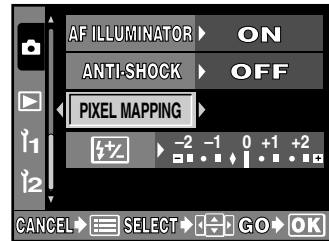

CLEANING MODE

The dust reduction function will remove most dirt or dust on the CCD. However, when dust or dirt is not removed completely, black dots may appear in the picture. If this happens, contact your Olympus Authorized Service Center to have the CCD physical cleaned. The CCD is a precision device and is easily damaged. When cleaning the CCD on your own, be sure to follow the instructions below.

When cleaning the CCD, the specified AC adapter should be used (P. 21). If a battery is used and power runs out during cleaning, the shutter will close, which may cause the shutter curtain and mirror to break.

- 1 Remove the lens from the camera.**
- 2 Set the power switch to **ON**.**
- 3 In the menu, select $\mathcal{I}1 \rightarrow$ **CLEANING MODE**, and press \mathcal{D} .**
 ☞ “How to use the menus” (P. 38)
- 4 Press the **OK** button.**
 - The camera enters the cleaning mode.
- 5 Press the shutter button fully.**
 - The mirror goes up and the shutter curtain opens.
- 6 Clean the CCD.**
 - Carefully blow off any dust on the surface of the CCD by using a mechanical blower (commercially available).
- 7 Be careful not to catch the mechanical blower in the shutter curtain when turning the power off to finish cleaning.**
 - If the camera turns off, the shutter curtain closes, causing the mirror to fall.

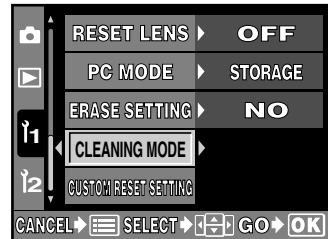
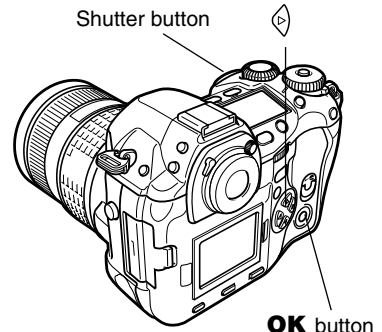

Note

- Be careful to not let the mechanical blower (commercially available) touch the CCD. If the blower touches the CCD, the CCD will be damaged.
- Never put the mechanical blower behind the lens mount. If the power turns off, the shutter closes, breaking the shutter curtain.
- Do not use anything other than the mechanical blower. If high-pressure gas is sprayed onto the CCD, it will freeze on the CCD's surface, damaging the CCD.

■ Product type

Product type	: Single-lens reflex digital camera with interchangeable lens system
Lens	: Zuiko Digital, Four Thirds System Lens
Lens mount	: Four Thirds Mount
Equivalent focal length on a 35 mm film camera:	: Approx. twice the focal length of the lens

■ Image pickup element

Product type	: 4/3 type full frame transfer primary color CCD
Total no. of pixels	: Approx. 5,500,000 pixels
No. of effective pixels	: Approx. 5,000,000 pixels
Screen size	: 17.3 mm (H) x 13.0 mm (V) (0.9" x 0.5")
Aspect ratio	: 1.33 (4 : 3)

■ Viewfinder

Product type	: Eye-level single-lens reflex viewfinder
Field of view	: Approx. 100% (for field of view on recorded images)
Viewfinder magnification	: 0.96x (-1 m^{-1} , 50mm lens, infinity)
Eye point	: 20 mm (0.8") (-1 m^{-1})
Diopter adjustment range	: $-3.0 - +1.0 \text{ m}^{-1}$
Optical path fraction	: Quick return half mirror
Depth of field	: To be checked with the preview button
Focusing screen	: Interchangeable
Eyecup	: Interchangeable

■ Monitor

Product type	: 1.8" TFT color LCD
Total no. of pixels	: Approx. 134,000 pixels

■ Shutter

Product type	: Computerized focal-plane shutter
Shutter	: 1/4000 - 60 sec. (1/3, 1/2, or 1 EV step) Manual mode: Bulb (Limit: 8 min.)

■ Autofocus

Product type	: TTL phase-contrast detection system
Focusing point	: 3-point multiple AF (left, center, right)
AF luminance range	: EV 0 - EV 19 (at ISO 100, 20°C)
Selection of focusing point	: Auto, Optional
AF illuminator	: Built-in Effective distance for AF illuminator: Approx. 0.7 - 6.0 m (2.3 - 19.7 ft.) (ED 50 mm F2.0 Macro)

■ Exposure control

- Metering system : TTL full-aperture metering system
 (1) Digital ESP metering
 (2) Center weighted average metering
 (3) Spot metering (approx. 2% for the viewfinder screen)
- Metering range : (1) EV 1 - 20 (Digital ESP metering, Center weighted average metering)
 (2) EV 3 - 17 (Spot metering)
 (At normal temperature, 50 mm F2, ISO 100)
- Exposure mode : (1) P: Program AE (Program shift can be performed)
 (2) A: Aperture priority AE
 (3) S: Shutter priority AE
 (4) M: Manual
- ISO sensitivity : 100 - 800 (High ISO values (1600 and 3200) are available)
- Exposure compensation : Exposure can be adjusted in 1/3, 1/2 or 1 EV step within a range of ± 5 EV.

■ White balance

- Product type : CCD and white balance sensor
- Mode setting : Auto, Preset WB (12 settings), One-touch WB
 (4 settings can be registered)

■ Recording

- Memory : CF card (Compatible with Type I and II)
 Microdrive compatible (Compatible with FAT 32)
- Recording format : DCF, DPOF compatible/Exif 2.2 compatible, PRINT Image Matching II compatible
- Recording mode : RAW (12 bits), TIFF (RGB), JPEG

■ Playback

- Playback mode : Single-frame playback, Close-up playback, Index display, Picture rotation
- Information display : Information display, Histogram display, Highlight display

■ Drive

- Drive mode : Single-frame shooting, Sequential shooting, Self-timer, Remote control
- Sequential shooting : 3 frames/sec. (Max. no. of storable sequential pictures: 12 frames)
 *Applied to all record modes.
- Self-timer : Operation time: 12 sec., 2 sec.
- Optical remote control : Operation time: 2 sec., 0 sec. (instantaneous shooting)

■ Flash

- Synchronization : Synchronized with the camera at 1/180 sec. or less
- Flash control mode : TTL-AUTO (TTL pre-flash mode), AUTO, MANUAL
- Flash attachment : Hot shoe, External flash connector (x attachment)

■ External connector

USB connector (mini-B), IEEE1394 connector, DC-IN jack, VIDEO OUT jack, Remote cable connector

■ Dust/drip proof system

Dust/drip proof sealing use, Supersonic wave filter (dust reduction function included as standard)

■ Power supply

Battery : BLM-1 Lithium-ion Battery
AC power supply : AC-1 AC adapter (optional)
Others : BLL-1 Lithium-ion Battery for Power Battery Holder Set (optional)

■ Dimensions/weight

Dimensions : 141 mm (W) x 104 mm (H) x 81 mm (D) (5.6" x 4.1" x 3.2")
(excluding protrusions)
Weight : Approx. 660 g (1.6 lb.)

■ Operating environment

Temperature : 0 - 40°C (operation)/-20 - 60°C (storage)
Humidity : 30 - 90 % (operation)/10 - 90 % (storage)

A (Aperture Priority) Mode

You set the aperture yourself and the camera automatically varies the shutter speed so that the picture is taken with the correct exposure.

AE (Automatic Exposure)

The camera's built-in exposure meter automatically sets the exposure. The 3 AE modes available on this camera are P mode, in which the camera selects both the aperture and shutter speed, A mode, in which the user selects the aperture and the camera sets the shutter speed, and S mode, in which the user selects the shutter speed and the camera sets the aperture.

In M mode, the user selects both the aperture and the shutter speed.

Aperture

The adjustable lens opening which controls the amount of light that enters the camera. The larger the aperture, the shorter the depth of field and the fuzzier the background. The smaller the aperture, the greater the depth of field and the sharper the background. Aperture is measured in f/stops. Larger aperture values indicate smaller apertures, and smaller aperture values indicate larger apertures.

CCD (Charge-Coupled Device)

This converts light passing through the lens into electrical signals. On this camera, light is picked up and converted into RGB signals to build a single image.

Center weighted averaging metering

A light metering mode or technique that uses an average of the center and periphery of the image area but is biased toward the information at the center of the image area. This method is best used when the brightness of the center and periphery of the image area does not vary greatly. See also digital ESP metering and spot metering.

Color space

A model that describes colors using more than three coordinates. Color spaces such as sRGB, Adobe RGB are occasionally used for encoding/reproducing colors.

Color temperature

The spectral balance of different white light sources is rated numerically by color temperature — a concept of theoretical physics that, with incandescent lighting, corresponds roughly to the absolute lamp filament temperature, expressed on the Kelvin (K) temperature scale. The higher the color temperature, the richer the light in bluish tones and the poorer in reddish; the lower the color temperature, the richer the light in reddish tones and the poorer in bluish. You may encounter difficulties with color reproduction when shooting indoors under fluorescent lighting, or where sunlight and fluorescent lighting are both present. Your camera is provided with a white balance adjustment feature that you can use to compensate for the odd effects of combinations of color you may occasionally see in your pictures.

Compression rate

Compression is a method of reducing file size by abbreviating some contents of data, and compression rate denotes the amount of compression. The actual effect of the selected compression rate could vary with the content of the image. The numbers for the compression rate selected with this camera provide only a general scale for reference and are not precise measurements.

Conventional Photograph

This refers to recording images using silver halide (the method for recording images in conventional, non-digital photography). This system is in contrast to still video and digital photography.

DCF (Design rule for Camera File system)

A standard for image files by the Japan Electronics and Information Technology Industries Association (JEITA).

Depth of Field

Depth of Field refers to the distance from the nearest to the furthest point of perceived "sharp" focus in a picture.

Digital ESP (Electro-Selective Pattern) Light Metering

This determines the exposure by metering and calculating the light levels in the center and other areas of the image separately.

DPOF (Digital Print Order Format)

This is for saving desired print settings on digital cameras. By entering which images to print and the number of copies of each, the user can easily have the desired images printed by a printer or print lab that supports the DPOF format.

Eclipsing (Vignetting)

This refers to when an object obscures part of the field of view so that the whole subject is not photographed. Vignetting also refers to when the image seen through the viewfinder does not exactly match the image shot through the objective lens, so the photographed image includes objects not seen through the viewfinder. In addition, vignetting can occur when an incorrect lens hood is used, causing shadowing to appear in the corners of the image.

EV (Exposure Value)

A system for measuring exposure. EV0 is when the aperture is at F1 and the shutter speed is 1 second. The EV then increases by 1 each time the aperture increases by one F stop or the shutter speed increases by one increment. EV can also be used to indicate brightness and ISO settings.

Exposure

The amount of light used to capture an image. The exposure is determined by the length of time the shutter is open (shutter speed) and the amount of light that passes through the lens (aperture).

Flash Bracket

A mount used to attach an external flash to the camera. Shadows on the subject can be changed by detaching the flash. The flash is used in combination with the flash cable.

ISO

A method for indicating film speed by the International Organization for Standardization (ISO) (e.g. "ISO100"). Higher ISO values indicate greater sensitivity to light, so images can be exposed even in low-light conditions.

JPEG (Joint Photographic Experts Group)

A compression format for color still images. Photographs (images) shot using this camera are recorded onto the card in JPEG format when the Record mode is set to SHQ, HQ, SQ. By downloading these images to a personal computer, users can edit them using graphics application software or view the images using an Internet web browser.

M (Manual) Mode

The user sets both the aperture and shutter speed.

NTSC (National Television Systems Committee) / PAL (Phase Alternating Line)

Television formats. NTSC is mainly used in Japan, North America and Korea. PAL is mainly used in Europe and China.

Number of Pixels (PIXEL COUNT)

The number of dots (pixels) used to create an image denotes the image size. For instance, an image in 640 x 480 resolution is the same size as the computer screen if the monitor setting is also 640 x 480. If the monitor setting is 1024 x 768, the image only takes up part of the screen.

P (Program) Mode

Also called Program AE mode. The camera automatically sets the best shutter speed and aperture for the shot.

Pixels

A pixel is the smallest unit (dot) used to make up an image. Clear large-sized printed images require millions of pixels.

RAW

Refers to raw data, data which has not been enhanced with a camera option like white balance, sharpness, contrast, etc. This file format is for viewing and processing with our own software. You may not be able to open or process these files with other graphics software applications, and these files cannot be selected for DPOF printing. RAW files are assigned an orf file extension (*.orf).

S (Shutter Priority) Mode

Also called Shutter Priority AE mode. The user selects the shutter speed and the camera automatically varies the aperture so that the picture is taken with the best exposure.

Single-lens reflex camera

A camera with a shooting lens working also as the viewfinder lens. The image of the subject enters through the lens, reflects off of the mirror and into the pentaprism, where focus is adjusted, then through the viewfinder lens. Pictures are taken by framing the composition and adjusting the focus in the viewfinder lens.

Sleep Mode

A mode designed to save battery life. The camera automatically enters the sleep mode if you do not operate it for a certain time. To get out of the sleep mode, use any button on the camera (shutter button, arrow pad, etc.)

Spot metering

The meter reading is taken from a very small area around the center of the subject, defined by the spot metering area mark in the viewfinder. Spot metering is ideal for use in difficult light conditions, or when the important element of the picture (subject's face) is small. Use spot metering for backlit subjects, or sports and stage performers. See also digital ESP metering and center weighted averaging metering.

Synchro Terminals

Terminals on an external flash unit for connecting it to the camera.

TIFF (Tagged Image File Format)

A format used for saving highly detailed black and white or color image data. TIFF image files can be handled by software programs for scanners and graphics applications. Non-compressed image data are stored in this format with this camera.

TFT (Thin-Film Transistor) Color Monitor

A color monitor constructed using thin-film technology.

TTL phase-contrast detection system

This is used to measure the distance to the subject. The camera determines if the image is focused by the detected phase contrast.

TTL (Through-The-Taking-Lens) System

To help adjust exposure, a light receptor built into the camera directly measures the light passing through the lens.





TTL-AUTO

For use with an external flash. Light emitted by the flash is measured by the light receptor in the camera as it passes through the lens. A signal is then sent to adjust the external flash intensity.

(AF frame selection) button	50
(Custom) menu	43
(Erase) button	10, 37, 77, 115, 116
(Exposure compensation) button.....	9, 34, 65
(Flash mode) button	9, 35, 99
(Language setting)	131
(Menu) button	10, 38
(Metering) button	9, 36, 68
(One-touch WB) button	9, 37, 89
(Playback mode) button	10, 37, 107
(Playback) menu	42
(Protect) button.....	10, 37, 114
(Record mode) button.....	9, 35, 81
(Setup) menu	45
(Shooting) menu	40
A	
AC adapter	21
Adobe RGB	97
AE lock AEL	69, 122
AE MEMO	122
AEL button.....	10, 37, 69
AEL/AFL	122
AF frame 	12, 50
AF ILLUMINATOR.....	9, 41, 55
AF lock	122
AF mode	51
All-frame reservation 	137
ANTI-SHOCK	78
Aperture priority shooting A	59
Arrow pad 	10
Auto bracketing BKT	70
Auto flash	100
Auto focus AF	47
B	
Battery compartment cover	9, 18
Battery compartment cover detaching pin....	20
Battery compartment lock	18
Beep sound 	129
BKT (Auto bracket) button	10, 35, 70
Body cap	22
Bulb shooting.....	64

C	
C (C-AF)	53
CARD SETUP	130
Card access lamp	10
Card adapter	23
Card cover.....	10, 24
Card cover lock	24
Card slot	10, 24
Center weighted averaging metering 	68
CLEANING MODE	171
Close-up playback 	108
COLOR SPACE.....	97
Compact Flash	23
Computer.....	133
Connector cover	10
CONTRAST 	40, 93
CONTROL.....	133
Control panel	9, 11
CUSTOM RESET SETTING	45, 118
D	
Date/time setting 	132
DC-IN jack	10
DIAL	126
Digital ESP metering ESP	68
Diopter adjustment dial	10, 27
DPOF	134
DRIVE button	10, 36, 73
Drive mode DRIVE	73
Dust reduction	170
E	
Eject button	24
ERASE SELECTED.....	116
ERASE SETTING	127
Erasing pictures 	115
EV STEP	125
Exposure compensation 	65
Exposure mode PASM	56
External flash connector	10, 106
Eyepiece shutter lever.....	75



F

FILE NAME	128
Fill-in flash 	102
1st curtain with red-eye reduction   SLOW	102
Flash	98
Flash intensity control 	104
Flash mode 	100
FOCUS RING	54, 127
Focus lock	49
Focus mode lever	10, 51
FORMAT	130

H

Hot shoe	9, 99
HQ	80

I

IEEE1394 (FireWire) cable	31, 148
IEEE1394 connector	10, 31, 148
Index display 	108
Index printing 	138

INFO (Information display) button 10, 37, 109

ISO BOOST

ISO button

J

JPEG

L

Lens	21
Lens attachment mark	9, 22
Lens cap	22
Lens lock pin	9
Lens release button	9, 22

LIGHT (Control panel illumination)

button

M

Main dial	9, 33
Manual focus MF	54
Manual shooting M	63
Menus 	38
MF	54
Microdrive	23
Mode dial	9, 56
Mode dial lock	9, 56

Monitor

Monitor brightness adjustment 

Monitor cover

Mount

N

NOISE FILTER 

NOISE REDUCTION 

NTSC

Number of storable sequential
pictures

Number of storable still pictures

O

OK button

One-touch white balance
 CUSTOM WB

OS

P

PAL

PC MODE

Picture rotation 

PIXEL MAPPING.

Power switch

Preset white balance 3000 - 7500 WB

Preview

Preview button

Print reservation 

Program shift **Ps**

Program shooting **P**

Protecting 

R

RAW

RAW DATA EDIT

RAW-JPEG

Rear cap

REC VIEW

Red-eye reduction flash 

RELEASE PRIORITY C









RELEASE PRIORITY S

Remote cable connector

Remote control 

Remote control receiver9, 76
 RESET LENS44, 127

S

S (S-AF)51
 S-AF+MF52
 SATURATION 94
 2nd curtain  SLOW 2nd-CURTAIN101
 Self-timer shooting 74
 Self-timer/Remote control lamp,
 AF illuminator.....9, 55
 Sequential shooting 73
 SHADING COMP. 97
 SHARPNESS 92
 SHQ.....80
 Shutter button9, 49
 Shutter priority shooting **S**.....61
 Shutter speed61, 63
 Single-frame erase115
 Single-frame reservation 135
 SLEEP130
 Slideshow 111
 Spot metering 68
 sRGB97
 STORAGE133
 Strap eyelet10, 16
 Sub dial9, 33
 Super FP flash.....104

T

Tabs38
 TIFF80
 Tripod socket9

U

USB cable31, 148
 USB connector10, 31, 148

V

VIDEO OUT.....131
 VIDEO OUT jack112
 Viewfinder10, 12

W

WB (White balance) button9, 35, 87
 WB BKT.....72
 White balance compensation 43, 90
 White balance sensor9, 85
 White balance **WB**85

OLYMPUS®

<http://www.olympus.com/>

OLYMPUS CORPORATION

Shinjuku Monolith, 3-1 Nishi-Shinjuku 2-chome, Shinjuku-ku, Tokyo 163-0914

OLYMPUS AMERICA INC.

Two Corporate Center Drive, Melville, NY 11747-3157, U.S.A. Tel. 1-631-844-5000

Technical Support (USA)

24/7 online automated help: <http://www.olympusamerica.com/E1>

Phone customer support: Tel. 1-800-260-1625 (Toll-free)

Our phone customer support is available from 8 am to 10 pm (Monday to Friday) ET

E-Mail: e-slrpro@olympusamerica.com

OLYMPUS OPTICAL CO. (EUROPA) GMBH.

Premises/Goods delivery: Wendenstrasse 14-18, 20097 Hamburg, Germany

Tel. +49 (0) 40-23 77 30/+49 (0) 40-23 77 33

Letters: Postfach 10 49 08, 20034 Hamburg, Germany

European Technical Customer Support:

Please visit our homepage <http://www.olympus-europa.com>

or call our TOLL FREE NUMBER: **00800 - 67 10 83 00**

for Austria, Belgium, Denmark, Finland, France, Germany, Italy, Luxemburg, Netherlands, Norway, Portugal, Spain, Sweden, Switzerland, United Kingdom

- Please note some (mobile) phone services/provider do not permit access or request an additional prefix to +800 numbers.

For all not listed European Countries and in case that you can't get connected to the above mentioned number please make use of the following:

CHARGED NUMBERS: +49 (0) 1805-67 10 83 or +49 (0) 40-23 77 38 99

Our Technical Customer Support is available from 9 am to 6 pm MET (Monday to Friday)