

OLYMPUS[®]

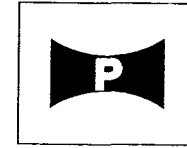

IS-300

IS-30 DLX

INSTRUCTIONS

- Before using your camera, read this manual carefully to ensure correct use.
- We recommend that you take test shots to get accustomed to your camera before taking important photographs.

BASIC
OPERATIONS

ADDITIONAL
FUNCTIONS

TAKING BETTER
PICTURES

CAMERA
MAINTENANCE



Ignoring this warning may result in the death or serious injury of the user.

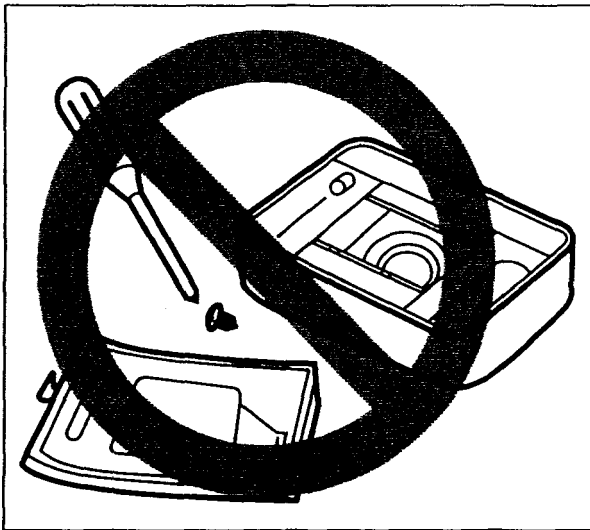

NEVER ATTEMPT TO DISASSEMBLE THE CAMERA; IT CONTAINS A HIGH-VOLTAGE CIRCUIT. IN CASE OF MALFUNCTION, CONSULT YOUR NEAREST OLYMPUS DEALER OR OLYMPUS SERVICE CENTER.



MAIN FEATURES

- Built-in 28mm~110mm approx. 4X-class zoom lens for increased shooting range.
- Powerful flash with GN 25 at maximum for telephoto needs. Increased luminance capability enables extended-distance flash photography.
- SLR lens ensures that what you see in the viewfinder is what you get on film.
- Direct Mode Select buttons let you easily set/choose the right exposure mode for any shooting purpose.
- Exposure compensation dial allows you to adjust for available light.
- Predictive autofocus helps achieve accurate focusing on moving subjects.
- Super FP Flash for synchronization as fast as 1/2,000-sec.
- Flash fires automatically to prevent fluorescent light from affecting the picture.

Symbols used in this manual:

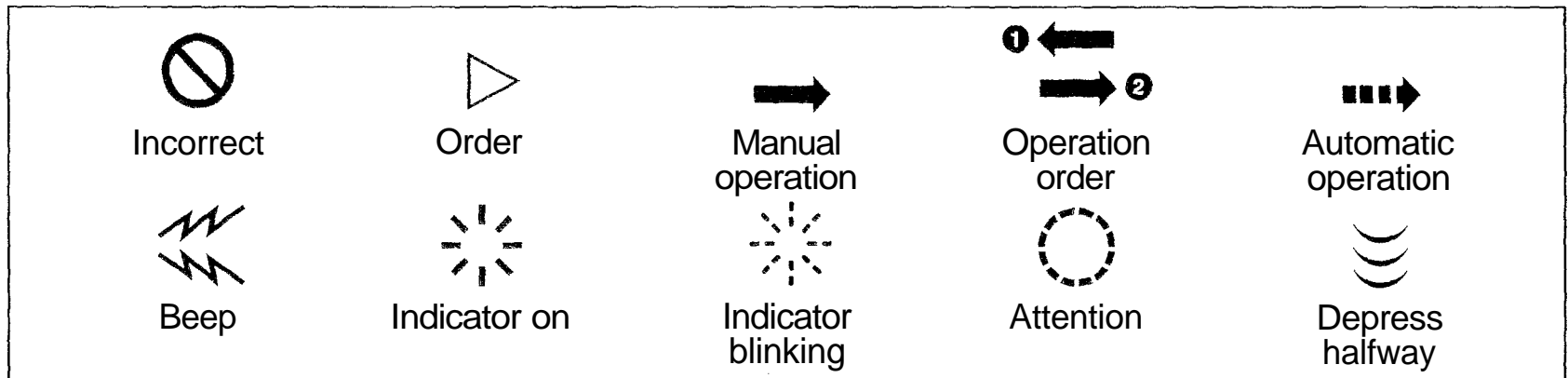

Pay particular attention to items in this manual enclosed in boxes .

Products shown in pictures and illustrations may be slightly different from the actual unit.

PREPARATIONS

Names and functions of parts	6	Outline of operations	12
Viewfinder display	8	Loading the batteries	14
LCD panel	9	Checking the batteries.....	15
Diopter adjustment	10	Points to remember	16
Using the strap/soft case*	11	Re-mounting the cap when it comes off	18

*IS-30 DLX only

BASIC OPERATIONS

Loading the film	19
Taking pictures	22
Using the focus lock	25
Unloading the film	26

ADDITIONAL FUNCTIONS

Taking panorama pictures [†]	27	Spot metering	44
Flash photography	29	Exposure compensation	46
Selftimer	35	Remote control	48
Using the exposure modes	36	Correcting the data [†]	50
Restoring the standard shooting mode ...	43	Printing the date and time [†]	51

[†] QD models only [‡] Panorama model only

TAKING BETTER PICTURES

Effects of zoom and its advantages ...	52	Film speed	58
Autofocus (AF)	54	Metering the amount of light	58
Exposure	56	Accessories (optional)	60

CAMERA MAINTENANCE

Questions and answers	61
Care and storage	62
Battery handling	64
Troubleshooting	65
Specifications	68

NAMES AND FUNCTIONS OF PARTS

PREPARATIONS

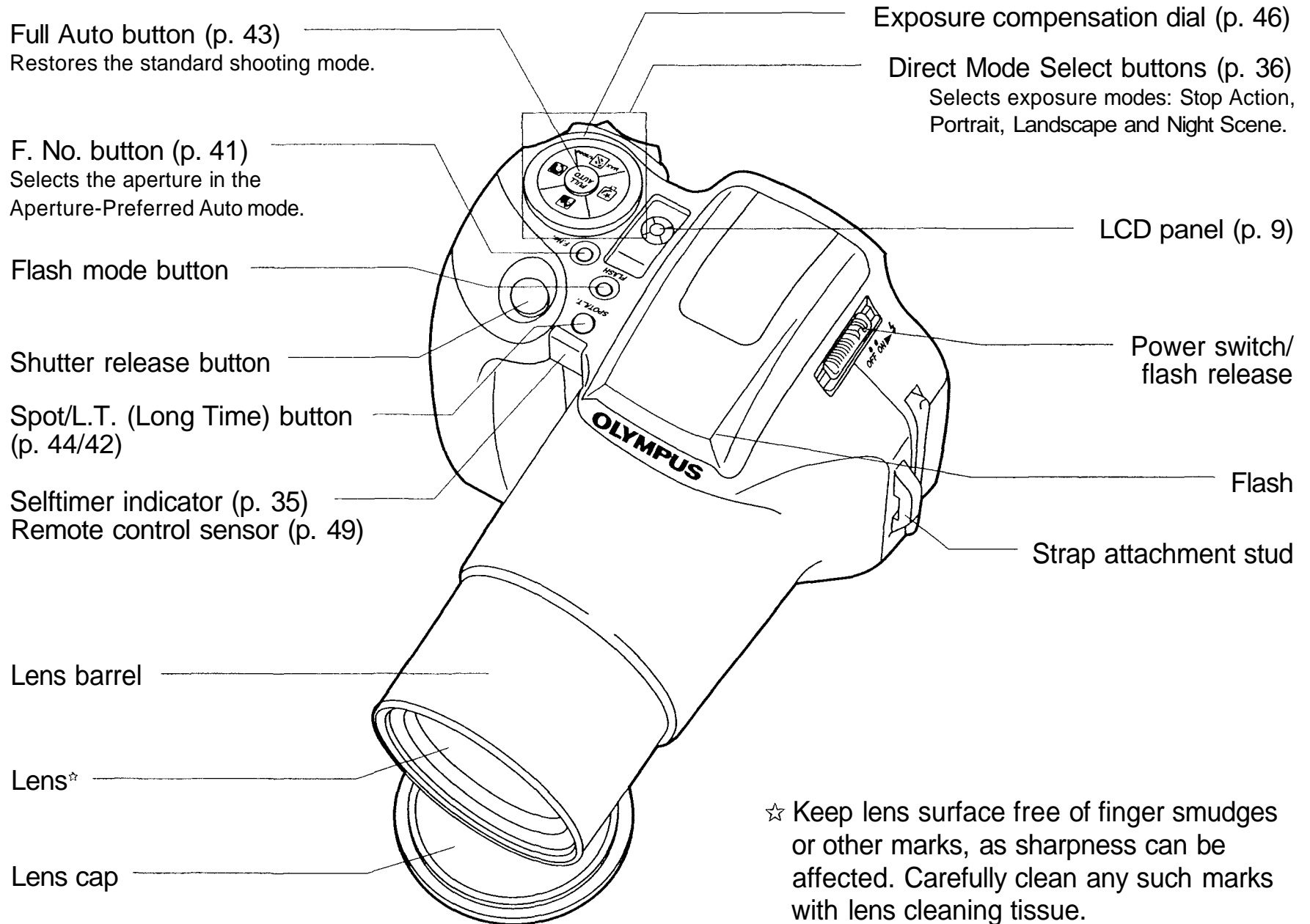

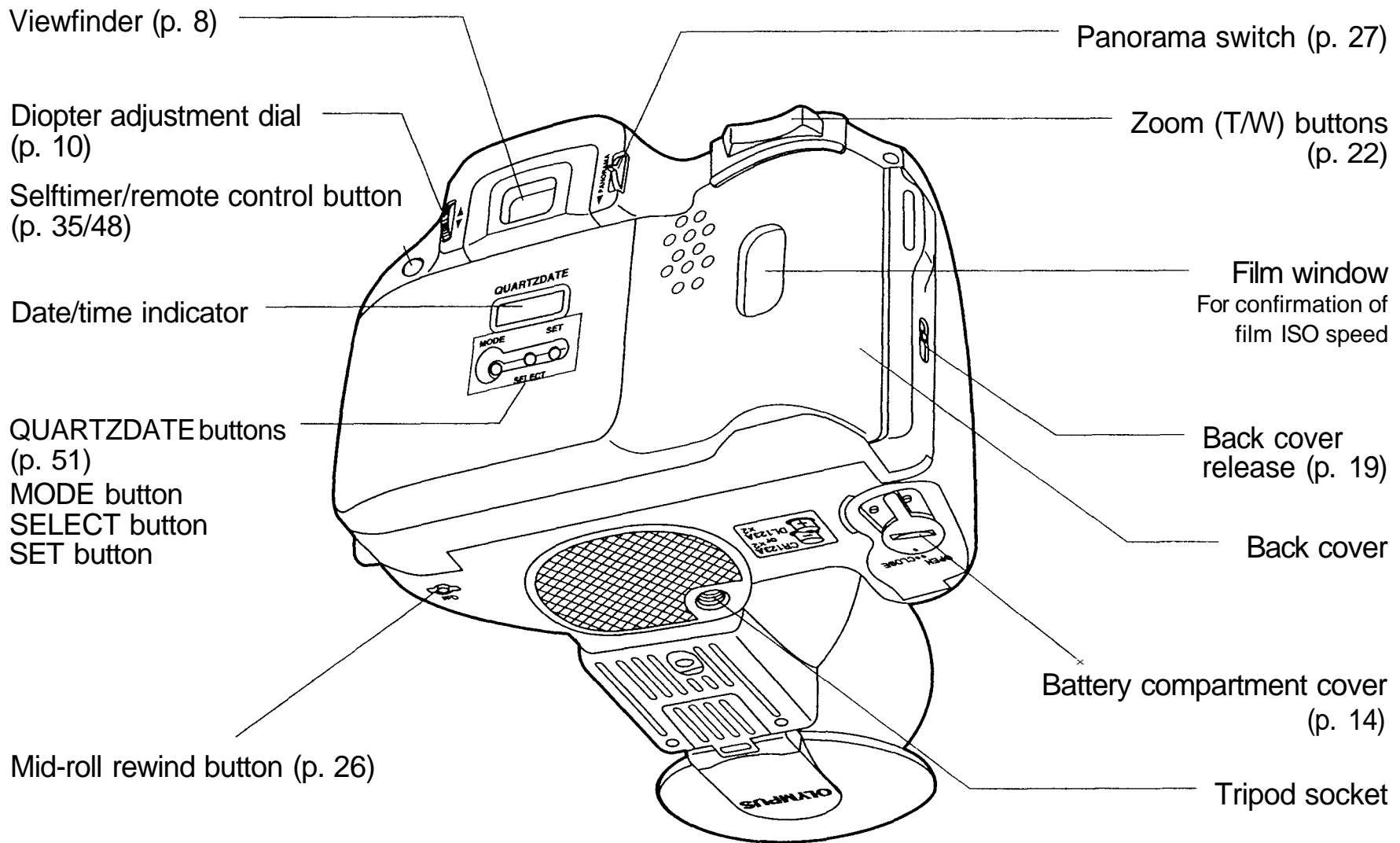

VIEWFINDER DISPLAY

Standard mode

Autofocus frame
Position your subject within the autofocus frame.

Spot frame
The area used by the Spot Metering mode to set exposure.

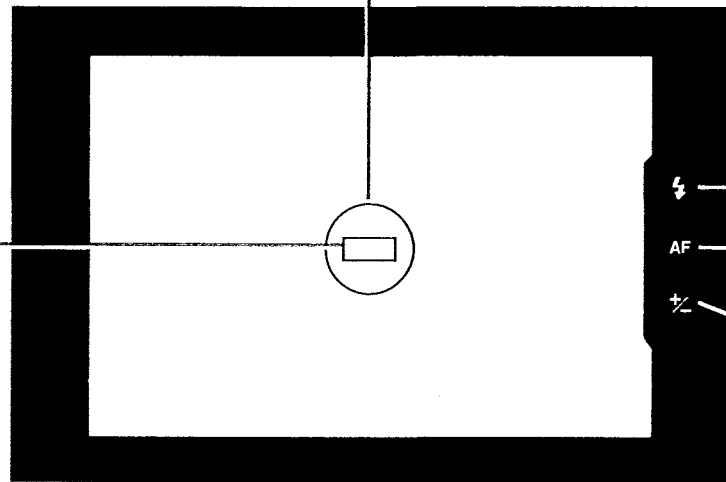

Flash (p. 30/31)

Autofocus (p. 17/24)
Lights when the subject is in focus.

Exposure compensation/
overexposure-
underexposure (p. 46&47/41)

Panorama mode

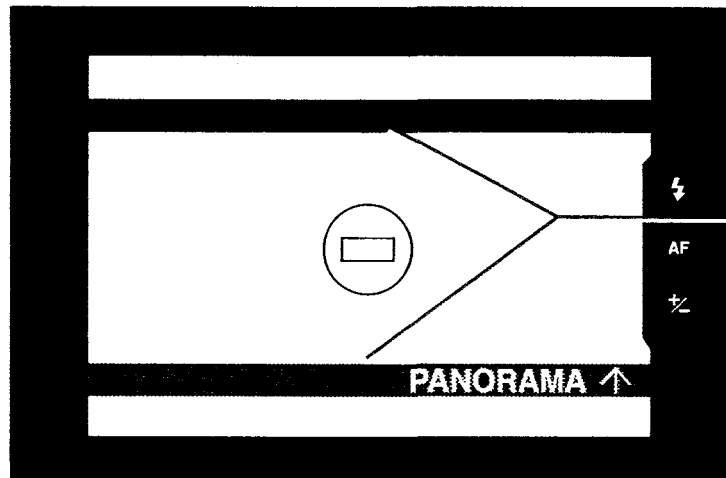

Panorama frame

LCD PANEL

Exposure counter (p. 21) Battery check (p. 15)

Flash modes (p. 29)

Selftimer/remote control
(p. 35/48)

Mode status indicator (p. 36)
Displays the mode selected for use.

Aperture setting/shutter speed
(p. 41/42)
Shutter speed shown when using the
Long Time mode.

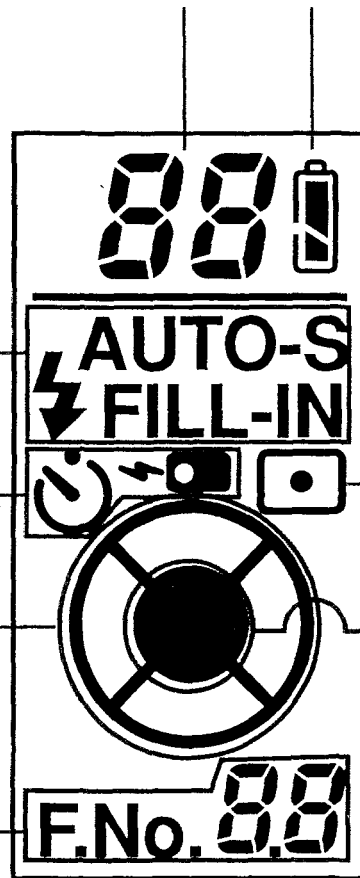

Spot Metering mode
(p. 44)

Full-Auto mode (p. 43)
The camera does everything
automatically in this mode.

Note: The LCD panel does not
actually display all indications
simultaneously as shown.

DIOPTER ADJUSTMENT

To adjust the viewfinder to compensate for near and farsighted vision.

Turn the diopter adjustment dial until the autofocus frame becomes clear.

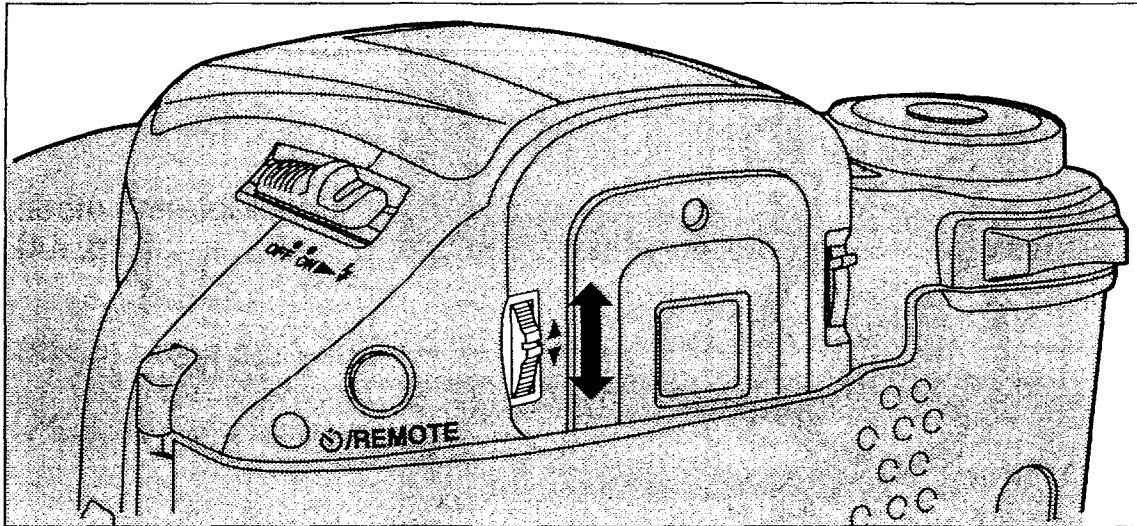

Turn up if you are nearsighted or down if you are farsighted.

USING THE STRAP/SOFT CASE

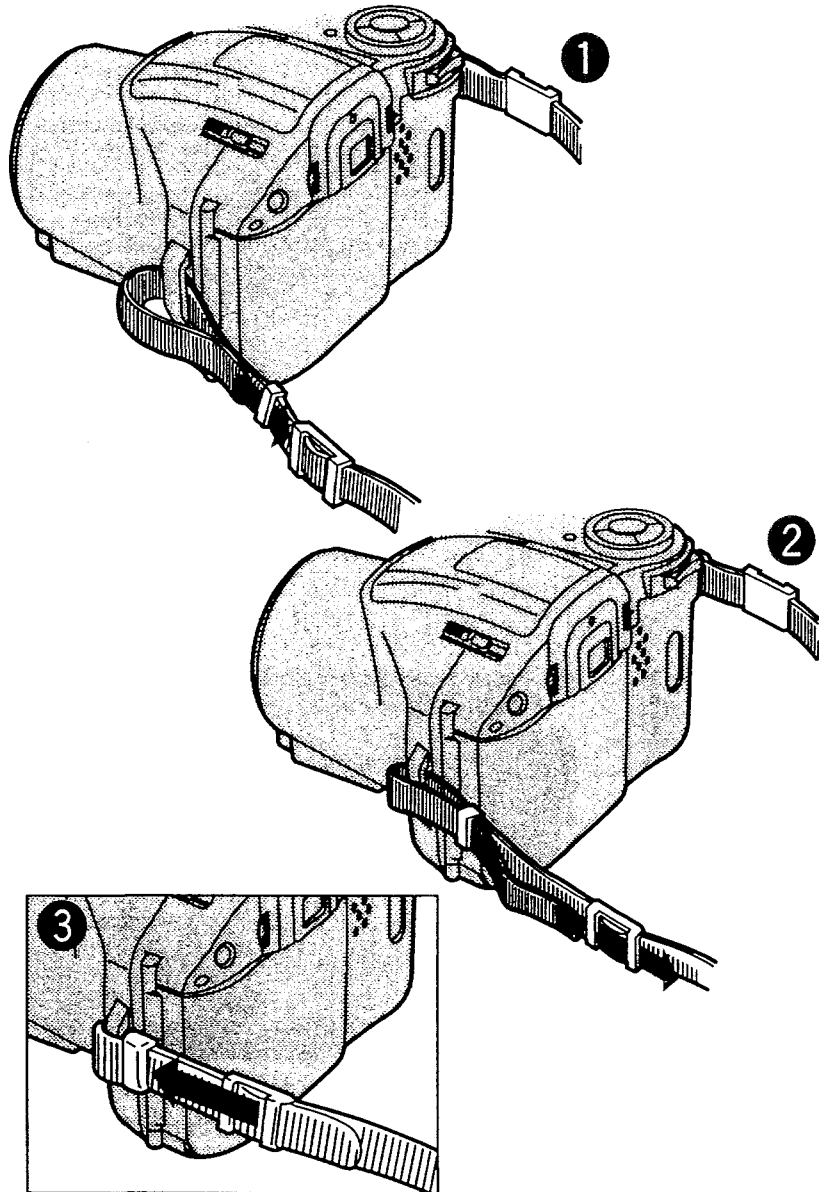

■ SOFT CASE (* IS-30 DLX only)

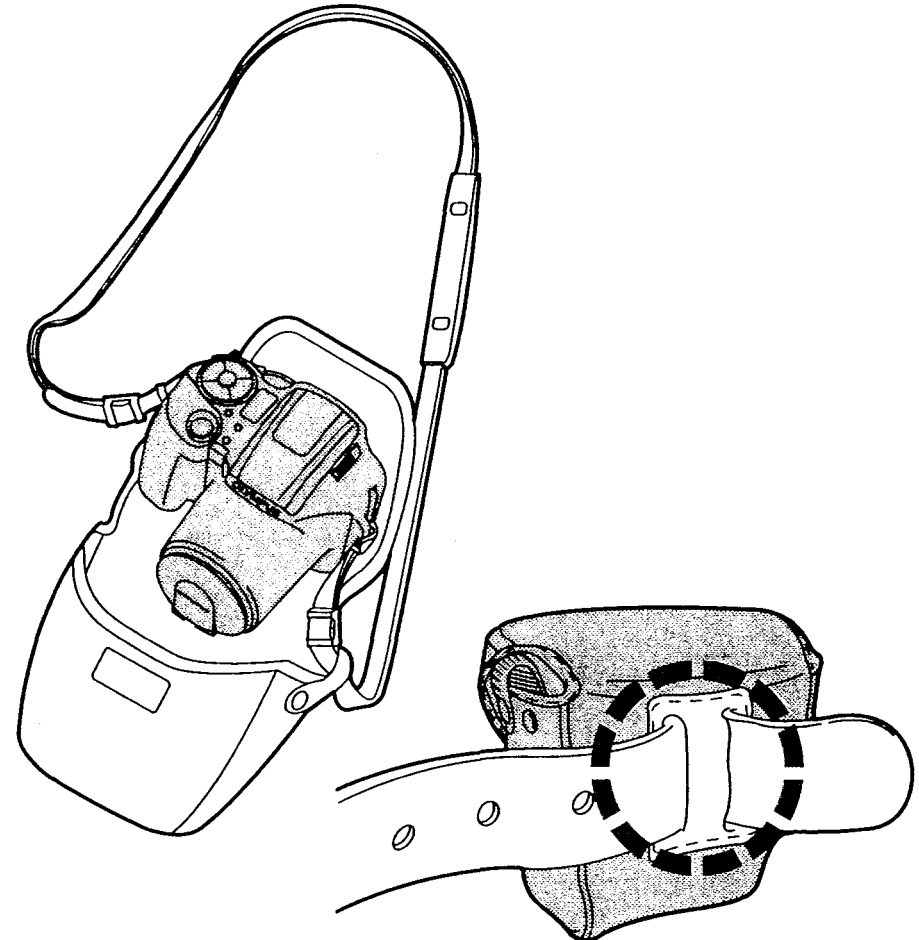

The soft case can be attached to a belt with the belt loop.

OUTLINE OF OPERATIONS

Basic Shooting Procedures

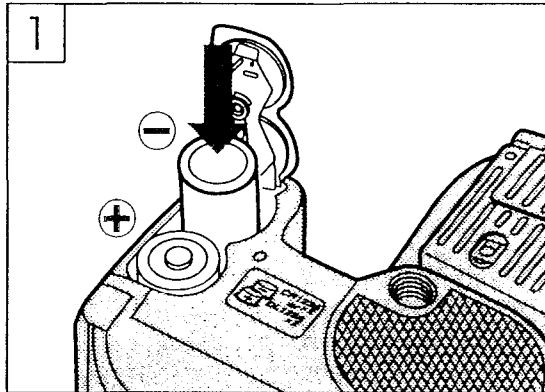

1 Load the batteries (p. 14).

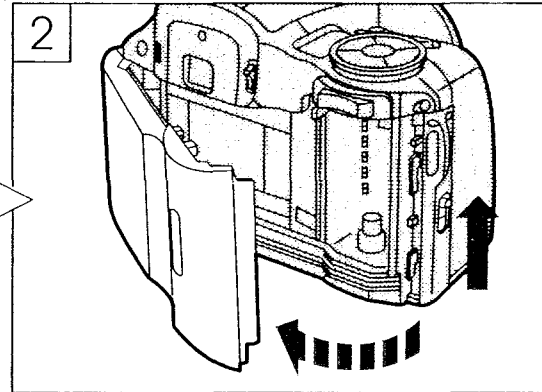

2 Open the back cover (p. 19).

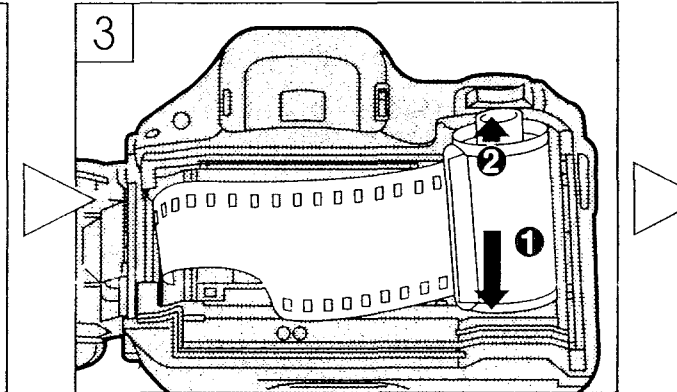

3 Load the film (p. 19).

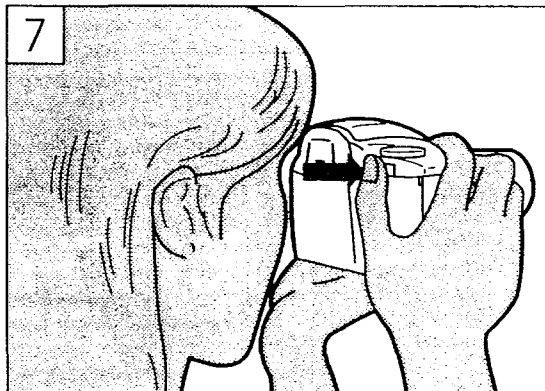

7 Press the zoom button to determine the composition (p. 22).

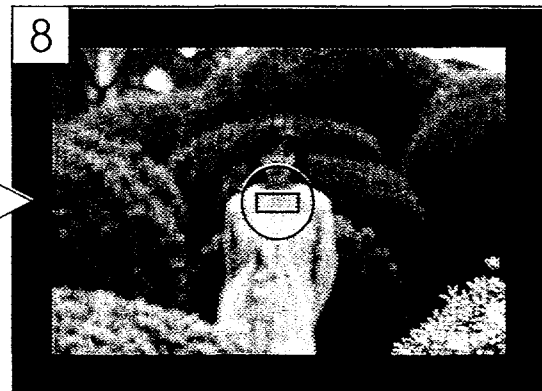

8 Place the autofocus frame on the subject you want to focus on (p. 23).



9 Depress the shutter release button halfway, making sure the green autofocus indicator in the viewfinder lights and the autofocus beep is heard (p. 24).

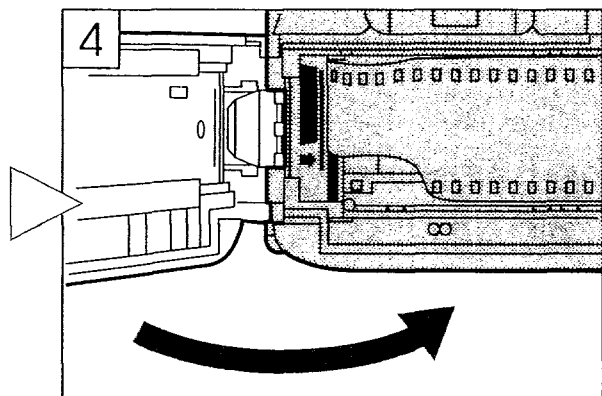

4 Close the back cover (p. 20).

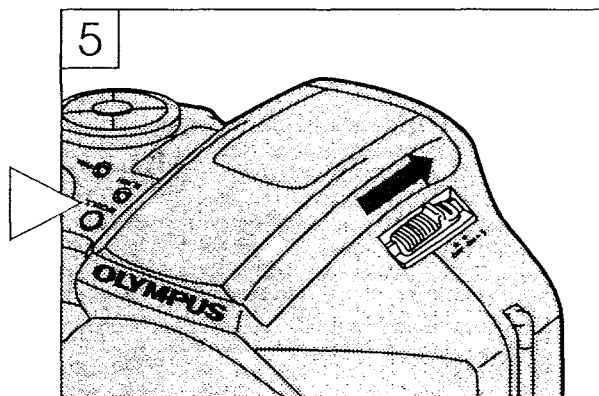

5 Turn the power switch ON (p. 21).

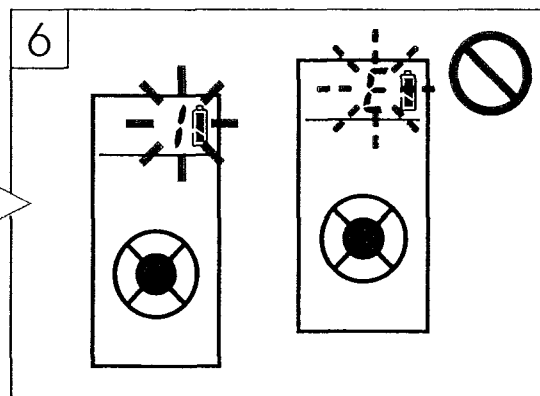

6 Make sure the exposure counter on the LCD panel reads 1 (p. 21).

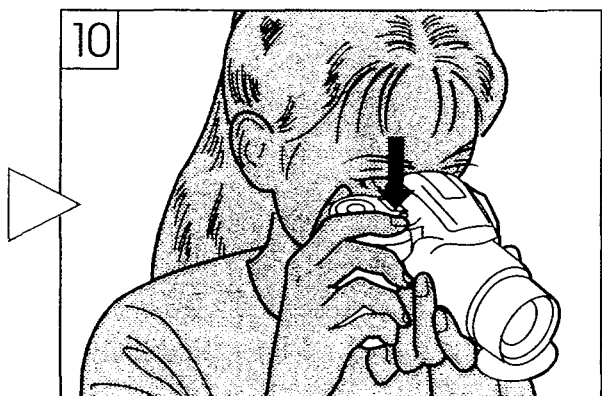

10 Depress the shutter release button fully to take a picture (p. 24).

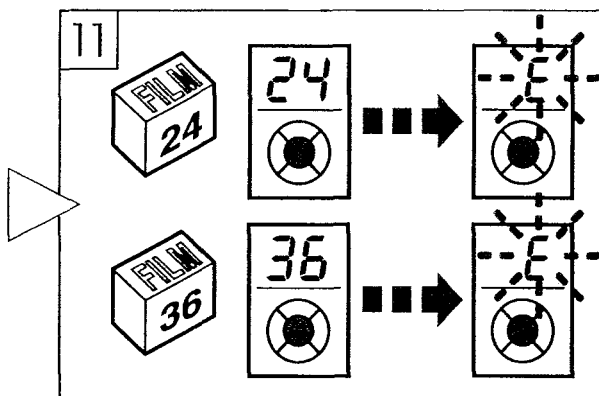

11 When the film reaches the end, it will automatically rewind (p. 26).

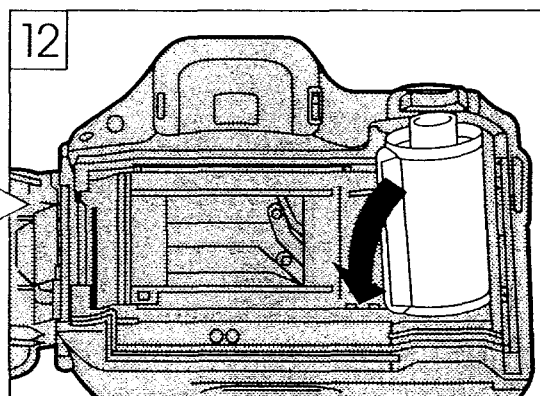

12 Open the back cover to remove the rewound film (p. 26).

LOADING THE BATTERIES

Use two 3V lithium batteries (DL123A or CR123A).

- 1.** ① Use your finger or a coin to turn the lock screw to OPEN. ② Place your fingertip in the notch. ③ And open the battery compartment cover.

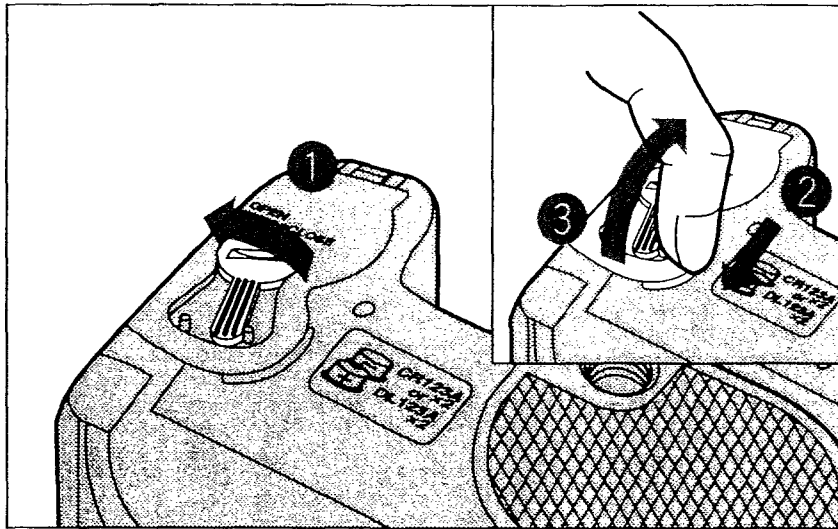

- When replacing the batteries, be sure to turn the power switch OFF before unloading the batteries.
- Take care not to injure your fingernail when opening the battery cover.

- 2.** ① Insert the batteries. ② And close the cover. ③ Turn the lock screw to CLOSE.

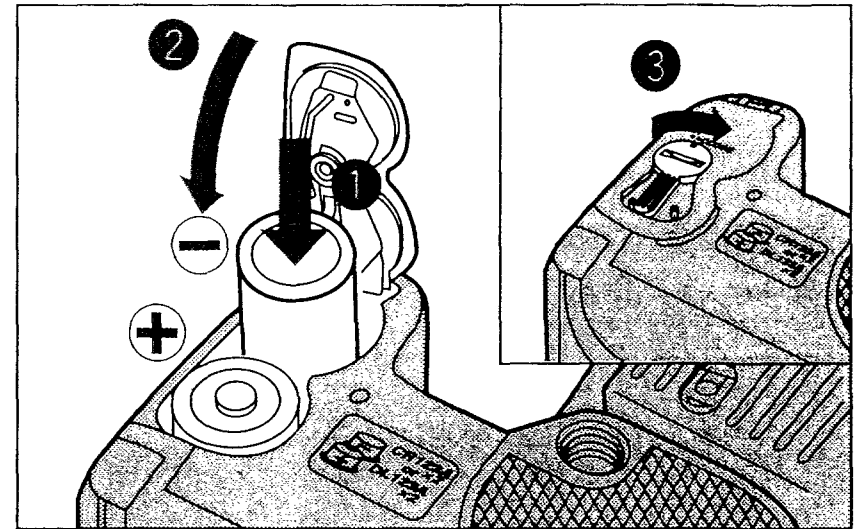

- Align the ⊕ and ⊖ directions of the batteries correctly as shown.



Read "Battery Handling" on page 64.

CHECKING THE BATTERIES

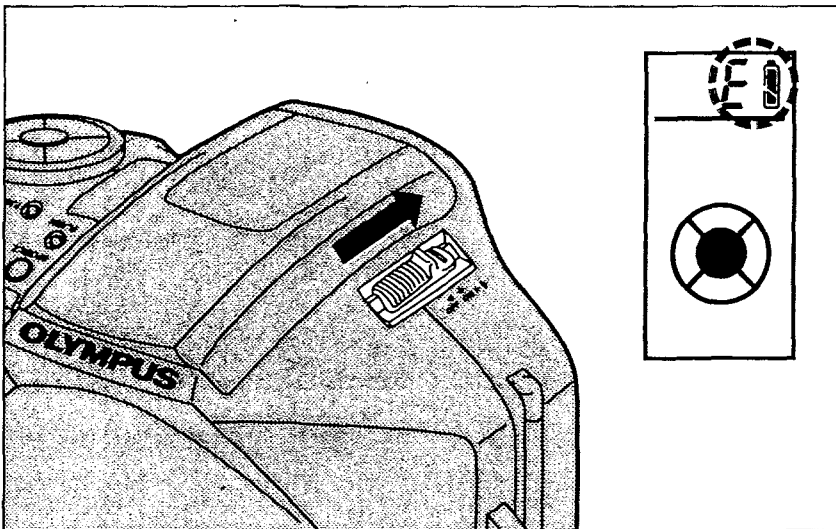
1. Turn the power switch ON. Be sure to check the batteries as well.



When replacing the batteries, make sure to turn the power switch OFF before unloading the batteries.

Display	Meaning
 lights (turns off automatically).	Batteries are OK. You can shoot.
 blinks and other indicators on the LCD panel are displayed normally.	Batteries are low and should be replaced.
 blinks and other indicators on the LCD panel go out.	Batteries are dead and should be replaced immediately.

Keep spare batteries on hand when going on a long trip or when using the camera in cold weather.

POINTS TO REMEMBER

Hold the Camera Correctly.



Correct



Correct

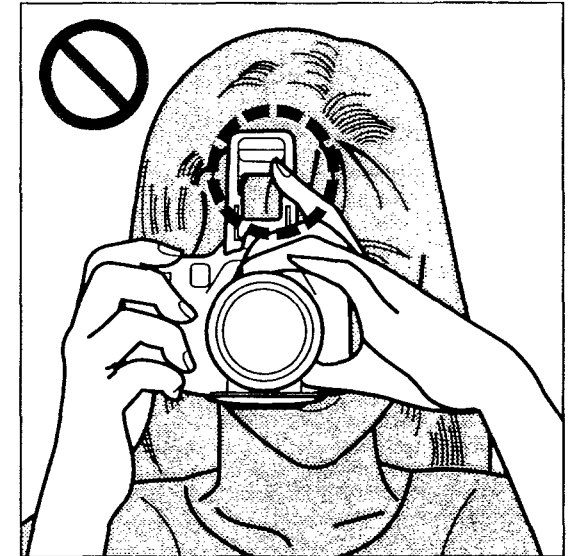

Incorrect

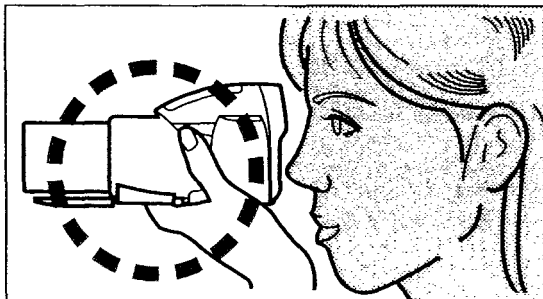

Note: As the focal length becomes larger, shaking the camera becomes more noticeable. Hold the camera firmly with both hands while keeping elbows at sides to prevent the camera from shaking.

Cautions:

- Try not to hold the lens barrel.
- Keep your fingers and the strap away from the lens and flash.

Proper Shutter Release.

The shutter release button has two clicks. Practice before loading the film.

1. Keep the shutter release button depressed halfway.

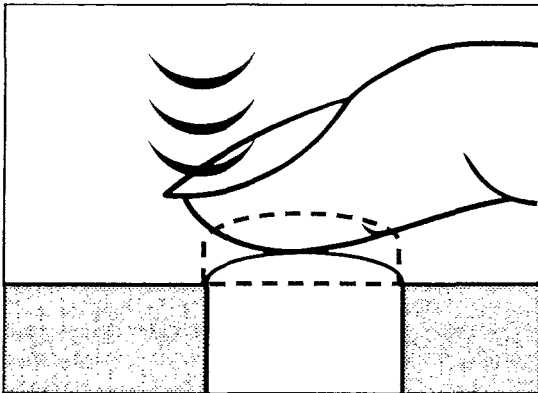

To lock the focus.

2. Depress the shutter release button fully.

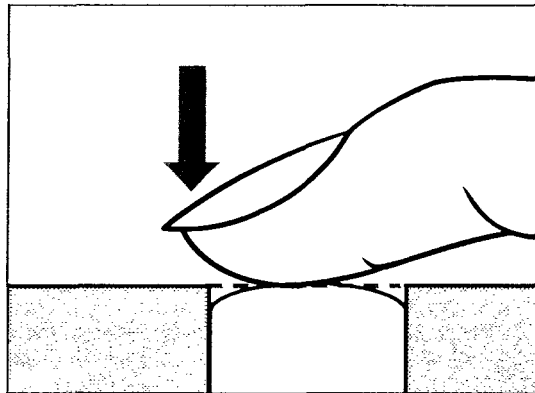

To release the shutter and take the picture.

Cautions:

- Press the shutter release button gently.
- Avoid shaking the camera when pressing the shutter release button to prevent blurry pictures.

Make sure

The image is clear, the autofocus beep is heard, and the autofocus indicator lights in the viewfinder.

Note: When the autofocus indicator is blinking, the shutter won't release. (p. 54)

RE-MOUNTING THE CAP WHEN IT COMES OFF

To prevent the hinge joint from breaking, the cap will come off if too much force is used when opening it.

(Do not attempt to remove the cap deliberately as repeated disconnection of the cap will loosen the hinge joint, increasing the likelihood that the cap will come off.)

If the cap comes off, re-mount it as instructed below.

- 1.** Turn the camera, so that the bottom is facing up.

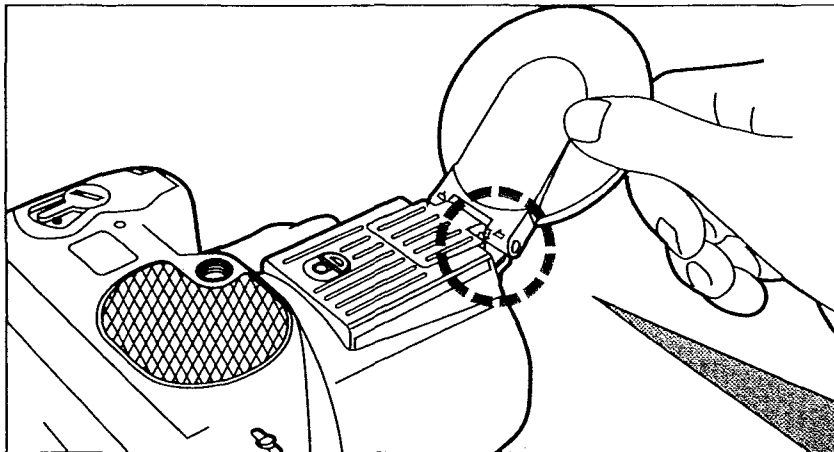

Open and close the cap to make sure the hinge joint has been engaged securely.

- 2.** Align the arrow-pointed recesses on the cap's hinge joint with the protrusions (silver parts) on the bottom tip of the lens barrel. While aligning them on both the left and right, press the cap firmly against the lens.

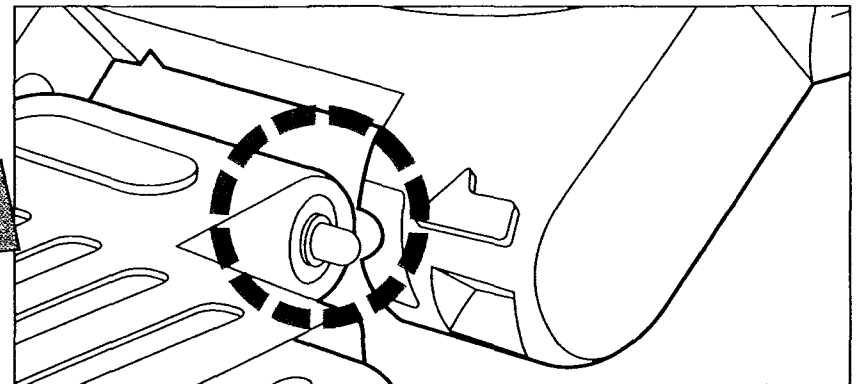

LOADING THE FILM

1. Slide the back cover release upward to open the back cover.

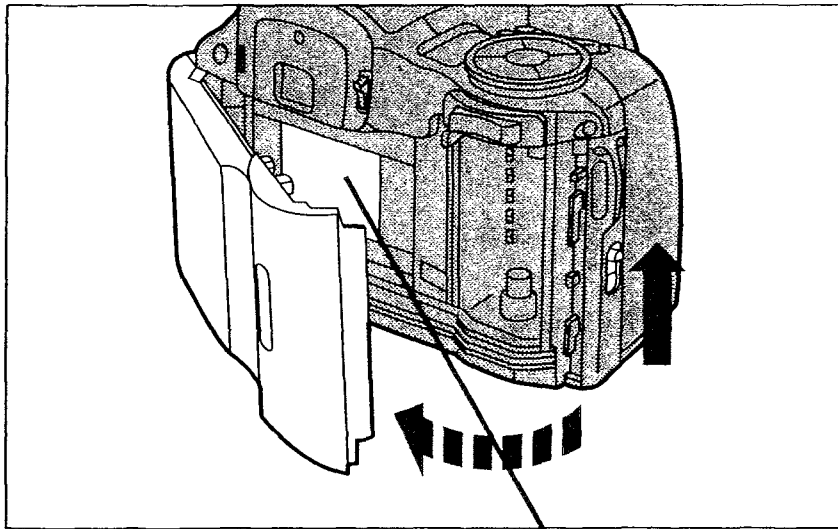

Shutter curtains

2. Load the film.

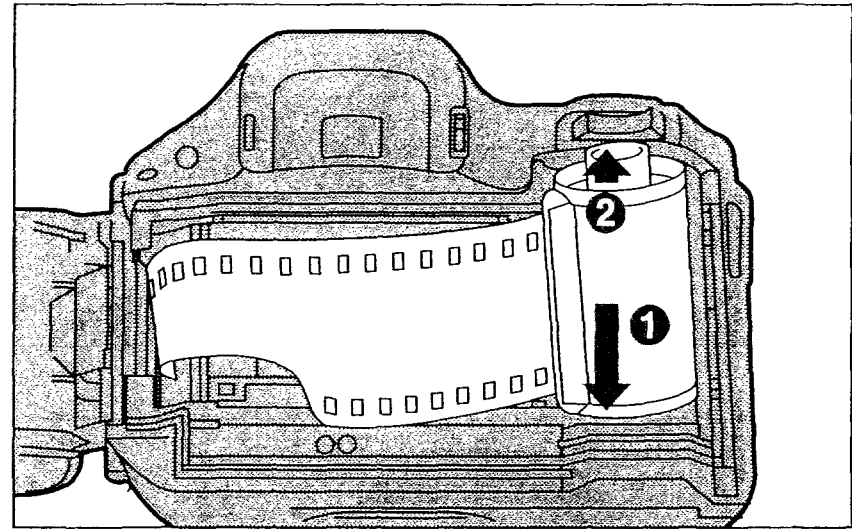

Caution: Be sure never to let anything touch the shutter curtains as they are extremely thin and have a high-precision design. Any contact with your fingers or film may damage or permanently deform the shutter curtains.

Correct

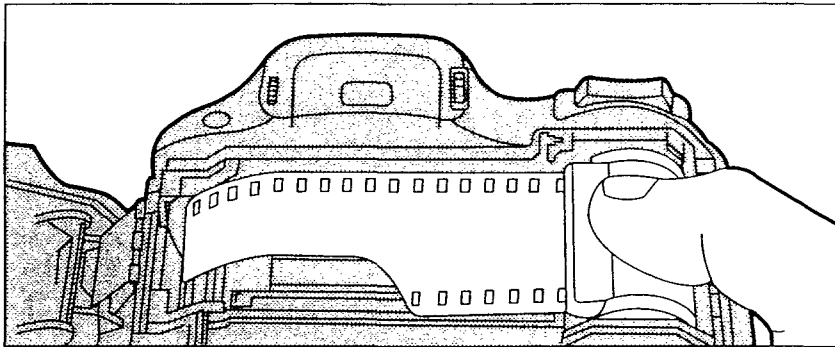

Incorrect

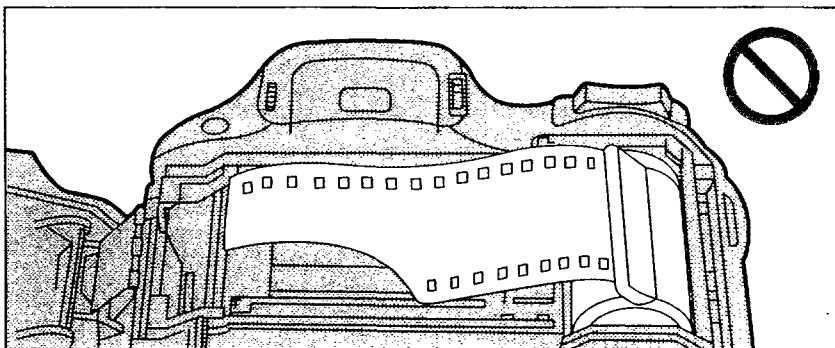

Note: Make sure the film is lying flat.

3. Align the tip of the film leader with the mark as shown, and close the back cover.

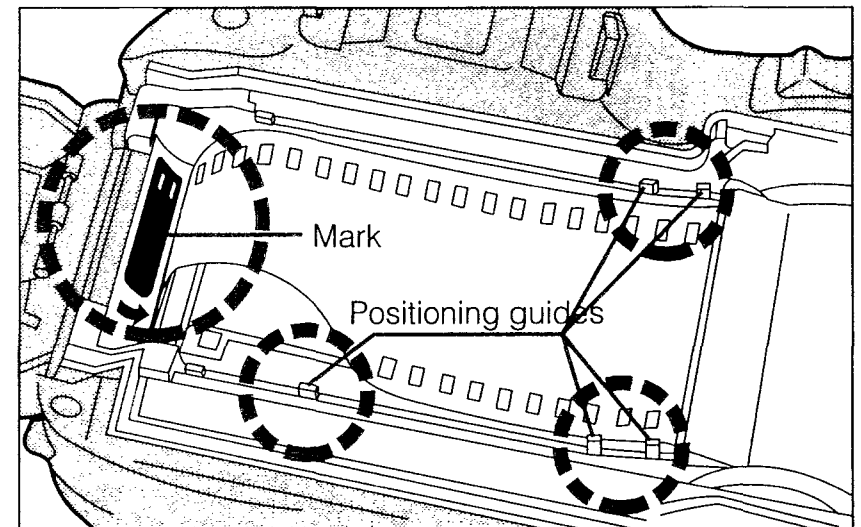

The film automatically advances to the first frame.

Make sure

The film does not overlap any of the positioning guides shown above.

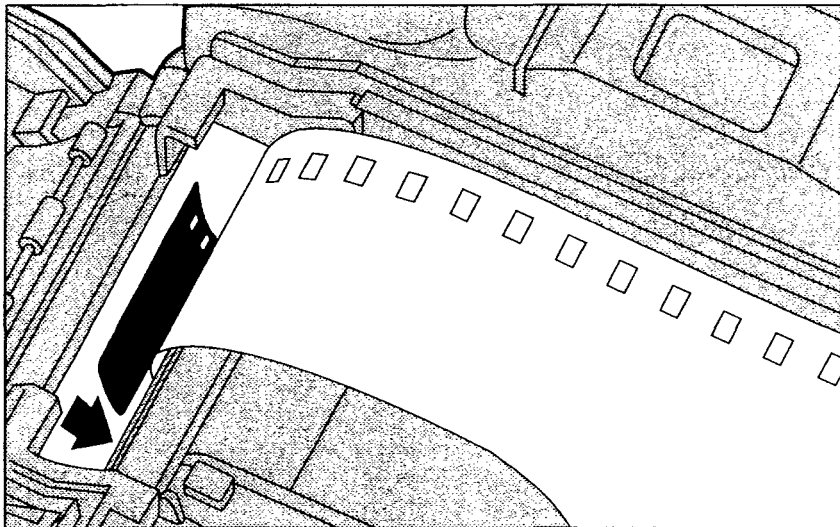

Notes:

- Place the film leader along the arrow as shown.
- Film information can be checked through the film window.

4. Turn the power switch ON.

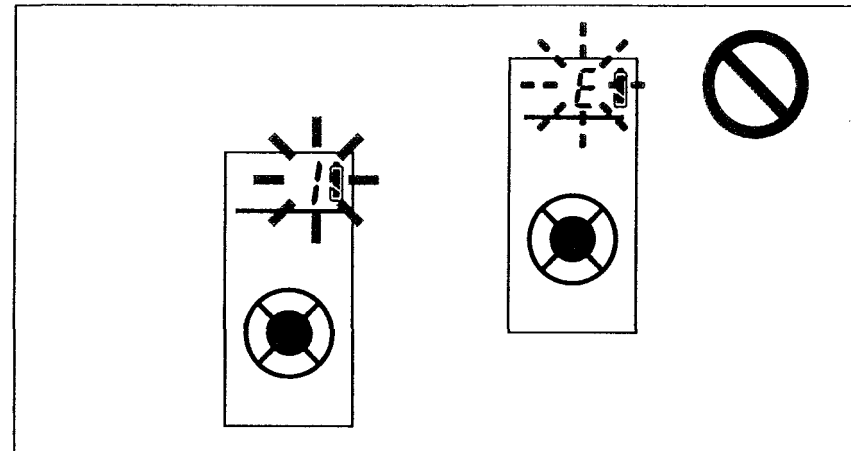

Make sure

The exposure counter on the LCD panel reads *1*.

Note: If *E* blinks in the exposure counter, as shown above, reload the film.

TAKING PICTURES

Follow this procedure for normal photography. When the power switch is turned ON, the camera is in the Full-Auto mode. (p. 43)

1. Turn the power switch ON.

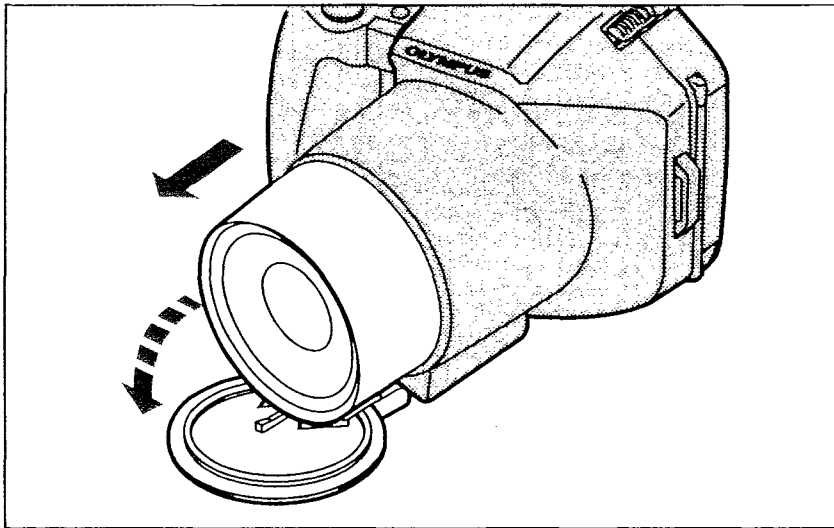

Make sure While the lens moves forward, the lens cap opens, and the LCD panel lights.

Note: If no operation is made for approx. 30 seconds, the LCD panel goes out and will come on again when the operation is resumed.

2. While looking through the viewfinder, press the zoom button to determine the composition.

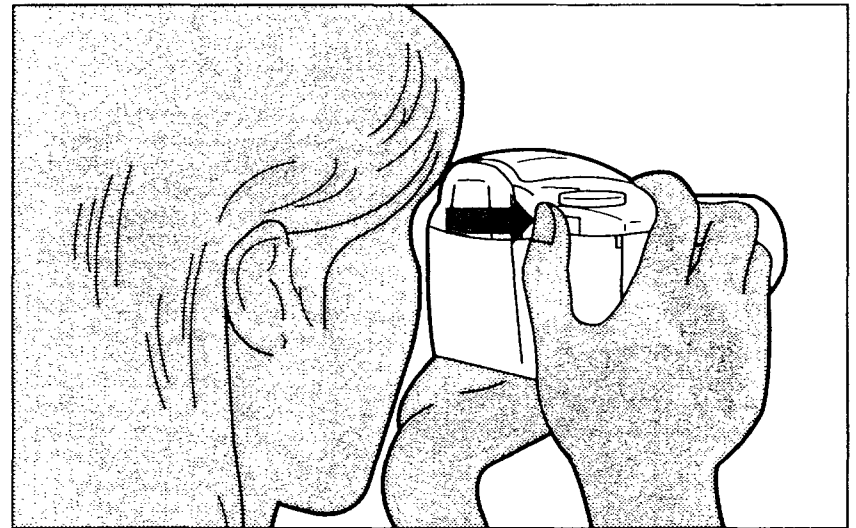

DANGER: DO NOT LOOK AT THE SUN DIRECTLY THROUGH THE VIEWFINDER.

How to Use the Zoom Buttons

Telephoto: Press the (T) button to zoom in.



Max. telephoto focal length: 110 mm

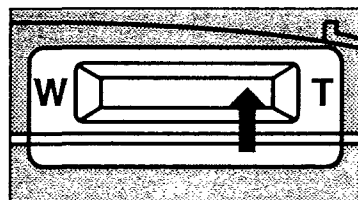

Wide-angle: Press the (W) button to zoom out.



Max. wide-angle focal length: 28 mm

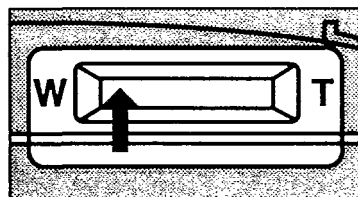

3. Position the autofocus frame on your subject.

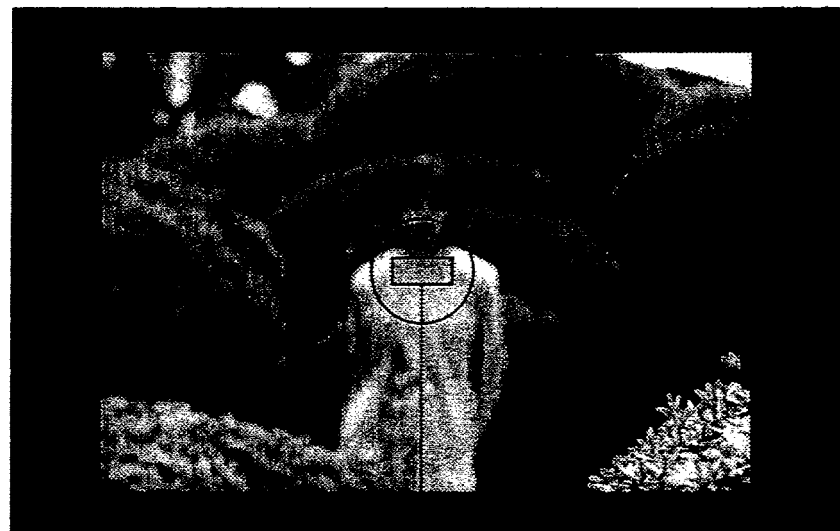

Autofocus frame

Working distance: 75 cm. (2.5 ft) ~ ∞.

4. Depress the shutter release button halfway.



Make sure

The autofocus beep is heard and the autofocus indicator lights when the subject is in focus. It will blink if the subject is difficult for the autofocus to lock on to, and when the subject is too close.

Note: When the autofocus indicator blinks, the shutter won't release. (p. 54)

5. Without removing your finger from the shutter release button, depress fully to take the picture.



The shutter releases and the film automatically advances to the next frame.

When you've finished shooting, turn the power switch OFF, and close the lens cap.

USING THE FOCUS LOCK

When the main subject is not in the center of the autofocus frame, follow the procedure below. This is called focus lock.

1. Position the autofocus frame on your subject and press the shutter release button halfway.



Make sure

Autofocus frame

The autofocus beep is heard, and the autofocus indicator lights in the viewfinder.

2. Reposition your subjects in the picture frame while keeping the shutter release button depressed halfway. Then press the shutter release button fully.



In focus lock the focus is locked in the center of the viewfinder and the exposure is also locked (AE lock) and averages the exposure for the entire viewfinder.

UNLOADING THE FILM

The camera automatically rewinds the film when you reach the end of a roll.

Make sure the motor has stopped and \mathcal{E} is blinking on the LCD panel before opening the back cover and removing the film.

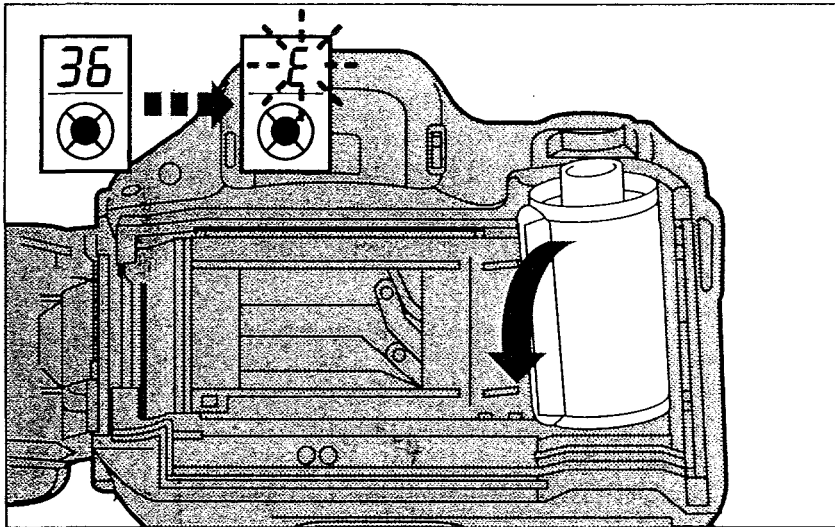

Notes: • The number of exposures will decrease during rewinding. • The final number of exposures may sometimes exceed the number of exposures specified on the film. • The film leader will be wound back inside the cassette.

Rewinding the film before the end of the roll

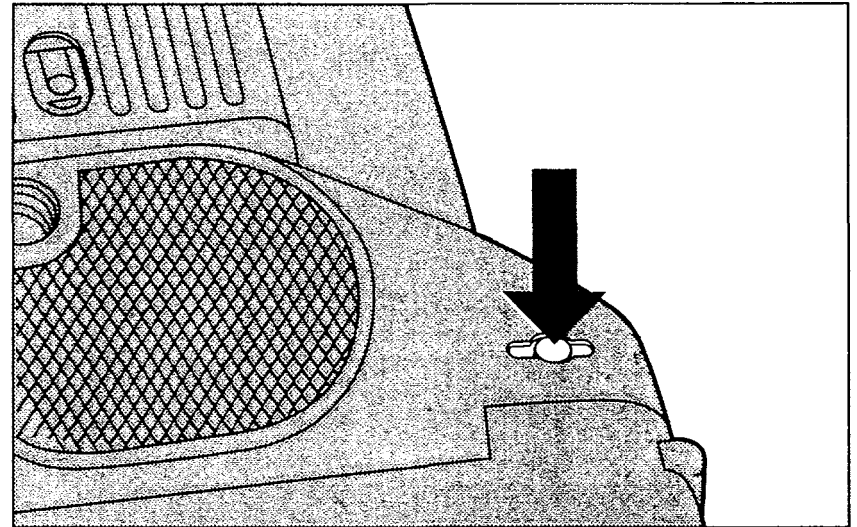

To rewind the film before the end of the roll, press the mid-roll rewind button with your fingernail. Do not use an instrument with a sharp tip.

TAKING PANORAMA PICTURES

Panorama model only

■ Selecting the Panorama Mode

Push the panorama switch up to change to the Panorama mode. Push the switch down to return to the Standard mode.

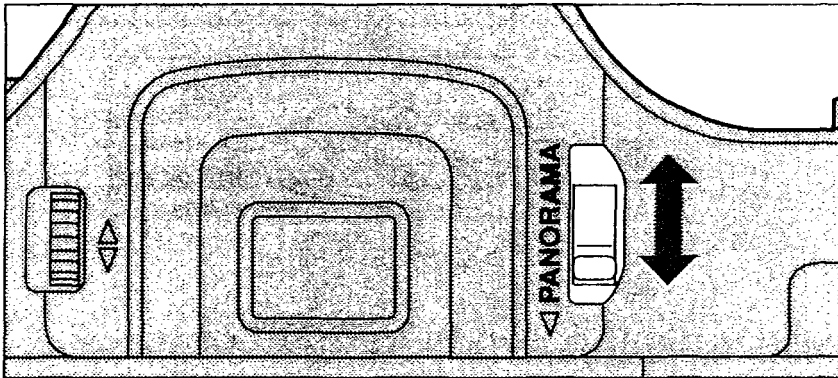

Notes:

- Push the switch all the way; don't stop it halfway.
- The date and time are not printed on Panorama format prints.

Do not open the back cover and touch the panorama mask in the Panorama mode. Otherwise the camera may malfunction.

Viewfinder in the Standard mode



Viewfinder in the Panorama mode

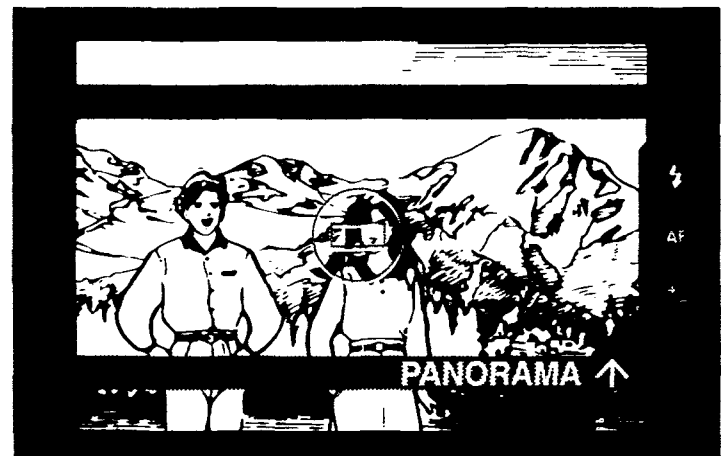

Printing Panorama Pictures

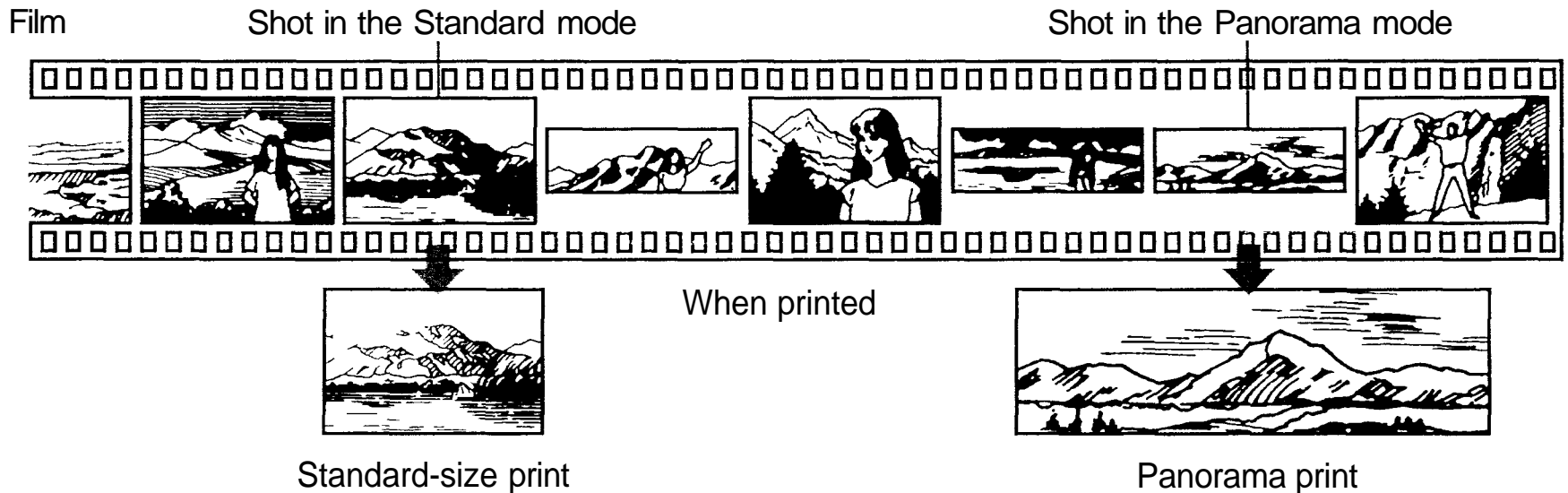

When you take a picture in the Panorama mode, only the middle portion (approx. 12 x 35 mm) of the frame of 35-mm film is exposed (as shown). This portion will be enlarged to the Panorama size (89 x 254 mm). The number of exposures is the same as with the standard size.

How to Get Panorama Prints

When having Panorama mode pictures developed and printed, make sure you tell your film processor that the pictures were taken in the Panorama mode.

FLASH PHOTOGRAPHY

Three flash modes are available to suit different requirements.

■ How to Select the Flash Mode

1. Set the power switch to ⚡ to flip up the flash.

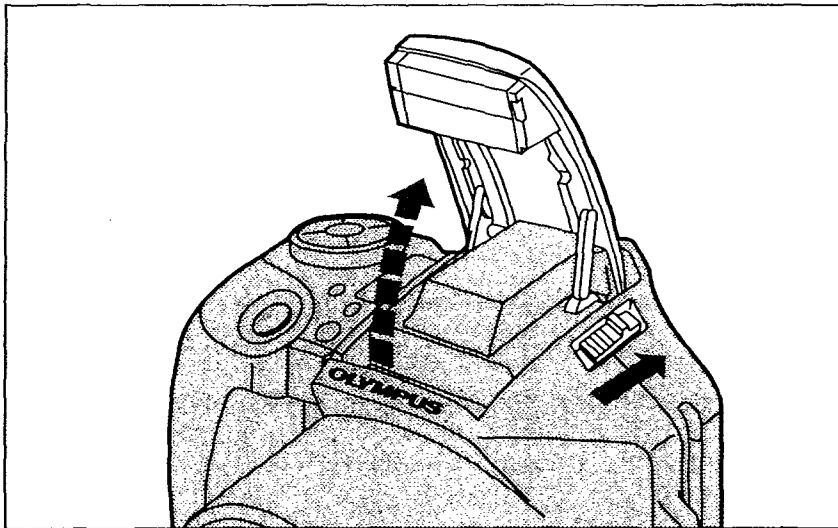

The camera will recharge the flash, and the flash will be ready to use.

Note: Recharging takes 0.2~3.9 seconds.

2. Press the FLASH button to select the flash mode.

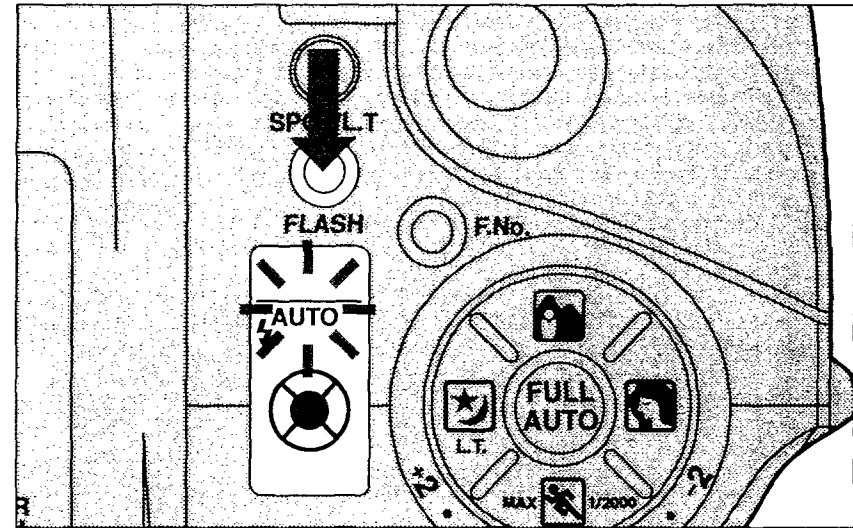

Make sure

The selected mode is displayed on the LCD panel.

■ Flash Modes

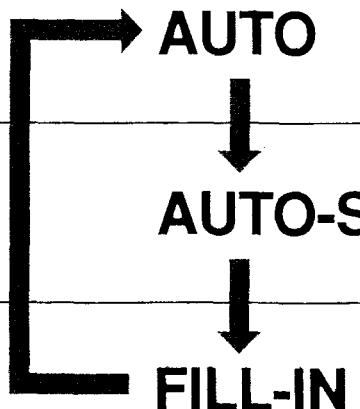
Mode	Function
 AUTO	Automatically fires in dark places, with backlighting and under fluorescent lighting (p. 31).
AUTO-S	Significantly reduces the phenomenon of "red-eye" (when a subject's eyes appear red) (p. 33).
FILL-IN	Fires regardless of available light (p. 34).

Note: Use of the flash is recommended if ⚡ blinks in the viewfinder when the flash isn't flipped up. Otherwise, the camera will select a long exposure and pictures may be blurred due to camera shake.

⚠ There is danger of temporarily affecting vision when the flash is fired very close to a person or animal.

In the dark, the flash also functions as an autofocus illuminator. When the shutter release button is pressed halfway, the flash emits several brief pre-flashes. When the shutter release button is pressed fully, the flash fires to take the picture. Hold the camera firmly until the picture is taken.

Auto Flash AUTO

The flash fires automatically in dark places, with backlighting and under fluorescent lighting.

1. Set the flash mode to AUTO.

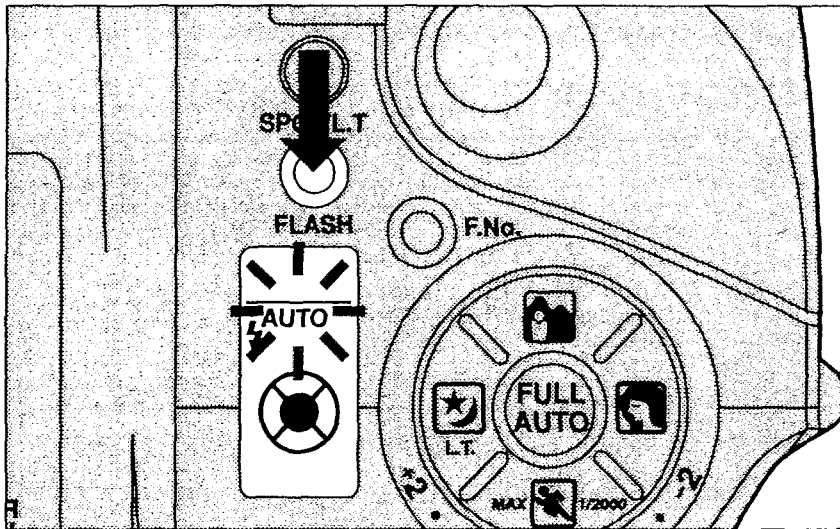

In certain conditions, the flash may not fire under fluorescent lighting.

2. Press the shutter release button halfway to make sure ⚡ lights in the viewfinder.

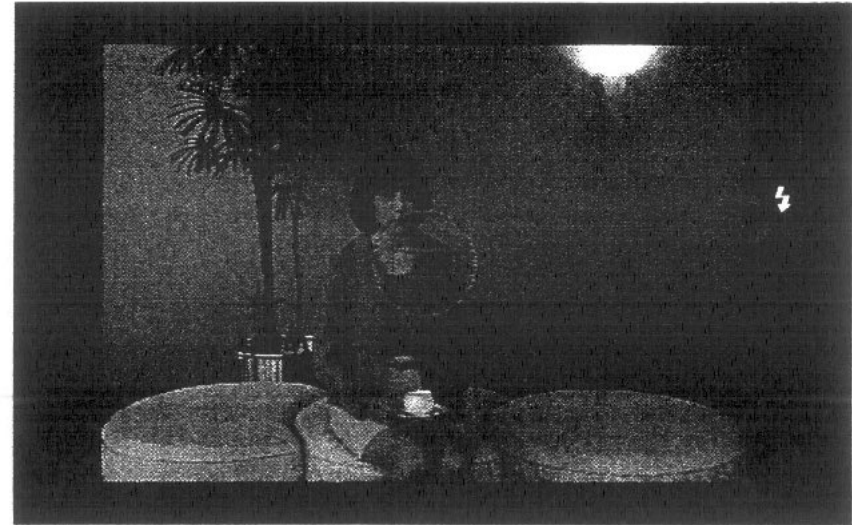

Note: If you press the shutter release button with ⚡ blinking in the viewfinder, the shutter won't release. This is because the flash is being recharged. Remove your finger from the shutter release button, and wait until recharging finishes.

3. Press the shutter release button fully.

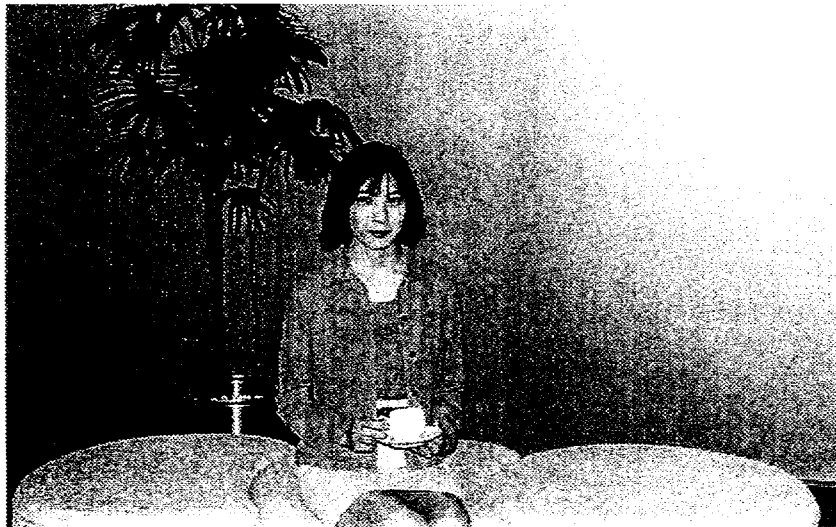

Auto Flash Range

(with color negative film)

Focal length	Telephoto	Wide angle
ISO 100	6.3 m (21 ft)	5.0 m (16.4 ft)
ISO 200	8.8 m (28.9 ft)	7.1 m (23.3 ft)
ISO 400	12.6 m (41 ft)	10.0 m (32.8 ft)

Maximum distance is about 70% when using reversal color film.

Note: The shutter speed is automatically set at 1/100-sec. when the flash fires. The flash will not fire if the existing light level requires a shutter speed greater than 1/100-sec.

Red-Eye Reducing Flash AUTO-S

Approximately 20 pre-flashes are emitted before the main flash fires, significantly reducing the phenomenon of "red-eye" (when a subject's eyes appear red). This mode is the same as Auto Flash except for the pre-flashes.

1. Flip up the flash, and select the Auto-S mode. Press the shutter release button.

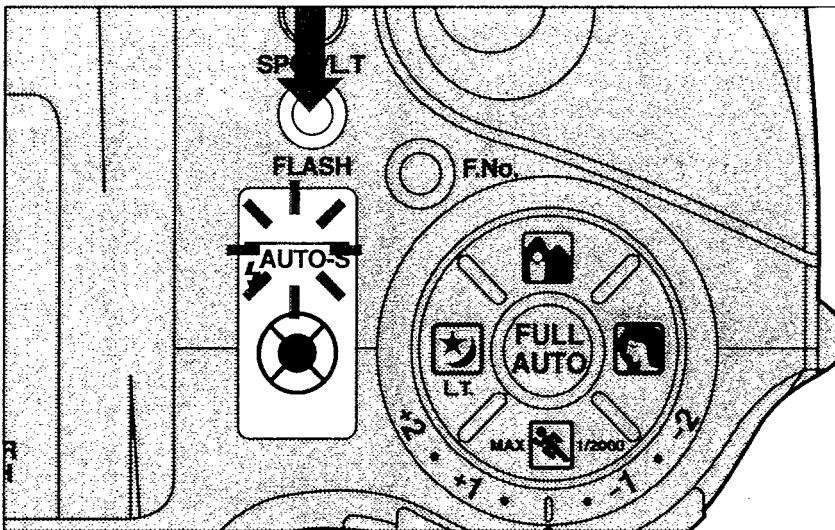

Red-eye reduction may not be effective when the subject:

1. Wasn't looking at the flash from right front.
 2. Wasn't watching the pre-flashes.
 3. Was too far from the camera.
- Did not respond to the pre-flashes due to particular characteristics of the individual.

Notes:

- After pressing the shutter release button, hold the camera securely until the shutter has been released.
- To cancel the Auto-S mode, select another mode following the procedure on page 29.

Forced Activation FILL-IN

In this mode, the flash always fires. Even in backlighting, both the subject and background can be shot clearly. And portraits look lively by reducing shadows on the subject's face.

1. Make sure the exposure mode is set to FULL AUTO.

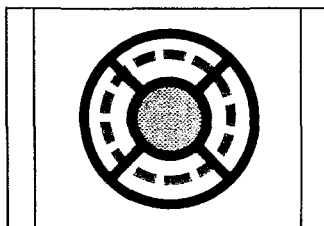



Note: In exposure modes other than Full Auto and Aperture-Preferred Auto, the Fill-in Flash mode cannot be engaged.

2. Select the Fill-in Flash mode, and press the shutter release button.



Note: The shutter speed is automatically set at 1/100-sec. Aperture and flash output will adjust for correct exposure.

SELFTIMER

1. Press the /REMOTE control button until  is displayed on the LCD panel.

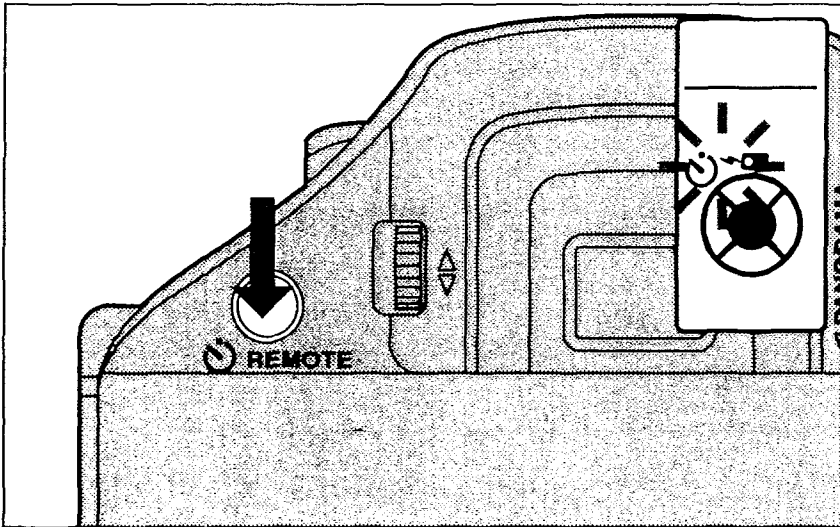

Fix the camera firmly on a tripod or other support.

Notes:

- Do not press the shutter release button from right in front of the camera. Correct focus and exposure cannot be achieved.
- The Selftimer mode is canceled after the shutter releases.
- To cancel the selftimer in the middle of operation, press the /REMOTE button again.
- Do not remove your eye from the viewfinder until after the shutter release button has been fully depressed. This prevents light from entering through the viewfinder.

2. Press the shutter release button.

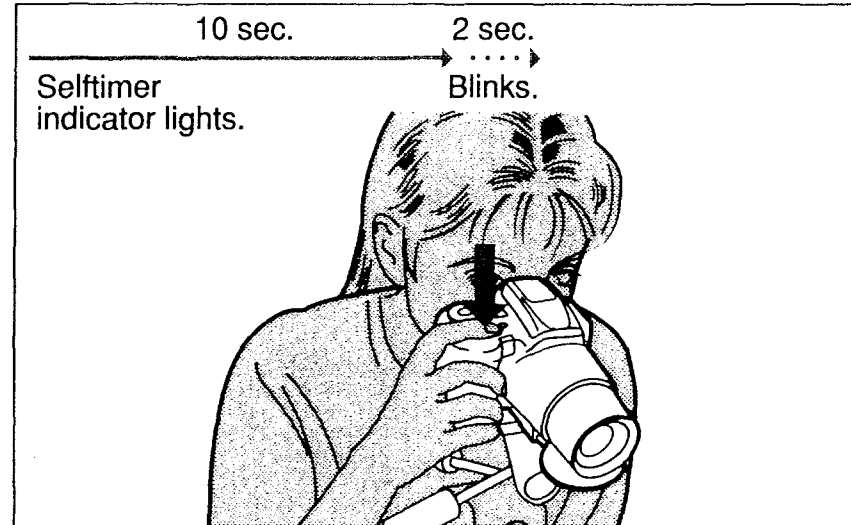

The shutter will be released 12 seconds later.

USING THE EXPOSURE MODES

There are four preset settings for easy shooting in various common situations, as well as an Aperture-Preferred Auto mode and Long Time mode that allow you to select your own settings.

■ Exposure Modes

◆ For easy, effective shooting in various common situations:



Stop Action (p. 37)
To freeze moving subjects.



Portrait (p. 38)
For pictures with blurred background for "portrait" effect.



Landscape (p. 39)
For pictures with extended in-focus background.



Night Scene (p. 40)
For night scenes or night scenes with subjects in the foreground, using the flash.

◆ For more creative lighting effects:

F.No.

Aperture-Preferred Auto (p. 41)
Set the aperture manually. The camera will automatically select the correct shutter speed.



Long Time (p. 42)
Allows you to set the shutter speed manually from 1 to 60 seconds. The aperture is automatically set to F8.

■ How to Select the Exposure Mode

Press one of the icons.

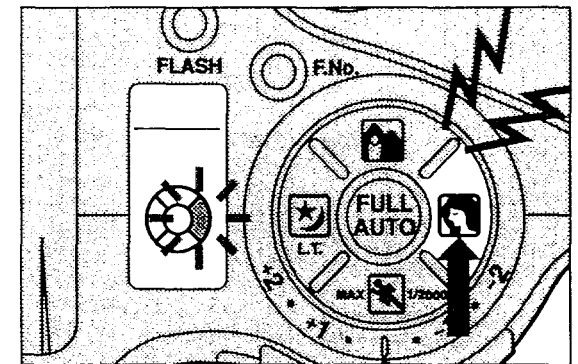

STOP ACTION 1/2000

To freeze moving subjects.

In this mode, the camera automatically selects a faster shutter speed to reduce blurring of moving subjects. (Max. shutter speed: 1/2000-sec.) Also in this mode, the predictive autofocus helps achieve more precise focusing on moving subjects.

1. Press the  button.

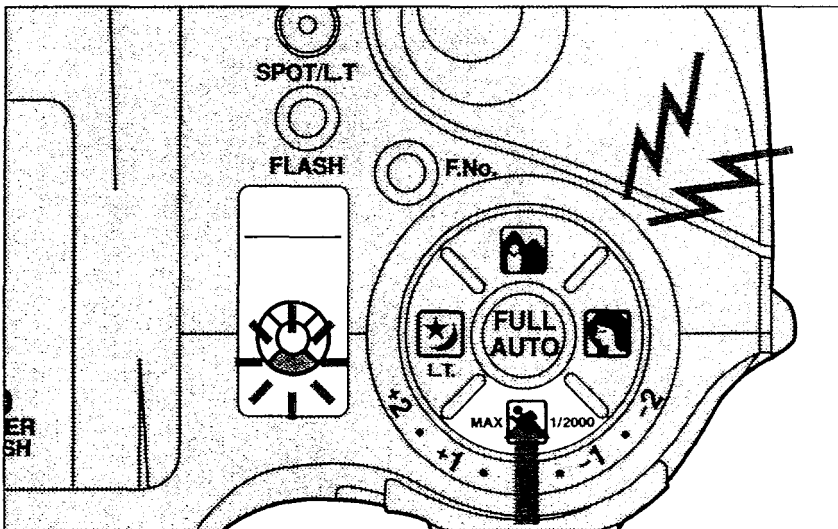

When you use flash in this mode, we recommend that you choose the Auto Flash mode. If you select the Auto-S mode, pre-flashes may cause you to miss the photo opportunity.

2. Press the shutter release button.



Notes:

- The camera keeps focusing on the subject as long as the shutter release button is kept depressed halfway.
- Correct focus may not be achieved when the subject is moving too fast.

PORTRAIT

To take pictures with blurred backgrounds for "portrait" effect.

The portrait mode lets you take beautiful portrait photographs. This is especially effective when the lens is at the telephoto setting and/or when there is a great distance between the subject and the background. In this mode, the Super FP Flash enables synchronization as fast as 1/2,000-sec.

1. Press the  button.

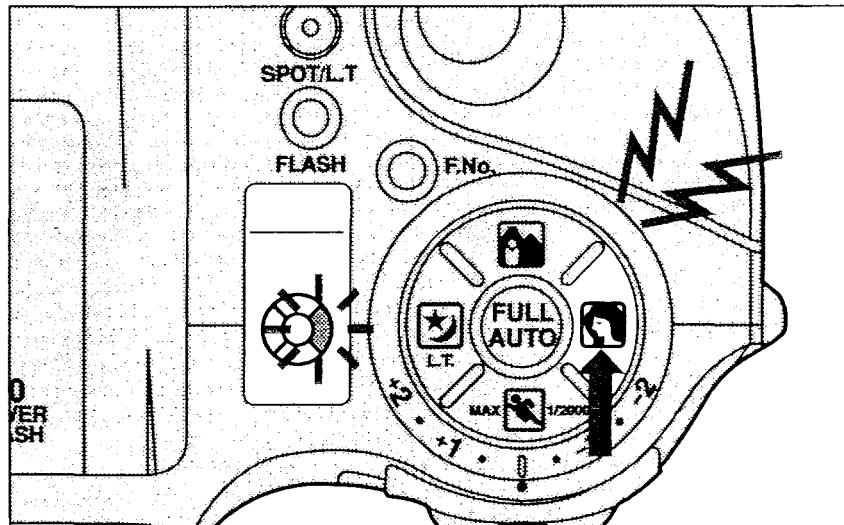

Note: The aperture is wide-open.

2. Press the shutter release button.



Note: When the flash is flipped up, it always fires regardless of the amount of available light to highlight your subject.

LANDSCAPE

To take pictures with extended in-focus backgrounds.

When shooting landscapes or landscapes with subjects in the foreground, all objects near and far are sharply in focus.

1. Press the  button.

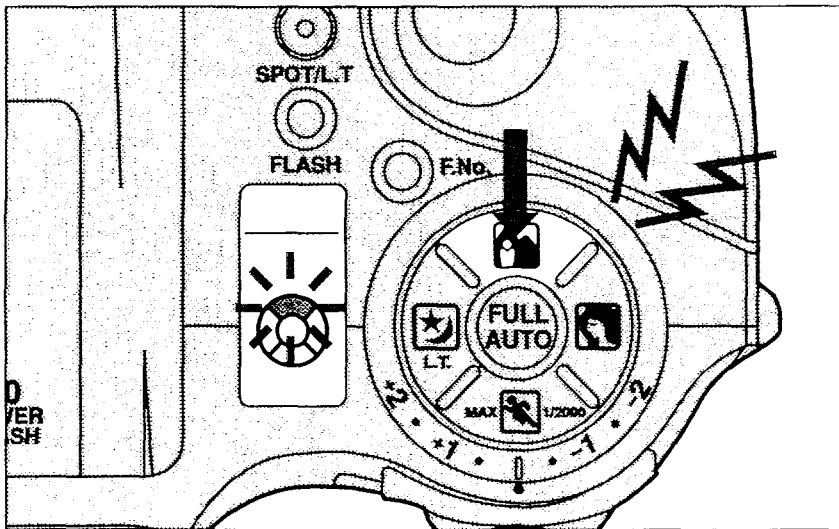

Note: Set the lens at wide angle for optimal results.

2. Press the shutter release button.



NIGHT SCENE

To shoot properly-lit night scenes.

In this mode, the camera automatically selects the ideal exposure for shooting night scenes, and for shooting night scenes with subjects in the foreground.

■ When subjects are in the foreground, flip up the flash.

1. Press the  button.

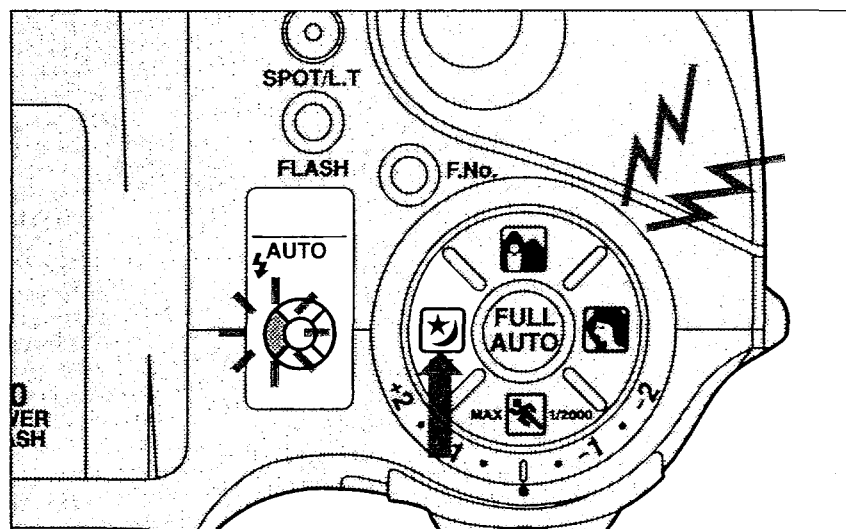

2. Press the shutter release button.



■ When there are no foreground subjects, do not flip up the flash.

Notes:

- When the flash is flipped up, flash power is automatically adjusted according to the subject.
- Since the camera may select a shutter speed as slow as 4-sec maximum, use of a tripod is recommended to prevent camera shake.

APERTURE-PREFERRED AUTO F.No.

The background blur can be controlled by adjusting the aperture setting. The shutter speed will be selected automatically.

1. Press the **F.No.** button to enter the Aperture-Preferred Auto mode.

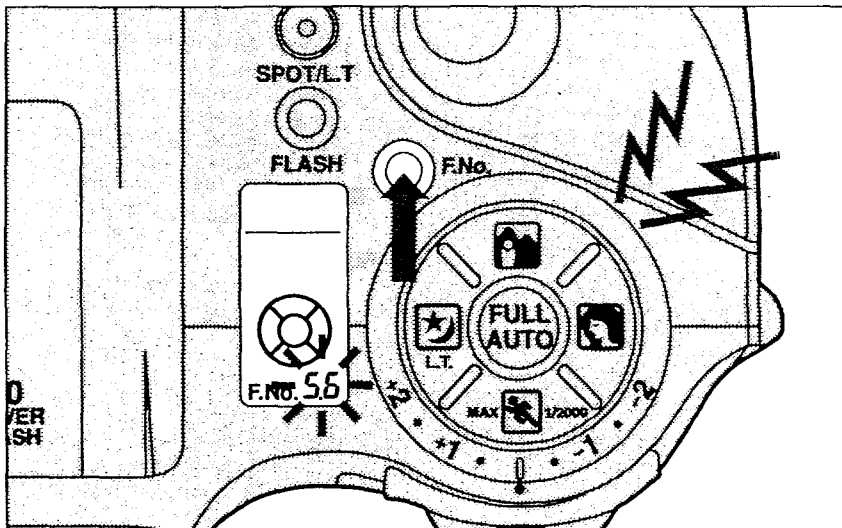

Notes: •Additional pressing of the **F.No.** button stops down the aperture. Once the camera has passed the smallest available aperture setting, it will return to the largest available aperture setting.
•Blinking +/- in the viewfinder indicates the subject is under- or overexposed. Change the aperture setting until it stops blinking.



Larger aperture (smaller value)
for a blurred background



Smaller aperture (larger value)
for a sharper background

LONG TIME To shoot fireworks.

For a dramatic shot of fireworks or similar nighttime lights, set the shutter speed as desired (1 to 60 sec.). The aperture is automatically set to F8.

1. While holding down the  button, press the SPOT/L.T. button to choose shutter speed.

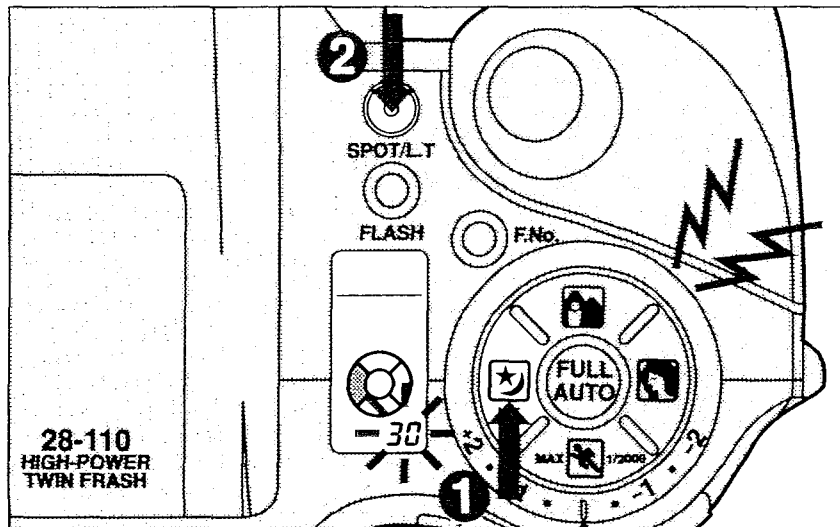

2. Press the shutter release button.



Shutter speed is shown on the LCD panel (page 9).

Notes:

- Each time you press the SPOT/L.T. button, the shutter speed changes in the following sequences: 1, 2, 4, 8, 15, 30, and 60 sec.
- Because the selected shutter speed will be very slow, to prevent blurring hold the camera firmly in position. Use of a tripod is recommended.

RESTORING THE STANDARD SHOOTING MODE **FULL AUTO**

Restore the standard shooting mode for easy, worry-free photography.

1. Press the FULL AUTO button.

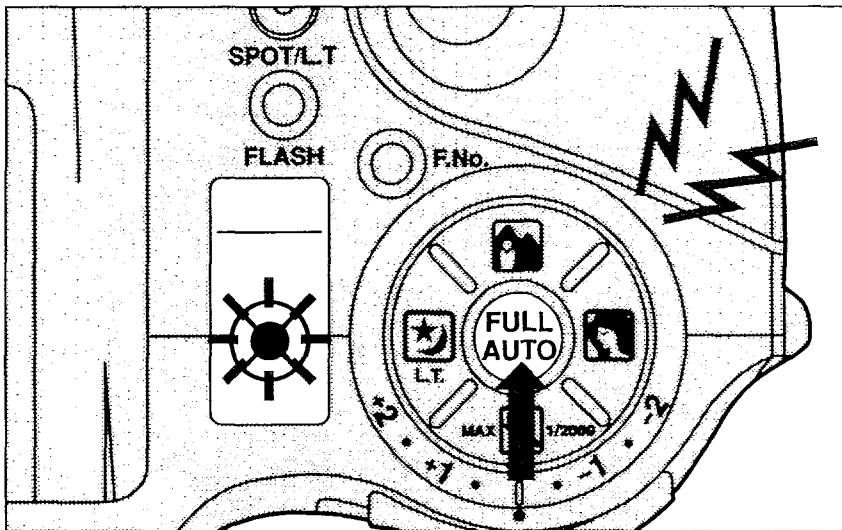

The camera will also return to the standard shooting mode if the power is switched off and on again.

Standard Shooting Mode

Settings for the standard shooting mode are as follows:

- Exposure mode — Programmed Auto
- Flash mode — Auto or Auto-S
- Selftimer/remote control — Canceled
- Spot metering — Canceled

Note: The exposure compensation setting is not canceled even when the FULL AUTO button is pressed.

SPOT METERING

In this mode, the camera limits light metering to a particular area, such as a subject's face, and sets the correct exposure.

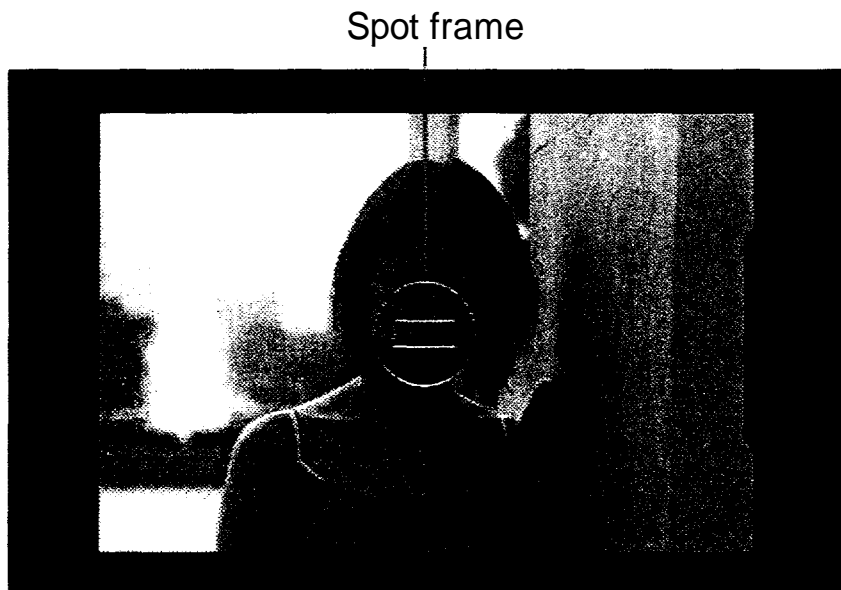

In situations like the one illustrated above, the subject will be dark because of backlighting.

1. Position the subject for spot metering within the spot frame, and press the SPOT/L.T. button.

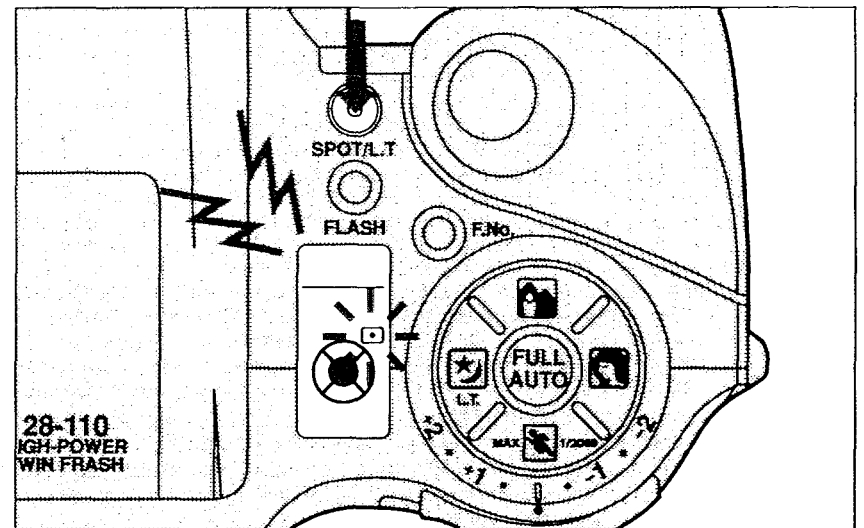

Make sure

 is displayed on the LCD panel and the exposure is locked.

2. Recompose the shot, then press the shutter release button to take the picture.



Use the Spot Metering mode in the following situation:

- When there is a big difference between subject and background brightness (e.g., backlighting).

Notes:

- When the flash is flipped up, or the Night Scene or Long Time mode is engaged, the camera does not perform spot metering.
- After the shot, the Spot Metering mode is canceled. To cancel the mode without taking a shot, press the SPOT/L.T. button again.

EXPOSURE COMPENSATION

When you deliberately want to make your shot brighter or darker, turn the exposure compensation dial instead of using the camera's standard automatic exposure.

1. Set the exposure compensation dial to the desired setting.

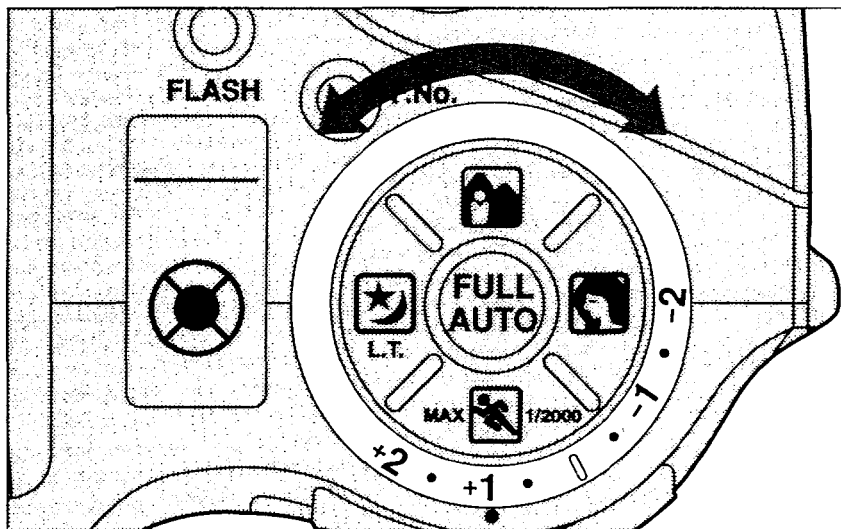

Notes:

- When the shutter release button is pressed halfway, +/- will be displayed in the viewfinder.
- Exposure compensation is possible up to ± 2 EV in 1/2-EV increments.

- When the exposure compensation setting is adjusted in the Long Time mode, only flash emission is corrected.
- Pressing the FULL AUTO button does not restore the exposure compensation dial's ± 0 setting. Always be sure to turn back the dial after using exposure compensation.
- The flash power is also compensated according to the selected exposure compensation setting.
- When negative color film is used, the exposure compensation effect may be almost indistinguishable in prints.
- In the Aperture-Preferred Auto mode, +/- blinks when the subject is outside the range within which exposure can be compensated.

To make a whitish subject brighter (Compensated to +2 EV)

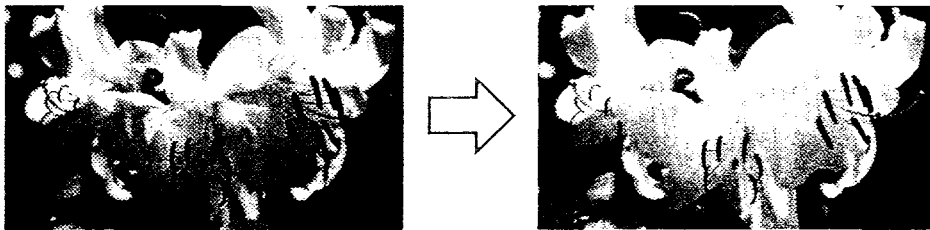

To make a blackish subject blacker (Compensated to -2 EV)

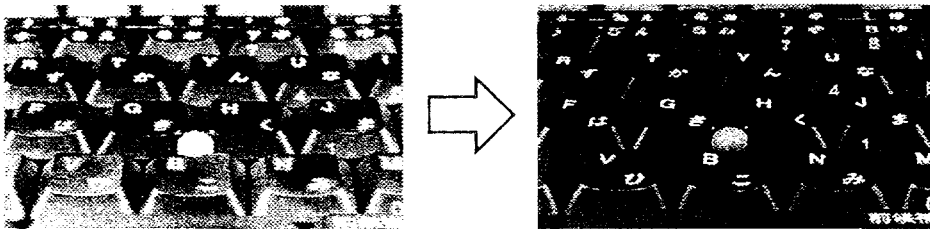

To make a backlit subject brighter (Compensated to +1 EV)

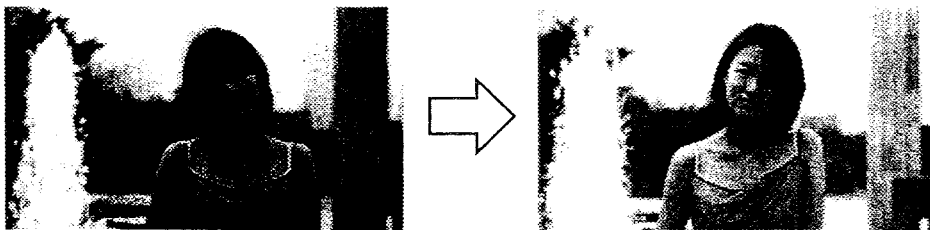

To turn a daytime scene into a virtual nighttime scene (Compensated to -2 EV)

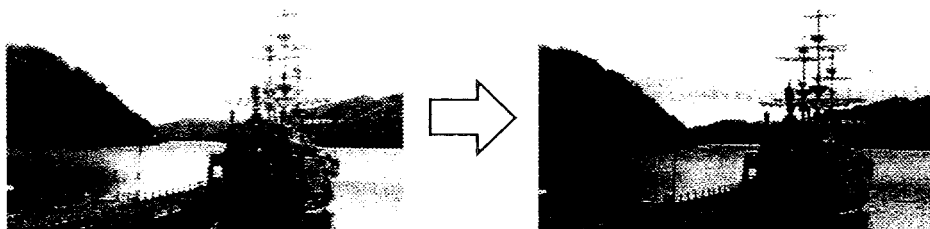

■ "+" Compensation

Renders the entire frame brighter.

- Backlit subject
- Whitish subject
- Snowscape

■ "-" Compensation

Renders the entire frame darker.

- Spotlit subject
- Subject with a black background
- Blackish subject

REMOTE CONTROL (OPTIONAL)

The optional RC-200 Remote Control is required.

1. Press the /REMOTE button to engage the Remote Control mode.

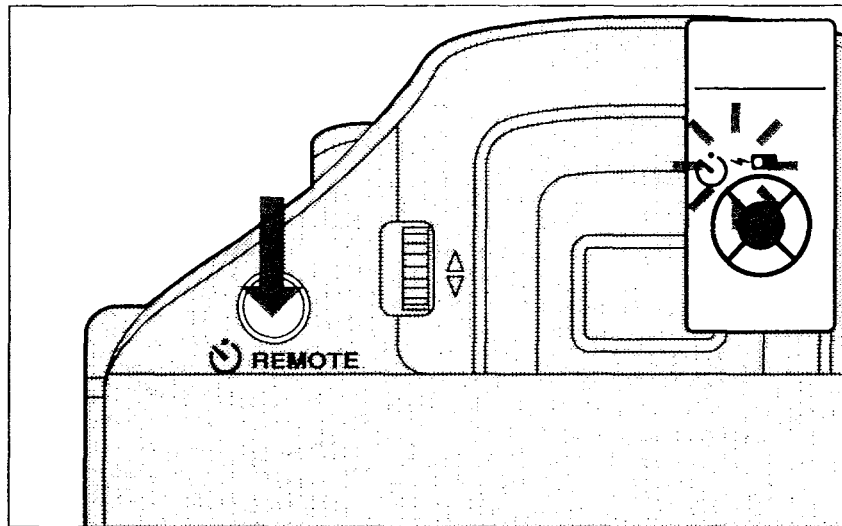

2. Position the autofocus frame on the subject.



3. Aim the remote control at the camera, and press the button.

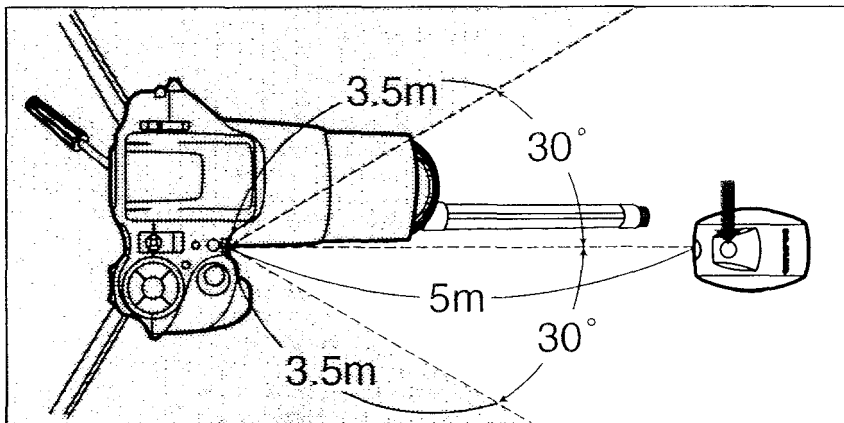

The shutter will be released about 3 seconds after the beep.

Notes:

- Use selftimer outside the above range.
- The remote control may not work when there is backlighting and when autofocusing is difficult. (p. 54)

CAUTIONS:

- Keep the remote control out of the reach of children. In case it is swallowed, immediately consult a doctor.
- Keep the remote control away from fire and extreme heat. Never try to disassemble it.
- Operating temperature is -10°C (14°F) ~ 40°C (104°F).
- Observe the precautionary remarks written on the battery.
- Dispose of a used battery as general waste according to local regulations.

Important: After the shot(s), be sure to press the \odot /REMOTE button again to cancel the Self-timer/Remote Control mode.

CORRECTING THE DATA

QD models only

Press the **SELECT** button to switch to the data correction status to adjust ① year-month-day and ② day-hour-minute.

- 1.** Press the **SELECT** button until the indication you want to change starts blinking.

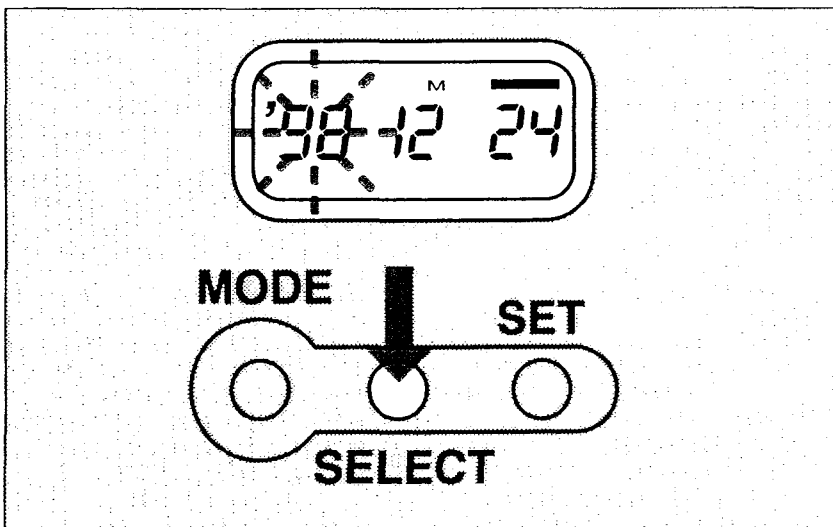

Do not press the buttons with a mechanical pencil or similar pointed instrument.

- 2.** Press the **SET** button to correct the data.

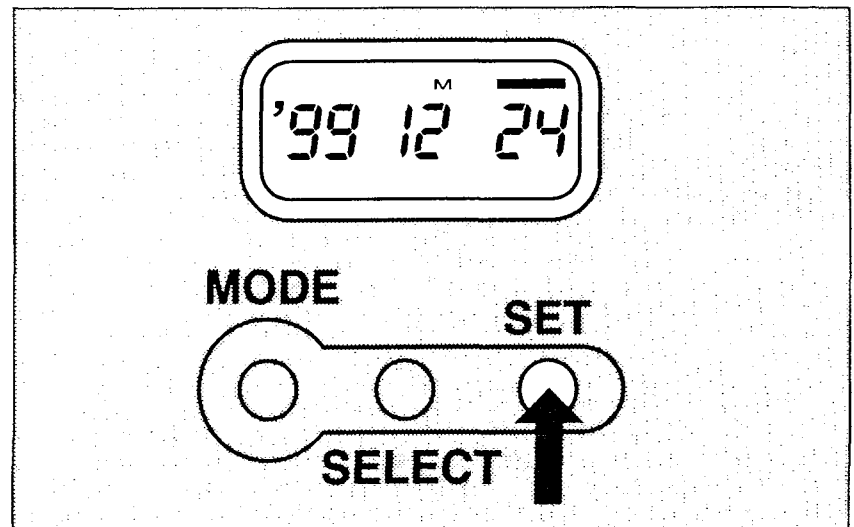

If you press the button once, the number on the display will advance by 1. If you hold the button down, the numbers will run in rapid succession.

PRINTING THE DATE AND TIME

QD models only

This camera has five data imprinting modes. Press the **MODE** button to choose the mode you want to use.

Month indicator ("M" stands for month.)

Imprinting confirmation indicator

Blinks for about 3 seconds after shooting to make sure the data has been imprinted.
(These indicators will not be printed on the picture.)

As you press the **MODE** button, the mode will switch in the order shown below.

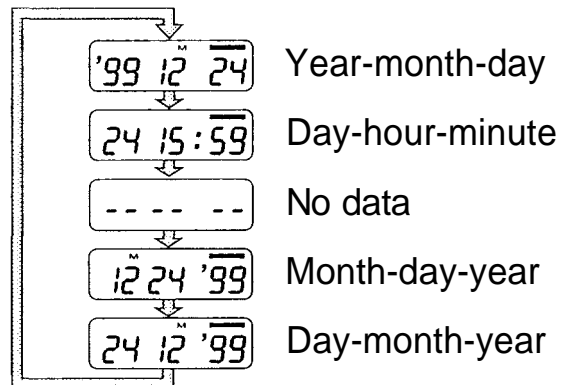
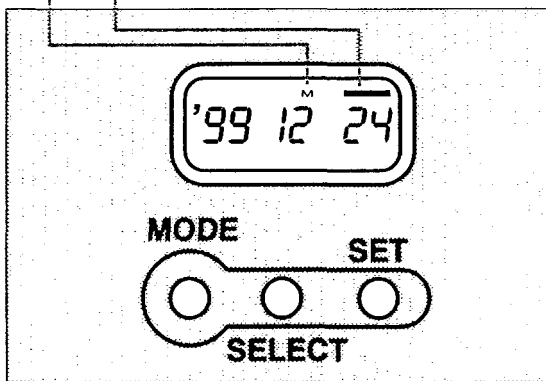

MODE button: Chooses date and time.

SELECT button: Chooses the indication to be changed.

SET button: Adjusts figures.

- Date and time are not imprinted in the Panorama mode.
- If there is anything whitish or tinged with orange in the area of the picture where the data is imprinted, the data may not be legible.
- Data may not be imprinted on black-and-white film.

EFFECTS OF ZOOM AND ITS ADVANTAGES

Zoom lens focal length is changed by moving part of the lens. With this camera, you can select any focal length between 28 mm and 110 mm.

- 28 mm wide-angle

Because the angle of view is wide and the depth of field is large, you can take sharp photographs with enhanced perspective and contrast. This is ideal for shooting landscapes, skylines, crowds at a party, etc.

- 50 mm (approx.)

This range is the standard angle of view and has moderate background blurring. It is suitable for most types of shot including portraits.

- 110 mm

At its maximum focal length, the built-in lens offers a telephoto effect. The depth of field is shallower, and the effects of aperture settings are more apparent. In telephoto shooting, use a tripod or hold the camera firmly to prevent the camera from shaking.

- 160 mm telephoto (optional)

When the optional teleconverter IS/L LENS C-160 H.Q. CONVERTER 1.45X is used, you can extend the telephoto range up to 160 mm.

- 210 mm telephoto (optional)

When the optional teleconverter IS/L LENS C-210 H.Q. CONVERTER 1.9X is used, you can extend the telephoto range up to 210 mm.

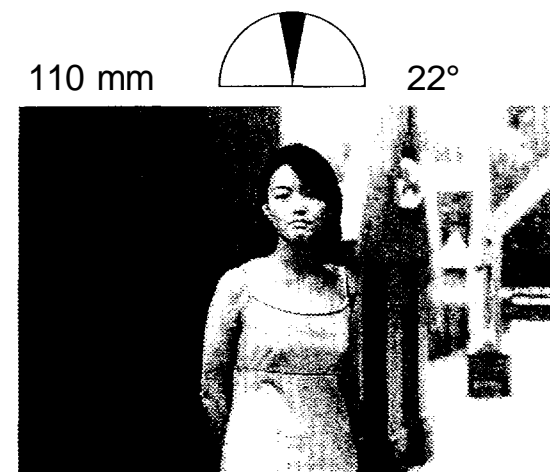
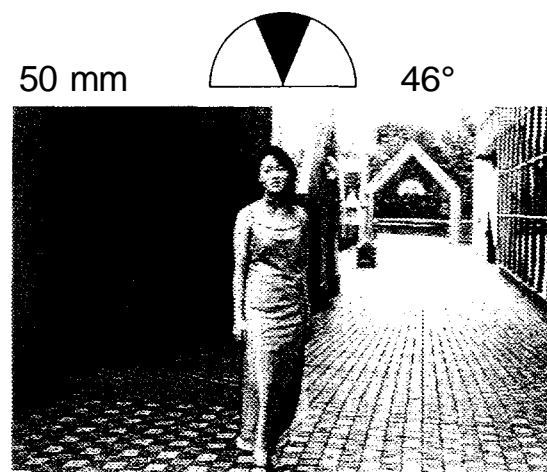
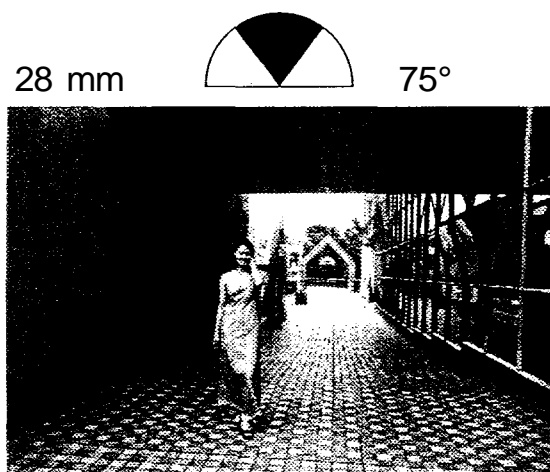

Angle of view and depth of field
 Angle of view is directly related to the focal depth of field (the distance in front of and behind the subject that the camera is able to bring into focus). The greater the angle of view (wide angle), the greater the depth of field. When the angle of view is narrow (telephoto), the depth of field decreases.

28 mm

F.No.5.6



50 mm

F.No.5.6



110 mm

F.No.5.6

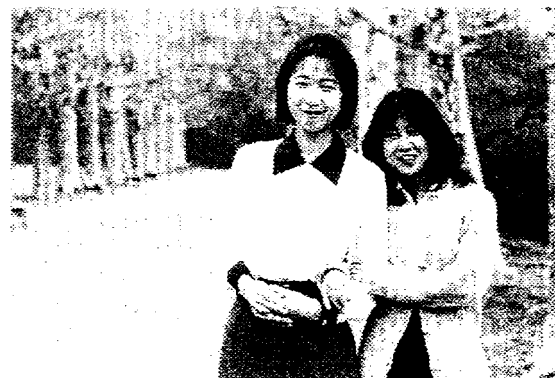

IS/L LENS C-160 H.Q. CONVERTER 1.45X

160 mm  15°



210 mm  12°



AUTOFOCUS (AF)

Although this camera's autofocus can lock on virtually any subject, there are certain conditions, such as ① ~ ③ shown below, where it may not be possible to obtain the correct focus. In the situations shown in ④ ~ ⑥ on the next page, autofocus may not lock on the correct subject even though the autofocus indicator lights and the shutter releases.

① Subjects with low contrast

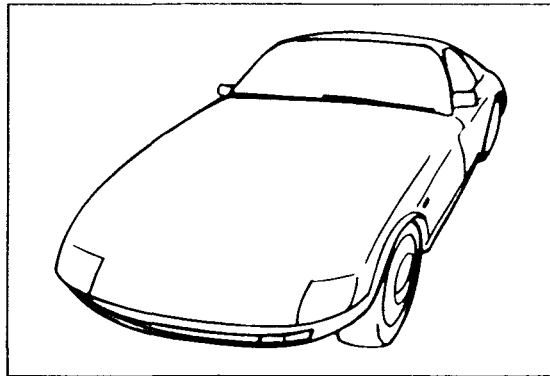

- Use the focus lock by first focusing on something at the same distance as the subject you wish to take a picture of, and then aim at the subject.

② Subjects that do not contain vertical lines

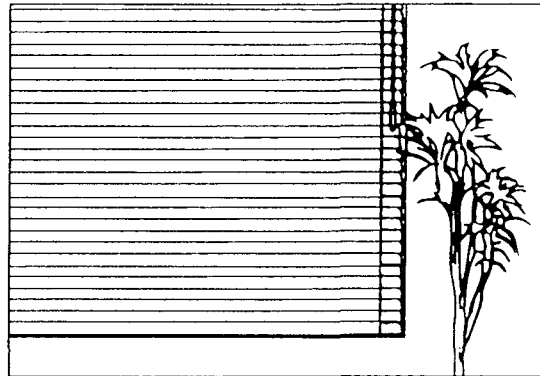

- Use the focus lock first while holding the camera vertically. Then switch the camera to the horizontal position to take the photograph.

③ Subjects in excessively bright light

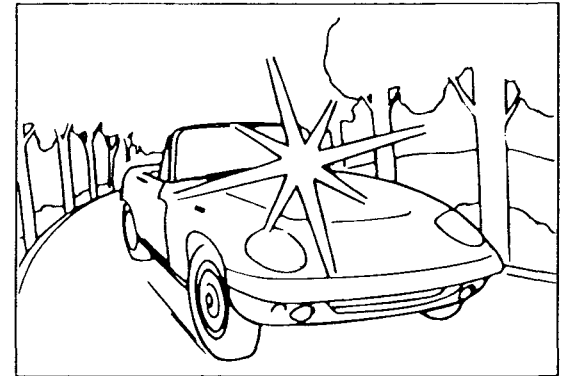

- Use the focus lock by first focusing on something at the same distance as the subject you wish to take a picture of, and then aim at the subject.

④ Two subjects at different distances

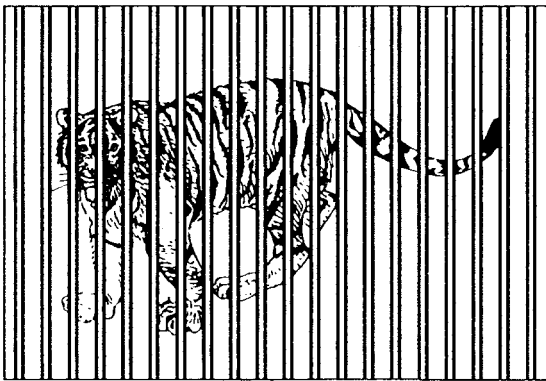

- When the subject locks out-of-focus although the autofocus indicator lights, focus on another subject at the desired camera-to-subject distance first. Then recompose the frame to take the picture.

⑤ Subjects with repetitive patterns

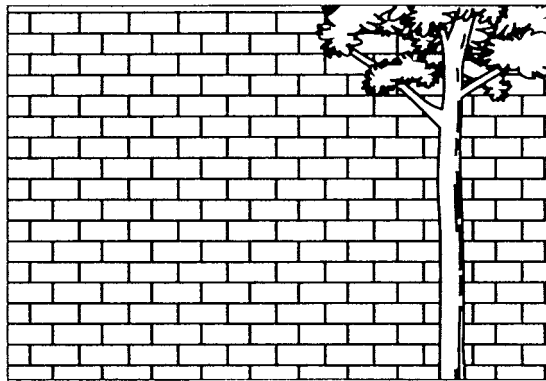

- When the subject locks out-of-focus although the autofocus indicator lights, focus on another subject at the desired camera-to-subject distance first. Then recompose the frame to take the picture.

⑥ High-speed subjects at close range

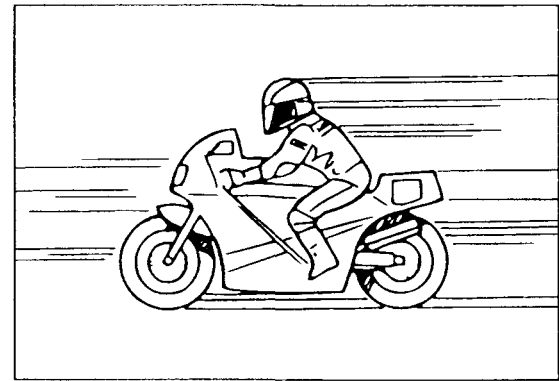

- Focus on another subject at the desired camera-to-subject distance first. Then recompose the frame to take the picture.

EXPOSURE

■ Automatic Exposure Mode

Exposure refers to the amount of light which strikes the film, and is controlled by a combination of aperture size and shutter speed. The correct amount of light, called correct exposure, depends on the film speed (indicated on the film package, e.g., ISO 100 or ISO 200).

The automatic exposure function automatically sets the correct exposure. This camera employs two types of automatic exposure modes, programmed auto-exposure and aperture-preferred auto exposure.

With programmed auto exposure, the camera automatically selects the most suitable combination of F stop and shutter speed for the existing lighting conditions. This lets you concentrate on composing your shot and releasing the shutter at just the right time. With aperture-preferred auto, you select the desired F stop, and the camera automatically selects the correct shutter speed. Aperture-preferred auto gives more artistic freedom of expression and creativity by selecting a desired F stop to control the blur of the background.

■ Programmed Chart (FULL AUTO)

The following program chart is for 28 mm wide-angle and 110 mm telephoto focal lengths. According to the focal length, the camera's program itself changes. When the subject is

brightly lit, the F stop and shutter speed change simultaneously. When the lighting is darker, the aperture remains wide-open and only the shutter speed changes to as slow as 2 sec. to match the available light (ISO 100).

In the standard shooting mode (refer to p. 43), if the built-in flash has been flipped up, it will automatically fire in dark lighting or backlit conditions. The shutter speed will be fixed at 1/100-sec.

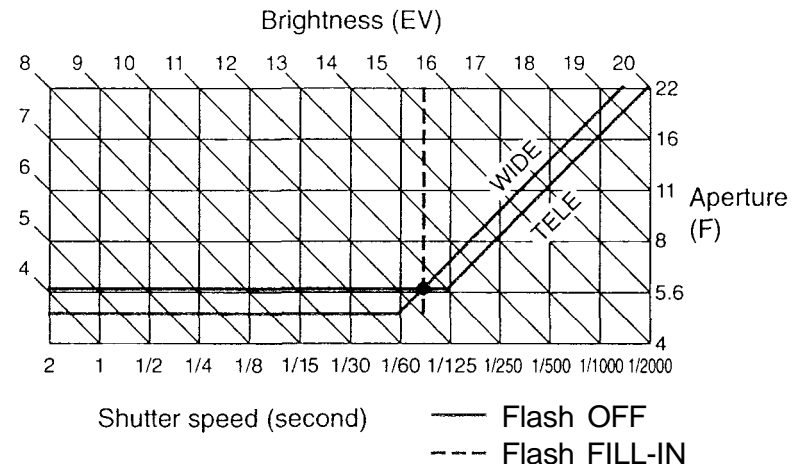

■ Portrait Mode

In this mode, the camera chooses a wide aperture for a shallow depth of field. This results in a softly blurred subject background, against which your subject stands out in sharp focus. This mode also prevents camera-shake from happening because a faster shutter speed is selected.

■ Night Scene Mode

Allows you to capture beautiful nighttime scenes just as they are. The camera automatically adjusts exposure compensation for optimum night scene photography - extending exposure time for up to 4 seconds (ISO 100). When shooting a subject against a nighttime background, use of the flash is recommended. In this case, the camera optimizes exposure compensation for both the subject and the background. Since the selected shutter speed may be very slow, hold the camera firmly in position (with a tripod for example) to prevent blurring.

■ Stop Action Mode

This mode is ideal for capturing high-speed photo opportunities such as sports scenes and children at play. A fast shutter speed is automatically selected to "freeze" the action on film.

■ Landscape Mode

This mode is ideal when you want to focus on both the subject and the background or when you want to shoot natural scenery with low contrast. The camera automatically stops down the aperture to make the range of focus as large as possible. In shooting conditions for this mode, the subjects are likely to be at a distance of ∞ (infinity), so the autofocus function in this mode starts from the ∞ position.

■ Long Time Mode

To obtain trailing effects when shooting fireworks or car lights, a long shutter speed is required. The Long Time mode is ideal for this type of shot since it allows you to choose a shutter speed of up to 60 seconds with a fixed aperture of F8. Since the selected shutter speed will be very slow, use of a tripod is recommended to prevent blurring.

■ Exposure Compensation

When you shoot ordinary subjects, the camera automatically selects the most appropriate exposure to give you the best shot. However, when shooting a backlit or whitish subject (including a snowscape) we recommend you correct exposure to +1 ~ +2 (to make your picture brighter). For a spotlighted, darkish, or blackish subject, correct exposure to -1 ~ -2 for (to make your picture darker).

FILM SPEED

■ Film Speed

Film speed is indicated on the back of film packages. ISO 100, ISO 200, and ISO 400 are the most common. High-speed film (ISO 400), as implied by its name, is for taking photos of fast-moving subjects in action shots, for example. However, there are also other advantages. With high-speed film, such as ISO 400, it is possible to take pictures in lower light. And the distance covered by the flash will be greater. Generally, the higher the film speed, the grainier the picture. With this camera, we recommend the use of "DX" film cartridges: ISO 25 ~ 3200. In the case of non-DX-coded film, the camera will automatically be set to film speed ISO 32.

METERING THE AMOUNT OF LIGHT

■ Light Metering

Light metering can measure the brightness of the framed subject in various ways. This camera employs three metering systems: (1) ESP light metering, (2) center-weighted average light metering, and (3) spot metering. You can select the light metering system most suitable to the conditions. The camera also uses TTL (through-the-lens) light metering to automatically measure the light that enters the lens. This lets you get very accurate light readings that are unaffected by changes in the distance between the subject and the camera.

■ Fuzzy Logic ESP (Electro-Selective Pattern) Light Metering

ESP light metering measures the brightness of the central portion and peripheral portion of the frame separately in order to determine the proper exposure. The calculation program used is based on programmed data to properly compensate for backlighting. ESP light metering is used automatically when in the Full-Auto mode.

■ Center-Weighted Average Light Metering

Center-weighted average light metering is the most widely used light metering system (Fig. A). This system measures the light available throughout the frame with special emphasis on the center of the frame. When in the Aperture-

Preferred Auto mode, this light metering system is automatically activated. When the contrast between bright and dark areas is not too extreme outside the center of the frame, this system offers excellent results.

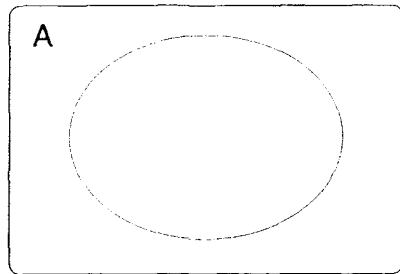

Spot Metering

Spot metering (Fig. B) measures the brightness at the center of the frame only. Because this metering system calculates the correct exposure for only one point, it is convenient when the subject is backlit or the picture contains strong contrasts. When shooting a subject in front of an extremely bright background, you should use spot metering on the subject's face.

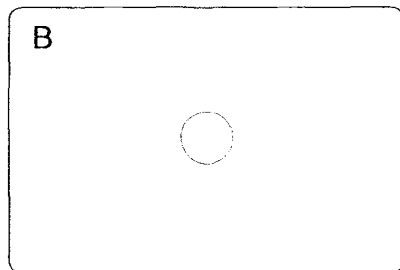

Super FP Flash

The duration of a conventional flash is extremely short. With SLR cameras equipped with focal plane shutters, the flash can normally only be synchronized at shutter speeds where the shutter opens fully. In this camera's Portrait mode, the flash duration has been extended, so synchronization is possible even when the shutter is not fully open. This system is called Super FP Flash and is especially effective for daylight sync photography with backlit scenes. Subjects can be made to stand out by opening the lens aperture fully to blur the background. Since flash output is never overpowering, it is easy to take natural-looking daylight sync pictures can with lighting similar to that used by professionals for SLR photography.

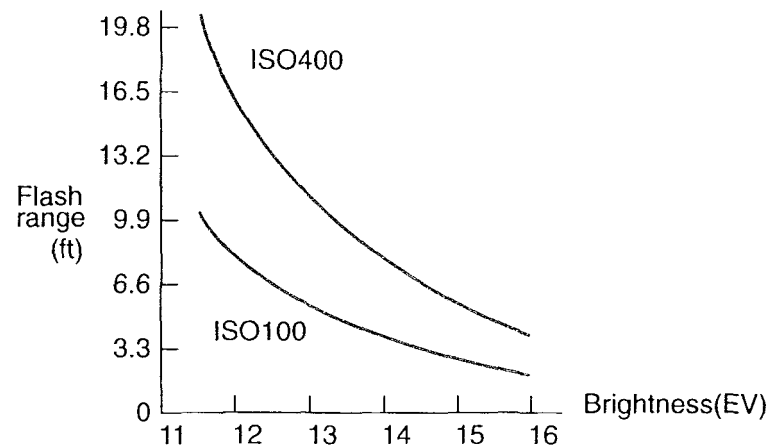

ACCESSORIES (OPTIONAL)

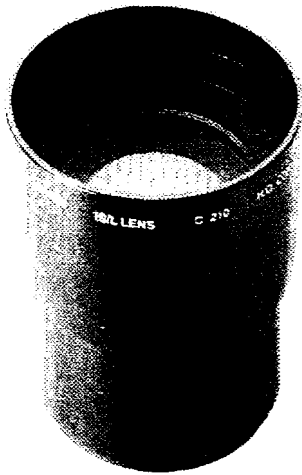

IS/L LENS C-210 H.Q.
CONVERTER 1.9X

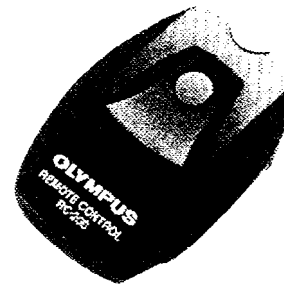

REMOTE CONTROL
RC-200

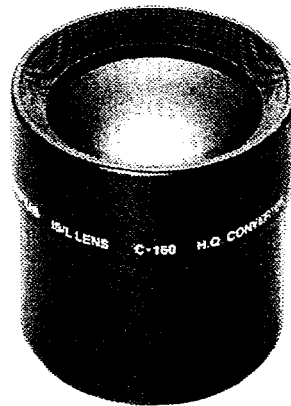

IS/L LENS C-160 H.Q.
CONVERTER 1.45X



ACTION CASE C

QUESTIONS AND ANSWERS

Q: How long will the batteries last?

A: Two new 3V lithium batteries will last for roughly 20 rolls of 24-exposure film on which the flash was used on half of all the shots (determined under Olympus test conditions). If you do not use the flash and zoom very often, the batteries will last much longer.

Q: How should I store the camera?

A: Cameras are susceptible to damage caused by dust, moisture, and salt. Wipe and dry the camera thoroughly before storing it. After using it at the beach, wipe it with a cloth that has been moistened with fresh water and then wrung out. Do not use mothballs.

Q: When does the camera measure and set the exposure?

A: When the shutter release button is pressed halfway, the camera measures both the exposure and the focus and then locks them as long as the shutter

release button remains halfway depressed. In the Spot Metering mode, the exposure is locked when the spot button is pressed.

Q: How should I clean the lens?

A: Wipe the lens gently with lens cleaning tissue that has been moistened with a small amount of lens cleaning fluid.

Q: Can I use a filter?

A: Yes, you can. Use one with a diameter of 52 mm. When you use a thick one, like a C-POL (circular-polarizing) filter, the edges of the picture plane sometimes become dark or the lens cap may not close. Be sure to turn off the power before mounting or removing a filter. When doing so, even with the power off, sometimes the lens rotates and the motor operates. This is not a malfunction.

Q: Can I use infrared film?

A: No.

CARE AND STORAGE

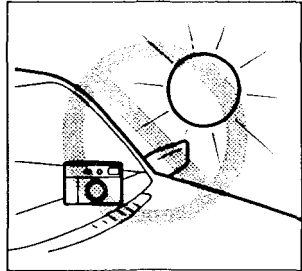

Do not leave the camera in any place exposed to excessive heat, humidity, or direct sunlight - for example, in a car or on the beach.

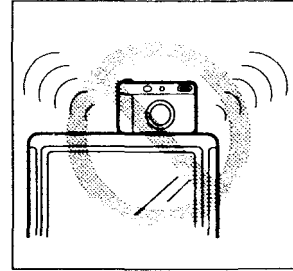

Do not leave the camera on a television, refrigerator, or speaker.

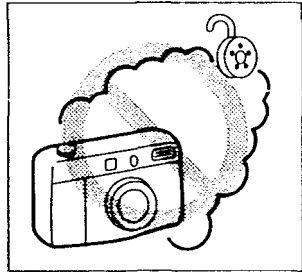

Do not expose the camera to formalin or naphthalene.

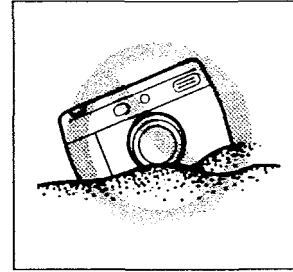

Do not expose the camera to dust or sand as this could cause serious damage.

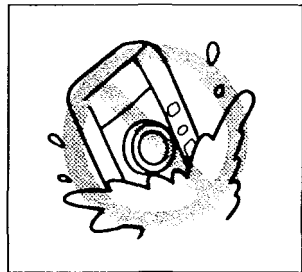

If the camera gets wet, wipe it with a dry towel immediately. The salt in seawater can be especially damaging.

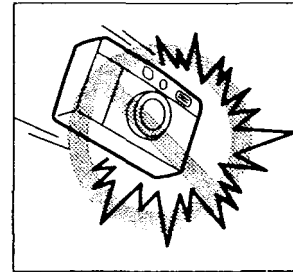

Do not shake or shock the camera.

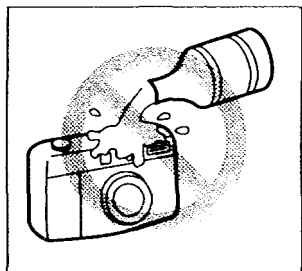

Do not use organic solvents such as alcohol or paint thinner when cleaning the camera.

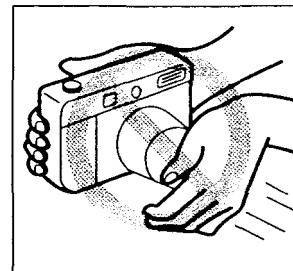

Do not apply excessive force to the zoom lens.

- Keep the camera in a well-ventilated place.
- Do not expose the camera to extreme heat (over 40°C/104°F) or to extreme cold (below -10°C/14°F). Low temperatures, even within this range, may sometimes cause deterioration in battery performance, temporarily disabling the camera.
- When transporting the camera from a cold place to a warm place or in the event of a sudden temperature change, put the camera into a plastic bag. This allows the camera's temperature to change slowly. Once the camera has adjusted to the new temperature, you can remove it from the bag and use it.
- Keep your hair, hands, strap, etc., away from the autofocus window, lens, AE sensor and flash.
- Avoid leaving the camera unused for a long period of time. This can cause mold to grow on the camera as well as other problems. Try to press the shutter release button and check the operation of the camera before use.
- Be careful when moving the camera on a tripod.
- Do not allow your film to pass through airport X-ray machines.
- Do not touch the contact points inside the camera.
- This camera is controlled by a microcomputer. Problems with the microcomputer can affect or stop camera operation. If this happens, remove the batteries, then reload them and try the camera again. Strong electrical fields can also interfere with the operation of this camera, so try to avoid places or objects that generate such fields.
- This camera is not suitable for use under severe conditions.
- Do not touch the front surface of the flash after using the flash continuously in a short time as the flash may be hot.

BATTERY HANDLING

- Do not short, disassemble or charge the batteries. Never throw batteries into fire because this can result in splitting or explosion.
- Store batteries out of the reach of children. If a battery is swallowed, consult a doctor immediately.
- Continuous use of the flash can cause battery temperature to rise. This may activate the safety circuit inside the batteries and cause the camera to stop working. In such case, allow the batteries to cool before using the camera again.
- Use the batteries correctly. Incorrect usage can result in leaking, heat and damage. When replacing the batteries, make sure the plus ⊕ and minus ⊖ terminals are correctly aligned.
- When replacing, never mix old and new batteries, or batteries of different types. Make sure both terminals are of the same type and same brand (DL123A or CR123A).
- Battery performance will drop temporarily at lower temperatures. In cold areas, protect the camera by using protective gear or placing it inside your clothing. Even when performance drops due to low temperature, it will be restored at normal temperatures.
- Sweat or oil on the plus ⊕ and minus ⊖ terminals can cause poor contact. Wipe batteries carefully with a dry cloth before use.
- We recommend that you carry spare batteries on long trips, especially in foreign countries where availability is questionable.
- Insulate used batteries by affixing tape over electrical contacts, and dispose of them as general waste according to local regulations.
- If you are not going to use the camera for an extended period of time, remove the batteries from the camera and store them in a cool, dry (low humidity) place at 20°C (68°F) or less.
- Observe the precautionary remarks written on the batteries.

TROUBLESHOOTING

Operating Problems

Symptom	Cause	Remedy	See
The camera does not work.	<ul style="list-style-type: none"> ① The power is OFF. ② The batteries are loaded incorrectly. ③ The batteries are exhausted. ④ The batteries are temporarily unable to function. ⑤ The loaded film has been rewound. ⑥ The film is incorrectly loaded. 	<ul style="list-style-type: none"> ① Set the power switch to ON. ② Reload the batteries correctly. ③ Replace the batteries with new ones. ④ Keep the camera warm while using it. ⑤ Remove the film. ⑥ Reload the film. 	<ul style="list-style-type: none"> 22 14 15 63 26 20
The LCD panel turn off suddenly.	<ul style="list-style-type: none"> ① The LCD panel turns off automatically if none of the camera's functions have been used for about 30 seconds. 	<ul style="list-style-type: none"> ① Press the FULL AUTO button, or press the shutter release button halfway. 	<ul style="list-style-type: none"> 24 43
⚡ blinks and the shutter cannot be released.	<ul style="list-style-type: none"> ① The flash has not finished recharging. 	<ul style="list-style-type: none"> ① Remove your finger from the shutter release button and wait for several seconds until recharging is completed. 	<ul style="list-style-type: none"> 31
⚡ blinks even when the flash is not flipped up.	<ul style="list-style-type: none"> ① ⚡ blinks to warn you that camera-shake is likely to occur due to insufficient light and to recommend that you use the flash to get a better result (for example, when shooting under fluorescent light). 	<ul style="list-style-type: none"> ① Flip up the flash. 	<ul style="list-style-type: none"> 30
The autofocus indicator blinks and the shutter cannot be released.	<ul style="list-style-type: none"> ① The autofocus system may not work when the subject is moving too fast, when the camera is shaking, or when the subject is difficult for autofocus to lock onto (refer to p. 54). ② The subject is closer than the camera's minimum working distance (75 cm/2.5 ft). 	<ul style="list-style-type: none"> ① First focus on something at the same distance as the subject, then recompose the frame to take the picture. ② Move 75 cm/2.5 ft or more away from the subject. 	<ul style="list-style-type: none"> 25 54 23
The camera doesn't focus on the subject even though the auxiliary flash lights.	<ul style="list-style-type: none"> ① The autofocus may not work when the subject is out of the auxiliary flash's working distance (approx. 75 cm ~ 5 m/2.5 ft ~ 16.4 ft). 	<ul style="list-style-type: none"> ① Move the camera closer to the subject. 	

Symptom	Cause	Remedy	See
The shutter doesn't release even when the shutter release button is pressed.	① The subject is not in focus.	① Make sure the subject is in focus and the autofocus indicator in the viewfinder lights.	24
	② The rewind film is still loaded.	② Remove the film.	26
The flash doesn't fire.	① Ambient light is too bright.	① Set the flash mode to Fill-In.	34
	② High-speed film is used.	② Set the flash mode to Fill-In.	34
+/- blinks in the viewfinder.	① Exposure is incorrect in the Aperture-Preferred Auto mode.	① Change the aperture until +/- stops blinking. Use the flash when available light is insufficient.	41
The shutter cannot be released by remote control.	① If no operations have been carried out in the Selftimer/Remote Control mode for about 20 minutes, the LCD panel turns off and the shutter can't be released with the remote control.	① Press the FULL AUTO button to turn on the LCD panel, and engage the Selftimer/Remote Control mode again.	

Problems with Printed Pictures

Symptom	Cause	Remedy	See
The subjects' eyes appear red in printed pictures.	① This "red-eye phenomenon" occurs with all cameras when a flash is used. It is caused by light from the flash reflecting off the retina at the back of the eye. Red-eye varies depending on the individual and shooting conditions such as ambient lighting. It is also more likely to occur when using 110 mm telephoto than when using wide-angle focal lengths.	① Use the Auto-S Flash mode to significantly reduce red-eye phenomenon.	33
The subject was within the frame of the viewfinder, but its edges are missing on the print.	① When a negative is enlarged, sometimes the edge of the frame is not printed.	① Leave some room on the edges of the frame when you compose your shots.	
The picture is out of focus.	① The camera moved when the shutter release button was pressed. ② The viewfinder's autofocus frame was not positioned on the subject. ③ The shutter release button was pressed from right in front of the camera in the Selftimer mode.	① Hold the camera correctly, and press the shutter release button gently. ② Position the autofocus frame on the subject, or use the focus lock. ③ Press the shutter release button while looking into the viewfinder, not while standing in front of the camera.	16 25 35
The picture is too dark.	① The subject was out of the working range of the flash. ② The subject was backlit. ③ The exposure compensation setting has been adjusted.	① Shoot within the working range of the flash. ② Set the flash to Fill-In mode. ③ Reset the exposure compensation dial to the "0" position.	32 34 46
The colors of pictures taken indoors look unnatural.	① The lighting fixture(s) affected the picture.	① Set the flash mode to Fill-In.	34

SPECIFICATIONS

Type: Fully automatic 35 mm autofocus single-lens reflex camera with built-in 28 mm ~ 110 mm zoom lens.

Film format: 35 mm standard DX-coded film (24 X 36 mm) switchable to Panorama format‡.

Lens: Olympus lens (filter available, 52 mm filter diameter), 28 mm ~ 110 mm F4.5 ~ 5.6, 11 elements in 9 groups (5-group zoom construction).

Shutter: Electronic control system vertical focal plane shutter. Shutter speed 1/2000-sec. ~ 4-sec. Manual F8, 1 sec ~ 60 sec.

Flash-shutter synchronization: Under 1/100 sec. (1/2,000 ~ 1/100 sec. in Portrait mode).

Focusing: TTL phase-difference detection system autofocus with focus lock. Autofocus beep available. Auxiliary flash activation in low light. (Available at distances up to 8 m (26.2 ft), determined under Olympus test conditions.) Focusing range — 0.75 m (2.5 ft) ~ ∞ (infinity). Provided with predictive autofocus (in Stop Action mode only).

Exposure compensation: ±2 EV (1/2-step).

Viewfinder: Standard/panorama switchable‡ single-lens reflex system, magnification ratio 0.72 (at 50 mm). Finder view-field — 85% of actual view-field.

Viewfinder information: Autofocus frame, spot frame, panorama frame‡, autofocus indicator, flash indicator (to be used as flash warning), overexposure/underexposure indicator.

Diopter adjustment: -2 ~ +1.

Light metering system: TTL light metering system. Fuzzy logic ESP light metering, center-weighted average light metering, spot metering.

Exposure modes: ① Program AE (Full-Auto, Stop Action, Portrait, Night Scene, Landscape). ② Aperture-Preferred Auto. ③ Long Time (manual).

Exposure counter: Progressive type, displayed on LCD panel.

Exposure counter: Progressive type, displayed on LCD panel.

Film speed range: Automatic setting with DX-coded film (ISO 25, 32, 50, 64, 100, 125, 200, 250, 400, 500, 800, 1000, 1600, 2000, 3200). Other intermediate film speeds will be automatically set for next lower speed.

Film loading: Automatic loading (automatically advances to first frame when camera back is closed).

Film advance: Automatic film winding.

Film rewind: Automatic film rewind (automatic rewind activated at end of film, automatic rewind stop). Rewind is possible at any point with rewind button.

Selftimer: Electronic selftimer with 12-sec. delay.

Remote control (optional): Infrared remote control unit, 3-sec. delay.

Flash: Built-in IVP (Intelligent Variable-Power) flash system, recycling time of about 0.2 ~ 3.9 sec. (at normal temperature).

Flash range:

Focal length	Telephoto	Wide angle
ISO 100	6.3 m (21 ft)	5.0 m (16.4 ft)
ISO 200	8.8 m (28.9 ft)	7.1 m (23.3 ft)
ISO 400	12.6 m (41 ft)	10.0 m (32.8 ft)

Flash modes: Auto (automatic flash activation in low-light, backlight, fluorescent light). Auto-S (red-eye reducing, same as Auto otherwise), Fill-In (forced activation), Off (when flash is retracted).

Battery check: Displayed on LCD panel.

Power source: Two 3V lithium batteries (DL123A or CR123A) (replaceable).

Dimensions: 123 (W) X 88 (H) X 115 (D) mm (4.8 X 3.5 X 4.5 in) (excluding protrusions).

Weight: 650 g (22.9 oz) (without batteries)

■ Quartz Date Specifications

Data recording system: Imprinting from behind film.

Types of data recording: ① Year-month-day,

② Day-hour-minute, ③ No data,

④ Month-day-year, ⑤ Day-month-year.

External display of recorded data:

Continuous LCD panel display.

Automatic calendar function:

To year 2049, self-adjusting.

Power source: One 3V lithium battery (CR2025).

SPECIFICATIONS ARE SUBJECT TO CHANGE WITHOUT ANY NOTICE OR OBLIGATION ON THE PART OF THE MANUFACTURER.

‡ **Panorama model only**

OLYMPUS®

OLYMPUS OPTICAL CO.,LTD. San-Ei Building, 22-2, Nishi Shinjuku 1-chome, Shinjuku-ku, Tokyo, Japan. Tel. 03-3340-2211

OLYMPUS AMERICA INC. Two Corporate Center Drive, Melville, NY 11747-3157, U.S.A. Tel. 516-844-5000/1-800-622-6372

OLYMPUS OPTICAL CO.(EUROPA) GMBH. (Premises/Goods delivery) Wendenstrasse 14-16, 20097 Hamburg, Germany. Tel. 040-237730
(Letters) Postfach 10 49 08, 20034 Hamburg, Germany.

OLYMPUS OPTICAL CO.(U.K.) LTD. 2-8 Honduras Street, London EC1Y0TX, United Kingdom. Tel. 0171-253-2772

奥林巴斯光学工業株式会社 日本東京都新宿区西新宿1丁目22-2 新宿サンエービル 圖文傳真 0081-3-3346-8380

奥林巴斯(香港)有限公司 香港九龍尖沙咀廣東道5號 海洋中心801室 圖文傳真 00852-2730-7976

This device complies with part 15 of the FCC Rules. Operation is subject to the conditions that this device does not cause harmful interference.

This Class B digital apparatus meets all requirements of the Canadian interference-Causing Equipment Regulations.
Cet appareil numérique de la classe B respecte toutes les exigences du Règlement sur le matériel brouilleur du Canada.

 This camera complies with EU directive 89/336/EEC for CE marking.

 Die CE-Marke zeigt an, daß diese Kamera die EG-Richtlinie 89/336EWG erfüllt.

 Cet appareil photo est conforme à la directive UE89/336/CEE pour le marquage CE.

 Esta cámara cumple con la directiva de la Union Europea 89/336/EEC para la marca de CE.