

**OLYMPUS®**

**QD**

# ***IS-50*** ***IS-500***

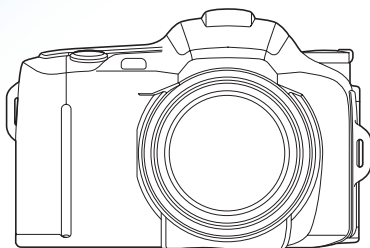

**INSTRUCTIONS** ➤ 2

**MODE D'EMPLOI** ➤ 29

**BEDIENUNGSANLEITUNG** ➤ 57

**INSTRUCCIONES** ➤ 85

**使用説明書** ➤ 113

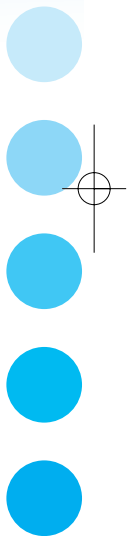

## WARNING

Read this manual carefully before using your camera.



Indicates circumstances under which mishandling resulting from ignoring this symbol could result in personal injury or property damage.

KEEP THE BATTERIES AWAY FROM FIRE. NEVER TRY TO DISASSEMBLE, RECHARGE, OR SHORT-CIRCUIT BATTERIES.

KEEP THE BATTERIES OUT OF THE REACH OF CHILDREN. IF A CHILD SWALLOWS A BATTERY, CONTACT A DOCTOR IMMEDIATELY.

NEVER ATTEMPT TO DISASSEMBLE THE CAMERA; IT CONTAINS A HIGH-VOLTAGE CIRCUIT. IF THE INTERNAL PARTS OF THE CAMERA ARE EXPOSED DUE TO DROPPING OR DAMAGE, REMOVE THE BATTERIES IMMEDIATELY TO PREVENT FURTHER USAGE.





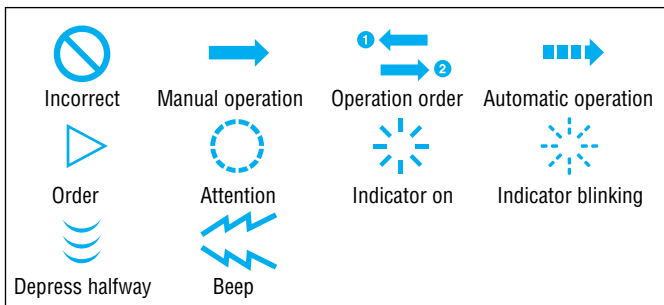





IN CASE OF MALFUNCTION, CONSULT YOUR NEAREST OLYMPUS DEALER OR OLYMPUS SERVICE CENTER.

### Symbols used in this manual:



- Pay particular attention to items in this manual enclosed in boxes .
- Products shown in pictures and illustrations may be slightly different from the actual unit.

## CONTENTS

Names of parts	2. Exposure mode button .....16
Camera Body.....4	[ <b>A</b> ] Aperture Preferred Auto ....17
Camera Body/LCD Panel .....5	[ <b>L.T.</b> ] Long Time .....18
Viewfinder Display.....6	[  ] Exposure Compensation .....19
Using the strap .....6	[  ] Spot Metering .....21
Diopter adjustment .....7	[  ] Selftimer/
Loading and checking the batteries ..7	[  ] Remote Control(Optional) ...22
Loading the film .....8	[  ] Macro Shooting .....23
Taking pictures	Restoring the Programmed Auto
Programmed Auto (FULL AUTO) ..9	[FULL AUTO] mode .....23
Focus Lock .....10	Correcting the date and time .....24
Unloading the film .....10	(Quartzdate models only)
Flash photography	Printing the date/time .....25
Setting the flash mode .....11	(Quartzdate models only)
Auto Flash .....12	Care and storage .....26
[  ] Red-Eye Reduction Flash ..13	Specifications .....27
[  ] Fill-In Flash .....13	Accessories (optional).....28
Exposure modes	
1. Direct Mode Select buttons .....14	
[  ] Stop Action .....14	
[  ] Portrait .....15	
[  ] Landscape.....15	
[  ] Night Scene .....16	

## 4 NAMES OF PARTS — Camera Body

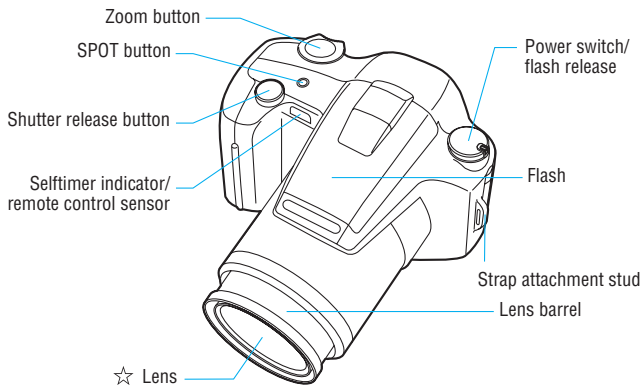

☆ Always try to keep this clean. Dirt and stains can result in pictures that are unclear and out-of-focus. Wipe off any dirt or stains with a soft cloth.

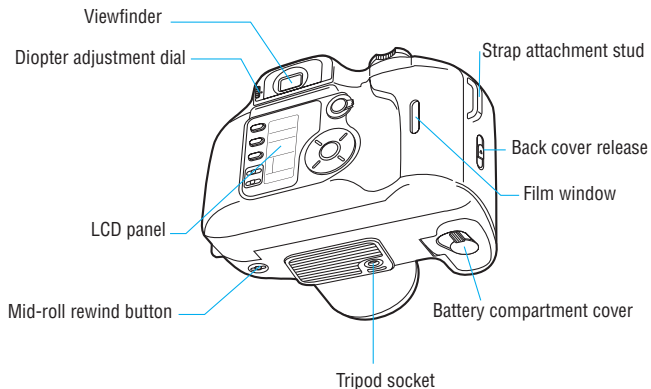

## 5 NAMES OF PARTS — Camera Body/LCD Panel

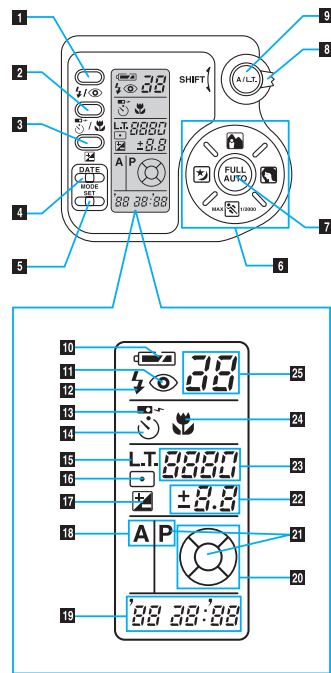

- 1 Flash mode button
- 2 Selftimer/ remote control/ macro button
- 3 Exposure compensation button
- 4 DATE MODE button\*
- 5 DATE SET button\*
- 6 Direct Mode Select buttons
- 7 **FULL AUTO** (programmed auto) button
- 8 Shift lever
- 9 Exposure mode button
- 10 Battery check
- 11 Red-Eye Reduction Flash
- 12 Fill-In Flash
- 13 Remote Control
- 14 Selftimer
- 15 Long Time
- 16 Spot Metering
- 17 Exposure Compensation
- 18 Exposure modes
- 19 Date/time indicator\*
- 20 Mode status indicator
- 21 Programmed Auto (FULL AUTO)
- 22 Aperture setting/ exposure compensation value
- 23 Shutter speed
- 24 Macro Shooting
- 25 Exposure counter

\* Quartzdate models only

## 6 NAMES OF PARTS — Viewfinder Display

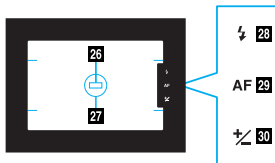

- 26 Autofocus frame
- 27 Spot frame
- 28 Flash
- 29 Autofocus indicator
- 30 Exposure compensation (overexposure/underexposure)

## DIOPTER ADJUSTMENT

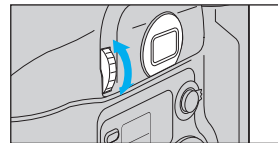

Turn the diopter adjustment dial until the autofocus frame is clear.

If you are nearsighted, turn the dial up.  
If you are farsighted, turn it down.

## LOADING AND CHECKING THE BATTERIES

Use two 3 V lithium batteries (CR123A or DL123A).

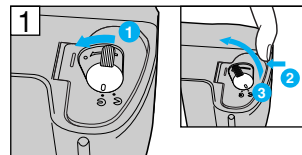

Turn the dial **1** on the battery compartment cover to  $\ominus$ . Hold the notch **2** with your fingertip. Open the cover **3**.

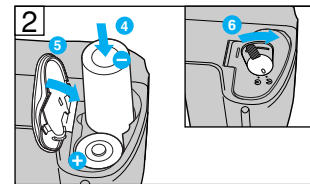

Insert the batteries **4** correctly. Close the battery compartment cover **5**. Turn the dial **6** to  $\oplus$  to lock the cover.

Make sure the power switch is set to OFF before opening the battery compartment cover.



Set the power switch **7** to ON to check the remaining battery power.

## USING THE STRAP

- Attach the strap as shown.

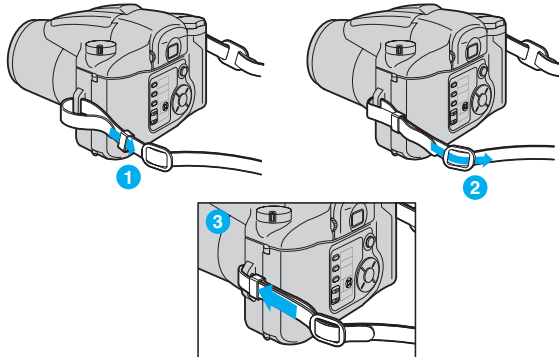

Secure the strap with the clasp.

lights (turns off automatically).	Batteries are OK. You can shoot.
blinks and other indicators are displayed normally.	Batteries are low and should be replaced with new ones.
blinks and other indicators go out.	Batteries are dead and should be replaced with new ones immediately.

## LOADING THE FILM

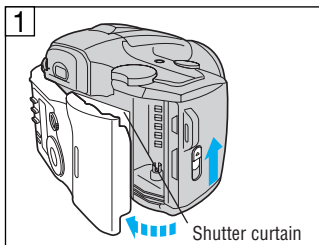

Slide the back cover release upward to open the back cover.

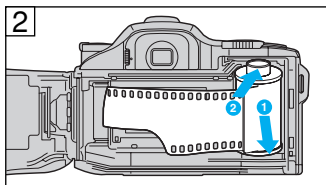

Insert the film cartridge.

Be careful not to touch the shutter curtain.

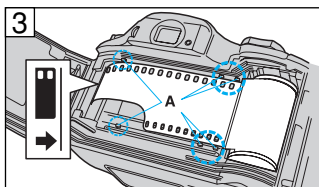

Place the film between the positioning guides (A), aligning the film leader in the direction of the arrow.

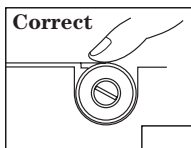

Correct

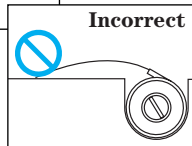

Incorrect

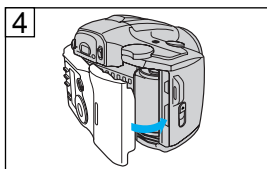

Close the back cover. The film automatically advances to the first frame. Set the power switch to ON.

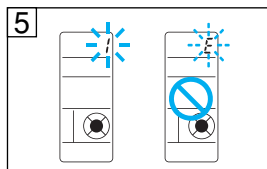

Make sure the exposure counter on the LCD panel reads “1”.

If “E” blinks, reload the film.

## TAKING PICTURES — Programmed Auto (FULL AUTO)

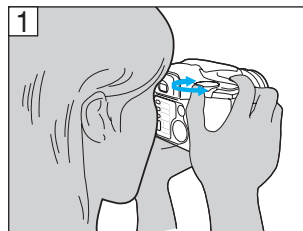

Set the power switch to ON. The lens will extrude and the LCD panel will turn on.

Compose your shot. Press the “T” side of the zoom button for telephoto (120 mm) or the “W” side for wide angle (28 mm).

After about 30 seconds of inactivity, the LCD panel goes out.



Do not look at the sun or other strong light sources through the viewfinder.

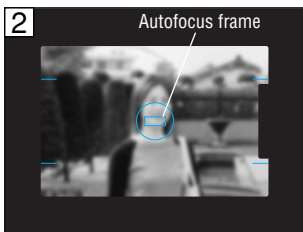

Position the autofocus frame  $\ominus$  on your subject.

- If the autofocus indicator blinks, the shutter cannot be released.
- The distance to your subject is 0.6 (2.0 ft) m to infinity at the wide-angle side and 0.9 (3.0 ft) m to infinity at the telephoto side.

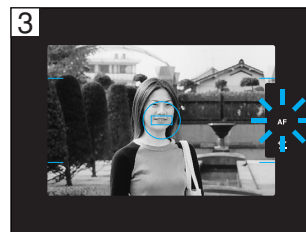

Press the shutter release button halfway to focus on the subject. After making sure that the camera beeps and the autofocus indicator lights in the viewfinder, press the shutter release button all the way to take the picture. After the shutter is released, the film automatically advances to the next frame.

## TAKING PICTURES — Focus Lock

If you want to position your main subject outside the center of the frame, follow the procedure below (focus lock).

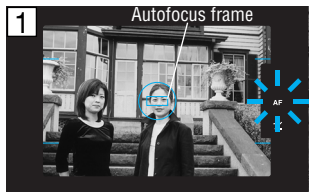

Position the autofocus frame on your subject and press the shutter release button halfway. The camera beeps, and the autofocus indicator lights in the viewfinder. The exposure is also locked at this time (AE lock).

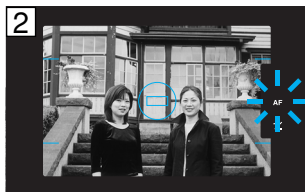

Reframe your subject while keeping the shutter release button pressed halfway. Then press the shutter release button all the way.

## UNLOADING THE FILM

The camera automatically rewinds the film when you reach the end of a roll. You can also rewind the film before it reaches the end.

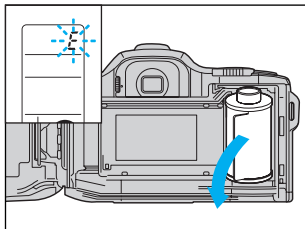

Make sure the motor has stopped and that “E” is blinking; then open the back cover to remove the film.

Rewinding the film before the end of the roll

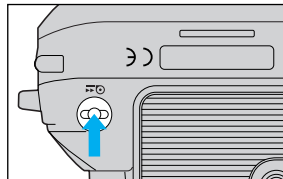

Press the mid-roll rewind button. Do not use an instrument with a sharp tip.

## FLASH PHOTOGRAPHY — Setting the Flash Mode

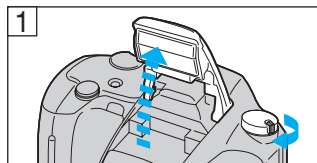

Set the power switch to  $\zeta$  to flip up the flash. The camera will recharge the flash, and the flash will be ready to use. When there is insufficient light, the flash fires automatically.

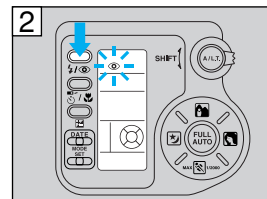

Press the  $\zeta / \text{Ⓢ}$  button to select the flash mode. The selected mode is displayed on the LCD panel.

Mode display	Flash mode	Function
No display	Auto Flash	Automatically fires in the dark, with backlighting, or under fluorescent lighting.
Eye icon	Red-Eye Reduction Flash	Significantly reduces the phenomenon of “red-eye” (when a subject’s eyes appear red in color photography).
Lightning bolt icon	Fill-In	Fires regardless of available light.

- When  $\zeta$  is blinking in the viewfinder, the flash is being recharged (for about 0.2 to 4 seconds with fresh batteries.) and the shutter cannot be released.
- When the flash fires in the Programmed Auto (**FULL AUTO**) mode, the shutter speed is automatically set at 1/100-sec.
- When the shutter release button is pressed halfway, the autofocus auxiliary light (flash) may flicker several times. Press the button fully for main flash activation.
- If  $\zeta$  is blinking in the viewfinder when the flash is not flipped up, use of the flash is recommended.



- Do not fire the flash right in front of the eyes of people and animals.
- Do not point the camera at a motorist and fire the flash.

## FLASH PHOTOGRAPHY — Auto Flash

The flash automatically fires in the selected exposure mode when required (in the dark, with backlighting, or under fluorescent lighting).

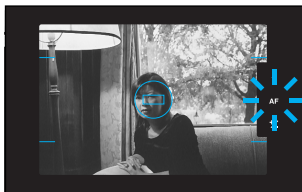

If  lights in the viewfinder when the shutter release button is pressed halfway, the flash will fire.

### Flash working range (with color negative film)

ISO	Wide angle (W) at F4.9	Telephoto (T) at F6.8
100	3.7 m (12.1 ft)	4.2 m (13.8 ft)
200	5.3 m (17.4 ft)	5.9 m (19.3 ft)
400	7.4 m (24.3 ft)	8.4 m (27.5 ft)

The figures in this table apply to the Programmed Auto mode and low-light conditions. When reversal film is used, the working range at the telephoto side will be reduced by about 30%.

In flash photography with this camera, the shutter speed is set to 1/100-sec. If you select the shutter speed higher than that, the flash won't fire.

## FLASH PHOTOGRAPHY — Red-Eye Reduction Flash

In this mode, the camera emits a series of pre-flashes before the main flash activates. This helps minimize the “red-eye” phenomenon (when a subject's eyes are illuminated by the flash and appear red in a color photograph).

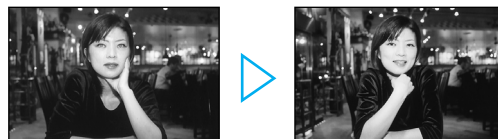

- Hold the camera securely. It takes about 1 second until the shutter releases.
  - Red-eye reduction may not be effective when the subject:
    1. Is not looking at the flash from right in front.
    2. Is not watching the pre-flashes.
    3. Is too far from the camera.
- The effectiveness of red-eye reduction varies depending on the individual characteristics of each subject.
- Do not use the flash in the Stop Action mode (p.14).

## FLASH PHOTOGRAPHY — Fill-In Flash

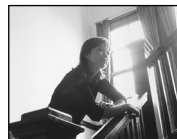

Use this mode when you want the flash to fire for each shot. The flash fires regardless of available light. Both the subject and background can be clearly shot.



- This mode is less effective in extremely bright conditions.
- The Fill-In Flash mode can be used with the Programmed Auto mode and Aperture Preferred Auto mode (p.17).

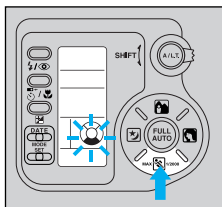

To make it easier to take clear, properly illuminated photographs under a variety of conditions, four exposure modes optimized for the most common shooting conditions are available.

**How to select the exposure mode**

Press the Direct Mode Select button that best suits the shooting conditions or desired effect.

MAX  1/2000	<b>Stop Action</b>	Use this mode to freeze moving subjects.
	<b>Portrait</b>	Use this mode to take a head-and-shoulders picture with a blurred background.
	<b>Landscape</b>	Use this mode to take pictures with extended in-focus backgrounds.
	<b>Night Scene</b>	Use this mode to shoot a night scene without artificially illuminating the subject.

**Stop Action** Use this mode to freeze moving subjects.



The shutter speed is automatically set higher to reduce the “movement” of a moving subject (1/2000-sec. at max.).

- The camera continually adjusts focus on the subject as long as the shutter release button is pressed halfway. The camera beeps twice the first time the subject comes into focus.
- When the subject is moving too fast, the shutter will not release.
- Use the Auto Flash mode in flash photography.

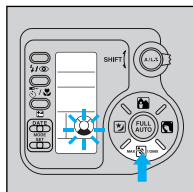

Press the button. Compose your shot, and press the shutter release button.

**Portrait**

Use this mode to take a head-and-shoulders picture with a blurred background.



The blurred background is particularly useful in telephoto shooting and when the background is distant. The flash is synchronized with the shutter up to 1/2000-sec. in this mode.

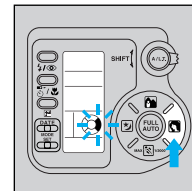

Press the button. Compose your shot, and press the shutter release button.

- The aperture is set wide-open.
- Use of the flash makes the subject stand out.

**Landscape**

Use this mode to take pictures with extended in-focus backgrounds.



This mode is useful for shooting landscapes or for shooting subjects in the foreground while keeping all surrounding objects (both near and far) in sharp focus.

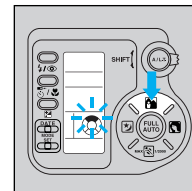

Press the button. Compose your shot, and press the shutter release button.

For optimum results, use this mode with the lens set to wide-angle side.



## 1. Direct Mode Select Buttons

### Night Scene

Use this mode to shoot a night scene without artificially illuminating the subject.

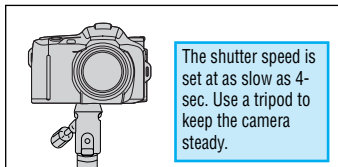

In this mode, you can shoot clear pictures at night without over-illuminating the subject and blackening out the background.

- When shooting subjects against a nighttime background, combine this mode with the flash.
- Do not use the flash when you are shooting night scenes only.

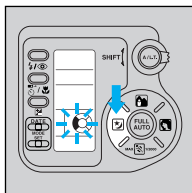



Press the  button. Compose your shot, and press the shutter release button.

## EXPOSURE MODES — 2. Exposure Mode Button

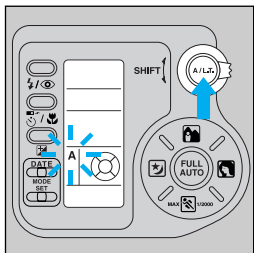
For more versatile exposure control, you can use the Aperture Preferred Auto mode or Long Time mode.



Press the exposure mode button to select “A” (Aperture Preferred Auto) or “L.T.” (Long Time).

 P	Programmed Auto
 A	Aperture Preferred Auto
 L.T.	Long Time

## 2. Exposure Mode Button

### Aperture Preferred Auto [A]

By selecting the aperture on your own, you can control the blurring of the background. The shutter speed is controlled automatically.





Select a smaller aperture (larger value) for a sharper background.

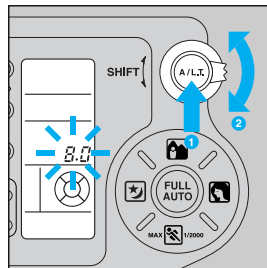
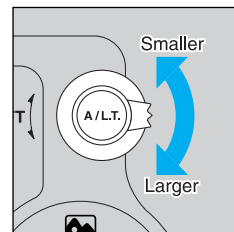

Select a larger aperture (smaller value) for a blurred background.



Press the exposure mode button  to select “A” (Aperture Preferred Auto). Push the shift lever  upward to stop down the aperture by 0.5 step. Push the lever  downward to return to a wide aperture.

If the shutter speed indicator blinks in the viewfinder when the shutter release button is pressed halfway, it means overexposure or underexposure. Change the aperture setting until the indicator stops blinking.

## 2. Exposure Mode Button

### Long Time [L.T.]

This mode is ideal for capturing pictures of fireworks and other bright lights at night. You can select the shutter speed from 1-sec. to 60-sec. The aperture is fixed at F8.

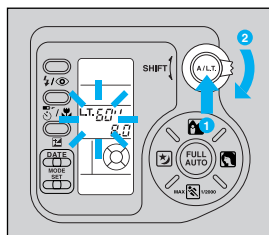
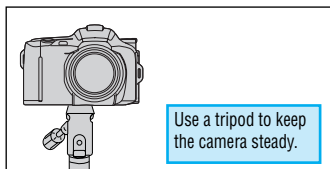

Press the exposure mode button **1** to enter the Long Time mode (“L.T.”). As you press the shift lever **2** downward, the shutter speed changes in the order of 1, 2, 4, 8, 15, 30, and 60-sec. (When you push the shift lever upward, the shutter speed changes in the reverse order.)

## EXPOSURE COMPENSATION [ ]

In this mode, you can deliberately make your picture brighter or darker as desired. Exposure compensation is possible up or down to  $\pm 2$  EV by 0.5 step.

▼ To make a whitish subject whiter (+2 EV compensation)

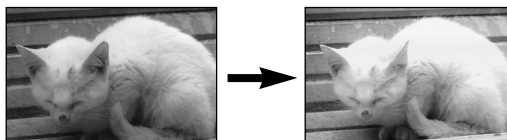

▼ To shoot a backlit subject (+1 EV compensation)

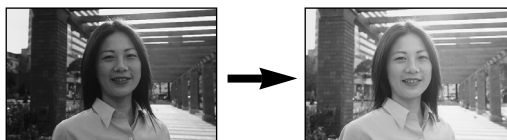

▼ To make a blackish subject blacker (-2 EV compensation)

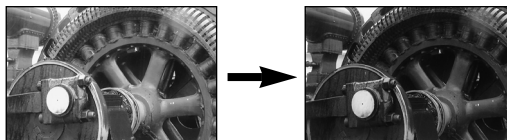

▼ To mimic a twilight scene when shooting in daylight (-2 EV compensation)



- + Compensation (to make the whole picture lighter)
  - Whitish subject
  - Backlit subject
  - Snow scene
- - Compensation (to make the whole picture darker)
  - Blackish subject
  - Subject with a black background
  - Subject in spotlight

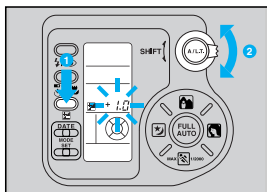

While keeping the exposure compensation button **1** pressed, use the shift lever **2** to select the exposure compensation value. The exposure compensation value is displayed on the LCD panel only when the exposure compensation button is pressed.

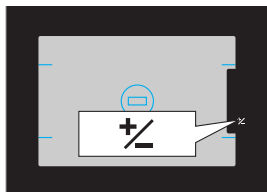

When the shutter release button is pressed halfway,  $\pm$  lights in the viewfinder.

To cancel the Exposure Compensation mode, set the exposure compensation value back to  $\pm$ .

- In the Exposure Compensation mode, the flash strength will also be corrected.
- When color negative film is used, pictures will be corrected when they are printed, which makes it difficult to see the effect of exposure compensation.

## SPOT METERING [ ]

This mode accurately measures a small area such as a person's face to enable you to shoot a picture with the brightness precisely adjusted to the subject.

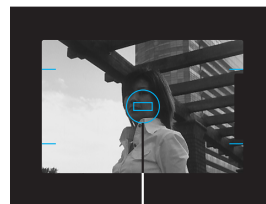

Spot frame

Position the spot frame on the area where you want to measure the light. When there is an extreme difference in the brightness of the subject and background, use of the Spot Metering mode is recommended (in backlighting, for example).

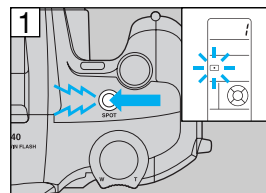

Press the SPOT button. The  mark, aperture setting and shutter speed will be displayed on the LCD panel. The exposure determined by light metering will be locked.



Press the shutter release button all the way.

- When the flash is flipped up or the Night Scene mode is engaged, the camera will not perform spot metering.
- When the shutter releases, the Spot Metering mode is canceled.
- To cancel the mode without taking a shot, press the SPOT button again.

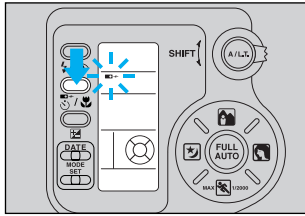

As you press the selftimer/ remote control/ macro button, the mode changes as follows:

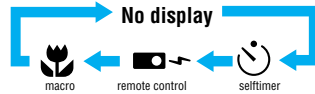

**When in the Selftimer mode**

Secure the camera on a tripod or other support. Compose your shot in the viewfinder. Press the shutter release button halfway (the focus and exposure are locked at this time). Then press the shutter release button all the way. The selftimer indicator lights for about 10 seconds and then blinks for about 2 seconds. After this, the shutter will release.

- The Selftimer mode is automatically disengaged after shutter release.
- To cancel the selftimer after it has been activated, press the selftimer/ remote control button again.

**When in the Remote Control mode**

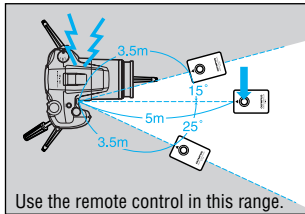

Use the remote control in this range.

Compose your shot in the viewfinder. Position the autofocus frame on your subject. To take a picture, point the remote control at the camera and press the button on the remote control. The camera starts beeping, and the shutter will release about 3 seconds later.

Press the selftimer/ remote control button again to cancel the mode.

For more details on the remote control (including how to insert the battery), see the separate instructions provided for the remote control.

Close-up photography from 0.6 (2.0 ft) m to infinity is possible throughout the focal length.

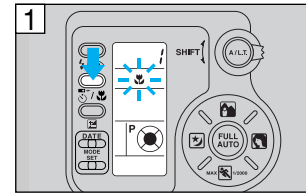

Press the macro button to display  .

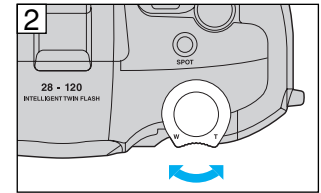

Compose your shot using the zoom button.

- When your subject is closer than 0.6 m (2.0 ft), the camera may be unable to focus on the subject although the autofocus indicator lights.
- To cancel the Macro mode, press the macro button again to turn off  .

**RESTORING THE PROGRAMMED AUTO [FULL AUTO] MODE**

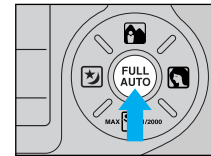

You can return to the Programmed Auto (FULL AUTO) mode at the touch of a button.

Press the **FULL AUTO** button to display “P” on the LCD panel. Setting the power switch to OFF and then ON again also restores the Programmed Auto mode.

**Setting in the Programmed Auto (FULL AUTO) mode**

- |                  |   |
|------------------|---|
| : Exposure mode  | Standard Program  |
| : Flash mode     | Auto Flash or Red-Eye Reduction Flash                                     |
| : Canceled modes | Spot Metering, Macro, Exposure Compensation, Remote Control and Selftimer |

Setting the Programmed Auto mode with the exposure mode button only switches the flash mode to Auto Flash or Red-Eye Reduction Flash; all other modes remain the same except the exposure mode (“A”).

Be sure to correct the date and time after the batteries have been inserted or replaced.

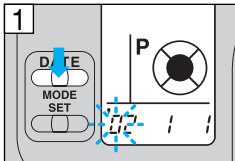

To set the “year” indicator:

1 Keep the **MODE** button pressed until the “year” indicator starts blinking.

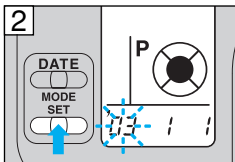

2 Press the **SET** button to adjust the “year” indicator. If you press the button once, the number on the display will advance by 1. If you keep the button pressed, the numbers will run in rapid succession. If you pass the intended number, keep pressing to return to that number.

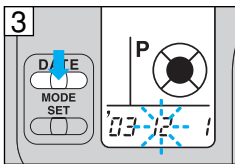

To set the “month” indicator:

3 Press the **MODE** button once more to make the “month” indicator blink. Press the **SET** button to adjust the “month” indicator.

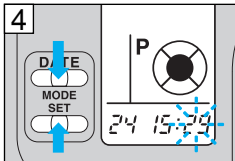

As you press the **MODE** button, the blinking indicator changes in the order of “year”, “month”, “day”, “hour” and “minute”.

4 Repeat Steps 2 and 3 to set “hour” and “minute”.

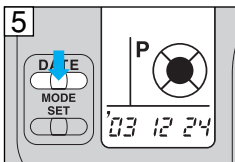

5 When “minute” has been set, press the **MODE** button. None of the indicators will be blinking and date/time correction is now complete.

First select the date/time mode you want to print.

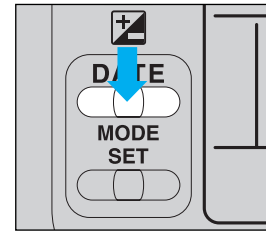

Press the **MODE** button. As you press it, the mode will switch in the order shown below.

Keep the mode you want to print displayed.

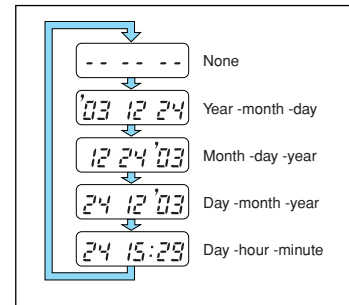

- The date unit uses the same power source as the main unit. Be sure to correct the date and time after the batteries are replaced.
- The date/time is imprinted in the lower right corner of the picture. If the date/time is superimposed on a bright color like white, orange, yellow, etc., it may be difficult to read.
- The date/time may not be imprinted correctly on the frame(s) after the specified final exposure of the film.
- When black-and-white film is used, the date/time may not be printed.

- Do not leave the camera in any place exposed to excessive heat, humidity or direct sunlight — for example, in a car or on the beach.
- Do not expose the camera to formalin or naphthalene.
- If the camera gets wet, wipe it with a dry towel. The salt in seawater can be especially damaging.
- Do not use organic solvents such as alcohol or paint thinner when cleaning the camera.
- Do not leave the camera on or near a television, refrigerator or other appliance with a magnetic field.
- Do not expose the camera to dust or sand as this could cause serious damage.
- Do not shake or shock the camera.
- Do not apply excessive force to the zoom lens.
- Do not expose the camera to extreme heat (over 40°C/ 104°F) or to extreme cold (below -10°C/ 14°F). Low temperatures, even within this range may sometimes cause deterioration in battery performance, temporarily disabling the camera.
- Avoid leaving the camera unused for long periods of time. This can cause mold to grow on the camera as well as other problems. Try to press the shutter release button and check the operation of the camera before use.
- Some airport X-ray machines can damage the film in your camera. Try to avoid passing your camera through these machines. Give it to the security officer for manual inspection.
- Do not touch the front surface of the flash after using the flash continuously in a short time as the flash may be hot.

Type:	Fully automatic 35 mm autofocus single-lens reflex camera with built-in 28 mm ~ 120 mm zoom lens.
Film format:	35 mm standard DX-coded film (24 x 36 mm).
Lens:	Olympus lens (filter available, 52 mm filter diameter), 28 mm~ 120 mm, F4.9 ~ 6.8, 15 elements in 10 groups (4-gourp zoom construction), 1 ED lens included.
Shutter:	Electronic control system vertical focal plane shutter. Shutter speed — 1/2000-sec. ~ 4-sec. in Manual mode; 1 sec. ~ 60 sec. in Long Time Mode.
Flash-shutter synchronization:	Under 1/100-sec. (Full synchronization up to 1/2000-sec. with Super FP Activation in Portrait mode).
Focusing:	TTL phase-difference detection system (with autofocus beep). Auxiliary flash activation in low light — 6m (19.7ft) working distance (determined under Olympus test conditions). Focus lock possible. Focusing range — 0.6 m (2ft) ~ ∞ (infinity) in macro shooting; 0.6 m (2ft) ~ ∞ (infinity) at wide angle and 0.9 m (3ft) ~ ∞ (infinity) at telephoto in standard shooting. Provided with predictive autofocus (in Stop Action mode only).
Viewfinder:	Single-lens reflex system, magnification ratio 0.72 (at 50 mm). Finder view-field — 85% of actual view-field.
Viewfinder information:	Autofocus frame, autofocus indicator, spot frame, flash indicator (also used as flash warning), overexposure/underexposure indicator (also used as exposure compensation indicator).
Diopter adjustment:	-2 ~ +1.
Light metering system:	TTL light metering system, ESP light metering, center-weighted average light metering and spot metering.
Exposure compensation:	±2 EV (1/2 step).
Exposure modes:	Programmed AE (FULL AUTO, Stop Action, Portrait, Night Scene and Landscape), Aperture Preferred AE. and Long Time.
Exposure counter:	Progressive type displayed on LCD panel.
Film speed range:	Automatic setting with DX-coded film (ISO 25, 32, 50, 64, 100, 125, 200, 250, 400, 500, 800 1000, 1600, 2000 or 3200). Other intermediate film speeds will be automatically set for next lower speed.
Film loading:	Automatic loading. (Automatically advances to first frame when camera back is closed.)
Film advance:	Automatic film winding.
Film rewind:	Automatic film rewind (automatic rewind activation at end of film, automatic rewind stop). Rewind possible at any point with rewind button.
Selftimer:	Electronic shutter with 12-sec. delay.

**Remote control(Optional):**

Infrared remote control unit with 3-sec. delay.

**Flash:** Built-in IVP (Intelligent Variable-Power) flash system with Super FP Activation. Manually flipped up. Recycling time — Approx. 0.2 ~ 4 sec. (at normal temperature). Flash working range — 0.6 m ~ 3.7 m (2.0 ~ 12.1ft) at wide angle and 0.9 m ~ 4.2 m (3.0 ~ 13.8ft) at telephoto with ISO 100 color negative film; 0.6 m ~ 7.4 m (2.0 ~ 24.3ft) at wide angle and 0.9 m ~ 8.4 m (3.0 ~ 27.5ft) at telephoto with ISO 400 color negative film.

**Flash modes:** Auto Flash (automatic flash activation in low-light, back light and fluorescent light), Red-Eye Reduction Flash (same as auto otherwise), Fill-In (forced activation) and Super FP Activation.

**Battery check:** Displayed on LCD panel.

**Power source:** Two 3 V lithium batteries (DL123A or CR123A).

**Dimensions:** 125 (W) x 87 (H) x 124 (D) mm(4.9 x 3.4 x 4.9 in) (extruding protrusions).

**Weight:** 650 g (22.9 oz)(without batteries).

■ Specifications for Date Unit \* Quartzdate models only

**Data recording system:** Imprinting from behind film.

**Types of data recording:** (1) None. (2) Year-month-day. (3) Month-day-year. (4) Day-month-year. (5) Day-hour-minute.

**External display of recorded data:** Continuous LCD panel display.

**Automatic calendar function:** To year 2032.

SPECIFICATIONS ARE SUBJECT TO CHANGE WITHOUT ANY NOTICE OR OBLIGATION ON THE PRODUCT OF THE MANUFACTURER. THE ACTUAL PRODUCT MAY DIFFER FROM ONES SHOWN IN THIS MANUAL.

## ACCESSORIES (OPTIONAL)

- Teleconverter  
IS/L LENS E-1.3X  
H.Q.TELECONVERTER



- Remote Control  
RC-300C

