

DIGITAL CAMERA

OLYMPUS[®]

Stylus 1030 SW / μ 1030 SW

Advanced Manual

Quick Start Guide

Get started using your camera right away.

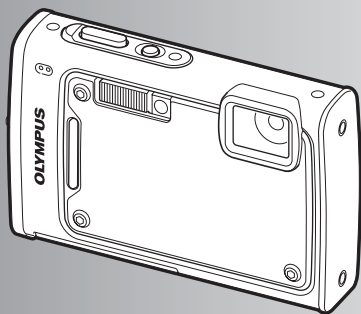

Button operations

Menu operations

Printing pictures

Using OLYMPUS Master

Getting to know your camera better

Appendix

- Thank you for purchasing an Olympus digital camera. Before you start to use your new camera, please read these instructions carefully to enjoy optimum performance and a longer service life. Keep this manual in a safe place for future reference.
- We recommend that you take test shots to get accustomed to your camera before taking important photographs.
- In the interest of continually improving products, Olympus reserves the right to update or modify information contained in this manual.
- The screen and camera illustrations shown in this manual were produced during the development stages and may differ from the actual product.

Quick Start Guide P. 3

Button operations P. 11

Test out the functions of the camera buttons by following along with the illustrations.

Menu operations P. 21

Learn about the menus that control the functions and settings for basic operation.

Printing pictures P. 41

Learn how to print pictures you have taken.

Using OLYMPUS Master P. 46

Learn how to transfer and save pictures to a computer.

Getting to know your camera better P. 51

Find out more about camera operations and how to take better pictures.

Appendix P. 62

Read about convenient functions and safety precautions on how to use your camera more effectively.

Gather these items (box contents)



Digital Camera



Strap



LI-50B
Lithium Ion Battery

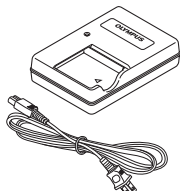

LI-50C
Battery Charger

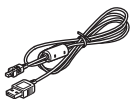

USB Cable

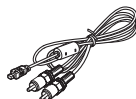

AV Cable



OLYMPUS Master 2
Software CD-ROM

Items not shown: Advanced Manual (this manual), Basic Manual, warranty card. Contents may vary depending on purchase location.

Attach the strap

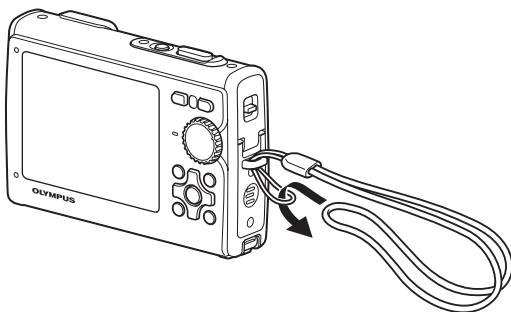

- Pull the strap tight so that it does not come loose.

Prepare the camera

a. Charge the battery.

! Note

- There are two types of the LI-50C battery charger, one is “AC cable type” and the other is “plug-in type”. Depending on the region where you purchased the camera, the included battery charger type differs. We explain here how to use the AC cable type battery charger as an example. If you received the plug-in type battery charger, plug it directly into an AC outlet.

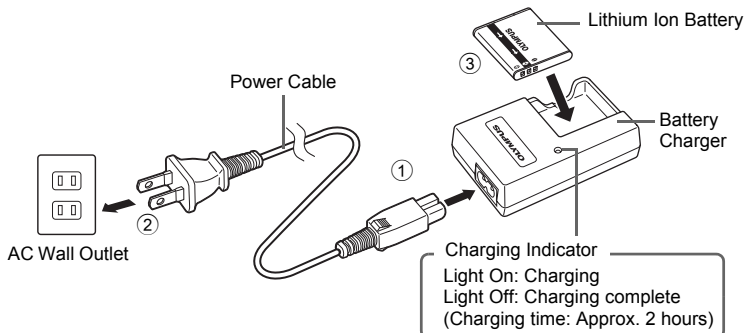

- Battery comes partially charged.

b. Insert the battery and an xD-Picture Card (optional) in the camera.

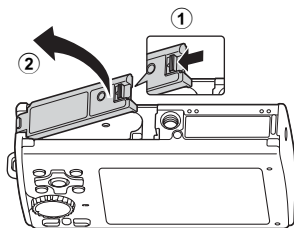

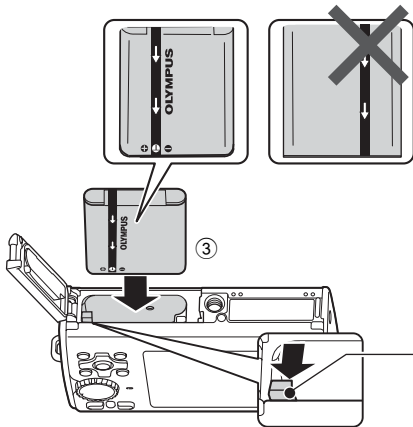

- **Insert the battery in the orientation shown in the illustration.**

If you insert the battery reversely, the camera will not turn on even if the **POWER** button is pressed.

Battery lock knob

To remove the battery, slide the battery lock knob in the direction of the arrow.

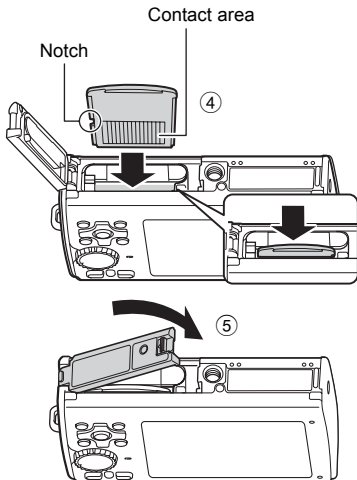

- **Orient the card as shown in the illustration and insert it straight into the card slot.**

Insert the card until it clicks into place.

To remove the card, push it all the way in and release it slowly. Then grasp the card and remove.

- You can shoot pictures with this camera even without using an optional xD-Picture Card™ (hereinafter referred to as “the card”). If an xD-Picture Card is not inserted, your pictures will be saved to the internal memory. For details on the card, please refer to “The card” (P. 63).

Turn the camera on

This explains how to turn on the camera in shooting mode.

a. Set the mode dial to **AUTO**.

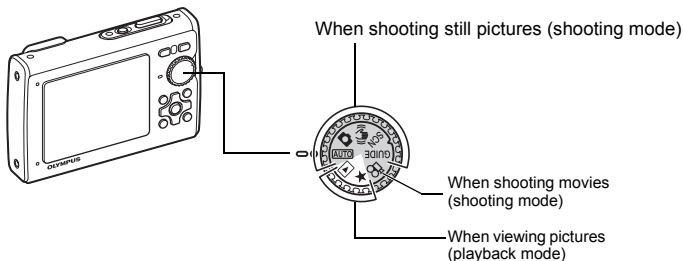

Still picture shooting modes

AUTO	This function allows you to shoot with the camera's automatic settings.
	The camera automatically sets the optimum aperture value and shutter speed.
	This function reduces the blur incurred by a moving subject, or camera shake when taking pictures.
SCN	This function allows you to shoot pictures by selecting a scene according to the shooting condition.
GUIDE	This function allows you to set the target items by following the shooting guide displayed on the screen.

b. Press the **POWER** button.

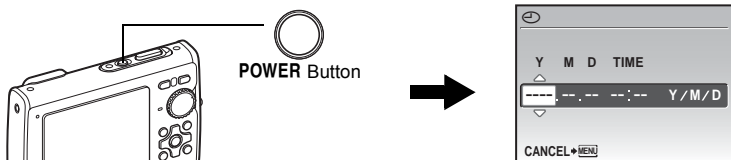

- When the date and time have not yet been set, this screen will appear.

- To turn off the camera, press the **POWER** button once again.

Hint

The directions of the arrow pad ($\triangle \nabla \leftarrow \rightarrow$) are indicated with $\triangle \nabla \leftarrow \rightarrow$ in this manual.

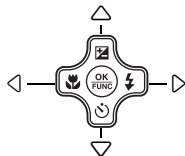

Set date and time

About the date and time setting screen

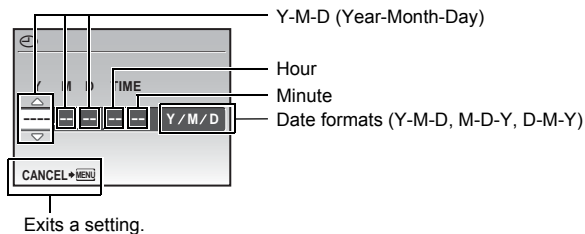

a. Press the button and the button to select [Y].

- The first two digits of the year are fixed.

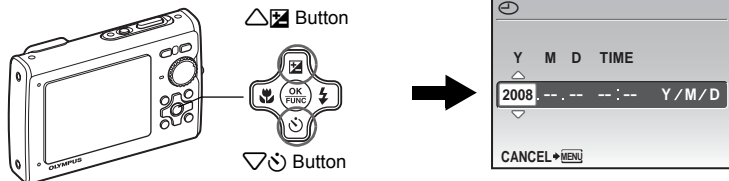

b. Press the button.

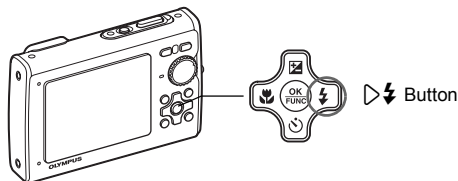

c. Press the button and the button to select [M].

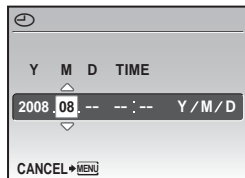

d. Press the button.

- e. Press the button and the button to select [D].

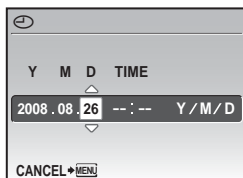

- f. Press the button.

- g. Press the button and the button to select the hours and minutes.

- The time is displayed in the 24-hour format.

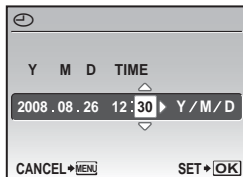

- h. Press the button.

- i. Press the button and the button to select [Y/M/D].

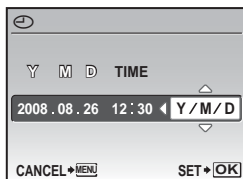

- j. After all items have been set, press the button.

- For precise time setting, press the button as the time signal strikes 00 seconds.

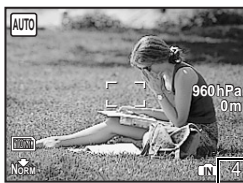
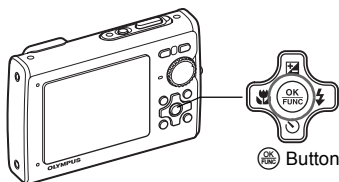

The number of storable still pictures is displayed.

Take a picture

a. Hold the camera.

Horizontal grip

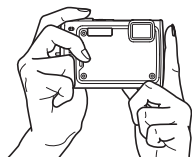

Vertical grip

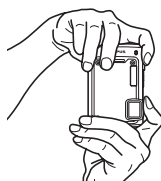

b. Focus.

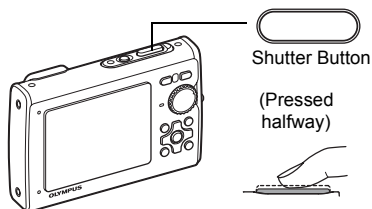

- The AF target mark lights in green when the focus and exposure are locked. The shutter speed and aperture value are displayed.
- If the AF target mark blinks red, the camera is unable to focus. Try locking the focus again.

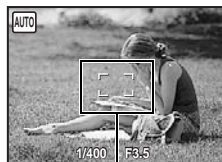

AF target mark
Place this mark over your subject.

c. Shoot.

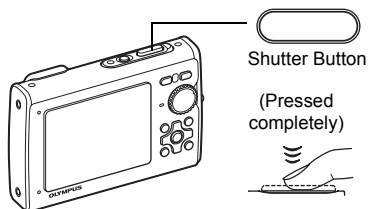

The card access lamp blinks.

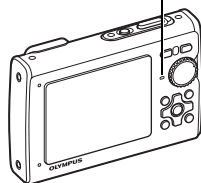

View pictures

- a. Set the mode dial to .

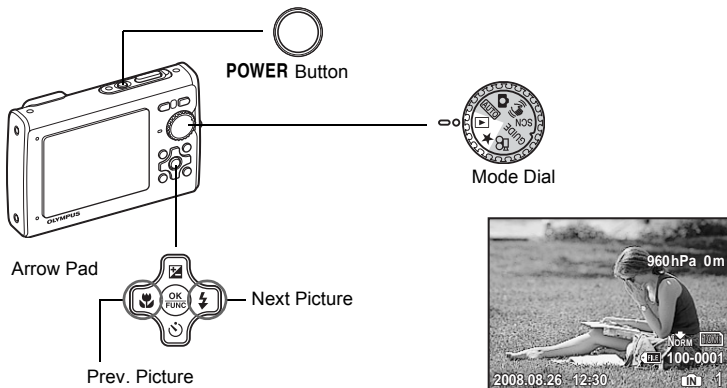

Erase pictures

- a. Press the  button and the  button to display the picture that you want to erase.
b. Press the  button.

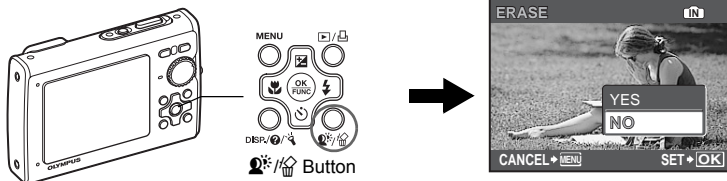

- c. Press the  button to select [YES] and press the  button to erase the picture.

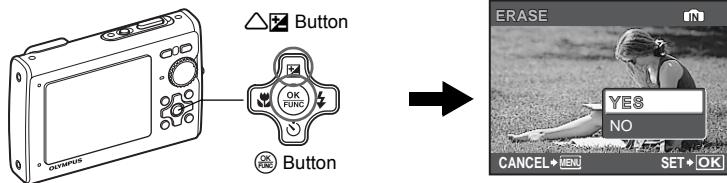

Button operations

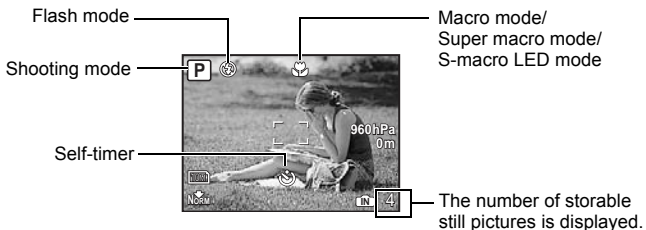
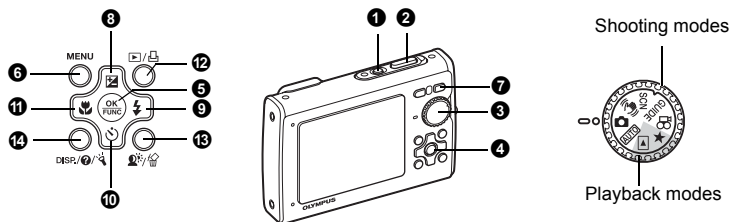

1 POWER button

Turning the camera on and off

Power on:

- Shooting mode
- Lens cover opens
- Monitor turns on

Playback mode

- Monitor turns on

2 Shutter button

Shooting pictures

Shooting still pictures

Set the mode dial to **AUTO**, **SCN** or **GUIDE**, and lightly press the shutter button (halfway). The AF target mark lights in green when the focus and exposure are locked (focus lock). The shutter speed and aperture value are displayed (only when the mode dial is set to **AUTO**, **SCN** or **GUIDE**). Now, press the shutter button all the way (completely) to shoot a picture.

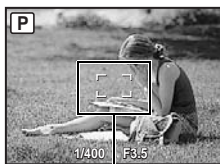

AF target mark

Focus lock - Locking the focus and then composing the shot

Compose your picture with the focus locked, and then fully press the shutter button to shoot a picture.

- If the AF target mark blinks red, the camera is unable to focus. Try locking the focus again.

AF lock mark

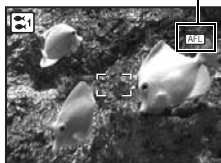

AF Lock - Locking the focus position

When the scene is or , you can lock the focus position by pressing . Press again to cancel the AF lock.

SCN (Scene) Selecting a scene mode according to the shooting situation" (P. 26)

- AF lock is automatically canceled after one shot.

Recording movies

Set the mode dial to , and press the shutter button halfway to lock the focus, and then press the shutter button completely to start recording. Press the shutter button again to stop recording.

3 Mode dial

Switching between shooting and playback modes

Set the mode dial to the desired shooting or playback mode.

AUTO Shooting pictures with full automatic settings

The camera determines the optimum settings for the shooting conditions automatically. Setting in the [CAMERA MENU] such as white balance and ISO sensitivity cannot be changed.

(P:Program auto) Set the optimum aperture value and shutter speed

The camera automatically sets the optimum aperture value and shutter speed for the brightness of the subject.

Setting in the [CAMERA MENU] such as white balance and ISO sensitivity can be changed.

Shooting pictures using digital image stabilization

This function reduces the blur caused by a moving subject or camera movement when taking pictures.

- By switching to another mode, most settings will be changed to the default settings of each mode.

SCN Shoot pictures by selecting a scene mode according to the situation

You can shoot pictures by selecting a scene mode according to the situation.

Select a scene mode/change another scene mode to another one

- Press **MENU** and select [SCN] from the top menu. Use the to select a scene and press .
- By switching to another scene mode, most settings will be changed to the default settings of each scene mode.

SCN (Scene) Selecting a scene mode according to the shooting situation" (P. 26)

GUIDE Follow the shooting guide to take better pictures

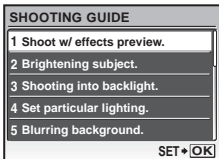

Follow the shooting guide displayed on the screen to set the target items.

- Press **MENU** to display the shooting guide again.
- To change the setting without using the shooting guide, set the shooting mode to another one.
- Functions set using the shooting guide will revert to the default settings when **MENU** is pressed or when the shooting mode is changed.

Shoot pictures by comparing previews of different effects

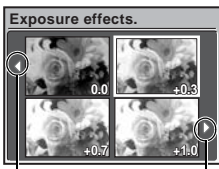

Select one of the [1 Shoot w/ effects preview.] options from the [SHOOTING GUIDE] menu to preview a live, multi-frame window on the monitor showing four different levels of the selected shooting effect. You can use the four preview frames to compare the desired setting/effect.

- Use the arrow pad to select the frame with the desired settings and press **REC**. The camera automatically switches to shooting mode and allows you to shoot with the selected effect.

Use **◀▶** to change the display.

When [Exposure effects.] is selected

Recording movies

Audio is recorded with the movie (When [MOVIE] is set to [NON-WATER MOVIE]).

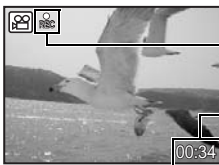

This icon lights during movie recording.

The remaining recording time is displayed. When the remaining recording time reaches 0, recording will stop automatically.

- You can switch the movie recording mode between [NON-WATER MOVIE] and [UNDERWATER MOVIE].

☞ "MOVIE Switching the movie recording mode" (P. 27)

View pictures/Selecting playback mode

The last picture taken is displayed.

- Press the arrow pad to view other pictures.
- Use the zoom button to switch between close-up playback, index display and calendar display.

Playing back movies

Select the movie in the playback mode and press  to play.



Operations during movie playback





Playing time/Total recording time

: Increases the volume.

: Reduces the volume.

: Each time you press the button, the playback speed changes in the following order: 2x; 20x; and back to 1x.

: Plays the movie in reverse. Each time you press the button, the playback speed changes in the following order: 1x; 2x; 20x; and back to 1x.

- Press  to pause the playback.

Operations during pause

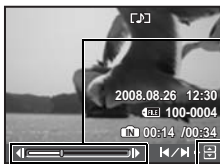

: Displays the next frame.

: Displays the previous frame.

: Displays the first frame.

: Displays the last frame.

- To resume the movie, press .
- To cancel the playback of the movie in the middle of it or during pause, press **MENU**.

Viewing panoramic pictures taken with [COMBINE IN CAMERA 1] [COMBINE IN CAMERA 2] (Panorama playback)



- Use the arrow pad to select a panoramic picture and press  to begin scrolling the picture from left to right (or bottom to top for rotated pictures).

- Use the zoom button to zoom in or out while a picture is scrolling. Use the arrow pad to change the scrolling direction of a zoomed in picture.

- To stop or resume scrolling in the original magnification, press .

- To exit panorama playback, press **MENU**.

 "PANORAMA Taking and combining panoramic pictures" (P. 24)

★ Viewing “My Favorite”



The still pictures registered in “My Favorite” are displayed.

- Press the arrow pad to view other pictures.
- Use the zoom button to switch among close-up playback and index display.

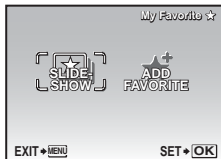

Press **MENU** during “My Favorite” playback to display the top menu, and then select [SLIDESHOW] or [ADD FAVORITE].

- ☞ “SLIDESHOW Playing back pictures automatically” (P. 30)
- ☞ “ADD FAVORITE Adding favorite images” (P. 31)

Erasing pictures from “My Favorite”

YES / NO

- Use the arrow pad to select the picture you want to erase, and press . Select [YES], and press .
- Erasing a picture from “My Favorite” does not erase the original picture recorded in the internal memory or to the card.

4 Arrow pad (△▽◀▶)

Use the arrow pad to select scenes, playback pictures, and to select the items on the menus.

5 button (OK/FUNC)

Displays the Function Menu which contains the functions and settings used during shooting. This button is also used to confirm your selection.

The functions you can set with the Function Menu

- ☞ “WB Adjusting the color of a picture” (P. 27)
- ☞ “ISO Changing the ISO sensitivity” (P. 28)
- ☞ “DRIVE Using sequential (continuous) shooting” (P. 28)
- ☞ “ESP/ Changing the area for measuring the brightness of a subject” (P. 29)
- ☞ “IMAGE QUALITY Changing the image quality” (P. 23)

Function Menu

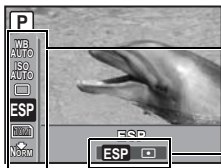

The current camera settings are displayed.

△▽: Select the function to be set.

◀▶: Select a setting, and press .

6 MENU button (MENU)

Displaying the top menu

Displays the top menu.

7 Zoom button

Zooming while shooting/Close-up playback

Shooting mode: Zooming in on your subject

Optical zoom ratio: 3.6×

Zoom out:
Press W on the
zoom button.

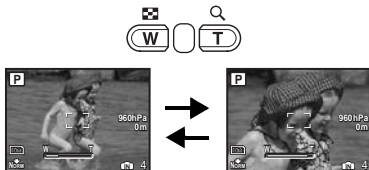

Zoom in:
Press T on the
zoom button.

Playback mode: Changing the picture display

Single-frame playback

- Use the arrow pad to browse pictures.

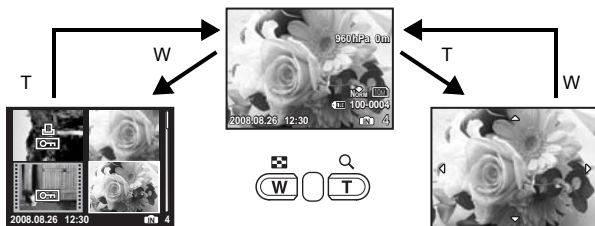

Close-up playback

- Press T to incrementally enlarge the picture up to 10 times the original size. Press W to reduce the size.
- Use the arrow pad during close-up playback to scroll around the picture.
- Press to return to single-frame playback.

Index display

- Use the arrow pad to select a picture for playback, and press to play back the single-frame of the picture selected.

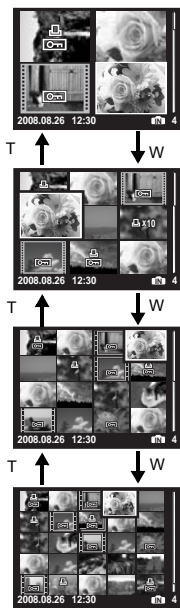

Calendar display



- Use the arrow pad to select the date, and press or T on the zoom button to display the picture on the date selected.



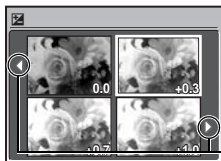

8 button

Changing picture brightness (Exposure Compensation)





Press  in shooting mode, use the arrow pad to select the frame with the desired brightness. Press  to confirm your selection.





- Adjustable from -2.0 EV to +2.0 EV.

Use   to change the display.

9 button



Flash shooting

Press  in shooting mode to select the flash setting.
Press  to confirm your selection.

	Auto-flash	The flash fires automatically in low light or backlight conditions.
	Red-eye reduction flash	This emits pre-flashes to reduce the occurrence of red-eye in your pictures.
	Fill-in flash	The flash fires regardless of the available light.
	Flash off	The flash does not fire.

10 button

Self-timer shooting



Press  in shooting mode to select on and off for the self-timer.
Press  to confirm your selection.



OFF	Cancel the self-timer.
ON	Set the self-timer.

- After pressing the shutter button completely, the self-timer lamp lights for approximately 10 seconds, blinks for approximately 2 seconds, and then the picture is taken.
- To cancel the self-timer, press .
- Self-timer shooting is automatically canceled after one shot.

11 button

Shooting pictures close to the subject (Macro mode)

Press  in shooting mode to select the macro mode.
Press  to confirm your selection.

OFF	Macro mode off	Macro mode is deactivated.
	Macro mode	This mode lets you shoot as close as 10 cm/3.9 in. (wide) and 30 cm/11.8 in. (tele) from your subject.
	Super macro mode	This mode lets you shoot as close as 2 cm/0.8 in. from your subject. If the distance between the camera and the subject is over 50 cm/19.7 in., the picture will be out of focus.
	S-macro LED mode	The LED light illuminates from 7 cm/2.8 in. to 20 cm/7.9 in. from the lens in super macro mode. Press the shutter button halfway to turn on the LED light.

- Zoom and flash cannot be used in super macro mode/S-macro LED mode.
- [ISO] is fixed at [AUTO] when shooting in S-macro LED mode.

 "ISO Changing the ISO sensitivity" (P. 28)

Viewing pictures immediately

Press in shooting mode to switch to playback mode and display the last picture taken. Press again or press the shutter button halfway to return to shooting mode.
 “ View pictures/Selecting playback mode” (P. 13)

Printing pictures

When a printer is connected to the camera, display the picture you want to print in playback mode and press .

“EASY PRINT” (P. 41)

Brightening the subject against backlight

Press in shooting mode to turn on or off Shadow Adjustment Technology. Press for setting. A frame is displayed on the monitor around your subject's face (except for /). This function makes the subject's face appear brighter, even against strong backlighting, and adjusts the background to ensure proper exposure of your picture.

OFF	Shadow Adjustment Technology is deactivated.
ON	Shadow Adjustment Technology is activated.

- It may take a few seconds until the frame is displayed on the monitor.
 - The faces may not be detected depending on the subject.
 - When [ON] is selected, the following setting restrictions apply:
 - [ESP/] is fixed at [ESP].
 - [AF MODE] is fixed at [FACE DETECT].
 - You can also use Shadow Adjustment Technology to compensate for backlighting in shot still pictures.
- “PERFECT FIX Editing images” (P. 30)

Erasing pictures

In playback mode, select the picture you want to erase, and press .

- Once erased, pictures cannot be restored. Check each picture before erasing to avoid accidentally erasing pictures you want to keep.

“ Protecting pictures” (P. 33)

Displaying the button guide

Hold down in shooting mode to display the guide indicating the location of the buttons.

DISP. Changing the information displays

Press DISP. to change the display in the following order.

Shooting mode

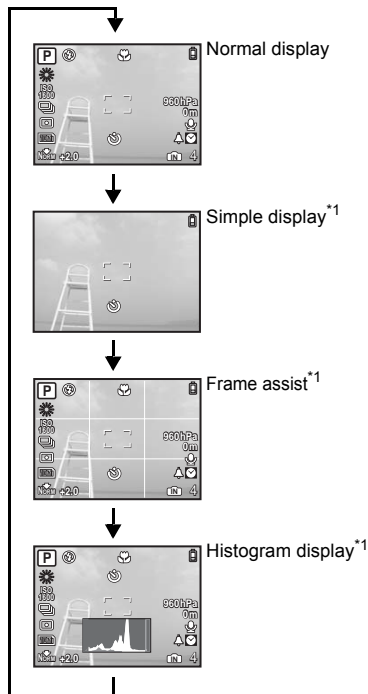

Playback mode

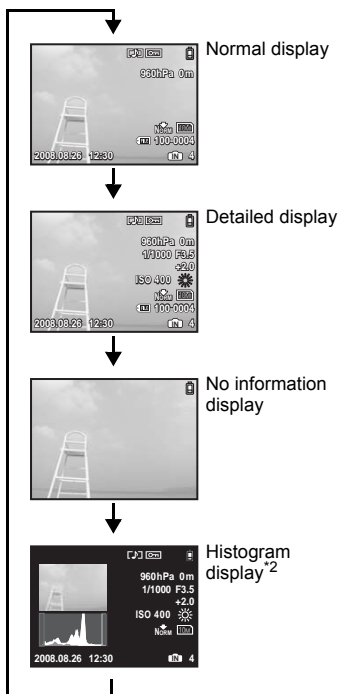

*1 This is not displayed when the mode dial is set to or GUIDE.

*2 This is not displayed when a movie is selected.

Displaying the menu guide

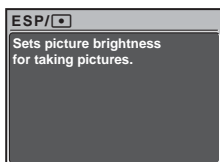

With a menu item highlighted, press and hold down to display the menu guide which will provide more information on the function or setting.

Turning on the LED illuminator

When [LED ILLUMINATOR] is set to [ON], hold down  to turn on the LED illuminator.



 "LED ILLUMINATOR Setting the LED illuminator function"
(P. 40)

- The LED illuminator can be turned on even when the camera is off.
- To turn off the LED illuminator, hold down  again, or perform no operations for 30 seconds and allow it turn off automatically.
- If you perform an operation when the LED illuminator is on, it will be kept on for a maximum of 90 seconds.

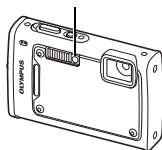
LED illuminator



Checking the time

While the camera is off, press **DISP./****/** to display the set alarm time (when [ALARM CLOCK] is set) and the current time for 3 seconds.

Menu operations

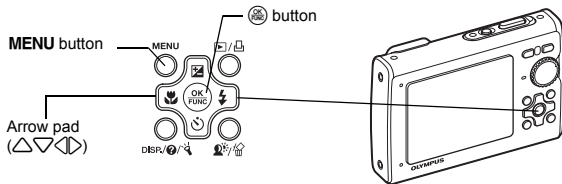

About the menu

Pressing **MENU** displays the top menu on the monitor.

- The items displayed on the top menu differ according to the mode.

Top menu (in still picture shooting mode)

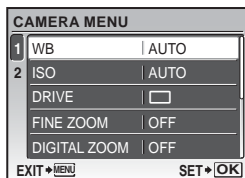
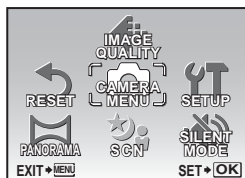

- When [CAMERA MENU], [PLAYBACK MENU], [EDIT], [ERASE], or [SETUP] is selected, the menu corresponding to the respective functions is displayed.
- When the mode dial is set to **GUIDE** and the settings are made by following the shooting guide, press **MENU** to display the shooting guide screen.

Operation guide

During menu operations, the buttons and their respective functions are displayed at the bottom of the monitor. Follow these guides to navigate the menus.

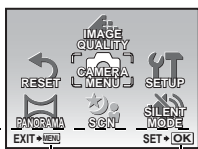

MENU button



BACK+MENU : Returns to the previous menu.



EXIT+MENU : Exits the menu.

SET+OK : Sets the selected item.

Operation guide





Using the menus

This explains how to use the menus with the [AF MODE] setting as an example.

- 1 Set the mode dial to .
- 2 Press **MENU** to display the top menu. Select [CAMERA MENU] and press  to confirm your selection.

- [AF MODE] is one of the selections on the [CAMERA MENU]. Press  to confirm your selection.

- 3 Use the arrow pad   to select [AF MODE], and press .

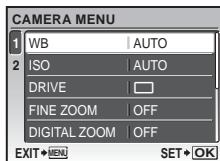
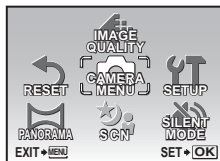

- Some settings may not be available, depending on the shooting/scene mode.
- When pressing  on this screen, the cursor moves to the page display. Press   to change the page. To select an item or function, press  or .

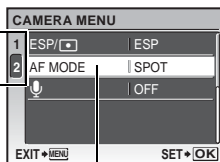

Page display: _____
The page display mark is displayed when there are additional menu items on the next page.



The selected item is displayed in a different color.

- 4 Use the arrow pad   to select [FACE DETECT], [iESP] or [SPOT], and press .

- The menu item is set and the previous menu is displayed. Press **MENU** to exit the menu.
- To cancel changes and continue menu operation, press **MENU** before pressing .

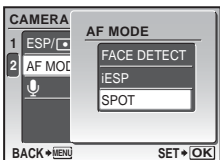

In still picture shooting mode

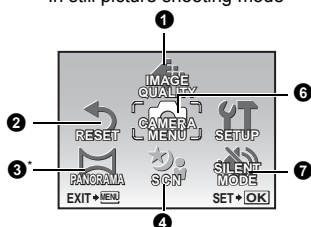



6 CAMERA MENU

WB	DIGITAL ZOOM
ISO	ESP/ 
DRIVE	AF MODE
FINE ZOOM	

* An Olympus xD-Picture Card is required.

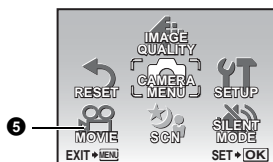
In movie recording mode



- Some functions are not available in certain modes.
-  “Functions available in shooting modes and scene modes” (P. 60)
-  “SETUP menus” (P. 35)
- The factory default settings are displayed in gray ().

1 IMAGE QUALITY

Changing the image quality

This function allows you to set [IMAGE SIZE] and [COMPRESSION] ([FRAME RATE] when recording movies).

Still picture image quality and their applications

IMAGE SIZE	Application
10M 3648 × 2736	• Suitable for printing pictures over A3 (11 × 17 in.).
5M 2560 × 1920	• Suitable for printing pictures at A4 (8.5 × 11 in.).
3M 2048 × 1536	• Suitable for printing pictures up to A4 (8 × 11 in.).
2M 1600 × 1200	• Suitable for printing pictures at A5 (5 × 7 in.).
1M 1280 × 960	• Suitable for printing pictures at postcard size.
VGA 640 × 480	• Suitable for viewing pictures on a TV or using pictures on emails and web sites.
16:9 1920 × 1080	• Suitable for playing pictures at Wide screen TV.

COMPRESSION

FINE FINE	• Shooting at high quality.
NORM NORMAL	• Shooting at normal quality.

Movie image quality

IMAGE SIZE

VGA 640 × 480

QVGA 320 × 240

FRAME RATE

30 30 frames/sec.

15 15 frames/sec.

 "Number of storable still pictures and recording length of movies" (P. 54)







2 RESET

Restoring default settings

NO / YES

It restores shooting functions back to default settings. The mode dial must not be set to **GUIDE**.

Functions restored to the factory default settings

Function	Factory default setting	Ref. Page
	0.0	P. 17
	AUTO	P. 17
	OFF	P. 17
	OFF	P. 17
Shadow Adjustment Technology	OFF	P. 18
IMAGE SIZE (Still picture/ Movie)	10M / QVGA	P. 23
COMPRESSION (Still picture)	NORM	P. 23
FRAME RATE (Movie)	15	P. 23
WB	AUTO	P. 27
ISO	AUTO	P. 28
DRIVE		P. 28
FINE ZOOM	OFF	P. 28
DIGITAL ZOOM	OFF	P. 28
ESP/ 	ESP	P. 29
AF MODE	SPOT	P. 29
	OFF	P. 29

3 PANORAMA

Taking and combining panoramic pictures

COMBINE IN CAMERA1	While panning the camera, the camera automatically shoots and combines pictures in the camera.
COMBINE IN CAMERA2	Pictures are manually shot, and the camera automatically combines pictures in the camera.
COMBINE IN PC	Pictures are manually shot to be combined on a computer.

- An Olympus xD-Picture Card is required for shooting.
- When the card capacity is insufficient, this function cannot be selected.

[COMBINE IN CAMERA 1]

While panning the camera, the camera automatically shoots and combines pictures for a single panoramic picture in the camera. Only combined pictures are saved.

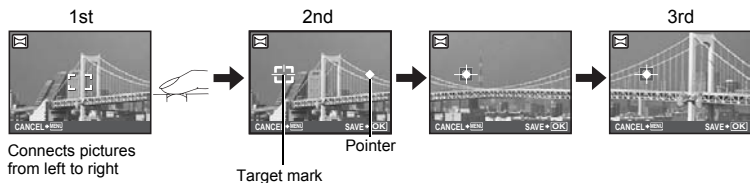

- Take the first picture.
- When you slightly move the camera in the direction of the next picture, a target mark and a pointer appear.
- The pointer moves as you pan the camera. Move the camera slowly and steadily until the pointer overlaps the target mark, then stay still.
- The camera shoots the second picture automatically.
- After the current subject appears on the monitor, take the third picture in the same manner as the second one.
- After the third picture is taken, the pictures are automatically combined, and then the combined picture is displayed. To combine only two pictures, press before shooting the third picture.
- To cancel making the panoramic picture during shooting, press **MENU** before pressing .

[COMBINE IN CAMERA 2]

Pictures are manually shot, and the camera automatically combines pictures for a single panoramic picture in the camera. Only combined pictures are saved.

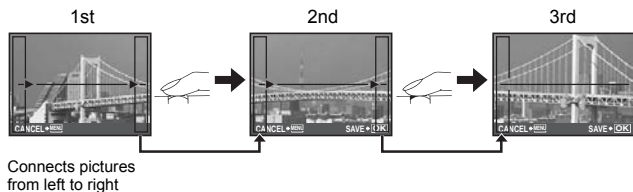

- Use to specify at which edge you want to connect the pictures, and then take the first picture.
- Compose your second shot so that the edge of the first picture overlaps the edge of the second picture, then shoot.
- Take the third picture in the same manner as the second one.
- After the third picture is taken, the pictures are automatically combined, and then the combined picture is displayed. To combine only two pictures, press before shooting the third picture.
- To cancel making the panoramic picture during shooting, press **MENU** before pressing .

[COMBINE IN PC]

Create a panoramic picture using the OLYMPUS Master software from the provided CD-ROM.

Connects pictures from left to right

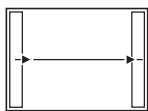

- ▷: The next picture is connected at the right edge.
- ◁: The next picture is connected at the left edge.

Connects pictures from bottom to top

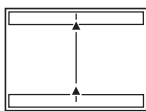

- △: The next picture is connected at the top.
- ▽: The next picture is connected at the bottom.

Use the arrow pad to specify at which edge you want to connect the pictures, and then compose your shots so that the edges of the pictures overlap.

Shooting is possible for up to 10 pictures. Press to exit panorama shooting.

- In [COMBINE IN PC], the part of the previous picture where it will be joined to the next picture does not remain in the frame. You have to remember what the part in the frame looked like and take the next picture so it overlaps.

! Note

- Focus, exposure, WB and zoom are locked in the first frame, and the flash does not fire.
- In [COMBINE IN CAMERA1] / [COMBINE IN CAMERA2] mode, camera settings are automatically optimized for this mode. In [COMBINE IN PC] mode, pictures are taken in the last [ISO] or [SCN] settings (except for some scene modes).
- In PANORAMA mode, Shadow Adjustment Technology is not available.

4 SCN (Scene)

Selecting a scene mode according to the shooting situation

PORTRAIT / LANDSCAPE / LANDSCAPE+PORTRAIT / NIGHT SCENE*¹ /
NIGHT+PORTRAIT*¹ / SPORT / INDOOR / CANDLE*¹ / SELF PORTRAIT /
AVAILABLE LIGHT*¹ / SUNSET*¹ / FIREWORKS*¹ / CUISINE / BEHIND GLASS /
DOCUMENTS / AUCTION*² / SHOOT & SELECT1*² / SHOOT & SELECT2*³ /
BEACH & SNOW / PRE-CAPTURE MOVIE / UNDERWATER SNAPSHOT*⁴ /
UNDERWATER WIDE*⁴ / UNDERWATER WIDE2*⁴ / UNDERWATER MACRO*⁴

The scene mode selection screen displays sample images as well as a description of the shooting situation for which it is designed. It can be set only when the mode dial is set to **SCN**.

"Mode dial Switching between shooting and playback modes" (P. 12)

- By switching to another scene mode, most settings will be changed to the default settings of each scene mode.

*1 When the subject is dark, noise reduction is automatically activated. This approximately doubles the shooting time, during which no other pictures can be taken.

*2 The focus is locked at the first frame.

*3 The camera focuses for each frame.

*4 Use a waterproof protector when using the camera at depths exceeding 10 m (32.8 ft.).

*5 The focus distance is fixed at approximately 5.0 m (16.4 ft.).

Scene mode selection screen



Sets the scene mode.

[SHOOT & SELECT1]/[SHOOT & SELECT2]

- These scene modes allow you to take sequential pictures by holding down the shutter button. After shooting the pictures, select the ones you want to erase by marking them with a ✓ and press to erase them.



[PRE-CAPTURE MOVIE]

- After the scene mode is fixed, the total of 7 seconds, from 2 seconds before pressing the shutter button until 5 seconds after pressing the shutter button, are recorded as a movie.
- Sound is not recorded.
- AF target mark is not displayed.
- The optical zoom and auto focus function are available during movie recording.
- For [IMAGE QUALITY] settings, select [IMAGE SIZE] from [VGA] or [QVGA], and [FRAME RATE] from [30] or [15].

5 MOVIE

Switching the movie recording mode

NON-WATER MOVIE	Suitable for recording movies out of water. The optical zoom is not available during movie recording but the sound can be recorded.
UNDERWATER MOVIE	Suitable for recording movies under water. The optical zoom is available during movie recording but the sound cannot be recorded.



6 CAMERA MENU

WB Adjusting the color of a picture

Still picture/Movie ([NON-WATER MOVIE])

AUTO		The white balance is adjusted automatically for natural color, regardless of the light source.
	Sunny day	For shooting under a clear sky.
	Cloudy day	For shooting under a cloudy sky.
	Tungsten light	For shooting under tungsten lighting.
	Fluorescent lamp 1	For shooting under daylight fluorescent lamp. (This type of lamp is mainly used in homes.)
	Fluorescent lamp 2	For shooting under a neutral white fluorescent lamp. (This type of lamp is mainly used in desk lamps.)
	Fluorescent lamp 3	For shooting under a white fluorescent lamp. (This type of lamp is mainly used in offices.)



Movie ([UNDERWATER MOVIE])

 1	Under water 1	Adjusts the color balance to be suitable for under water shooting.
 2	Under water 2	
 3	Under water 3	





ISO Changing the ISO sensitivity

AUTO	Sensitivity is automatically adjusted according to the conditions of the subject.
80/100/200/400/ 800/1600	A low value lowers the sensitivity for daylight shooting of clear, sharp pictures. The higher the value, the better the camera's light sensitivity and ability to shoot with a fast shutter speed and in low light conditions. However, high sensitivity introduces noise into the resulting picture, which may give it a grainy appearance.

DRIVE Using sequential (continuous) shooting

	Shoots 1 frame at a time when the shutter button is pressed.
	Focus and exposure are locked at the first frame. The sequential shooting speed varies depending on the image quality setting.
	Pictures can be taken at a faster speed than normal sequential shooting.

You can take a sequence of pictures at one time by holding down the shutter button. The camera will take pictures continuously until you release the shutter button.

- When  is selected, the following setting restrictions apply:
 - The flash mode is fixed at .
 - [ISO] is fixed at [AUTO].
 - [IMAGE SIZE] is limited to  and lower.
 - [FINE ZOOM], [DIGITAL ZOOM] and  are not available.

FINE ZOOM Zooming in on your subject without reducing image quality

OFF / ON

This function allows you to zoom up to 21× by combining the optical zoom and image cropping. This function will not reduce the image quality since it does not convert the data with fewer pixels into the data with larger pixels.

- The available zoom factor varies depending on the [IMAGE QUALITY] setting.
- [IMAGE SIZE] is limited to  and lower.

DIGITAL ZOOM Zooming in on your subject

OFF / ON

The digital zoom can be used to take close-up shots with stronger magnification when combined with optical zoom. (Optical Zoom × Digital Zoom: maximum 18×)

- This function cannot be set when [FINE ZOOM] is [ON].

Optical zoom



Digital zoom

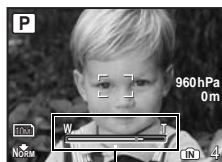

Zoom bar
 White : The optical zoom area
 Yellow : The digital zoom area

ESP/ Changing the area for measuring the brightness of a subject

ESP	Meters the brightness at the center of the monitor and the surrounding area separately to capture an image with balanced brightness. When taking pictures against strong backlight, the center of the picture may appear dark.
	Only the center of the monitor is metered. Recommended for taking a picture against strong backlight.

AF MODE Changing the focusing area

FACE DETECT	The camera searches a face within the frame and focus on it.
iESP	The camera determines which subject within the screen to focus on. Even when the subject is not in the center of the screen, focusing is possible.
SPOT	Focus selection is based on the subject within the AF target mark.

- Even when [FACE DETECT] is set, faces may not be detected depending on the subject.
- When [FACE DETECT] or [iESP] is selected, AF target mark is not displayed in shooting standby.

..... Recording sound with still pictures

OFF / ON

When activated [ON], the camera will record about 4 seconds of audio after the picture is taken.
 When recording, aim the camera microphone at the source of the sound you want to record.
 When holding the camera, keep your fingers away from the microphone.



7 SILENT MODE

Turning off camera sounds

OFF / ON

This function allows you to mute operational sounds during shooting and playback (e.g. warning beeps, shutter sounds, etc...).

4 EDIT

- 📄 *2
- 📄 *2
- COLOR EDIT *2
- FRAME *2
- LABEL *2
- CALENDAR *2
- INDEX *3

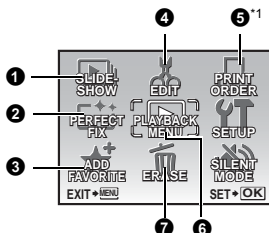

6 PLAYBACK MENU



- *1 A card is required.
- *2 This is not displayed when a movie is selected.
- *3 This is not displayed when a still picture is selected.

👉 “SETUP menus” (P. 35)

“SILENT MODE Turning off camera sounds” (P. 29)

- The factory default settings are displayed in gray ().

1 SLIDESHOW

Playing back pictures automatically

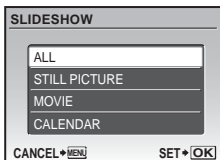

- Select the type of materials to be viewed as a slideshow from [ALL], [STILL PICTURE], [MOVIE] or [CALENDAR].
- When selecting [STILL PICTURE], also select the transition effect between pictures from [TYPE].
- When selecting [CALENDAR], also select the date of the material to play.
- Set [BGM] to [OFF], [1] or [2].

SLIDESHOW	ALL / STILL PICTURE / MOVIE / CALENDAR
TYPE	NORMAL / FADER / SLIDE / ZOOM
BGM	OFF / 1 / 2

- After setting [BGM], press to start the slideshow.
- Press or **MENU** to cancel the slideshow.

2 PERFECT FIX

Editing images

The recorded image is corrected and saved as a new one.

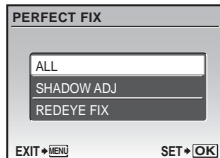

- Use to select the item you want to edit and press to execute the selected feature.
- Use to display picture you want to edit and press .

ALL	Shadow adjustment and red-eye fix are activated together.
SHADOW ADJ	Edit only the portions that photographed dark when there is backlighting.
REDEYE FIX	Corrects a subject with red-eye.

- Movies, pictures shot by another camera, and previously fixed or edited pictures cannot be corrected.
- Depending on the picture, the editing may not be effective.
- Editing an image may cause it to suffer a minor loss in quality.

3 ADD FAVORITE

Adding favorite images

This function registers your favorite still pictures as separate still pictures in the internal memory. You can register up to 9 favorite pictures.

★ Viewing "My Favorite" (P. 15)



- Use the arrow pad to select a picture, and press .

- Registered pictures cannot be erased even by formatting the internal memory.
- A registered picture can be used as the startup screen picture or menu screen background picture.

"PW ON SETUP Setting the startup screen and volume" (P. 36)
 "MENU COLOR Setting the menu screen color and background" (P. 36)

Note

- Please note that registered pictures cannot be edited, printed, copied to a card, transferred to a computer, or played back on a computer.

4 EDIT

..... Changing the size of pictures

VGA 640 x 480	This function changes the picture size to 640 x 480 and saves it as a new file.
QVGA 320 x 240	This function changes the picture size to 320 x 240 and saves it as a new file.

..... Cropping a picture

Crop a picture, and save the cropped picture as a new picture.



- Select the picture to be cropped with , and press .
- Use the arrow pad and zoom button to adjust the position and size of the area-selection box, and press .
- This function cannot be used when a panoramic picture is selected.

COLOR EDIT Changing the color of pictures

This function changes the color of a picture and saves it as a new file.

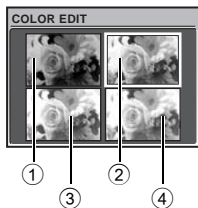

- Select the picture with \triangleleft \triangleright , and press \odot .
- Use the arrow pad to select the desired color, and press \odot .

① Black & White	Creates a black and white picture.
② Sepia	Creates a sepia picture.
③ Saturation (High)	This increases the saturation of the picture.
④ Saturation (Low)	This slightly increases the saturation of the picture.

FRAME Add a frame to your picture

This function lets you select a frame, integrate the frame with an image, and save it as a new picture.



- Select the picture to be integrated with the frame with \triangleleft \triangleright , and press \odot . (Press \triangle ∇ to turn the picture 90 degrees clockwise or 90 degrees counterclockwise.)
- Select a frame with \triangleleft \triangleright and press \odot .
- Press the arrow pad and the zoom button to adjust the position and size of the picture, and press \odot .
- This function cannot be used when a panoramic picture is selected.

LABEL Add a label to your picture

This function lets you select a label, integrate the label with an image, and save it as a new picture.



- Select the picture with \triangleleft \triangleright , and press \odot .
- Select the label with \triangleleft \triangleright , and press \odot . (Press \triangle ∇ to turn the label 90 degrees clockwise or 90 degrees counterclockwise.)
- Press the arrow pad and the zoom button to adjust the position and size of the label, and press \odot .
- Set the color of the label with the arrow pad, and press \odot .
- This function cannot be used when a panoramic picture is selected.

CALENDAR Create a calendar print with a picture

This function lets you select a calendar format, integrate the calendar with a picture, and save it as a new file.

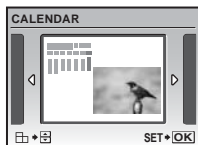

- Select the picture with \triangleleft \triangleright , and press \odot .
- Select the calendar with \triangleleft \triangleright , and press \odot . (Press \triangle ∇ to turn the picture 90 degrees clockwise or 90 degrees counterclockwise.)
- Set the date of the calendar, and press \odot .
- This function cannot be used when a panoramic picture is selected.

INDEX Making an index picture from a movie

This function extracts 9 frames from a movie and saves them as a new picture (INDEX) containing thumbnails of each frame.



- Select a movie with \triangleleft / \triangleright , and press MENU .
- The [BUSY] bar will be temporarily displayed.

5 PRINT ORDER

Making print reservations (DPOF)

This function allows you to save printing data (the number of prints and the date and time information) with the pictures stored on the card.

MENU "Print settings (DPOF)" (P. 44)

6 PLAYBACK MENU

LOCK Protecting pictures

OFF / ON

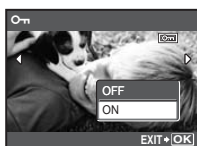

Protected pictures cannot be erased with [ERASE], [SEL.IMAGE], or [ALL ERASE], but they are all erased by formatting.

- Select the picture with \triangleleft / \triangleright , and protect it by selecting [ON] with \triangleup / \triangledown . You can protect several frames in succession. LOCK is displayed when the picture is protected.

ROT Rotating pictures

$\text{ROT} +90^\circ$ / $\text{ROT} 0^\circ$ / $\text{ROT} -90^\circ$

Pictures taken with the camera held vertically are displayed horizontally during playback. This function lets you rotate such pictures so that they are displayed vertically on the monitor, and the new picture orientations will be saved even after the power is turned off.



Select a picture with \triangleleft / \triangleright , and use \triangleup / \triangledown to select [$\text{ROT} +90^\circ$], [$\text{ROT} 0^\circ$], or [$\text{ROT} -90^\circ$]. You can rotate several frames in succession.



YES / NO



Sound is recorded for about 4 seconds.

- Select a picture with \triangleleft / \triangleright , and select [YES] with \triangle / ∇ , then press OK to begin recording.
- The [BUSY] bar will be temporarily displayed.

7 ERASE**Erase selected pictures/Erase all pictures**

Protected pictures cannot be erased. Cancel protection before erasing protected pictures. Once erased, pictures cannot be restored. Check each picture before erasing to avoid accidentally erasing pictures you want to keep.

- When erasing the picture in the internal memory, do not insert the card into the camera.
- When erasing the picture from the card, insert a card into the camera in advance.
- You can confirm on the monitor whether the internal memory or card is being used.

"Using the internal memory or card" (P. 63)

SEL. IMAGE **Erase by selecting the single-frame**

- Use the arrow pad to select the picture, and press OK to add \checkmark .
- Press OK again to cancel the selection.
- When all individual pictures to be erased have been marked, press OK .
- Select [YES], and press OK .

ALL ERASE **Erase all the pictures in the internal memory or the card**

- Select [YES], and press OK .

SETUP menus

Shooting mode
(In still picture shooting mode)

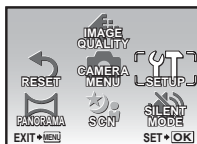

Playback mode

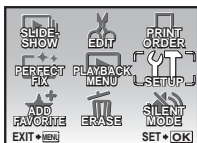

SETUP

MEMORY FORMAT
(FORMAT *1)
BACKUP *1
PW ON SETUP
MENU COLOR
SOUND SETTINGS *2
REC VIEW
FILE NAME
PIXEL MAPPING
DUALTIME
ALARM CLOCK
VIDEO OUT
POWER SAVE
LED ILLUMINATOR
MANOMATER
m/ft

*1 A card is required.

*2 This feature is not available in [SILENT MODE].

"SILENT MODE Turning off camera sounds" (P. 29)

- The factory default settings are displayed in gray ().

MEMORY FORMAT (FORMAT) Formatting the internal memory or card

All existing data, including protected pictures, are erased when the internal memory or card is formatted (images registered to "My Favorite" are not erased). Make sure that you save or transfer important data to a computer before formatting the internal memory or card.

- Make sure there is no card inserted in the camera when formatting the internal memory.
- When the internal memory is formatted, the data of the frames and labels downloaded with the provided OLYMPUS Master software will be deleted.
- Be sure that the card is inserted in the camera when formatting the card.
- Before using non-Olympus cards or cards which have been formatted on a computer, you must format them with this camera.

BACKUP Copying pictures in the internal memory to the card

Insert the optional card into the camera. Copying data does not erase the pictures in the internal memory.

- It takes some time to back up data. Check that the battery is charged before starting the copy, or use the AC adapter.

..... Selecting a display language

You can select a language for on-screen display. Available languages vary depending on the area where you purchased this camera.

PW ON SETUP Setting the startup screen and volume

SCREEN OFF (No picture is displayed.) / 1 / 2 / MY FAVORITE

VOLUME OFF (No sound) / LOW / HIGH

- Select [2] and press to set a still picture in the internal memory or card as the startup screen.
- Select [MY FAVORITE] and press to set a still picture registered in "My Favorite" as the startup screen.
- 🔍 "ADD FAVORITE Adding favorite images" (P. 31)
- [VOLUME] cannot be set in the following cases.
 - When [SCREEN] is set to [OFF]
 - When [SILENT MODE] is set to [ON]

MENU COLOR Setting the menu screen color and background

NORMAL / COLOR1 / COLOR2 / COLOR3 / MY FAVORITE

- Select [MY FAVORITE] and press to set a still picture registered in "My Favorite" as the background.
- 🔍 "ADD FAVORITE Adding favorite images" (P. 31)

SOUND SETTINGS Setting the sounds output from the camera

You can make the following settings with [SOUND SETTINGS].

- Setting the type of button operation sounds and volume. (BEEP)
- Selecting the sound of the shutter button. (SHUTTER SOUND)
- Adjusting the volume of the camera warning sound. (●))
- Adjusting the volume during playback. (▶ VOLUME)

BEEP	SOUND TYPE	1 / 2
	VOLUME	OFF (No sound) / LOW / HIGH
SHUTTER SOUND	SOUND TYPE	1 / 2 / 3
	VOLUME	OFF (No sound) / LOW / HIGH
●))	OFF (No sound) /	LOW / HIGH
▶ VOLUME	OFF (No sound) /	LOW / HIGH

- You can set all the sounds muted at once by setting [SILENT MODE].
- 🔍 "SILENT MODE Turning off camera sounds" (P. 29)

REC VIEW Viewing pictures immediately after they are taken

OFF	The picture being recorded is not displayed. This is useful when you want to prepare for your next shot while the previous picture is being recorded.
ON	The picture being recorded is displayed. This is useful for making a brief check of the picture you have just taken. You can resume shooting while the picture is still being displayed.

FILE NAMEResetting the file names of pictures

RESET	The file number and folder number are reset every time a new card is inserted in the camera. The folder number returns to [No. 100] and the file number returns to [No. 0001].
AUTO	Even if a new card is inserted, the folder number and file number are retained from the previous card. This helps you to manage multiple cards.

Structure of file name and folder name

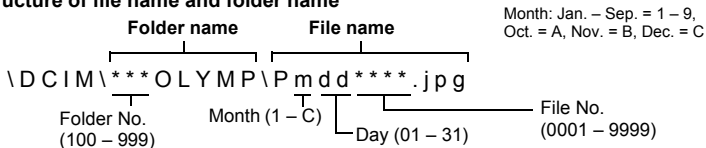

PIXEL MAPPINGAdjusting the image processing function

The pixel mapping feature allows the camera to check and adjust the CCD and image processing functions. It is not necessary to operate this function frequently. Approximately once a year is recommended. Wait at least one minute after taking or viewing pictures to allow the pixel mapping function to perform properly. If you turn the camera off during pixel mapping, start again.

Select [PIXEL MAPPING]. When [START] is displayed, press .

..... Adjusting the brightness of monitor



: Brightens the monitor.

: Darkens the monitor.

Press  to confirm your selection.

.....Setting the date and time

The date and time is saved with each image, and is used in the file name.

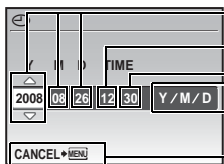

Y-M-D (Year-Month-Day)

Hour

Minute

Date formats (Y-M-D, M-D-Y, D-M-Y)

MENU: Cancels the setting.

- The first two digits of the year are fixed.
- The time is displayed in the 24-hour format.
- To set the time precisely, with the cursor either on "Minute" or [Y/M/D], press  as the time signal strikes 00 seconds.

DUALTIME Setting the date and time for another time zone

OFF	Switches to the date and time set in [☺]. Pictures are recorded with the date and time set in [☺].
ON	Switches to the date and time set in [DUALTIME]. When setting the dual time, select [ON], and then set the time. Pictures are recorded with the date and time set in [DUALTIME].

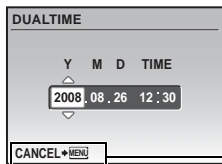

MENU: Cancels the setting.

- The date format is the same as that set with [☺].
- The first two digits of the year are fixed.
- The time is displayed in the 24-hour format.

ALARM CLOCK Setting alarms

OFF	No alarm is set or alarm is canceled.
ONE TIME	Alarm is activated once. After the alarm goes off, the setting is canceled.
DAILY	Alarm is activated daily at the set time.

- When [☺] has not been set, [ALARM CLOCK] is not available.
- When [SILENT MODE] is set to [ON], the alarm will not sound.
- When [DUALTIME] is set to [ON], the alarm sounds according to the dual time date and time setting.

Setting an alarm

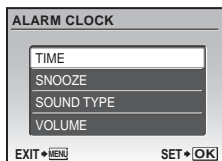

- Select [ONE TIME] or [DAILY], and set the alarm time.
- You can set snooze or alarm sounds and volume.

TIME	Sets the alarm time.	
SNOOZE	OFF	No snooze is set.
	ON	Alarm is activated every 5 minutes, up to 7 times.
SOUND TYPE	1 / 2 / 3	
VOLUME	LOW / HIGH	

Operating, shutting off and checking the alarm

- Operating the alarm:
Turn off the camera. The alarm only operates when the camera is off.
- Shutting off the alarm:
While the alarm is sounding, press any button to shut off the alarm and turn off the camera. Note that pressing **POWER** will turn the camera on.
When [SNOOZE] is [OFF], the alarm stops automatically and the camera turns off after 1 minute of no operation.
- Checking the alarm settings:
While the camera is off, press **DISP.**  to display the current and alarm set times. Times will be displayed for 3 seconds.

VIDEO OUT Playing back pictures on a TV

NTSC / PAL

The factory default settings differ according to the region where the camera is sold.

To play back camera images on a TV, set the video output according to your TV's video signal type.

- TV video signal types differ by country/region. Check the video signal type before connecting the camera to the TV.

NTSC: North America, Taiwan, Korea, Japan

PAL: European countries, China

Playing back pictures on a TV

Turn off the camera and the TV before connecting.

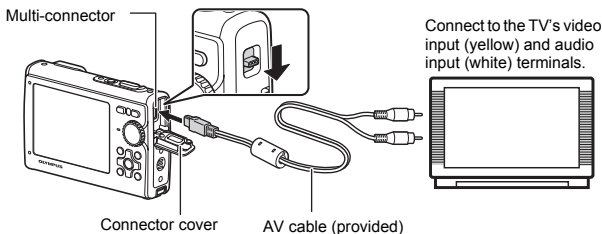

Settings on the camera

Press **POWER** in playback mode to turn the camera on.

- The last picture taken is displayed on the TV. Use the arrow pad to select the picture you want to display.

Settings on the TV

Turn the TV on, and set it to video input mode.

- For details of switching to video input, refer to your TV's instruction manual.
- Images and the information displayed on the screen may become cropped depending on the TV's settings.

POWER SAVE **Setting the camera to the power save mode**

OFF / ON

When no operation has been performed for approximately 10 seconds while in shooting mode, the monitor automatically shuts off. Pressing the zoom button or other buttons restores the camera from power save mode.

LED ILLUMINATOR **Setting the LED illuminator function**

OFF / ON

This function provides additional lighting when a quick light source is needed and to help you compose your picture in a dark environment.

☞ "DISP./☑/☒ button Changing the information on display/Display the menu guide/
Turning on the LED illuminator/Checking the time" (P. 19)

MANOMETER **Displaying the atmospheric pressure and altitude/depth during shooting**

OFF / ON / CALIBRATE

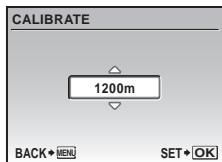

This displays the atmospheric pressure and altitude/depth during shooting (from -10 m (-32.8 ft.) to 5,000 m (16,400 ft.)). A warning message is displayed when a water depth close to 10 m (32.8 ft.) is reached.

- Select [CALIBRATE] and press \triangleright to display the [CALIBRATE] screen. Use the arrow pad \triangle / ∇ to adjust your current position.
- The displayed value may have a margin of error depending on meteorological conditions. Use this for your reference.

m/ft **Setting the units for the altitude/depth display**

m / ft

Set to display the altitude/depth in meters or feet.

Printing pictures

Direct printing (PictBridge)

By connecting the camera to a PictBridge-compatible printer, you can print out pictures directly.

EASY PRINTPrints the picture displayed in the monitor by using the standard settings of your printer.

CUSTOM PRINTPrints with the various print settings.

- PictBridge is a standard for connecting digital cameras and printers of different makers and printing out pictures directly. To find out if your printer is compatible with PictBridge, refer to the printer's instruction manual.
- For printer's standard settings, available printing modes, the setting items such as paper sizes, and printer's specifications such as available types of paper, how to install the papers and ink cassettes, etc., refer to the printer's instruction manual.

EASY PRINT

- 1** In playback mode, display the picture you want to print out on the monitor.
- 2** Turn the printer on and plug the USB cable provided with the camera into the multi-connector of the camera and the printer's USB port.

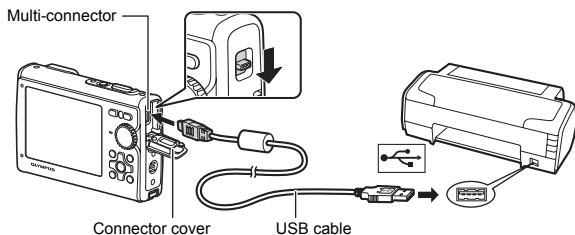

- The easy print start screen is displayed.



3 Press / .

- Printing starts.
- When printing is finished, the picture selection screen is displayed. To print another picture, press to select a picture, and press / .

4 Disconnect the USB cable.



Other print modes and print settings (CUSTOM PRINT)

- 1 Follow Steps 1 and 2 on P. 41 to display the screen for Step 3 above, and then press .
- 2 Select [CUSTOM PRINT], and press .
- 3 Follow the operation guide to adjust print settings.

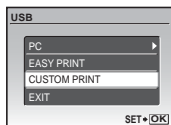

Selecting a print mode

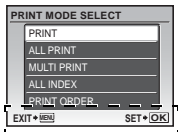

Operation guide

PRINT	Prints the selected picture.
ALL PRINT	Prints all the pictures stored in the internal memory or the card.
MULTI PRINT	Prints one picture in multiple layout format.
ALL INDEX	Prints an index of all the pictures stored in the internal memory or the card.
PRINT ORDER	Prints the pictures according to the print reservation data on the card.  "Print settings (DPOF)" (P. 44)

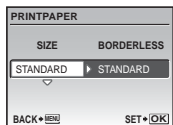

Setting the print paper



SIZE	Choose from the available paper sizes on your printer.
BORDERLESS	Select with or without borders. In [MULTI PRINT] mode, you cannot print with a border.
PICS/SHEET	Select the number of pictures to be laid out on a sheet of paper. Available in [MULTI PRINT] mode only.

- If the [PRINTPAPER] screen is not displayed, [SIZE], [BORDERLESS] and [PICS/SHEET] are set to the standard.

Selecting the picture to print

Press   to select the picture you want to print. You can also use the zoom button and select a picture from the index display.



PRINT	Prints one copy of the selected picture. When [SINGLE PRINT] or [MORE] has been selected, a single copy or more copies are printed.
SINGLE PRINT	Makes a print reservation for the displayed picture.
MORE	Sets the number of prints and data to be printed for the displayed picture.

Setting the number of prints and data to be printed

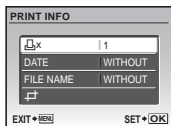

	Sets the number of prints. You can select up to 10 prints.
DATE (🕒)	If you select [WITH], pictures are printed with the date.
FILE NAME (📄)	If you select [WITH], pictures are printed with the file name.
	Use the arrow pad and zoom button, adjust the location and size of the trimming frame, then press to print the cropped picture.

4 Select [PRINT], and press .

- Printing starts.
- When [OPTION SET] is selected in [ALL PRINT] mode, [PRINT INFO] screen is displayed.
- When printing is finished, the [PRINT MODE SELECT] screen is displayed.

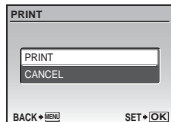

To cancel printing

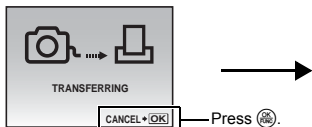

Screen during data transfer

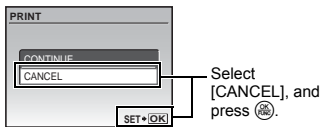

5 In the [PRINT MODE SELECT] screen, press MENU.

- A message is displayed.

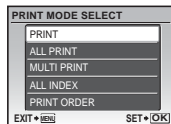

6 Disconnect the USB cable.

Print settings (DPOF)

Print reservation allows you to save printing data (the number of prints and the date and time information) with the pictures stored on the card.



With print reservation, you can print out pictures easily either at home using a personal DPOF-compatible printer or at a photo store that supports DPOF. DPOF is a standard format used to record automatic print information from digital cameras.

- Only the images stored on the card can be reserved to print. Insert a card with recorded pictures into the camera before making print reservations.
- DPOF reservations set by another device cannot be changed by this camera. Make changes using the original device. If a card contains DPOF reservations set by another device, entering reservations using this camera may overwrite the previous reservations.
- You can make DPOF print reservations for up to 999 images per card.
- Not all functions may be available on all printers, or at all photo stores.

Making a print reservation

1 Press **MENU** in the playback mode and select **[PRINT ORDER]**.

2 Select **[1]** or **[ALL]**, and press **[OK]**.

-  Makes a print reservation for the selected picture.
 -  Makes print reservations for all the pictures stored on the card.
- When **[ALL]** is selected, go to step 5.

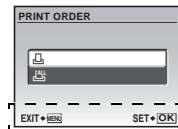

Operation guide

When [1] is selected

3 Press **◀▶** to select the frames for print reservations, and then press **△▽** to set the number of prints.

- You cannot make print reservations for pictures with .
- Repeat Step 3 to make print reservations for other pictures.

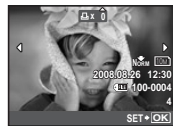

4 When you finish making print reservations, press **[OK]**.

5 Select the date and time print setting, and press **[OK]**.

- NO** The pictures are printed without the date and time.
- DATE** The selected pictures are printed with the shooting date.
- TIME** The selected pictures are printed with the shooting time.

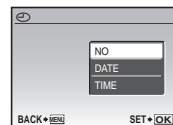

6 Select **[SET]**, and press **[OK]**.

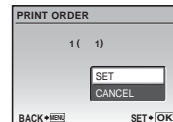





Resetting print reservation data

You can reset all the print reservation data or just for selected pictures.







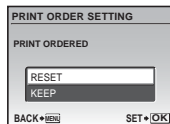

- 1 Select top menu ▶ [PRINT ORDER], and press .

To reset the print reservation data for all the pictures

- 2 Select [] or [], and press .
- 3 Select [RESET], and press .



To reset the print reservation data for a selected picture

- 2 Select [, and press .
- 3 Select [KEEP], and press .
- 4 Press  to select the picture with the print reservations you want to cancel, and press  to decrease the number of prints to 0.
 - Repeat Step 4 to cancel print reservations for other pictures.
- 5 When you are finished canceling print reservations, press .
- 6 Select the date and time setting, and press .
- The setting is applied to the remaining pictures with print reservations.
- 7 Select [SET], and press .

Using OLYMPUS Master

Using the USB cable provided with your camera, you can connect the camera and computer and download (transfer) the images to your computer using the OLYMPUS Master software, also provided with the camera.

Prepare the following items before starting.



OLYMPUS Master 2
CD-ROM



USB cable

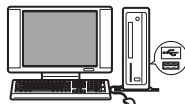

A computer that satisfies the operating
environment (P. 46) requirements

What is OLYMPUS Master?

OLYMPUS Master is a software application for managing your digital images on your computer.

Install the OLYMPUS Master software

Before installing the OLYMPUS Master software, please confirm that your computer is compatible with the following system requirements.

For newer operating systems, please refer to the Olympus web site as shown on the back cover of this manual.

Operating environment

	Windows	Macintosh
OS	Windows 2000 Professional/XP Home Edition/XP Professional/Vista	Mac OS X v10.3 or later
CPU	Pentium III 500 MHz or later	Power PC G3 500 MHz or later Intel Core Solo/Duo 1.5 GHz or later
RAM	256 MB or more	256 MB or more
Hard disk capacity	500 MB or more	500 MB or more
Monitor	1,024 × 768 pixels or more 65,536 colors or more (16.77 million colors or more recommended)	1,024 × 768 pixels or more 32,000 colors or more (16.77 million colors or more recommended)
Other	USB port or IEEE 1394 port Internet Explorer 6 or later QuickTime 7 or later recommended DirectX 9 or later recommended	USB port or IEEE 1394 port (FireWire) Safari 1.0 or later (1.3 or later recommended) QuickTime 6 or later

! Note

- Use a computer with a pre-installed operating system. Operations are not guaranteed on home-built computers or computers with an updated operating system.
- Operations are not guaranteed when using an added USB or IEEE 1394 (FireWire) port.
- To install the software, you must log on as a user with administrators' privileges.
- If you are using Macintosh, be sure to remove the media (drag & drop onto the trash icon) before performing the following operations. Failure to do so could result in unstable computer operation and the need to reboot.
 - Disconnect the cable connecting the camera to the computer
 - Turn off the camera
 - Open the camera's battery/card compartment cover

For how to install the OLYMPUS Master software, refer to the installation guide included in the CD-ROM.

Connecting the camera to a computer

1 Make sure the camera is turned off.

- The monitor is off.
- The lens cover is closed.

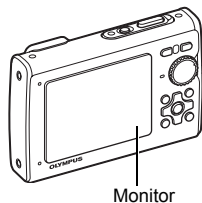

2 Connect the multi-connector on the camera to the USB port on the computer using the provided USB cable.

- Refer to your computer's instruction manual to locate the position of the USB port.
- The camera turns on automatically.
- The monitor turns on and the selection screen for the USB connection is displayed.

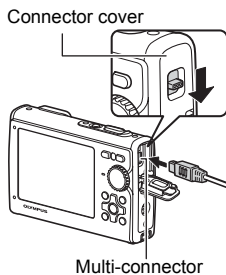

3 Select [PC], and press .

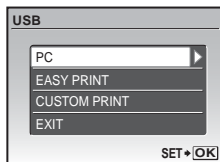

4 The camera is recognized by the computer.

• Windows

When you connect the camera to your computer for the first time, the computer attempts to recognize the camera. Click "OK" to exit the message that is displayed. The camera is recognized as a "Removable Disk".

• Macintosh

The iPhoto program is the default application for managing digital images. When you connect your digital camera for the first time, the iPhoto application starts automatically, so close this application and start OLYMPUS Master.

! Note

- The camera functions are disabled while the camera is connected to a computer.
- Connecting the camera to a computer via a USB hub may cause unstable operation. In this case, do not use a hub, but connect the camera directly to the computer.
- Images cannot be transferred to your computer with OLYMPUS Master if [PC] is selected in Step 3, \triangleright is pressed and [MTP] is selected.

Start up the OLYMPUS Master software

Windows

1 Double-click the "OLYMPUS Master 2" icon  on the desktop.

Macintosh

1 Double-click the "OLYMPUS Master 2" icon  in the "OLYMPUS Master 2" folder.

- The browse window is displayed.
- When OLYMPUS Master is started up for the first time after installation, the OLYMPUS Master initial setting screen and user registration screen are displayed before the browse window. Follow the on-screen instructions.

Displaying camera images on a computer

Downloading and saving images

1 Click "Transfer Images"  on the browse window, and then click "From Camera" .

- The window for selecting the pictures you want to transfer from the camera is displayed. All the images in the camera are displayed.

2 Select "New Album" and enter an album name.

3 Select the image files and click "Transfer Images".

- A window indicating that the download is complete is displayed.

4 Click "Browse images now".

- The downloaded images are displayed in the browse window.



To disconnect the camera

- 1 Make sure that the card access lamp has stopped blinking.

Card access lamp

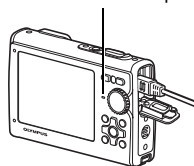

- 2 Make the following preparations for disconnecting the USB cable.

Windows

- ① Click the "Unplug or Eject Hardware" icon  in the system tray.
- ② Click the message that is displayed.
- ③ When a message is displayed saying that the hardware can be ejected safely, click "OK".

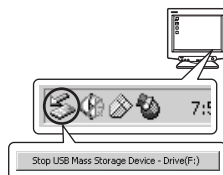

Macintosh

- ① The trash icon changes to the eject icon when the "Untitled" or "NO_NAME" icon on the desktop is dragged. Drag and drop it on the eject icon.



- 3 Disconnect the USB cable from the camera.

Note

- Windows: When you click "Unplug or Eject Hardware", a warning message may be displayed. Make sure that image data is not being downloaded from the camera and that all applications are closed. Click the "Unplug or Eject Hardware" icon again and disconnect the cable.

For detailed operations of OLYMPUS Master, refer to the quick start guide displayed upon startup or the help of the OLYMPUS Master.

To download and save images to a computer without using OLYMPUS Master

This camera is compatible with USB mass storage. You can connect the camera to your computer using the USB cable provided with the camera to download and save images without using OLYMPUS Master. The following environment is required to use the USB cable to connect the camera to your computer.

Windows: Windows 2000 Professional/XP Home Edition/XP Professional/Vista

Macintosh: Mac OS X v10.3 or later

Note

- If your computer is running Windows Vista, you can select [PC] in Step 3 on P. 47, press , and select [MTP] to use Windows Photo Gallery.
- Data transfer is not guaranteed in the following environments, even if your computer is equipped with a USB port.
 - Computers with a USB port added by means of an extension card, etc.
 - Computers without a factory-installed OS and home-built computers

Shooting tips and information

Tips before you start taking pictures

The camera does not turn on even when a battery is loaded

The direction of the battery is incorrect

- Insert the battery in the correct direction.

The battery is not fully charged

- Charge the battery with the charger.

The battery is temporarily unable to function because of the cold

- Battery performance declines in low temperatures, and the charge may not be sufficient to turn on the camera. Remove the battery and warm it by putting it in your pocket for a while.

Cannot use the card

- If the card's contact area is dirty, the [CARD SETUP] screen may display without reading the card. In this case, select [CLEAN CARD], and press . Then, remove the card and wipe the contact area with a soft, dry cloth.

No picture is taken when the shutter button is pressed

The camera is in sleep mode

- To save battery power, the camera automatically goes into sleep mode and the monitor turns off if there is no operation after 3 minutes when the camera is turned on (when the lens cover is open and the monitor is on). No picture is taken even if the shutter button is fully pressed in this mode. Operate the zoom button or other buttons to restore the camera from sleep mode before taking a picture. If the camera is left on for 15 minutes, it automatically turns off (the lens cover closes and the monitor turns off). Press **POWER** to turn the camera on.

The mode dial is set to or

- This is the playback mode for displaying pictures on the monitor. Set the mode dial to a shooting mode.

The mode dial is in the position of **GUIDE**

- No pictures can be taken when the shooting guide is being displayed. Take pictures after selecting your desired shooting effect in the shooting guide or set it to a setting other than **GUIDE** in shooting mode.

The flash is charging

- Wait until the  (flash charge) mark stops blinking before taking the picture.

The date and time have not been set

The camera has been used in the same conditions from the time of purchase

- No date and time have been set for the camera at the time of purchase. Set the date and time before using the camera.



"Turn the camera on" (P. 6)
" Setting the date and time" (P. 37)

The battery has been pulled out of the camera

- The date and time settings will be returned to the factory default settings if the camera is left without battery for approximately 1 day. Also, the date and time setting will be canceled earlier than this if the battery has been in the camera for a short period of time. Before taking important pictures, check that the date and time settings are correct.

Focusing on the subject

There are several ways to focus, depending on the subject.

When the subject is not in the center of the frame

- Place the subject in the center of the frame, lock the focus on the subject, and then recompose your picture.
- Set [AF MODE] to [iESP].

 "AF MODE Changing the focusing area" (P. 29)

The subject is moving quickly

- Focus the camera on a point roughly the same distance away as the subject you want to shoot and lock the focus (by pressing the shutter button halfway). Then recompose your picture and press the shutter button completely as the subject enters the frame.

Subjects that are difficult to focus on

- Under certain types of conditions, it is difficult to focus using auto focus.



Subject with low contrast



Subject with an extremely bright area in the center of the frame

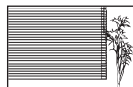

Subject without vertical lines



Subjects at different distances

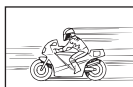

Fast-moving subject



The subject is not in the center of the frame

In these cases, focus (focus lock) on an object with high contrast at the same distance as the intended subject, recompose your shot and then take the picture. If the subject has no vertical lines, hold the camera vertically and focus the camera using the focus lock function by pressing the shutter button halfway, and then return the camera to the horizontal position while keeping the button pressed halfway and take the picture.

Prevent blur by using image stabilization

Be sure to hold the camera firmly with both hands and press the shutter button slowly so as to avoid moving the camera. You can reduce the blur when shooting the picture in  mode.

 "Shooting pictures using digital image stabilization" (P. 12)

Pictures are more likely to be blurry when:

- images are shot at a high-magnification zoom setting, i.e. using both optical zoom and digital zoom functions,
- the object is dark and the shutter speed is slow, or
- scene modes where the flash is turned off and/or the shutter speed is slow.

Taking stabilized pictures without the flash

The flash is activated automatically when there is insufficient light, or when the camera is shaken. To take pictures with no flash in dark places, set the flash mode to  and set as follows:

Increase the [ISO] setting

-  "ISO Changing the ISO sensitivity" (P. 28)

The picture is too grainy

There are several factors that can cause the picture to appear grainy.

Using the digital zoom to take close-up pictures

- With the digital zoom, part of the image is cropped and enlarged. The greater the magnification, the grainier the picture appears.

-  "DIGITAL ZOOM Zooming in on your subject" (P. 28)

Increasing the ISO sensitivity

- When you increase the [ISO] setting, "noise", which appears as spots of unwanted color or unevenness in the color, can be introduced and give the picture a grainy appearance. This camera is equipped with a function to allow shooting at high sensitivity while suppressing noise; however, increasing the ISO sensitivity can result in some noise, depending on the shooting conditions.

-  "ISO Changing the ISO sensitivity" (P. 28)

Taking pictures with the correct color

- The reason why there are sometimes differences between the actual colors and the colors recorded in a picture is related to the light source illuminating the subject. [WB] is the function that helps the camera determine the true colors. Normally, the [AUTO] setting provides the optimal white balance, but depending on the subject, results may be better if you manually adjust the [WB] setting.
 - When the subject is in the shade on a sunny day
 - When the subject is illuminated by both natural light and indoor lighting, such as when near a window
 - When there is no white in the center of the frame



-  "WB Adjusting the color of a picture" (P. 27)

Taking pictures of a white beach or snow scene

- Take pictures with  in **SCN** mode. Suitable for taking pictures on a sunny day at the beach or in the snow.

-  "**SCN** (Scene) Selecting a scene mode according to the shooting situation" (P. 26)

- Often, bright subjects (such as snow) turn out darker than their natural colors. Use  to adjust toward [+] to make these subjects closer to their true shades. Conversely, when you are shooting dark subjects, it can be effective to adjust toward the [-]. Sometimes, using the flash may not produce the brightness (exposure) that was intended.

-  " button Changing picture brightness (Exposure Compensation)" (P. 17)

Misalignment of panoramic pictures

- Panning along the camera central axis reduces picture misalignment. When you shoot close subjects, panning along the axis of the lens gives good results.
- In [COMBINE IN CAMERA1] mode, the camera automatically detects its own position except for the following cases (In such cases, use [COMBINE IN CAMERA 2] or [COMBINE IN PC].):
 - Camera moves too fast, or the camera was not moved along a straight line.
 - Subject with low contrast (the whole screen is filled with the sky, etc.).
 - A moving subject is taking up most of the screen.
 - Camera is moved while processing.

Taking pictures of a subject against backlight

- When Shadow Adjustment Technology is set to [ON], the subject's face appears brighter even against backlight and the color of the background is enhanced in the picture. This function can also be used to shoot indoor pictures from outdoors.
 - "☀️: Brightening the subject against backlight" (P. 18)
- With [ESP/👁️] set to [👁️], the picture can be taken based on the brightness at the center of the monitor without being affected by the light in the background.
 - "ESP/👁️ Changing the area for measuring the brightness of a subject" (P. 29)
- Set the flash to [🔊] to activate fill-in-flash. You can shoot a subject against backlight without the face of the subject appearing dark. [🔊] is effective for shooting against backlight and under fluorescent and other artificial lighting.
 - "🔊 button Flash shooting" (P. 17)
 - It is effective to set the exposure compensation to [+] by pressing when shooting against strong backlighting.
 - "△+ button Changing picture brightness (Exposure Compensation)" (P. 17)
 - Adjusting exposure of person's face by setting [AF MODE] to [FACE DETECT] makes the subject's face appear brighter even against strong backlighting.
 - "AF MODE Changing the focusing area" (P. 29)

Additional shooting tips and information

Increasing the number of pictures that can be taken

There are two ways to record the pictures you take with this camera.

Recording pictures to the internal memory

- Pictures are recorded to the internal memory, and when the number of storable still pictures reaches 0, you must connect the camera to a computer to download the pictures, and then erase the pictures from the internal memory.

Using a card (xD-Picture Card) (optional)

- Pictures are recorded to the card inserted in the camera. When the card is full, you download the pictures to a computer, and then either erase the pictures from the card or use a new card.
- Pictures are not recorded to the internal memory when a card is inserted in the camera. Pictures in the internal memory can be copied to the card using the [BACKUP] function.
 - "BACKUP Copying pictures in the internal memory to the card" (P. 35)
 - "The card" (P. 63)

Number of storable still pictures and recording length of movies

Still pictures

IMAGE SIZE		COMPRES- SION	Number of storable still pictures			
			Internal memory		Using a 1GB card	
			With sound	Without sound	With sound	Without sound
	3648 × 2736		3	3	204	205
			5	5	399	404
	2560 × 1920		5	6	404	410
			12	12	820	841
	2048 × 1536		9	9	615	627
			18	19	1254	1305
	1600 × 1200		15	15	1031	1066
			28	30	1938	2063

IMAGE SIZE		COMPRES- SION	Number of storable still pictures			
			Internal memory		Using a 1GB card	
			With sound	Without sound	With sound	Without sound
[1M]	1280 × 960	FINE	23	24	1560	1640
		NORM	43	47	2907	3198
[VGA]	640 × 480	FINE	75	89	4920	5815
		NORM	121	163	7996	10661
[16:9]	1920 × 1080	FINE	14	14	954	984
		NORM	26	28	1827	1938

Movie

IMAGE SIZE		FRAME RATE	Continuous recording length			
			Internal memory		Using a 1 GB card	
			With sound *1	Without sound *2	With sound *1	Without sound *2
[VGA]	640 × 480	[30]	8 sec.	8 sec.	10 sec.	10 sec.
		[15]	16 sec.	16 sec.	18 min. 37 sec.	18 min. 57 sec.
[QVGA]	320 × 240	[30]	19 sec.	19 sec.	22 min. 3 sec.	22 min. 44 sec.
		[15]	38 sec.	39 sec.	29 min.	29 min.

*1 When [MOVIE] is set to [NON-WATER MOVIE].

*2 When [MOVIE] is set to [UNDERWATER MOVIE].

Using a new card

- If you use a non-Olympus card or a card that was used on a computer for another application, use the [FORMAT] function to format the card.

 "MEMORY FORMAT (FORMAT) Formatting the internal memory or card" (P. 35)

The card access lamp is blinking

- An image or movie is being recorded or downloaded (when connected to a computer).
- Do not do any of the following while the card access lamp is blinking. Doing so may prevent the image data from being saved and render the internal memory or card unusable.
 - Open the battery/card compartment cover.
 - Remove the battery and card.

Extending the useful life of the battery

- Performing any of the following operations when not actually taking pictures can deplete the battery power.
 - Repeatedly pressing the shutter button halfway
 - Repeatedly using the zoom
- To minimize the battery consumption, set [POWER SAVE] to [ON] and turn off the camera whenever it is not in use.

 "POWER SAVE Setting the camera to the power save mode" (P. 40)

Functions that cannot be selected from menus/Functions that cannot be selected even by pressing the function buttons

- Some items are not be selectable from the menus when using the arrow pad. (The menu items displayed in gray cannot be selected.)
 - Items that cannot be set with the current shooting mode
 - Items that cannot be set because of an item that has already been set: When [DRIVE] is set to [P], [FINE ZOOM] or [DIGITAL ZOOM] cannot be set.
- Some functions cannot be set by pressing the function buttons depending on the camera setting. [s], Flash Mode, etc.
- Some functions cannot be used when there is no card in the camera. [PANORAMA], [PRINT ORDER], [FORMAT], [BACKUP]
- You cannot change the function settings when the mode dial is set to **GUIDE**.

Restoring default settings

- This camera retains the settings (except for **SCN**) even after the power is turned off. To return the settings to default settings, execute [RESET].
 - [RESET] "RESET Restoring default settings" (P. 24)

Confirming the exposure when the monitor is difficult to see outdoors

The monitor may be difficult to see and the exposure difficult to confirm when shooting outdoors.

Press DISP./[INFO] repeatedly to display the histogram

- Set the exposure so that the graph is concentrated on the outer edges and the graph is balanced on both sides.

How to read the histogram

- If the peak fills too much of the frame, the image will appear mostly black.
- If the peak fills too much of the frame, the image will appear mostly white.
- The part indicated in green in the histogram shows the luminance distribution in the center area of the monitor.

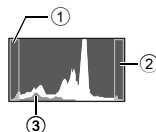

- [DISP./[INFO]] button Changing the information on display/Display the menu guide/Turning on the LED illuminator/Checking the time" (P. 19)

Playback help and troubleshooting tips

The red-eye cannot be fixed

- Depending on the picture, the red-eye may not be fixed. Also, parts except the eye may be fixed.





Bright specks appear in the picture

- Light reflecting from dust and other particles in the air at night may appear as bright specks in pictures taken using the flash.

Playing back the picture in the internal memory

- When a card has been inserted in the camera, the picture in the internal memory cannot be played back. Pull out the card before operating the camera.



Viewing picture information

- Play back a picture, and press **DISP./**. Press **DISP./** repeatedly to change the amount of information displayed.
-  “**DISP./** button Changing the information on display/Display the menu guide/Turning on the LED illuminator/Checking the time” (P. 19)

Quickly displaying a desired picture

- Press **W** on the zoom button to view the pictures as thumbnails (index display) or in a calendar format (calendar display).
-  “**Zoom button** Zooming while shooting/Close-up playback” (P. 16)

Erasing sound recorded to still pictures

- Once sound is added to a picture, it is not possible to erase the sound. In this case, make a re-recording with silence. Re-recording of the sound is not possible if there is insufficient space in the internal memory or on the card.
-  “ Adding sound to still pictures” (P. 34)

Viewing pictures on a computer

Viewing the entire picture on a computer screen

The size of the picture displayed on a computer screen changes depending on the computer settings. When the monitor setting is 1,024 × 768 and you are using Internet Explorer to view a picture with an image size of 2,048 × 1,536 at 100%, the entire picture cannot be viewed without scrolling. There are several ways you can view the entire picture on the computer screen.













View the picture using image browsing software





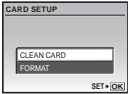

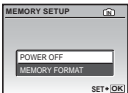
- Install the OLYMPUS Master 2 software from the provided CD-ROM.

Change the monitor setting

- The icons on the computer desktop may be rearranged. For details on changing the settings on your computer, refer to the computer's instruction manual.

When you get an error message on the camera...

Monitor indication	Possible cause	Corrective action
 CARD ERROR	There is a problem with the card.	This card cannot be used. Insert a new card.
 WRITE PROTECT	Writing to the card is prohibited.	The recorded image has been protected (read-only) on a computer. Download the image to a computer and cancel the read-only setting.
 MEMORY FULL	The internal memory has no available memory and cannot store any new data.	Insert a card or erase unwanted data. Before erasing, back up the data of important pictures using the card, or download such pictures to a computer.
 CARD FULL	The card has no available memory and cannot store any new data.	Replace the card or erase unwanted data. Before erasing, download important pictures to a computer.
 NO PICTURE	There are no pictures in the internal memory or on the card.	The internal memory or the card contains no pictures. Record pictures.
 PICTURE ERROR	There is a problem with the selected picture and it cannot be played back on this camera.	Use image processing software to view the picture on a computer. If that cannot be done, the image file is damaged.
 THE IMAGE CANNOT BE EDITED	Pictures taken by other cameras, taken in [16:9] or previously edited or corrected pictures cannot be edited or fixed.	Use image processing software to edit the pictures.
 CARD-COVER OPEN	The battery/card compartment cover is open.	Close the battery/card compartment cover.
 BATTERY EMPTY	The battery is empty.	Charge the battery.
	The card was not read. Or, the card is not formatted.	<ul style="list-style-type: none"> • Select [CLEAN CARD] and press . • Remove the card and wipe the contact area with a soft, dry cloth. • Select [FORMAT] ► [YES] and press . All data on the card is erased.
	There is an error in the internal memory.	Select [MEMORY FORMAT] ► [YES] and press  . All data in the internal memory is erased.

Monitor indication	Possible cause	Corrective action
 NO CONNECTION	The camera is not connected to the computer or printer correctly.	Disconnect the camera and connect it again correctly.
 NO PAPER	There is no paper in the printer.	Load some paper in the printer.
 NO INK	The printer has run out of ink.	Replace the ink cartridge in the printer.
 JAMMED	The paper is jammed.	Remove the jammed paper.
SETTINGS CHANGED	The printer's paper tray has been removed or the printer has been operated while changing settings on the camera.	Do not operate the printer while changing settings on the camera.
 PRINT ERROR	There is a problem with the printer and/or camera.	Turn off the camera and printer. Check the printer and remedy any problems before turning the power on again.
 CANNOT PRINT	Pictures recorded on other cameras may not be printed on this camera.	Use a computer to print.









Functions available in shooting modes and scene modes

Some functions cannot be set in certain shooting modes. For more details, refer to the table below.

■ indicates a restriction to the respective function of each **SCN** mode.

 "Functions available in shooting scenes" (P. 61)

Functions available in shooting modes

Shooting mode Function							Ref. Page
	AUTO			SCN	NON-WATER MOVIE	UNDERWATER MOVIE	
	✓	✓	✓	✓	✓	✓	P. 17
	✓	✓	✓	■	—	—	P. 17
	✓	✓	✓	■	✓ ^{*1}	✓ ^{*1}	P. 17
	✓	✓	✓	■	✓	✓	P. 17
Shadow Adjustment Technology	✓	✓	✓	■	✓	✓	P. 18
Optical zoom	✓	✓	✓	■	✓ ^{*2}	✓	P. 16
IMAGE QUALITY	✓	✓	✓	■	✓	✓	P. 23
PANORAMA	—	✓	✓ ^{*3}	■	—	—	P. 24
SILENT MODE	✓	✓	✓	✓	✓	✓	P. 29
WB	—	✓	✓	✓	✓	✓	P. 27
ISO	—	✓	—	■	—	—	P. 28
DRIVE	—	✓	✓	■	—	—	P. 28
FINE ZOOM	—	✓	✓	■	—	—	P. 28
DIGITAL ZOOM	—	✓	✓	■	✓	✓	P. 28
ESP/ 	—	✓	✓	■	✓	✓	P. 29
AF MODE	—	✓	✓	■	—	—	P. 29
	—	✓	✓	■	—	—	P. 29

*1 [] is not available.

*2 The optical zoom is not available during movie recording. Set [DIGITAL ZOOM] to [ON] to enable the zoom function for shooting.

*3 [COMBINE IN CAMERA 1] and [COMBINE IN CAMERA 2] are not available.

Functions available in shooting scenes

	SCN															Ref. Page
Function																
	✓	✓	✓	—	✓	—	—	—	—	—	✓ ^{*1}	✓	✓	✓	—	P. 17
	✓	✓ ^{*2}	✓ ^{*2}	✓	✓ ^{*2}	✓ ^{*2}	—	✓	—	✓	✓	✓	✓	—	✓ ^{*2}	P. 17
	✓	✓	✓	✓	✓	✓	✓	✓	✓	—	—	— ^{*3}	— ^{*3}	—	✓	P. 17
Shadow Adjustment Technology	✓	✓	—	—	✓	✓	—	✓	✓	✓	—	✓	—	—	✓	P. 18
Optical zoom	✓	✓	✓	✓	—	✓	✓	✓	✓	✓	✓	✓	✓	—	✓	P. 16
IMAGE QUALITY	✓	✓	✓	✓ ^{*4}	✓	✓	✓	✓	— ^{*5}	✓ ^{*4}	✓	✓	✓	✓	✓	P. 23
PANORAMA	✓ ^{*6}	✓ ^{*6}	✓ ^{*6}	✓ ^{*6}	—	✓ ^{*6}	✓ ^{*6}	✓ ^{*6}	—	—	—	✓ ^{*6}	✓ ^{*6}	✓ ^{*6}	—	P. 24
ISO	—	—	—	—	—	—	—	—	—	—	—	—	✓	✓	—	P. 28
DRIVE	✓ ^{*7}	✓ ^{*7}	—	—	✓ ^{*7}	—	—	✓ ^{*7}	—	—	—	✓ ^{*7}	✓ ^{*7}	✓ ^{*7}	—	P. 28
FINE ZOOM	✓	✓	✓	—	—	✓	✓	✓	✓	—	✓	✓	✓	—	—	P. 28
DIGITAL ZOOM	✓	✓	✓	—	—	✓	✓	✓	✓	—	✓	✓	✓	—	✓	P. 28
ESP/	✓	✓	✓	✓	—	✓	✓	✓	✓	✓	✓	✓	✓	✓	✓	P. 29
AF MODE	✓	✓	✓	✓	✓ ^{*8}	✓	—	✓	✓	✓	✓	✓	✓ ^{*9}	—	—	P. 29
	✓	✓	✓	✓	✓	✓	✓	✓	—	—	—	✓	✓	✓	—	P. 29

*1 [] is not available.

*2 [] and [] are not available.

*3 AF lock is on.

*4 Only an image quality at [] or lower is available.

*5 The image quality is fixed at [].

*6 [COMBINE IN CAMERA 1] and [COMBINE IN CAMERA 2] are not available.

*7 [] cannot be selected.

*8 [SPOT] is not available.

*9 [FACE DETECT] is not available.

Camera care

Cleaning the camera

Exterior:

- Wipe gently with a soft cloth. If the camera is very dirty, soak the cloth in mild soapy water and wring well. Wipe the camera with the damp cloth and then dry it with a dry cloth. If you have used the camera at the beach, use a cloth soaked in clean water and wrung well.
- If any dirt, dust, sand, or other foreign material adheres to the periphery of the lens cover after use, or the lens cover does not move smoothly, wash the camera using the method described on P. 65.

Monitor:

- Wipe gently with a soft cloth.

Lens:

- Blow dust off the lens with a commercial blower, then wipe gently with a lens cleaner.

Battery/Charger:

- Wipe gently with a soft, dry cloth.



Note

- Do not use strong solvents such as benzene or alcohol, or chemically treated cloth.
- Mold may form on the lens surface if the lens is left dirty.

Storage

- When storing the camera for extended periods, remove the battery, AC adapter and card, and keep in a cool, dry place that is well ventilated.
- Periodically insert the battery and test the camera functions.



Note

- Avoid leaving the camera in places where chemical products are handled since this may result in corrosion.

Battery and charger

- This camera uses one Olympus lithium ion battery (LI-50B). No other type of batteries can be used.
- Power consumption by the camera varies depending on which functions are used.
- During the conditions described below, power is consumed continuously and the battery becomes exhausted quickly.
 - The zoom is used repeatedly.
 - The shutter button is pressed halfway repeatedly in shooting mode, activating the auto focus.
 - A picture is displayed on the monitor for an extended period of time.
 - The camera is connected to a computer or printer.
- Using an exhausted battery may cause the camera to turn off without displaying the battery level warning.
- The rechargeable battery is not fully charged at the time of purchase. Charge the battery fully with the LI-50C charger before use.
- The provided rechargeable battery usually takes approximately 2 hours to charge (varies on usage).
- The supplied LI-50C battery charger is used only for LI-50B battery. Do not charge other type of battery with the supplied battery charger. It might cause explosion, leaking, overheating or fire.
- For plug-in type battery charger:
This power unit is intended to be correctly orientated in a vertical or floor mount position.

Use of the accessories

The card

Pictures can be recorded on the optional card.

The internal memory and card are the camera's media for recording pictures, similar to film in a film camera. Pictures recorded to the internal memory or card can be easily erased on the camera or processed using a computer.

Unlike portable storage media, the internal memory cannot be removed or exchanged.

The number of recordable pictures can be increased by using a card with a larger capacity.

① Index area

You can use this space to write the contents of the card.

② Contact area

The part where the data transferred from the camera enters the card.

Do not touch the contact area on the card.

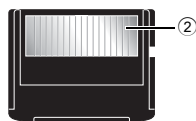

Compatible cards

xD-Picture Card 16MB – 2GB (TypeH/M, Standard)

Using the internal memory or card

You can confirm on the monitor whether the internal memory or card is being used during shooting and playback operations.

Shooting mode



Memory indicator

IN: When using the internal memory

No icon: When using a card

Playback mode



! Note

- Do not open the battery/card compartment cover while the card access lamp is blinking, as this indicates that data is being read or written. Doing so may damage the data in the internal memory or the card and render the internal memory or card unusable.

Card access lamp

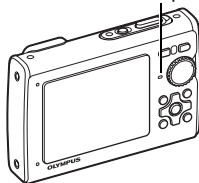

AC adapter

An AC adapter is useful for time-consuming tasks such as image downloads to a computer or when running a slideshow for a long period of time. To use an AC adapter for this camera, the multi-adapter (CB-MA1/accessory) is required.

Do not use any other AC adapter with this camera.

Using your charger and AC adapter abroad

- The charger and AC adapter can be used in most home electrical sources within the range of 100 V to 240 V AC (50/60Hz) around the world. However, depending on the country or area you are in, the AC wall outlet may be shaped differently and the charger may require a plug adapter to match the wall outlet. For details, ask at your local electrical shop or travel agent.
- Do not use travel voltage converters as they could damage your charger and AC adapter.

IMPORTANT INFORMATION ABOUT WATER AND SHOCK RESISTANT FEATURES

Water resistance: The waterproof feature is warranted*¹ to operate at depths up to 10 m (32.8 feet) for up to one hour. The waterproof feature may be compromised if the camera is subject to substantial or excessive impact.

Shock resistance: The anti-shock feature warrants*² the operation of the camera against accidental impact incurred from everyday use of your digital compact camera. The anti-shock feature does not unconditionally warrant all defective operation or cosmetic damage. Cosmetic damage, such as scratches and dents, are not covered under the warranty.

As with any electronic device, proper care and maintenance are required to preserve the integrity and operation of your camera. To maintain camera performance, please take your camera to the nearest Olympus Authorized Service Center to have it inspected after any major impact. In the event the camera is damaged as a result of negligence or misuse, the warranty will not cover costs associated with the service or repair of your camera. For additional information on our warranty, please visit to the Olympus website for your local area.

Please observe the following care instructions for your camera.

Before Use:

- Check the camera for foreign material including dirt, dust or sand.
- Be sure to close the battery/card compartment cover and connector cover firmly so that each lock makes clicking sound.
- Do not open the battery/card compartment cover and connector cover with wet hands, while under water, or in a damp or dusty environment (e.g. beach).

After Use:

- Be sure to wipe off any excess water or debris after using the camera under water.
- **After the camera is used under sea water, immerse the camera in a bucket containing fresh water for about 10 minutes (with the battery/card compartment cover and connector cover firmly closed). After that, dry the camera in a shade with good ventilation.**
- **Water drops may be observed on the inner surface of the battery/card compartment cover or connector cover after you open each cover. If any water drops are found, be sure to wipe them off before using the camera.**

Notes after use

- Any foreign material may be adhered to the periphery of the lens cover, after you use the camera in an environment containing foreign material including dirt, dust or sand, or when the lens cover won't move smoothly.

If you continue to use the camera in such a condition, the lens may be damaged or the lens cover may become stuck, causing a failure. To avoid such a failure, wash the camera using the following method.

- Insert the battery and close the battery/card compartment cover and connector cover firmly so that each lock makes the clicking sound.
- Fill a bucket with fresh water, immerse the camera in the bucket with the lens surface downward and shake the camera thoroughly.
- Press the **POWER** button several times in the water and close/open the lens cover repeatedly.
- Furthermore, shake the camera further with the cover opened.

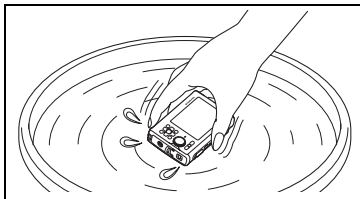

Follow the steps ① to ④, then check if the lens cover moves smoothly.

If the lens cover does not move smoothly, rinse the lens face by placing it directly under a strong stream of tap water and pressing the **POWER** button repeatedly.

Storage and Maintenance

- Do not leave the camera in an environment at high temperature (40°C (104°F) or more) or at low temperature (-10°C (14°F) or less). Failure to do so may break down water resistance.
- Do not use chemicals for cleaning, rust prevention, anti-fogging, repairing, etc. Failure to do so may break down water resistance.
- Do not leave the camera in water for a long time. Failure to do so will cause damage to the camera's appearance and/or deteriorate water resistance.**
- In addition do not pour water over the camera directly from the water faucet.
- In order to preserve the water resistant feature, as with any underwater housing, it is recommended that the waterproof packing (and seals) are replaced annually.**
For the Olympus distributors or service stations where the waterproof packing can be replaced, visit Olympus website for your local area.

Closing Battery/Card Compartment Cover and Connector cover

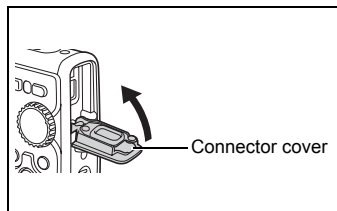
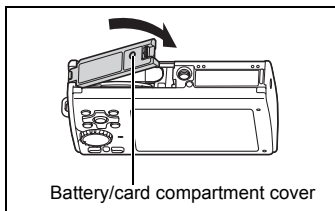

Note: The included accessories (e.g. charger) do not offer shock or water resistance.

*1 as determined by Olympus pressure testing equipment in accordance to IEC Standard Publication 529 IPX8 - This means that the camera can be used normally under water at a specified water pressure.

*2 This anti-shock performance is confirmed by Olympus' testing conditions in accordance with MIL-STD-810F, Method 516.5, Procedure IV (Transit Drop Test). For more details of Olympus' testing conditions, please refer to the Olympus website for your local area.

SAFETY PRECAUTIONS

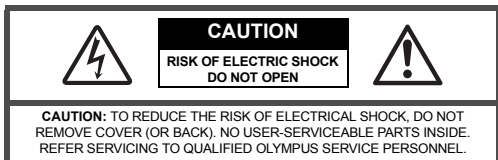

An exclamation mark enclosed in a triangle alerts you to important operating and maintenance instructions in the documentation provided with the product.



DANGER

If the product is used without observing the information given under this symbol, serious injury or death may result.



WARNING

If the product is used without observing the information given under this symbol, injury or death may result.



CAUTION

If the product is used without observing the information given under this symbol, minor personal injury, damage to the equipment, or loss of valuable data may result.

WARNING!

TO AVOID THE RISK OF FIRE OR ELECTRICAL SHOCK, NEVER DISASSEMBLE, EXPOSE THIS PRODUCT TO WATER OR OPERATE IN A HIGH HUMIDITY ENVIRONMENT.

General Precautions

Read All Instructions — Before you use the product, read all operating instructions. Save all manuals and documentation for future reference.

Cleaning — Always unplug this product from the wall outlet before cleaning. Use only a damp cloth for cleaning. Never use any type of liquid or aerosol cleaner, or any type of organic solvent to clean this product.

Attachments — For your safety, and to avoid damaging the product, use only accessories recommended by Olympus.

Water and Moisture — For precautions on products with weatherproof designs, read the weatherproofing sections.

Location — To avoid damage to the product, mount the product securely on a stable tripod, stand, or bracket.

Power Source — Connect this product only to the power source described on the product label.

Lightning — If a lightning storm occurs while using an AC adapter, remove it from the wall outlet immediately.

Foreign Objects — To avoid personal injury, never insert a metal object into the product.

Heat — Never use or store this product near any heat source such as a radiator, heat register, stove, or any type of equipment or appliance that generates heat, including stereo amplifiers.



WARNING

- **Do not use the camera near flammable or explosive gases.**
- **Do not use the flash and LED on people (infants, small children, etc.) at close range.**
 - You must be at least 1 m (3 ft.) away from the faces of your subjects. Firing the flash too close to the subject's eyes could cause a momentary loss of vision.
- **Keep young children and infants away from the camera.**
 - Always use and store the camera out of the reach of young children and infants to prevent the following dangerous situations which could cause serious injury:
 - Becoming entangled in the camera strap, causing strangulation.
 - Accidentally swallowing the battery, cards or other small parts.
 - Accidentally firing the flash into their own eyes or those of another child.
 - Accidentally being injured by the moving parts of the camera.
- **Do not look at the sun or strong lights with the camera.**
- **Do not use or store the camera in dusty or humid places.**
- **Do not cover the flash with a hand while firing.**



CAUTION

- **Stop using the camera immediately if you notice any unusual odors, noise, or smoke around it.**
 - Never remove the batteries with bare hands, which may cause a fire or burn your hands.
- **Do not leave the camera in places where it may be subject to extremely high temperatures.**
 - Doing so may cause parts to deteriorate and, in some circumstances, cause the camera to catch fire. Do not use the charger or AC adapter if it is covered (such as a blanket). This could cause overheating, resulting in fire.
- **Handle the camera with care to avoid getting a low-temperature burn.**
 - When the camera contains metal parts, overheating can result in a low-temperature burn. Pay attention to the following:
 - When used for a long period, the camera will get hot. If you hold on to the camera in this state, a low-temperature burn may be caused.
 - In places subject to extremely cold temperatures, the temperature of the camera's body may be lower than the environmental temperature. If possible, wear gloves when handling the camera in cold temperatures.
- **Be careful with the strap.**
 - Be careful with the strap when you carry the camera. It could easily catch on stray objects - and cause serious damage.
- **Do not touch the metallic parts of the camera for a long period of time at low temperatures.**
 - This may damage your skin. At low temperatures, handle the camera while wearing gloves.

Battery Handling Precautions

Follow these important guidelines to prevent batteries from leaking, overheating, burning, exploding, or causing electrical shocks or burns.



DANGER

- The camera uses a lithium ion battery specified by Olympus. Charge the battery with the specified charger. Do not use any other chargers.
- Never heat or incinerate batteries.
- Take precautions when carrying or storing batteries to prevent them from coming into contact with any metal objects such as jewelry, pins, fasteners, etc.
- Never store batteries where they will be exposed to direct sunlight, or subjected to high temperatures in a hot vehicle, near a heat source, etc.
- To prevent causing battery leaks or damaging their terminals, carefully follow all instructions regarding the use of batteries. Never attempt to disassemble a battery or modify it in any way, by soldering, etc.
- If battery fluid gets into your eyes, flush your eyes immediately with clear, cold running water and seek medical attention immediately.
- Always store batteries out of the reach of small children. If a child accidentally swallows a battery, seek medical attention immediately.



WARNING

- Keep batteries dry at all times.
- To prevent batteries from leaking, overheating, or causing a fire or explosion, use only batteries recommended for use with this product.
- Insert the battery carefully as described in the operating instructions.
- If rechargeable batteries have not been recharged within the specified time, stop charging them and do not use them.
- Do not use a battery if it is cracked or broken.
- If a battery leaks, becomes discolored or deformed, or becomes abnormal in any other way during operation, stop using the camera.
- If a battery leaks fluid onto your clothing or skin, remove the clothing and flush the affected area with clean, running cold water immediately. If the fluid burns your skin, seek medical attention immediately.
- Never subject batteries to strong shocks or continuous vibration.



CAUTION

- Before loading, always inspect the battery carefully for leaks, discoloration, warping, or any other abnormality.
- The battery may become hot during prolonged use. To avoid minor burns, do not remove it immediately after using the camera.
- Always unload the battery from the camera before storing the camera for a long period.

Caution for Usage Environment

- To protect the high-precision technology contained in this product, never leave the camera in the places listed below, no matter if in use or storage:
 - Places where temperatures and/or humidity are high or go through extreme changes. Direct sunlight, beaches, locked cars, or near other heat sources (stove, radiator, etc.) or humidifiers.
 - In sandy or dusty environments.
 - Near flammable items or explosives.
 - In wet places, such as bathrooms or in the rain. When using products with weatherproof designs, read their manuals as well.
 - In places prone to strong vibrations.
- Never drop the camera or subject it to severe shocks or vibrations.
- When mounted on a tripod, adjust the position of the camera with the tripod head. Do not twist the camera.
- Do not touch electric contacts on cameras.
- Do not leave the camera pointed directly at the sun. This may cause lens or shutter curtain damage, color failure, ghosting on the CCD, or may possibly cause fires.
- Do not push or pull severely on the lens.
- Before storing the camera for a long period, remove the battery. Select a cool, dry location for storage to prevent condensation or mold from forming inside the camera. After storage, test the camera by turning it on and pressing the shutter release button to make sure that it is operating normally.
- Always observe the operating environment restrictions described in the camera's manual.
- The altitude/depth measurement function is not approved by an official institution. Use the readings only for your reference.

Battery Handling Precautions

- This camera uses a lithium ion battery specified by Olympus. Do not use any other type of battery. For safe and proper use, read the battery's instruction manual carefully before using it.
- If the battery's terminals get wet or greasy, camera contact failure may result. Wipe the battery well with a dry cloth before use.
- Always charge a battery when using it for the first time, or if it has not been used for a long period.
- When operating the camera with battery power at low temperatures, try to keep the camera and spare battery as warm as possible. A battery that has run down at low temperatures may be restored after it is warmed at room temperature.
- The number of pictures you can take may vary depending on the shooting conditions or battery.
- Before going on a long trip, and especially before traveling abroad, purchase extra batteries. A recommended battery may be difficult to obtain while traveling.
- Please recycle batteries to help save our planet's resources. When you throw away dead batteries, be sure to cover their terminals and always observe local laws and regulations.

Monitor

- Do not push the monitor forcibly; otherwise the image may become vague, resulting in a playback mode failure or damage to the monitor.
- A strip of light may appear on the top/bottom of the monitor, but this is not a malfunction.
- When a subject is viewed diagonally in the camera, the edges may appear zigzagged on the monitor. This is not a malfunction; it will be less noticeable in playback mode.
- In places subject to low temperatures, the monitor may take a long time to turn on or its color may change temporarily. When using the camera in extremely cold places, it is a good idea to occasionally place it in a warm place. A monitor exhibiting poor performance due to low temperatures will recover in normal temperatures.
- The LCD used for the monitor is made with high-precision technology. However, black spots or bright spots of light may appear constantly on the Monitor. Due to its characteristics or the angle at which you are viewing the monitor, the spot may not be uniform in color and brightness. This is not a malfunction.

Legal and Other Notices

- Olympus makes no representations or warranties regarding any damages, or benefit expected by using this unit lawfully, or any request from a third person, which are caused by the inappropriate use of this product.
- Olympus makes no representations or warranties regarding any damages or any benefit expected by using this unit lawfully which are caused by erasing picture data.

Disclaimer of Warranty

- Olympus makes no representations or warranties, either expressed or implied, by or concerning any content of these written materials or software, and in no event shall be liable for any implied warranty of merchantability or fitness for any particular purpose or for any consequential, incidental or indirect damages (including but not limited to damages for loss of business profits, business interruption and loss of business information) arising from the use or inability to use these written materials or software or equipment. Some countries do not allow the exclusion or limitation of liability for consequential or incidental damages, so the above limitations may not apply to you.
- Olympus reserves all rights to this manual.

Warning

Unauthorized photographing or use of copyrighted material may violate applicable copyright laws. Olympus assumes no responsibility for unauthorized photographing, use or other acts that infringe upon the rights of copyright owners.

Copyright Notice

All rights reserved. No part of these written materials or this software may be reproduced or used in any form or by any means, electronic or mechanical, including photocopying and recording or the use of any type of information storage and retrieval system, without the prior written permission of Olympus. No liability is assumed with respect to the use of the information contained in these written materials or software, or for damages resulting from the use of the information contained therein. Olympus reserves the right to alter the features and contents of this publication or software without obligation or advance notice.



"CE" mark indicates that this product complies with the European requirements for safety, health, environment and customer protection. "CE" mark cameras are intended for sales in Europe.



This symbol [crossed-out wheeled bin WEEE Annex IV] indicates separate collection of waste electrical and electronic equipment in the EU countries. Please do not throw the equipment into the domestic refuse. Please use the return and collection systems available in your country for the disposal of this product.

Use Only Dedicated Rechargeable Battery and Battery Charger

We strongly recommend that you use only the genuine Olympus dedicated rechargeable battery and battery charger with this camera.

Using a non-genuine rechargeable battery and/or battery charger may result in fire or personal injury due to leakage, heating, ignition or damage to the battery. Olympus does not assume any liability for accidents or damage that may result from the use of a battery and/or battery charger that are not genuine Olympus accessories.

Provisions of warranty

1. If this product proves to be defective, although it has been used properly (in accordance with the written Handling Care and Operating instructions supplied with it), during a period of two years from the date of purchase from an authorized Olympus distributor within the business area of Olympus Imaging Europa GmbH as stipulated on the website: <http://www.olympus.com> this product will be repaired, or at Olympus's option replaced, free of charge. To claim under this warranty the customer must take the product and this Warranty Certificate before the end of the two year warranty period to the dealer where the product was purchased or any other Olympus service station within the business area of Olympus Imaging Europa GmbH as stipulated on the website: <http://www.olympus.com>. During the one year period of the World Wide Warranty the customer may turn the product in at any Olympus service station. Please notice that not in all countries such Olympus service station exists.
2. The customer shall transport the product to the dealer or Olympus authorized service station at his own risk and shall be responsible for any costs incurred in transporting the product.
3. This warranty does not cover the following and the customer will be required to pay repair charge, even for defects occurring within the warranty period referred to above.
 - (a) Any defect that occurs due to mishandling (such as an operation performed that is not mentioned in the Handling Care or other sections of the instructions, etc.)
 - (b) Any defect that occurs due to repair, modification, cleaning, etc. performed by anyone other than Olympus or an Olympus authorized service station.
 - (c) Any defect or damage that occurs due to transport, a fall, shock, etc. after purchase of the product.
 - (d) Any defect or damage that occurs due to fire, earthquake, flood damage, thunderbolt, other natural disasters, environmental pollution and irregular voltage sources.
 - (e) Any defect that occurs due to careless or improper storage (such as keeping the product under conditions of high temperature and humidity, near insect repellents such as naphthalene or harmful drugs, etc.), improper maintenance, etc.
 - (f) Any defect that occurs due to exhausted batteries, etc.
 - (g) Any defect that occurs due to sand, mud, etc. entering the inside of the product casing.
 - (h) When this Warranty Certificate is not returned with the product.
 - (i) When any alterations whatsoever are made to the Warranty Certificate regarding the year, month and date of purchase, the customer's name, the dealer's name, and the serial number.
 - (j) When proof of purchase is not presented with this Warranty Certificate.
4. This Warranty applies to the product only; the Warranty does not apply to any other accessory equipment, such as the case, strap, lens cap and batteries.
5. Olympus's sole liability under this warranty shall be limited to repairing or replacing the product. Any liability for indirect or consequential loss or damage of any kind incurred or suffered by the customer due to a defect of the product, and in particular any loss or damage caused to any lenses, films, other equipment or accessories used with the product or for any loss resulting from a delay in repair or loss of data, is excluded. Compelling regulations by law remain unaffected by this.

Notes regarding warranty maintenance

1. This warranty will only be valid if the Warranty Certificate is duly completed by Olympus or an authorized dealer or other documents contain sufficient proof. Therefore, please make sure that your name, the name of the dealer, the serial number and the year, month and date of purchase are all completed or the original invoice or the sales receipt (indicating the dealer's name, the date of purchase and product type) is attached to this Warranty Certificate. Olympus reserves the right to refuse free-of-charge service if neither Warranty Certificate is completed nor the above document is attached or if the information contained in it is incomplete or illegible.
 2. Since this Warranty Certificate will not be re-issued, keep it in a safe place.
- Please refer to the list on the web site: <http://www.olympus.com> for the authorized international Olympus service network.

Trademarks

- IBM is a registered trademark of International Business Machines Corporation.
- Microsoft and Windows are registered trademarks of Microsoft Corporation.
- Macintosh is a trademark of Apple Inc.
- xD-Picture Card™ is a trademark.
- All other company and product names are registered trademarks and/or trademarks of their respective owners.
- The standards for camera file systems referred to in this manual are the "Design Rule for Camera File System/DCF" standards stipulated by the Japan Electronics and Information Technology Industries Association (JEITA).

SPECIFICATIONS

● Camera

Product type	: Digital camera (for recording and playback)
Recording system	
Still pictures	: Digital recording, JPEG (in accordance with Design rule for Camera File system (DCF))
Applicable standards	: Exif 2.2, Digital Print Order Format (DPOF), PRINT Image Matching III, PictBridge
Sound with still pictures	: Wave format
Movies	: AVI Motion JPEG
Memory	: Internal memory xD-Picture Card 16 MB to 2 GB (TypeH/M, Standard)
No. of pictures (when fully charged)	: Approx. 260 (based on CIPA battery life measurement standards)
No. of effective pixels	: 10,100,000 pixels
Image pickup device	: 1/2.33" CCD (primary color filter), 10,700,000 pixels (gross)
Lens	: Olympus lens 5.0 to 18.2 mm, f3.5 to 5.1 (equivalent to 28 to 102 mm on a 35 mm camera)
Photometric system	: Digital ESP metering, spot metering system
Shutter speed	: 4 to 1/1000 sec.
Shooting range	: 0.5 m (1.6 ft.) to ∞ (W/T) (normal) 0.1 m (0.3 ft.) to ∞ (W), 0.3 m (1.0 ft.) to ∞ (T) (macro mode) 0.02 m (0.8 in.) to 0.5 m (1.6 ft.) (W only) (super macro mode) 0.07 m (2.8 in.) to 0.2 m (0.7 ft.) (W only) (S-macro LED mode)
Monitor	: 2.7" TFT color LCD display, 230,000 dots
Flash charge time	: Approx. 3.5 sec. (for full flash discharge at room temperature using a new fully charged battery)
Outer connectors	: Multi-connector (DC-IN jack, USB connector, A/V OUT jack)
Automatic calendar system	: 2000 up to 2099
Water resistance	
Type	: Equivalent to IEC Standard publication 529 IPX8 (under OLYMPUS test conditions), available in 10 m (32.8 feet) deep water
Meaning	: Camera can normally be used under water at a specified water pressure.
Dust resistance	: IEC Standard publication 529 IP6X (under OLYMPUS test conditions)
Operating environment	
Temperature	: -10°C to 40°C (14°F to 104°F) (operation)/ -20°C to 60°C (-4°F to 140°F) (storage)
Humidity	: 30% to 90% (operation)/10% to 90% (storage)
Power supply	: One Olympus lithium ion battery (LI-50B) or Olympus AC adapter
Dimensions	: 93.2 mm (W) × 61.4 mm (H) × 21.3 mm (D) (3.7 × 2.4 × 0.8 in.) (excluding protrusions)
Weight	: 173 g (6.1 oz) (excluding battery and card)

"Shadow Adjustment Technology" function contains patented technologies from Apical Limited.



● Lithium ion battery (LI-50B)

Product type	: Lithium ion rechargeable battery
Model No.	LI-50BA/LI-50BB
Standard voltage	: DC 3.7 V
Standard capacity	: 925 mAh
Battery life	: Approx. 300 full charges (varies on usage)
Operating environment	
Temperature	: 0°C to 40°C (32°F to 104°F) (charging)/ -10°C to 60°C (14°F to 140°F) (operation)/ -10°C to 35°C (14°F to 95°F) (storage)
Dimensions	: 34.4 × 40.0 × 7.0 mm (1.4 × 1.6 × 0.3 in.)
Weight	: Approx. 20 g (0.7 oz)

● Battery charger (LI-50C)

Model No.	LI-50CAA/LI-50CAB/LI-50CBA/LI-50CBB
Power requirements	: AC 100 to 240 V (50 to 60 Hz)
Output	: DC 4.2 V, 700 mA
Charging time	: Approx. 2 hours
Operating environment	
Temperature	: 0°C to 40°C (32°F to 104°F) (operation)/ -20°C to 60°C (-4°F to 140°F) (storage)
Dimensions	: 62.0 × 23.8 × 90.0 mm (2.4 × 0.9 × 3.5 in.)
Weight	: Approx. 70 g (2.5 oz)

● Using in low temperatures

Low temperature operation of the optional Olympus xD-Picture Card and lithium ion battery are guaranteed to 0°C (32°F). However, the following have been tested for use with this product in temperatures up to -10°C (14°F).

Olympus xD-Picture Card

	16 MB	32 MB	64 MB	128 MB	256 MB	512 MB	1 GB	2 GB
Standard	✓	✓	✓	✓	✓	✓	/	/
TypeM	/	/	/	/	✓	✓	✓	✓
TypeH	/	/	/	/	✓	✓	✓	✓

✓: Operation confirmed

Olympus lithium ion battery

LI-50B

- The number of storable still pictures is reduced in low temperatures.

Design and specifications subject to change without notice.

CAMERA DIAGRAM

Camera

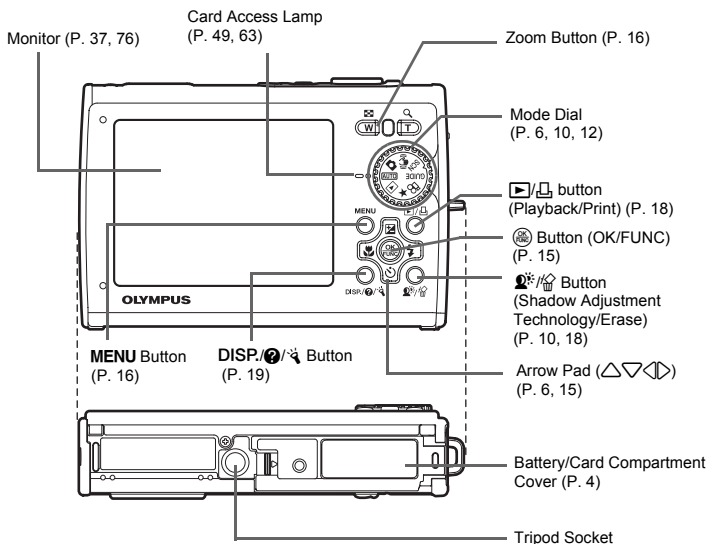
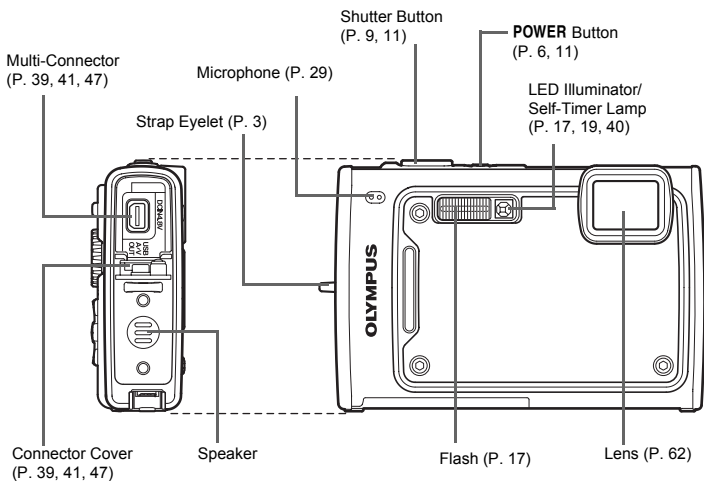

● Monitor - Shooting mode

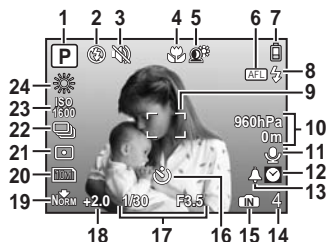

Still picture

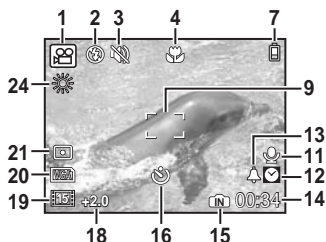

Movie

	Item	Indication	Ref. Page
1	Shooting modes	etc.	P. 12, 15, 26
2	Flash mode		P. 17
3	Silent mode		P. 29
4	Macro mode Super macro mode S-macro LED mode		P. 17
5	Shadow Adjustment Technology		P. 18
6	AF lock mark		P. 12
7	Battery check	= full power, = low power	P. 58
8	Flash standby Camera movement warning/ flash charge	(Lit) (Blinks)	P. 51
9	AF target mark		P. 9, 11, 29
10	Pressure, altitude/depth	960hPa 0m etc.	P. 40
11	Sound record		P. 29
12	Dualtime		P. 38
13	Alarm		P. 38
14	Number of storable still pictures Remaining recording time	4 00:34	P. 54
15	Current memory	(Recording pictures to the internal memory), No icon (Recording pictures to the card)	P. 63
16	Self-timer		P. 17
17	Shutter speed/ Aperture value	1/30 F3.5, etc.	-
18	Exposure compensation	-2.0 – +2.0	P. 17
19	Compression Frame rate	(NORMAL), (FINE) (15 frames/sec.), (30 frames/sec.)	P. 23
20	Image size	etc.	P. 23

	Item	Indication	Ref. Page
21	Spot metering		P. 29
22	Drive		P. 28
23	ISO	ISO 100, ISO 400, ISO 1600, etc.	P. 28
24	White balance		P. 27

● Monitor - Playback mode

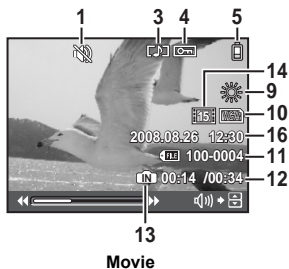
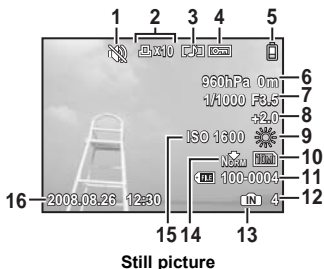































	Item	Indication	Ref. Page
1	Silent mode		P. 29
2	Print reservation/Number of prints	x10	P. 44
3	Sound record		P. 34
4	Protect		P. 33
5	Battery check	= full power, = low power	P. 58
6	Pressure, altitude/depth	960hPa 0m etc.	P. 40
7	Shutter speed/ Aperture value	1/1000 F3.5, etc.	-
8	Exposure compensation	-2.0 - +2.0	P. 17
9	White balance	WB AUTO,	P. 27
10	Image size	etc.	P. 23
11	File number	100-0004	P. 37
12	Number of frames Elapsed time/ Total recording time	4 00:14/00:34	- P. 14
13	Current memory	(Playing back the picture in the internal memory), No icon (Playing back the picture in the card)	P. 63
14	Compression Frame rate	(NORMAL), (FINE) (15 frames/sec.), (30 frames/sec.)	P. 23
15	ISO	ISO 100, ISO 400, ISO 1600, etc.	P. 28
16	Date and time	2008.08.26 12:30	P. 7, 37

Index

CAMERA DIAGRAM	75
VOLUME	36
A	
AC adapter	64
ADD FAVORITE	15, 31
Adding sound to still pictures 	34
AF lock	12
AF MODE	29
AF target mark	9, 11, 29
ALARM CLOCK 	38
ALL (SLIDESHOW)	30
ALL ERASE 	34
ALL INDEX	42
ALL PRINT	42
All-frame reservation 	44
AUTO (Auto-flash)	17
AUTO (ISO)	28
AUTO (WB) WB AUTO	27
Auto focus	52
AV cable	3, 39
B	
BACKUP	35
Battery	4, 62
Battery charger	3, 4, 62, 64
Battery check	76
BEEP	36
BGM	30
Black & White	32
C	
CALENDAR	32
CALENDAR (SLIDESHOW)	30
Calendar display	16
CAMERA MENU	23, 27
Card	24, 35, 63
CCD	37
Close-up playback 	16
Cloudy day 	27
COLOR EDIT	32
COMBINE IN CAMERA1	24
COMBINE IN CAMERA2	24
COMBINE IN PC	24
COMPRESSION	23
Continuous recording length	55
Cropping a picture 	31, 43
CUSTOM PRINT	42
D	
Date and time 	7, 37
Digital image stabilization mode 	6, 12
DIGITAL ZOOM	28
Direct printing	41
Display language 	35
DPOF	44
DRIVE	28
DUALTIME 	38

E	
EASY PRINT	41
EDIT	31
ERASE	34
Erase	10, 18
Error message	58
ESP	29
ESP/	29
EV	17
Exposure	17
Exposure compensation 	17, 77
F	
FACE DETECT	29
FILE NAME	37, 43
File name	37
Fill-in flash 	17
FINE 	23
FINE ZOOM	28
Flash charge	51, 76
Flash mode 	11, 17
Flash off 	17
Fluorescent lamp1/2/3 	27
Focus	9, 11, 12, 28, 52
Focus lock	11
FORMAT	35
Format	35
FRAME	32
Frame number	77
FRAME RATE	24
Function menu	15
G	
GUIDE (Shooting guide)	6, 13
H	
High speed sequential shooting 	28
Histogram display	19, 56
I	
iESP	29
IMAGE QUALITY	23
IMAGE SIZE	23
INDEX	33
Index display 	16
Information displays	19
Internal memory	35, 63
ISO	28
L	
LABEL	32
LED ILLUMINATOR	40
Lithium ion battery	3, 4, 62
M	
m/ft	40
Macro mode 	11, 17
MANOMETER	40
MEMORY FORMAT	35
Menu	21

MENU COLOR	36	Shooting mode	11, 16, 19, 35
Menu guide	19	Shooting still pictures (Full auto mode) AUTO	6, 12
Monitor brightness adjustment 	37	Shooting still pictures (Program auto) 	6, 12
Monitor Symbols & Icons	76	SHUTTER SOUND	36
MOVIE (SLIDESHOW)	30	SILENT MODE 	29
MOVIE (Topmenu)	27	Single-frame playback	16
MULTI PRINT	42	Single-frame reservation 	44
N		Single-frame shooting 	28
NON-WATER MOVIE 	27	Sleep mode	51
NORMAL 	23	SLIDESHOW	30
NTSC	39	S-macro LED mode 	11, 17
Number of storable still pictures	54	SOUND SETTINGS	36
O		SPOT (AF MODE)	29
OLYMPUS Master	3, 46	Spot metering 	29
Operation guide	21, 42, 44	STILL PICTURE (SLIDESHOW)	30
Optical zoom	16, 28	Strap	3
P		Sunny day 	27
PAL	39	Super macro mode 	11, 17
PANORAMA	24	T	
Panorama playback	14	Top menu	21
PC	47	Tungsten light 	27
PERFECT FIX	30	Turn the camera on	6
PictBridge	41	TYPE	30
Picture rotation 	33	U	
PIXEL MAPPING	37	Under water 1/2/3  1  2  3	28
Play "My Favorite" 	15	UNDERWATER MOVIE 	27
PLAYBACK MENU	30, 33	USB cable	3, 41, 46, 47, 49
Playback mode 	10, 11, 13, 16, 19, 35	V	
Playback on a TV	39	VIDEO OUT	39
Playing time/Total recording time	14	W	
POWER SAVE	40	Warning sound 	36
PRE-CAPTURE MOVIE 	27	White balance WB	27
Press completely	9, 11	X	
Press halfway	9, 11	xD-Picture Card	24, 63
PRINT ORDER 	33, 42	Z	
Print settings 	44	Zoom	16, 28
Printing pictures	41		
Protect 	33		
PW ON SETUP	36		
R			
REC VIEW	36		
Recording movies 	12		
Recording sound with still pictures 	29		
REDEYE FIX	30		
Red-eye reduction flash 	17		
RESET	24		
Resizing 	31		
S			
Saturation (High)	32		
Saturation (Low)	32		
SCN (Scene)	6, 12, 26		
SEL. IMAGE	34		
Self-timer 	11, 17		
Sepia	32		
Sequential shooting 	28		
SETUP menus	35		
SHADOW ADJ	30		
SHOOT & SELECT 1/2 	27		

OLYMPUS®

<http://www.olympus.com/>

OLYMPUS IMAGING CORP.

Shinjuku Monolith, 3-1 Nishi-Shinjuku 2-chome, Shinjuku-ku, Tokyo, Japan

OLYMPUS IMAGING AMERICA INC.

3500 Corporate Parkway, P.O. Box 610, Center Valley, PA 18034-0610, U.S.A. Tel. 484-896-5000

Technical Support (USA)

24/7 online automated help: <http://www.olympusamerica.com/support>

Phone customer support: Tel. 1-888-553-4448 (Toll-free)

Our phone customer support is available from 8 am to 10 pm

(Monday to Friday) ET

<http://olympusamerica.com/contactus>

Olympus software updates can be obtained at: <http://www.olympusamerica.com/digital>

OLYMPUS IMAGING EUROPA GMBH

Premises: Wendenstrasse 14-18, 20097 Hamburg, Germany

Tel: +49 40-23 77 3-0 / Fax: +49 40-23 07 61

Goods delivery: Bredowstrasse 20, 22113 Hamburg, Germany

Letters: Postfach 10 49 08, 20034 Hamburg, Germany

European Technical Customer Support:

Please visit our homepage <http://www.olympus-europa.com>

or call our TOLL FREE NUMBER* : **00800 - 67 10 83 00**

for Austria, Belgium, Denmark, Finland, France, Germany, Italy, Luxemburg, Netherlands,
Norway, Portugal, Spain, Sweden, Switzerland, United Kingdom

* Please note some (mobile) phone services providers do not permit access or request an
additional prefix to +800 numbers.

For all European Countries not listed and in case that you can't get connected
to the above mentioned number, please make use of the following

CHARGED NUMBERS: **+49 180 5 - 67 10 83** or **+49 40 - 237 73 4899**

Our Technical Customer Support is available from 9 am to 6 pm MET (Monday to Friday)