

DIGITAL CAMERA

OLYMPUS[®]

Stylus 760 / *μ* 760

Instruction Manual

Quick Start Guide

Get started using your camera right away.

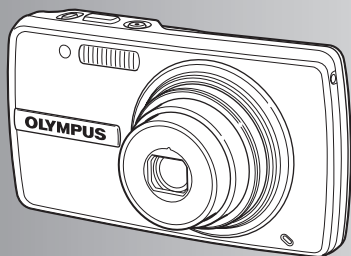

Button operations

Menu operations

Printing pictures

Using OLYMPUS Master

Getting to know your camera better

Appendix

- Thank you for purchasing an Olympus digital camera. Before you start to use your new camera, please read these instructions carefully to enjoy optimum performance and a longer service life. Keep this manual in a safe place for future reference.
- We recommend that you take test shots to get accustomed to your camera before taking important photographs.
- In the interest of continually improving products, Olympus reserves the right to update or modify information contained in this manual.
- The screen and camera illustrations shown in this manual were produced during the development stages and may differ from the actual product.

Quick Start Guide P. 3

Button operations P. 10

Test out the functions of the camera buttons by following along with the illustrations.

Menu operations P. 18

Learn about the menus that control the functions and settings for basic operation.

Printing pictures P. 36

Learn how to print pictures you have taken.

Using OLYMPUS Master P. 42

Learn how to transfer and save pictures to a computer.

Getting to know your camera better P. 50

Find out more about camera operations and how to take better pictures.

Appendix P. 60

Read about convenient functions and safety precautions on how to use your camera more effectively.

Gather these items (box contents)



Digital Camera



Strap

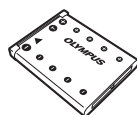

LI-42B
Lithium Ion Battery



LI-40C
Battery Charger



USB Cable

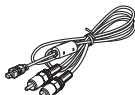

AV Cable



OLYMPUS Master
Software CD-ROM

Items not shown: Instruction Manual (this manual), warranty card. Contents may vary depending on purchase location.

Attach the strap

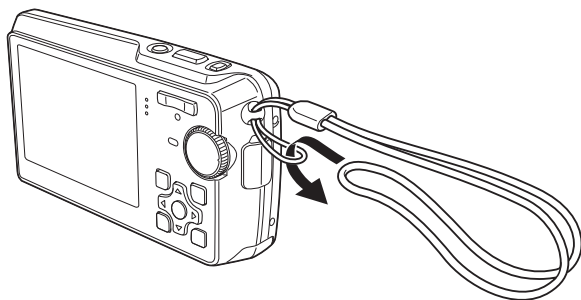

- Pull the strap tight so that it does not come loose.

Prepare the battery

a. Charge the battery

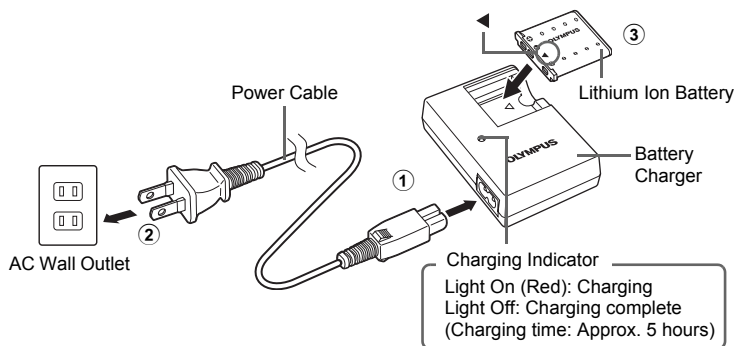

- Battery comes partially charged.

b. Insert the battery in the camera

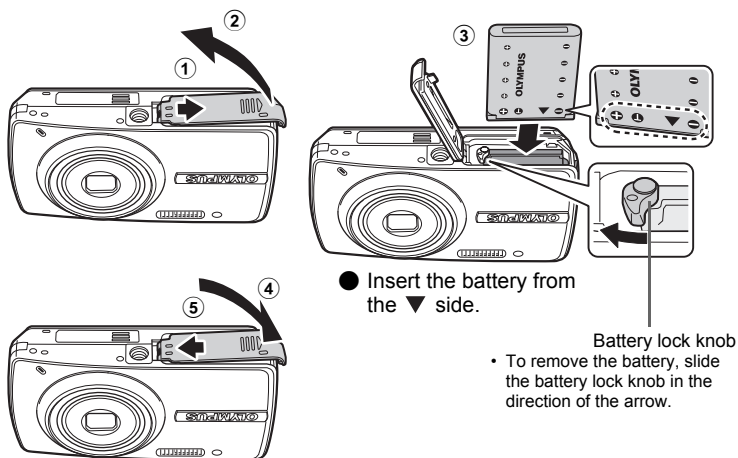

- You can shoot pictures with this camera even without using an optional xD-Picture Card™ (hereinafter referred to as “the card”). For details on inserting the card, please refer to “Inserting and removing the card” (P. 62).

Turn the camera on

This explains how to turn on the camera in shooting mode.

a. Set the mode dial to .

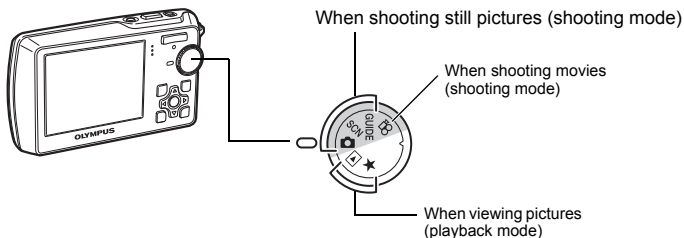

Still picture shooting modes

	This function allows you to shoot with the camera's automatic settings.
SCN	This function allows you to shoot pictures by selecting a scene according to the shooting condition.
GUIDE	This function allows you to set the target items by following the shooting guide displayed on the screen.

b. Press the **POWER** button.

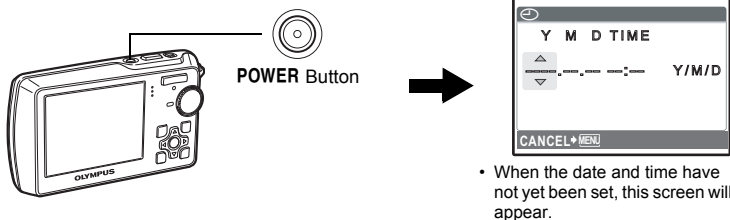

- To turn off the camera, press the **POWER** button once again.

Set date and time

About the date and time setting screen

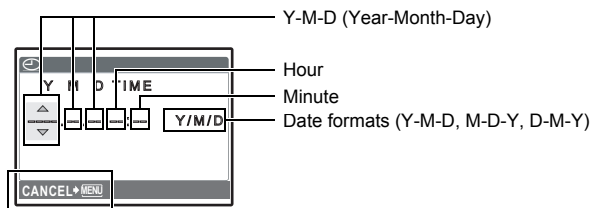

Exits a setting.

a. Press the button and the button to select [Y].

- The first two digits of the year are fixed.

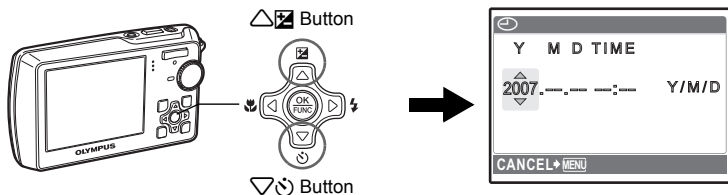

b. Press the button.

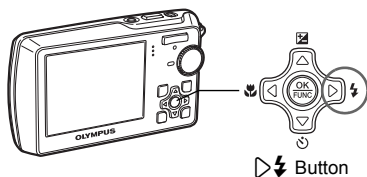

c. Press the button and the button to select [M].

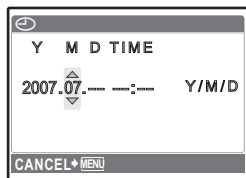

d. Press the button.

- e. Press the  button and the  button to select [D].

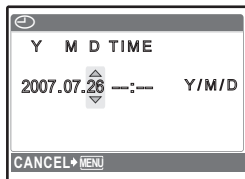

- f. Press the  button.
 g. Press the  button and the  button to select the hours and minutes.
 • The time is displayed in the 24-hour format.

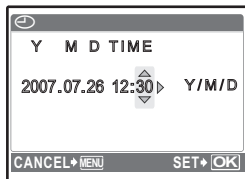

- h. Press the  button.
 i. Press the  button and the  button to select [Y/M/D].

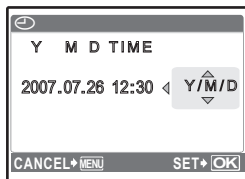

- j. After all items have been set, press the  button.
 • For precise time setting, press the  button as the time signal strikes 00 seconds.

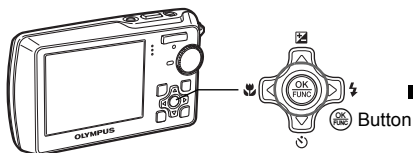

Take a picture

a. Hold the camera

Horizontal grip

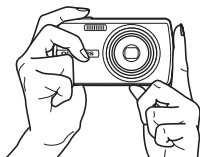

Vertical grip



b. Focus

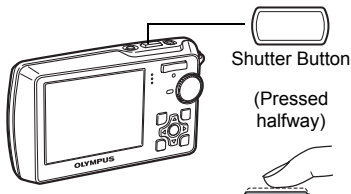

Place this mark over your subject.

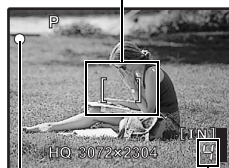

The number of storable still pictures is displayed.

The green lamp indicates the focus and exposure are locked.

c. Shoot

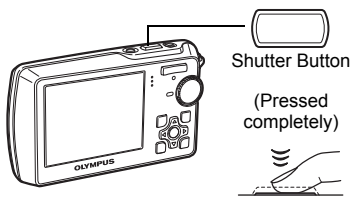

The card access lamp blinks.

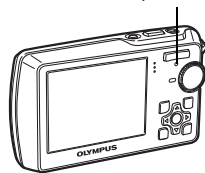

View pictures

- a. Set the mode dial to .

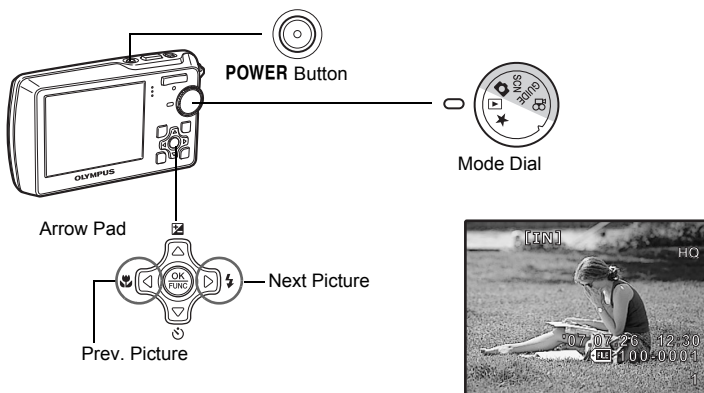

Erase pictures

- a. Press the   button and the   button to display the picture that you want to erase.
- b. Press the   button.

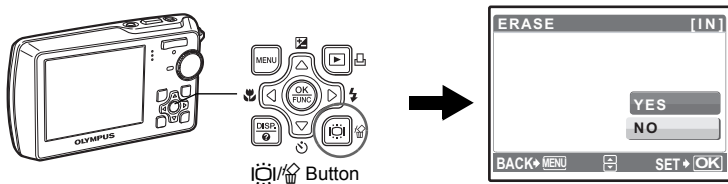

- c. Press the   button to select **[YES]** and press the  button to erase the picture.

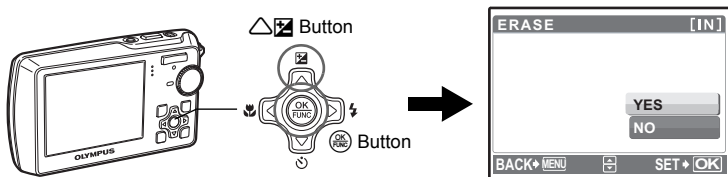

Button operations

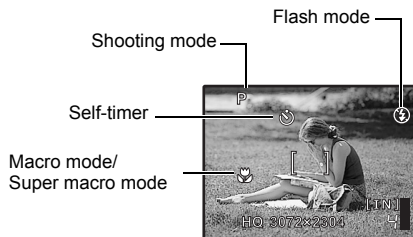
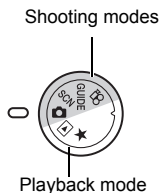
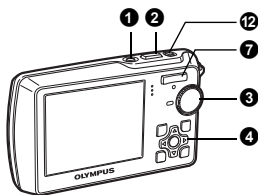
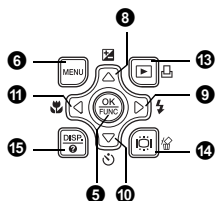

1 POWER button

Turning the camera on and off

Power on:

- Shooting mode
- Lens extends
- Monitor turns on

- Playback mode
- Monitor turns on

2 Shutter button

Shooting pictures

Shooting still pictures

Set the mode dial to **SCN** or **GUIDE**, and lightly press the shutter button (halfway). The green lamp lights when the focus and exposure are locked (focus lock). Now press the shutter button all the way (completely) to shoot a picture.

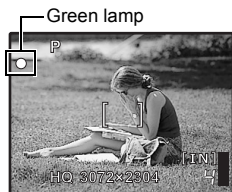

Focus lock - Locking the focus and then composing the shot

Compose your picture with the focus locked, and then fully press the shutter button to shoot a picture.

- If the green lamp blinks, the focus is not adjusted properly. Try locking the focus again.

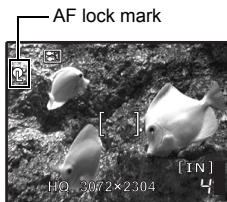

AF Lock - Locking the focus position

When the scene is , you can lock the focus position by pressing . Press again to cancel the AF lock.

SCN Shoot pictures by selecting a scene mode according to the situation" (P. 11)

- AF lock is automatically canceled after one shot.

Recording movies

Set the mode dial to , and lightly press the shutter button to lock the focus, and then press the shutter button completely to start recording. Press the shutter button again to stop recording.

3 Mode dial

Switching between shooting and playback modes

Set the mode dial to the desired shooting or playback mode.

Shooting still pictures

The camera determines the optimum settings for the shooting conditions automatically.

SCN Shoot pictures by selecting a scene mode according to the situation

You can shoot pictures by selecting a scene mode according to the situation.

Select a scene mode/change another scene mode to another one

- Press **MENU** to select [SCN] from the top menu, and change it to another scene mode.
- By switching to another scene mode, most settings will be changed to the default settings of each scene mode.

GUIDE Follow the shooting guide for setting

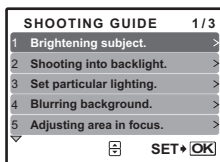

Follow the shooting guide displayed on the screen to set the target items.

- Press **MENU** to display the shooting guide again.
- To change the setting without using the shooting guide, set the shooting mode to another one.
- The content set using the shooting guide will change to the default setting by pressing **MENU** or changing the mode using the mode dial.

Recording movies

Audio is recorded with the movie.



This icon lights red during movie recording.

The remaining recording time is displayed. When the remaining recording time reaches 0, recording will stop automatically.

▶ Viewing still pictures/Selecting playback mode

The last picture taken is displayed.

- Press the arrow pad to view other pictures.
- Use the zoom button to switch between close-up playback, index display and calendar display.
- Press  to hide the information displayed on the screen for 3 seconds during single-frame playback.

 "MOVIE PLAY Playing back movies" (P. 26)

★ Viewing "My Favorite"



The still pictures registered in "My Favorite" are displayed.

- Press the arrow pad to view other pictures.
- Use the zoom button to switch among close-up playback and index display.





Press **MENU** during "My Favorite" playback to display the top menu, and then select [SLIDESHOW] or [ADD FAVORITE].

-  "SLIDESHOW Playing back pictures automatically" (P. 25)
- "ADD FAVORITE Adding favorite images" (P. 26)

Erasing pictures from "My Favorite"

YES/ NO

- Use the arrow pad to select the picture you want to erase, and press . Select [YES], and press .
- Erasing a picture from "My Favorite" does not erase the original picture recorded in the internal memory or to the card.

4 Arrow pad ()

Use the arrow pad to select scenes, playback picture, and the items on the menus.

5 button (OK/FUNC)

Displays the function menu which contains the functions and settings used during shooting. This button is also used to confirm your selection.

The functions you can set with the function menu

P/AUTO Shooting pictures with automatic settings

Select the shooting mode when you have set the mode dial to .

P (Program auto) The camera automatically sets the optimum aperture value and shutter speed for the brightness of the subject.

AUTO (Full auto mode) The camera automatically sets white balance and ISO sensitivity in addition to the aperture and shutter speed.

Other functions you can set with the function menu

- ☞ “WB Adjusting the color of a picture” (P. 22)
- “ISO Changing the ISO sensitivity” (P. 22)
- “DRIVE Using sequential (continuous) shooting” (P. 22)
- “ESP/☐ Changing the area for measuring the brightness of a subject” (P. 23)

Function menu

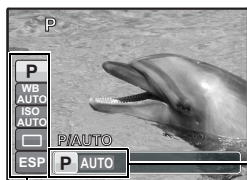

◀▶: Select a setting, and press .

△▽: Select the function to be set.

6 MENU button (MENU)

Displaying the top menu

Displays the top menu.

7 Zoom button

Zooming while shooting/close-up playback

Shooting mode: Zooming in on your subject

Optical zoom ratio: 3×



Zoom out:
Press W on the
zoom button.



Zoom in:
Press T on the
zoom button.

Playback mode: Changing the picture display

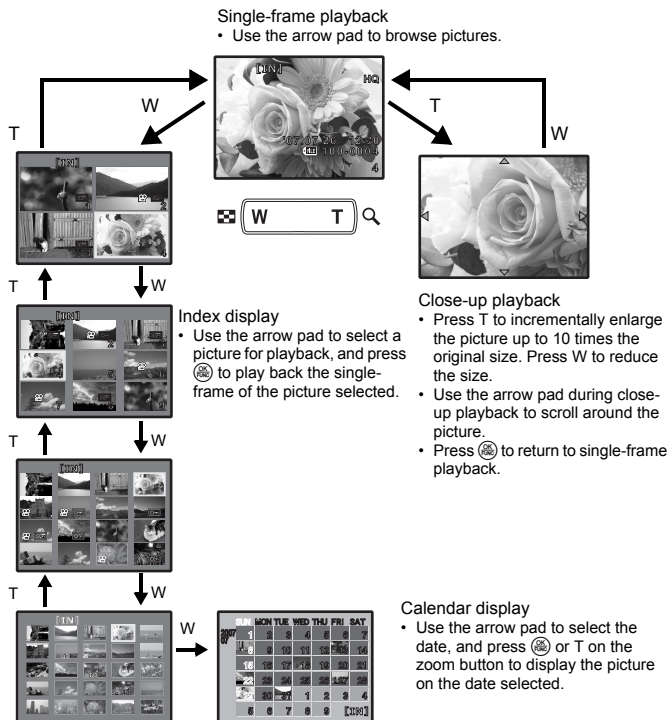

8 button

Changing picture brightness





Press in shooting mode, and then use the arrow pad to adjust the exposure and press to confirm the setting.



- Adjustable from -2.0EV to +2.0 EV

: Brighten
: Darken



Activate the setting.



9  **button****Flash shooting**

Press  in shooting mode to select the flash setting.
Press  to confirm your selection.

AUTO (Auto-flash)	The flash fires automatically in low light or backlight conditions.
 Red-eye reduction flash	This emits pre-flashes to reduce the occurrence of red-eye in your pictures.
 Fill-in flash	The flash fires regardless of the available light.
 Flash off	The flash does not fire even in low light conditions.



10  **button****Self-timer shooting**



Press  in shooting mode to select on and off for the self-timer.
Press  to confirm your selection.

 OFF	Cancel the self-timer.
 ON	Set the self-timer.

- After pressing the shutter button completely, the self-timer lamp lights for approximately 10 seconds, blinks for approximately 2 seconds, and then the picture is taken.
- To cancel the self-timer, press .
- Self-timer shooting is automatically canceled after one shot.



11  **button****Shooting pictures close to the subject**



Press  in shooting mode to select the macro mode.
Press  to confirm your selection.

OFF	Macro mode is deactivated.
 Macro mode	This mode lets you shoot as close as 20 cm/7.9 in. (wide) and 50 cm/19.7 in. (tele) from your subject.
 Super macro mode	This mode lets you shoot as close as 8 cm/3.2 in. from your subject.

- Zoom and flash cannot be used in super macro mode.

12  **button****Shooting pictures using the image stabilizer**

Press  in shooting mode to turn the image stabilizer on or off. Press  to confirm your selection.



 OFF	Image stabilizer is deactivated.
 ON	Image stabilizer is activated.

- It is recommended to make the image stabilizer inactive, when mounted on a tripod.
- At very slow shutter speeds (for example when taking night photographs), some images may not acquire the proper stabilization effect.
- If the camera is severely shaken, digital images may not be stabilized properly.

 Viewing pictures immediately

Press  in shooting mode to switch to playback mode and display the last picture taken.

Press  again or press the shutter button halfway to return to shooting mode.

  Viewing still pictures/Selecting playback mode" (P. 12)

 Printing pictures



When a printer is connected to the camera, display the picture you want to print in playback mode and press .

 "EASY PRINT" (P. 36)

14   button

Increasing the brightness of the monitor/Erasing pictures

 Increasing the brightness of the monitor

Press  in shooting mode. The monitor will be set to the brightest state set in  for 10 seconds.

  Adjusting the brightness of monitor" (P. 32)

 Erasing pictures

In playback mode, select the picture you want to erase, and press .

- Once erased, pictures cannot be restored. Check each picture before erasing to avoid accidentally erasing pictures you want to keep.

 "O-m Protecting pictures" (P. 29)

Changing the information displays

Press **DISP** to change the display in the following order.

Shooting mode

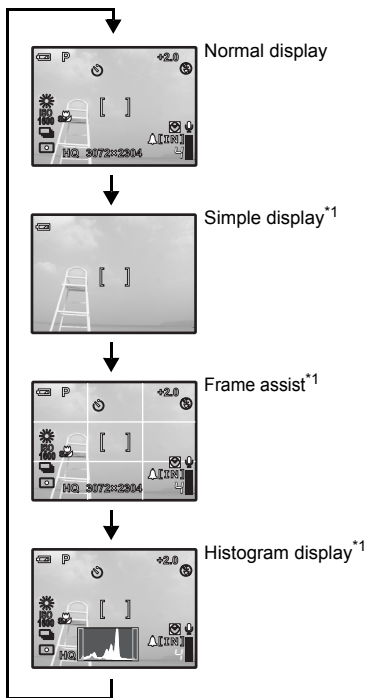

Playback mode

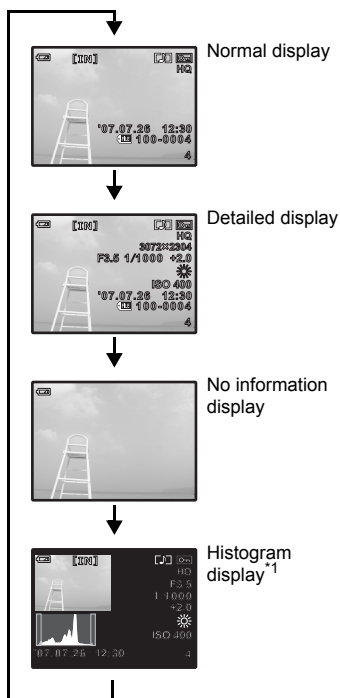

*1 Not displayed in case of .

Displaying the menu guide



With menu items selected, hold down **DISP** to display the menu guide. Release **DISP** to close the menu guide.

Checking the time

While the camera is off, press **DISP** to display the set alarm time (when [ALARM CLOCK] is set) and the current time for 3 seconds.

Menu operations

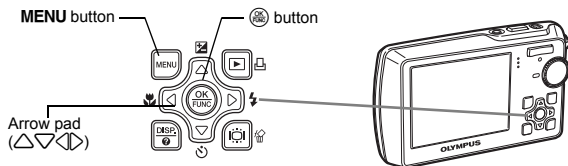

About the menu

Pressing **MENU** displays the top menu on the monitor.

- The items displayed on the top menu differ according to the mode.

Top menu (in still picture shooting mode)

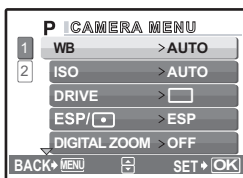
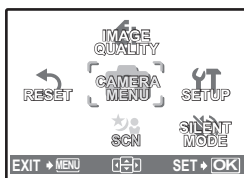

- When [CAMERA MENU], [PLAYBACK MENU], [EDIT], [ERASE], or [SETUP] is selected, the menu corresponding to the respective functions is displayed.
- When your camera is set according to the shooting guide with the mode dial set at **GUIDE**, press **MENU** to display the shooting guide screen.

Operation guide

During menu operations, the buttons and their respective functions are displayed at the bottom of the monitor. Follow these guides to navigate the menus.

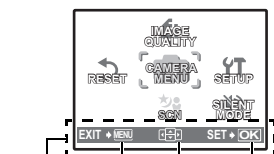

Operation guide

MENU
button

\triangle ∇ \leftarrow \rightarrow on
the arrow pad



BACK + MENU : Returns to the previous menu.



EXIT + MENU : Exits the menu.

\triangle ∇ \leftarrow \rightarrow : Press \triangle ∇ \leftarrow \rightarrow to select a setting.

SET + OK : Sets the selected item.

Using the menu



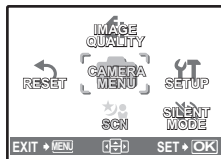

This explains how to use the menu with the [AF MODE] setting as an example.

- 1 Set the mode dial to .
- 2 Press **MENU** to display the top menu. Select [CAMERA MENU] and press  to confirm your selection.

- [AF MODE] is one of the selections on the [CAMERA MENU]. Press  to confirm your selection.



- 3 Use the arrow pad   to select [AF MODE], and press .



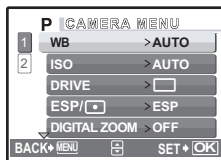

- Some settings may not be available, depending on the shooting/scene mode.
- When pressing  on this screen, the cursor moves to the page display. Press   to change the page. To select an item or function, press  or .

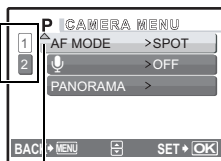

Page display: —————
The page display mark is displayed when there are additional menu items on the next page.



The selected item is displayed in a different color.

- 4 Use the arrow pad   to select [iESP] or [SPOT], and press .
- The menu item is set and the previous menu is displayed. Press **MENU** repeatedly to exit the menu.
 - To cancel changes and continue menu operation, press **MENU** before pressing .

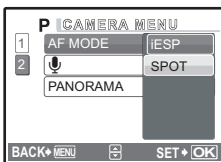

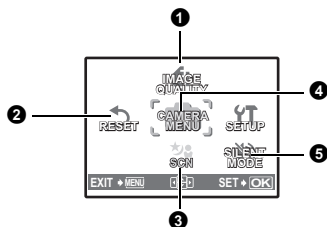

4 CAMERA MENU

WB	DIGITAL ZOOM
ISO	AF MODE
DRIVE	
ESP/	PANORAMA*

* An Olympus xD-Picture Card is required.

- Some functions are not available according to the selected mode.
- "Functions available in shooting modes and scene modes" (P. 58)
- "SETUP menus" (P. 30)
- The factory default settings are displayed in gray ().

1 IMAGE QUALITY

Changing the image quality

Still picture image quality and their applications

Image quality/Image size	Compression	Application
SHQ 3072 × 2304	Low compression	• This is useful for printing large images on A3-size (16.5 × 11.7 in.) paper.
HQ 3072 × 2304	Standard compression	• This is useful for performing computer image processing, such as contrast adjustment and red-eye correction.
SQ1 2560 × 1920 2304 × 1728 2048 × 1536	Standard compression	• This is useful for A3 (16.5 × 11.7 in.) /A4 (11.7 × 8.5 in.)-size prints. • This is useful for computer editing such as rotating or adding text to a picture.
SQ2 1600 × 1200 1280 × 960 1024 × 768 640 × 480	Standard compression Low compression	• This is useful for postcard-sized (6 × 4 in.) prints. • This is useful for viewing pictures on a computer. • This is useful for sending as e-mail attachments.
16:9 1920 × 1080	Standard compression	• This is useful for expressing the broadness of a subject such as landscapes and for viewing pictures on a wide-screen television.

Movie image quality

Image quality/Image size	
SHQ 640 × 480	
HQ 320 × 240	
SQ 160 × 120	

2 RESET

Restoring default settings

NO / YES

It restores shooting functions back to default settings. The mode dial must not be set to **GUIDE**.

Functions restored to the factory default settings

Function	Factory default setting	Ref. Page
	0.0	P. 14
	AUTO	P. 15
	OFF	P. 15
	OFF	P. 15
IMAGE STABILIZER	OFF	P. 15
IMAGE QUALITY	HQ	P. 20
WB	AUTO	P. 22
ISO	AUTO	P. 22
DRIVE		P. 22
ESP/	ESP	P. 23
DIGITAL ZOOM	OFF	P. 23
AF MODE	SPOT	P. 23
	OFF	P. 23

3 SCN (Scene)

Selecting a scene mode according to the shooting situation

PORTRAIT / LANDSCAPE / LANDSCAPE+PORTRAIT / NIGHT SCENE^{*1} /
NIGHT+PORTRAIT^{*1} / SPORT / INDOOR / CANDLE^{*1} / SELF PORTRAIT /
AVAILABLE LIGHT^{*1} / SUNSET^{*1} / FIREWORKS^{*1} / CUISINE / BEHIND GLASS /
DOCUMENTS / AUCTION / SHOOT & SELECT1^{*2} / SHOOT & SELECT2^{*3} /
BEACH & SNOW / UNDER WATER WIDE1 / UNDER WATER WIDE2^{*4} /
UNDER WATER MACRO

The scene mode selection screen displays sample images as well as a description of the shooting situation for which it is designed. It can be set only when the mode dial is set to **SCN**.

"Mode dial Switching between shooting and playback modes" (P. 11)

- By switching to another scene mode, most settings will be changed to the default settings of each scene mode.

^{*1} When the subject is dark, noise reduction is automatically activated. This approximately doubles the shooting time, during which the next picture can be taken.

^{*2} The focus is locked at the first frame.

^{*3} The camera focuses for each frame.

^{*4} The focus distance is fixed at approximately 5.0 m (16.4 ft.).

Scene mode selection screen



Set the scene mode.

[SHOOT & SELECT1]/[SHOOT & SELECT2]

- These scene modes allow you to take sequential pictures by holding down the shutter button. After shooting the pictures, select the ones you want to erase by marking them with a ✓ and press to erase them.

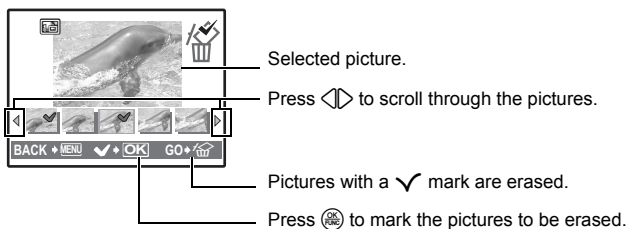

4 CAMERA MENU

WB..... Adjusting the color of a picture

AUTO		The white balance is adjusted automatically for natural color, regardless of the light source.
Sunny day		For shooting under a clear sky.
Cloudy day		For shooting under a cloudy sky.
Tungsten light		For shooting under tungsten lighting.
Fluorescent lamp 1		For shooting under daylight fluorescent lighting. (This type of lamp is mainly used in homes.)
Fluorescent lamp 2		For shooting under a neutral white fluorescent lamp. (This type of lamp is mainly used in desk lamps.)
Fluorescent lamp 3		For shooting under a white fluorescent lamp. (This type of lamp is mainly used in offices.)

ISO..... Changing the ISO sensitivity

AUTO		Sensitivity is automatically adjusted according to the conditions of the subject.
80/100/200/ 400/800/1600		A low value lowers the sensitivity for daylight shooting of clear, sharp pictures. The higher the value, the better the camera's light sensitivity and ability to shoot with a fast shutter speed and in low light conditions. However, high sensitivity introduces noise into the resulting picture, which may give it a grainy appearance.

DRIVE..... Using sequential (continuous) shooting

		Shoots 1 frame at a time when the shutter button is pressed.
		Focus and exposure are locked at the first frame. The sequential shooting speed varies depending on the image quality setting.
		Pictures can be taken at a faster speed than normal sequential shooting.

You can take a sequence of pictures at one time by holding down the shutter button. The camera will take pictures continuously until you release the shutter button.

- In [Fn], the settings change as follows.
 - The flash mode is fixed at [ON].
 - [ISO] is fixed at [AUTO].
 - [IMAGE QUALITY] is limited to [2048 × 1536] and lower.

ESP/ Changing the area for measuring the brightness of a subject

ESP Meters the brightness at the center of the monitor and the surrounding area separately to capture an image with balanced brightness. When taking pictures against strong backlight, the center of the picture may appear dark.

Only the center of the monitor is metered. Recommended for taking a picture against strong backlight.

DIGITAL ZOOM Zooming in on your subject

OFF /ON

The digital zoom can be used to take close-up shots with stronger magnification when combined with optical zoom. (Optical Zoom × Digital Zoom: maximum 15×)

Optical zoom

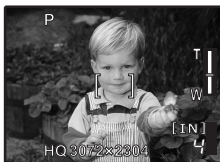

Digital zoom

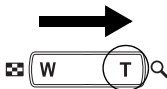

Zoom bar
 White area: The optical zoom area
 Red area: The digital zoom area

AF MODE Changing the focusing area

IESP The camera determines which subject within the screen to focus on. Even when the subject is not in the center of the screen, focusing is possible.

SPOT Focus selection is based on the subject within the AF target mark.

..... Recording sound with still pictures

OFF /ON

When activated [ON], the camera will record about 4 seconds of audio after the picture is taken.

When recording, aim the camera microphone at the source of the sound you want to record.

PANORAMACreating a panoramic picture

Panorama shooting lets you create a panoramic picture, using the OLYMPUS Master software from the provided CD-ROM. An Olympus xD-Picture Card is required for panorama shooting.

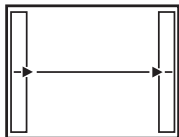

Connects pictures
from left to right

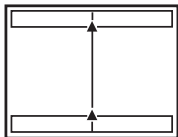

Connects pictures
from bottom to top

- ▷: The next picture is connected at the right edge.
- ◁: The next picture is connected at the left edge.

- △: The next picture is connected at the top.
- ▽: The next picture is connected at the bottom.

Use the arrow pad to specify at which edge you want to connect the pictures, and then compose your shots so that the edges of the pictures overlap. The part of the previous picture that will be combined will not remain in the frame. Remember the frame displayed on the monitor as a rough indication, then compose the shot so that the edges of the previous picture in the frame overlap with the next shot.



- Press to exit panorama shooting.
- Panorama shooting is possible for up to 10 pictures. After 10 pictures have been shot, a warning mark () is displayed.

5 SILENT MODE

Setting to turn off operational sounds

OFF /ON

This function allows you to turn off operational sounds that occur during shooting and playback, warning beeps, shutter sounds, etc.

It cannot be set when the mode dial is set to **GUIDE**.



When a still picture is selected

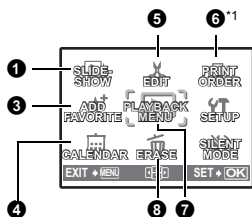
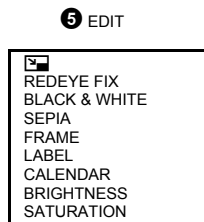

7 PLAYBACK MENU

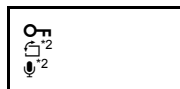

- *1 A card is required.
- *2 This is not displayed when a movie is selected.

When a movie is selected

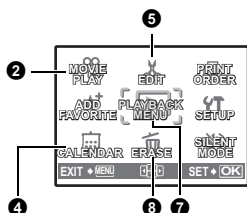

"SETUP menus" (P. 30)

"SILENT MODE Setting to turn off operational sounds" (P. 24)

- The factory default settings are displayed in gray ().

1 SLIDESHOW

Playing back pictures automatically

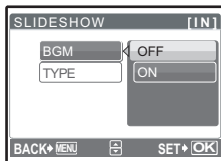

- Set [BGM] to [ON] or [OFF].
- Select the transition effect between pictures from [TYPE].

BGM	ON / OFF
TYPE	NORMAL
	FADER
	SLIDE
	ZOOM

- Only the first frame of each movie is displayed.
- After setting [BGM] and [TYPE], press to start the slideshow.
- Press or **MENU** to cancel the slideshow.

2 MOVIE PLAY

Playing back movies

Select [MOVIE PLAY] from the top menu, and press to play back the movie. You can also playback a movie by selecting a picture with the movie icon () and pressing .



Operations during movie playback



Playing time/Total recording time

: Increases the volume.

: Reduces the volume.

: Each time you press the button, the playback speed changes in the following order: 2x; 20x; and back to 1x.

: Plays the movie in reverse. Each time you press the button, the playback speed changes in the following order: 1x; 2x; 20x; and back to 1x.

- Press to pause the playback.

Operations during pause



: Displays the first frame.

: Displays the last frame.

: Displays the next frame.

: Displays the previous frame.

- To resume the movie, press .
- To cancel the playback of the movie in the middle of it or during pause, press **MENU**.

3 ADD FAVORITE

Adding favorite images

This function registers your favorite still pictures as separate still pictures. You can register up to 9 favorite pictures.

★ Viewing "My Favorite" (P. 12)



- Use the arrow pad to select a picture, and press .

- Registered pictures cannot be erased even by formatting the internal memory.
 - A registered picture can be used as the startup screen picture or menu screen background picture.
- ☞ “PW ON SETUP Setting the startup screen and volume” (P. 31)
 “MENU THEME Setting the menu screen color and background” (P. 31)

! Note

- Registered pictures cannot be edited, printed, copied to a card, transferred to a computer, or played back on a computer.

4 CALENDAR **Playing back the pictures in a calendar format**

This function lets you playback the pictures in a calendar format, organized by the date the images were recorded.

5 EDIT

 **Changing the size of pictures**

640 × 480 / 320 × 240

This changes the image size of a picture and saves it as a new file.

REDEYE FIX **Fixing the red-eye in pictures**

This function corrects the red-eye look that often occurs when taking pictures with a flash and saves the picture as a new file.

BLACK & WHITE **Changing pictures to black and white**

This changes the picture to black and white and saves it as a new file.







SEPIA **Changing pictures to a sepia tone**

This changes the picture to sepia and saves it as a new file.

FRAME **Synthesize the frame and the picture**

This function lets you select a frame, integrate the frame with an image, and save it as a new picture.











- Select a frame with  and press .
- Select the picture to be synthesized with the frame with  and press . (Press   to turn the picture 90 degrees clockwise or 90 degrees counterclockwise.)
- Press the arrow pad and the zoom button to adjust the position and size of the picture, and press .

LABEL **Add a label to your picture**

This function lets you select a label, integrate the label with an image, and save it as a new picture.



- Select the picture with  and press .
- Select the label with  and press . (Press   to turn the label 90 degrees clockwise or 90 degrees counterclockwise.)
- Press the arrow pad and the zoom button to adjust the position and size of the picture, and press .
- Set the color of the label with the arrow pad, and press .

CALENDAR Create a calendar print with a picture

This function lets you select a calendar format, integrate the calendar with a picture, and save it as a new file.

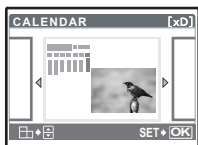

- Select the picture with \triangleleft \triangleright , and press OK .
- Select the calendar with \triangleleft \triangleright , and press OK . (Press \triangle ∇ to turn the picture 90 degrees clockwise or 90 degrees counterclockwise.)
- Set the date of the calendar, and press OK .

BRIGHTNESS Change the brightness of the picture

This function lets you adjust the brightness of a picture and save it as a new picture.



- Select the picture with \triangleleft \triangleright , and press OK .
- Adjust the brightness with \triangle ∇ , and press OK .

SATURATION Change the vividness of the picture

This function lets you adjust the vividness of the picture, and store it as a new picture.

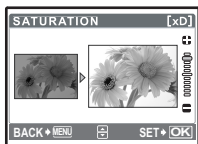

- Select the picture with \triangleleft \triangleright , and press OK .
- Adjust the vividness with \triangle ∇ , and press OK .

INDEX Making an index picture from a movie

This function extracts 9 frames from a movie and saves them as a new picture (INDEX) containing thumbnails of each frame.



- Select a movie with \triangleleft \triangleright , and press OK .
- The [BUSY] bar will be temporarily displayed.

6 PRINT ORDER**Making print reservations (DPOF)**

This function allows you to save printing data (the number of prints and the date and time information) with the pictures stored on the card.

OK "Print settings (DPOF)" (P. 39)

7 PLAYBACK MENU

🔒 Protecting pictures

OFF / ON



Protected pictures cannot be erased with [ERASE], [SEL.IMAGE], or [ALL ERASE], but they are all erased by formatting.

- Select the picture with \triangleleft \triangleright , and protect it by selecting [ON] with \triangle ∇ . You can protect several frames in succession. 🔒 is displayed when the picture is protected.

🔄 Rotating pictures

+90° / 0° / -90°

Pictures taken with the camera held vertically are displayed horizontally during playback. This function lets you rotate such pictures so that they are displayed vertically on the monitor, and the new picture orientations will be saved even after the power is turned off.

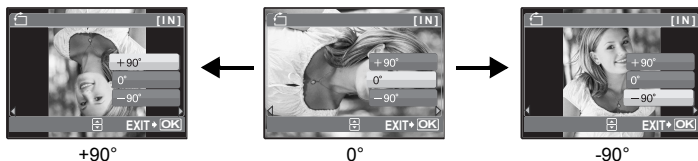

Select a picture with \triangleleft \triangleright , and use \triangle ∇ to select [+90°], [0°], or [-90°]. You can rotate several frames in succession.

🎤 Adding sound to still pictures

YES / NO



Sound is recorded for about 4 seconds.

- Select a picture with \triangleleft \triangleright , and use \triangle ∇ to select [YES] to begin recording.
- The [BUSY] bar will be temporarily displayed.

8 ERASE

Erase selected pictures/Erase all pictures

Protected pictures cannot be erased. Cancel protection before erasing protected pictures. Once erased, pictures cannot be restored. Check each picture before erasing to avoid accidentally erasing pictures you want to keep.

- When erasing the picture in the internal memory, do not insert the card into the camera.
- When erasing the picture from the card, insert a card into the camera in advance.

SEL. IMAGE..... Erase by selecting the single-frame



- Use the arrow pad to select the picture, and press \odot to add \checkmark .
- Press \odot again to cancel the selection.
- When all individual pictures to be erased have been marked, press trash .
- Select [YES], and press \odot .

ALL ERASE..... Erase all the pictures in the internal memory or the card

- Select [YES], and press \odot .

SETUP menus

Shooting mode

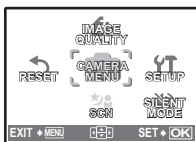

Playback mode

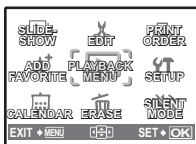

SETUP

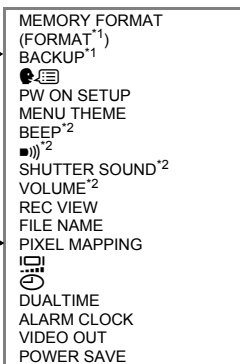

*1 A card is required.

*2 This feature is not available in [SILENT MODE].

speaker "SILENT MODE Setting to turn off operational sounds" (P. 24)

MEMORY FORMAT (FORMAT)..... Formatting the internal memory or card

All existing data, including protected pictures, are erased when the internal memory or card is formatted. Make sure that you save or transfer important data to a computer before formatting the internal memory or card.

- Make sure there is no card inserted in the camera when formatting the internal memory.
- When the internal memory is formatted, the data of the frames and labels downloaded with the provided OLYMPUS Master software will be deleted.
- Be sure that the card is inserted in the camera when formatting the card.
- Before using non-Olympus cards or cards which have been formatted on a computer, you must format them with this camera.

BACKUP Copying pictures in the internal memory to the card

Insert the optional card into the camera. Copying data does not erase the pictures in the internal memory.

- It takes some time to back up data. Check if the battery is not empty before starting the copy, or use the AC adapter.

 **Selecting a display language**

You can select a language for on-screen display. Available languages vary depending on the area where you purchased this camera.

You can add other languages to your camera with the provided OLYMPUS Master software.

PW ON SETUP **Setting the startup screen and volume**

SCREEN OFF (No picture is displayed.) / 1 / 2 / MY FAVORITE

VOLUME OFF (No sound) / LOW / HIGH

- Select [2] and press \triangleright to set a still picture in the internal memory or card as the startup screen.
- Select [MY FAVORITE] and press \triangleright to set a still picture registered in "My Favorite" as the startup screen.
-  "ADD FAVORITE Adding favorite images" (P. 26)
- [VOLUME] cannot be set in the following cases.
 - When [SCREEN] is set to [OFF]
 - When [SILENT MODE] is set to [ON]

MENU THEME **Setting the menu screen color and background**

NORMAL / BLUE / BLACK / PINK / MY FAVORITE

- Select [MY FAVORITE] and press \triangleright to set a still picture registered in "My Favorite" as the background.
-  "ADD FAVORITE Adding favorite images" (P. 26)

BEEP **Adjusting the volume of the beep when buttons are pressed**

OFF (No sound) / LOW / HIGH

 **Adjusting the volume of the camera warning sound**

OFF (No sound) / LOW / HIGH

SHUTTER SOUND **Selecting the sound of the shutter button**

OFF (No sound)

1 LOW / HIGH

2 LOW / HIGH

3 LOW / HIGH

VOLUME **Adjusting the volume during playback**

OFF (No sound) / LOW / HIGH

REC VIEW Viewing pictures immediately after they are taken

OFF	The picture being recorded is not displayed. This is useful when you want to prepare for your next shot while the previous picture is being recorded.
ON	The picture being recorded is displayed. This is useful for making a brief check of the picture you have just taken. You can resume shooting while the picture is still being displayed.

FILE NAME Resetting the file names of pictures

RESET	This method is useful when grouping files on separate cards. The file number and folder number are reset every time a new card is inserted in the camera. The folder number returns to [No. 100] and the file number returns to [No. 0001].
AUTO	This method is useful when you want to manage all your files with sequential numbers. Even if a new card is inserted, the folder number and file number are retained from the previous card. This helps you to manage multiple cards.

File names and their folder names for recorded pictures are automatically generated by the camera. File names and folder names respectively include file numbers (0001 to 9999) and folder names (100 to 999), and are named as follows.

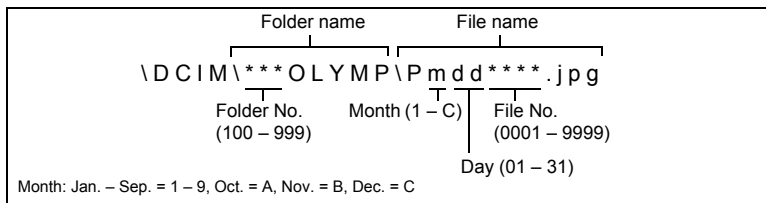

**PIXEL MAPPING** Adjusting the image processing function

The pixel mapping feature allows the camera to check and adjust the CCD and image processing functions. It is not necessary to operate this function frequently. Approximately once a year is recommended. Wait at least one minute after taking or viewing pictures to allow the pixel mapping function to perform properly. If you turn the camera off during pixel mapping, start again.

Select [PIXEL MAPPING]. When [START] is displayed, press .

 Adjusting the brightness of monitor

Press  to confirm your selection.

: Brightens the monitor. : Darkens the monitor.

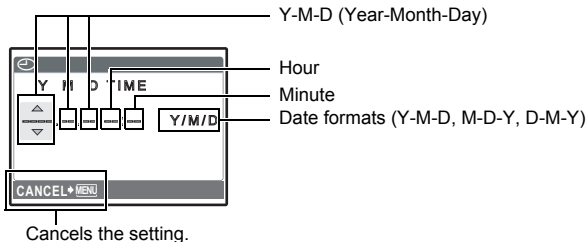

.....Setting the date and time

The date and time is saved with each image, and is used in the file name.



- The first two digits of the year are fixed.
- The time is displayed in the 24-hour format.
- To set the time precisely, with the cursor at either "minute" or [Y/M/D], press  as the time signal strikes 00 seconds.

DUALTIME Setting the date and time for another time zone

OFF	Switches to the date and time set in  . Pictures are recorded with the date and time set in  .
ON	Switches to the date and time set in [DUALTIME]. When setting the dual time, select [ON], and then set the time. Pictures are recorded with the date and time set in [DUALTIME].

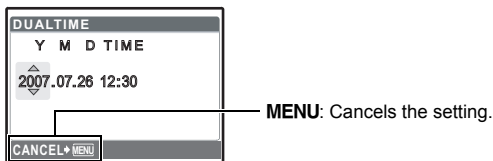

- The date format is the same as that set with .
- The first two digits of the year are fixed.
- The time is displayed in the 24-hour format.

ALARM CLOCKSetting alarms

OFF	No alarm is set or alarm is canceled.
ONE TIME	Alarm is activated once. After the alarm goes off, the setting is canceled.
DAILY	Alarm is activated daily at the set time.

- When  has not been set, [ALARM CLOCK] is not available.
- When [SILENT MODE] is set to [ON], the alarm will not sound.
- When [DUALTIME] is set to [ON], the alarm sounds according to the dual time date and time setting.

Setting an alarm

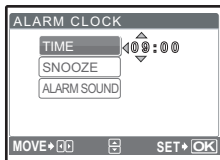

- Select [ONE TIME] or [DAILY], and set the alarm time.
- You can set snooze or alarm sounds and volume.

TIME	Sets the alarm time.	
SNOOZE	OFF	No snooze is set.
	ON	Alarm is activated every 5 minutes, up to 7 times.
ALARM SOUND	1	LOW / MID / HIGH
	2	LOW / MID / HIGH
	3	LOW / MID / HIGH

Operating, shutting off and checking the alarm

- Operating the alarm:
Turn off the camera. The alarm only operates when the camera is off.
- Shutting off the alarm:
While the alarm is sounding, press any button to shut off the alarm and turn off the camera. Note that pressing **POWER** will turn the camera on.
When [SNOOZE] is [OFF], the alarm stops automatically and the camera turns off after 1 minute of no operation.
- Checking the alarm settings:
While the camera is off, press **DISP**  to display the current and alarm set times. Times will be displayed for 3 seconds.

VIDEO OUTPlaying back pictures on a TV

NTSC / PAL

The factory default settings differ according to the region where the camera is sold.

To play back camera images on a TV, set the video output according to your TV's video signal type.

- TV video signal types differ by country/region. Check the video signal type before connecting the camera to the TV.

NTSC: North America, Taiwan, Korea, Japan

PAL: European countries, China

Playing back pictures on a TV

Turn off the camera and the TV before connecting.

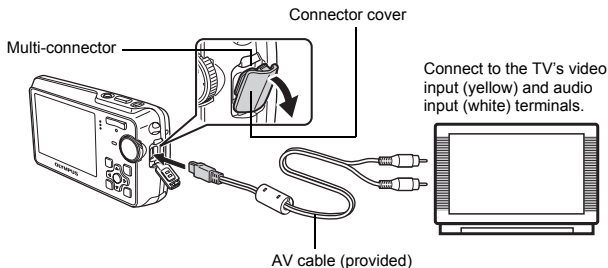

Settings on the camera

Press **POWER** in playback mode to turn the camera on.

- The last picture taken is displayed on the TV. Use the arrow pad to select the picture you want to display.

Settings on the TV

Turn the TV on, and set it to video input mode.

- For details of switching to video input, refer to your TV's instruction manual.
- Images and the information displayed on the screen may become cropped depending on the TV's settings.

POWER SAVE Setting the camera to the power save mode

OFF /ON

When no operation has been performed for approximately 10 seconds while in shooting mode, the monitor automatically shuts off. Pressing the zoom button or other buttons restores the camera from power save mode.

Printing pictures

Direct printing (PictBridge)

Using the direct printing function

By connecting the camera to a PictBridge-compatible printer, you can print out pictures directly. Select the pictures you want to print and the number of prints on the camera's monitor. To find out if your printer is compatible with PictBridge, refer to the printer's instruction manual.

What is PictBridge?

A standard for connecting digital cameras and printers of different makers and printing out pictures directly.

- Available printing modes, paper sizes, etc., vary depending on the printer you use. Refer to the instruction manual for your printer.
- For details of printing paper types, ink cassettes, etc., refer to the printer's instruction manual.

EASY PRINT

[EASY PRINT] can be used to print out the picture displayed on the monitor. The selected picture is printed using the standard settings of your printer. The date and file name are not printed.

STANDARD

All printers that support PictBridge have standard print settings. If [STANDARD] is selected on the settings screens (P. 38), pictures are printed according to these settings. Refer to the printer's instruction manual for its standard settings or contact the printer manufacturer.

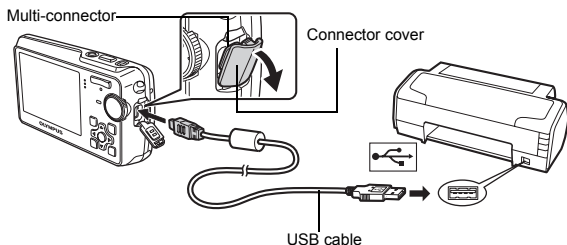

- 1 In playback mode, display the picture you want to print out on the monitor.**
- 2 Turn the printer on and plug the USB cable provided with the camera into the multi-connector of the camera and the printer's USB port.**



- The easy print start screen is displayed.
- For details of how to turn the printer on and the location of the USB port, refer to the printer's instruction manual.

3 Press .

- Printing starts.

- When printing is finished, the picture selection screen is displayed. To print another picture, press   to select a picture, and press .
- When you are finished, disconnect the USB cable from the camera with the picture selection screen displayed.



4 Disconnect the USB cable from the camera.

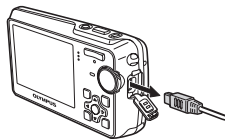

5 Disconnect the USB cable from the printer.

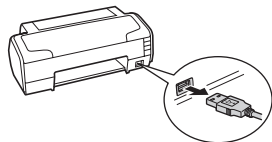

You can use [EASY PRINT] even when the camera is turned off or in shooting mode. With the camera turned off or in shooting mode, connect the USB cable. The selection screen for the USB connection is displayed. Select [EASY PRINT].

 "EASY PRINT" Step 3 (P. 37), "CUSTOM PRINT" Step 2 (P. 37)

Other print modes and print settings (CUSTOM PRINT)

- 1 Follow Steps 1 and 2 on P. 36 to display the screen for Step 3 above, and then press .
- 2 Select [CUSTOM PRINT], and press .

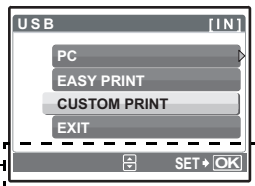

Operation guide 

3 Follow the operation guide to adjust print settings.

Selecting a print mode

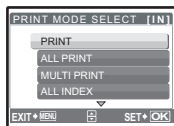

PRINT	Prints the selected picture.
ALL PRINT	Prints all the pictures stored in the internal memory or the card.
MULTI PRINT	Prints one picture in multiple layout format.
ALL INDEX	Prints an index of all the pictures stored in the internal memory or the card.
PRINT ORDER	Prints the pictures according to the print reservation data on the card. If no print reservations have been made, this option is not available. "Print settings (DPOF)" (P. 39)

Setting the print paper



SIZE	Choose from the available paper sizes on your printer.
BORDERLESS	Select with or without borders. In [MULTI PRINT] mode, you cannot print with a border.
OFF ()	The picture is printed inside a blank frame.
ON ()	The picture is printed filling the entire page.
PICS/SHEET	Available in [MULTI PRINT] mode only. The number of prints that can be printed vary depending on the printer.

Note

- If the [PRINT PAPER] screen is not displayed, [SIZE], [BORDERLESS] and [PICS/SHEET] are set to the standard.

Selecting the picture to print



PRINT	Prints one copy of the selected picture. When [SINGLE PRINT] or [MORE] has been selected, a single copy or more copies are printed.
SINGLE PRINT	Makes a print reservation for the displayed picture.
MORE	Sets the number of prints and data to be printed for the displayed picture.

Press to select the picture you want to print. You can also use the zoom button and select a picture from the index display.

Setting the number of prints and data to be printed

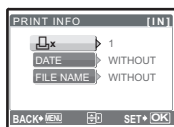

x	Sets the number of prints. You can select up to 10 prints.
DATE ()	If you select [WITH], pictures are printed with the date.
FILE NAME ()	If you select [WITH], pictures are printed with the file name.

4 Select [OK], and press .

- Printing starts.
- When printing is finished, the [PRINT MODE SELECT] screen is displayed.

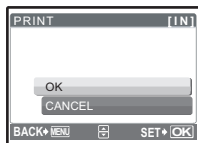

To cancel printing

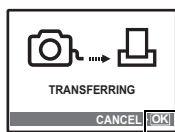

Screen during data transfer

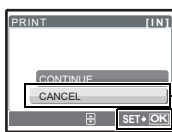

Select [CANCEL], and press .

5 In the [PRINT MODE SELECT] screen, press MENU.

- A message is displayed.

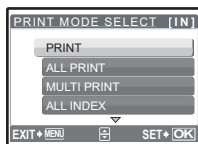

6 Disconnect the USB cable from the camera.

7 Disconnect the USB cable from the printer.

Print settings (DPOF)

How to make print reservations

Print reservation allows you to save printing data (the number of prints and the date and time information) with the pictures stored on the card.

With print reservation, you can print out pictures easily either at home using a personal DPOF-compatible printer or at a photo store that supports DPOF. DPOF is a standard format used to record automatic print information from digital cameras.

Only the images stored on the card can be reserved to print. Insert a card with recorded pictures into the camera before making print reservations.

Pictures with print reservations can be printed using the following procedures.

Printing using a DPOF-compatible photo store.

You can print the pictures using the print reservation data.

Printing using a DPOF-compatible printer.

Printing is possible directly from a card containing print reservation data, without using a computer. For more details, refer to the printer's instruction manual. A PC card adapter may also be necessary.

Note

- DPOF reservations set by another device cannot be changed by this camera. Make changes using the original device. If a card contains DPOF reservations set by another device, entering reservations using this camera may overwrite the previous reservations.
- You can make DPOF print reservations for up to 999 images per card.
- Not all functions may be available on all printers, or at all photo stores.

To use print services without using DPOF

- Pictures stored in the internal memory cannot be printed at a photo store. The pictures need to be copied to a card before taking them.
- "BACKUP Copying pictures in the internal memory to the card" (P. 31)

Single-frame reservation

Follow the operation guide to make a print reservation for a selected picture.

- 1 Press **MENU** in the playback mode and display the top menu.
- 2 Select **[PRINT ORDER]** ▶ **[↓]**, and press **OK/FUNC**.

Operation guide

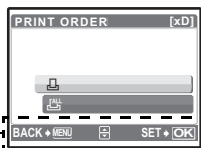

- 3 Press **◀▶** to select the frames for print reservations, and then press **△▽** to set the number of prints.

- You cannot make print reservations for pictures with **Ⓜ**.
- Repeat Step 3 to make print reservations for other pictures.

- 4 When you finish making print reservations, press **OK/FUNC**.



- 5 Select the date and time print setting, and press **OK/FUNC**.

NO The pictures are printed without the date and time.

DATE The selected pictures are printed with the shooting date.

TIME The selected pictures are printed with the shooting time.

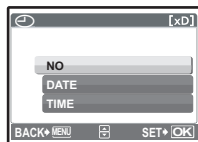

- 6 Select **[SET]**, and press **OK/FUNC**.

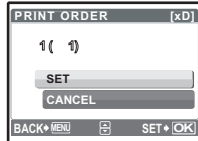

All-frame reservation

Reserves all the pictures stored on the card. The number of prints is set at one print per picture.

- 1 Press **MENU** in the playback mode and display the top menu.
- 2 Select **[PRINT ORDER]** ▶ **[ALL]**, and press **OK/FUNC**.
- 3 Select the date and time setting, and press **OK/FUNC**.
NO The pictures are printed without the date and time.
DATE All pictures are printed with the shooting date.
TIME All pictures are printed with the shooting time.
- 4 Select **[SET]**, and press **OK/FUNC**.

Resetting print reservation data

You can reset all the print reservation data or just for selected pictures.

- 1 Select top menu ▶ **[PRINT ORDER]**, and press **OK/FUNC**.

To reset the print reservation data for all the pictures

- 2 Select **[ALL]** or **[ALL]**, and press **OK/FUNC**.
- 3 Select **[RESET]**, and press **OK/FUNC**.

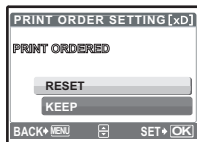

To reset the print reservation data for a selected picture

- 2 Select **[ALL]**, and press **OK/FUNC**.
- 3 Select **[KEEP]**, and press **OK/FUNC**.
- 4 Press **◀▶** to select the picture with the print reservations you want to cancel, and press **▽** to decrease the number of prints to 0.
 - Repeat Step 4 to cancel print reservations for other pictures.
- 5 When you are finished canceling print reservations, press **OK/FUNC**.
- 6 Select the date and time setting, and press **OK/FUNC**.
 - The setting is applied to the remaining pictures with print reservations.
- 7 Select **[SET]**, and press **OK/FUNC**.

Using OLYMPUS Master

Overview

Using the USB cable provided with your camera, you can connect the camera and computer and download (transfer) the images to your computer using the OLYMPUS Master software, also provided with the camera.

Prepare the following items before starting.



OLYMPUS Master 2
CD-ROM



USB cable



Computer equipped with a USB port

Install the OLYMPUS Master software P. 43

Connect the camera to the computer using the USB cable P. 45

Start up the OLYMPUS Master software P. 46

Download image files to the computer P. 46

Disconnect the camera from the computer P. 47

Using OLYMPUS Master

What is OLYMPUS Master?

OLYMPUS Master is a software application for managing your digital images on your computer. Installing it on your computer lets you do the following:

- **Download images from the camera or other media**
- **View images and movies**
 - You can run a slideshow and play back sound.
- **Manage images**
 - Manage images in an album or folder.
 - Downloaded images are automatically sorted by date, allowing you to search for images quickly.
- **Edit images**
 - You can rotate images, trim them and change the size.
- **Edit images with the filter and correction functions**

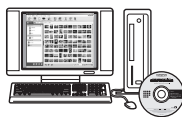

- **Print images**
 - You can easily print images.
- **Make panoramic images**
 - You can make panoramic images using pictures taken in panorama mode.
- **Update the version of your camera's firmware.**

For details of other functions and operations, refer to the "Help" guide in the OLYMPUS Master reference manual.

Install the OLYMPUS Master software

Before installing the OLYMPUS Master software, please confirm that your computer is compatible with the following system requirements.

For newer operating systems, please refer to the Olympus web site as shown on the back cover of this manual.

Operating environment

Windows

OS	Windows 2000 Professional/XP Home Edition/XP Professional/Vista
CPU	Pentium III 500 MHz or later
RAM	256 MB or more
Hard disk capacity	500 MB or more
Monitor	1,024 × 768 pixels or more 65,536 colors or more (16.77 million colors or more recommended)
Other	USB port or IEEE 1394 port Internet Explorer 6 or later QuickTime 7 or later recommended DirectX 9 or later recommended

Note

- **Windows 98/98SE/Me are not supported.**
- Use a computer with a pre-installed operating system. Operations are not guaranteed on home-built computers or computers with an updated operating system.
- Operations are not guaranteed when using an added USB port or IEEE 1394 port.
- To install the software, you must log on as a user with administrators' privileges.

Macintosh

OS	Mac OS X v10.3 or later
CPU	Power PC G3 500 MHz or later Intel Core Solo/Duo 1.5 GHz or later
RAM	256 MB or more
Hard disk capacity	500 MB or more
Monitor	1,024 × 768 pixels or more 32,000 colors or more (16.77 million colors or more recommended)
Other	USB port or IEEE 1394 port (FireWire) Safari 1.0 or later (1.3 or later recommended) QuickTime 6 or later

Note

- **Mac versions earlier than OS X 10.3 are not supported.**
- Operations are not guaranteed when using an added USB or IEEE 1394 (FireWire) port.
- To install the software, you must log on as a user with administrators' privileges.
- Be sure to remove the media (drag & drop onto the trash icon) before performing the following operations. Failure to do so could result in unstable computer operation and the need to reboot.
 - Disconnect the cable connecting the camera to the computer
 - Turn off the camera
 - Open the camera's battery/card compartment cover

Windows

1 Insert the CD-ROM into the CD-ROM drive.

- The OLYMPUS Master setup screen is displayed.
- If the screen is not displayed, double-click the "My Computer" icon and click the CD-ROM icon.

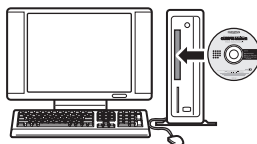

2 Select the display language and click the "OLYMPUS Master 2" button.

- When the component installation screen is displayed, click "OK".

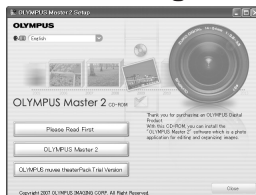

3 Click "Next" and follow the on-screen instructions.

- When the OLYMPUS Master licensing agreement is displayed, read the agreement and click "Yes" to proceed with the installation.



4 When the user information screen is displayed, enter your "Name", select your "Region" and click "Next".

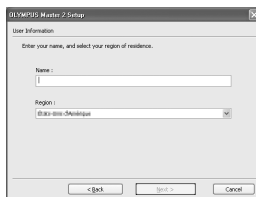

5 When the setup type selection screen is displayed, click "Install".

- To select the components to install, select "Custom".

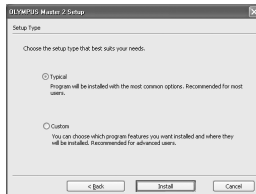

- The installation begins. The screen confirming that setup is completed is displayed. Click "Close".
- Next, the screen confirming whether to install OLYMPUS muvee theaterPack Trial Version is displayed. To install this software, click "Install".



Macintosh

1 Insert the CD-ROM into the CD-ROM drive.

- The CD-ROM window is displayed.
- If the CD-ROM window is not displayed, double-click the CD-ROM icon on the desktop.



2 Double-click the "Setup" icon on the desktop.

- The OLYMPUS Master installation screen is displayed.
- Follow the on-screen instructions.
- When the OLYMPUS Master licensing agreement is displayed, read the agreement and click "Continue" and then "Continue" to proceed with the installation.
- The screen confirming that installation is completed is displayed.
- You must restart your computer before using OLYMPUS Master.



Connecting the camera to a computer

1 Make sure the camera is turned off.

- The monitor is off.
- The lens is retracted.

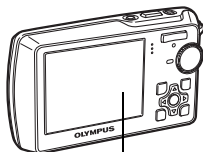

2 Connect the multi-connector on the camera to the USB port on the computer using the provided USB cable.

- Refer to your computer's instruction manual to locate the position of the USB port.
- The camera turns on automatically.
- The monitor turns on and the selection screen for the USB connection is displayed.

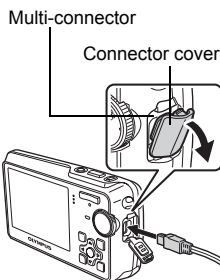

3 Select [PC], and press .

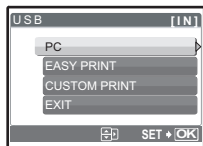

4 The camera is recognized by the computer.

• Windows

When you connect the camera to your computer for the first time, the computer attempts to recognize the camera. Click "OK" to exit the message that is displayed. The camera is recognized as a "Removable Disk".

• Macintosh

The iPhoto program is the default application for managing digital images. When you connect your digital camera for the first time, the iPhoto application starts automatically, so close this application and start OLYMPUS Master.

! Note

- The camera functions are disabled while the camera is connected to a computer.
- Connecting the camera to a computer via a USB hub may cause unstable operation. In this case, do not use a hub, but connect the camera directly to the computer.
- Images cannot be transferred to your computer with OLYMPUS Master if [PC] is selected in Step 3, [D] is pressed and [MTP] is selected.

Start up the OLYMPUS Master software

Windows

1 Double-click the "OLYMPUS Master 2" icon  on the desktop.

Macintosh

1 Double-click the "OLYMPUS Master 2" icon  in the "OLYMPUS Master 2" folder.

- The browse window is displayed.
- When OLYMPUS Master is started up for the first time after installation, the OLYMPUS Master initial setting screen and user registration screen are displayed before the browse window. Follow the on-screen instructions.

To exit OLYMPUS Master

1 Click "Exit"  on any window.

- OLYMPUS Master is exited.

Displaying camera images on a computer

Downloading and saving images

1 Click "Transfer Images"  on the browse window, and then click "From Camera" .

- The window for selecting the pictures you want to transfer from the camera is displayed. All the images in the camera are displayed.

2 Select "New Album" and enter an album name.

3 Select the image files and click "Transfer Images".

- A window indicating that the download is complete is displayed.

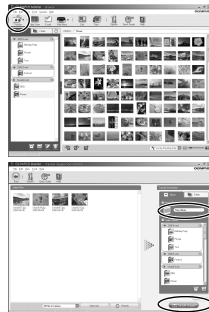

4 Click "Browse images now".

- The downloaded images are displayed in the browse window.



To disconnect the camera

1 Make sure that the card access lamp has stopped blinking.

Card access lamp

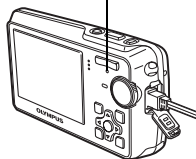

2 Make the following preparations for disconnecting the USB cable.

Windows

- 1 Click the "Unplug or Eject Hardware" icon  in the system tray.
- 2 Click the message that is displayed.
- 3 When a message is displayed saying that the hardware can be ejected safely, click "OK".

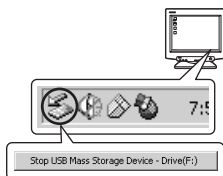

Macintosh

- 1 The trash icon changes to the eject icon when the "Untitled" or "NO_NAME" icon on the desktop is dragged. Drag and drop it on the eject icon.



3 Disconnect the USB cable from the camera.

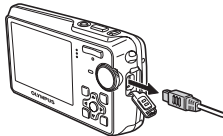

Note

- Windows: When you click "Unplug or Eject Hardware", a warning message may be displayed. Make sure that image data is not being downloaded from the camera and that all applications are closed. Click the "Unplug or Eject Hardware" icon again and disconnect the cable.

Viewing still pictures and movies

1 Click the “Album” tab on the browse window and select the album that you want to view.

- The selected album image is displayed in the thumbnail area.

2 Double-click the still picture thumbnail that you want to view.

- OLYMPUS Master switches to the image edit window and the picture is enlarged.
- Click “Back”  to return to the browse window.



To view a movie

1 Double-click the movie thumbnail that you want to see in the browse window.

- OLYMPUS Master switches to the edit window and the first frame of the movie is displayed.

2 To play back the movie, click “Play” at the bottom of the screen.



To download and save images to a computer without using OLYMPUS Master

This camera is compatible with USB mass storage. You can connect the camera to your computer using the USB cable provided with the camera to download and save images without using OLYMPUS Master. The following environment is required to use the USB cable to connect the camera to your computer.

Windows: Windows 98SE/Me/2000 Professional/XP Home Edition/XP Professional/Vista



Macintosh: Mac OS 9.0 to 9.2/X

Note

- If your computer is running Windows 98SE, you will need to install the USB driver. Before connecting the camera to your computer with the USB cable, double-click the files from the following folders on the provided OLYMPUS Master CD-ROM.
(Drive name): \win98usb\INSTALL.EXE
- If your computer is running Windows Vista, you can select [PC] in Step 3 on P. 45, press , and select [MTP] to use Windows Photo Gallery.
- Data transfer is not guaranteed in the following environments, even if your computer is equipped with a USB port.
 - Windows 95/98/NT 4.0
 - Windows 98SE upgrades from Windows 95/98
 - Mac OS 8.6 or earlier
 - Computers with a USB port added by means of an extension card, etc.
 - Computers without a factory-installed OS and home-built computers

To increase the number of languages

Please take care that your battery is fully charged!

- 1 Make sure that your computer is connected to the Internet.**
- 2 Plug the USB cable into the USB port on the computer.**
- 3 Plug the other end of the USB cable into the camera's USB connector.**
 - The camera turns on automatically.
 - The monitor turns on and the selection screen for the USB connection is displayed.
- 4 Select [PC], and press .**
- 5 In the browse window, select "Camera", then "Update Camera/Add Display Language".**
 - The confirmation window for updating is displayed.
- 6 Click "OK".**
 - The updating the camera window is displayed.
- 7 Click "Add Language" in the updating camera display.**
 - The "Add Display Language of Camera" window is displayed.
- 8 Click  and select a language.**
- 9 Click "Add".**
 - The new language is downloaded to your camera.
Please do not remove any cable or the battery while the camera is processing.
- 10 After the download procedure the camera display will show "OK". You can remove the cables and turn power off. After restarting the camera you will be able to choose the new language from [SET UP].**

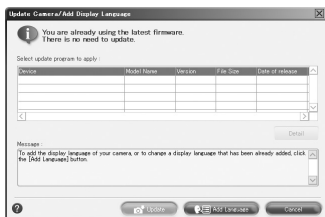

Getting to know your camera better

Shooting tips and information

Tips before you start taking pictures

The camera does not turn on even when a battery is loaded

The battery is not fully charged

- Charge the battery with the charger.

The battery is temporarily unable to function because of the cold

- Battery performance declines in low temperatures, and the charge may not be sufficient to turn on the camera. Remove the battery and warm it by putting it in your pocket for a while.

No picture is taken when the shutter button is pressed

The camera is in sleep mode

- To save battery power, the camera automatically goes into sleep mode and the monitor turns off if there is no operation when the camera is turned on (when the lens is extended and the monitor is on). No picture is taken even if the shutter button is fully pressed in this mode. Operate the zoom button or other buttons to restore the camera from sleep mode before taking a picture. If the camera is left for 15 minutes, it automatically turns off (the lens retracts and the monitor turns off). Press **POWER** to turn the camera on.

The mode dial is set to or

- This is the playback mode for displaying pictures on the monitor. Set the mode dial to a shooting mode.

The mode dial is in the position of **GUIDE**

- No pictures can be taken when the shooting guide is being displayed. Take pictures after setting target terms by following the shooting guide or set it to the setting other than **GUIDE** in shooting mode.

The flash is charging

- Wait until the  (flash charge) mark stops blinking before taking the picture.

The memory gauge is full

- No pictures can be taken when the memory gauge is full. Wait until there is space in the memory gauge.

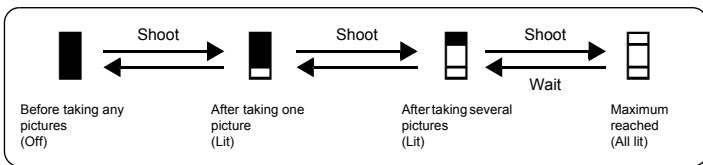

The date and time have not been set

The camera has been used in the same conditions from the time of purchase

- No date and time have been set for the camera at the time of purchase. Set the date and time before using the camera.



- "Turn the camera on" (P. 5)
-  "Setting the date and time" (P. 33)

The battery has been pulled out of the camera

- The date and time settings will be returned to the factory default settings if the camera is left without battery for approximately 1 day. Also, the date and time setting will be canceled earlier than this if the battery has been in the camera for a short period of time. Before taking important pictures, check that the date and time settings are correct.

Focusing on the subject

There are several ways to focus, depending on the subject.

When the subject is not in the center of the frame

- Place the subject in the center of the frame, lock the focus on the subject, and then recompose your picture.
- Set [AF MODE] to [iESP].

 "AF MODE Changing the focusing area" (P. 23)

The subject is moving quickly

- Focus the camera on a point roughly the same distance away as the subject you want to shoot and lock the focus (by pressing the shutter button halfway). Then recompose your picture and press the shutter button completely as the subject enters the frame.

Subjects that are difficult to focus on

- Under certain types of conditions, it is difficult to focus using auto focus. The green lamp on the monitor lights, allowing you to check if the focus is locked.

The green lamp blinks.
The subject cannot be brought into focus.



Subject with low contrast

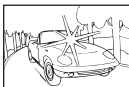

Subject with an extremely bright area in the center of the frame

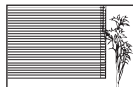

Subject without vertical lines

The green lamp lights,
but the subject cannot be brought into focus.



Subjects at different distances

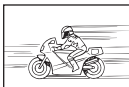

Fast-moving subject



The subject is not in the center of the frame

In these cases, focus (focus lock) on an object with high contrast at the same distance as the intended subject, recompose your shot and then take the picture. If the subject has no vertical lines, hold the camera vertically and focus the camera using the focus lock function by pressing the shutter button halfway, and then return the camera to the horizontal position while keeping the button pressed halfway and take the picture.

Prevent blur by using image stabilization

Be sure to hold the camera firmly with both hands and press the shutter button slowly so as to avoid moving the camera. You can also reduce the blurring by pressing  before shooting the picture.

 "Image stabilization button Shooting pictures using the image stabilizer" (P. 15)

The digital images are not stabilized when:

- images are shot at a high-magnification zoom setting, i.e. using both optical zoom and digital zoom functions,
- the object is dark and the shutter speed is slow, or
- scene modes where the flash is turned off and/or the shutter speed is slow.

Taking stabilized pictures without the flash

The flash is activated automatically when there is insufficient light, or when the camera is shaken. To take pictures with no flash in dark places, set the flash mode to  and set as follows:

Increase the [ISO] setting

-  "ISO Changing the ISO sensitivity" (P. 22)

The picture is too grainy

There are several factors that can cause the picture to appear grainy.

Using the digital zoom to take close-up pictures

- With the digital zoom, part of the image is cropped and enlarged. The greater the magnification, the grainier the picture appears.
-  "DIGITAL ZOOM Zooming in on your subject" (P. 23)







Increasing the ISO sensitivity

- When you increase the [ISO] setting, "noise", which appears as spots of unwanted color or unevenness in the color, can be introduced and give the picture a grainy appearance. This camera is equipped with a function to allow shooting at high sensitivity while suppressing noise; however, increasing the ISO sensitivity can result in some noise, depending on the shooting conditions.
-  "ISO Changing the ISO sensitivity" (P. 22)









Taking pictures with the correct color

- The reason why there are sometimes differences between the actual colors and the colors recorded in a picture is related to the light source illuminating the subject. [WB] is the function that helps the camera determine the true colors. Normally, the [AUTO] setting provides the optimal white balance, but depending on the subject, results may be better if you manually adjust the [WB] setting.
 - When the subject is in the shade on a sunny day
 - When the subject is illuminated by both natural light and indoor lighting, such as when near a window
 - When there is no white in the center of the frame
-  "WB Adjusting the color of a picture" (P. 22)

Taking pictures of a white beach or snow scene

- Take pictures with  in **SCN** mode. Suitable for taking pictures on a sunny day at the beach or in the snow.
-  "**SCN** (Scene) Selecting a scene mode according to the shooting situation" (P. 21)
- Often, bright subjects (such as snow) turn out darker than their natural colors. Use   to adjust toward [+] to make these subjects closer to their true shades. Conversely, when you are shooting dark subjects, it can be effective to adjust toward the [-]. Sometimes, using the flash may not produce the brightness (exposure) that was intended.
-  "  button Changing picture brightness" (P. 14)

Taking pictures of a subject against backlight

- With [ESP/] set to , the picture can be taken based on the brightness at the center of the monitor without being affected by the light in the background.
-  "ESP/ Changing the area for measuring the brightness of a subject" (P. 23)
- Set the flash to  to activate fill-in-flash. You can shoot a subject against backlight without the face of the subject appearing dark.  is effective for shooting against backlight and under fluorescent and other artificial lighting.
-  " button Flash shooting" (P. 15)

Additional shooting tips and information

Increasing the number of pictures that can be taken

There are two ways to record the pictures you take with this camera.

Recording pictures to the internal memory

- Pictures are recorded to the internal memory, and when the number of storable still pictures reaches 0, you must connect the camera to a computer to download the pictures, and then erase the pictures from the internal memory.

Using a card (optional)

- Pictures are recorded to the card when inserted in the camera. When the card is full, you download the pictures to a computer, and then either erase the pictures from the card or use a new card.
- Pictures are not recorded to the internal memory when a card is inserted in the camera. Pictures in the internal memory can be copied to the card using the [BACKUP] function.

 "BACKUP Copying pictures in the internal memory to the card" (P. 31)
"The card" (P. 61)

Number of storable still pictures and recording length of movies

Still pictures

Image quality	Image size	Number of storable still pictures			
		Internal memory		Using a 512 MB card	
		With sound	Without sound	With sound	Without sound
SHQ	3072 × 2304	4	4	145	147
HQ	3072 × 2304	8	8	287	293
SQ1	2560 × 1920	12	12	409	420
	2304 × 1728	14	15	499	515
	2048 × 1536	18	19	626	652
SQ2	1600 × 1200	22	23	743	779
	1280 × 960	33	36	1141	1229
	1024 × 768	49	55	1681	1879
	640 × 480	75	90	2458	2905
16:9	1920 × 1080	27	28	913	968

Movie

Image quality	Image size	Recording length	
		Internal memory	Using a 512 MB card
SHQ	640 × 480 (15 frames/sec.)	16 sec.	9 min. 18 sec.
HQ	320 × 240 (15 frames/sec.)	38 sec.	21 min. 47 sec.
SQ	160 × 120 (15 frames/sec.)	1 min. 35 sec.	53 min. 45 sec.

Using a new card

- If you use a non-Olympus card or a card used for another application, such as for a computer, the message [CARD ERROR] is displayed. To use this card with this camera, use the [FORMAT] function to format the card.

 "MEMORY FORMAT (FORMAT) Formatting the internal memory or card" (P. 30)

Lamp indicators

This camera uses several lamps to indicate the camera status.

Lamp	Status
Self-timer lamp	The lamp lights for approximately 10 seconds, blinks for approximately 2 seconds, and then the picture is taken.
Card access lamp	Blinking: An image or movie is being recorded or downloaded (when connected to a computer). <ul style="list-style-type: none"> Do not do any of the following while the card access lamp is blinking. Doing so may prevent the image data from being saved and render the internal memory or card unusable. <ul style="list-style-type: none"> Open the battery/card compartment cover. Remove the battery. Connect or disconnect the AC adapter.
Green lamp of the monitor	Lit: The focus and exposure are locked. Blinking: The focus and exposure are not locked. <ul style="list-style-type: none"> Release your finger from the shutter button, re-position the AF target mark on the subject and press the shutter button halfway again.

Extending the useful life of the battery

- Performing any of the following operations when not actually taking pictures can deplete the battery power.
 - Repeatedly pressing the shutter button halfway
 - Repeatedly using the zoom
- To minimize the battery consumption, set [POWER SAVE] to [ON] and turn off the camera whenever it is not in use.

 "POWER SAVE Setting the camera to the power save mode" (P. 35)

Functions that cannot be selected from menus

- Some items may not be selectable from the menus when using the arrow pad.
 - Items that cannot be set with the current shooting mode
 - Items that cannot be set because of an item that has already been set: [S/M], Flash Mode, etc.
 - Items used to edit pictures taken with another camera.
- Some functions cannot be used when there is no card in the camera. [PANORAMA], [PRINT ORDER], [FORMAT], [BACKUP]

Selecting the appropriate image quality

A record mode expresses a combination of desired image size and compression level. Use the following examples to help determine the optimal record mode when shooting.

To make high quality prints on full-size paper such as A3/To edit and process images on a computer

- [SHQ] or [HQ]

To print A3/A4-size images

- [SQ1]

To print postcard-size images/To send as an e-mail attachment or post on a web site

- [SQ2]

To express the broadness of a subject such as landscapes/To view pictures on a wide-screen television

- [16:9]

 "IMAGE QUALITY Changing the image quality" (P. 20)

Restoring default settings

- This camera retains the settings (except for **SCN**) even after the power is turned off. To return the settings to default settings, execute [RESET].

 "RESET Restoring default settings" (P. 21)

Confirming the exposure when the monitor is difficult to see outdoors

The monitor may be difficult to see and the exposure difficult to confirm when shooting outdoors.



Press repeatedly to display the histogram

- Set the exposure so that the graph is concentrated on the outer edges and the graph is balanced on both sides.

How to read the histogram

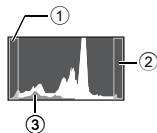
- ① If the peak fills too much of the frame, the image will appear mostly black.
- ② If the peak fills too much of the frame, the image will appear mostly white.
- ③ The part indicated in green in the histogram shows the luminance distribution within the AF target mark.



  button Changing the information on display/Display the menu guide/Checking the time" (P. 17)

Playback help and troubleshooting tips

The red-eye cannot be fixed

- Depending on the picture, the red-eye may not be fixed. Also, parts except the eye may be fixed.



Playback tips

Playing back the picture in the internal memory

- When a card has been inserted in the camera, the picture in the internal memory cannot be played back. Pull out the card before operating the camera.

Understanding the settings and other information of pictures taken

- Play back a picture, and press . Press  repeatedly to change the amount of information displayed.

  button Changing the information on display/Display the menu guide/Checking the time" (P. 17)

Quickly displaying a desired picture

- Press W on the zoom button to view the pictures as thumbnails (index display) or in a calendar format (calendar display).

 "Zoom button Zooming while shooting/close-up playback" (P. 13)

Erasing sound recorded to still pictures

- Once sound is added to a picture, it is not possible to erase the sound. In this case, make a re-recording with silence. Sound recording is not possible if there is insufficient space in the internal memory or on the card.

 "Adding sound to still pictures" (P. 29)

Viewing the entire picture on a computer screen

The size of the picture displayed on a computer screen changes depending on the computer settings. When the monitor setting is 1,024 × 768 and you are using Internet Explorer to view a picture with an image size of 2,048 × 1,536 at 100%, the entire picture cannot be viewed without scrolling. There are several ways you can view the entire picture on the computer screen.















View the picture using image browsing software



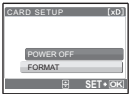

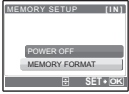
- Install the OLYMPUS Master software from the provided CD-ROM.

Change the monitor setting

- The icons on the computer desktop may be rearranged. For details of changing the settings on your computer, refer to the computer's instruction manual.

When you get an error message on the camera...

Monitor indication	Possible cause	Corrective action
 CARD ERROR	There is a problem with the card.	This card cannot be used. Insert a new card.
 WRITE-PROTECT	Writing to the card is prohibited.	The recorded image has been protected (read-only) on a computer. Download the image to a computer and cancel the read-only setting.
 MEMORY FULL	The internal memory has no available memory and cannot store any new data.	Insert a card or erase unwanted data. Before erasing, back up the data of important pictures using the card, or download such pictures to a computer.
 CARD FULL	The card has no available memory and cannot store any new data.	Replace the card or erase unwanted data. Before erasing, download important pictures to a computer.
 NO PICTURE	There are no pictures in the internal memory or on the card.	The internal memory or the card contains no pictures. Record pictures.
 PICTURE ERROR	There is a problem with the selected picture and it cannot be played back on this camera.	Use image processing software to view the picture on a computer. If that cannot be done, the image file is damaged.
 THE IMAGE CANNOT BE EDITED	Pictures taken by other cameras, taken in [16:9], or previously edited or corrected pictures cannot be edited or fixed.	Use image processing software to edit the pictures.
 CARD-COVER OPEN	The battery/card compartment cover is open.	Close the battery/card compartment cover.
 BATTERY EMPTY	The battery is empty.	Charge the battery.
	This card cannot be used in this camera. Or, the card is not formatted.	Format the card or replace. • Select [POWER OFF] and press  . Insert a new card. • Select [FORMAT] ► [YES] and press  . All data on the card is erased.
	There is an error in the internal memory.	Select [MEMORY FORMAT] ► [YES] and press  . All data in the internal memory is erased.
 NO CONNECTION	The camera is not connected to the computer or printer correctly.	Disconnect the camera and connect it again correctly.
 NO PAPER	There is no paper in the printer.	Load some paper in the printer.

Monitor indication	Possible cause	Corrective action
 NO INK	The printer has run out of ink.	Replace the ink cartridge in the printer.
 JAMMED	The paper is jammed.	Remove the jammed paper.
SETTINGS CHANGED	The printer's paper tray has been removed or the printer has been operated while changing settings on the camera.	Do not operate the printer while changing settings on the camera.
 PRINT ERROR	There is a problem with the printer and/or camera.	Turn off the camera and printer. Check the printer and remedy any problems before turning the power on again.
 CANNOT PRINT	Pictures recorded on other cameras may not be printed on this camera.	Use a computer to print.









Functions available in shooting modes and scene modes

Some functions cannot be set in certain shooting modes. For more details, refer to the table below.

 indicates a restriction to the respective function of each **SCN** mode.

 "Functions with restrictions in shooting scenes" (P. 59)

Functions available in shooting modes

Function	Shooting mode			SCN	
		P	AUTO		
		✓	✓	✓	✓
		✓	✓		—
		✓	✓		✓
		✓	✓		✓
Image stabilizer		✓	✓	✓	—
Optical zoom		✓	✓		✓*
WB		✓	—	✓	✓
ISO		✓	—		—
DRIVE		✓	—		—
ESP/ 		✓	—		✓
IMAGE QUALITY		✓	✓		✓
SILENT MODE		✓	✓	✓	✓
DIGITAL ZOOM		✓	—		✓
AF MODE		✓	—		—
		✓	—		—
PANORAMA		✓	—		—

* The optical zoom is not available during movie recording. Set [DIGITAL ZOOM] to [ON] to enable the zoom function for shooting.

Functions with restrictions in shooting scenes

Function	SCN																
	✓	✓	✓	—	✓	—	—	—	—	—	—	—	—	—	✓ ^{*1}	✓	✓
	✓	✓ ^{*2}	✓ ^{*2}	✓	✓ ^{*2}	✓ ^{*2}	—	✓	—	✓	✓	✓	✓	✓	✓	—	—
	✓	✓	✓	✓	✓	✓	✓	✓	✓	✓	—	—	—	—	— ^{*3}	—	—
Optical zoom	✓	✓	✓	✓	—	✓	✓	✓	✓	✓	✓	✓	✓	✓	✓	✓	—
ISO	—	—	—	—	—	—	—	—	—	—	—	—	—	—	—	✓	✓
DRIVE	✓ ^{*4}	✓ ^{*4}	—	—	✓ ^{*4}	—	—	✓ ^{*4}	—	—	—	—	—	—	—	✓ ^{*4}	✓ ^{*4}
ESP/	✓	✓	✓	✓	—	✓	✓	✓	✓	✓	✓	✓	✓	✓	✓	✓	✓
IMAGE QUALITY	✓	✓	✓	✓ ^{*5}	✓	✓	✓	✓	✓	— ^{*6}	✓ ^{*5}	✓	✓	✓	✓	✓	✓
DIGITAL ZOOM	✓	✓	✓	—	—	✓	✓	✓	✓	✓	—	✓	✓	✓	✓	✓	—
AF MODE	✓	✓	✓	✓	—	✓	—	✓	✓	✓	✓	✓	✓	✓	✓	✓	—
	✓	✓	✓	✓	✓	✓	✓	✓	✓	✓	—	—	—	—	—	✓	✓
PANORAMA	✓	✓	✓	✓	—	✓	✓	✓	✓	—	—	—	—	—	—	✓	✓

*1 Excluding [].

*2 [] is not available.

*3 AF lock is on.

*4 [] cannot be selected.

*5 Only a image quality at [2048 × 1536] or lower is available.

*6 The image quality is fixed to [640 × 480].

Camera care

Cleaning the camera

Exterior:

- Wipe gently with a soft cloth. If the camera is very dirty, soak the cloth in mild soapy water and wring well. Wipe the camera with the damp cloth and then dry it with a dry cloth. If you have used the camera at the beach, use a cloth soaked in clean water and wrung well.

Monitor:

- Wipe gently with a soft cloth.

Lens:

- Blow dust off the lens with a commercial blower, then wipe gently with a lens cleaner.

Battery/Charger:

- Wipe gently with a soft, dry cloth.



Note

- Do not use strong solvents such as benzene or alcohol, or chemically treated cloth.
- Mold may form on the lens surface if the lens is left dirty.

Storage

- When storing the camera for extended periods, remove the battery, AC adapter and card, and keep in a cool, dry place that is well ventilated.
- Periodically insert the battery and test the camera functions.



Note

- Avoid leaving the camera in places where chemical products are handled since this may result in corrosion.

Battery and charger

- This camera uses one Olympus lithium ion battery (LI-42B or LI-40B). No other type of batteries can be used.
- Power consumption by the camera varies depending on which functions are used.
- During the conditions described below, power is consumed continuously and the battery becomes exhausted quickly.
 - The zoom is used repeatedly.
 - The shutter button is pressed halfway repeatedly in shooting mode, activating the auto focus.
 - A picture is displayed on the monitor for an extended period of time.
 - The camera is connected to a computer or printer.
- Using an exhausted battery may cause the camera to turn off without displaying the battery level warning.
- The rechargeable battery is not fully charged at the time of purchase. Charge the battery fully with the LI-40C charger before use.
- The provided rechargeable battery usually takes approximately 5 hours to charge.
- This camera uses a charger specified by Olympus. Do not use any other type of charger.
- The charger can be used within the range of AC 100 V to AC 240 V (50/60 Hz). When using the charger abroad, you may need a plug adapter to convert the plug to the shape of the AC wall outlet. For details, ask at your local electrical shop or travel agent.
- Do not use travel voltage converters as they could damage your charger.

Useful use of the accessories

The card

Pictures can be recorded on the optional card.

The internal memory and card are the camera's media for recording pictures, similar to film in a film camera. Pictures recorded to the internal memory or card can be easily erased on the camera or processed using a computer.

Unlike portable storage media, the internal memory cannot be removed or exchanged.

The number of recordable pictures can be increased by using a card with a larger capacity.

① Index area

You can use this space to write the contents of the card.

② Contact area

The part where the data transferred from the camera enters the card.

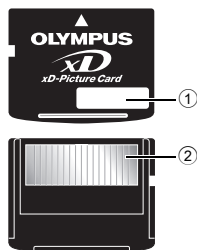

Compatible cards

xD-Picture Card 16MB – 2GB (TypeH/M, Standard)

Using the internal memory or card

You can confirm on the monitor whether the internal memory or card is being used during shooting and playback operations.

Shooting mode



Playback mode



Memory indicator

[IN]: When using the internal memory

[xD]: When using a card

Inserting and removing the card

- 1 Turn off the camera.
- 2 Open the battery/card compartment cover.

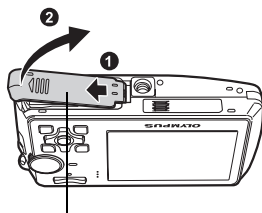

Battery/card compartment cover

Inserting the card

- 3 Orient the card as shown, and insert it into the card slot as shown in the illustration.

- Insert the card straight in.
- Insert the card until it clicks into place.

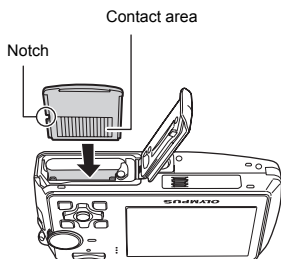

Removing the card

- 4 Push the card all the way in and release slowly.

- The card protrudes slightly and stops.
- Grasp the card and remove.

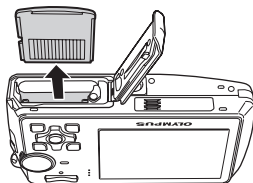
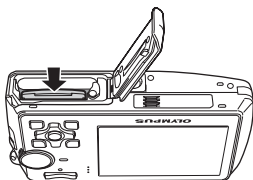

- 5 Close the battery/card compartment cover.

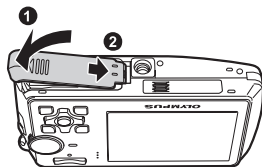

Note

- Do not open the battery/card compartment cover while the card access lamp is blinking, as this indicates that data is being read or written. Doing so may damage the data in the internal memory or the card and render the internal memory or card unusable.

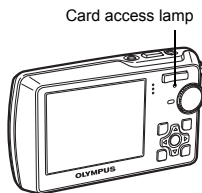

AC adapter

An AC adapter is useful for time-consuming tasks such as image downloads to a computer or when running a slideshow for a long period of time. To use an AC adapter for this camera, the multi-adapter (CB-MA1/accessory) is required. Do not use any other AC adapter with this camera.

SAFETY PRECAUTIONS

Weatherproof feature

This camera is weatherproof, but it cannot be used underwater. Olympus will not assume any responsibility for malfunction of the camera caused by water getting inside as a result of misuse by the user. The camera is weatherproof and is not damaged by water spray from any direction.

Observe the following precautions when using the camera.



- Do not wash the camera with water.

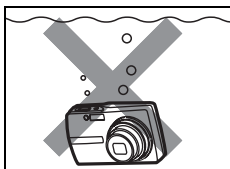

- Do not drop the camera into water.



- Do not take pictures underwater.

Water may get inside the camera if the battery/card compartment cover or connector cover are not firmly closed.

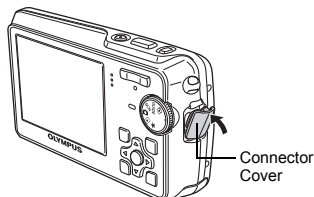
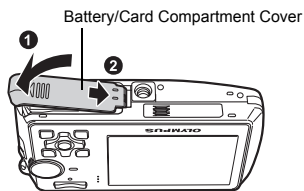

- If the camera gets splashed, wipe the water off as soon as possible with a dry cloth.
- Do not open or close the battery/card compartment cover or connector cover while the camera is wet.
- The rechargeable battery and other camera accessories are not weatherproof.

**CAUTION****RISK OF ELECTRIC SHOCK
DO NOT OPEN****CAUTION:** TO REDUCE THE RISK OF ELECTRICAL SHOCK, DO NOT REMOVE COVER (OR BACK). NO USER-SERVICEABLE PARTS INSIDE. REFER SERVICING TO QUALIFIED OLYMPUS SERVICE PERSONNEL.

An exclamation mark enclosed in a triangle alerts you to important operating and maintenance instructions in the documentation provided with the product.

**DANGER**

If the product is used without observing the information given under this symbol, serious injury or death may result.

**WARNING**

If the product is used without observing the information given under this symbol, injury or death may result.

**CAUTION**

If the product is used without observing the information given under this symbol, minor personal injury, damage to the equipment, or loss of valuable data may result.

WARNING!**TO AVOID THE RISK OF FIRE OR ELECTRICAL SHOCK, NEVER DISASSEMBLE, EXPOSE THIS PRODUCT TO WATER OR OPERATE IN A HIGH HUMIDITY ENVIRONMENT.****General Precautions**

Read All Instructions — Before you use the product, read all operating instructions. Save all manuals and documentation for future reference.

Cleaning — Always unplug this product from the wall outlet before cleaning. Use only a damp cloth for cleaning. Never use any type of liquid or aerosol cleaner, or any type of organic solvent to clean this product.

Attachments — For your safety, and to avoid damaging the product, use only accessories recommended by Olympus.

Water and Moisture — For precautions on products with weatherproof designs, read the weatherproofing sections.

Location — To avoid damage to the product, mount the product securely on a stable tripod, stand, or bracket.

Power Source — Connect this product only to the power source described on the product label.

Lightning — If a lightning storm occurs while using an AC adapter, remove it from the wall outlet immediately.

Foreign Objects — To avoid personal injury, never insert a metal object into the product.

Heat — Never use or store this product near any heat source such as a radiator, heat register, stove, or any type of equipment or appliance that generates heat, including stereo amplifiers.

Handling the Camera



WARNING

- **Do not use the camera near flammable or explosive gases.**
- **Do not use the flash and LED on people (infants, small children, etc.) at close range.**
 - You must be at least 1 m (3 ft.) away from the faces of your subjects. Firing the flash too close to the subject's eyes could cause a momentary loss of vision.
- **Keep young children and infants away from the camera.**
 - Always use and store the camera out of the reach of young children and infants to prevent the following dangerous situations which could cause serious injury:
 - Becoming entangled in the camera strap, causing strangulation.
 - Accidentally swallowing the battery, cards or other small parts.
 - Accidentally firing the flash into their own eyes or those of another child.
 - Accidentally being injured by the moving parts of the camera.
- **Do not look at the sun or strong lights with the camera.**
- **Do not use or store the camera in dusty or humid places.**
- **Do not cover the flash with a hand while firing.**



CAUTION

- **Stop using the camera immediately if you notice any unusual odors, noise, or smoke around it.**
 - Never remove the batteries with bare hands, which may cause a fire or burn your hands.
- **Never hold or operate the camera with wet hands.**
- **Do not leave the camera in places where it may be subject to extremely high temperatures.**
 - Doing so may cause parts to deteriorate and, in some circumstances, cause the camera to catch fire. Do not use the charger or AC adapter if it is covered (such as a blanket). This could cause overheating, resulting in fire.
- **Handle the camera with care to avoid getting a low-temperature burn.**
 - When the camera contains metal parts, overheating can result in a low-temperature burn. Pay attention to the following:
 - When used for a long period, the camera will get hot. If you hold on to the camera in this state, a low-temperature burn may be caused.
 - In places subject to extremely cold temperatures, the temperature of the camera's body may be lower than the environmental temperature. If possible, wear gloves when handling the camera in cold temperatures.
- **Be careful with the strap.**
 - Be careful with the strap when you carry the camera. It could easily catch on stray objects - and cause serious damage.

Battery Handling Precautions

Follow these important guidelines to prevent batteries from leaking, overheating, burning, exploding, or causing electrical shocks or burns.



DANGER

- The camera uses a lithium ion battery specified by Olympus. Charge the battery with the specified charger. Do not use any other chargers.
- Never heat or incinerate batteries.
- Take precautions when carrying or storing batteries to prevent them from coming into contact with any metal objects such as jewelry, pins, fasteners, etc.
- Never store batteries where they will be exposed to direct sunlight, or subjected to high temperatures in a hot vehicle, near a heat source, etc.

- To prevent causing battery leaks or damaging their terminals, carefully follow all instructions regarding the use of batteries. Never attempt to disassemble a battery or modify it in any way, by soldering, etc.
- If battery fluid gets into your eyes, flush your eyes immediately with clear, cold running water and seek medical attention immediately.
- Always store batteries out of the reach of small children. If a child accidentally swallows a battery, seek medical attention immediately.



WARNING

- Keep batteries dry at all times.
- To prevent batteries from leaking, overheating, or causing a fire or explosion, use only batteries recommended for use with this product.
- Insert the battery carefully as described in the operating instructions.
- If rechargeable batteries have not been recharged within the specified time, stop charging them and do not use them.
- Do not use a battery if it is cracked or broken.
- If a battery leaks, becomes discolored or deformed, or becomes abnormal in any other way during operation, stop using the camera.
- If a battery leaks fluid onto your clothing or skin, remove the clothing and flush the affected area with clean, running cold water immediately. If the fluid burns your skin, seek medical attention immediately.
- Never subject batteries to strong shocks or continuous vibration.



CAUTION

- Before loading, always inspect the battery carefully for leaks, discoloration, warping, or any other abnormality.
- The battery may become hot during prolonged use. To avoid minor burns, do not remove it immediately after using the camera.
- Always unload the battery from the camera before storing the camera for a long period.

Caution for Usage Environment

- To protect the high-precision technology contained in this product, never leave the camera in the places listed below, no matter if in use or storage:
 - Places where temperatures and/or humidity are high or go through extreme changes. Direct sunlight, beaches, locked cars, or near other heat sources (stove, radiator, etc.) or humidifiers.
 - In sandy or dusty environments.
 - Near flammable items or explosives.
 - In wet places, such as bathrooms or in the rain. When using products with weatherproof designs, read their manuals as well.
 - In places prone to strong vibrations.
- Never drop the camera or subject it to severe shocks or vibrations.
- When mounted on a tripod, adjust the position of the camera with the tripod head. Do not twist the camera.
- Do not touch electric contacts on cameras.
- Do not leave the camera pointed directly at the sun. This may cause lens or shutter curtain damage, color failure, ghosting on the CCD, or may possibly cause fires.
- Do not push or pull severely on the lens.
- Before storing the camera for a long period, remove the battery. Select a cool, dry location for storage to prevent condensation or mold from forming inside the camera. After storage, test the camera by turning it on and pressing the shutter release button to make sure that it is operating normally.
- Always observe the operating environment restrictions described in the camera's manual.

Battery Handling Precautions

- This camera uses a lithium ion battery specified by Olympus. Do not use any other type of battery. For safe and proper use, read the battery's instruction manual carefully before using it.
- If the battery's terminals get wet or greasy, camera contact failure may result. Wipe the battery well with a dry cloth before use.
- Always charge a battery when using it for the first time, or if it has not been used for a long period.
- When operating the camera with battery power at low temperatures, try to keep the camera and spare battery as warm as possible. A battery that has run down at low temperatures may be restored after it is warmed at room temperature.
- The number of pictures you can take may vary depending on the shooting conditions or battery.
- Before going on a long trip, and especially before traveling abroad, purchase extra batteries. A recommended battery may be difficult to obtain while traveling.
- Please recycle batteries to help save our planet's resources. When you throw away dead batteries, be sure to cover their terminals and always observe local laws and regulations.

Monitor

- Do not push the monitor forcibly; otherwise the image may become vague, resulting in a playback mode failure or damage to the monitor.
- A strip of light may appear on the top/bottom of the monitor, but this is not a malfunction.
- When a subject is viewed diagonally in the camera, the edges may appear zigzagged on the monitor. This is not a malfunction; it will be less noticeable in playback mode.
- In places subject to low temperatures, the monitor may take a long time to turn on or its color may change temporarily. When using the camera in extremely cold places, it is a good idea to occasionally place it in a warm place. A monitor exhibiting poor performance due to low temperatures will recover in normal temperatures.
- The LCD used for the monitor is made with high-precision technology. However, black spots or bright spots of light may appear constantly on the Monitor. Due to its characteristics or the angle at which you are viewing the monitor, the spot may not be uniform in color and brightness. This is not a malfunction.

Legal and Other Notices

- Olympus makes no representations or warranties regarding any damages, or benefit expected by using this unit lawfully, or any request from a third person, which are caused by the inappropriate use of this product.
- Olympus makes no representations or warranties regarding any damages or any benefit expected by using this unit lawfully which are caused by erasing picture data.

Disclaimer of Warranty

- Olympus makes no representations or warranties, either expressed or implied, by or concerning any content of these written materials or software, and in no event shall be liable for any implied warranty of merchantability or fitness for any particular purpose or for any consequential, incidental or indirect damages (including but not limited to damages for loss of business profits, business interruption and loss of business information) arising from the use or inability to use these written materials or software or equipment. Some countries do not allow the exclusion or limitation of liability for consequential or incidental damages, so the above limitations may not apply to you.
- Olympus reserves all rights to this manual.

Warning

Unauthorized photographing or use of copyrighted material may violate applicable copyright laws. Olympus assumes no responsibility for unauthorized photographing, use or other acts that infringe upon the rights of copyright owners.

Copyright Notice

All rights reserved. No part of these written materials or this software may be reproduced or used in any form or by any means, electronic or mechanical, including photocopying and recording or the use of any type of information storage and retrieval system, without the prior written permission of Olympus. No liability is assumed with respect to the use of the information contained in these written materials or software, or for damages resulting from the use of the information contained therein. Olympus reserves the right to alter the features and contents of this publication or software without obligation or advance notice.

FCC Notice

- Radio and Television Interference
- Changes or modifications not expressly approved by the manufacturer may void the user's authority to operate this equipment. This equipment has been tested and found to comply with the limits for a Class B digital device, pursuant to Part 15 of the FCC Rules. These limits are designed to provide reasonable protection against harmful interference in a residential installation.
- This equipment generates, uses, and can radiate radio frequency energy and, if not installed and used in accordance with the instructions, may cause harmful interference to radio communications.
- However, there is no guarantee that interference will not occur in a particular installation. If this equipment does cause harmful interference to radio or television reception, which can be determined by turning the equipment off and on, the user is encouraged to try to correct the interference by one or more of the following measures:
 - Adjust or relocate the receiving antenna.
 - Increase the distance between the camera and receiver.
 - Connect the equipment to an outlet on a circuit different from that to which the receiver is connected.
 - Consult your dealer or an experienced radio/TV technician for help. Only the OLYMPUS-supplied USB cable should be used to connect the camera to USB enabled personal computers (PC).

Any unauthorized changes or modifications to this equipment would void the user's authority to operate.

For customers in North and South America

For customers in USA

Declaration of Conformity

Model Number : Stylus 760/ μ 760

Trade Name : OLYMPUS

Responsible Party : **OLYMPUS IMAGING AMERICA INC.**

Address : 3500 Corporate Parkway, P.O. Box 610, Center Valley,
PA 18034-0610, U.S.A.

Telephone Number : 484-896-5000

Tested To Comply With FCC Standards
FOR HOME OR OFFICE USE

This device complies with Part 15 of the FCC rules. Operation is subject to the following two conditions:

- (1) This device may not cause harmful interference.
- (2) This device must accept any interference received, including interference that may cause undesired operation.

For customers in Canada

This Class B digital apparatus meets all requirements of the Canadian Interference-Causing Equipment Regulations.

For customers in Europe



"CE" mark indicates that this product complies with the European requirements for safety, health, environment and customer protection. "CE" mark cameras are intended for sales in Europe.



This symbol [crossed-out wheeled bin WEEE Annex IV] indicates separate collection of waste electrical and electronic equipment in the EU countries.

Please do not throw the equipment into the domestic refuse.

Please use the return and collection systems available in your country for the disposal of this product.

Use Only Dedicated Rechargeable Battery and Battery Charger

We strongly recommend that you use only the genuine Olympus dedicated rechargeable battery and battery charger with this camera.

Using a non-genuine rechargeable battery and/or battery charger may result in fire or personal injury due to leakage, heating, ignition or damage to the battery. Olympus does not assume any liability for accidents or damage that may result from the use of a battery and/or battery charger that are not genuine Olympus accessories.

Provisions of warranty

1. If this product proves to be defective, although it has been used properly (in accordance with the written Handling Care and Operating instructions supplied with it), during a period of two years from the date of purchase from an authorized Olympus distributor within the business area of Olympus Imaging Europa GmbH as stipulated on the website: <http://www.olympus.com> this product will be repaired, or at Olympus's option replaced, free of charge. To claim under this warranty the customer must take the product and this Warranty Certificate before the end of the two year warranty period to the dealer where the product was purchased or any other Olympus service station within the business area of Olympus Imaging Europa GmbH as stipulated on the website: <http://www.olympus.com>. During the one year period of the World Wide Warranty the customer may turn the product in at any Olympus service station. Please notice that not in all countries such Olympus service station exists.
2. The customer shall transport the product to the dealer or Olympus authorized service station at his own risk and shall be responsible for any costs incurred in transporting the product.
3. This warranty does not cover the following and the customer will be required to pay repair charge, even for defects occurring within the warranty period referred to above.
 - (a) Any defect that occurs due to mishandling (such as an operation performed that is not mentioned in the Handling Care or other sections of the instructions, etc.)
 - (b) Any defect that occurs due to repair, modification, cleaning, etc. performed by anyone other than Olympus or an Olympus authorized service station.
 - (c) Any defect or damage that occurs due to transport, a fall, shock, etc. after purchase of the product.
 - (d) Any defect or damage that occurs due to fire, earthquake, flood damage, thunderbolt, other natural disasters, environmental pollution and irregular voltage sources.
 - (e) Any defect that occurs due to careless or improper storage (such as keeping the product under conditions of high temperature and humidity, near insect repellents such as naphthalene or harmful drugs, etc.), improper maintenance, etc.
 - (f) Any defect that occurs due to exhausted batteries, etc.
 - (g) Any defect that occurs due to sand, mud, etc. entering the inside of the product casing.
 - (h) When this Warranty Certificate is not returned with the product.
 - (i) When any alterations whatsoever are made to the Warranty Certificate regarding the year, month and date of purchase, the customer's name, the dealer's name, and the serial number.
 - (j) When proof of purchase is not presented with this Warranty Certificate.
4. This Warranty applies to the product only; the Warranty does not apply to any other accessory equipment, such as the case, strap, lens cap and batteries.
5. Olympus's sole liability under this warranty shall be limited to repairing or replacing the product. Any liability for indirect or consequential loss or damage of any kind incurred or suffered by the customer due to a defect of the product, and in particular any loss or damage caused to any lenses, films, other equipment or accessories used with the product or for any loss resulting from a delay in repair or loss of data, is excluded. Compelling regulations by law remain unaffected by this.

Notes regarding warranty maintenance

1. This warranty will only be valid if the Warranty Certificate is duly completed by Olympus or an authorized dealer or other documents contain sufficient proof. Therefore, please make sure that your name, the name of the dealer, the serial number and the year, month and date of purchase are all completed or the original invoice or the sales receipt (indicating the dealer's name, the date of purchase and product type) is attached to this Warranty Certificate. Olympus reserves the right to refuse free-of-charge service if neither Warranty Certificate is completed nor the above document is attached or if the information contained in it is incomplete or illegible.
 2. Since this Warranty Certificate will not be re-issued, keep it in a safe place.
- Please refer to the list on the web site: <http://www.olympus.com> for the authorized international Olympus service network.

Trademarks

- IBM is a registered trademark of International Business Machines Corporation.
- Microsoft and Windows are registered trademarks of Microsoft Corporation.
- Macintosh is a trademark of Apple Computer Inc.
- xD-Picture Card™ is a trademark.
- All other company and product names are registered trademarks and/or trademarks of their respective owners.
- The standards for camera file systems referred to in this manual are the "Design Rule for Camera File System/DCF" standards stipulated by the Japan Electronics and Information Technology Industries Association (JEITA).

SPECIFICATIONS

● Camera

Product type	: Digital camera (for recording and playback)
Recording system	
Still pictures	: Digital recording, JPEG (in accordance with Design rule for Camera File system (DCF))
Applicable standards	: Exif 2.2, Digital Print Order Format (DPOF), PRINT Image Matching III, PictBridge
Sound with still pictures	: Wave format
Movies	: AVI Motion JPEG
Memory	: Internal memory xD-Picture Card 16 MB to 2 GB (TypeH/M, Standard)
No. of pictures (when fully charged)	: Approx. 200 (based on CIPA battery life measurement standards)
No. of effective pixels	: 7,110,000 pixels
Image pickup device	: 1/2.33" CCD (primary color filter), 7,380,000 (gross)
Lens	: Olympus lens 6.5 to 19.5 mm, f3.4 to 5.7 (equivalent to 37 to 111 mm on a 35 mm camera)
Photometric system	: Digital ESP metering, spot metering system
Shutter speed	: 4 to 1/1000 sec.
Shooting range	: 0.6 m (2.0 ft.) to ∞ (W/T) (normal) 0.2 m (0.7 ft.) to ∞ (W), 0.5 m (1.6 ft.) to ∞ (T) (macro mode) 0.08 m (3.2 in.) to 0.6 m (2.0 ft.) (W only) (super macro mode)
Monitor	: 2.5" TFT color LCD display, 230,000 pixels
Flash charge time	: Approx. 4 sec. (for full flash discharge at room temperature using a new fully charged battery)
Outer connectors	: DC-IN jack, USB connector, A/V OUT jack (multi-connector)
Automatic calendar system	: 2000 up to 2099
Water resistance	
Type	: Equivalent to IEC Standard publication 529 IPX4 (under OLYMPUS test conditions)
Meaning	: Camera is not damaged by water spray from any direction.
Operating environment	
Temperature	: 0°C to 40°C (32°F to 104°F) (operation), -20°C to 60°C (-4°F to 140°F) (storage)
Humidity	: 30% to 90% (operation)/10% to 90% (storage)
Power supply	: One Olympus lithium ion battery (LI-42B/LI-40B) or Olympus AC adapter
Dimensions	: 99 mm (W) × 54 mm (H) × 24.4 mm (D) (3.9 × 2.1 × 1.0 in.) (excluding protrusions)
Weight	: 120 g (4.2 oz) (excluding battery and card)



● Lithium ion battery (LI-42B)

Product type	: Lithium ion rechargeable battery
Standard voltage	: DC 3.7 V
Standard capacity	: 740 mAh
Battery life	: Approx. 300 full charges (varies on usage)
Operating environment	
Temperature	: 0°C to 40°C (32°F to 104°F) (charging)/ -10°C to 60°C (14°F to 140°F) (operation)/ -20°C to 35°C (-4°F to 95°F) (storage)
Dimensions	: 31.5 × 39.5 × 6 mm (1.2 × 1.5 × 0.2 in.)
Weight	: Approx. 15 g (0.5 oz)

● Battery charger (LI-40C)

Power requirements	: AC 100 to 240 V (50 to 60 Hz) 3.2 VA (100 V) to 5.0 VA (240 V)
Output	: DC 4.2 V, 200 mA
Charging time	: Approx. 300 min.
Operating environment	
Temperature	: 0°C to 40°C (32°F to 104°F) (operation)/ -20°C to 60°C (-4°F to 140°F) (storage)
Dimensions	: 62 × 23 × 90 mm (2.4 × 0.9 × 3.5 in.)
Weight	: Approx. 65 g (2.2 oz)

Design and specifications subject to change without notice.

CAMERA DIAGRAM

Camera

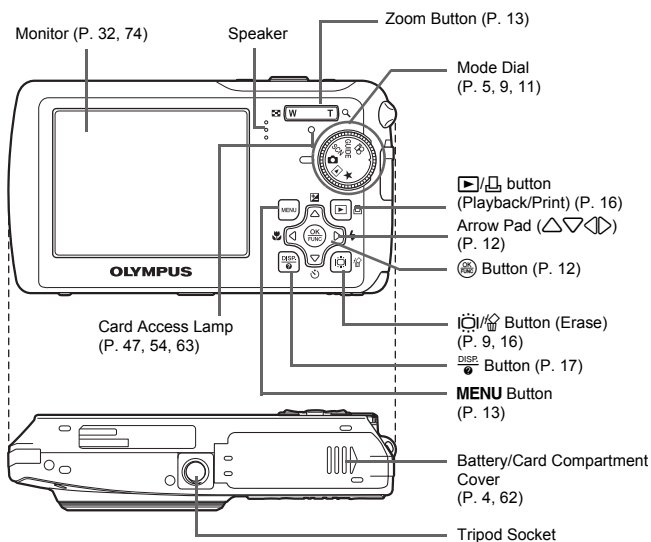
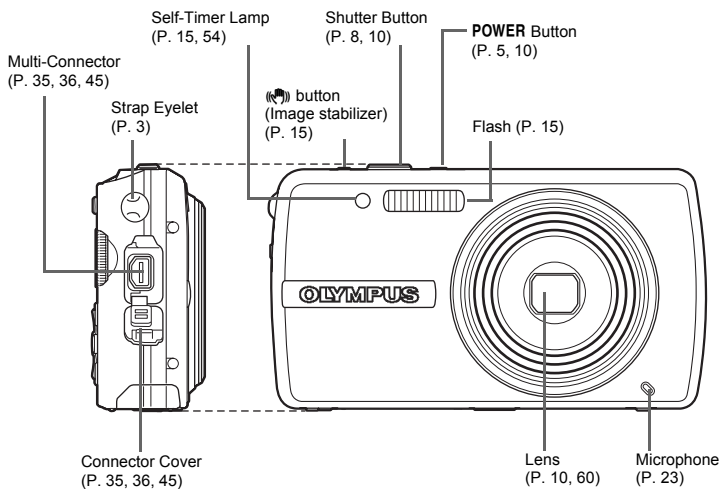

Monitor Symbols & Icons

● Monitor - Shooting mode

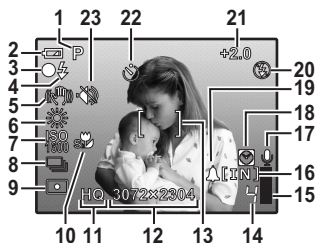

Still picture

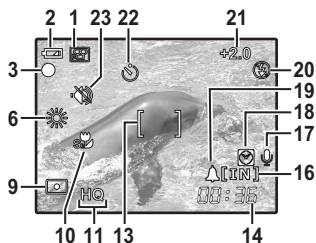

Movie

	Item	Indication	Ref. Page
1	Shooting modes	AUTO , P , etc.	P. 11, 12, 21
2	Battery check	= full power, = low power	P. 57
3	Green lamp	○ = Auto Focus Lock	P. 8 10, 54
4	Flash standby Camera movement warning/ flash charge	(Lit) (Blinks)	P. 50
5	Digital Image Stabilization		P. 15
6	White balance		P. 22
7	ISO	ISO 80 – ISO 1600	P. 22
8	Drive		P. 22
9	Spot metering		P. 23
10	Macro mode Super macro mode		P. 15
11	Image quality	SHQ, HQ, SQ1, SQ2, 16:9, SQ	P. 20
12	Image size	3072 × 2304, 2560 × 1920, 640 × 480, etc.	P. 20
13	AF target mark	[]	P. 8, 23
14	Number of storable still pictures Remaining recording time	4 00:36	P. 53
15	Memory gauge	(maximum reached)	P. 50
16	Current memory	[IN] (Recording pictures to the internal memory), [xD] (Recording pictures to the card)	P. 61
17	Sound record		P. 23
18	Dualtime		P. 33
19	Alarm		P. 33
20	Flash mode		P. 15
21	Exposure compensation	-2.0 – +2.0	P. 14
22	Self-timer		P. 15
23	Silent mode		P. 24

● Monitor - Playback mode

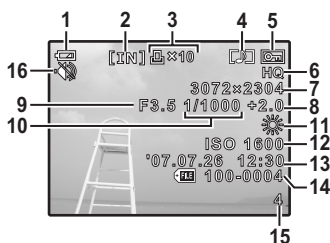

Still picture



Movie

	Item	Indication	Ref. Page
1	Battery check	= full power, = low power	P. 57
2	Current memory	[IN] (Playing back the picture in the internal memory), [xD] (Playing back the picture in the card)	P. 61
3	Print reservation/Number of prints	× 10	P. 40
	Movie		P. 26
4	Sound record		P. 29
5	Protect		P. 29
6	Image quality	SHQ, HQ, SQ1, SQ2, 16:9, SQ	P. 20
7	Image size	3072 × 2304, 2560 × 1920, 640 × 480, etc.	P. 20
8	Exposure compensation	-2.0 – +2.0	P. 14
9	Aperture value	F3.5, F4.0, etc.	–
10	Shutter speed	4 – 1/1000	–
11	White balance	WB AUTO,	P. 22
12	ISO	ISO 80 – ISO 1600	P. 22
13	Date and time	'07.07.26 12:30	P. 6, 33
14	File number	100-0004	P. 32
15	Number of frames	4	P. 32
	Elapsed time/ Total recording time	00:00/00:36	P. 26
16	Silent mode		P. 24

Index

button	17
button (erase)	16
button (exposure compensation)	14
button (flash mode)	15
button (macro)	15
button (OK/FUNC)	12
button (playback/print)	16
button (self-timer)	15
16:9	20

A

AC adapter	63
ADD FAVORITE	12, 26
Adding sound to still pictures	29
AF lock	11
AF MODE	23
ALARM CLOCK	33
ALL ERASE	30
ALL INDEX	38
ALL PRINT	38
All-frame reservation	41
Arrow pad ()	12
AUTO (Auto-flash)	15
AUTO (Full auto mode)	12
AUTO (ISO)	22
AUTO (WB) WB AUTO	22
Auto focus	51
AV cable	3, 35

B

BACKUP	31
Battery	4, 60
Battery charger	3, 4, 60
Battery check	74
Battery/card compartment cover	4, 62
BEEP	31
BGM	25
BLACK & WHITE	27
BRIGHTNESS	28

C

CALENDAR	28
Calendar display	14, 27
CAMERA MENU	20, 22
Card	24, 30, 61, 62
Card access lamp	47, 54, 63
CCD	32
Close-up playback	14
Cloudy day	22
Compression	20
Connector cover	35, 36, 45
CUSTOM PRINT	37

D

Date and time	6, 33
DIGITAL ZOOM	23
Direct printing	36
Display language	31
DPOF	39

DRIVE	22
DUALTIME	33

E

EASY PRINT	36
EDIT	27
ERASE	29
Erase	9, 16
Error message	57
ESP	23
ESP/	23
EV	14
Exposure	14
Exposure compensation	14, 75

F

FILE NAME	32, 38
File name	33
Fill-in flash	15
Flash	15
Flash charge	50, 74
Flash mode	10, 15
Flash off	15
Fluorescent lamp 1/2/3	22
Focus	8, 10, 11, 22, 51, 54
Focus lock	10
FORMAT	30
Format	30
FRAME	27
FRAME ASSIST	17
Frame number	75
Function menu	12

G

Green lamp	8, 10, 51, 54
GUIDE (Shooting guide)	5, 11

H



High speed sequential shooting	22
Histogram display	17, 55
HQ	20

I

iESP	23
IMAGE QUALITY	20
Image size	20
Image stabilizer	15
INDEX	28
Index display	14
Information displays	17
Internal memory	30, 61
ISO	22







L





LABEL	27
Lens	10, 60
Lithium ion battery	3, 4, 60
Low compression	20











M	
Macro mode 	10, 15
MEMORY FORMAT	30
Memory gauge	50
Menu	18
MENU button (MENU)	13
Menu guide	17
MENU THEME	31
Microphone	23
Mode dial	5, 9, 11
Monitor	32, 74
Monitor brightness adjustment 	32
Monitor Symbols & Icons	74
MOVIE PLAY	26
MULTI PRINT	38
Multi-connector	35, 36, 45

N	
NTSC	34
Number of storable still pictures	53

O	
OLYMPUS Master	3, 42
Operation guide	18, 37, 40
Optical zoom	13, 23

P	
P (Program auto)	12
P/AUTO	12
PAL	34
PANORAMA	24
PC	45
PictBridge	36
Picture rotation 	29
PIXEL MAPPING	32
Play "My Favorite" 	12
PLAYBACK MENU	25, 29
Playback mode 	9, 10, 12, 14, 17, 30
Playback on a TV	35
Playing time/Total recording time	26
POWER button	5, 10
POWER SAVE	35
Press completely	8, 10
Press halfway	8, 10
PRINT ORDER 	28, 38
Print settings 	39
Printing pictures	36
Protect 	29
PW ON SETUP	31

R	
REC VIEW	32
Recording length	53
Recording movies 	11
Recording sound with still pictures 	23
REDEYE FIX	27
Red-eye reduction flash 	15
RESET	21
Resizing 	27

S	
SATURATION	28
SCN (Scene)	5, 11, 21
SEL. IMAGE	30
Self-timer lamp	15, 54
Self-timer 	10, 15
SEPIA	27
Sequential shooting 	22
SETUP menus	30
SHOOT & SELECT1/2 	22
Shooting mode	10, 13, 17, 30
Shooting still pictures 	5, 11
SHQ	20
Shutter button	8, 10
SHUTTER SOUND	31
SILENT MODE 	24
Single-frame playback	14
Single-frame reservation 	40
Single-frame shooting 	22
Sleep mode	50
SLIDESHOW	25
Speaker	73
SPOT (AF MODE)	23
Spot metering 	23
SQ	20
SQ1	20
SQ2	20
STANDARD	36
Standard compression	20
Strap	3
Sunny day 	2
Super macro mode 	10, 15

T	
Top menu	18
Tripod socket	73
Tungsten light 	22
Turn the camera on	5
TYPE	25

U	
USB cable	3, 36, 42, 45, 47
USB driver	48

V	
VIDEO OUT	34
VOLUME	31

W	
Warning sound 	31
White balance WB	22

X	
xD-Picture Card	24, 61

Z	
Zoom	13, 23
Zoom button	13, 23

Memo

Memo

Memo

Memo

Memo

Memo

OLYMPUS®

<http://www.olympusamerica.com/>

OLYMPUS IMAGING AMERICA INC.

3500 Corporate Parkway, P.O. Box 610, Center Valley, PA 18034-0610, U.S.A. Tel. 484-896-5000

Technical Support (USA)

24/7 online automated help: <http://www.olympusamerica.com/support>

Phone customer support: Tel. 1-888-553-4448 (Toll-free)

Our phone customer support is available from 8 am to 10 pm (Monday to Friday) ET

E-Mail: distec@olympus.com

Olympus software updates can be obtained at: <http://www.olympusamerica.com/digital>

To find the nearest Service Centers, please visit: <http://www.olympusamerica.com/digital>,

and click on the Worldwide Warranty icon at the bottom of the page.

Service Centers

U.S.A.:

California Olympus Imaging America Inc.

10805 Holder Street Suite 170
Cypress, CA 90630-5145
Tel: (888) 553-4448

New York Olympus Imaging America Inc.

400 Rabro Drive
Hauppauge, NY 11788-4258
Tel: (888) 553-4448

Canada:

Mississauga Olympus Canada Inc.

Consumer Products Group
151 Telson Road
Markham, Ontario Canada L3R 1E7
Tel. 1-866-267-3039

Mexico: Olympus Imaging de Mexico S.A. de C.V.

WTC Mexico,
Montecito No.38 - Lobby - Office 3
Col. Napolis, Mexico D.F. 03810
Tel. (01800)800-2128
E-mail: pedro.jimenez@olympus.com

Argentina:

Jesus Labrador S.A.

Paraguay 755 PB, C1057 AAI Buenos Aires
Tel: (011) 4313-3174 Fax: (011) 4312-5239
E-Mail: jesuslabrador@speedy.com.ar

Jesus Labrador S.A.

Sucursal Mitre, Bartolome Mitre 860
C1036AAP Buenos Aires Tel: (011) 4331-1227
E-mail: jesuslabrador@speedy.com.ar

Brazil:

Rio de Janeiro Assistec

Rua Uruguaiana, 94-Sobrelaja
Centro-Rio de Janeiro CEP 20050-091
Tel: (021) 2242-3236 Fax: (021) 2242-3236
E-Mail: rio@assistecs.com.br

Sao Paulo Assistec

Rua Avanhandava 126, 3 Andar
Consolação, São Paulo
Tel: (011) 3123-3100 Fax: (011) 3214-0706
E-mail: ASSISTECSS@UOL.COM.BR

Assistec

Filial Shopping Eldorado
Av. Rebouças 3970, 1 Subsolo, Loja 1035
Pinheiros, Sao Paulo
Tel: (011) 3815-3054 Fax: (011) 3814-4398
E-mail: ASSISTECSS@UOL.COM.BR

Chile:

REIFSCHEIDER S.A.

Camino El Conquistador del Monte 5024
Huechuraba, Santiago
Tel: 56-2-6781200
Fax: 56-2-6781202
E-mail : olympus@reifschneider.cl,
serviciotecnico@reifschneider.cl

Colombia:

CV Tronica LTDA

Calle 68 No 12-57, Bogota
Tel: (0571) 235-7260/348-1573
Fax: (0571) 348-1574
E-mail: servicio@cvtronica.com

Panama:

FOTOSER

Edif. El Paical, Oficina No3, P.A.
Urb. Herbruger, Transistmica
(Detras del S/M Riba Smith),
Tel/Fax: (507) 261-0436
E-mail: rearanda@rocketmail.com

Uruguay:

Fotocamara S.R.L.

Rondeau 1470 Montevideo
Tel: (02) 900-2004 Fax: (02) 900-8430
E-mail: FOTOCAM@ADINET.COM.UY

Venezuela:

Micron C.A.

4ta. transversal Urb. Horizonte,
Edificio América, Mezanine, Caracas 1070-A
Tel: (0212) 238-3526 Fax: (0212) 239-8598
E-mail: gullermolandaeta@micron.com.ve