

User's Guide



Shop online at

omega.com[®]

Ω OMEGA[®]

omega.com

e-mail: info@omega.com

*For latest product manuals:
omegamanual.info*

ISO 9001
CERTIFIED
CORPORATE QUALITY

STAMFORD, CT

ISO 9002
CERTIFIED
CORPORATE QUALITY

MANCHESTER, UK

OMB-DAQBOOK 100 & 200 Series **Data Acquisition for Notebook, Desktop, and Tower PCs**



OMEGAnet® Online Service
omega.com

Internet e-mail
info@omega.com

Servicing North America:

U.S.A.:
ISO 9001 Certified

One Omega Drive, P.O. Box 4047
Stamford, CT 06907-0047
TEL: (203) 359-1660 FAX: (203) 359-7700
e-mail: info@omega.com

Canada:

976 Bergar
Laval (Quebec) H7L 5A1, Canada
TEL: (514) 856-6928 FAX: (514) 856-6886
e-mail: info@omega.ca

For immediate technical or application assistance:

U.S.A. and Canada: Sales Service: 1-800-826-6342 / 1-800-TC-OMEGA®
Customer Service: 1-800-622-2378 / 1-800-622-BEST®
Engineering Service: 1-800-872-9436 / 1-800-USA-WHEN®

Mexico:

En Español: (001) 203-359-7803 e-mail: espanol@omega.com
FAX: (001) 203-359-7807 info@omega.com.mx

Servicing Europe:

Benelux:

Postbus 8034, 1180 LA Amstelveen, The Netherlands
TEL: +31 (0)20 3472121 FAX: +31 (0)20 6434643
Toll Free in Benelux: 0800 0993344
e-mail: sales@omegaeng.nl

Czech Republic:

Frystatska 184, 733 01 Karviná, Czech Republic
TEL: +420 (0)59 6311899 FAX: +420 (0)59 6311114
Toll Free: 0800-1-66342 e-mail: info@omegashop.cz

France:

11, rue Jacques Cartier, 78280 Guyancourt, France
TEL: +33 (0)1 61 37 2900 FAX: +33 (0)1 30 57 5427
Toll Free in France: 0800 466 342
e-mail: sales@omega.fr

Germany/Austria:

Daimlerstrasse 26, D-75392 Deckenpfronn, Germany
TEL: +49 (0)7056 9398-0 FAX: +49 (0)7056 9398-29
Toll Free in Germany: 0800 639 7678
e-mail: info@omega.de

United Kingdom:

ISO 9002 Certified

One Omega Drive, River Bend Technology Centre
Northbank, Irlam, Manchester
M44 5BD United Kingdom
TEL: +44 (0)161 777 6611 FAX: +44 (0)161 777 6622
Toll Free in United Kingdom: 0800-488-488
e-mail: sales@omega.co.uk

It is the policy of OMEGA Engineering, Inc. to comply with all worldwide safety and EMC/EMI regulations that apply. OMEGA is constantly pursuing certification of its products to the European New Approach Directives. OMEGA will add the CE mark to every appropriate device upon certification.

The information contained in this document is believed to be correct, but OMEGA accepts no liability for any errors it contains, and reserves the right to alter specifications without notice.

WARNING: These products are not designed for use in, and should not be used for, human applications.

Chapter 1 – *Daq Systems, a Brief Overview* discusses the “modular concept” associated with DaqBooks, DaqBoards, and DBK options.

Chapter 2 – *Setup and Startup* provides instructions for configuring and connecting a DaqBook; installing the appropriate software, and supplying power to the system.

Chapter 3 – *A Closer Look at DaqBook Hardware* discusses the differences between DaqBook models, performance factors, jumpers, connections, and stacking hardware.

DBK Basics – discusses option cards and modules (DBKs) that can be used to enhance and expand data acquisition systems. Note that *DBK Basics* is not a chapter, but an independent document module that is applicable to this user’s manual, as well as others.

Appendix A – *Specifications, DaqBooks*



Reference Notes:

During software installation, Adobe® PDF versions of user manuals are automatically installed onto your hard drive as a part of product support. The default location is in the **Programs** directory, which can be accessed from the Windows Desktop.

A copy of the Adobe Acrobat Reader® is included on your CD. The Reader provides a means of reading and printing the PDF documents. Note that hardcopy versions of manuals can be ordered from the factory.

- DaqView and DaqViewXL* – explains the use and features of the included *out-of-the-box* data acquisition software.
- Post Acquisition Data Analysis User’s Guide*– This pdf consists of two documents. The first discusses eZ-PostView, a post data acquisition analysis program. The application is included free as a part of DaqTemp product support. The second includes information regarding eZ-FrequencyView and eZ-TimeView. These two applications have more features than does eZ-PostView and are available for purchase. They can, however, be used freely during a 30-day trial period. For detailed information regarding specific DBKs, refer to the DBK Option Cards and Modules User’s Manual, p/n OMB-457-0905. Each DBK section includes device-specific hardware and software information. The document includes a chapter on power management.
- For programming-related information refer to the separate *Programmer’s Manual*, p/n OMB-1008-0901.

Table of Contents

1 – Daq Systems, a Brief Overview

- Daq Systems, the Modular Concept1-1*
- DaqBooks & DaqBoards1-2*
- Using DBK Cards & Modules for Signal Conditioning ...1-3*
- Daq Software 1-3*

2 – Setup and Startup

- Set Jumpers2-2*
- Connect to the PC and Connect Power 2-3*
- Install Software and Product Support Documentation 2-4*
- Test Hardware..... 2-5*

3 – A Closer Look at DaqBook Hardware

- DaqBook/100,/112,/120,/200, and /2163-1*
 - In General 3-1*
 - DaqBook Differences 3-1*
 - Performance Factors 3-2*
 - Front and Rear Panels3-2*
 - Jumpers3-4*
 - Connections3-7*
- DaqBook/260 3-12*
 - Front and Rear Panels3-12*
 - Hardware Setup3-13*
- Stacking Hardware3-17*
 - Using Dual-Lock Tabs and Splice Plates 3-17*
 - Using T-Cables3-18*

DBK Basics (Document Module)

- Introduction..... 1*
- How Do DBKs Connect to the Data Acquisition Device? 2*
- DBK Identification Tables 3*
 - Analog Output DBKs 3*
 - Digital I/O Control DBKs 3*
 - Analog Signal Conditioning DBKs 3*
 - Expansion and Terminal Panel Connection DBKs 4*
 - Power Supply DBKs 4*
- Tips on Setting up a Data Acquisition System 4*
- Power Supplies and Power Connectors6*
- An Introduction to Power-Related DBKs 7*
- Calculating Your System's Power Needs 9*
- Additional Reading 11*

Appendix A - Specifications, DaqBooks

Daq Systems, the Modular Concept 1-1
DaqBooks and DaqBoards 1-2
Using DBK Cards and Modules for Signal Conditioning 1-2
Daq Software 1-3

Daq Systems, the Modular Concept

Daq equipment and software form a modular, interrelated family of products that provide great flexibility in data acquisition system design. This flexibility allows for the development of custom systems that are unique to the user, and which can be optimized for his or her specific application needs. With the Daq product line, system expansion or redesign can typically be accomplished with relative ease.

- **Primary Acquisition Device.** This is the main data acquisition device, e.g., a DaqBook or DaqBoard. These devices provide a vital data conversion and communications link between the data source of transducers and signal conditioners and the data processor of the host computer. Note the DaqBoards can be one of three types: (1) ISA, (2) PCI, or (3) compact PCI (cPCI). The DaqBoards covered in this document are of the ISA type.
- **DBK Option Cards and Modules.** Over 35 DBK cards and modules (the number is constantly growing) provide various types of signal conditioning and system expansion. Note that certain DBK modules exist for the purpose of supplying power to other members of the acquisition system. The DBK options are discussed in a *DBK Basics* document module and in the detailed *DBK Option Cards and User's Manual* (p/n OMB-457-0905).



Reference Note:

DBK options are discussed in the *DBK Option Cards and Modules User's Manual* (p/n OMB-457-0905). As a part of product support, this manual is automatically loaded onto your hard drive during software installation. The default location is the Programs directory, which can be accessed through the Windows Desktop.

- **Software.** DaqView *out-of-the-box* software provides a graphical user interface with easy to read spreadsheet formats for viewing channel data, as well as a choice of analog, digital, and bar-graph meters. Waveform analysis can be performed, when applicable. A product support option, included on the data acquisition CD, provides a means of performing post data analysis. More information is included in the software-specific PDF documents that are installed on your hard-drive as a part of product support.

In addition to the included out-of-the-box software, Daq products can be controlled via user-written custom programs through Applications Program Interface (API). Several languages are supported, e.g., C/C++, VisualBASIC, Delphi.



Reference Note:

Programming topics are covered in the *Programmer's User Manual* (p/n OMB-1008-0901). As a part of product support, this manual is automatically loaded onto your hard drive during software installation. The default location is the Programs directory, which can be accessed through the Windows Desktop.

DaqBooks and DaqBoards

Daq products connect to one or more DBKs on their signal input side and a computer on their output side. Each type of Daq device connects to the computer in a different way:

- The **DaqBook** is an external module that connects to a computer's enhanced parallel port (EPP) interface or PC-Card link.
- The **DaqBoard [ISA type]** board is an internal card that plugs into an ISA-bus slot within a computer.

Features common to the Daq products include:

- 100-kHz channel-to-channel scan *and* gain switching (10 μ s); 200-kHz for DaqBoard/2000 Series and DaqBoard/2000c Series Boards.
- 512-location sequence memory that can be loaded with any combination of channels and gains.
- Ability to access up to 256 different channels of DBK signals while maintaining the channel-to-channel scan rate. The DBK expansion options can accommodate mixed-signal inputs from thermocouples and RTDs to isolated high-voltage inputs and strain gages.
- Ability to handle 8 differential or 16 single-ended signal inputs without DBK expansion units.
- Ability to handle fixed digital I/O up to 4 TTL lines in and 4 TTL lines out (accessible only if no analog expansion cards are in use).

The following table lists various features of DaqBooks and ISA-DaqBoards.

Daq Products, Models and Features								
Models	A/D Resolution	Analog Output Channels	Unipolar/Bipolar Selection	Single-ended/Differential Selection	Programmable Digital I/O Lines	Program mable Counter/ Timers	Size (inches)	Power Consumption
DaqBooks								
DaqBook/100	12 bit	2	Jumper	Jumper	16 high speed 24 gen purpose	5 ch 7 MHz	8.5×11 ×1.375	510 mA @ 12V
DaqBook/112	12 bit	2	Jumper	Jumper	N/A	N/A	8.5×11 ×1.375	360 mA @ 12V
DaqBook/120	12 bit	2	Jumper	Jumper	16 high speed 24 gen purpose	5 ch 7 MHz	8.5×11 ×1.375	510 mA @ 12V
DaqBook/200	16 bit	2	Software	Software	16 high speed 24 gen purpose	5 ch 7 MHz	8.5×11 ×1.375	620 mA @ 12V
DaqBook/216	16 bit	2	Software	Software	N/A	N/A	8.5×11 ×1.375	600 mA @ 12V
DaqBook/260	16 bit	2	Software	Software	16 high speed 24 gen purpose	5 ch 7 MHz	11×13 ×3.5	620* mA @ 12V
ISA-DaqBoards								
DaqBoard/100A	12 bit	2	Sequencer	Software	16 high speed 24 gen purpose	5 ch 7 MHz	4.5×13.125	1330 mA @ 5V
DaqBoard/112A	12 bit	2	Sequencer	Software	N/A	N/A	4.5×13.125	970 mA @ 5V
DaqBoard/200A	16 bit	2	Sequencer	Software	16 high speed 24 gen purpose	5 ch 7 MHz	4.5×13.125	1700 mA @ 5V
DaqBoard/216A	16 bit	2	Sequencer	Software	N/A	N/A	4.5×13.125	1340 mA @ 5V

* Does not include power consumption of internal DBK options.

Using DBK Cards and Modules for Signal Conditioning

The DBK signal-conditioning cards and module are designed for use with DaqBooks, LogBooks, and various types of data acquisition boards, i.e., ISA, PCI, and compact PCI (cPCI) types. The DBKs perform best when used with an acquisition device that can dynamically select channel, gain, and range. DBK cards and modules with dynamic channel and gain/range selection allow for high channel-to-channel scan rates with a variety of transducers.

DBK output signals can be bipolar, e.g., -5 to +5 V, or unipolar, e.g., 0 to 10 V. The user can select a range of relevant values to correspond to the lowest signal (e.g., -5 or 0 V) and the highest signal (e.g., 5 or 10 V) signal. This type of range selection guarantees the highest resolution in 12-bit or 16-bit conversion.

DBK modules share the same footprint as the DaqBook and a typical notebook PCs; allowing for convenient stacking. The majority of these modules have their own power supply; however, several options exist for packaging and powering the DBKs.



Reference Note:

DBK options are detailed in the *DBK Option Cards and Modules User's Manual* (p/n OMB-457-0905). As a part of product support, this manual is automatically loaded onto your hard drive during software installation. The default location is the Programs directory, which can be accessed through the Windows Desktop.

Daq Software

The Daq devices have software options capable of handling most applications. Three types of software are available:

- ready-to-use graphical programs, e.g., DaqView, DaqViewXL, and post acquisition data analysis programs such as PostView, DIAdem, and eZ-PostView
- drivers for third-party, icon-driven software such as DASyLab and LabView
- various language drivers to aid custom programming using API

Ready-to-use programs are convenient for fill-in-the-blank applications that do not require programming for basic data acquisition and display:

- DaqView is a Windows-based program for basic set-up and data acquisition. DaqView lets you select desired channels, gains, transducer types (including thermocouples), and a host of other parameters with a click of a PC's mouse. DaqView lets you stream data to disk and display data in numerical or graphical formats. PostView is a post-acquisition waveform-display program within DaqView.
- DaqViewXL allows you to interface directly with Microsoft Excel to enhance data handling and display. Within Excel you have a full-featured Daq control panel and all the data display capabilities of Excel.
- Post acquisition data analysis programs, e.g., PostView, DIAdem, and eZ-PostView, typically allow you to view and edit post-acquisition data.
- The Daq Configuration control panel allows for interface configuration, testing, and troubleshooting.

Each Daq system comes with an Application Programming Interface (API). API-language drivers include: C/C++, Delphi, and Visual Basic. The latest software is a 32-bit version API.



Reference Notes:

- The software document modules, *DaqView*, *DaqViewXL*, and *Post Acquisition Data Analysis User's Guide*, are not included as part of the hardcopy manual, but are available in PDF version. See the PDF Note, below.
- Programming topics are covered in the *Programmer's User Manual* (p/n OMB-1008-0901). As a part of product support, this manual is automatically loaded onto your hard drive during software installation. The default location is the Programs directory, which can be accessed through the Windows Desktop.

PDF Note: During software installation, Adobe® PDF versions of user manuals will automatically install onto your hard drive as a part of product support. The default location is in the **Programs** directory, which can be accessed from the *Windows Desktop*. Refer to the PDF documentation for details regarding both hardware and software.

A copy of the Adobe Acrobat Reader® is included on your CD. The Reader provides a means of reading and printing the PDF documents. Note that hardcopy versions of the manuals can be ordered from the factory.

For DaqBook/100, /112, /120, /200, /216, /260*

This chapter provides instructions for getting a DaqBook configured, connected, installing the appropriate software, and powering up the system. The figure, later on this page, provides an overview of the steps necessary for a successful setup.



Reference Notes:

- **DaqBook/260 Users:** Instructions detailing the removal of the slide-out drawer and steps for installing internal cards are provided in Chapter 3 of this manual.
- The *DBK Option Cards and Modules User's Manual* (p/n OMB-457-0905) contains detailed DBK and power-related information. As a part of product support, the DBK manual is automatically loaded onto your hard drive during software installation. The default location is the **Programs** directory, which can be accessed through the Windows Desktop.

CAUTION



Turn off power to the DaqBook and externally connected equipment before connecting cables and setting configuration jumpers and switches, and before removing the cover. Electric shock or damage to equipment can result even under low-voltage conditions.



Take ESD precautions (packaging, proper handling, grounded wrist strap, etc.)

Minimum System Requirements

PC system with Pentium® Processor

Windows Operating System

RAM, as follows:

- 16 Mbytes of RAM for Windows 3.x
- 32 Mbytes of RAM for Windows 95/98/NT
- 64 Mbytes of RAM for Windows Me
- 64 Mbytes of RAM for Windows 2000
- 64 Mbytes of RAM for Windows XP

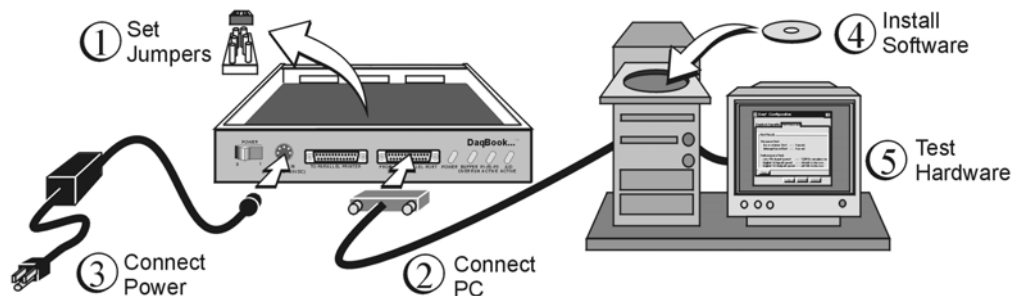

DaqBook Installation Steps, Pictorial Overview

* **DaqBook/260 Users:** Instructions detailing the removal of the slide-out drawer and steps for installing internal cards are provided in Chapter 3 of this manual.

(1) Set Jumpers

- Place the unit on a flat, stable surface. Ensure no power or signal lines are connected.
- Remove cover screw(s), and slide the top cover plate free of the device. All jumpers are accessible from above the board, and no further disassembly is required.
- Set jumpers JP1 through JP4 as needed for your application. Jumper configuration options follow shortly. Note that jumpers are clearly labeled on the actual motherboards.

Note: DaqBook/200, /216, and /260 do not have JP3 and JP4 jumpers. For those units, related settings are made via software.
- Leave JP5, JP6, and JP7 in their default positions. JP5 (Time Base Selection) default position is for 1 MHz. JP6 (Watchdog Timer Enable/Disable) default position selects “disabled.” JP7 concerns calibration. See user’s manual prior to changing the settings of these three jumpers.
- Replace and secure the cover before applying power and signals.

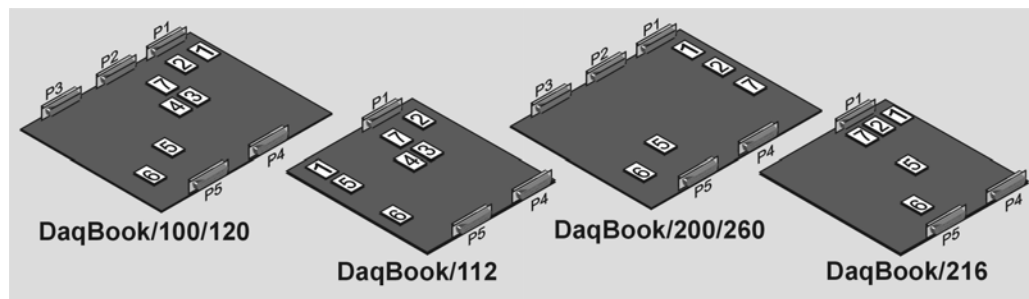

Motherboard Jumper Locations

Note: DaqBook/112 and DaqBook/216 boards are physically smaller than the other boards.

JP1 – External Analog Expansion Power

If analog option cards (DBKs) are used, JP1 jumpers are set to provide +15 and -15 VDC to the cards.

If using a DBK32A or DBK33 Power Supply Card, remove all jumpers from JP1.

If no cards are being used, the counter/timer CTR0 is available, and JP1 must be set as shown in the following figure.

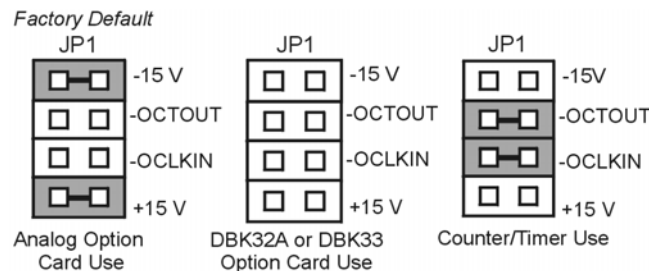

CAUTION



Placing the jumpers on -OCTOUT and -OCLKIN could damage the 8254 timer chip! If either a DBK32A Auxiliary Power Supply or a DBK33 Triple-Output Power Supply Card is used, the JP1 shunt jumpers must be removed, otherwise timer chip damage will occur. Refer to the DBK32A, DBK33, and Power Management sections of your user’s manual for more information.

JP2 – DAC Reference Voltage and SSH (Simultaneous Sample and Hold)

JP2 selects an **Internal** (*default*) or **External** reference voltage for the two separate analog outputs.

JP2 also selects **SSH** (*default*) for applications using one or more of the following: DBK2, DBK4, DBK5, DBK7, DBK17, DBK50, or DBK51.

We recommend that you leave these jumpers at the factory default setting (see figure at right). Refer to the JP2 material in chapter 3 prior to making changes.

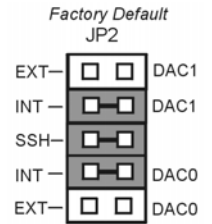

CAUTION



Incorrect jumper placement can damage the DaqBook!

JP2 – If EXT DAC0 or EXT DAC1 are used, the SSH jumper must be removed!
JP3 and JP4 - Placing JP3 [or JP4] jumpers horizontally can damage DaqBook!

JP3 – Bipolar or Unipolar A/D Operation

JP3 selects **Bipolar** (*default*) or **Unipolar** operation for the A/D converter.

- **If using DBK cards**, leave these jumpers in the factory default positions.
- **If you want 0-10V range** [instead of -5 V to $+5\text{ V}$] **and are not using DBK cards**, position JP3 jumpers to select **Unipolar**.

Note: For DaqBook/200, /216 and /260 a JP3 equivalent setting is made in software.

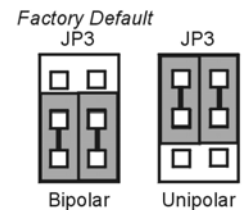

JP4 - Single-ended or Differential Analog Input Channels

JP4 selects the analog input lines as 16 **Single-Ended** channels (default); or 8 pairs of **Differential** channels.

If using DBK cards, leave these jumpers in the factory default positions.

If you are not using DBK cards and you want differential channels, then position the jumpers for Differential.

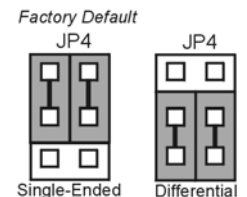

Note: For DaqBook/200, /216 and /260 a JP4 equivalent setting is made in software.

(2 & 3) Connect to the PC and Connect Power

- Verify DaqBook's power switch is in the "0" (**OFF**) position.
- Connect the female-end of the supplied cable to DaqBook's connector labeled, "**FROM PC PARALLEL PORT.**"
- Connect the male-end of the cable to an available parallel port on the PC.
- Connect the supplied AC-to-DC adapter's *jack-end* to DaqBook's **POWER IN** connector.
- Connect the adapter's plug to a standard AC outlet.
- To verify connections, turn **ON** the power by placing the rocker-arm POWER switch to the "1" position. The **POWER LED** should light up.

If connecting your DaqBook to a notebook PC, you can use a WBK20A, PCMCIA Interface Card. Refer to separate instructions (supplied with the WBK20A) if applicable.

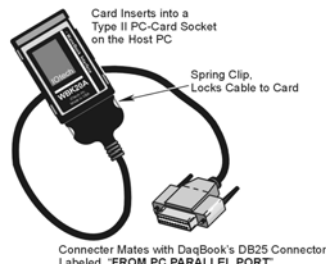

WBK20A Interface Card

If connecting your DaqBook to a desktop PC (with no available EPP port), you can use a WBK21 Interface card. Refer to separate instructions (supplied with the WBK21) if applicable.

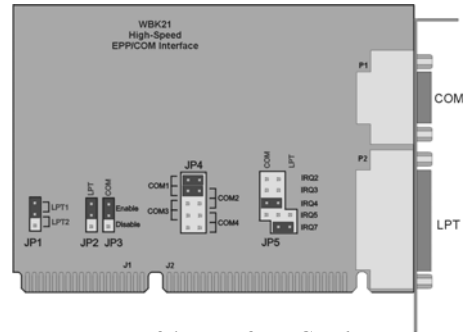

WBK21 Interface Card



Reference Note: It is possible to use a VDC power source other than an AC-to-DC adapter. Both the DBK Basics document module (included in this manual) and the DBK Option Cards and Modules User's Manual contain power-related information. The DBK manual is installed on your hard drive during software installation. The default location is the **Programs** directory.

(4) Install Software and Product Support Documentation

1. Remove previous version Daq drivers, if present. You can do this through Microsoft's **Add/Remove Programs** feature.
2. Place the Data Acquisition CD into the CD-ROM drive. *Wait for PC to auto-run the CD. This may take a few moments, depending on your PC.* If the CD does not auto-run, use the Desktop's Start/Run/Browse feature.
3. After the intro-screen appears, follow the screen prompts.

Upon completing the software installation, continue with step 5, *Test Hardware*.

(5) Test Hardware

- (a) Run the **Daq Configuration** control panel applet.
- (b) Click “**Add Device.**”
- (c) Select your DaqBook model from the “**Device Type**” scroll box and click **OK**.
- (d) Select your DaqBook from the “**Device Inventory**” window and click “**Properties.**”
- (e) Ensure settings are correct, and make changes if needed.
- (f) Select the **Test Hardware** tab.
- (g) Verify DaqBook has been properly installed and powered-on. Make sure the parallel port cable is firmly in place on both the DaqBook and the host PC’s LPT port.
- (h) Click the “**Resource Test**” button. This begins the test on DaqBook.
- (i) Click the **Test** button.

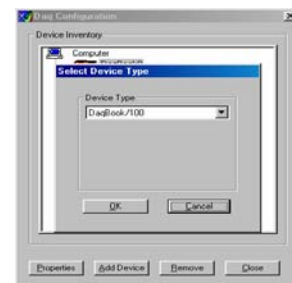

Device Type Window

Note: Testing the DaqBook device may, in some cases, cause the system to hang. If test results are not displayed in 30 seconds or the system does not seem to be responding, reboot the system. Upon power-up, re-enter the Daq Configuration and change the DaqBook configuration settings to those that work properly.

Test results have two components: **Resource Tests** and **Performance Tests**.

Resource Tests

Resource tests are intended to test system capability for the current device configuration. These tests are pass/fail. Resource test failure may indicate a lack of resource availability or a resource conflict.

- **Base Address Test** – Tests the base address for the selected parallel port. Failure of this test may indicate that the parallel port is not properly configured within the system. See relevant operating system and computer manufacturer’s documentation to correct the problem.
- **Interrupt Level Test** – Tests the ability of the parallel port to generate interrupts. Failure of this test may indicate that the parallel port may be currently unable to generate the necessary hardware interrupt, while other parallel port devices may work OK in this mode. Some parallel port devices (such as printers) do not require interrupts to work properly. See relevant operating system and computer manufacturer’s documentation to correct the problem.

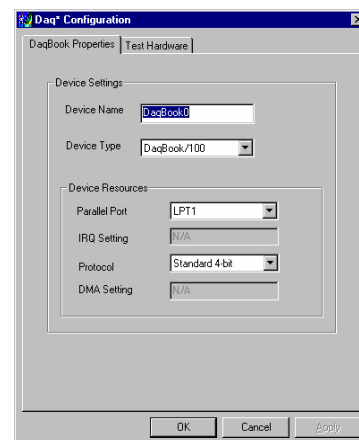

DaqBook Properties Tab

Performance Tests

Performance tests are intended to test various DaqBook functions with the current device configuration. These tests give quantitative results for each supported functional group. The results represent maximum rates at which the various operations can be performed. These rates depend on the selected parallel port protocol and will vary according to port hardware capabilities.

- **ADC FIFO Input Speed** – tests the maximum rate at which data can be transferred from the DaqBook’s internal ADC FIFO to computer memory through the parallel port. Results are given in samples/second, where a sample (2 bytes in length) represents a single A/D value.
- **Digital I/O Input Speed** – tests the maximum rate at which DIO input data can be transferred from the DaqBook’s Digital I/O ports to computer memory through the parallel port. Results are given in bytes/second.
- **Digital I/O Output Speed** – tests the maximum rate at which DIO output data can be transferred from the computer’s memory to the DaqBook’s Digital I/O ports through the parallel port. Results are given in bytes/second.



Test Hardware Tab

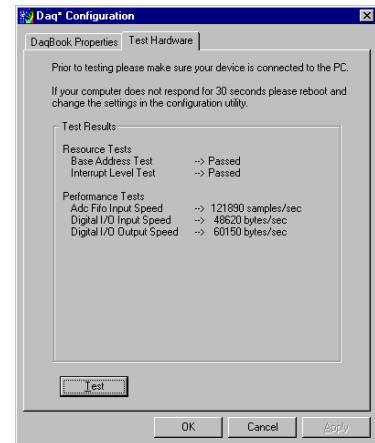

Test Results



Reference Note: If you experience difficulties, please refer to other sections of this manual and to the additional user documentation before calling technical support. User documentation is included on your data acquisition CD, and is installed automatically as a part of product support, when your software is installed. The default location is in the **Programs** directory.

Note that hardcopy versions of the manuals can be ordered from the factory.

- DaqBook/100,/112,/120,/200, and /2163-1**
 - In General 3-1
 - DaqBook Differences 3-1
 - Performance Factors 3-2
 - Front and Rear Panels3-2
 - Jumpers3-4
 - Connections3-7
- DaqBook/260 3-12**
 - Front and Rear Panels3-12
 - Hardware Setup3-13
- Stacking Hardware3-17**
 - Using Dual-Lock Tabs and Splice Plates 3-17
 - Using T-Cables3-18

DaqBook/100, /112, /120, /200, and /216

In General

DaqBooks consist of boards enclosed in a 8.5 × 11 × 1.375 inch metal chassis; with exception of the DaqBook/260, which is 11 × 13 × 3.5 inches. DaqBooks attach to a host PC's parallel port via a 25-wire parallel port cable and can transfer data bi-directionally at up to 170 Kbytes/s for a standard printer port (SPP) and up to 800 Kbytes/s for an enhanced parallel port (EPP). Data is stored in the PC's memory and hard drive, not in the DaqBook.

DaqBooks can be powered from a suitable AC-to-DC power adapter, a 12 V car battery, or a rechargeable NICAD battery module. This power flexibility is ideal for portable and remote data acquisition, such as automotive and aviation *in-vehicle* testing.

Output power from the DaqBook's P1 connector includes: +5 VDC via pin 1, +15 VDC via pin 21, and -15 VDC via pin 2.



Reference Notes:

The section, *External Analog Expansion Power (JP1)*, explains how to set JP1, based on power use in the system.

DaqBooks have capabilities which, at one time, could only be met by using several plug-in DAS boards. All DaqBooks provide 16 analog inputs, and can be expanded up to 256. In addition, each model has 2 analog outputs, and at least 4 digital I/O channels. Some models have built-in expansion slots; other models have additional digital I/O and counter/timer capabilities.

DaqBook Differences

While all DaqBook models are closely related, the following should be noted.

- DaqBook/112 and DaqBook/216 provide 1 slot for an expansion DBK card.
- DaqBook/100, DaqBook/120, and DaqBook/200 do not have an expansion slot, but do have 24 general-purpose digital I/O channels (expandable up to 192), 16 high-speed digital inputs, and 5 frequency/pulse I/O channels.
- DaqBook models /120, /200, and /260 have EPP (Enhanced Parallel Port) capability.
- DaqBook/260 has 3 expansion slots for DBK cards.
- DaqBook/100, DaqBook/112, and DaqBook/120 are 12-bit.
- DaqBook/200, DaqBook/216, and DaqBook/260 are 16-bit.

Performance Factors

DaqBooks are flexible when it comes to analog input capabilities. The A/D maximum sample rate is 100 kHz (divide by number of channels for scan rate) with a 16-channel multiplexer and a programmable-gain input amplifier. Users can expand channel capacity to 256 analog inputs via expansion modules for multiplexing RTDs, thermocouples, strain gages, anti-aliasing filters, and simultaneous sample and hold amplifiers.

Expansion cards and modules attach to the DaqBook's 37-pin P1 I/O connector.



Reference Note: *Connector Pinouts* begin on page 3-8.

The DaqBooks can perform 100 kHz scan sequences with programmable delays from 10 μ s to 10 hours. The 100 kHz conversion rate fixes the time skew between channels at 10 μ s. The 512-location scan sequencer allows selection of the input amplifier gain for each channel. DaqBook models /100, /120, /200, and /260 can each scan 16 digital inputs in the same sequence used for analog inputs; such inputs are thus time-correlated. Optional simultaneous-sample-and-hold (SSH) cards enable DaqBooks to instantaneously sample up to 256 channels. Scanning and timing specifications are met, even when a DaqBook system includes a full complement of expansion modules. All types of transducers are scanned within the same scan group, and with no intervention from the host PC.

DaqBooks offer a wide selection of triggering capabilities. Scans can be triggered by software, a TTL signal, or a level of analog input [including slope]. The analog input trigger is hardware-based and minimizes trigger latency to less than 10 μ s.

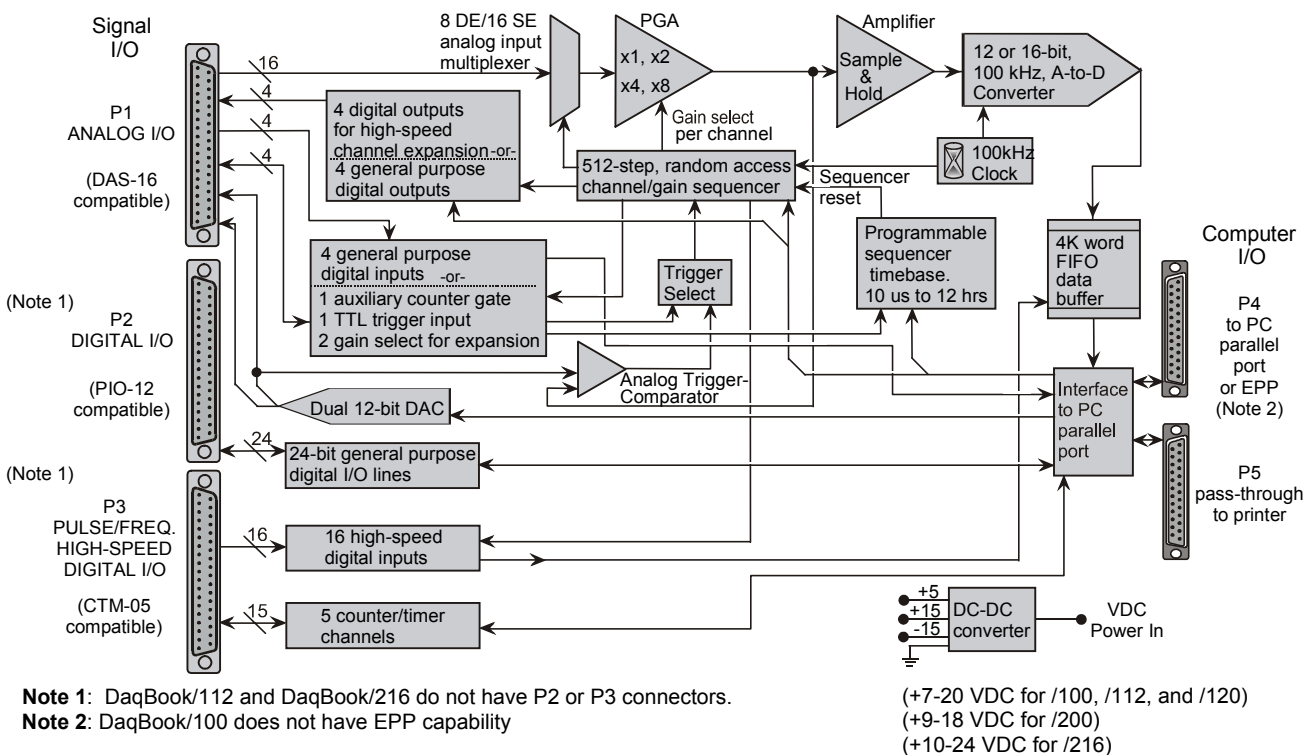

DaqBook Block Diagram



Reference Note: A separate block diagram for DaqBook/260 is presented on page 3-12.

Front and Rear Panels Excluding DaqBook/260

The following illustrations show the relative locations of connectors, power switches, indicator LEDs, and the expansion slot, as applicable. DaqBook/260 is treated separately in an upcoming section.



Reference Note:

DaqBook/260 users should refer to page 3-12 for information specific to that product.

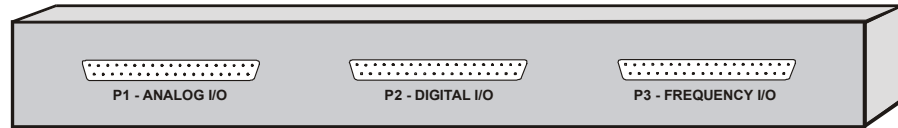

Front Panel of DaqBook/100/120/200

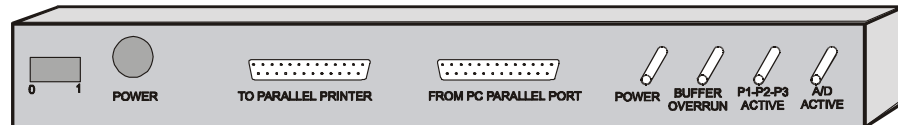

Rear Panel of DaqBook/100/120/200

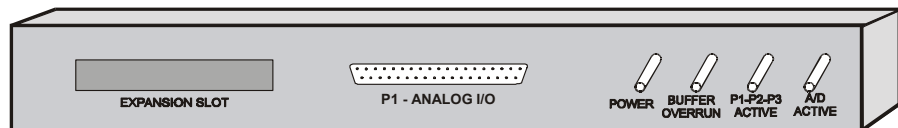

Front Panel of DaqBook/112/216

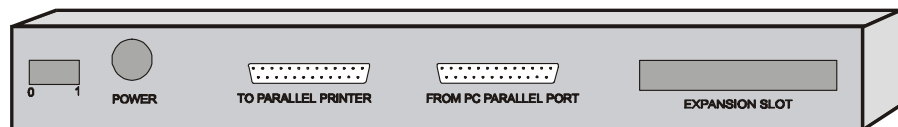

Rear Panel of DaqBook/112/216

DaqBook Controls and Connectors	
Switch	
POWER	Depressing the "1" side of this rocker-arm switch turns the power on.
Connectors	
POWER INPUT	This DIN5 input connector accepts +7 to 20 VDC for the /100, /112, /120; +10 to 24 VDC for the /216; +9 to 18 VDC for the /200, /260.
TO PARALLEL PRINTER	This port allows the computer to use any standard parallel printer in a pass-through mode (DB25).
FROM PC PARALLEL PORT	This port connects to the computer's standard or enhanced parallel port (DB25).
P1 - ANALOG I/O	Provides sixteen analog input channels, two analog output channels, two 16-bit counter/timers, four TTL inputs and outputs, and various signals for driving expansion cards (DB37).
P2 - DIGITAL I/O	Provides three 8-bit TTL programmable I/O ports and external interrupt input (DB37).
P3 - FREQUENCY I/O	Provides five 16-bit counters and sixteen high-speed digital inputs and external interrupt input (DB37).
Indicators	
POWER	This LED lights when power is applied to the DaqBook and the power switch is in the "1" (ON) position.
P1-P2-P3 ACTIVE	This LED lights when the DaqBook is in an active state. This LED is off when the DaqBook is disabled or in the printer-pass-through mode. P1, P2, and P3 are software accessible from the computer.
BUFFER OVERRUN	This LED lights for a buffer overrun error. This occurs when A/D signals are converted faster than the PC collects the data. Depending on the application, this indication may not be an error.
A/D ACTIVE	This LED lights during an A/D scan sequence. If the sequence has a low number of steps and occurs infrequently, this indicator will only flash briefly.

Jumpers

Proper installation requires that several jumpers and switches be set correctly for your application. These jumpers and switches are located inside the DaqBook enclosure and possibly on your DBKs. Jumpers for the various DaqBook models are configured similarly except for the jumpers' relative locations. Silk-screening on the motherboard identifies jumpers and switches. **Note:** Even if using the default settings, you should verify actual jumper positions.

The DaqBook configuration jumpers include:

- **JP1 - External Analog Expansion Power;** default is *Analog Option Card Use*
- **JP2 - DAC Voltage Reference;** default is *DAC0 and DAC1 internal reference with SSH*
- **JP3 - Unipolar/Bipolar;** default is *bipolar* (Note 1)
- **JP4 - Differential/Single Ended;** default is *single ended* (Note 1)
- **JP5 - Time Base;** default is *1 MHz*
- **JP6 - Watchdog Timer;** default is Watch Dog timer *disabled*
- **JP7 - Reserved for factory use.**

Note 1: DaqBook/200, DaqBook /216, and DaqBook /260 do not have JP3 and JP4 jumpers. For these products the related settings are made via software.

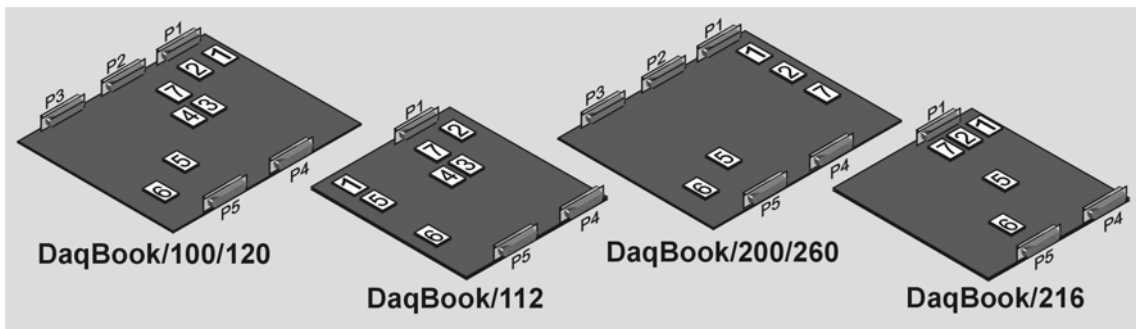

Location of DaqBook Jumpers

External Analog Expansion Power (JP1)

This 4×2 header (JP1) has 3 possible settings. If analog option cards (DBKs) are used, the JP1 pins are set to provide +15 and -15 VDC to the cards. If such cards are not used, the counter/timer CTR0 is available, and JP1 must be set accordingly. The default setting is for use of analog option cards.

CAUTION	
	<p>If using a DBK32A Auxiliary Power Supply or a DBK33 Triple-Output Power Supply Card, the JP1 shunt jumpers must be entirely removed. Placing the jumpers on -OCTOUT and -OCLKIN will damage the 8254 timer chip.</p>

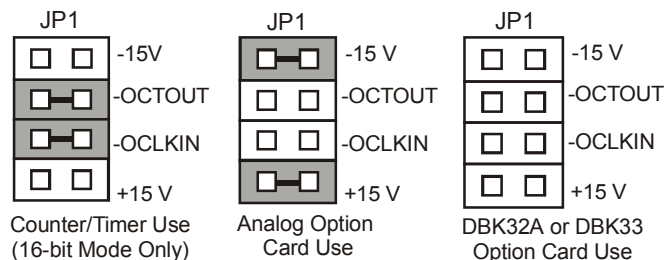

JP1 External Analog Expansion Settings



Reference Note:

The *Power Management* section of the *DBK Option Cards and Modules User's Manual* (p/n OMB-457-0905) contains additional power-related information. As a part of product support, this manual is automatically loaded onto your hard drive during software installation. The default location is the **Programs** directory, which can be accessed through the Windows Desktop.

DAC Reference Selection (JP2)

This 5x2 header (JP2) allows you to select internal or external voltage references for the two separate analog outputs. If the internal -5 VDC reference is selected, either DAC can output from 0 to +5 VDC as the register count varies from 0 to 4095 (12-bit). If an external voltage reference is desired (up to +10 VDC or -10 VDC), the shunt jumpers must be set accordingly. There is also a provision to allow the outputting of a simultaneous Sample-Hold command signal on the DAC1-REFIN pin with the DAC1 set up for an internal reference.

CAUTION



The SSH setting cannot be used at the same time as a DAC1 external reference due to a potentially damaging conflict on P1 pin #26. The defaults are both DAC0 and DAC1 set to Internal Reference.

Note: The SSH setting is used with DBK2, DBK4, DBK5, DBK7, DBK17, DBK50, and DBK51. Refer to the DBK options manual (p/n 457-0905) as needed.

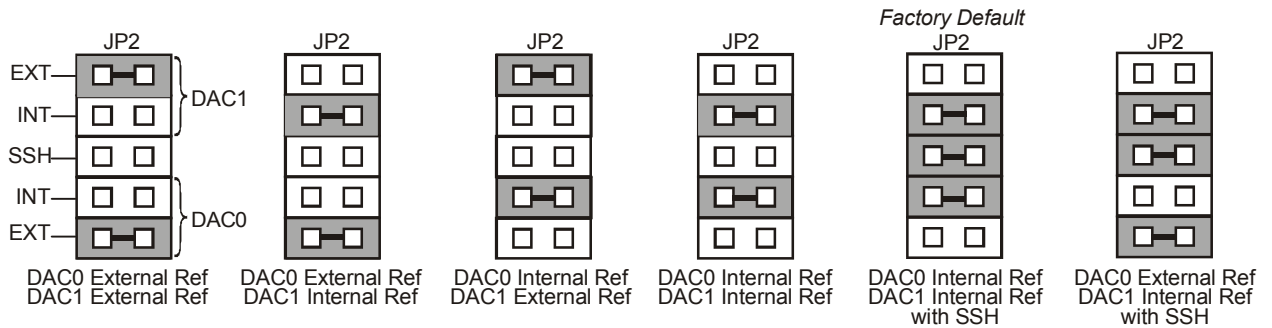

Bipolar or Unipolar A/D Operation (JP3)*

*Hardware Setting For DaqBook/100, DaqBook /112, and DaqBook /120 Only

The A/D converter in the DaqBook can be operated in two modes, bipolar or unipolar. In the bipolar mode (default setting), input voltages up to ± 5 VDC can be applied (on the $\times 1$ gain range). In the unipolar mode, positive voltages up to 10 VDC may be applied ($\times 1$ gain range). Refer to the table below for gain, range, and mode relations.

CAUTION	
	JP3 is a double-wide jumper that must be positioned vertically. Misplacing this jumper in a horizontal position will damage the unit.

Gain	Mode	Volts Range
$\times 1$	BI	± 5
$\times 2$	BI	± 2.5
$\times 4$	BI	± 1.25
$\times 8$	BI	± 0.625
$\times 1$	UNI	0 to +10
$\times 2$	UNI	0 to +5
$\times 4$	UNI	0 to +2.5
$\times 8$	UNI	0 to +1.25

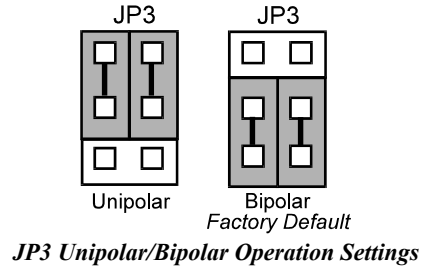

Note: For the DaqBook/100, /112, and /120, set the jumpers to the desired position as shown in figure.

Note: For the DaqBook/200, /216, and /260 the Unipolar/Bipolar option is selected via software by the `daq200SetMode` and `daq200SetScan` commands.

Single-ended or Differential Analog Input Channels (JP4)*

*Hardware Setting For DaqBook/100, /112, and /120 Only

CAUTION	
	JP4 must be positioned vertically. Positioning JP4 horizontally will damage the unit.

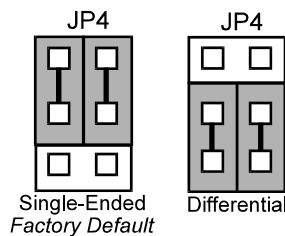

JP4 Single-Ended/Differential Settings

JP4 is a 3×2 header used to configure the 16 analog input lines as 16 single-ended channels or as 8 pairs of differential channels. In general, if the DaqBook is going to be used in the stand-alone mode (no analog expansion cards), either mode can be used. If analog expansion cards (each DBK capable of sixteen single-ended or differential inputs) are used, the single-ended mode must be used. The default setting is thus single-ended. Place the jumpers in the desired position (see previous figure).

Note: For the DaqBook/200, /216, and /260, the Unipolar/Bipolar option is selected via software by the `daq200SetMode` and `daq200SetScan` commands.

Time Base Selection (JP5)

JP5 is a 2×3 header that allows you to apply 1 of 3 oscillator-derived frequencies to the 8254 timer chip. The frequencies are 100 kHz, 1 MHz, and 10 MHz. The default setting is 1 MHz.

Note: A special-version 8254 timer-chip is required for 10 MHz. DaqView and most 3rd party software assume the 1 MHz time base.

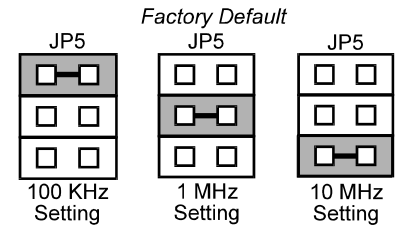

JP5 Time Base Settings

Watchdog Timer Enable/Disable (JP6)

This 3-pin header (JP6) allows the elective use of the watchdog timer. The watchdog timer is used to assure consistent operation of the pass-through printer port during data collection and to restore pass-through printing if the computer is reset. Enable the watchdog timer if you:

- Use a printer on the pass-through printer port
- Expect the computer to be suddenly reset during DaqBook operation
- Want the DaqBook to reset itself rather than having to manually toggle the DaqBook's power switch.

Place the shunt jumper in the desired position as shown in the figure. The default setting is Disabled.

Note: The watchdog timer can mistake a computer pause for a reset and then impede background measurements. For this reason, the watchdog timer should normally be disabled unless automatic restoration of pass-through printing is required.

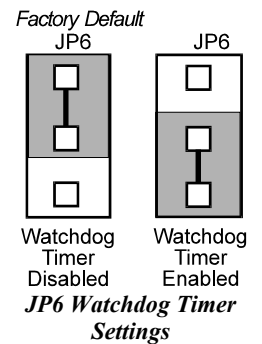

JP6 Watchdog Timer Settings

Connections

The DaqBook connects to the computer's DB25F parallel printer port with a DB25M to DB25F 1284 Compliant LPT cable. 2-foot and 6-foot length cables of this type can be ordered through the factory. The part numbers are CA-35-2 and CA-35-6, respectively.

Connect the male end to the computer and the female end to the DaqBook connector labeled FROM PC PARALLEL PORT. Any printer port (LPT1, LPT2, or LPT3) may be used but should be noted for software setup. When using a printer, attach the original printer cable (male DB25) into the DaqBook connector labeled TO PARALLEL PRINTER.

Note: Printing cannot occur during data acquisition.

The DaqBook may be powered with a supplied AC adapter that plugs into any standard AC wall outlet. An isolated VDC source of 1-2 amps may also be used. Power requirements are +7-20 VDC for the DaqBook/100/112/120, +10-24 VDC for the DaqBook/216, and +9-18 VDC for the DaqBook/200/260. Before plugging unit in, make sure the power switch is in the "0" (OFF) position.

- If using an AC power adapter, plug it into an AC outlet and attach the low voltage end to the jack on the DaqBook.
- If using another VDC source, make sure leads are connected to the proper DIN terminals.

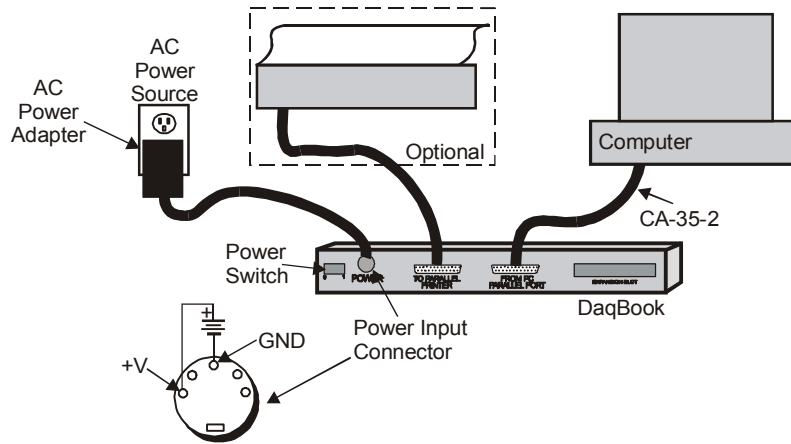

DaqBook Connections

To verify connections, turn ON the power switch by flipping the rocker- switch to the “1” position, and the POWER LED should light up. If using a printer, check operation by issuing a <PRINT SCREEN> or equivalent command.

Note: Software installation is necessary before the DaqBook can perform any functions.

Parallel Port Capabilities

The DaqBook/112, /120, /200, /216, and /260 (but not the /100) models can take advantage of enhanced parallel port (EPP) communication. Standard LPT ports on an IBM-compatible PC have 4-bit and 8-bit modes to read data from the printer port. The 8-bit mode is faster than the 4-bit, but not all printer ports support this mode. EPP ports are parallel ports with additional hardware that allows the DaqBook to communicate with the PC faster (3 to 10 times) than standard parallel ports.

EPPs require special hardware, and only certain computers are EPP-capable. Most laptop computers that use the Intel 386SL or 486SL chip set (which includes the 82360 I/O controller) are EPP-capable. For computers with plug-in card slots, EPP adapter cards are available. You may wish to consult your computer documentation for details about your machine and possible adapter cards. For more information about supported EPP hardware and machine-specific issues, refer to the README file supplied with the software.

Note: The EPPs may be configured for any available I/O address but must be configured for either interrupt 5 or 7. The DaqBook driver does not support the use of interrupts 10, 11, 12, or 15.

In addition to supporting the special hardware required for EPP capability, some computers and parallel port cards come equipped with special BIOS or device drivers which support the EPP BIOS Draft Revision 3 (and possible Draft Revision 5) standard. This standard specifies a software level interface between applications and the EPP hardware itself. The DaqBook/DaqBoard software driver supports computers and parallel ports equipped with EPP BIOS Draft Revision 3.

Connector Pinouts

To gain access to DaqBook port connectors, signals can be connected via a CA-37-x cable through a D-shell 37-pin female connector or a DBK11 screw-terminal card with component sockets. The following tables detail P1, P2, and P3 pinouts and how each line is used.

DaqBook

P1 Pinout

Analog I/O

(compatible with
Metrabyte DAS-16)

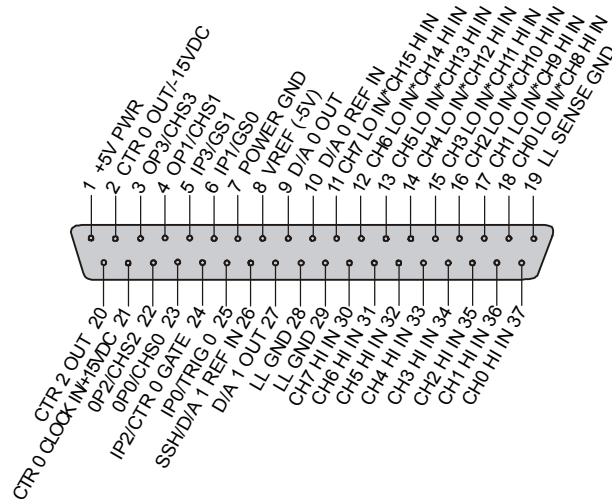

Pin	Signal Name	Description for P1 Pin Use	
1	+5 PWR	+5 V supply	see Note 1
2	CTR 0 OUT/-15 VDC	Counter 0 output (8254 chip)/ -15 V supply	see Note 1
3	OP 3/CHS 3	Digital out bit 3/channel select line for expansion cards	
4	OP 1/CHS 1	Digital out bit 1/channel select line for expansion cards	
5	IP 3/GS 1	Digital in bit 3/gain select line for expansion cards	
6	IP 1/GS 0	Digital in bit 1/gain select line for expansion cards	
7	POWER GND	Digital ground	
8	VREF (-5V)	-5 V supply @ 10 mA max	
9	D/A 0 OUT	Digital to analog converter output ch 0	
10	D/A 0 REF IN	Digital to analog converter reference in ch 0 (must invert)	
11	CH 7 LO IN/CH 15 HI IN	Ch 7 LO IN (differential mode)/ch 15 HI IN (single-ended mode)	
12	CH 6 LO IN/CH 14 HI IN	Ch 6 LO IN (differential mode)/ch 14 HI IN (single-ended mode)	
13	CH 5 LO IN/CH 13 HI IN	Ch 5 LO IN (differential mode)/ch 13 HI IN (single-ended mode)	
14	CH 4 LO IN/CH 12 HI IN	Ch 4 LO IN (differential mode)/ch 12 HI IN (single-ended mode)	
15	CH 3 LO IN/CH 11 HI IN	Ch 3 LO IN (differential mode)/ch 11 HI IN (single-ended mode)	
16	CH 2 LO IN/CH 10 HI IN	Ch 2 LO IN (differential mode)/ch 10 HI IN (single-ended mode)	
17	CH 1 LO IN/CH 9 HI IN	Ch 1 LO IN (differential mode)/ch 9 HI IN (single-ended mode)	
18	CH 0 LO IN/CH 8 HI IN	Ch 0 LO IN (differential mode)/ch 8 HI IN (single-ended mode)	
19	L.L. GND	Low-level ground (analog ground - use with analog inputs and outputs)	
20	CTR 2 OUT	Counter 2 output (8254 chip)	
21	CTR 0 CLOCK IN/+15 VDC	Counter 0 clock in (8254 chip)/+15 V supply	see Note 1
22	OP 2/CHS 2	Digital output bit 2/ channel select line for expansion cards	
23	OP 0/CHS 0	Digital output bit 0/channel select line for expansion cards	
24	IP 2/CTR 0 GATE	Digital input bit 2/counter 0 gate (16-bit support only)	
25	IP 0/TRIG 0	Digital input bit 0/trigger 0	
26	D/A 1 REF IN/SSH	Digital-to-analog converter reference in ch 1 (must invert)/ SSH	
27	D/A 1 OUT	Digital-to-analog converter output ch 1	
28	L.L. GND	Low-level ground (analog ground - use with analog inputs and outputs)	
29	L.L. GND	Low-level ground (analog ground - use with analog inputs and outputs)	
30	CH 7 HI IN	Ch 7 HI IN (single-ended mode or differential mode)	
31	CH 6 HI IN	Ch 6 HI IN (single-ended mode or differential mode)	
32	CH 5 HI IN	Ch 5 HI IN (single-ended mode or differential mode)	
33	CH 4 HI IN	Ch 4 HI IN (single-ended mode or differential mode)	
34	CH 3 HI IN	Ch 3 HI IN (single-ended mode or differential mode)	
35	CH 2 HI IN	Ch 2 HI IN (single-ended mode or differential mode)	
36	CH 1 HI IN	Ch 1 HI IN (single-ended mode or differential mode)	
37	CH 0 HI IN	Ch 0 HI IN (single-ended mode or differential mode)	

Note: Software configuration commands determine P1 digital I/O pin functions. Actual shunt-jumper placement is required to provide ± 15 VDC to expansion cards or disconnect internal DAC references to allow externally selected DAC references. Digital I/O cannot be used with DBKs. "I" indicates the pin can be used for either function but not both at the same time.

Note 1: Refer to the *Power Management* section in the DBK options manual (p/n OMB-457-0905).



Reference Note:

The *Power Management* section of the *DBK Option Cards and Modules User's Manual* (p/n OMB-457-0905) contains additional power-related information. As a part of product support, this manual is automatically loaded onto your hard drive during software installation. The default location is the Programs directory, which can be accessed through the Windows Desktop.

DaqBook

P2 Pinout

Digital I/O

This P2 interface is available on the DaqBook/100, /120, /200, and /260.

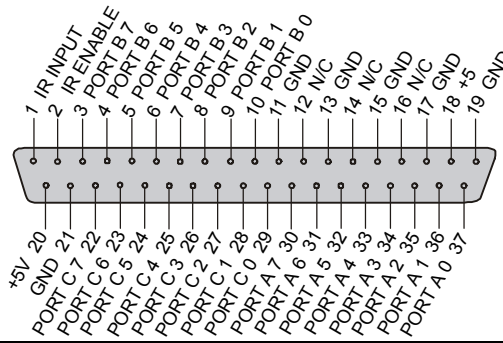

Pin	Signal Name	Description for P2 Pin Use
1	IR INPUT	Interrupt line input (no functions to access this)
2	IR ENABLE	Interrupt line enable (no functions to access this)
3	PORT B 7	Digital input/output - port B bit 7
4	PORT B 6	Digital input/output - port B bit 6
5	PORT B 5	Digital input/output - port B bit 5
6	PORT B 4	Digital input/output - port B bit 4
7	PORT B 3	Digital input/output - port B bit 3
8	PORT B 2	Digital input/output - port B bit 2
9	PORT B 1	Digital input/output - port B bit 1
10	PORT B 0	Digital input/output - port B bit 0
11	GND	Digital ground
12	N/C	Pin not connected/not used
13	GND	Digital ground
14	N/C	Pin not connected/not used
15	GND	Digital ground
16	N/C	Pin not connected/not used
17	GND	Digital ground
18	+5 V	+5 V supply see Note 1
19	GND	Digital ground
20	+5 V	+5 V supply see Note 1
21	GND	Digital ground
22	PORT C 7	Digital input/output - port C bit 7
23	PORT C 6	Digital input/output - port C bit 6
24	PORT C 5	Digital input/output - port C bit 5
25	PORT C 4	Digital input/output - port C bit 4
26	PORT C 3	Digital input/output - port C bit 3
27	PORT C 2	Digital input/output - port C bit 2
28	PORT C 1	Digital input/output - port C bit 1
29	PORT C 0	Digital input/output - port C bit 0
30	PORT A 7	Digital input/output - port A bit 7
31	PORT A 6	Digital input/output - port A bit 6
32	PORT A 5	Digital input/output - port A bit 5
33	PORT A 4	Digital input/output - port A bit 4
34	PORT A 3	Digital input/output - port A bit 3
35	PORT A 2	Digital input/output - port A bit 2
36	PORT A 1	Digital input/output - port A bit 1
37	PORT A 0	Digital input/output - port A bit 0

Note: No local lines are available if digital expansion cards are in use.



Note! P2 expansion cables must be kept short for proper operation. Do not exceed 14" per attached DBK card.

Note 1: Refer to the *Power Management* section in the DBK options manual (p/n OMB-457-0905).



Reference Note:

The *Power Management* section of the *DBK Option Cards and Modules User's Manual* (p/n OMB-457-0905) contains additional power-related information. As a part of product support, this manual is automatically loaded onto your hard drive during software installation. The default location is the Programs directory, which can be accessed through the Windows Desktop.

DaqBook

P3 Pinout

Pulse/Frequency/ High-Speed Digital I/O

This P3 interface is available on the DaqBook/100, /120, /200, and /260.

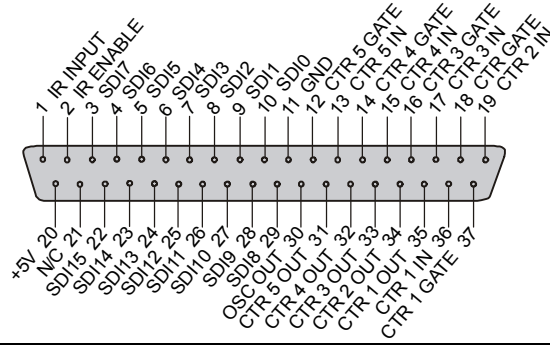

Pin	Signal Name	Description for P3 Pin Use
1	IR INPUT	Interrupt line input (used with counters)
2	IR ENABLE	Interrupt line enable (used with counters)
3	SDI 7	High-speed digital input bit 7 (low byte)
4	SDI 6	High-speed digital input bit 6 (low byte)
5	SDI 5	High-speed digital input bit 5 (low byte)
6	SDI 4	High-speed digital input bit 4 (low byte)
7	SDI 3	High-speed digital input bit 3 (low byte)
8	SDI 2	High-speed digital input bit 2 (low byte)
9	SDI 1	High-speed digital input bit 1 (low byte)
10	SDI 0	High-speed digital input bit 0 (low byte)
11	GND	Digital ground
12	CTR 5 GATE	Counter 5 gate (9513 chip)
13	CTR 5 IN	Counter 5 input (9513 chip)
14	CTR 4 GATE	Counter 4 gate (9513 chip)
15	CTR 4 IN	Counter 4 input (9513 chip)
16	CTR 3 GATE	Counter 3 gate (9513 chip)
17	CTR 3 IN	Counter 3 input (9513 chip)
18	CTR 2 GATE	Counter 2 gate (9513 chip)
19	CTR 2 IN	Counter 2 input (9513 chip)
20	+5 V	+5 V supply see Note 1
21	D IN STROBE	NC
22	SDI 15	High-speed digital input bit 15 (high byte)
23	SDI 14	High-speed digital input bit 14 (high byte)
24	SDI 13	High-speed digital input bit 13 (high byte)
25	SDI 12	High-speed digital input bit 12 (high byte)
26	SDI 11	High-speed digital input bit 11 (high byte)
27	SDI 10	High-speed digital input bit 10 (high byte)
28	SDI 9	High-speed digital input bit 9 (high byte)
29	SDI 8	High-speed digital input bit 8 (high byte)
30	OSC. OUT	Oscillator output - fout (9513 chip)
31	CTR 5 OUT	Counter 5 output (9513 chip)
32	CTR 4 OUT	Counter 4 output (9513 chip)
33	CTR 3 OUT	Counter 3 output (9513 chip)
34	CTR 2 OUT	Counter 2 output (9513 chip)
35	CTR 1 OUT	Counter 1 output (9513 chip)
36	CTR 1 IN	Counter 1 input (9513 chip)
37	CTR 1 GATE	Counter 1 gate (9513 chip)

Note 1: Refer to the *Power Management* section in the DBK options manual (p/n OMB-457-0905).



Reference Note:

The *Power Management* section of the *DBK Option Cards and Modules User's Manual* (p/n OMB-457-0905) contains additional power-related information. As a part of product support, this manual is automatically loaded onto your hard drive during software installation. The default location is the Programs directory, which can be accessed through the Windows Desktop.

DaqBook/260

The DaqBook/260 is a combination of a DaqBook/200 and a DBK60 expansion chassis. The DaqBook sits on an upper shelf within the enclosure. Below it, a card drawer can hold three analog DBK cards and provide termination panels with connectors for various sensors.

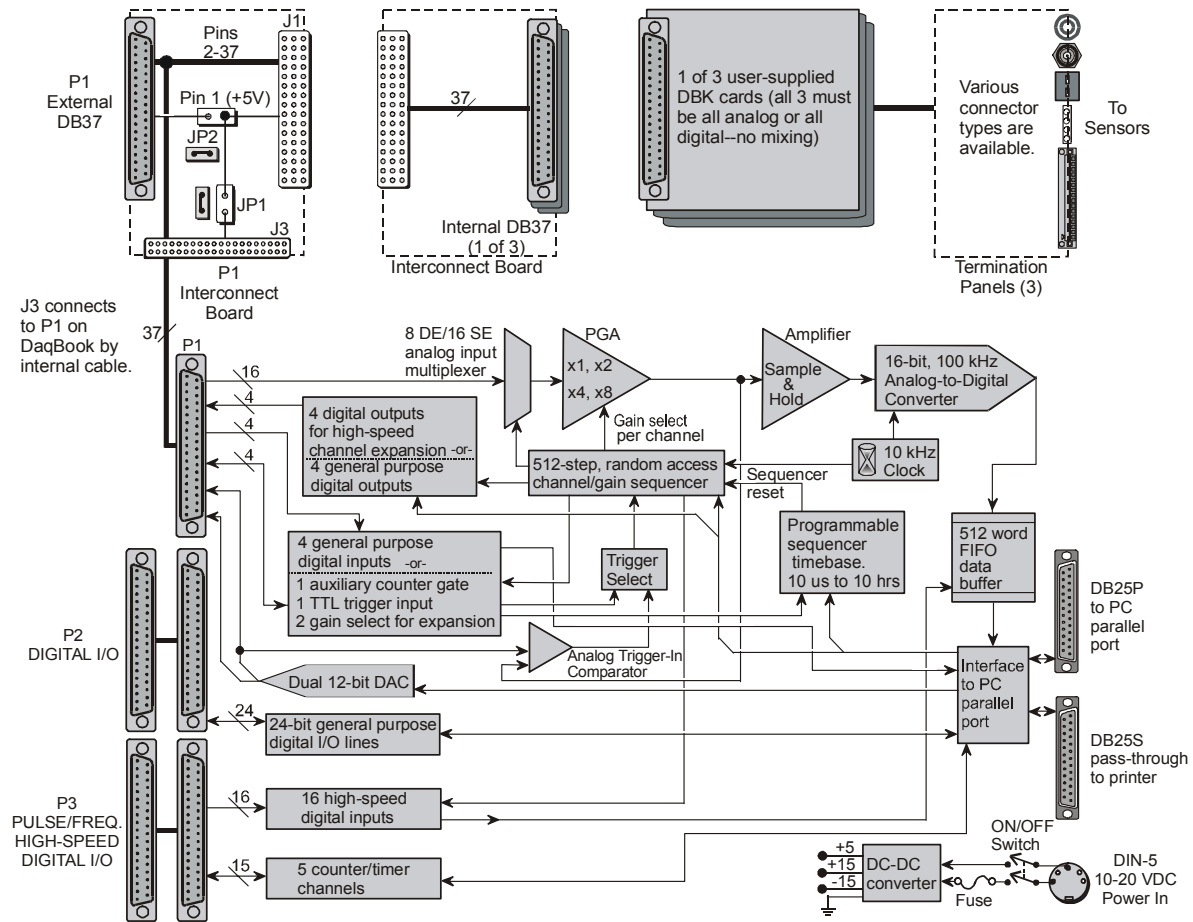

DaqBook/260 Block Diagram

Front and Rear Panels

The **front panel** has male DB37 connectors for system expansion via P1, P2, and P3. The DaqBook section includes a power switch, a DIN-5 connector for power-in, a DB25 connector for printer pass-through, a DB25 to the PC's parallel port, and LED status indicators for power, buffer overload, P1-P2-P3 active, and A/D active.

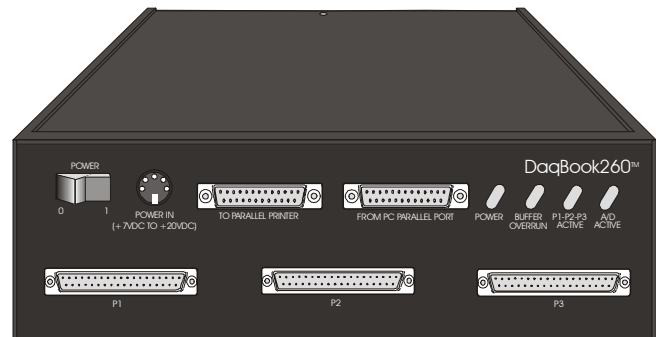

DaqBook/260 Front Panel

The rear panel is made of three termination panels with connectors for the various sensors.

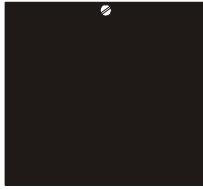

Blank Panel
DBK601

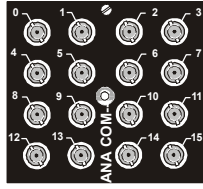

BNC Connectors
plus Analog Common
DBK602

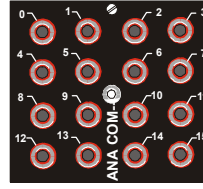

Safety Jacks, single-ended
plus Analog Common
DBK603

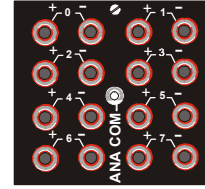

Safety Jacks, Differential
plus Analog Common
DBK604

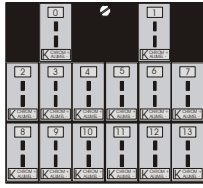

T/C Connectors, Differential
DBK605-B DBK605-R
DBK605-J DBK605-S
DBK605-K DBK605-T

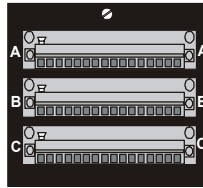

Terminal Blocks,
16 connections per block
(48 connections per panel)
DBK606

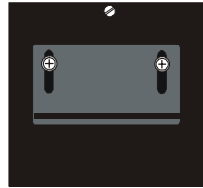

Strain Relief Clamp
DBK607

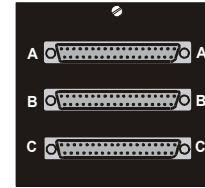

DB37 Connectors, Female
DBK608

Hardware Setup

WARNING



Electrical Shock Hazard! To avoid injury or equipment damage, turn off power to all connected equipment during setup.

CAUTION



Use ESD tools, containers, and procedures during setup of DBK cards. Electrostatic discharge can damage some of the components.



To prevent pin damage, align DBK cards with the backplane DB37 connectors before gently pressing them together.

1 – Turn off system power and disconnect DaqBook/260

If the DaqBook/260 is presently connected in a system, turn off all system devices and disconnect it.

2 – Remove top cover

Remove the two top cover screws and slide off the top cover.

3 – Remove card drawer

- A. Remove the two screws holding the card drawer to the chassis.
- B. Loosen the three captive thumbscrews holding the termination panels to the chassis.
- C. Using the handle, carefully slide out the card drawer.

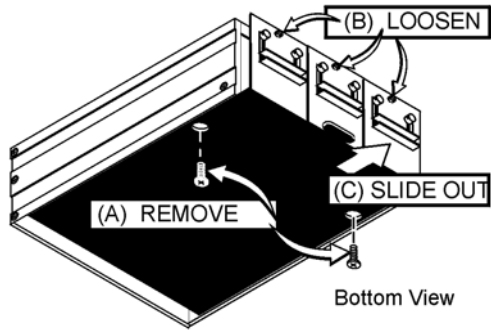

4 – Remove termination panels

Remove the two screws mounting each termination panel to the card drawer.

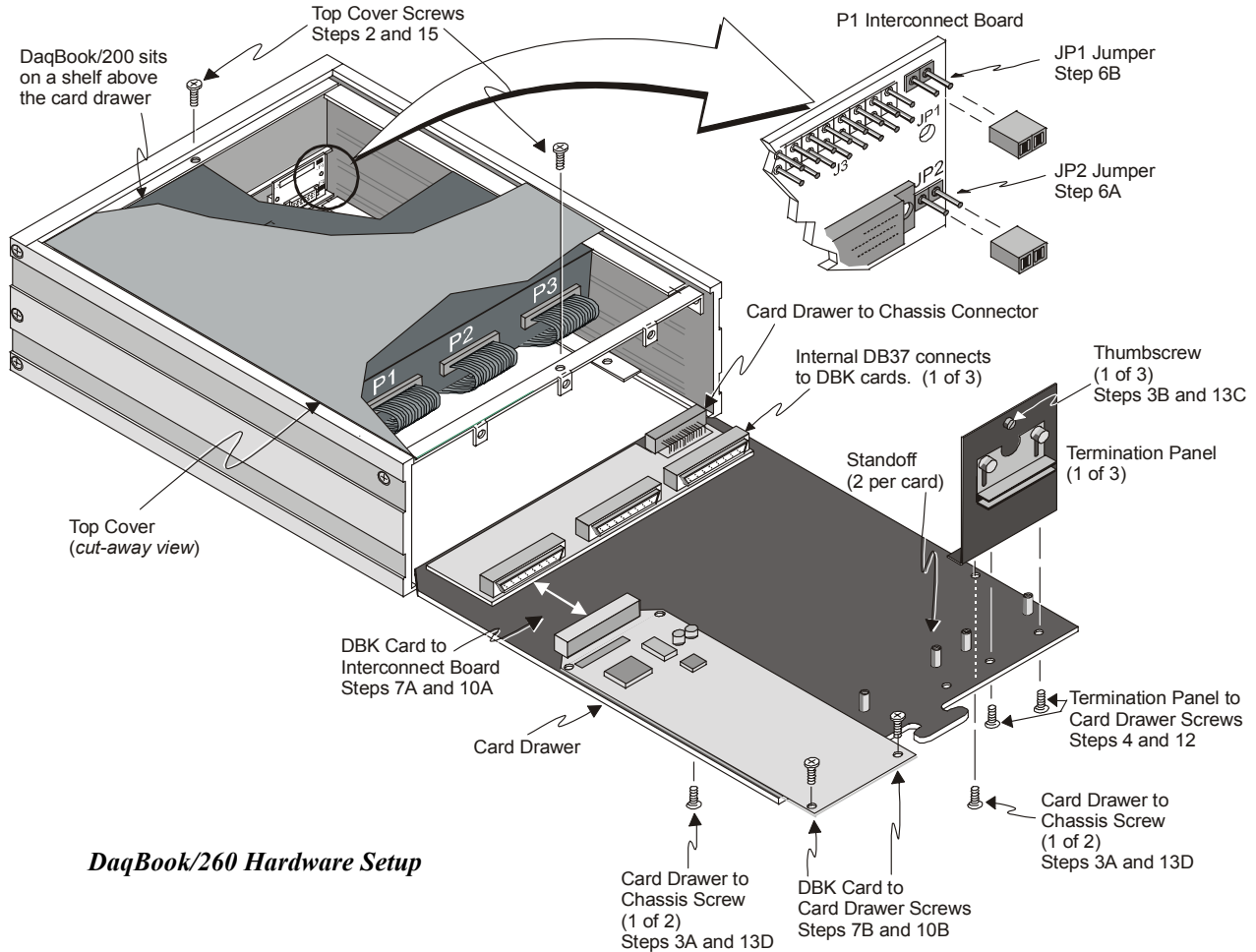

5 – Determine power requirements

Depending on the power needs of your system's DBK cards, you may need to add a power card.



Reference Note:

Both the *DBK Basics* section of this manual and the *Power Management* section of the *DBK Option Cards and Modules User's Manual* (p/n OMB-457-0905) contain power-related information. As a part of product support, the DBK manual is automatically loaded onto your hard drive during software installation. The default location is the **Programs** directory, which can be accessed through the Windows Desktop.

- A. Use the *DBK Power Requirements Worktable* to calculate the power requirements of your system's DBK cards.
- B. Use the *Available Power Chart* to determine your system's power availability.
- C. If the required power in step 5A is more than the available power in step 5B, you need an additional power card. There are two auxiliary power supply cards:
 - DBK32A – For use with a LogBook, DaqBook, or DaqBoard. It supplies ± 15 V.
 - DBK33 – For use with a Log Book, DaqBook, DaqBoard, or Daq PC-Card. It supplies +5 V and ± 15 V.



Reference Note:

Refer to the *DBK Option Cards and Modules User's Manual* (p/n OMB-457-0905) as needed. As a part of product support, the DBK manual is automatically loaded onto your hard drive during software installation. The default location is the **Programs** directory, which can be accessed through the Windows Desktop.

6 – Configure chassis for power sources

Avoid having more than one power source on the P1 bus. +5 V is controlled by the JP1 and JP2 on the P1 interconnect board. ± 15 V is controlled by the JP1 on the DaqBook/200 acquisition processor board.

- A. **JP2** on interconnect board – If +5 V will be supplied to DBK cards outside the chassis, install the JP2 jumper on the P1 interconnect board (see previous figure).
- B. **JP1** on interconnect board – If +5 V will be supplied to DBK cards inside the chassis, install the JP1 jumper on the P1 interconnect board (see previous figure).
- C. **JP1** on acquisition processor board – If using a DBK32A or DBK33 power card anywhere in the system, remove the +15 V/-15 V jumpers from JP1 on the DaqBook/200 acquisition processor board. Refer to *Hardware Setup* in the DBK32A or DBK33 section of the DBK options manual.

7 – Install a power card, if necessary

If you determined in step 5 that additional power is needed, add a DBK32A or DBK33 power card to the chassis.

- A. Carefully align the power card's DB37 connector with a DB37 connector on the interconnect board and gently press them together.
- B. Mount the power card with two screws into the standoffs on the card drawer.

8 – Configure DaqBook/260

If a DaqBook/260 driver is not available in software, select DaqBook/200.

9 – Configure DBK cards

Configure unique channel addresses with the jumpers on the DBK cards. Some cards have other jumpers and/or DIP switches. Refer to the DBK options manual (p/n 457-0905) as needed.

10 – Install DBK cards



You must use all analog DBK cards in the DaqBook/260; or all digital DBK cards providing that a factory modification is made to do so. At no time can you mix analog and digital cards in a DaqBook/260.

- A. Carefully align the DBK card's DB37 connector with a DB37 connector on the interconnect board and gently press them together (see previous figure).
- B. Mount the DBK card with two screws into the standoffs on the card drawer.
- C. Continue installation of any remaining DBK cards.

11 – Connect internal signals

Connect signal inputs from DBK cards to termination panels. DBK cards connect to the termination panels in various ways (see the following figure). Refer to the DBK options manual (p/n 457-0905) as needed.

- Single-ended connections use analog common.
- Differential connections require the proper polarity, typically red-to-red for high (+) and black-to-black for low (-).
- For thermocouples, red is generally the low side, and the T/C connector and wire type must match the thermocouple type used.

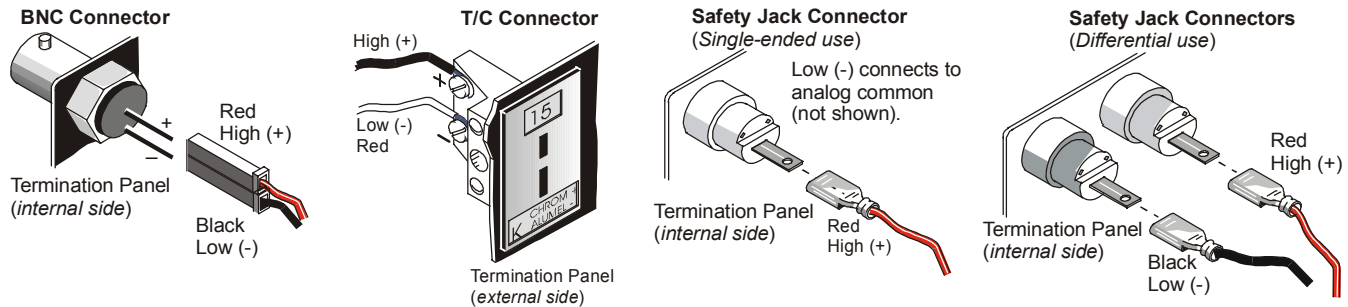

Connection Types

12 – Install termination panels

Mount the termination panels to the card drawer with two screws for each panel.

13 – Install card drawer

The card drawer slides into the bottom track of the chassis.

- Hold the card drawer by its handle and tilt it up slightly. Place it on the bottom track of the chassis.
- Carefully slide the card drawer into the chassis. When it engages the bottom track, level the card drawer and continue inserting it until it engages with the P1 interconnect board.
- Tighten the three captive thumbscrews holding the termination panels to the chassis.
- Install the two screws holding the card drawer to the chassis.

14 – Connect external signals

Connect signal inputs from sensors to termination panels.

15 – Install top cover

Slide on the top cover and install the two top cover screws.

16 – Turn on system power and check operation

Stacking Hardware

Using Dual-Lock Tabs and Splice Plates

For systems that make use of several data acquisition modules, stacking units together conserves space and simplifies cable runs. Such stacking can be facilitated with dual-lock tabs or splice plates.

- **Dual-lock tabs.** Dual-lock tabs, often referred to as Velcro,[®] provide a means of temporarily stacking modules together. The tabs provide a convenient way to quickly add modules to [or remove modules from] a system. Dual-lock tabs are often used to attach a notebook PC to a module.
- **Splice Plate Kits.** Optional Splice Plate Kits are available through the factory. The kits include metal plates that screw into the sides of modules to form a vertical rack of two or more modules. This method allows the “enclosure” to size itself as needed rather than wasting space in a *1-size-fits-all* type of enclosure. A handle can be attached to the plate for convenience in portable applications.

Note that even when splice plates are used, dual-lock tabs are typically used to attach a notebook PC to the top-level acquisition module.

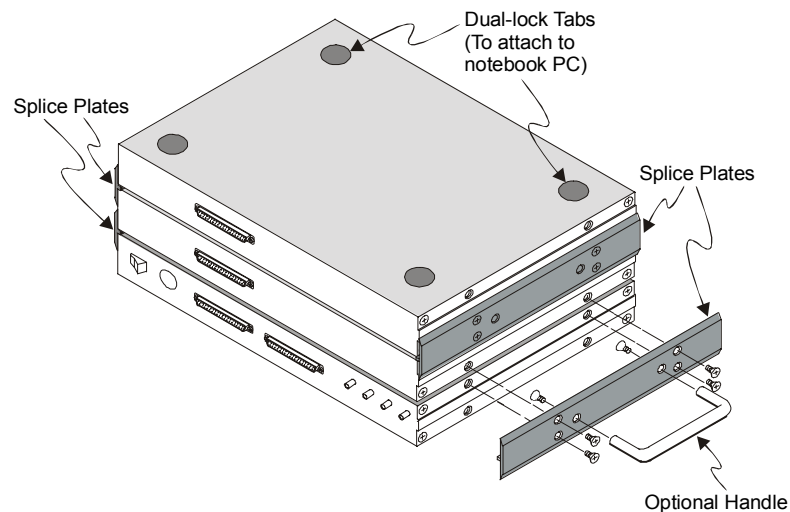

Stacking Data Acquisition Modules

Using T-Cables

CAUTION



Turn power OFF to the Daq devices and externally connected equipment while connecting cables and setting configuration jumpers and switches or before opening the lid. Electrical shock or damage to equipment can result even under low-voltage conditions.

T-Cables are available in different lengths and can be used for linking two or more compatible devices together via the device's 37-pin digital I/O connectors.

The bottom-end of the T-Cable is a dual-connector, consisting of both a female connector, and a 37-pin (male) connector. As seen in the following illustration, the T-Cable's 37-pin (male) connector can be used for "Daisy-Chain" applications.

Each T-Cable comes with three sets of screws. These are designated (in the diagram) as: short, medium, and long. Use the short screws to secure the single, female-end of the cable to the device; and use the medium length screws to secure a cable's "dual-end" connector. Use the long screws for daisy-chain applications (when you are connecting one T-Cable to another T-Cable).



Tighten screws snug only; do not over-tighten!

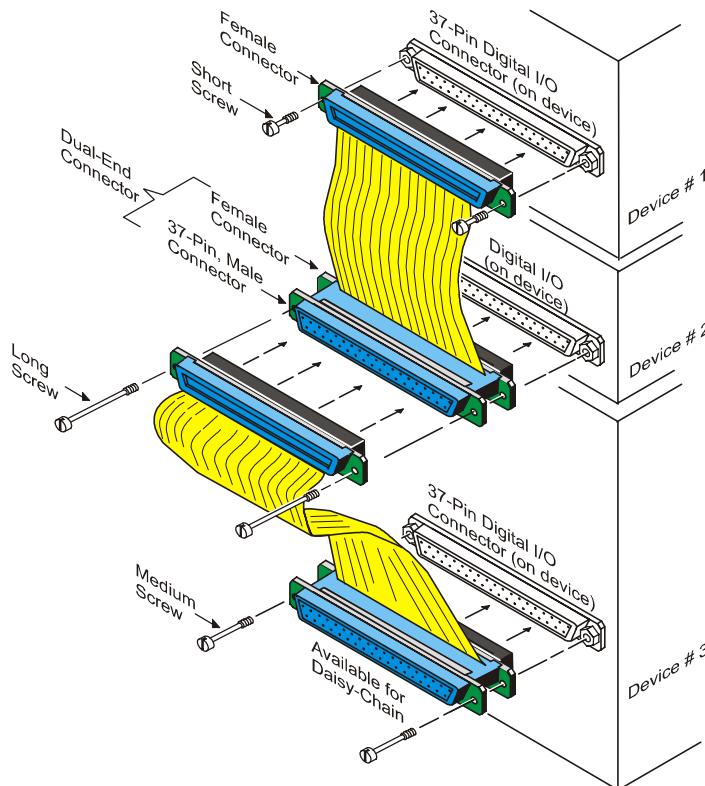

Daisy-Chain Example, Using two T-Cables

DBK Basics

Introduction..... 1
How Do DBKs Connect to the Data Acquisition Device? 2
DBK Identification Tables 3
 Analog Output DBKs 3
 Digital I/O Control DBKs 3
 Analog Signal Conditioning DBKs 3
 Expansion and Terminal Panel Connection DBKs 4
 Power Supply DBKs 4
Tips on Setting up a Data Acquisition System 4
Power Supplies and Power Connectors6
An Introduction to Power-Related DBKs 7
Calculating Your System's Power Needs 9
Additional Reading 11

CAUTION



Turn off power to all devices connected to the system before connecting cables or setting configuration jumpers and switches. Electrical shock or damage to equipment can result even under low-voltage conditions.

CAUTION



The discharge of static electricity can damage some electronic components. Semiconductor devices are especially susceptible to ESD damage. You should always handle components carefully, and you should never touch connector pins or circuit components unless you are following ESD guidelines in an appropriate ESD controlled area. Such guidelines include the use of properly grounded mats and wrist straps, ESD bags and cartons, and related procedures.

Introduction

The term “DBK” typically refers to a card or module that is used to expand or enhance a primary data acquisition device, such as a DaqBook, DaqBoard, or LogBook. As will be seen in the upcoming DBK identification tables, DBKs provide a wide variety of data acquisition functions. Depending on the DBKs used, one or more of the following can be realized:

- signal conditioning
- analog output
- digital I/O
- channel expansion
- supplying powering to another acquisition device
- providing an interface for different connectivity.



Reference Notes: During software installation, Adobe® PDF versions of user manuals will automatically install onto your hard drive as a part of product support. The default location is in the **Programs** directory, which can be accessed from the *Windows Desktop*. Refer to the PDF documentation, especially the *DBK Option Cards and Modules User's Manual* (p/n OMB-457-0905) for details regarding both hardware and software in relevant to DBKs.

A copy of the Adobe Acrobat Reader® is included on your CD. The Acrobat Reader provides a means of reading and printing the PDF documents. Note that hardcopy versions of the manuals can be ordered from the factory.

How Do DBKs Connect to the Data Acquisition Device?

Each DBK connects to the primary data acquisition device; e.g., a DaqBook, DaqBoard, or LogBook, through one of three 37-pin ports, which are designated as follows:

- P1 – Analog I/O
- P2 – Digital I/O
- P3 – Pulse/Frequency/High-Speed Digital I/O

Depending on the primary data acquisition device, connectivity issues differ slightly. This will be made clear by the figures and accompanying text that follow.

For DaqBooks, ISA-Type DaqBoards, and LogBooks, DBK connections are not made directly to the port, but through a CA-37-x ribbon cable, where “x” indicates the number of expansion devices that can be connected. For example, in addition to providing a DB37 connector to interface with the primary data acquisition device, a CA-37-3 cable includes three additional DB37 connectors. These provide a means of adding three DBKs to one port. Use of a CA-37-16 cable will allow up to 16 DBKs to be added. The CA-37-x cable system is excellent for DaqBooks, LogBooks, and ISA-type DaqBoards.

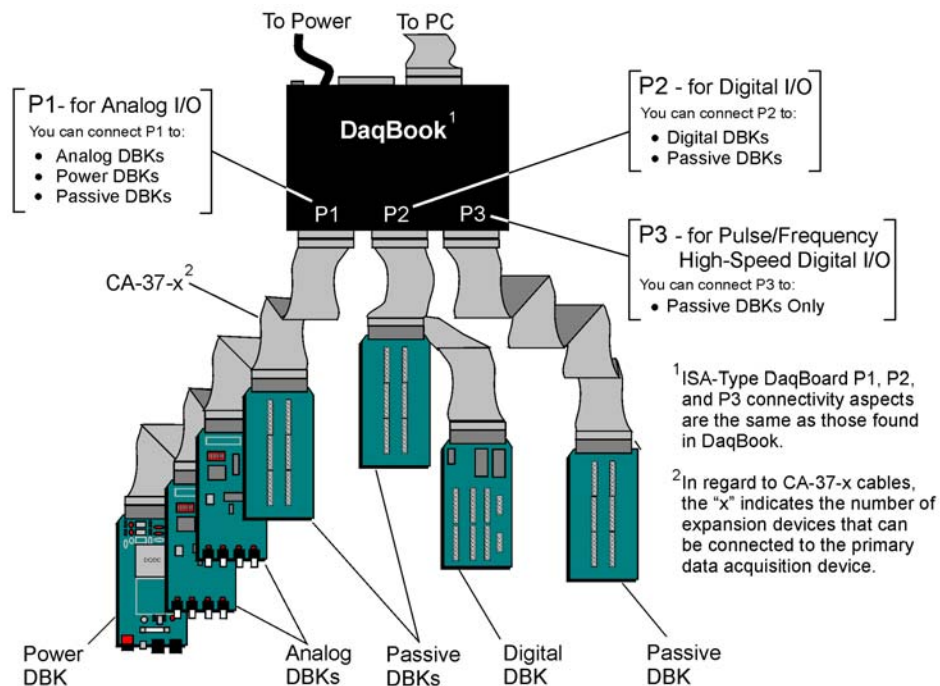

Connecting DBKs to a DaqBook

The above figure applies to LogBooks, DaqBooks, and ISA-type DaqBoards. As will be seen elsewhere in the documentation, some models do not include all three connectors (P1, P2, and P3).

DBK Identification Tables

Analog Output DBKs

Analog Output			
Product	Name/Description	I/O	Connectivity
DBK2	Voltage Output Card	4 channels	P1
DBK5	Current Output Card	4 channels	P1

Digital I/O Control DBKs

Digital I/O / Control			
Product	Name/Description	I/O	Connectivity
DBK20	General-Purpose Digital I/O Card (Screw Terminals)	48 channels	P2
DBK21	General-Purpose Digital I/O Card (DB37 Connectors)	48 channels	P2
DBK23	Optically Isolated Digital-Input Module	24 channels	P2
DBK24	Optically Isolated Digital-Output Module	24 channels	P2
DBK25	Relay Output Card	8 channels	P2

Analog Signal Conditioning DBKs

The DBKs that are used for analog signal conditioning attach to transducers and condition their outputs into analog voltages. An A/D converter, located in the primary acquisition device, measures the analog voltages. There are many signal-conditioning solutions available (and more are in development). Note that DBK high-capacity modules require more circuitry than can fit on a compact card.

Analog Signal Conditioning			
Product	Name/Description	I/O	Connectivity
DBK4	Dynamic Signal Input Card	2 channels	P1
DBK7	Frequency-to-Voltage Input Card	4 channels	P1
DBK8	High-Voltage Input Card	8 channels	P1
DBK9	RTD Measurement Card	8 channels	P1
DBK12	Low-Gain Analog Multiplexing Card	Note 2	16 channels
DBK13	High-Gain Analog Multiplexing Card	Note 2	16 channels
DBK15	Universal Current/Voltage Input Card	Note 2	16 channels
DBK16	Strain-Gage Measurement Card	2 channels	P1
DBK17	Simultaneous Sample & Hold Card	4 channels	P1
DBK18	Low-Pass Filter Card	4 channels	P1
DBK19	Thermocouple Card	Note 2	14 channels
DBK42	5B Isolated Signal-Conditioning Module	16 channels	P1
DBK43A	Strain-Gage Measurement Module	8 channels	P1
DBK44	5B Isolated Signal-Conditioning Card	2 channels	P1
DBK45	SSH and Low-Pass Filter Card	4 channels	P1
DBK50	Isolated High-Voltage Input Module	8 channels	P1
DBK51	Isolated Low-Voltage Input Module	8 channels	P1
DBK52	Thermocouple Input Module	Note 2	14 channels
DBK53	Low-Gain Analog Multiplexing Module	Note 2	16 channels
DBK54	High-Gain Analog Multiplexing Module	Note 2	16 channels
DBK80	Differential Voltage Input Card with Excitation Output	16 channels	P1
DBK81	Thermocouple Card, High-Accuracy	7 channels	P1
DBK82	Thermocouple Card, High-Accuracy	14 channels	P1
DBK83	Thermal Couple Card, High-Accuracy; uses Connection Pod	14 channels	POD-1
DBK84	Thermocouple Module, High-Accuracy	14 channels	P1

Expansion and Terminal Panel Connection DBKs

The following DBKs offer provide various expansion and connection options. The stackable 3-slot DBK10 low-profile enclosure can be used for up to three DBKs. If a system has more than 3 DBKs, the 10-slot DBK41 can be used. Several DBK41s can be daisy-chained to accommodate many DBKs in one system.

Expansion and Connection, General			
Product	Name/Description	I/O	Connectivity
DBK1	16-Connector BNC Adapter Module	16 connectors	P1
DBK10	3-Slot Expansion Chassis	3 cards	P1, P2, or P3
DBK11A	Screw-Terminal Option Card (DB37-Screw Terminal Block)	Component sockets	P1
DBK40	BNC Interface	18 connectors	P1 or P3
DBK41	Analog Expansion Enclosure	10 cards	P1 or P2
DBK60	Expansion Chassis with Termination Panels	3 cards	P2

Termination Panels, Connectivity for DaqBoard/260			
Product	Name/Description	I/O	Connectivity
DBK601	Termination Panel - blank rear panel	none	none
DBK602	Termination Panel - BNC rear panel	16 connectors	BNC
DBK603	Termination Panel - Safety Jacks, single ended	16 connectors	Safety Jacks
DBK604	Termination Panel - Safety Jacks, differential	8 differential (16)	Safety Jacks
DBK605	Termination Panels - Thermal Couple, differential panels; specify type: B, J, K, R, S, or T	16 differential	T/C Connectors
DBK606	Termination Panel – 3 Terminal Blocks; 16 connections per TB	48 connectors	Screw Terminal
DBK607	Termination Panel – strain relief clamp	none	none
DBK608	Termination Panel – 3 female DB37 connectors	three DB37	DB37

Power Supply DBKs

Power supply type DBKs are typically used in laboratory, automotive, and field applications. Input power can come from any +10 to +20 VDC source, or from an AC source by using an appropriately rated AC-to-DC adapter. The DBK30A rechargeable power supply can power DBK modules where AC mains are not available (the DBK30A outputs 28 V for powering transducers). For a large number of DBK cards, the DBK32A or DBK33 can be installed into an expansion slot. The DBK33 is used when +5 V is required in addition to ± 15 VDC. The DBK34 provides a steady 12 or 24 VDC while working with vehicle electrical systems that may be turned on or off during testing.

Power Supply		
Product	Name/Description	Power
DBK30A	Rechargeable Battery/Excitation Module	+12-14, 24-28 VDC (3.4 A-hr @ 14 VDC)
DBK32A	Auxiliary Power Supply Card	± 15 V @ 500 mA
DBK33	Triple-Output Power Supply Card	± 15 V @ 250 mA; +5 V @ 1 A
DBK34	Vehicle UPS Module	12/24 VDC (5 A-hr @ 12 VDC)
DBK34A	UPS Battery Module	12/24 VDC (5 A-hr @ 12 VDC)

Tips on Setting up a Data Acquisition System

A successful installation involves setting up equipment and setting software parameters. In addition to this manual, you may need to consult your Daq device or LogBook user's manual.

DBKs should be configured before connections are made and power is applied. This sequence can prevent equipment damage and will help ensure proper operation on startup. Many DBKs have on-board jumpers and/or DIP switches that are used for setting channels and other variables. You will need to refer to the individual DBK document modules to ensure that the DBKs are properly configured for you application.

Prior to designing or setting up a custom data acquisition system, you should review the following tips. After reviewing the material you can write out the steps to setup a system that will best meet your specific application needs.

1. The end use of the acquisition data should be used to determine how you set up and program your acquisition system. Prior to creating the system you should understand its layout and know how you are going to assign the channels. If you can answer the following questions you are off to a good start. If not, you need to find the answers.
 - What engineering units, ranges, sampling rates, etc. are best for your data?
 - Will the data be charted graphically, statistically processed, or exported to other programs?
 - How will the data be used?
 - How will the data be saved?
 - What are your system's power requirements? Using several DBKs or transducers that require excitation current may require an extra power supply, e.g., a DBK32A.
2. Assign channel numbers.
3. Plan the location of transducers, cable runs, DBKs, the acquisition device [LogBook or Daq device], and the computer. Label your transducers, cables, and connectors to prevent later confusion.
4. When configuring your LogBook or Daq device(s) consider the following:
 - LogBook calibration is typically performed automatically through LogView software; however, some DBKs may require manual calibration.
 - **The DaqBook and DaqBoard (ISA type) have internal jumpers and switches that you must set manually to match your application.**
 - Some DaqBook models are partially configured in software.
 - Daq PC-Cards are configured entirely in software.
 - You may need to refer to other documentation, such as Quick Starts, Installation Guides, User's Manuals, and pertinent DBK document modules.
5. Perform all hardware configurations before connecting signal and power. Remember to configure all the DBK cards and modules for your application. Several jumpers and DIP switches may need to be set (channel, gain, filters, signal mode, etc).
6. Setting up channel parameters often requires both hardware and software setup.
7. Route and connect all signal and power cables while all power is turned OFF.
8. To minimize electrical noise, route all signal lines away from any RF or high-voltage devices.
9. Follow your device's specific installation instructions. For certain devices software should be installed first; for others, hardware should be installed prior to software installation.
10. **After software is loaded, remember to set the software parameters as needed for your application. The software must recognize all the hardware in the system. Measurement units and ranges should be checked to verify that they meet your application requirements.**
11. Remember to set all channels to the proper mode for your DBK or other signal source.
12. After your system is up and running, verify proper data acquisition and data storage.
13. Verify system accuracy; adjust ranges or calibrate as needed.
14. Device specific information regarding system setup and expansion can be found in the Daq and LogBook User's manuals; and in the applicable DBK document modules of this manual.

15. **If you are considering system expansion**, review the DBK10, DBK41, and DBK60 document modules. The best option depends on the number of DBK cards in your system. For just a few cards, use the stackable 3-slot DBK10 low-profile expansion enclosure. For more than six cards, use the 10-slot DBK41. DBK41s can be daisy-chained to one-another to handle a large number of DBKs.
16. **In regard to power management**, you should review the DBK30A, DBK32A, and DBK33 document modules. For portable applications, the compact DBK30A rechargeable power supply can provide power to the DBK10 or DBK41. The DBK30A also includes a 28 V output for powering 4 to 20 mA transducers. For applications with many DBK cards (initially or in future expansion), the DBK32A or DBK33 can be installed into any expansion slot. The DBK32A provides ± 15 VDC and the DBK33 provides ± 15 VDC and $+5$ VDC.

Power Supplies and Connectors



Power supplies convert the raw power they receive into a lower DC voltage and/or current for use by devices with various power demands. Many of the power supplies that are used to power data acquisition equipment are of the *switching-mode* type. These devices provide a regulated output whether the power supply's input is, for example, 60 Hz, 120 VAC as in the United States or, 50 Hz, 220 VAC as found in European countries. Small power supplies, that do not switch, consist of simple transformer/rectifiers and filtered capacitors; and operate over a smaller voltage range.

LogBooks - The switching-mode power supply commonly used with LogBook systems uses an input range of 100 VAC to 240 VAC at 50 Hz to 60 Hz. The power supply's output [to the LogBook] is 15 VDC @ 2.7 amps via a DIN5 connector.

DaqBooks - Power supplies that are used with DaqBooks are typically of the transformer/rectifier type. They supply the DaqBook with 15 VDC @ 900 mA via a DIN5 connector.

DBKs – The following table indicates the type of power supply that is typically used with certain DBKs.

15 VDC @ 2700 mA Switching-Mode Type Power Supply		15 VDC @ 900 mA Transformer/Rectifier Type, Unregulated Power Supply	
The DBKs in this column use up to 15 VDC @ 2700 mA. This <i>switching-mode</i> power supply receives power from a 100 to 240 VAC source, at 50 to 60 Hz, and converts it to the required value.		The DBKs in this column use up to 15 VDC @ 900 mA. This transformer/rectifier type power supply receives power from a 110 to 125 VAC source, at 60 Hz, and converts it to the required value.	
DBK	Description	DBK	Description
DBK32A	Auxiliary Power Supply Card	DBK23	Optically Isolated Digital-Input Module
DBK33	Triple-Output Power Supply Card	DBK24	Optically Isolated Digital-Output Module
DBK42	5B Isolated Signal Conditioning Module	DBK43A	Strain Gage Measurement Module
		DBK50	Isolated High-Voltage Input Module
		DBK51	Isolated Low-Voltage Input Module

The DIN5 is the system's basic power connector (see the following figure). The CA-115 is a 6-in. cable with a plug (male) DIN5 connector on both ends. The CA-115 is used to connect DBK32As [or DBK33s] in parallel when they are to be powered by the same power supply.

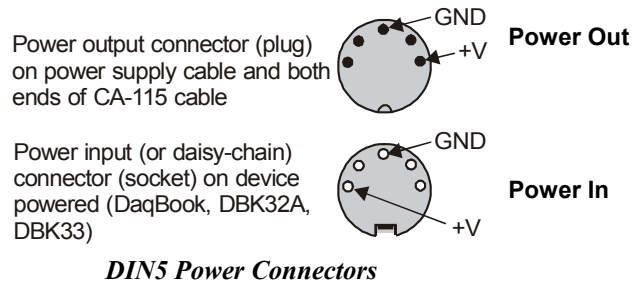

Note: DIN5 connectors for LogBook, DBK34, and DBK34A have threaded retaining rings.

Note: The following figure shows the pinout for the DBK34 and DBK34A Power Out DIN5 connector. The 28 V pin is only active when the device is in the 28 VDC mode; however, the 14 V pin is active regardless of the mode selected.

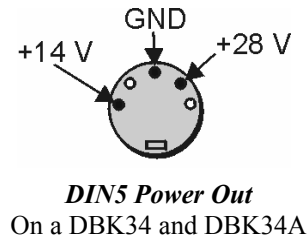

An Introduction to Power-Related DBKs

The power-related DBK options are the DBK30A, DBK32A, DBK33, DBK34, and DBK34A. From the standpoint of providing reliable power, these DBKs have proven convenient in laboratory, automotive, and field applications.

Input power for these devices can come from any 10 to 20 VDC source, or from an AC source via an appropriate AC-to-DC adapter.

A brief synopsis of the DBK power options follows. Refer to the respective document modules for complete information.



DBK30A module - provides power at 14 and 28 VDC with a rated capacity of 3.4 A-hr @ 14 VDC.

The DBK30A's 28 V output will power 4 to 20 mA transducers. The module's rechargeable power supply can power DBK modules in situations where AC mains are not available.

Note: Some transducers (e.g., 2-wire 4-20 mA transmitters, bridge-configured sensors, etc) require an excitation voltage in order to work properly. The DBK30A supplies 14 and 28 VDC. Consult transducer documentation before applying power.

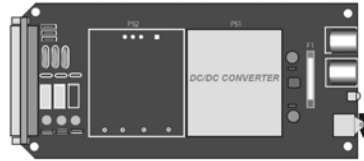
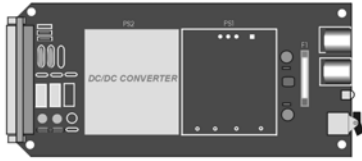

DBK32A - provides ± 15 VDC @ 500 mA. **DBK33** - provides ± 15 VDC @ 250 mA and +5 VDC @ 1000 mA.

The DBK32A and DBK33 power cards attach directly to the P1 analog expansion bus where they supply power to DBK analog expansion cards. The DBK32A and the DBK33 can be powered from an included AC adapter, an optional DBK30A battery module, or from a +10 to +20 VDC source such as a car battery.

When installed in a DBK10 three-slot expansion chassis, the DBK32A or DBK33 supplies power to the analog DBK [that is to receive power] via a CA-37-x cable.

If used with the DBK41 ten-slot expansion enclosure, the DBK32A or DBK33 installs into one of the analog expansion slots on the DBK41's backplane. A power card in any DBK41 slot (other than the leftmost, when viewed from the rear) will power the other cards that are connected to the DBK41's backplane.

CAUTION



If using a DBK32A or a DBK33 with a DaqBook or DaqBoard [ISA type], you must entirely remove the shunt jumpers from JP1. Failure to do so will result in damage to the 8254 timer chip. Refer to the power card document modules and to the *Daq device Hardware* sections of the DaqBook and DaqBoard [ISA] user's manuals for JP1 location and configuration.

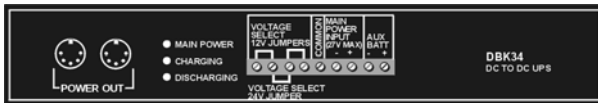

DBK34 module – provides 12 or 24 VDC with a 5.0 or 2.5 A-hr capacity (respectively). This module is an Uninterruptable Power Supply (UPS) that can be used for in-vehicle testing where the vehicle's electrical system will not affect acquisition device power during starter-current surge, or power-off.

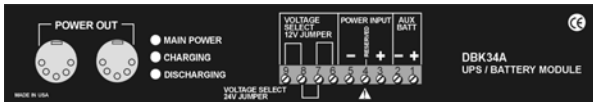

DBK34A module – provides 12 or 24 VDC with a 5.0 or 2.5 A-hr capacity (respectively). This device is classified as a UPS / Battery module. It is an improved version of the earlier DBK34. Like the DBK34, the DBK34A can be used for in-vehicle testing where the vehicle's electrical system will not affect acquisition device power during power during starter-current surge, or power-off.

Calculating Your System's Power Needs

Use the chart below and the worktable on the next page to ensure your system will have sufficient power. If the load (calculated in the worktable) exceeds available power (from the chart at the right), you must add a power card or a module such as a DBK32A or DBK33.

Available Power Chart—Supply	
Product	Available Power
LogBook	+5 VDC @ 0.10 A from P1-1, P2-18, P2-20, P3-20 +15 VDC @ 0.15 A from P1-21 +15 VDC @ 0.05 A from P3-19 -15 VDC @ 0.15 A from P1-2 -15 VDC @ 0.05 A from P3-37
DaqBook/100	2100 mW
DaqBook/112	2400 mW
DaqBook/120	2100 mW
DaqBook/200	4000 mW
DaqBook/216	4000 mW
DaqBook/260	4000 mW
DaqBoard/100A	3300 mW
DaqBoard/112A	3300 mW
DaqBoard/200A	3000 mW
DaqBoard/216A	3000 mW
DaqBoard/260A	3000 mW
DBK32	7500 mW
DBK32A	15000 mW
DBK33	7500 mW
DBK34	5 A-hr in 12 V mode; fused at 8 A
DBK34A	5 A-hr in 12 V mode; fused at 8 A

Use the following procedure and table to calculate the required system power.

1. In the Quantity column (5th), list the number of DBKs of that type in your system.
2. In the Sub Total column (7th), enter the product of column 5 and column 6 (mW).
3. Add the Sub Total column, and enter the sum at the bottom right of the table.
This result is your power requirement in mW.



DBK32, DBK32A, and DBK34 cannot supply +5 VDC.

In cases that require +5 VDC, if the +5 VDC requirement exceeds 500 mW from a LogBook or Daq device, then a DBK33 must be used. Note that DBK33 can supply 1000 mW at +5 VDC.

Note: The DBK34 has an 8 amp fuse, and has a capacity of 5 A-hr when in the 12V mode, and a capacity of 2.5 A-hr when in the 24V mode.

DBK Power Requirement Worktable—Demand						
DBK Options	Voltage Reference			Calculation		
	+15 VDC	-15 VDC	+5 VDC	Quantity	× mW	= Sub Total
DBK1	0	0	0		0	
DBK2	18 mA	18 mA	5 mA		565	
DBK4	95 mA	80 mA	25 mA		2750	
DBK5	2 mA	2 mA	15 mA		135	
DBK7	14 mA	8 mA	18 mA		420	
DBK8	15 mA	15 mA	<1 mA		455	
DBK9	21 mA	16 mA	<1 mA		560	
DBK11A	0	0	0		0	
DBK12	15 mA	15 mA	<1 mA		455	
DBK13	15 mA	15 mA	<1 mA		455	
DBK15	16 mA	16 mA	<1 mA		485	
DBK16	37 mA	32 mA	<1 mA		1040	
DBK17	30 mA	30 mA	<1 mA		905	
DBK18	36 mA	36 mA	<1 mA		1085	
DBK19	6 mA	7 mA	<1 mA		200	
DBK20	0	0	<10 mA		50	
DBK21	0	0	<10 mA		50	
DBK23***	0	0	<2 mA		10	
DBK24***	0	0	<2 mA		10	
DBK25	0	0	<2 mA		10	
DBK40	0	0	0		0	
DBK41	0	0	0		0	
DBK42	<1 mA	<1 mA	<1 mA		35	
DBK43A***	<1 mA	<1 mA	<1 mA		35	
DBK44	<1 mA	<1 mA	60 mA (Note 1)		330	
DBK45	52 mA	52 mA	<1 mA		1565	
DBK50***	<1 mA	<1 mA	<1 mA		35	
DBK51***	<1 mA	<1 mA	<1 mA		35	
DBK52	6 mA	7 mA	<1 mA		200	
DBK53	15 mA	15 mA	<1 mA		455	
DBK54	15 mA	15 mA	<1 mA		455	
DBK80	25 mA	25 mA	<1 mA		755	
DBK81	35 mA	35 mA	<2 mA		1060	
DBK82	60 mA	60 mA	<2 mA		1810	
DBK83	60 mA	60 mA	<2 mA		1810	
DBK84	60 mA	60 mA	<2 mA		1810	
Total Power Requirement in mW						
<p>Note 1: DBK44's 60 mA value is based on 30 mA for each of two 5B modules. This value will be higher if using 5B module 5B38 (200 mA for each 5B38), or if using 5B39 (170 mA for each 5B39). Refer to the DBK44 document module for more information.</p> <p>Note 2: DBK2 and DBK5 are not used with LogBook.</p> <p>*** Three asterisks indicate that the DBK is a module with internal power supply; powered separately.</p>						

Additional Reading

During software installation, Adobe® PDF versions of user manuals will automatically install onto your hard drive as a part of product support. The default location is in the **Programs** directory, which can be accessed from the *Windows Desktop*. Refer to the PDF documentation for details regarding both hardware and software.

A copy of the Adobe Acrobat Reader® is included on your CD. The Reader provides a means of reading and printing the PDF documents. Note that hardcopy versions of the manuals can be ordered from the factory.

You should refer to the following documents, as applicable, for acquisition system and programming information.

- DBK Option Cards and Modules User's Manual* (p/n OMB-457-0905)
- DaqBoard [ISA] User's Manual* (p/n OMB-457-0907)
- DaqBook User's Manual* (p/n OMB-457-0906)
- LogBook User's Manual* (p/n OMB-461-0901)
- Programmer's Manual* (p/n OMB-1008-0901)
- Post Acquisition Data Analysis User's Guide*

Of the above listed documents, the most relevant to the DBKs is the *DBK Option Cards and Modules User's Manual* (p/n OMB-457-0905). A synopsis of the contents follows:

- 1 – Introduction to DBKs.** Explains what DBKs are and uses tables to identify the various types of DBKs. The chapter includes tips for setting up a data acquisition system, discussions of signal management and signal conditioning, and CE compliance information.
 - 2 – Power Management.** Explains how to determine system power requirements and discusses various power options.
 - 3 – System Connections and Pinouts.** Provides instructions for connecting a DBK option to a Daq or LogBook device. Pinouts are included for the P1, P2, and P3 DB37 connectors.
 - 4 – DBK Set Up in DaqView.** Provides instruction for setting up analog and digital DBKs in *DaqView's Hardware Configuration* screen.
 - 5 – DBK Set Up in LogView.** Provides instruction for setting up analog and digital DBKs in *LogView's Hardware Configuration* window.
 - 6 – Troubleshooting.** Explains solutions to common noise, wiring, and configuration problems.
- DBK Document Modules** –Includes DBK-specific documentation for the card and module options listed on pages 3 and 4 of this document.



Notes

General

Power Consumption

DaqBook/100, & /120: 510 mA @ 12 VDC

DaqBook /112: 360 mA @ 12 VDC

DaqBook /200: 620 mA @ 12 VDC

DaqBook /216: 600 mA @ 12 VDC

DaqBook /260*: 620 mA @ 12 VDC

**(Does Not Include internal DBK options)*

Operating Temperature: 0° to 50°C

Storage Temperature: 0° to 70°C

Humidity: 0 to 95% RH, non-condensing

Dimensions: 285 mm W x 220 mm D x 35 mm H
(11" x 8.5" x 1.375")

Weight: 2.2 kg (5 lbs); DaqBook/260 (9 lbs)

A/D Specifications

Type: Successive approximation

Resolution

DaqBook/100, /112, & /120: 12 bit

DaqBook/200, /216, & /260: 16 bit

Conversion Time: 8 μ s

Monotonicity: No missing codes

Linearity: ± 1 bit

Zero Drift: ± 10 ppm/°C max

Gain Drift: ± 30 ppm/°C max

Sample & Hold Amplifier

Acquisition Time: 2 μ s

Aperture Uncertainty: 100 ps

Analog Inputs

for DaqBook/100, /112, & /120

Channels: 16 single-ended, 8 differential, expandable up to 256 differential; single-ended/differential operation is switch selectable per system

Connector: DB37 male, P1

Resolution: 12 bits

Accuracy: $\pm 0.1\%$ FS

Ranges

Unipolar/bipolar operation is switch selectable per system

Unipolar: 0 to +10V, 0 to +5V,

0 to +2.5V, 0 to +1.25V

Bipolar: ± 5 V, ± 2.5 V, ± 0.125 V, ± 0.625 V

Maximum Overvoltage: 30 VDC

Input Current

Differential: 150 pA typ; 0.2 μ A max

Single-Ended: 250 pA typ; 0.4 μ A max

Input Impedance: 100M Ohm in parallel with 100 pF

Gain Temp. Coefficient: 3 ppm/°C typ

Offset Temp. Coefficient: 12 μ V/°C max

Analog Inputs

for DaqBook/200, /216, & /260

Channels: 16 single-ended, 8 differential, expandable up to 256 differential; single-ended/differential operation is software programmable per system

Connector: DB37 male, P1

Resolution: 16 bits

Accuracy: $\pm 0.025\%$ FS

Ranges

Unipolar/bipolar operation is software programmable on a per-channel basis

Unipolar: 0 to +10V, 0 to +5V,

0 to +2.5V, 0 to +1.25V

Bipolar: ± 5 V, ± 2.5 V, ± 1.25 V, ± 0.625 V

Maximum Overvoltage: 30 VDC

Input Current

Differential: 150 pA typ; 0.2 μ A max

Single-Ended: 250 pA typ; 0.4 μ A max

Input Impedance: 100M Ohm in parallel with 100 pF

Gain Temp. Coefficient: 3 ppm/°C typ

Offset Temp. Coefficient: 12 μ V/°C max

Triggering

Analog Trigger

Programmable Level Range: 0 to ± 5 V

Trigger to A/D Latency: 10 μ s max

Digital Trigger

Logic Level Range: 0.8V low/2.2V high

Trigger to A/D Latency: 10 μ s max

Software Trigger

Trigger to A/D Latency: Dependent on PC

Pre-Trigger: Up to 65,536 scans

Sequencer

Randomly programmable for channel and gain; DaqBook/200 series is also randomly programmable for unipolar/bipolar ranges

Depth: 512 location

Channel to Channel Rate: 10 μ s/channel, fixed

Maximum Repeat Rate: 100 kHz

Minimum Repeat Rate: 10 hours

Expansion Channel Sample Rate:

Same as on-board channels, 10 μ s/channel

Specifications are continued on page A-3.

Note: Specifications are subject to change without notice.

This page is intentionally blank.

Analog Outputs

Channels: 2
Connector: DB37 male, P1
Resolution: 12 bits
Voltage Ranges: 0 to 5 VDC with built-in reference;
0 up to ± 10 VDC with external reference
Maximum Output Current: 10 mA

General Purpose Digital I/O for DaqBook/100, /120, /200, & /260

24 I/O channels, expandable up to 192
Connector: DB37 male, P2
Device: 82C55
Output Voltage Levels
Minimum "1" Voltage: 3.0 @ 2.5 mA sourcing
Maximum "0" Voltage: 0.4 @ 2.5 mA sinking
Output Current
Maximum Source Current: 2.5 mA
Maximum Sink Current: -2.5 mA
Input Voltage Levels
Minimum Required "1" Voltage Level: 2V
Maximum Allowed "0" Voltage Level: 0.8V
Output Float Leakage Current: 10 μ A

High-Speed Digital Inputs for DaqBook/100, /120, /200, & /260

16 input lines
Connector: DB37 male, P3
Maximum Sampling Rate: 100 Kwords/s
Input Low Voltage: 0.8V max
Input High Voltage: 2V min
Input Low Current: 10 nA
Input High Current: -10 μ A

Counter/Timer for DaqBook/100, /120, /200, & /260

5 counter/timer channels
Connector: DB37 male, P3
Frequency/Pulse Counting Mode:
Up or down, binary or BCD
Maximum Pulse Count: 80-bit binary
(5 channels cascaded)
Maximum Input Rate: 7 MHz
Minimum High Pulse Width: 70 ns
Minimum Low Pulse Width: 70 ns
On-board Time Base: 1 MHz

Cable Information	Part No.
DB25 male to DB25 female parallel cable, 2 ft.	CA-35-2
DB25 male to DB25 female parallel cable, 6 ft.	CA-35-6
DBK expansion cable from DaqBook to DBK modules; 2.5 in.	CA-37-1T
DBK expansion cable from DaqBook to DBK modules; 4.5 in.	CA-37-3T
DBK expansion cable from DaqBook to DBK modules; 5.5 in.	CA-37-4T
DBK expansion cable from DaqBook to DBK modules; 11.5 in.	CA-37-8T
Ribbon cable with female DB37 connector, provides convenient wiring to DaqBook P1, P2, and P3 ports without requiring soldering to DB37 connectors, 6 ft.	CA-113
5-pin male DIN to 5-pin male DIN provides convenient connection between DaqBook power input connectors and battery packs (also used to daisy-chain input power to expansion modules equipped with 2 power input connectors, e.g., DBK32A, DBK42), 6 in.	CA-115
5-pin DIN to automobile cigarette lighter power cable, 8 ft.	CA-116

Note: Specifications are subject to change without notice.



Notes

WARRANTY/DISCLAIMER

OMEGA ENGINEERING, INC. warrants this unit to be free of defects in materials and workmanship for a period of **13 months** from date of purchase. OMEGA's WARRANTY adds an additional one (1) month grace period to the normal **one (1) year product warranty** to cover handling and shipping time. This ensures that OMEGA's customers receive maximum coverage on each product.

If the unit malfunctions, it must be returned to the factory for evaluation. OMEGA's Customer Service Department will issue an Authorized Return (AR) number immediately upon phone or written request. Upon examination by OMEGA, if the unit is found to be defective, it will be repaired or replaced at no charge. OMEGA's WARRANTY does not apply to defects resulting from any action of the purchaser, including but not limited to mishandling, improper interfacing, operation outside of design limits, improper repair, or unauthorized modification. This WARRANTY is VOID if the unit shows evidence of having been tampered with or shows evidence of having been damaged as a result of excessive corrosion; or current, heat, moisture or vibration; improper specification; misapplication; misuse or other operating conditions outside of OMEGA's control. Components in which wear is not warranted, include but are not limited to contact points, fuses, and triacs.

OMEGA is pleased to offer suggestions on the use of its various products. However, OMEGA neither assumes responsibility for any omissions or errors nor assumes liability for any damages that result from the use of its products in accordance with information provided by OMEGA, either verbal or written. OMEGA warrants only that the parts manufactured by the company will be as specified and free of defects. OMEGA MAKES NO OTHER WARRANTIES OR REPRESENTATIONS OF ANY KIND WHATSOEVER, EXPRESSED OR IMPLIED, EXCEPT THAT OF TITLE, AND ALL IMPLIED WARRANTIES INCLUDING ANY WARRANTY OF MERCHANTABILITY AND FITNESS FOR A PARTICULAR PURPOSE ARE HEREBY DISCLAIMED. LIMITATION OF LIABILITY: The remedies of purchaser set forth herein are exclusive, and the total liability of OMEGA with respect to this order, whether based on contract, warranty, negligence, indemnification, strict liability or otherwise, shall not exceed the purchase price of the component upon which liability is based. In no event shall OMEGA be liable for consequential, incidental or special damages.

CONDITIONS: Equipment sold by OMEGA is not intended to be used, nor shall it be used: (1) as a "Basic Component" under 10 CFR 21 (NRC), used in or with any nuclear installation or activity; or (2) in medical applications or used on humans. Should any Product(s) be used in or with any nuclear installation or activity, medical application, used on humans, or misused in any way, OMEGA assumes no responsibility as set forth in our basic WARRANTY/DISCLAIMER language, and, additionally, purchaser will indemnify OMEGA and hold OMEGA harmless from any liability or damage whatsoever arising out of the use of the Product(s) in such a manner.

RETURN REQUESTS/INQUIRIES

Direct all warranty and repair requests/inquiries to the OMEGA Customer Service Department. BEFORE RETURNING ANY PRODUCT(S) TO OMEGA, PURCHASER MUST OBTAIN AN AUTHORIZED RETURN (AR) NUMBER FROM OMEGA'S CUSTOMER SERVICE DEPARTMENT (IN ORDER TO AVOID PROCESSING DELAYS). The assigned AR number should then be marked on the outside of the return package and on any correspondence.

The purchaser is responsible for shipping charges, freight, insurance and proper packaging to prevent breakage in transit.

FOR **WARRANTY** RETURNS, please have the following information available BEFORE contacting OMEGA:

1. Purchase Order number under which the product was PURCHASED,
2. Model and serial number of the product under warranty, and
3. Repair instructions and/or specific problems relative to the product.

FOR **NON-WARRANTY** REPAIRS, consult OMEGA for current repair charges. Have the following information available BEFORE contacting OMEGA:

1. Purchase Order number to cover the COST of the repair,
2. Model and serial number of the product, and
3. Repair instructions and/or specific problems relative to the product.

OMEGA's policy is to make running changes, not model changes, whenever an improvement is possible. This affords our customers the latest in technology and engineering.

OMEGA is a registered trademark of OMEGA ENGINEERING, INC.

© Copyright 2005 OMEGA ENGINEERING, INC. All rights reserved. This document may not be copied, photocopied, reproduced, translated, or reduced to any electronic medium or machine-readable form, in whole or in part, without the prior written consent of OMEGA ENGINEERING, INC.

Where Do I Find Everything I Need for Process Measurement and Control? **OMEGA...Of Course!** *Shop online at omega.com*

TEMPERATURE

- ☑ Thermocouple, RTD & Thermistor Probes, Connectors, Panels & Assemblies
- ☑ Wire: Thermocouple, RTD & Thermistor
- ☑ Calibrators & Ice Point References
- ☑ Recorders, Controllers & Process Monitors
- ☑ Infrared Pyrometers

PRESSURE, STRAIN AND FORCE

- ☑ Transducers & Strain Gages
- ☑ Load Cells & Pressure Gages
- ☑ Displacement Transducers
- ☑ Instrumentation & Accessories

FLOW/LEVEL

- ☑ Rotameters, Gas Mass Flowmeters & Flow Computers
- ☑ Air Velocity Indicators
- ☑ Turbine/Paddlewheel Systems
- ☑ Totalizers & Batch Controllers

pH/CONDUCTIVITY

- ☑ pH Electrodes, Testers & Accessories
- ☑ Benchtop/Laboratory Meters
- ☑ Controllers, Calibrators, Simulators & Pumps
- ☑ Industrial pH & Conductivity Equipment

DATA ACQUISITION

- ☑ Data Acquisition & Engineering Software
- ☑ Communications-Based Acquisition Systems
- ☑ Plug-in Cards for Apple, IBM & Compatibles
- ☑ Datalogging Systems
- ☑ Recorders, Printers & Plotters

HEATERS

- ☑ Heating Cable
- ☑ Cartridge & Strip Heaters
- ☑ Immersion & Band Heaters
- ☑ Flexible Heaters
- ☑ Laboratory Heaters

ENVIRONMENTAL MONITORING AND CONTROL

- ☑ Metering & Control Instrumentation
- ☑ Refractometers
- ☑ Pumps & Tubing
- ☑ Air, Soil & Water Monitors
- ☑ Industrial Water & Wastewater Treatment
- ☑ pH, Conductivity & Dissolved Oxygen Instruments