

# OMRON®

## INSTRUCTION MANUAL

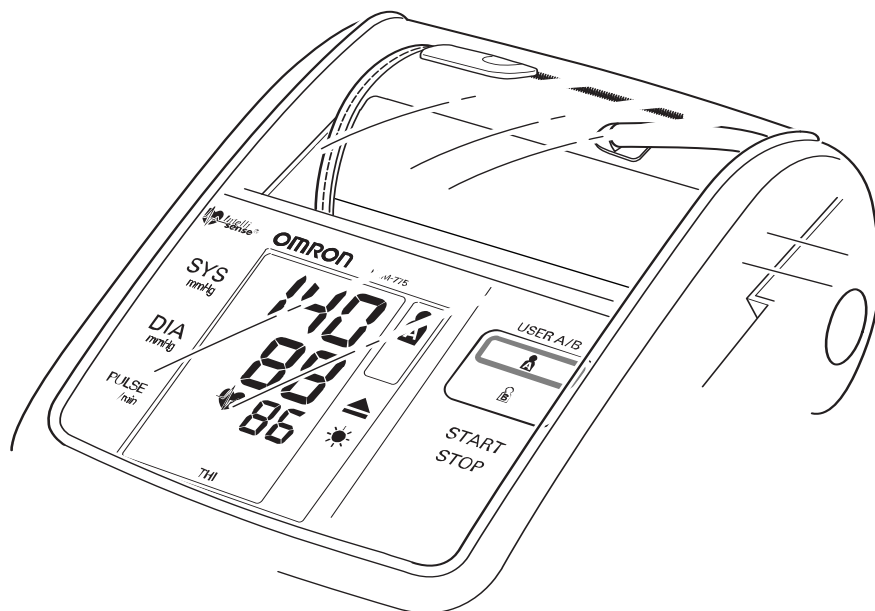

### Ultra Premium Blood Pressure Monitor featuring ComFit™ Cuff Model HEM-775



ESPAÑOL

ENGLISH

# TABLE OF CONTENTS

## Before Using the Monitor

Introduction	4
Safety Information	5
Operating the Device	5
Risk of Electrical Shock	6
Care and Maintenance	7
Before Taking a Measurement	8

## Operating Instructions

Know Your Unit	9
Unit Display	10
Display Symbols	11
Irregular Heartbeat Symbol	11
Movement Error Symbol	11
USER ID Symbol	11
Morning Hypertension Symbol	12
Heartbeat Symbol	13
Average Value Symbol	13
Morning Average Symbol	13
Evening Average Symbol	13
Battery Installation	14
Using the AC Adapter	16
Setting the Date and Time	18
Applying the Arm Cuff	22

# TABLE OF CONTENTS

Taking a Measurement .....	.26
Using the Guest Mode .....	.26
Selecting the USER ID .....	.27
Using the USER ID .....	.27
Selecting the TruRead™ Mode .....	.28
Using the Single Mode .....	.30
Using the TruRead™ Mode .....	.33
Special Conditions .....	.35
Using the Memory Function .....	.36
Averaging Function .....	.36
To Display the Measurement Values .....	.37
Morning and Evening Averages .....	.39
Morning Averages .....	.39
Evening Averages .....	.39
To Display Morning and Evening Averages .....	.40
Display Combinations .....	.41
To Delete All Values Stored in the Memory .....	.42
<b>Care and Maintenance</b>	
Care and Maintenance .....	.43
Error Indicators and Troubleshooting Tips .....	.45
FCC Statement .....	.47
Warranty .....	.48
Specifications .....	.49
Notes .....	.50

# INTRODUCTION

Thank you for purchasing the Omron® HEM-775 IntelliSense® Automatic Blood Pressure Monitor with ComFit™ Cuff.

*Fill in for future reference.*

DATE PURCHASED: \_\_\_\_\_

SERIAL NUMBER: \_\_\_\_\_

*Staple your purchase receipt here*

Your new digital blood pressure monitor uses the oscillometric method of blood pressure measurement. This means the monitor detects your blood's movement through your brachial artery and converts the movements into a digital reading. The monitor stores measurement results for two people and features Morning and Evening Averages. TruRead™ allows for three consecutive measurements with timed intervals for an average reading.

The HEM-775 comes with the following components:



- Monitor
- ComFit™ Cuff
- AC Adapter
- 4 “AA” Batteries
- Warranty Card
- Instruction Manual printed in English and Spanish

The HEM-775 IntelliSense® Automatic Blood Pressure Monitor is intended for home use.

## SAVE THESE INSTRUCTIONS

# SAFETY INFORMATION

*To assure the correct use of the product basic safety measures should always be followed including the warnings and cautions listed in this instruction manual.*

SAFETY SYMBOLS USED IN THIS INSTRUCTION MANUAL	
 <b>WARNING</b>	Indicates a potentially hazardous situation which, if not avoided, could result in death or serious injury.
 <b>CAUTION</b>	Indicates a potentially hazardous situation which, if not avoided, may result in minor or moderate injury to the user or patient or damage to the equipment or other property.

## OPERATING THE DEVICE

- ⚠ Contact your physician for specific information about your blood pressure. Self-diagnosis and treatment using measured results may be dangerous. Follow the instructions of your physician or licensed healthcare provider.
- ⚠ If battery fluid should get in your eyes, immediately rinse with plenty of clean water. Contact a physician immediately.
- ⚠ Read all of the information in the instruction manual and any other literature in the box before operating the unit.
- ⚠ This device is intended for use in measuring blood pressure and pulse rate in the adult population. Do not use this device on infants or persons who cannot express their intentions.

# SAFETY INFORMATION

## OPERATING THE DEVICE (continued)

- ⚠ Read the Special Conditions section (page 35) of the instruction manual if your systolic pressure is known to be more than 220 mmHg. Inflating to a higher pressure than necessary may result in bruising where the cuff is applied.
- ⚠ Operate the device only as intended. Do not use the device for any other purpose.
- ⚠ Dispose of the device, components and optional accessories according to applicable local regulations. Unlawful disposal may cause environmental pollution.
- ⚠ Do not use a cellular phone near the device. It may result in an operational failure.
- ⚠ Use only Omron authorized parts and accessories. Parts and accessories not approved for use with the device may damage the unit.
- ⚠ Use only 1.5V manganese or alkaline batteries with this device. Do not use other types of batteries. This may damage the unit.

## RISK OF ELECTRICAL SHOCK

- ⚠ Do not plug or unplug the power cord into the electrical outlet with wet hands.
- ⚠ Do not overload power outlets. Plug the device into the appropriate voltage outlet.

# SAFETY INFORMATION

## CARE AND MAINTENANCE

- ⚠ Do not subject the monitor to strong shocks, such as dropping the unit on the floor.
- ⚠ Do not submerge the device or any of the components in water.
- ⚠ Store the device and the components in a clean, safe location.
- ⚠ Changes or modification not approved by Omron Healthcare will void the user warranty. Do not disassemble or attempt to repair the unit or components.
- ⚠ Do not store the AC adapter in the cuff compartment. This may damage the cuff.

# BEFORE TAKING A MEASUREMENT

To ensure a reliable reading follow these recommendations:

1. Avoid eating, drinking alcohol, smoking, exercising, and bathing for 30 minutes before taking a measurement. Rest for at least 15 minutes before taking the measurement.
2. Stress raises blood pressure. Avoid taking measurements during stressful times.
3. Measurements should be taken in a quiet place.
4. Remove tight-fitting clothing from your arm.
5. Sit in a chair with your feet flat on the floor. Rest your arm on a table so that the cuff is at the same level as your heart.
6. Remain still and do not talk during the measurement.
7. Keep a record of your blood pressure and pulse readings for your physician. A single measurement does not provide an accurate indication of your true blood pressure. You need to take and record several readings over a period of time. Try to measure your blood pressure at about the same time each day for consistency.



# KNOW YOUR UNIT

## Main Unit:

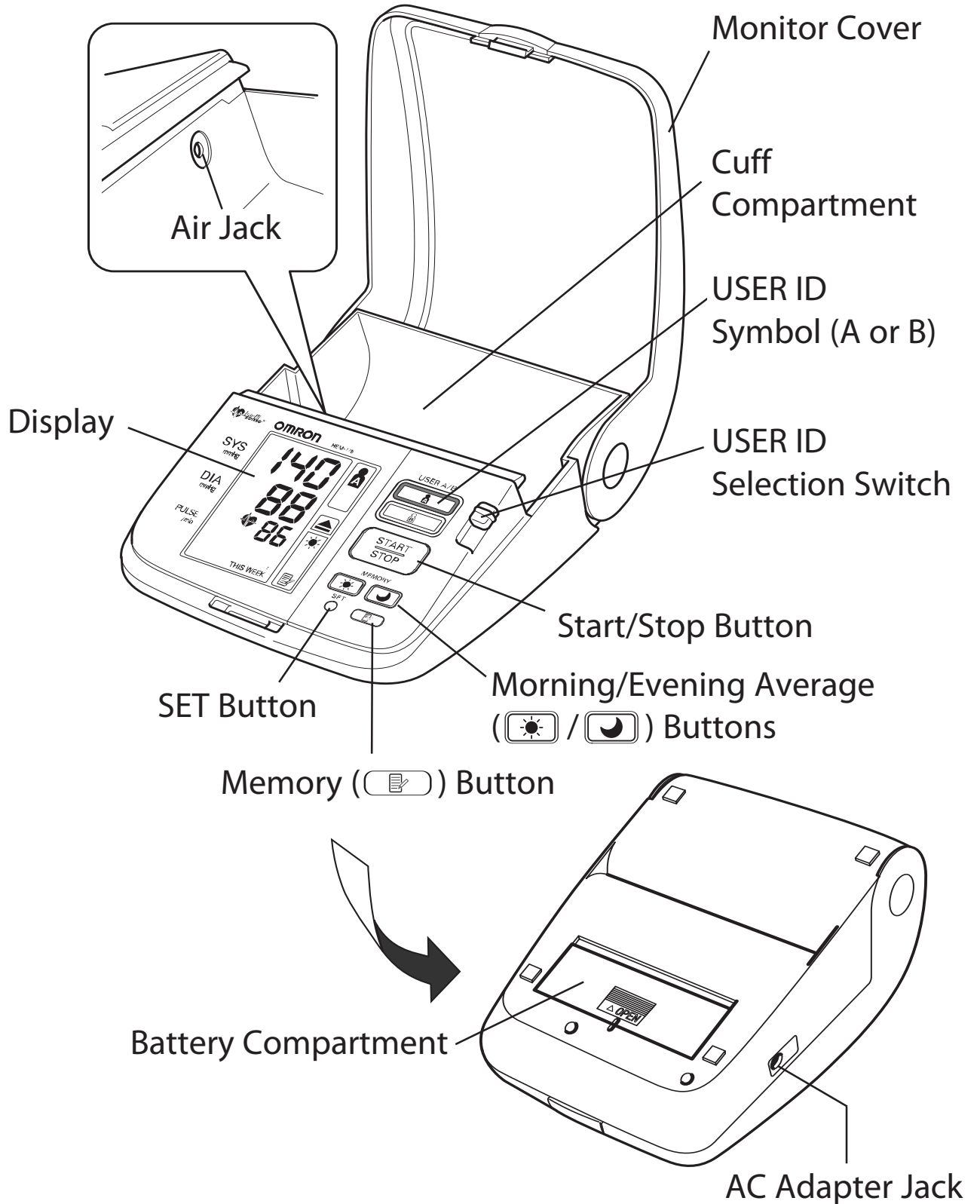

# KNOW YOUR UNIT

## Components:

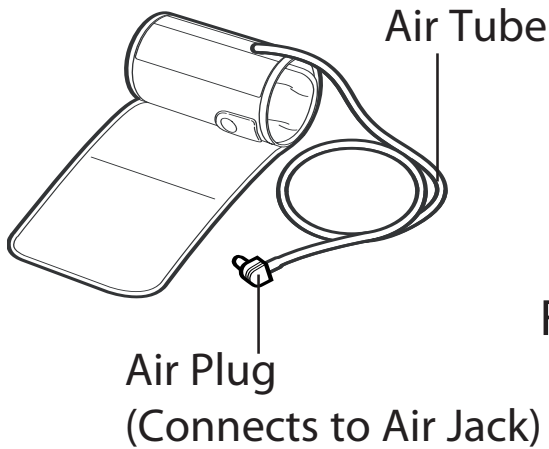

Arm Cuff

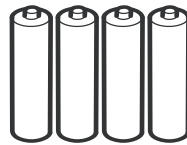

Four "AA" Batteries

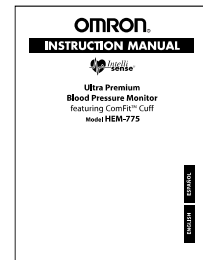
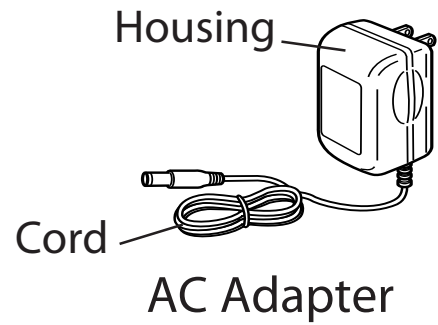

Instruction Manual

# UNIT DISPLAY

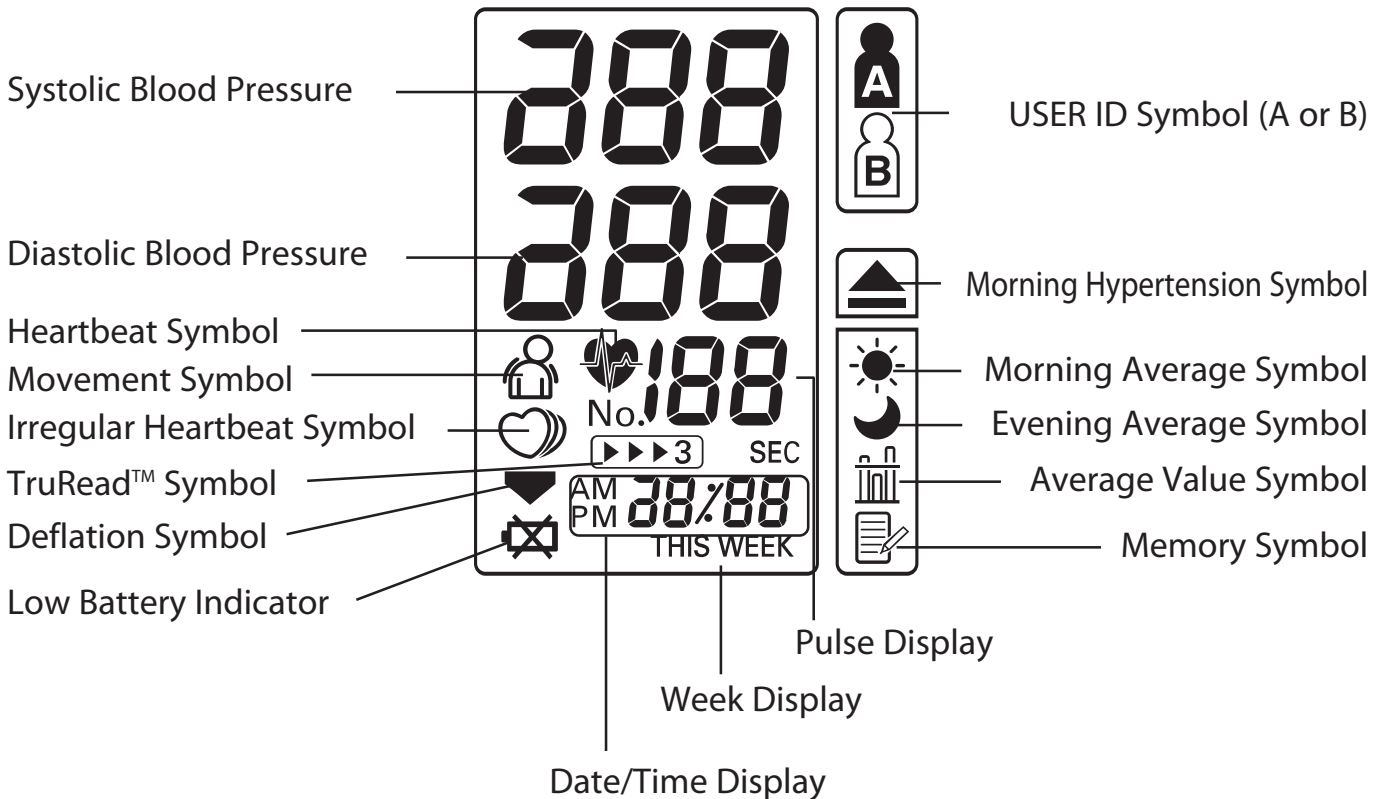

# DISPLAY SYMBOLS

## IRREGULAR HEARTBEAT SYMBOL (🫀)

When the monitor detects an irregular rhythm two or more times during the measurement, the Irregular Heartbeat Symbol (🫀) will appear on the display with the measurement values.

An irregular heartbeat rhythm is defined as a rhythm that is more than 25% slower or 25% faster from the average rhythm detected while the monitor is measuring the systolic blood pressure and the diastolic blood pressure.

If the irregular heartbeat symbol (🫀) displays with your measurement results, we recommend you consult your physician. Follow the directions of your doctor.

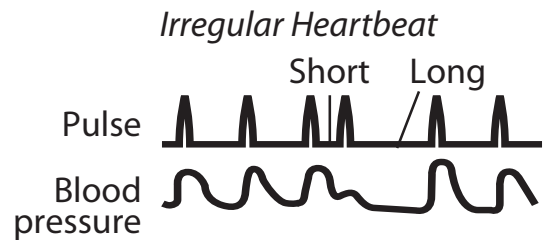
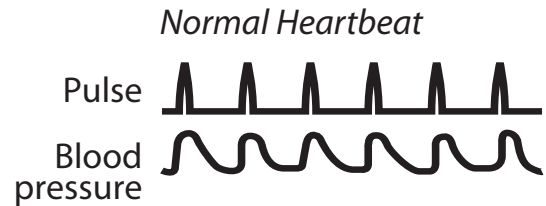

## MOVEMENT ERROR SYMBOL (🧑)

The Movement Error Symbol is displayed if you move your body during the measurement. Please remove the arm cuff, and wait 2-3 minutes. Take another measurement.

## USER ID SYMBOL (👤 / 👤)

The USER ID Symbol indicates USER A or USER B as selected by the user to take a measurement or when using the memory function. The USER ID Symbol is not displayed when using the Guest Mode to take a measurement.

# DISPLAY SYMBOLS

The American Heart Association<sup>1</sup> recommends the following guideline for upper limit of normal for home blood pressure readings:

<b>AHA Home Guideline for Upper Limit of Normal BP</b>	
Systolic Blood Pressure	135 mmHg
Diastolic Blood Pressure	85 mmHg

This is a general guideline because blood pressure depends on age and morbidity. The AHA recommends a lower home blood pressure goal for certain patients, including diabetic patients, pregnant women, and patients with renal failure<sup>1</sup>.

The monitor is not intended to be a diagnostic device.

## **⚠ WARNING**

Contact your physician for specific information about your blood pressure. Self-diagnosis and treatment using measured results may be dangerous. Follow the instructions of your physician or licensed healthcare provider.

Omron Healthcare recommends you contact your physician if the MORNING HYPERTENSION SYMBOL and/or the HEARTBEAT SYMBOL appear on the display with your measurement values.

## **MORNING HYPERTENSION SYMBOL (▲)**

The Morning Hypertension Symbol is displayed if the morning average reading for a week is above 135 for the Systolic Blood Pressure value and/or 85 for the Diastolic Blood Pressure value when viewing the Morning Averages and the Evening Averages in the memory.

<sup>1</sup>American Heart Association Scientific Statement 2004

# DISPLAY SYMBOLS

## HEARTBEAT SYMBOL ( )

### TAKING A MEASUREMENT

The Heartbeat Symbol flashes on the display during the measurement.

The Heartbeat Symbol flashes at every heartbeat.

When the measurement is complete, the Heartbeat Symbol flashes on the display with your blood pressure and pulse rate if the reading is above 135 for the Systolic Blood Pressure value and/or 85 for the Diastolic Blood Pressure value.

### USING THE MEMORY FUNCTION

The Heartbeat Symbol flashes when the blood pressure reading stored in the memory is above 135 for the Systolic Blood Pressure value and/or 85 for the Diastolic Blood Pressure value.

## AVERAGE VALUE SYMBOL ( )

The Average Value Symbol is displayed when you press the memory button. The most recent average reading appears on the display screen.

## MORNING AVERAGE SYMBOL ( )

The Morning Average symbol is displayed when viewing Morning Averages using the Memory Function.

## EVENING AVERAGE SYMBOL ( )

The Evening Average symbol is displayed when viewing Evening Averages using the Memory Function.

# BATTERY INSTALLATION

1. Press the ▼ indicator on the battery cover and slide the cover off in the direction of the arrow.

2. Install 4 “AA” size batteries so the + (positive) and - (negative) polarities match the polarities of the battery compartment as indicated.

3. Replace the battery cover.

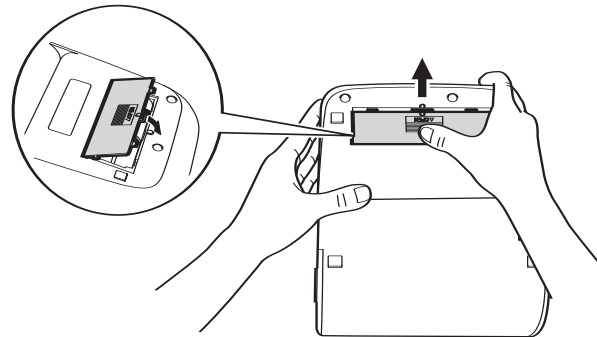
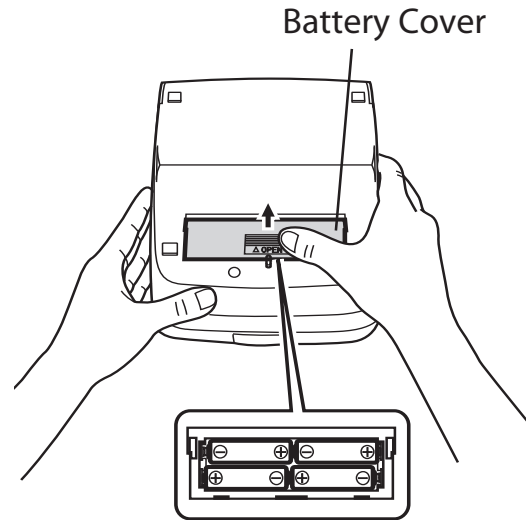

# BATTERY INSTALLATION

## BATTERY REPLACEMENT



Low Battery Indicator

When the Low Battery Indicator appears on the display screen turn the monitor off and remove all the batteries. Replace with four new batteries at the same time. Longlife alkaline batteries are recommended.

### **⚠ CAUTION**

If battery fluid should get in your eyes, immediately rinse with plenty of clean water. Contact a physician immediately.

- NOTES:**
- Turn the unit off before replacing the batteries. If the batteries are removed while the unit is still on, the date and time will be reset to that of the previous use. However, the measurement results are not deleted.
  - When the batteries are replaced, you may need to reset the date and time. If the year is flashing on the display screen, refer to page 21, **RESETTING THE DATE AND TIME**.
  - The supplied batteries may have a shorter life.

### **⚠ CAUTION**

Dispose of the device, components and optional accessories according to applicable local regulations. Unlawful disposal may cause environmental pollution.

# USING THE AC ADAPTER

Use only the authorized Omron AC Adapter, Model Number HEM-ADPT1, with this monitor.

We recommend you install the batteries even if the AC Adapter is used. If no batteries are installed, you may need to reset the date and time if the AC Adapter is disconnected. The measurement results will not be deleted.

## **⚠ CAUTION**

Use only Omron authorized parts and accessories. Parts and accessories not approved for use with the device may damage the unit.



# USING THE AC ADAPTER

## TO CONNECT THE AC ADAPTER

- ① Insert the AC Adapter Plug into the AC Adapter Jack on the back side of the monitor as illustrated.
- ② Plug the AC Adapter into a 120V AC outlet (60 cycles).

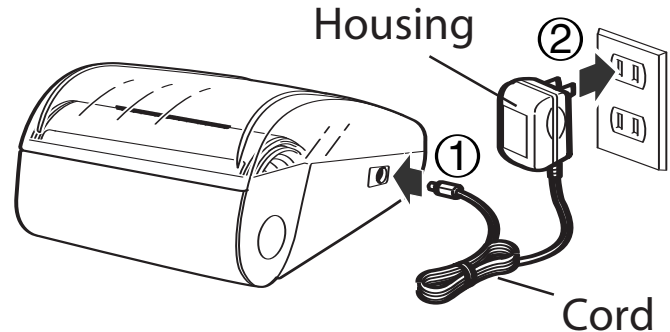

## TO DISCONNECT THE AC ADAPTER

- ① Hold and pull the Housing to remove the AC Adapter from the electrical outlet. Do not remove by pulling on the cord.
- ② Remove the AC Adapter plug from the monitor.

### **⚠ WARNING**

Do not plug or unplug the power cord into the electrical outlet with wet hands.

### **⚠ CAUTION**

Do not overload power outlets. Plug the device into the appropriate voltage outlet.

# SETTING THE DATE AND TIME

Set the monitor to the current date and time before taking a measurement for the first time. If the date and time are not set correctly, the measurement values stored in the memory and the average values may not be correct.

The Blood Pressure Monitor automatically stores up to 84 individual measurement values with the dates and times. The monitor also calculates weekly averages for measurements in the morning and in the evening. Morning and Evening averages are stored for this week and the last seven weeks.

The monitor can also calculate an average reading based on the three most recent measurements taken within 10 minutes of the last reading.

- NOTE:**
- If only two readings are stored in the memory for the 10-minute period, the average is based on the two readings.
  - If one reading is stored in the memory for the 10-minute period, this reading is displayed as the average.

## 1. TO START THE SETTING

Press and hold the SET button to adjust the date and time.

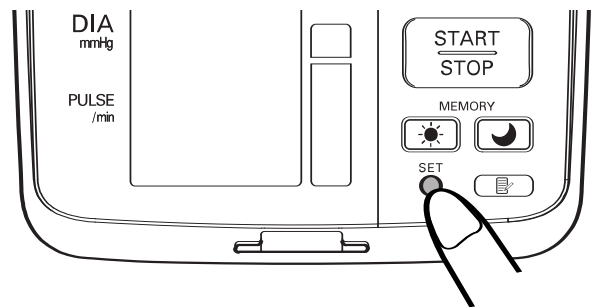

The year flashes on the display.

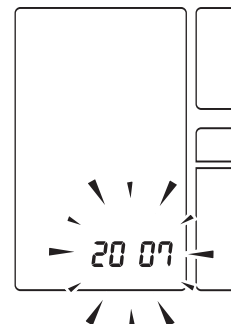

# SETTING THE DATE AND TIME

## 2. SETTING THE YEAR

The year can be set between 2007 and 2030. When the display reaches 2030, it will return to 2007.

Press the Memory button (  ) to advance by increments of one year.

Press the SET button to set the current year.

The month flashes on the display.

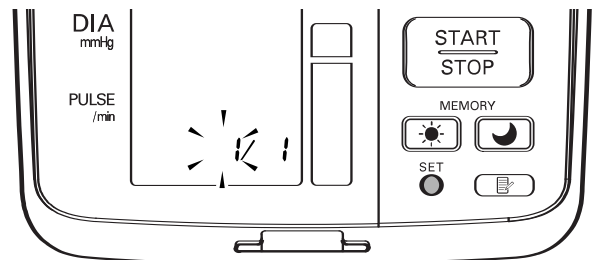
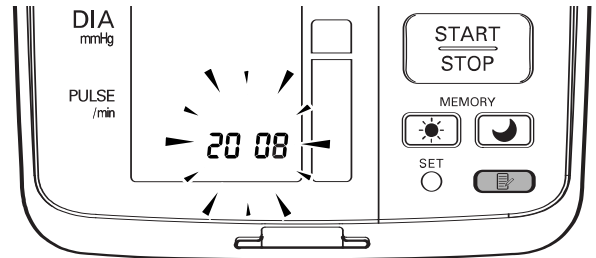

**NOTE:** Press and hold the Memory button (  ) to advance the date and time values faster.

## 3. SETTING THE MONTH

Press the Memory button (  ) to advance by increments of one month.

Press the SET button to set the current month.

The day flashes on the display.

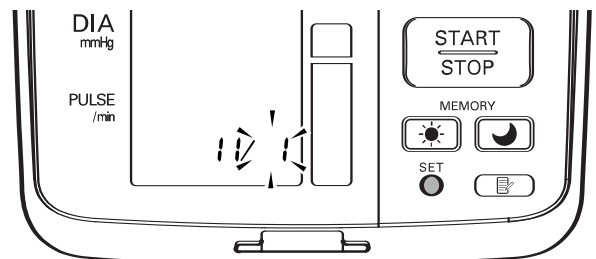

# SETTING THE DATE AND TIME

## 4. SETTING THE DAY

Press the Memory button (  ) to advance by increments of one day.

Press the SET button to set the current day.

The hour flashes on the display.

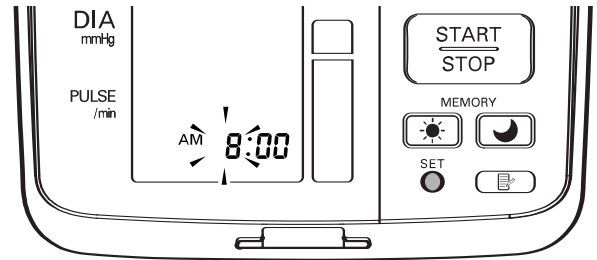

## 5. SETTING THE HOUR

The time is set using AM or PM.

Press the Memory button (  ) to advance by increments of one hour.

Press the SET button to set the current hour.

The minute flashes on the display.

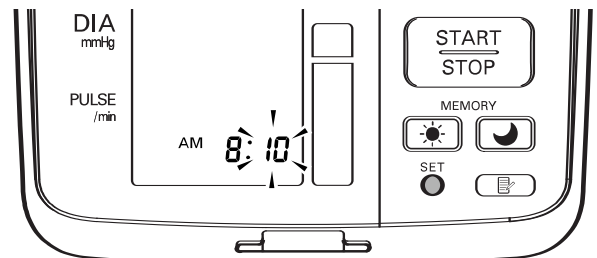

## 6. SETTING THE MINUTE

Press the Memory button (  ) to advance by increments of one minute.

Press the SET button to set the minute setting.

## 7. TO TURN THE MONITOR OFF

Press the START/STOP button.

**NOTE:** The monitor will automatically turn off after the minute has been set after battery replacement.

# SETTING THE DATE AND TIME

## RESETTING THE DATE AND TIME

To adjust the date or time after it has been setup when you first use the unit.

Start with the monitor in the off position.

1. Press and hold the SET button.

The TruRead™ symbol  and the current setting (**on** or **oFF**) will appear on the display for the USER ID selected.

To change the **on** or **oFF** setting press the Memory button, then press the SET button.

The interval time flashes on the display. Press the Memory button to select the desired interval time, then press the SET button.

The year flashes on the display.

2. Refer to page 18, SETTING THE DATE AND TIME.

**NOTE:** If you need to change the Date and Time, always adjust the Date and Time setting before taking the next measurement.

# APPLYING THE ARM CUFF

## ⚠ CAUTION

Read all of the information in the instruction manual and any other literature in the box before operating the unit.

## ⚠ CAUTION

This device is intended for use in measuring blood pressure and pulse rate in the adult population. Do not use this device on infants or persons who cannot express their intentions.

## APPLYING THE CUFF ON THE LEFT ARM

1. Make sure the air plug is securely inserted in the main unit.

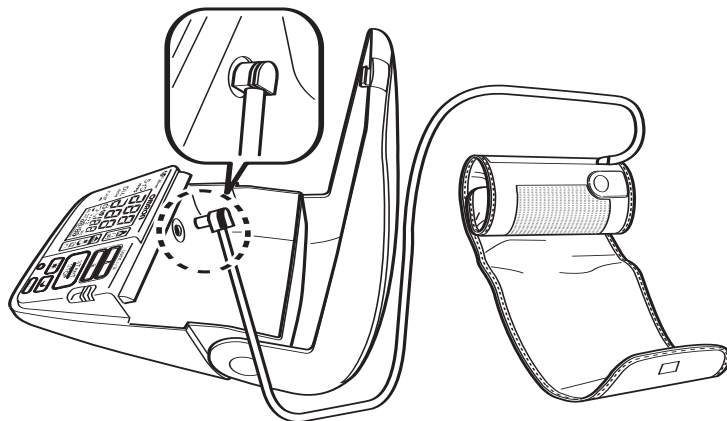

2. Remove tight-fitting clothing from your upper left arm.

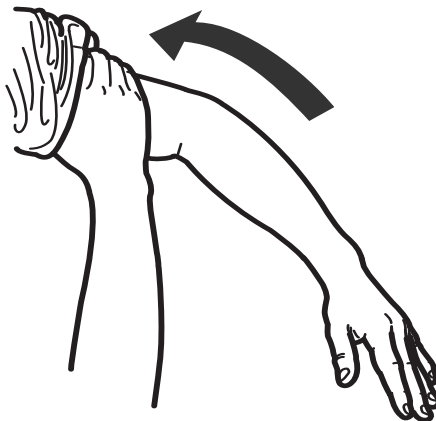

# APPLYING THE ARM CUFF

3. Sit in a chair with your feet flat on the floor. Place your left arm on a table so the cuff is level with your heart.

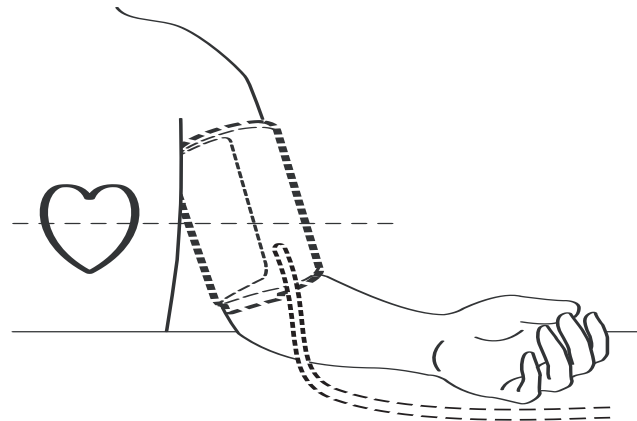
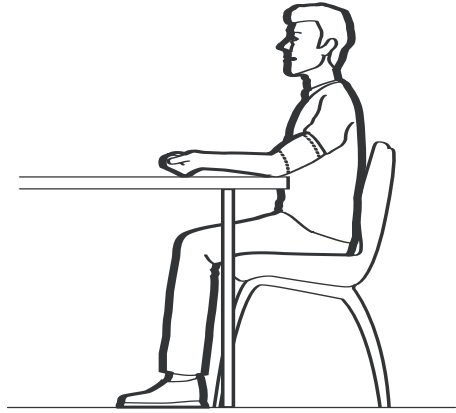

4. Hold the grip on the cuff securely with your right hand, placing your thumb on the thumb grip.

Thumb Grip

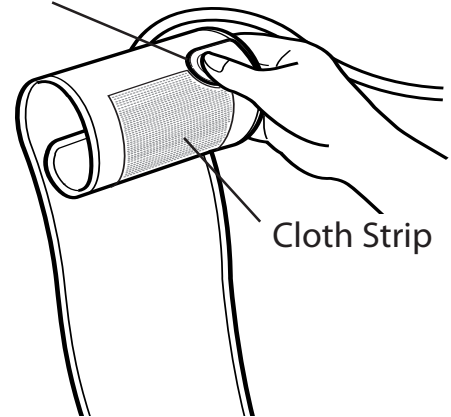

5. Turn the palm of your left hand upward.

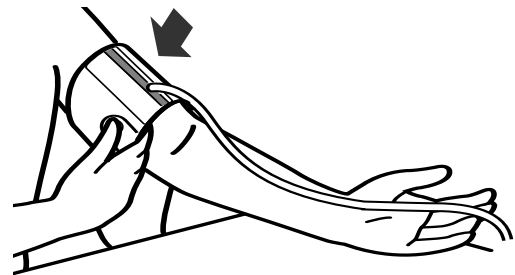

# APPLYING THE ARM CUFF

6. Apply the cuff to your left upper arm so the blue strip is on the inside of your arm and aligned with your middle finger. The air tube runs down the inside of your arm. The bottom of the cuff should be approximately 1/2" above your elbow.

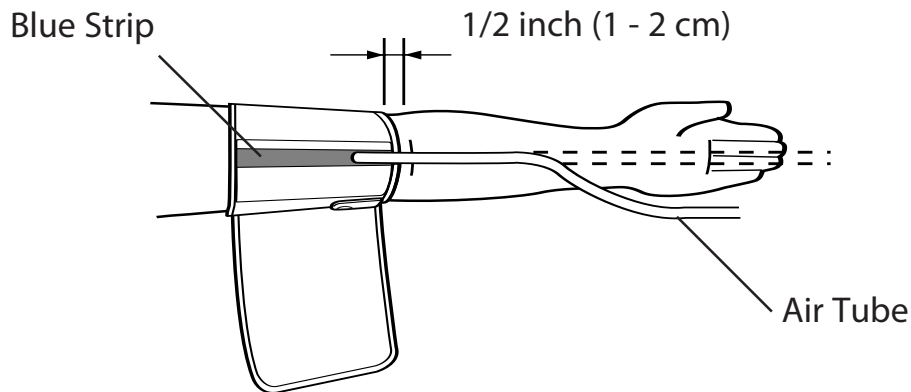

7. Wrap the cuff firmly in place around your arm using the cloth strip.

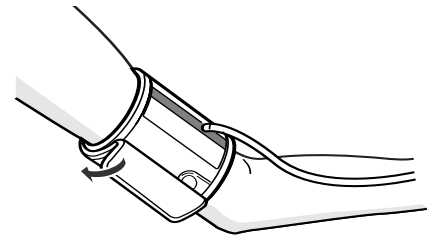



# APPLYING THE ARM CUFF

## APPLYING THE CUFF ON THE RIGHT ARM

When taking a measurement using the right arm use this instruction for Step 6 on page 24.

Apply the cuff to your right upper arm so the thumb grip is centered on the inside of your inner arm. The bottom of the cuff should be approximately 1/2" above your elbow.

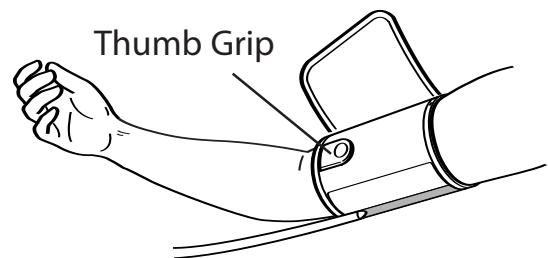

**NOTE:** Be careful not to rest your arm on the air tube. This will restrict the flow of air to the cuff.

# TAKING A MEASUREMENT

The monitor is designed to take measurements and store the measurement values in the memory for two people using USER ID A and USER ID B.

The monitor can also be used to take a single measurement for other persons using the GUEST Mode. The USER ID symbol is not displayed when using the GUEST Mode. Measurements taken using the GUEST Mode are not stored in the memory.

## ⚠ CAUTION

Operate the device only as intended. Do not use the device for any other purpose.

## USING THE GUEST MODE

1. Press and hold the START/STOP button.

The A and B Symbols disappear from the display.

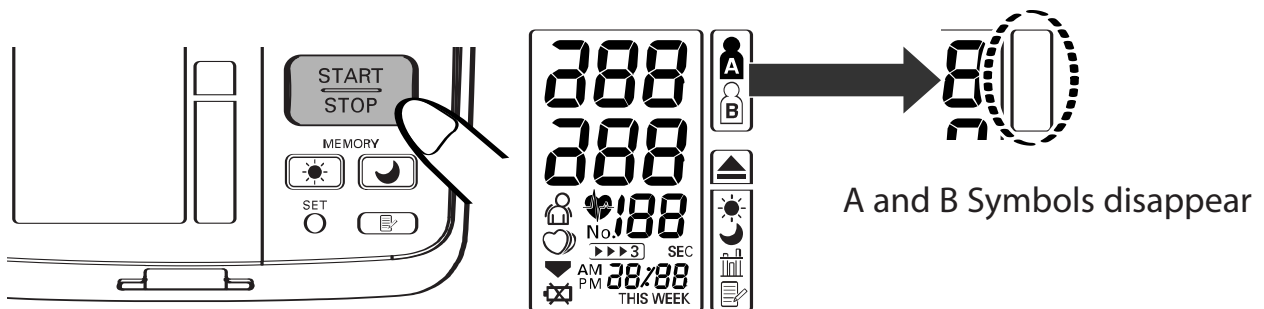

2. Release the START/STOP button.

The cuff starts to inflate automatically.

**NOTE:** To stop the inflation press the START/STOP button.

The monitor will stop inflating, start deflation and turn off.

# TAKING A MEASUREMENT

3. Inflation stops and the measurement is started. When the measurement is completed, your blood pressure and pulse rate appear on the display.

## SELECTING THE USER ID

Select your USER ID. Always use the same USER ID when taking a measurement. The monitor stores the measurement values in the memory by the USER ID selected. These measurement values are used to calculate the Morning Averages and Evening Averages.

Slide the USER ID Selection Switch up or down to select USER A or B.

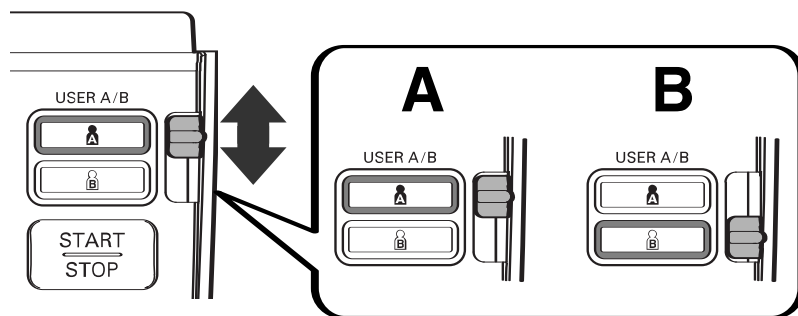

## USING THE USER ID

When you select a USER ID the monitor can be set to take one measurement using the Single Mode or three consecutive measurements using the TruRead™ Mode when you press the START/STOP button.

**NOTE:** The default value is set to the Single Mode to take one measurement.

The TruRead™ Mode takes three consecutive measurements. The monitor will inflate, take a measurement, and deflate three times separated by a short interval of time between each measurement.

# TAKING A MEASUREMENT

## SELECTING THE TruRead™ MODE

1. Select your USER ID (A or B).

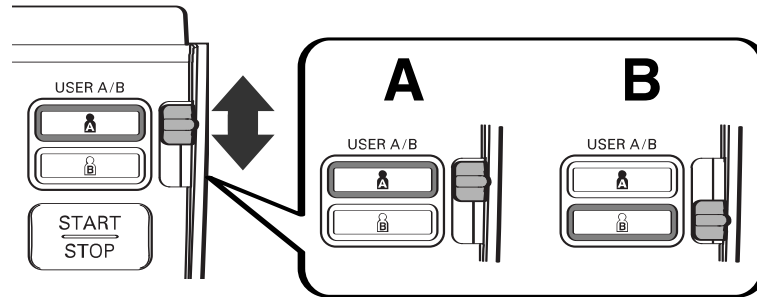

2. Press and hold the SET button.

The TruRead™ symbol  and the **oFF** setting appears on the display.

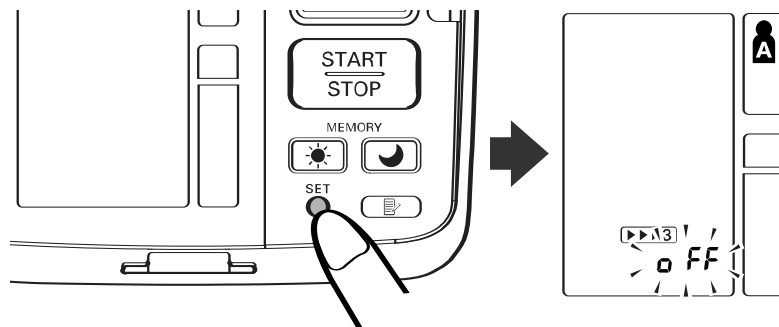

3. Press the Memory button (  ) to select **on**.

**NOTE:** Press the Memory button to alternate between **on** and **oFF**.

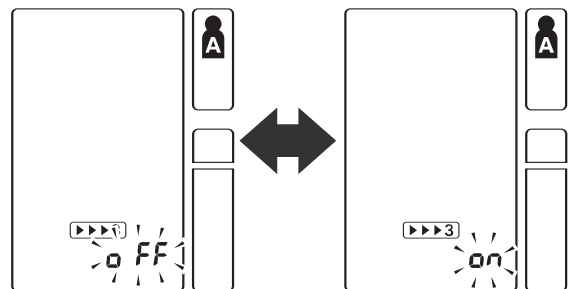

# TAKING A MEASUREMENT

4. Press the SET button to confirm the change.

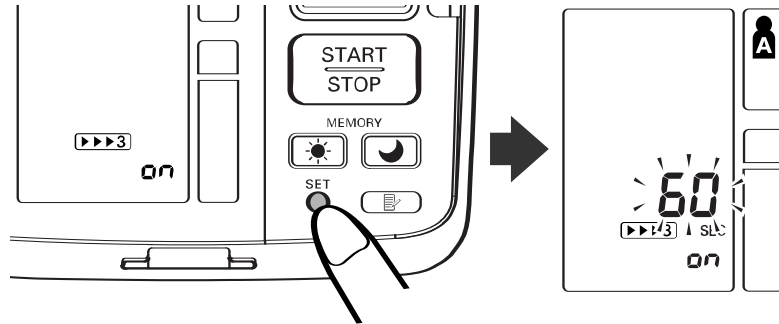

The number of seconds between each measurement is displayed.

**NOTE:** The default value between each measurement is 60 seconds.

5. Press the MEMORY button (  ) to change the interval of time between each measurement.

The interval can be set to 15 seconds, 30 seconds, 60 seconds or 120 seconds. Continue to press the MEMORY button until the desired interval appears on the display.

6. Press the SET button to confirm the setting.

The year flashes on the display.

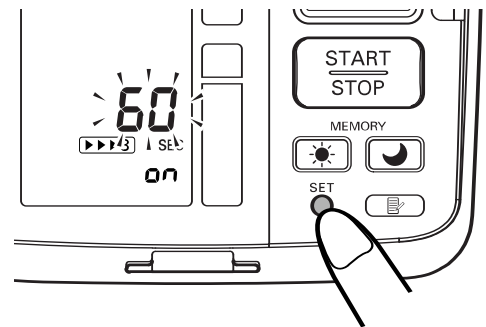

# TAKING A MEASUREMENT

7. If the date and time are correct, press the START/STOP button to turn the monitor off.

To change the date and time refer to page 18, SETTING THE DATE AND TIME.

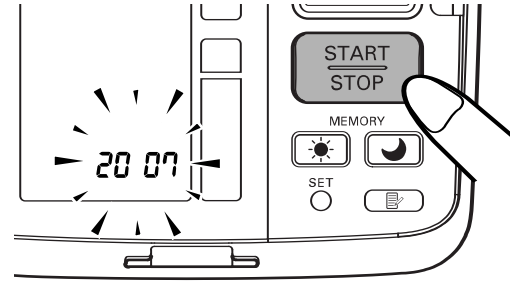

## **⚠ CAUTION**

Do not use a cellular phone near the device. It may result in an operational failure.

## **USING THE SINGLE MODE**

1. Select your USER ID (A or B).

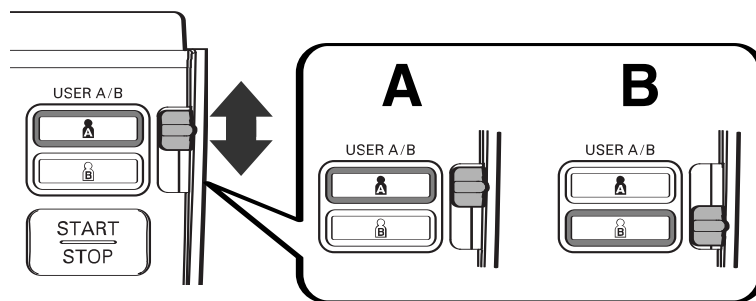

# TAKING A MEASUREMENT

2. Press the START/STOP button.

All symbols appear on the display. The USER ID Symbol you selected flashes on the display.

The cuff starts to inflate automatically. As the cuff inflates, the monitor automatically determines your ideal inflation level. This monitor detects the pulse during inflation. Do not move your arm and remain still until the entire measurement process is completed.

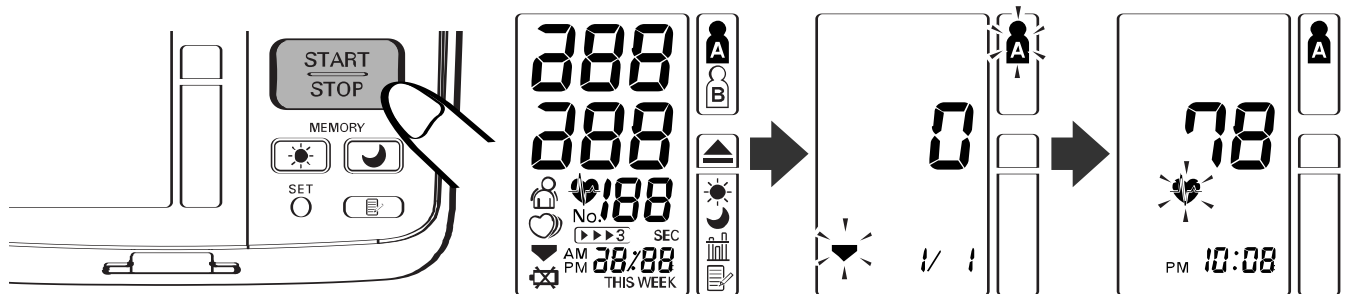

**NOTE:** To stop the inflation or measurement, press the START/STOP button. The monitor will stop inflating, start deflating and will turn off.

3. Inflation stops automatically and the measurement is started.

As the cuff deflates, decreasing numbers appear on the display. The Heartbeat Symbol (  ) flashes at every heartbeat.

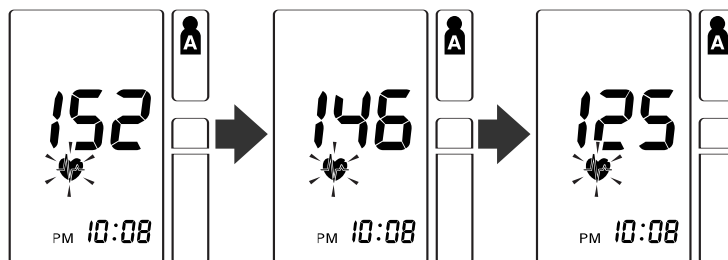

# TAKING A MEASUREMENT

- When the measurement is complete, the arm cuff completely deflates. Your blood pressure and pulse rate are displayed.

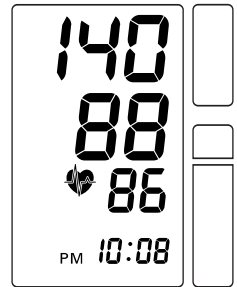

- Press the START/STOP button to turn the monitor off.

**NOTE:** The monitor will automatically turn off after five minutes.

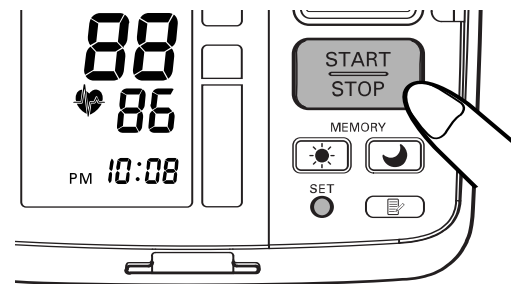



# TAKING A MEASUREMENT

## USING THE TruRead™ MODE

1. Select your USER ID (A or B).
2. Press the START/STOP button.

All symbols appear on the display. The USER ID Symbol you selected flashes on the display. The cuff starts to inflate automatically.

**NOTE:** To stop the inflation or measurement, press the START/STOP button. The monitor will stop inflating, start deflating and will turn off.

3. Inflation stops automatically and the measurement is started.

As the cuff deflates, decreasing numbers appear on the display. The Heartbeat Symbol (  ) flashes at every heartbeat. When the measurement is complete, the arm cuff completely deflates.

**NOTE:** Do not move your arm and remain still until the entire measurement process is completed.

4. Check the progress of the consecutive measurements.

**NOTE:** If a measurement fails, the monitor will repeat taking a measurement up to five times during the consecutive measurement process.

The first measurement is complete, waiting to start the next measurement. The interval of time set between each measurement will appear on the display.

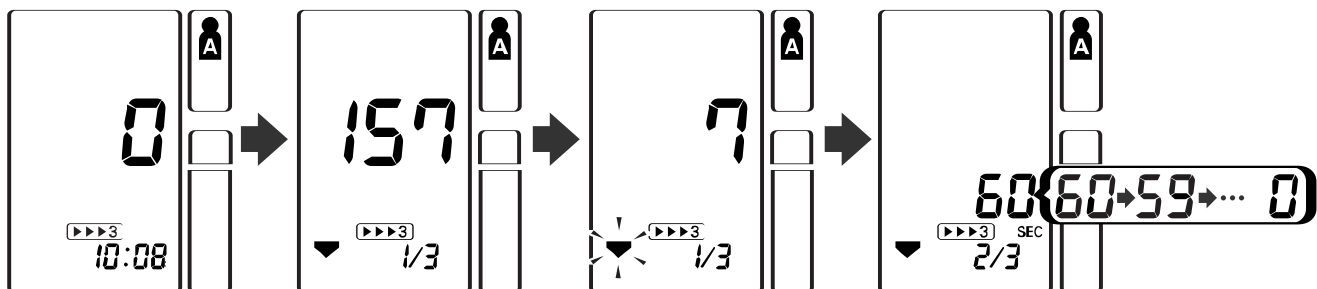

# TAKING A MEASUREMENT

The second measurement is complete, waiting to start the next measurement.

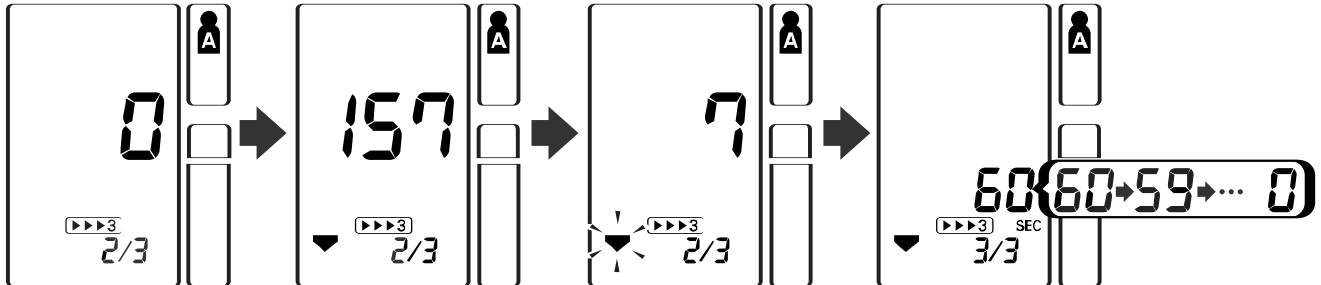

The consecutive measurements are complete. The average for three measurements appears on the display.

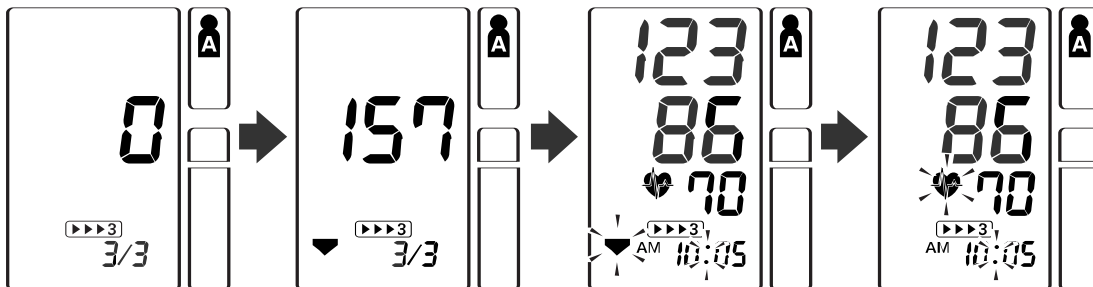

5. Press the SET button to display the blood pressure and pulse rate for the first measurement. Press the SET button again to display the next measurement.
6. Press the START/STOP button to turn the monitor off.

# TAKING A MEASUREMENT

## SPECIAL CONDITIONS

### ⚠ CAUTION

Inflating to a higher pressure than necessary may result in bruising where the cuff is applied.

If your systolic pressure is known to be more than 220 mmHg, press and hold the START/STOP button until the monitor inflates 30 to 40 mmHg higher than your expected systolic pressure.

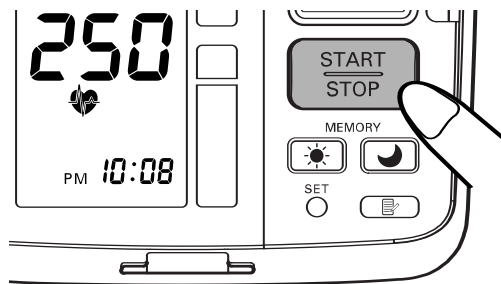

- NOTES:**
- Do not apply more pressure than necessary.
  - The monitor will not inflate above 299 mmHg.

When the measurement is complete, the arm cuff completely deflates. Your blood pressure and pulse rate are displayed.

# USING THE MEMORY FUNCTION

The monitor is designed to store the blood pressure and the pulse rate in the memory for two people (USER A and USER B) every time a measurement is completed.

The monitor automatically stores up to 84 sets of measurement values (blood pressure and pulse rate) for each user (A and B). When 84 sets of measurement values are stored, the oldest record is deleted to save the most recent values. The monitor also stores 8 weeks of Morning Averages and 8 weeks of Evening Averages for each user (A and B).

## AVERAGING FUNCTION

The monitor calculates the average reading based on the three most recent sets of measurement values taken within 10 minutes of the most recent reading.

**NOTE:** If two sets of measurement values are stored in the memory for the 10 minutes period, the average is based on the two sets of measurement values. If one set of measurement values is stored, this is displayed as the average.

# USING THE MEMORY FUNCTION

## TO DISPLAY THE MEASUREMENT VALUES

1. Select your USER ID (A or B).
2. Press the Memory button (  ).

The Average Symbol (  ) appears on the display when the average reading is shown.

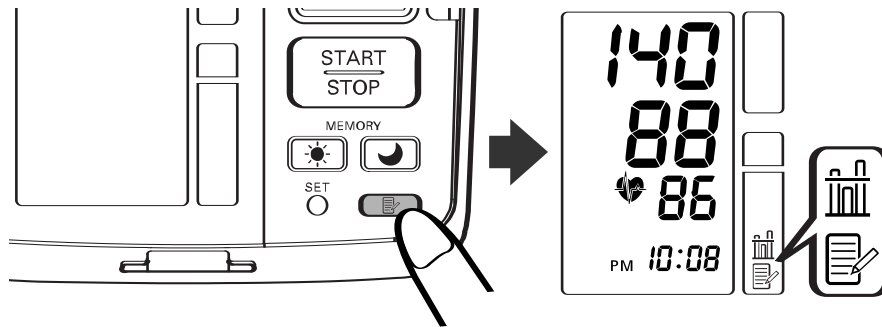

# USING THE MEMORY FUNCTION

3. Press the Memory button (  ) to display the most recent set of measurement values on the screen. The values are displayed from the most recent to the oldest.

**NOTE:** The date and time are alternately displayed with the measurement values.

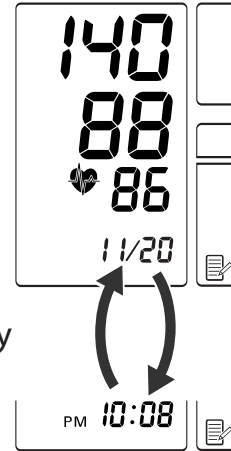

Alternating display

Press the Memory button to display the next set of values.

Press and hold the Memory button to display the values faster.

## TruRead™ Mode

The average for the consecutive measurements appears on the display with the TruRead™ symbol (  ). To display the values for the individual measurements press the SET button while the average is displayed.

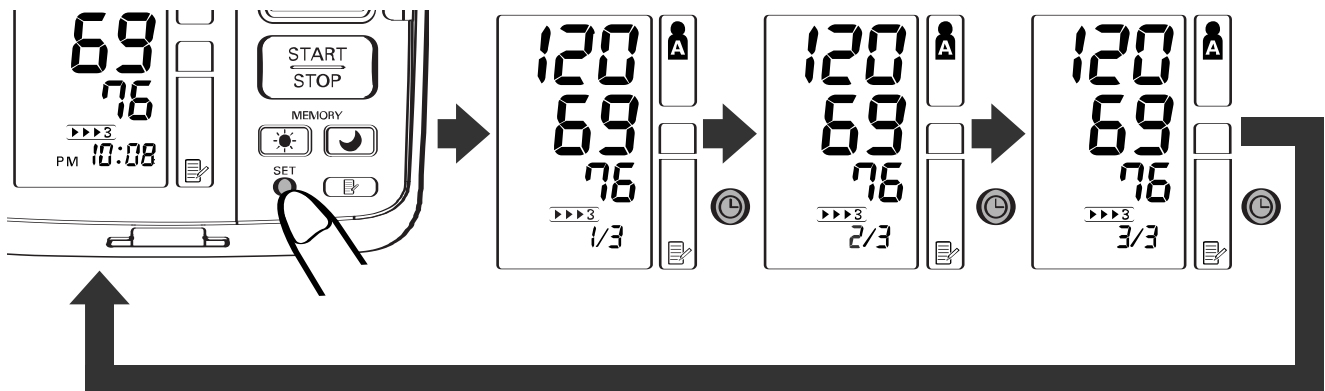

4. Press the START/STOP button to turn the power off.

# USING THE MEMORY FUNCTION

## MORNING AND EVENING AVERAGES

The monitor calculates and displays a weekly average for measurements taken in the morning (☀) and evening (☾). The monitor stores 8 weeks of Morning Averages and 8 weeks of Evening Averages for each user (A and B).

**NOTE:** The week begins Sunday at 4:00 AM

## MORNING AVERAGES

Morning averages are based on the first average reading using the TruRead™ Mode or the first reading using the Single Mode.

Measurement times must be between:

**4:00 AM and 9:59 AM.**

## EVENING AVERAGES

Evening averages are based on the last average reading using the TruRead™ Mode or the last reading using the Single Mode.

Measurement times must be between:

**7:00 PM and 1:59 AM.**

# USING THE MEMORY FUNCTION

## TO DISPLAY MORNING AND EVENING AVERAGES

1. Select your USER ID (A or B).
2. Press the Morning Average button

(☀️) or the Evening Average button (🌙).

The average for the current week “THIS WEEK” appears on the display.

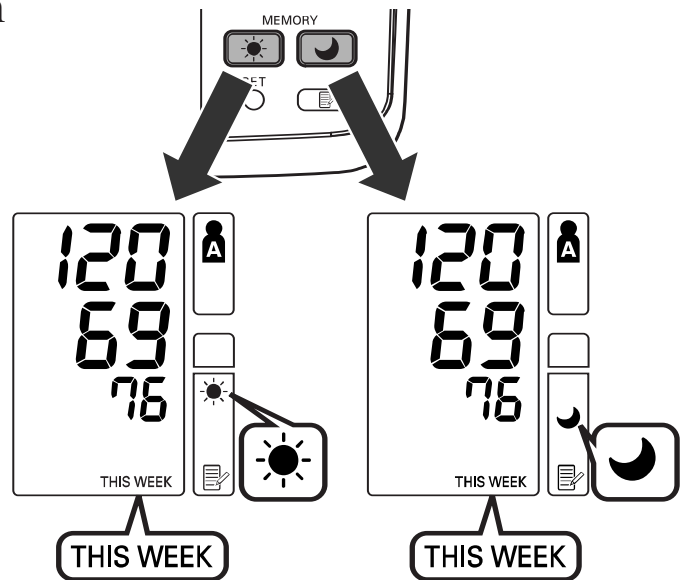

3. Continue to press the Morning Average button (☀️) or the Evening Average button (🌙) to display the previous weeks. The monitor displays “-1 WEEK” for the previous week to “-7 WEEK” for the oldest set of averages.

**NOTE:** If no measurement is taken in a given week, the display will appear as illustrated.

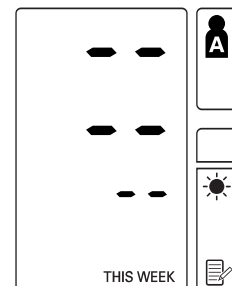

4. Press the START/STOP button to turn the monitor off.



# USING THE MEMORY FUNCTION

## DISPLAY COMBINATIONS

In addition to the Morning Average and Evening Average Symbols, the monitor may also display the Morning Hypertension Symbol if the morning average for that week is above the AHA guidelines. (See page 12 for details.) Depending on your measurement results, these may be displayed in the following combinations.

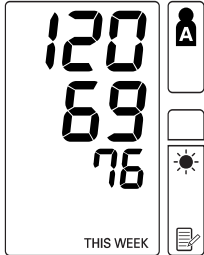
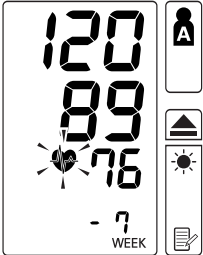
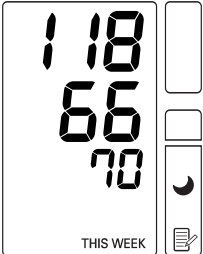
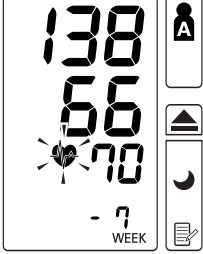
	Display	
<b>Morning Average</b>	 <p>Morning average from This Week with Morning Average Symbol</p>	 <p>Morning average from 7 weeks ago with Morning Average Symbol + blinking Heartbeat Symbol + Morning Hypertension Symbol</p>
<b>Evening Average</b>	 <p>Evening average from This Week with Evening Average Symbol</p>	 <p>Evening average from 7 weeks ago with Evening Average Symbol + blinking Heartbeat Symbol + Morning Hypertension Symbol</p>
	<b>Average within AHA guidelines</b>	<b>Average above AHA guidelines + Morning Hypertension</b>

# USING THE MEMORY FUNCTION

The Morning Hypertension Symbol (▲) appears if the weekly average for morning measurements is above 135/85.

In this case the Morning Hypertension Symbol (▲) is displayed when the Evening Average is displayed, regardless of the values for the Evening Average.

## TO DELETE ALL VALUES STORED IN THE MEMORY

The values stored in the memory are deleted by USER ID.

You cannot partially delete values stored in the memory. All values for the user you select will be deleted.

1. Select your USER ID (A or B).
2. While holding the Memory button (☰) and the START/STOP button simultaneously for more than 2 seconds all values will be deleted.

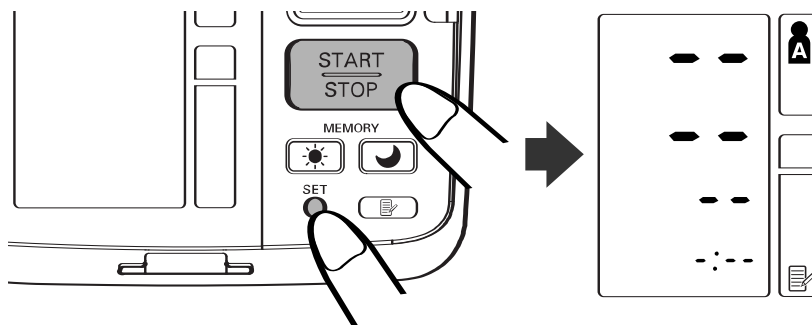

# CARE AND MAINTENANCE

*To keep your digital blood pressure monitor in the best condition and protect the unit from damage, follow the directions listed below:*

**Close the monitor cover** when not in use.



**Do not forcefully bend** the arm cuff or air tube. Do not fold tightly.

**⚠ CAUTION**

Do not store the AC adapter in the cuff compartment. This may damage the cuff.

**Clean the monitor with a soft dry cloth.** Do not use any abrasive or volatile cleaners. Do not attempt to clean the cuff.

**⚠ CAUTION**

Do not submerge the device or any of the components in water. Do not subject the monitor to extreme hot or cold temperatures, humidity or direct sunlight.

**⚠ CAUTION**

Store the device and the components in a clean, safe location.

**⚠ CAUTION**

Do not subject the monitor to strong shocks, such as dropping the unit on the floor.

# CARE AND MAINTENANCE

**Remove the batteries** if the unit will not be used for three months or longer. Always replace all the batteries with new ones at the same time.

**Use the unit consistent with the instruction provided in this manual.**

**⚠ CAUTION**



Changes or modification not approved by Omron Healthcare will void the user warranty. Do not disassemble or attempt to repair the unit or components.

**⚠ CAUTION**

Use only Omron authorized parts and accessories. Parts and accessories not approved for use with the device may damage the unit.

# ERROR INDICATORS AND TROUBLESHOOTING TIPS

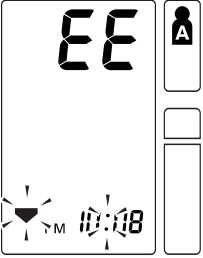
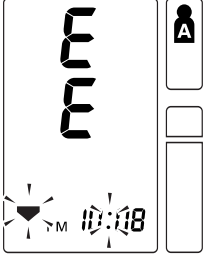
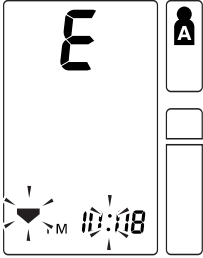
## ERROR INDICATORS

SYMBOL	CAUSE	CORRECTION
	<p>Cuff under-inflated. Cuff not applied correctly.</p>	<p><b>Single Mode</b> Remove the arm cuff. Read, “Taking a Measurement”. Take another measurement.</p> <p><b>TruRead™ Mode</b> The monitor will repeat the process up to 5 times.</p>
	<p>Cuff over-inflated</p>	
	<p>Monitor could not detect pulse wave.</p>	<p>Take another measurement and remain still until the measurement is complete.</p>
	<p>Air plug is not connected.</p>	
	<p>Batteries are worn</p>	<p>Replace the four batteries. Refer to “Battery Installation.”</p>

# ERROR INDICATORS AND TROUBLESHOOTING TIPS

## TROUBLESHOOTING TIPS

<b>PROBLEM</b>	<b>CAUSES AND SOLUTIONS</b>
No power. No display appears on the unit.	Replace all four batteries with new ones. Check the battery installation for proper placement of the battery polarities.
Measurement values appear too high or too low.	Blood pressure varies constantly. Many factors including stress, time of day, and how you wrap the cuff, may affect your blood pressure. Review the sections “Before Taking a Measurement” and “Taking a Measurement.”

# FCC STATEMENT

**Note:****POTENTIAL FOR RADIO/TELEVISION INTERFERENCE (for U.S.A. only)**

This product has been tested and found to comply with the limits for a Class B digital device, pursuant to part 15 of the FCC rules.

These limits are designed to provide reasonable protection against harmful interference in a residential installation. The product generates, uses, and can radiate radio frequency energy and, if not installed and used in accordance with the instructions, may cause harmful interference to radio communications. However, there is no guarantee that interference will not occur in a particular installation. If the product does cause harmful interference to radio or television reception, which can be determined by turning the product on and off, the user is encouraged to try to correct the interference by one or more of the following measures:

- Reorient or relocate the receiving antenna.
- Increase the separation between the product and the receiver.
- Connect the product into an outlet on a circuit different from that to which the receiver is connected.
- Consult the dealer or an experienced radio/TV technician for help.

**POTENTIAL FOR RADIO/TELEVISION INTERFERENCE (for Canada only)**

This digital apparatus does not exceed the Class B limits for radio noise emissions from digital apparatus as set out in the interference-causing equipment standard entitled “Digital Apparatus”, ICES-003 of the Canadian Department of Communications.

Cet appareil numérique respecte les limites de bruits radioélectriques applicables aux appareils numériques de Classe B prescrites dans la norme sur le matériel brouilleur: “Appareils Numériques”, ICES-003 édictée par le ministre des communications.

Changes or modifications not expressly approved by the party responsible for compliance could void the user’s authority to operate the equipment.

# WARRANTY

Your HEM-775 IntelliSense® Automatic Blood Pressure Monitor, excluding the arm cuff, is warranted to be free from defects in materials and workmanship appearing within 5 years from the date of purchase, when used in accordance with the instructions provided with the monitor. The arm cuff is warranted to be free from defects in materials and workmanship appearing within one year from the date of purchase when the monitor is used in accordance with the instructions provided with the monitor. The above warranties extend only to the original retail purchaser.

We will, at our option, repair or replace without charge any monitor or arm cuff covered by the above warranties. Repair or replacement is our only responsibility and your only remedy under the above warranties.

To obtain warranty service contact Omron Healthcare for the address of the repair location. Shipping instructions and repair information is available by calling **1-800-634-4350** or visit our website at [www.omronhealthcare.com](http://www.omronhealthcare.com).

Enclose the Proof of Purchase. Include \$5.00 for the return shipping and handling. Include a letter, with your name, address, phone number, and description of the specific problem. Pack the product carefully to prevent damage in transit. Because of possible loss in transit, we recommend insuring the product with return receipt requested.

**ALL IMPLIED WARRANTIES, INCLUDING BUT NOT LIMITED TO THE IMPLIED WARRANTIES OF MERCHANTABILITY AND FITNESS FOR PARTICULAR PURPOSE, ARE LIMITED TO THE DURATION OF THE APPLICABLE WRITTEN WARRANTY ABOVE.** Some states do not allow limitations on how long an implied warranty lasts, so the above limitation may not apply to you.

**OMRON SHALL NOT BE LIABLE FOR LOSS OF USE OR ANY OTHER INCIDENTAL, CONSEQUENTIAL OR INDIRECT COSTS, EXPENSES OR DAMAGES.** Some states do not allow the exclusion or limitation of incidental or consequential damages, so the above exclusions may not apply to you.

This warranty gives you specific legal rights, and you may also have other rights which may vary from state to state.

## FOR CUSTOMER SERVICE

Visit our web site at:

[www.omronhealthcare.com](http://www.omronhealthcare.com)

Call toll free:

1-800-634-4350



# SPECIFICATIONS

Model:	<b>HEM-775</b>
Display:	LCD Digital Display
Measurement Range:	Pressure: 0 to 299 mmHg, Pulse: 40-180/min.
Accuracy/Calibration:	Pressure: $\pm 3$ mmHg or 2% of reading Pulse: $\pm 5$ % of reading
Inflation:	Automatic by electric pump
Deflation:	Automatic pressure release valve
Rapid Air Release:	Automatic exhaust valve
Pressure Detection:	Capacitive pressure sensor
Measurement Method:	Oscillometric method
Pulse Wave Detection:	Capacitance type pressure sensor
Power Source:	120V 60Hz AC adapter or 4 "AA" batteries
Battery Life:	Approx. 1400 uses when used 6 times a day with 4 new alkaline batteries
Operating Temperature /Humidity:	50°F to 104°F (10°C to 40°C) /30 to 85% RH
Storage Temperature /Humidity/Air Pressure:	-4°F to 140°F (-20°C to 60°C) /10 to 95% RH /700 - 1060 hPa
Main Unit Weight:	Approximately 33.9 oz. (960 g) not including batteries
Main Unit Dimensions:	Approximately 9 3/4" (l) $\times$ 7" (w) $\times$ 4 3/8" (h) (Approximately 249 mm $\times$ 178 mm $\times$ 110 mm)
Cuff Size:	Approximately 6" (w) (152 mm) Cuff tube 23 5/8" (l) (600 mm)
Cuff Circumference:	Fits arm circumferences 9" to 17" 220 mm to 420 mm
Memory:	Up to 84 per user
Weekly Averages:	Up to 8 weeks
Contents:	Main Unit, ComFit™ Cuff, AC Adapter, Instruction Manual, 4 "AA" Batteries and Warranty Card
UPC Code:	0 73796 85775 2

**NOTE: These specifications are subject to change without notice.**

# NOTES

# NOTES

Manufactured by OMRON HEALTHCARE

Made in China

Distributed by:

**OMRON HEALTHCARE, INC.**

1200 Lakeside Drive

Bannockburn, Illinois 60015

[www.omronhealthcare.com](http://www.omronhealthcare.com)

Copyright © 2006 Omron Healthcare, Inc.  
HEM-775INST Rev