

OMRON

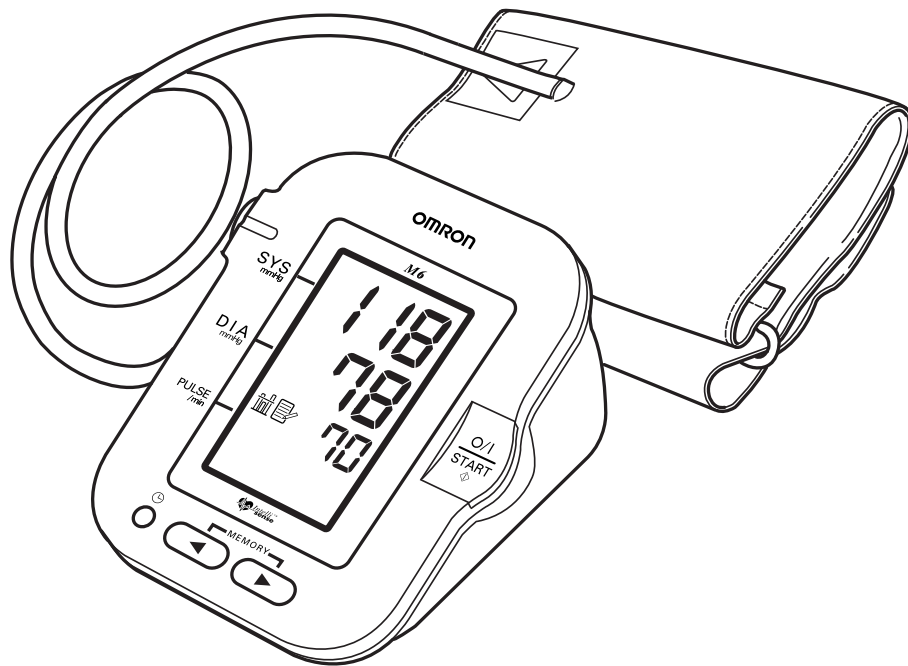

Digital Automatic Blood Pressure Monitor Model M6

- **Instruction Manual**
- **Mode d'emploi**
- **Gebrauchsanweisung**
- **Manuale de instructone**
- **Manual de instrucciones**
- **Gebruiksaanwijzing**
- **РУКОВОДСТВО ПО ЭКСПЛУАТАЦИИ**

EN

FR

DE

IT

ES

NL

RU



A Good Sense of Health

IM-HEM-7001-E-02-08/08
1638166-1C

Contents

Introduction	3
Important Safety Information	4
1. Overview	5
2. How to Obtain Meaningful Readings.....	7
3. Preparation	8
3.1 Installing/Replacing the Batteries.....	8
3.2 Setting the Date and Time	9
4. Using the Monitor.....	11
4.1 Applying the Arm Cuff	11
4.2 Taking a Reading.....	14
4.3 Using the Memory Function	18
5. Handling Errors and Problems	20
6. Optional Parts.....	21
7. Storage and Maintenance.....	22
8. Technical Data.....	23
9. Some Useful Information about Blood Pressure	25

Introduction

The OMRON M6 is a compact, fully automatic blood pressure monitor, operating on the oscillometric principle. It measures your blood pressure and pulse rate simply and quickly. For comfortable controlled inflation without the need of pressure pre-setting or re-inflation the device uses its advanced “Intelli-Sense” technology.

The device also stores up to 90 measurements in memory and calculates an average value based on the last three measurements. Each measurement is stored along with the date and time of measurement.



Important Safety Information

- Blood pressure measurement is not suitable in cases of serious arteriosclerosis (hardening of the arteries).
- The pulse display is not suitable for monitoring the frequency of cardiac pacemakers.
- Pregnant women should only measure their own blood pressure in consultation with their doctor, since the readings can be changed by pregnancy.
- Do not use the monitor on babies, young children or persons who cannot express their consent.
- Do not use the monitor for any purpose other than measuring blood pressure.
- Do not use a cellular phone near the monitor. This may result in the monitor operating incorrectly.
- The battery liquid may leak and damage the monitor. Please observe the following points.
 - When you are not going to use the unit for a long period of time (approximately three months or more), take out the batteries.
 - Replace old batteries with new ones immediately.
 - Do not use old and new batteries together.
 - Do not insert the batteries with their polarities incorrectly aligned.
- Please remember: Self-measurement is not the same as medical treatment.
- You should never change the dose of medicines prescribed by your doctor but you can help your doctor to optimize the treatment by documenting the measured values. If there are unusual values, please inform your doctor immediately.
- Never unplug the power cord with wet hands.
- Use only the original AC adapter designed for this unit. Use of unsupported adapters may damage the device.

1. Overview

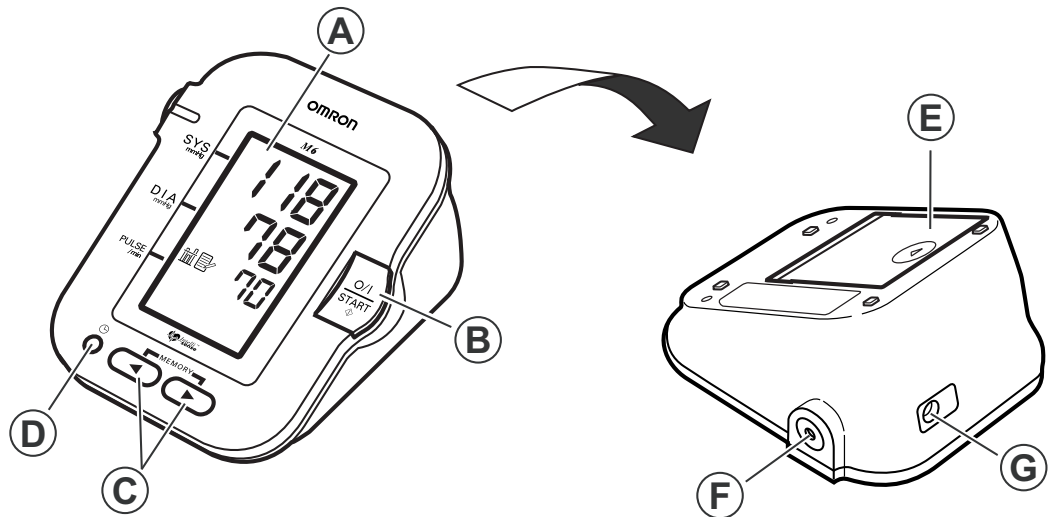
Monitor



- | | |
|---|--|
| A. Display | E. Battery compartment |
| B. O/I START button | F. Air jack |
| C. Memory ( ) buttons | G. AC adapter jack (for optional AC adapter) |
| D. Date/Time () setting button | |

Display

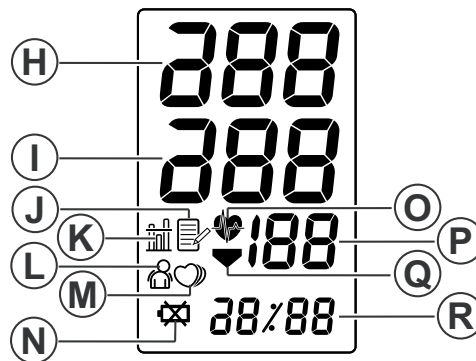

- H. Systolic blood pressure
- I. Diastolic blood pressure
- J. Memory display
- K. Average value display
- L. Movement error display
- M. Irregular heartbeat display
- N. Battery low display

- O. Heartbeat display
- P. Pulse display
- Q. Deflation display
- R. Date/Time display

Package contents

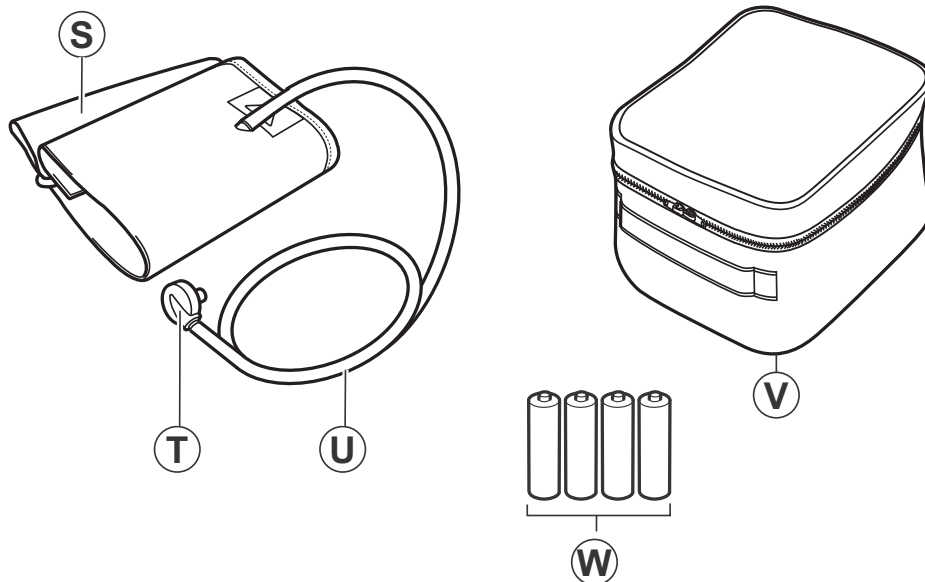

- S. Arm cuff (Medium cuff: arm circumference 22-32 cm)
- T. Air plug
- U. Air tube

- V. Storage case
- W. Four "AA" alkaline (LR6) batteries

2. How to Obtain Meaningful Readings

To help ensure a reliable reading, avoid eating, smoking, or exercising for at least 30 minutes before taking a measurement.

Note: Remove any tight-fitting clothing from your upper arm.

1. Sit on a chair with your feet flat on the floor and place your arm on a table so that the arm cuff will be at the same level as your heart.

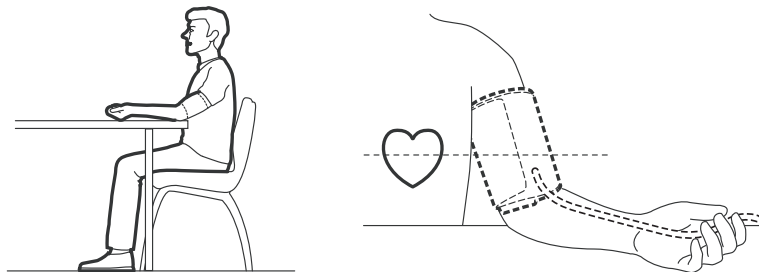

2. Apply the arm cuff to your upper arm. The coloured marker should be centred on the inside of your arm and point down the inside of the arm, so that the air tube runs down the inside of your forearm and is in line with your middle finger.

3. Secure the cuff around your arm using the fabric fastener strip.

4. Press the O/I START button.

When measurement is complete, the monitor displays your blood pressure and pulse rate, and automatically deflates the cuff.

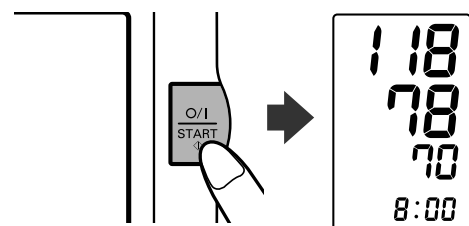

Notes:

- Always wait at least 2-3 minutes before taking another blood pressure measurement.
- Please note that all measurement are stored in the memory. If different people measure with the same device make sure that you are aware of this fact.

3. Preparation

3.1 Installing/Replacing the Batteries

1. Remove the battery cover.

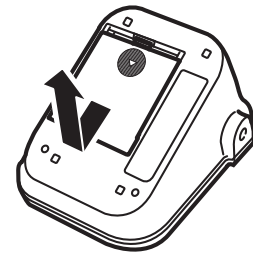

2. Insert four “AA” batteries as indicated in the battery compartment and then replace the battery cover.

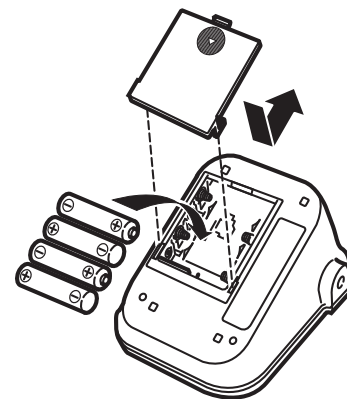

Notes:

- If the battery low display () appears on the display, replace all four batteries at the same time. Long-life alkaline batteries are recommended.
- Remove the batteries if the monitor will not be used for three months or more.
- If the batteries are removed for a long period of time, the Date/Time setting will need to be reset. See “Setting the Data and Time” for details.
- Dispose of batteries according to applicable local regulations.

3.2 Setting the Date and Time

Your blood pressure monitor automatically stores up to 90 measurements values in its memory and calculates an average reading based on the measurements from the last three readings.

- Set the monitor to the correct date and time before taking a measurement for the first time.
- If the batteries have been removed for a long period of time, the date and time setting will need to be reset.

1. When the batteries are installed, the year digits will flash in the display when you turn on the monitor.

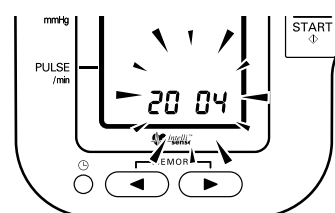

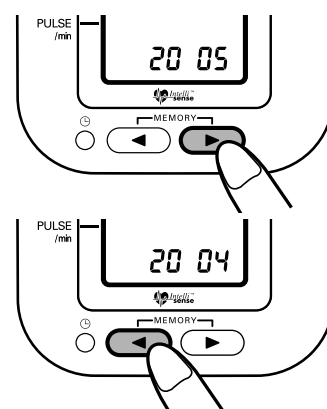

Note: If you need to reset the date and time for some reason, hold down the  button while the power is off.

2. Press the  button to advance the digits one at a time.



To change the digits to a lower number, press the  button to lower the digits one at a time.

If you hold down the  or  button, the digits will advance (or lower) rapidly.

3. Press the  button to confirm the setting when the desired number appears on the display.

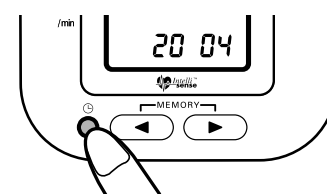

4. Repeat steps 2 and 3 to set the month and date (day).

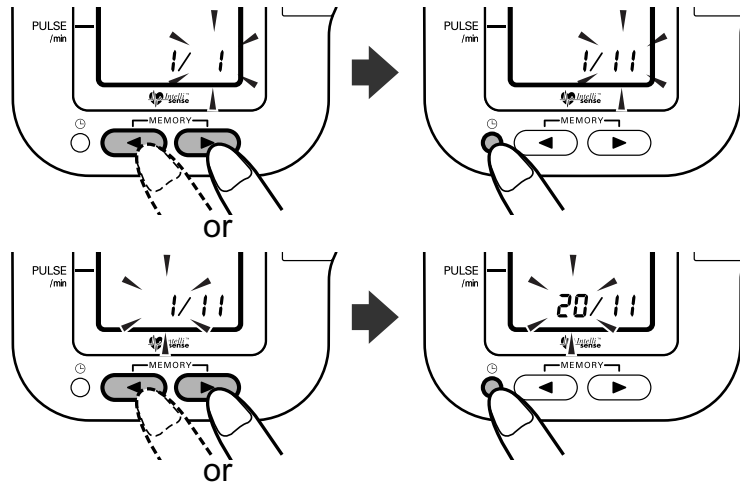

5. Repeat steps 2 and 3 to set the hour and minutes for the time.

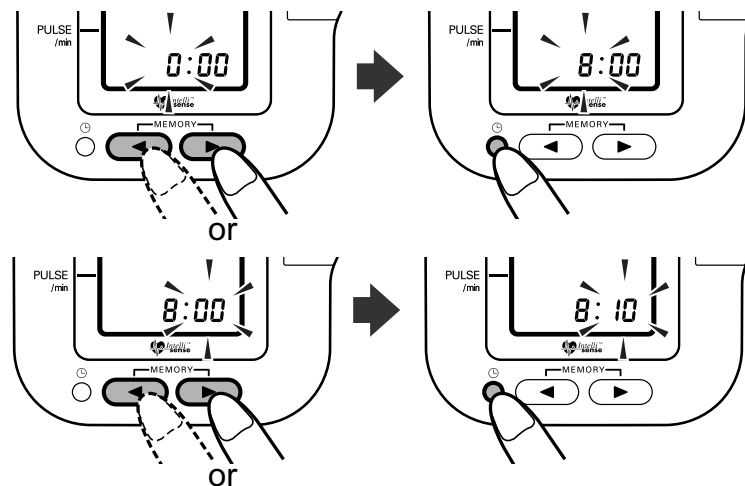

6. Press the O/I START button when you have finished setting the date and time.

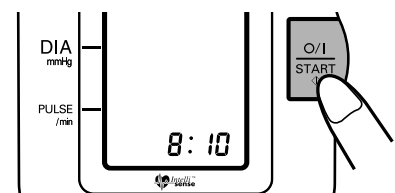

4. Using the Monitor

4.1 Applying the Arm Cuff

You can wrap the cuff either on your right or left arm.

- Remove tight-fitting clothing from your upper arm.
- Do not place the cuff over thick clothes and do not roll up your sleeve if it is too tight.

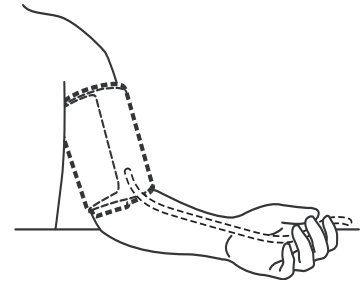

1. If the cuff is assembled correctly, the hook material will be on the outside of the cuff loop and the metal D-ring will not touch your skin.

Note: If the cuff is not assembled, pass the end of the cuff furthest from the tubing through the metal D-ring to form a loop. The smooth cloth should be on the inside of the cuff loop.

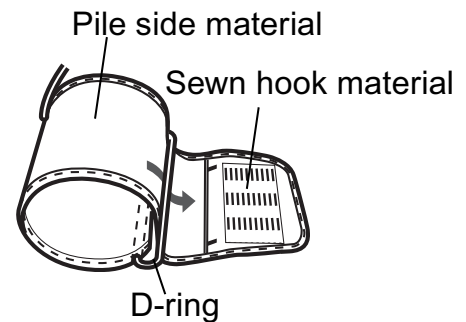

2. Insert the air plug into the air jack (on the left side of the device).

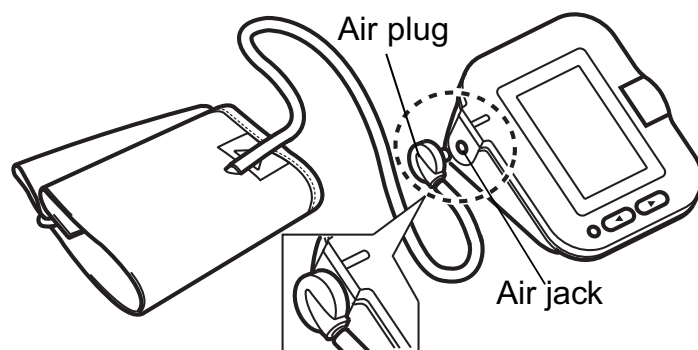

The cuff must be fully deflated when it is inserted into the air jack.

- 3.** Sit in a chair with your feet flat on the floor and place your arm on a table so that the cuff will be at the same level as your heart.

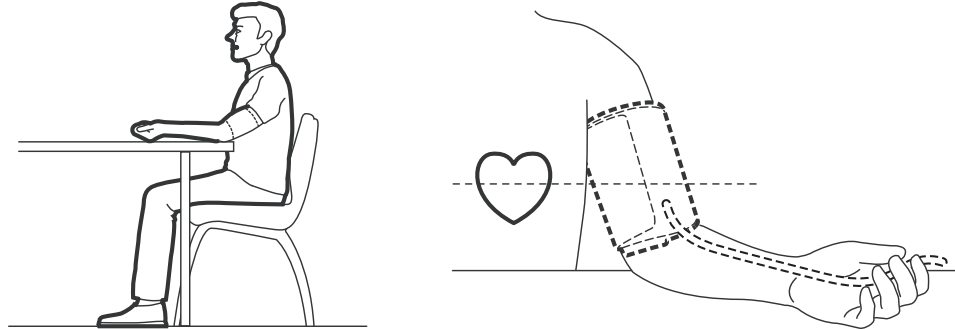

- 4.** Put your arm through the cuff loop.

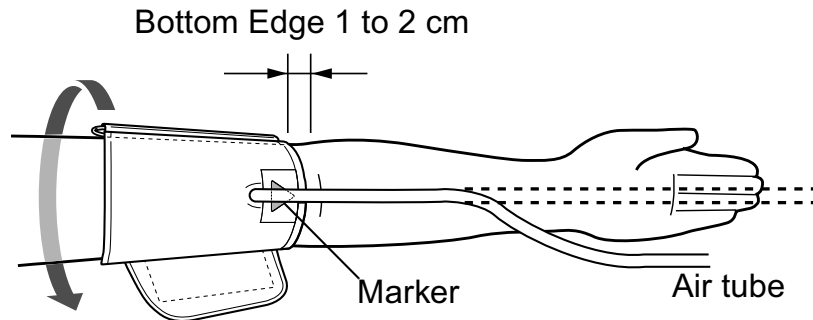

The bottom of the cuff should be approximately 1 to 2 cm above the elbow.

Apply the cuff to your upper arm so that the coloured marker is centred on the middle of your inner arm and points down the inside of the arm. The air tube should run down the inside of your forearm and be in line with your middle finger.

5. Pull the cuff so that the top and bottom edges are tightened evenly around your arm.

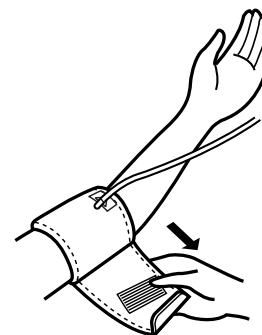

6. When the cuff is positioned correctly, close the fabric fastener FIRMLY.

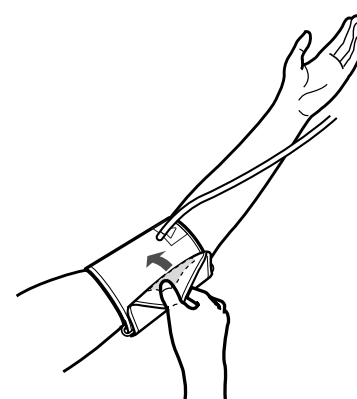

Notes:

- Make certain the cuff fits snugly around your arm.
- The cuff should make good contact with your skin. You should be able to fit your index finger between the cuff and your arm easily, so you can pull the cuff off and on.
- Make sure that there are no kinks in the air tubing.

EN

Taking measurements on the right arm

Please note the following points when applying the cuff to your right arm. Apply the cuff so that the air tube is at the side of your elbow.

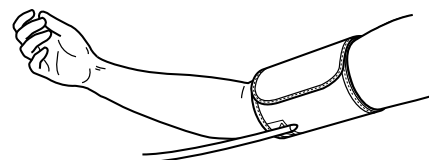

Notes:

- Be careful not to rest your arm on the air tube, or otherwise restrict the flow of air to the cuff.
- Apply the arm cuff so that no part of the cuff is positioned over the elbow joint. The cuff should be 1 to 2 cm above the elbow.

4.2 Taking a Reading

1. Press the O/I START button and remain still, the cuff will start to inflate automatically.

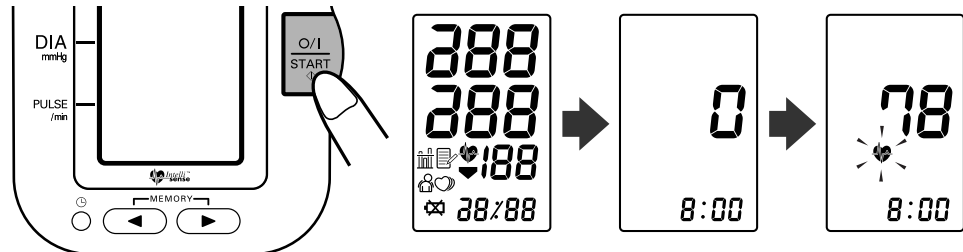

As the cuff begins to inflate, the monitor automatically determines your ideal inflation level. Remain still and do not talk until measurement is completed.

Note: Do not inflate the cuff if it is not wrapped around your arm.

2. Inflation stops automatically and measurement is started.

As the cuff slowly deflates, decreasing numbers appear on the display and the Heart-beat display  flashes at every heartbeat.

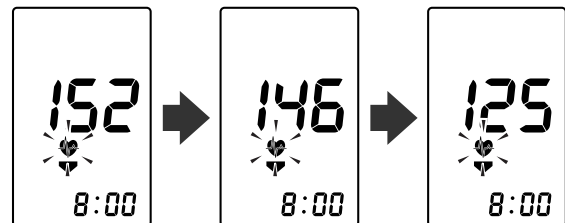

In rare circumstances, the monitor might re-inflate the cuff to continue with the measurement.

3. When the measurement is complete, the arm cuff completely deflates and your blood pressure and pulse rate are displayed.

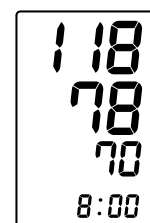



Note: The monitor automatically stores the blood pressure readings and pulse rate along with date and time of measurement in its memory.

4. Press the O/I START button to turn the monitor off.

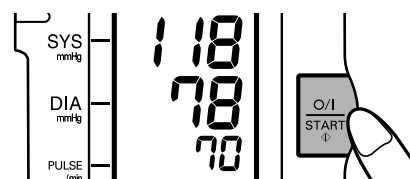
Note: If you forget to turn the monitor off, it will automatically shut itself off after five minutes.



Important:

- Wait 2-3 minutes before taking another blood pressure measurement. Waiting between readings allows the arteries to return to the condition prior to taking the blood pressure measurement.
- If you move during measurement, the movement display () may appear. Repeat the measurement and remain still until the measurement is complete.
- Your blood pressure monitor includes an irregular heartbeat feature. Irregular heartbeats can influence the results of the measurement. The irregular heartbeat algorithm automatically determines if the measurement is usable or needs to be repeated. If the irregular heartbeat display () is shown after your have taken a measurement, repeat the measurement. If the irregular heartbeat display () is shown frequently, please make your doctor aware of it.

Instructions for special conditions

If your systolic pressure is known to be more than 220 mmHg, after the cuff starts to inflate, press and hold the O/I START button until the monitor inflates 30 to 40 mmHg higher than your suspected systolic pressure.





Important:

- The monitor will not inflate above 300 mmHg.
- Do not apply more pressure than necessary.

What is Irregular Heartbeat?

An irregular heartbeat is a heartbeat rhythm that varies by more than 25% from the average heartbeat rhythm detected while the unit is measuring the systolic and diastolic blood pressure.

If such an irregular rhythm is detected more than twice during measurement,

the irregular heartbeat display () appears on the display when the measurement results are displayed. If too many irregular rhythms are detected during measurement, the irregular heartbeat display appears () but no measurement is displayed.

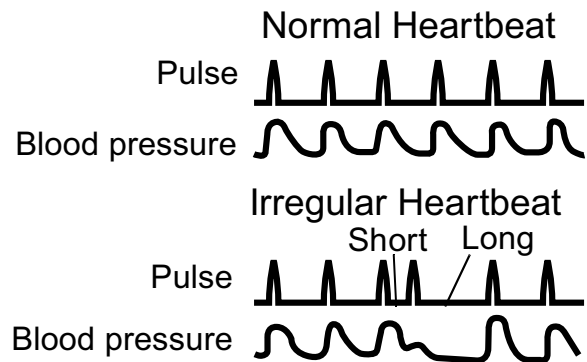

What is Arrhythmia?

A heartbeat is stimulated by electrical signals that cause the heart to contract.

Arrhythmia is a condition where the heartbeat rhythm is abnormal due to flaws in the bio-electrical system that drives the heartbeat. Typical symptoms are skipped heartbeats, premature contraction, an abnormally rapid (tachycardia) or slow (bradycardia) pulse. This can be caused by heart disease, aging, physical predisposition, stress, lack of sleep, fatigue etc. Arrhythmia can only be diagnosed by a doctor through a special examination.

Whether the appearance of irregular heartbeat display () in the results indicates arrhythmia or not can only be determined by an examination and diagnosis by your doctor.

If the irregular heartbeat display () is shown frequently, please make your doctor aware of it. Conducting self-diagnosis and treatment based on measurement results is dangerous. Be sure to follow the instructions of your doctor.

4.3 Using the Memory Function

This monitor has a memory capable of storing 90 sets of readings. Every time you complete the measurement, the monitor automatically stores blood pressure and pulse rate. The monitor also calculates an average reading based on the measurements from the last three readings.

Note: To ensure that the measurement results are recorded correctly, make sure that the date and time are set correctly before taking a measurement.

When 90 sets of readings are stored in memory, the oldest set will be deleted to store a new set.

The date and time of stored readings will be alternately displayed.

To View the Average Value

Press the  memory button.



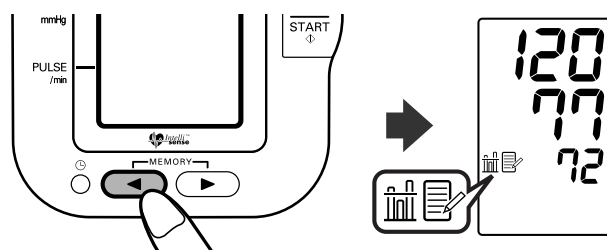

The average values, based on the last three measurements, is displayed.

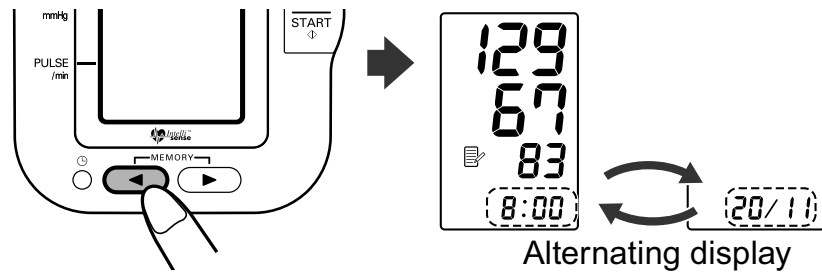

To View Previous Readings Stored in Memory

1. Press the  button, while the average reading is displayed, to view reading stored in memory from the most recent to the oldest.



2. Press the  or  button repeatedly to cycle through the previous measurement values
( button: from the most recent to the oldest,
 button: from the oldest to the most recent)

Keep the button pressed down to cycle rapidly through the previous values.

To Delete All the Values Stored in Memory

Caution!

You cannot delete the stored readings partially, all the reading in the monitor will be deleted.

To delete stored readings, press the  memory button and the O/I START button simultaneously, then all the readings will be deleted.

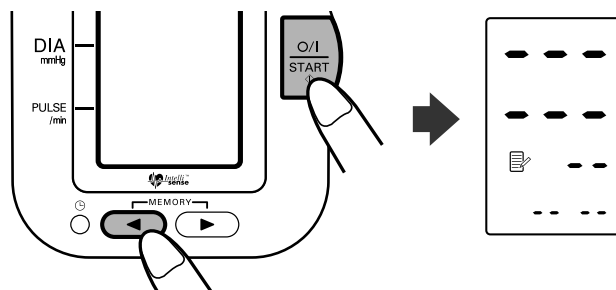

5. Handling Errors and Problems

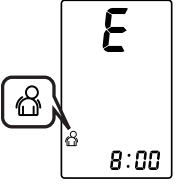
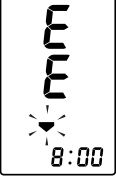
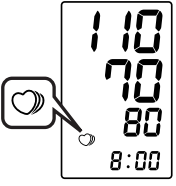
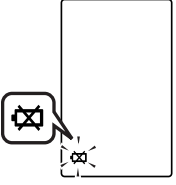
Error Display	Cause	Remedy
	Cuff is under inflated.	Carefully read and repeat the steps listed under “Taking a Reading” on p. 14.
	Movement during measurement	
	Cuff over inflated.	
	This icon indicates irregular or weak pulses are detected, but result can be considered reliable.	Remove the arm cuff. Wait 2-3 minutes and then take another measurement. Repeat the steps in “Taking a Reading” on p. 14. If this error continues to appear, contact your physician.
	Batteries have run down.	Replace all four “AA” batteries with new ones.

6.Optional Parts

Problem	Cause	Remedy
No display appears when the O/I START button is pressed.	The batteries are empty.	Replace the batteries.
Cannot measure or readings are too high.	Is the cuff wrapped firmly around the arm?	Attach the arm cuff correctly.
	The cuff pressure does not rise although the pump motor can be heard.	Check that the air plug is properly connected to the monitor. Push the air plug firmly into the air jack.
The blood pressure is different each time. The reading is extremely low (or high).	Blood pressure readings constantly vary with time of measurement and nervous condition. Take deep breaths to relax before taking a measurement.	

6. Optional Parts

AC Adapter (Q-adapter or F-adapter)

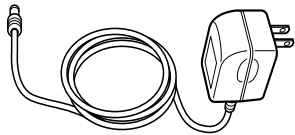

Small cuff

Arm circumference 17 - 22 cm



Large cuff

Arm circumference 32 - 42 cm



7. Storage and Maintenance

To protect your monitor from damage, please observe the following:

- Do not subject your monitor and cuff to extreme temperatures, humidity, moisture or direct sunlight.
- Do not fold the cuff or tubing tightly.
- Do not disassemble the monitor.
- Do not carry out repairs of any kind yourself. If a defect occurs, consult the OMRON distributor or Customer Services as mentioned on the packaging, or seek the advice of your surgical appliance stockist or pharmacist.
- The OMRON M6 is a precision measuring device. It is important that the accuracy remains within the specifications. It is recommended that you have the monitor inspected every two years to ensure it is accurate and functioning correctly. Consult the OMRON distributor or Customer Services as mentioned on the packaging for further details.
- Do not subject the monitor to strong shocks or vibrations (for example, dropping the monitor on the floor.)
- Do not use volatile liquids to clean the monitor. **THE MONITOR SHOULD BE CLEANED WITH A SOFT, DRY CLOTH.**
- Do not wash the arm cuff or immerse it in water.

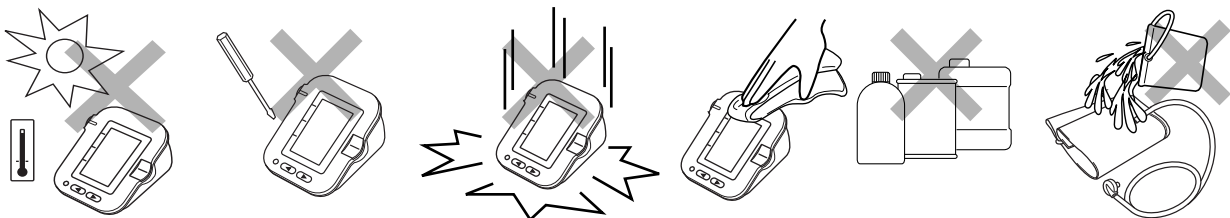

EN

Storage

Keep the monitor in its storage case when not in use.

Note: If you are using the optional AC adapter, make sure that the adapter is placed under the cuff and monitor so that it does not damage the display.

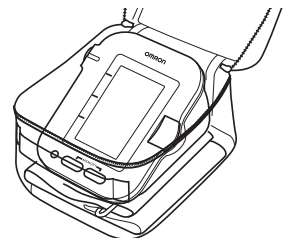

8. Technical Data

Model	OMRON M6 (HEM-7001-E)
Display	LCD Digital Display
Measurement Method	Oscillometric method
Measurement Range	Pressure: 0 mmHg to 299 mmHg Pulse: 40 to 180/min.
Accuracy	Pressure: ± 3 mmHg Pulse: $\pm 5\%$ of display reading
Inflation	Fuzzy-logic controlled by electric pump
Deflation	Automatic pressure release valve
Memory	90 Measurements with date and time
Power Source	4 "AA" batteries 1.5V or AC/ DC adapter (optional, 6V = 4W)
Battery life	Capacity of new alkaline batteries is approx. 1500 measurements
Operating temperature/ Humidity	+10°C to +40°C Maximum: 30 to 90% RH
Storage temperature Humidity	-20°C to +60°C Maximum: 10 to 95% RH
Console Weight	Approximately 355g without batteries
Cuff Weight	Approximately 135g
Outer Dimensions	Approximately 131 (l) mm \times 155 (w) mm \times 84(h) mm
Cuff Dimensions	Approximately 140 mm \times 480 mm (Medium cuff: arm circumference 22 to 32 cm)
Package Content	Medium cuff, instruction manual, storage case, battery set, guarantee card, blood pressure pass

Note: Subject to technical modification without prior notice

- This OMRON product is produced under the strict quality system of OMRON Healthcare Co. Ltd., Japan. The Core component for OMRON blood pressure monitors, which is the Pressure Sensor, is produced in Japan for assembly.
- Disposal of this product and used batteries should be carried out in accordance with the national regulations for the disposal of electronic products.



= Type B

CE 0197



This device fulfils the provisions of EC directive 93/42/EEC (Medical Device Directive). This blood pressure monitor is designed according to the European Standard EN1060, Non-invasive sphygmomanometers Part 1: General Requirements and Part 3: Supplementary requirements for electromechanical blood pressure measuring systems.



Caution: Please read the instruction manual carefully before using the device.

Important information regarding Electro Magnetic Compatibility (EMC)

With the increased number of electronic devices such as PC's and mobile (cellular) telephones, medical devices in use may be susceptible to electromagnetic interference from other devices. Electromagnetic interference may result in incorrect operation of the medical device and create a potentially unsafe situation. Medical devices should also not interfere with other devices.

In order to regulate the requirements for EMC (Electro Magnetic Compatibility) with the aim to prevent unsafe product situations, the EN60601-1-2 standard has been implemented. This standard defines the levels of immunity to electromagnetic interferences as well as maximum levels of electromagnetic emissions for medical devices.

This medical device manufactured by OMRON Healthcare conforms to this EN60601-1-2:2001 standard for both immunity and emissions.

Nevertheless, special precautions need to be observed:

- Do not use mobile (cellular) telephones and other devices, which generate strong electrical or electromagnetic fields, near the medical device. This may result in incorrect operation of the unit and create a potentially unsafe situation. Recommendation is to keep a minimum distance of 7 m. Verify correct operation of the device in case the distance is shorter.

Further documentation in accordance with EN60601-1-2:2001 is available at OMRON Healthcare Europe at the address mentioned in this instruction manual. Documentation is also available at www.omron-healthcare.com.



**Correct Disposal of This Product
(Waste Electrical & Electronic Equipment)**

This marking shown on the product or its literature, indicates that it should not be disposed of, with other household wastes at the end of its working life. To prevent possible harm to the environment or human health from uncontrolled waste disposal, please separate this from other types of wastes and recycle it responsibly to promote the sustainable reuse of material resources.

Household users should contact either the retailer where they purchased this product, or their local government office, for details of where and how they can take this item for environmentally safe recycling.

Business users should contact their supplier and check the terms and conditions of the purchase contract. This product should not be mixed with other commercial wastes for disposal.

This product does not contain any hazardous substances.

9. Some Useful Information about Blood Pressure

What is Blood Pressure?

Blood pressure is a measure of the force of blood flowing against the walls of the arteries. Arterial blood pressure is constantly changing during the course of the heart's cycle.

The highest pressure in the cycle is called the *Systolic Blood Pressure*; the lowest is the *Diastolic Blood Pressure*.

Both pressure readings, the *Systolic* and *Diastolic*, are necessary to enable a doctor to evaluate the status of a patient's blood pressure.

Why is it a Good Thing to measure Blood Pressure at Home?

Having your blood pressure measured by a doctor can cause anxiety which is itself a cause of high blood pressure. As a variety of conditions affect blood pressure, a single measurement may not be sufficient for an accurate diagnosis.

Many factors such as physical activity, anxiety, or the time of day, can influence your blood pressure. Thus it is best to try and measure your blood pressure at the same time each day, to get an accurate indication of any changes in blood pressure. Blood pressure is typically low in the morning and increases from afternoon to evening. It is lower in the summer and higher in the winter.

Blood pressure is measured in millimetres of mercury (mmHg) and measurements are written with the systolic pressure before the diastolic e.g. A blood pressure written as 140/90, is referred to as 140 over 90 mmHg.

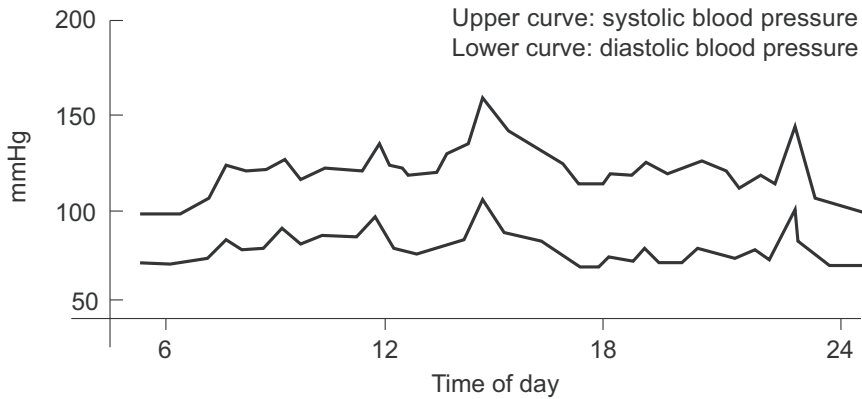

Example: fluctuation within a day (male, 35 years old)

Classification of Blood Pressure by the World Health Organization

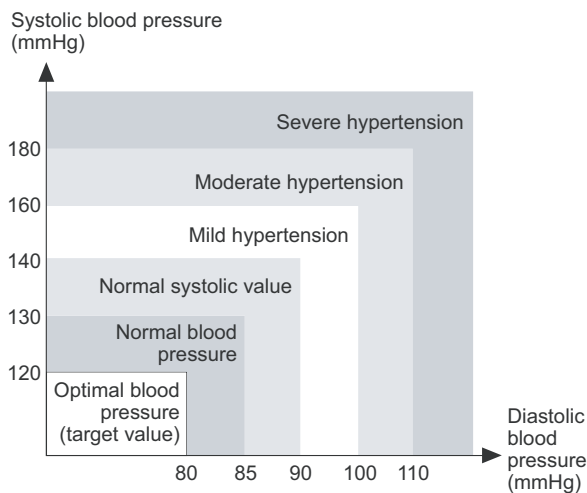

The World Health Organization (WHO) and the International Society of Hypertension (ISH) developed the Blood Pressure Classification shown in this figure.



EN

This classification is based on the blood pressure values measured on people in a sitting position in outpatient departments of hospitals.

*There is no universally accepted definition of hypotension. However, those having the systolic pressure below 100 mmHg are assumed as hypotensive.

Manufacturer	OMRON HEALTHCARE CO., LTD. 24, Yamanouchi Yamanoshita-cho, Ukyo-ku, Kyoto, 615-0084, Japan 
EU-representative	OMRON HEALTHCARE EUROPE B.V. Kruisweg 577, 2132 NA Hoofddorp, The Netherlands www.omron-healthcare.com 
Production facility	OMRON DALIAN CO., LTD. Economic & Technical Development Zone Dalian 116600, China
Subsidiary	OMRON HEALTHCARE UK LTD. Opal Drive Fox Milne, Milton Keynes MK15 0DG, United Kingdom
	OMRON Medizintechnik Handelsgesellschaft mbH John-Deere-Str. 81a, 68163 Mannheim, Germany www.omron-medizintechnik.de
	OMRON SANTÉ FRANCE SAS 14, rue de Lisbonne, 93561 Rosny-sous-Bois Cedex, France

Made in China