

# ONKYO®

## Network Stereo Receiver

# TX-8050

## Instruction Manual

Thank you for purchasing an Onkyo Network Stereo Receiver. Please read this manual thoroughly before making connections and plugging in the unit. Following the instructions in this manual will enable you to obtain optimum performance and listening enjoyment from your new Stereo Receiver. Please retain this manual for future reference.

## Contents

**Introduction** .....En-2

**Connections** ..... En-10

**Enjoying Audio Sources**..... En-18

**Appendix**  
**Troubleshooting** ..... En-51  
**Specifications** ..... En-54



## WARNING:

TO REDUCE THE RISK OF FIRE OR ELECTRIC SHOCK, DO NOT EXPOSE THIS APPARATUS TO RAIN OR MOISTURE.

## CAUTION:

TO REDUCE THE RISK OF ELECTRIC SHOCK, DO NOT REMOVE COVER (OR BACK). NO USER-SERVICEABLE PARTS INSIDE. REFER SERVICING TO QUALIFIED SERVICE PERSONNEL.



**WARNING**  
RISK OF ELECTRIC SHOCK  
DO NOT OPEN

**AVIS**  
RISQUE DE CHOC ELECTRIQUE  
NE PAS OUVRIR



The lightning flash with arrowhead symbol, within an equilateral triangle, is intended to alert the user to the presence of uninsulated "dangerous voltage" within the product's enclosure that may be of sufficient magnitude to constitute a risk of electric shock to persons.



The exclamation point within an equilateral triangle is intended to alert the user to the presence of important operating and maintenance (servicing) instructions in the literature accompanying the appliance.

## Important Safety Instructions

1. Read these instructions.
2. Keep these instructions.
3. Heed all warnings.
4. Follow all instructions.
5. Do not use this apparatus near water.
6. Clean only with dry cloth.
7. Do not block any ventilation openings. Install in accordance with the manufacturer's instructions.
8. Do not install near any heat sources such as radiators, heat registers, stoves, or other apparatus (including amplifiers) that produce heat.
9. Do not defeat the safety purpose of the polarized or grounding-type plug. A polarized plug has two blades with one wider than the other. A grounding type plug has two blades and a third grounding prong. The wide blade or the third prong are provided for your safety. If the provided plug does not fit into your outlet, consult an electrician for replacement of the obsolete outlet.
10. Protect the power cord from being walked on or pinched particularly at plugs, convenience receptacles, and the point where they exit from the apparatus.
11. Only use attachments/accessories specified by the manufacturer.
12. Use only with the cart, stand, tripod, bracket, or table specified by the manufacturer, or sold with the apparatus. When a cart is used, use caution when moving the cart/apparatus combination to avoid injury from tip-over.  

PORTABLE CART WARNING  
S3125A
13. Unplug this apparatus during lightning storms or when unused for long periods of time.
14. Refer all servicing to qualified service personnel. Servicing is required when the apparatus has been damaged in any way, such as power-supply cord or plug is damaged, liquid has been spilled or objects have fallen into the apparatus, the apparatus has been exposed to rain or moisture, does not operate normally, or has been dropped.
15. Damage Requiring Service  
Unplug the apparatus from the wall outlet and refer servicing to qualified service personnel under the following conditions:
  - A. When the power-supply cord or plug is damaged,
  - B. If liquid has been spilled, or objects have fallen into the apparatus,
  - C. If the apparatus has been exposed to rain or water,
  - D. If the apparatus does not operate normally by following the operating instructions. Adjust only those controls that are covered by the operating instructions as an improper adjustment of other controls may result in damage and will often require extensive work by a qualified technician to restore the apparatus to its normal operation,
  - E. If the apparatus has been dropped or damaged in any way, and
  - F. When the apparatus exhibits a distinct change in performance this indicates a need for service.
16. Object and Liquid Entry  
Never push objects of any kind into the apparatus through openings as they may touch dangerous voltage points or short-out parts that could result in a fire or electric shock.  
The apparatus shall not be exposed to dripping or splashing and no objects filled with liquids, such as vases shall be placed on the apparatus.  
Don't put candles or other burning objects on top of this unit.
17. Batteries  
Always consider the environmental issues and follow local regulations when disposing of batteries.
18. If you install the apparatus in a built-in installation, such as a bookcase or rack, ensure that there is adequate ventilation.  
Leave 20 cm (8") of free space at the top and sides and 10 cm (4") at the rear. The rear edge of the shelf or board above the apparatus shall be set 10 cm (4") away from the rear panel or wall, creating a flue-like gap for warm air to escape.

# Precautions

---

1. **Recording Copyright**—Unless it's for personal use only, recording copyrighted material is illegal without the permission of the copyright holder.

2. **AC Fuse**—The AC fuse inside the unit is not user-serviceable. If you cannot turn on the unit, contact your Onkyo dealer.

3. **Care**—Occasionally you should dust the unit all over with a soft cloth. For stubborn stains, use a soft cloth dampened with a weak solution of mild detergent and water. Dry the unit immediately afterwards with a clean cloth. Don't use abrasive cloths, thinners, alcohol, or other chemical solvents, because they may damage the finish or remove the panel lettering.

## 4. Power

### WARNING

BEFORE PLUGGING IN THE UNIT FOR THE FIRST TIME, READ THE FOLLOWING SECTION CAREFULLY.

AC outlet voltages vary from country to country. Make sure that the voltage in your area meets the voltage requirements printed on the unit's rear panel (e.g., AC 230 V, 50 Hz or AC 120 V, 60 Hz).

The power cord plug is used to disconnect this unit from the AC power source. Make sure that the plug is readily operable (easily accessible) at all times.

Pressing **ON/STANDBY** to select Standby mode does not fully disconnect from the mains. If you do not intend to use the unit for an extended period, remove the power cord from the AC outlet.

## 5. Preventing Hearing Loss

### Caution

Excessive sound pressure from earphones and headphones can cause hearing loss.

## 6. Batteries and Heat Exposure

### Warning

Batteries (battery pack or batteries installed) shall not be exposed to excessive heat as sunshine, fire or the like.

7. **Never Touch this Unit with Wet Hands**—Never handle this unit or its power cord while your hands are wet or damp. If water or any other liquid gets inside this unit, have it checked by your Onkyo dealer.

## 8. Handling Notes

- If you need to transport this unit, use the original packaging to pack it how it was when you originally bought it.
- Do not leave rubber or plastic items on this unit for a long time, because they may leave marks on the case.
- This unit's top and rear panels may get warm after prolonged use. This is normal.
- If you do not use this unit for a long time, it may not work properly the next time you turn it on, so be sure to use it occasionally.

## For U.S. models

### FCC Information for User

#### CAUTION:

The user changes or modifications not expressly approved by the party responsible for compliance could void the user's authority to operate the equipment.

#### NOTE:

This equipment has been tested and found to comply with the limits for a Class B digital device, pursuant to Part 15 of the FCC Rules. These limits are designed to provide reasonable protection against harmful interference in a residential installation.

This equipment generates, uses and can radiate radio frequency energy and, if not installed and used in accordance with the instructions, may cause harmful interference to radio communications. However, there is no guarantee that interference will not occur in a particular installation. If this equipment does cause harmful interference to radio or television reception, which can be determined by turning the equipment off and on, the user is encouraged to try to correct the interference by one or more of the following measures:

- Reorient or relocate the receiving antenna.
- Increase the separation between the equipment and receiver.
- Connect the equipment into an outlet on a circuit different from that to which the receiver is connected.
- Consult the dealer or an experienced radio/TV technician for help.

## For Canadian Models

**NOTE:** THIS CLASS B DIGITAL APPARATUS COMPLIES WITH CANADIAN ICES-003.

## Modèle pour les Canadiens

**REMARQUE:** CET APPAREIL NUMÉRIQUE DE LA CLASSE B EST CONFORME À LA NORME NMB-003 DU CANADA.

## Precautions—Continued

### For British models

Replacement and mounting of an AC plug on the power supply cord of this unit should be performed only by qualified service personnel.

#### IMPORTANT

The wires in the mains lead are coloured in accordance with the following code:

- Blue: Neutral
- Brown: Live

As the colours of the wires in the mains lead of this apparatus may not correspond with the coloured markings identifying the terminals in your plug, proceed as follows:

The wire which is coloured blue must be connected to the terminal which is marked with the letter N or coloured black.

The wire which is coloured brown must be connected to the terminal which is marked with the letter L or coloured red.

#### IMPORTANT

The plug is fitted with an appropriate fuse. If the fuse needs to be replaced, the replacement fuse must be approved by ASTA or BSI to BS1362 and have the same ampere rating as that indicated on the plug. Check for the ASTA mark or the BSI mark on the body of the fuse.

If the power cord's plug is not suitable for your socket outlets, cut it off and fit a suitable plug. Fit a suitable fuse in the plug.

### For European Models

#### Declaration of Conformity

We, ONKYO EUROPE  
ELECTRONICS GmbH  
LIEGNITZERSTRASSE 6,  
82194 GROEBENZELL,  
GERMANY



declare in own responsibility, that the ONKYO product described in this instruction manual is in compliance with the corresponding technical standards such as EN60065, EN55013, EN55020 and EN61000-3-2, -3-3.

GROEBENZELL, GERMANY

K. MIYAGI

ONKYO EUROPE ELECTRONICS GmbH

## Features

- Clean Design Aluminum Front Panel
- Network Capability
  - Internet Radio
  - DLNA (Digital Living Network Alliance)
- iPod/iPhone<sup>\*1</sup> Digital Direct Connection via USB
- USB Mass-storage Class Device Compatible USB
- Music Optimizer<sup>\*2</sup> for Compressed Digital Music Files
- WRAT (Wide Range Amplifier Technology)
- Discrete Amplifier with Massive Transformer
- Zone 2 Capability
- Gold Plated Terminals
- 130 Watts/channel @ 6 Ω (IEC)
- 100 Watts/channel @ 6 Ω (FTC)
- AM/FM 40 Presets
- RDS (PS/PTY/RT/TP) (European model only)
- Pure Audio Mode
- Direct Mode
- Anti-vibration Oval Chassis
- Phono Equalizer
- RI Input
- 1 IR Input and 1 Output
- Universal Port for the Dock for iPod®/iPhone<sup>®\*1</sup>/HD Radio<sup>™\*2</sup> tuner module (North American model)/DAB+ tuner module (European model)
- Headphone Output
- 2.1 ch Pre-outs

\*1



iPhone, iPod, iPod classic, iPod nano, iPod shuffle, and iPod touch are trademarks of Apple Inc., registered in the U.S. and other countries.

“Made for iPod” and “Made for iPhone” mean that an electronic accessory has been designed to connect specifically to iPod or iPhone, respectively, and has been certified by the developer to meet Apple performance standards. Apple is not responsible for the operation of this device or its compliance with safety and regulatory standards.

Please note that the use of this accessory with iPod or iPhone may affect wireless performance.

\*2

Music Optimizer™ is a trademark of Onkyo Corporation.



HD Radio™, HD Radio Ready™, and the HD Radio Ready logo are proprietary trademarks of iBiquity Digital Corporation. This HD Radio Ready™ receiver is ready to receive HD Radio broadcasts when connected to the Onkyo UP-HT1 HD Radio tuner module (sold separately).

Windows and the Windows logo are trademarks of the Microsoft group of companies.

# Contents

<b>Important Safety Instructions</b> .....	2	Playing Music Files on a Server.....	31
<b>Precautions</b> .....	3	Remote Playback.....	32
<b>Features</b> .....	4	<b>Network/USB Features</b> .....	<b>34</b>
<b>Supplied Accessories</b> .....	<b>6</b>	Connecting to the Network.....	34
Installing the Batteries.....	6	Network Requirements.....	34
Aiming the Remote Controller.....	6	Server Requirements.....	34
<b>Getting to Know the Receiver</b> .....	<b>7</b>	USB Device Requirements.....	35
Front Panel.....	7	Supported Audio File Formats.....	35
Rear Panel.....	8	About DLNA.....	35
Display.....	8	<b>iPod/iPhone Playback via Onkyo Dock</b> .....	<b>36</b>
Remote Controller.....	9	Using the Onkyo Dock.....	36
<b>Connecting the Receiver</b> .....	<b>10</b>	Controlling Your iPod/iPhone.....	37
Speaker Connection Precautions.....	10	<b>Controlling Other Components</b> .....	<b>39</b>
Connecting the Speaker Cables.....	10	<b>Advanced Setup</b> .....	<b>40</b>
Connecting a Powered Subwoofer.....	11	Changing the Advanced Setup Settings.....	40
Connecting a Power Amplifier.....	11	Advanced Setup Menu.....	41
Configuring the Speaker Impedance.....	12	<b>Zone 2</b> .....	<b>44</b>
<b>Connecting Antennas</b> .....	<b>13</b>	Connecting Zone 2.....	44
<b>Connecting Your Components</b> .....	<b>14</b>	Zone 2 Out Settings.....	44
About AV Connections.....	14	Using Zone 2.....	45
Connecting Onkyo <b>RI</b> Components.....	16	<b>Connecting Components Not Reached by the</b> <b>Remote Controller Signals (IR IN/OUT)</b> .....	<b>47</b>
Connecting a Recording Component.....	17	If Remote Controller Signal Does Not Reach the	
Connecting the Power Cord.....	17	Receiver Remote Sensor.....	47
<b>Turning On the Receiver</b> .....	<b>18</b>	If Remote Controller Signal Does Not Reach Other	
Turning On and Standby.....	18	Components.....	47
Changing the Input Display.....	18	<b>Firmware Update</b> .....	<b>48</b>
<b>Enjoying Audio Sources</b> .....	<b>19</b>	Updating the Firmware via Network.....	48
Muting the Receiver		Updating the Firmware via USB.....	49
(remote controller only).....	19	<b>Troubleshooting</b> .....	<b>51</b>
Using Headphones.....	19	Power.....	51
Setting the Display Brightness.....	20	Audio.....	51
Using the Sleep Timer		Video.....	51
(remote controller only).....	20	Tuner.....	51
Using the Tone and Balance Controls.....	20	Remote Controller.....	51
Select the Audio Input.....	20	UP-A1 Dock for iPod/iPhone.....	52
Selecting the Listening Mode.....	21	Recording.....	52
Enjoying the Pure Audio Sound.....	21	Zone 2.....	52
<b>Recording</b> .....	<b>22</b>	Music Server and Internet Radio.....	52
Recording the Input Source.....	22	USB Device Playback.....	53
Recording Audio and Video from		Others.....	53
Separate Sources.....	22	<b>Specifications</b> .....	<b>54</b>
<b>Listening to the Radio</b> .....	<b>23</b>		
Listening to AM/FM Stations.....	23		
Using RDS (European model only).....	26		
<b>Using the USB/Network Device</b> .....	<b>28</b>		
Connecting the iPod/iPhone Directly to			
the USB Port.....	28		
Playing the USB Device.....	29		
Listening to the Internet Radio.....	30		

# Supplied Accessories

Make sure you have the following accessories:

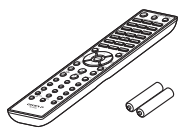

**Remote controller and two batteries (AAA/R03)**

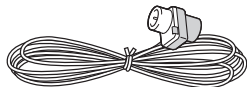

**Indoor FM antenna**



**AM loop antenna**

\* In catalogs and on packaging, the letter at the end of the product name indicates the color. Specifications and operation are the same regardless of color.

## Installing the Batteries

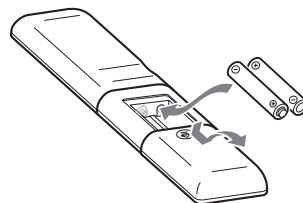

### Notes:

- If the remote controller doesn't work reliably, try replacing the batteries.
- Don't mix new and old batteries or different types of batteries.
- If you intend not to use the remote controller for a long time, remove the batteries to prevent damage from leakage or corrosion.
- Expired batteries should be removed as soon as possible to prevent damage from leakage or corrosion.

## Aiming the Remote Controller

When using the remote controller, point it toward the receiver's remote control sensor, as shown below.

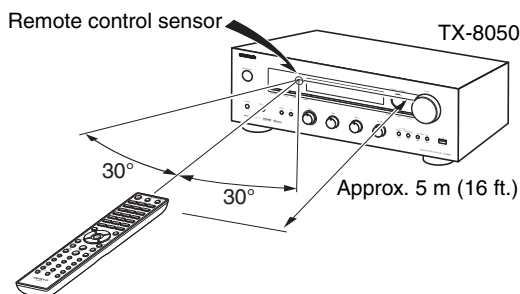

# Getting to Know the Receiver

## Front Panel

### North American model

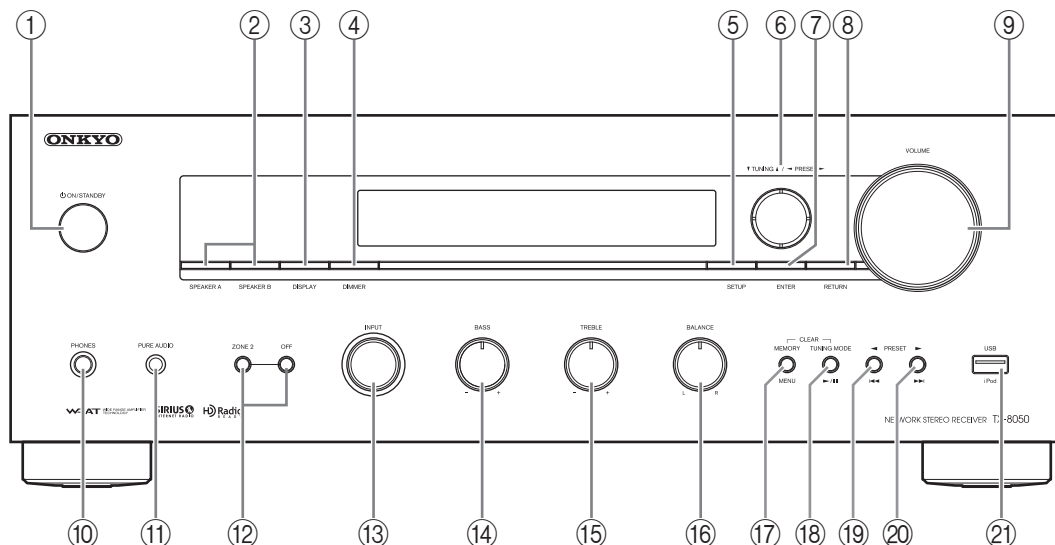

### European model

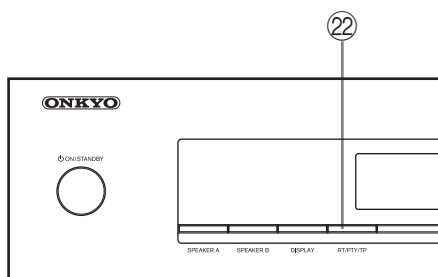

For detailed information, see the pages in parentheses.

- ① **ON/STANDBY button (18, 45, 51)**
- ② **SPEAKERS A and B switches (19)**
- ③ **DISPLAY button (25)**
- ④ **DIMMER button (North American model) (20)**
- ⑤ **SETUP button (12, 40, 44)**
- ⑥ **TUNING ▲/▼, PRESET ◀/▶ buttons (23, 24, 27, 40)**
- ⑦ **ENTER button (27)**
- ⑧ **RETURN button (40)**
- ⑨ **VOLUME control (19)**
- ⑩ **PHONES jack (19)**
- ⑪ **PURE AUDIO button and indicator (21)**
- ⑫ **ZONE 2, OFF buttons (45)**
- ⑬ **INPUT selector (19, 22, 23, 27, 45)**
- ⑭ **BASS control (20)**
- ⑮ **TREBLE control (20)**
- ⑯ **BALANCE control (20)**
- ⑰ **MEMORY/MENU button (24)**
- ⑱ **TUNING MODE/▶/II button (23, 25, 51)**
- ⑲ **PRESET ◀/I◀◀ button (24)**
- ⑳ **PRESET ▶/▶▶▶ button (24)**
- ㉑ **USB port (28)**
- ㉒ **RT/PTY/TP button (European model) (27)**

## Getting to Know the Receiver—Continued

### Rear Panel

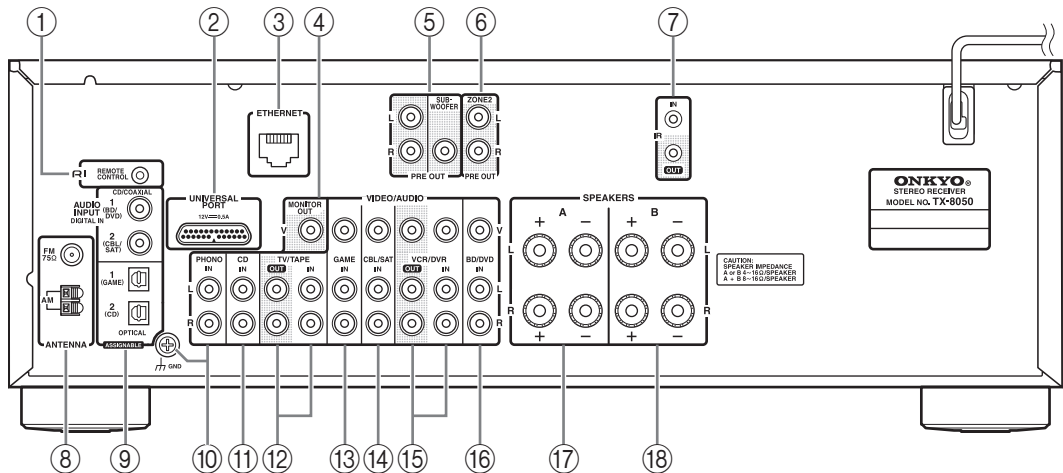

For detailed information, see the pages in parentheses.

- |  |   |
|--|---|
| ① <b>RI REMOTE CONTROL</b> jack (16)                         | ⑪ <b>CD IN</b> jacks (15)   |
| ② <b>UNIVERSAL PORT</b> jack (15)                            | ⑫ <b>TV/TAPE IN/OUT</b> jacks (15, 17)                              |
| ③ <b>ETHERNET</b> port (15)                                  | ⑬ <b>GAME IN</b> jacks (15)   |
| ④ <b>MONITOR OUT</b> jack (15)                               | ⑭ <b>CBL/SAT IN</b> jacks (15)                                      |
| ⑤ <b>PRE OUT</b> jacks (11)                                  | ⑮ <b>VCR/DVR IN/OUT</b> jacks (15, 17)                              |
| ⑥ <b>ZONE 2 PRE OUT</b> jacks (44)                           | ⑯ <b>BD/DVD IN</b> jacks (15)                                       |
| ⑦ <b>IR IN/OUT</b> jacks (47)                                | ⑰ <b>SPEAKERS A</b> terminals (10)                                  |
| ⑧ <b>FM ANTENNA</b> jack and <b>AM ANTENNA</b> terminal (13) | ⑱ <b>SPEAKERS B</b> terminals (10)                                  |
| ⑨ <b>DIGITAL IN COAXIAL</b> and <b>OPTICAL</b> jacks (15)    | See “Connecting the Receiver” for connection<br>(→ pages 10 to 17). |
| ⑩ <b>PHONO IN (MM)</b> and <b>GND</b> terminal (15)          |   |

### Display

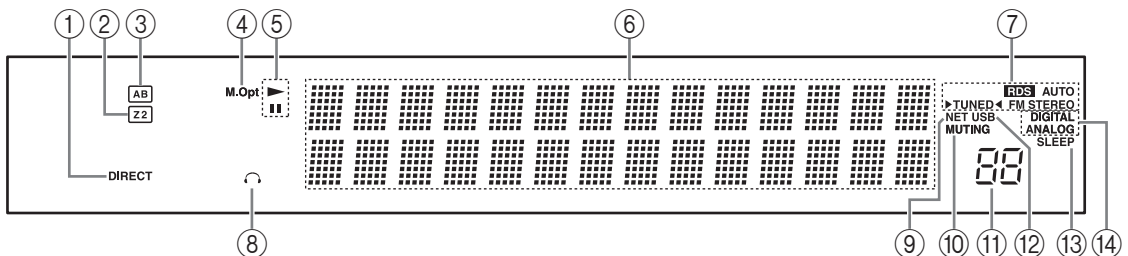

For detailed information, see the pages in parentheses.

- |  |                                       |
|--|---------------------------------------|
| ① <b>DIRECT</b> indicator (21)               | • <b>TUNED</b> indicator (23)         |
| ② <b>Z2 (Zone 2)</b> indicator (45)          | • <b>FM STEREO</b> indicator (23, 51) |
| ③ <b>A/B</b> speaker indicator (19)          | ⑧ <b>Headphone</b> indicator          |
| ④ <b>M.Opt</b> indicator (21)                | ⑨ <b>NET</b> indicator (30, 31)       |
| ⑤ <b>▶,   </b> indicators                    | ⑩ <b>MUTING</b> indicator (51)        |
| ⑥ <b>Message</b> area                        | ⑪ <b>Volume level</b> (19)            |
| ⑦ <b>Tuning</b> indicators                   | ⑫ <b>USB</b> indicator (28, 29)       |
| • <b>RDS</b> indicator (European model) (26) | ⑬ <b>SLEEP</b> indicator (20, 41)     |
| • <b>AUTO</b> indicator (23)                 | ⑭ <b>Audio input</b> indicators       |



## Remote Controller

For detailed information, see the pages in parentheses.

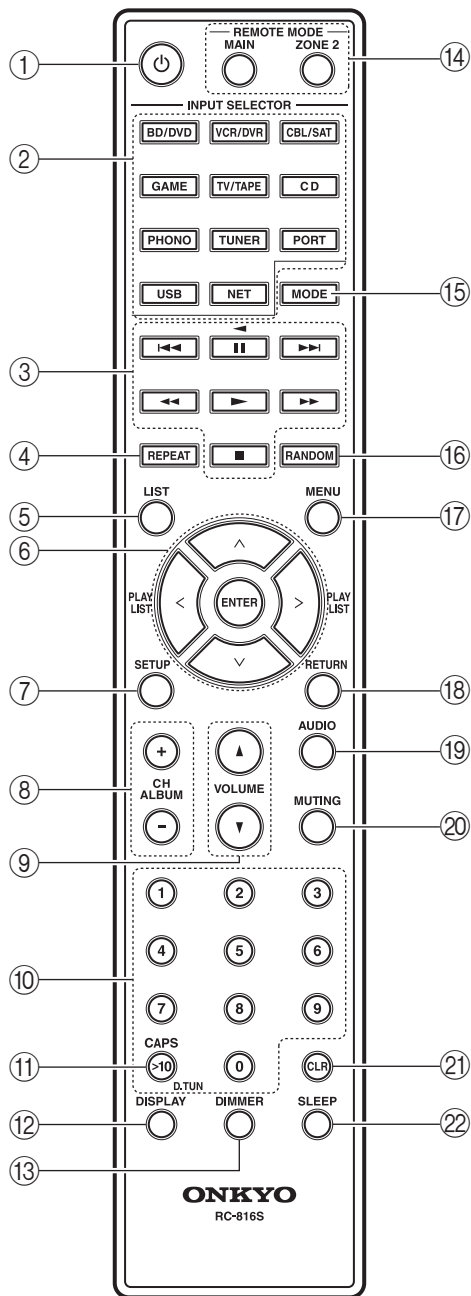

- ① **⏻ button (12, 18, 45)**
- ② **INPUT SELECTOR buttons (18, 19, 22, 23, 38, 39, 45)**
- ③ **Control buttons (38, 39)**
- ④ **REPEAT button (38, 39)**
- ⑤ **LIST button**
- ⑥ **Arrow [^]/[v]/[<]/[>] and ENTER buttons (12, 23, 38, 39, 40, 44)**
- ⑦ **SETUP button (12, 40, 44)**
- ⑧ **CH/ALBUM buttons (25, 38, 39)**
- ⑨ **VOLUME ▲/▼ buttons (19, 46)**
- ⑩ **Number buttons (23, 24, 39)**
- ⑪ **>10/CAPS/D.TUN button (24)**
- ⑫ **DISPLAY button (25, 38, 39)**
- ⑬ **DIMMER button (20)**
- ⑭ **REMOTE MODE buttons (9, 39, 45, 46)**
- ⑮ **MODE button (38, 39)**
- ⑯ **RANDOM button (38, 39)**
- ⑰ **MENU button (39)**
- ⑱ **RETURN button (38, 39, 40)**
- ⑲ **AUDIO button (21)**
- ⑳ **MUTING button (19, 45, 46)**
- ㉑ **CLR button (25)**
- ㉒ **SLEEP button (20)**

### Using the REMOTE MODE buttons



You can use this remote controller's Zone 2 capability to control a Zone 2 device. To control a Zone 2 device, start by

pressing the REMOTE MODE [ZONE 2] button. After you've finished operating the Zone 2 device, and would like to operate this receiver once again, press the REMOTE MODE [MAIN] button.

If the expected operation does not occur even though the remote controller is pointed toward the receiver, it may be that Zone 2 is selected. Please press the REMOTE MODE [MAIN] button. Once you've pressed the REMOTE MODE [MAIN] button, there's no need to press this button again before each operation; you can simply use the remote controller to operate the receiver as usual. Similarly, once you've pressed the REMOTE MODE [ZONE 2] button, you can continue operating the Zone 2 device without having to press this button again before each operation.

# Connecting the Receiver

⚠ **Disconnect the power cord from the electrical outlet before making any connections.**

## Speaker Connection Precautions

The receiver allows you to connect two sets of speakers. When two sets of speakers are connected, you can select which speaker set outputs sound or use both sets to output sound simultaneously. (→ page 19 about “Speakers A” and “Speakers B”)

- When you connect one set of speakers to either SPEAKERS A or SPEAKERS B terminal posts, or when you connect two sets of speakers to both speaker terminal posts and output sound only from either speaker set, use speakers whose impedance is 4 to 16 Ω, and set the speaker impedance setting on the receiver to 4 or 6 Ω (→ page 12). When the impedance of the speaker to be used is less than 6 Ω, set the speaker impedance to 4 Ω.
- When you connect speakers to both SPEAKERS A and SPEAKERS B terminal posts and output sound from both speaker sets simultaneously, use speakers whose impedance is 8 to 16 Ω. Set the speaker impedance setting on the receiver to 4 Ω.
- Read the instructions supplied with your speakers.
- Pay close attention to speaker wiring polarity. In other words, connect positive (+) terminals only to positive (+) terminals, and negative (–) terminals only to negative (–) terminals. If you get them the wrong way around, the sound will be out of phase and will sound unnatural.
- Unnecessarily long or very thin speaker cables may affect the sound quality and should be avoided.
- Be careful not to short the positive and negative wires. Doing so may damage the receiver.
- Don't connect more than one cable to each speaker terminal. Doing so may damage the receiver.
- Don't connect a speaker to more than one pair of speaker terminals.

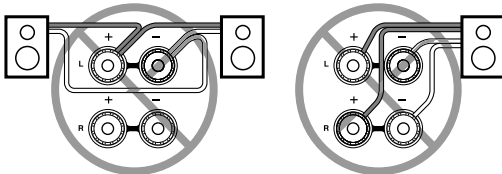
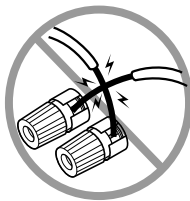

### Note:

If you make an incorrect setting for the speakers or the impedance values, the built-in protection circuit may be activated resulting in no sound output from speakers.

## Connecting the Speaker Cables

- 1 Strip about 5/8" (15 mm) of insulation from the ends of the speaker cables, and twist the bare wires tightly, as shown.**

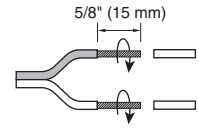

- 2 Unscrew the terminal.**



- 3 Fully insert the bare wire.**



- 4 Screw the terminal tight.**



The following illustration shows which speaker should be connected to each pair of terminals.

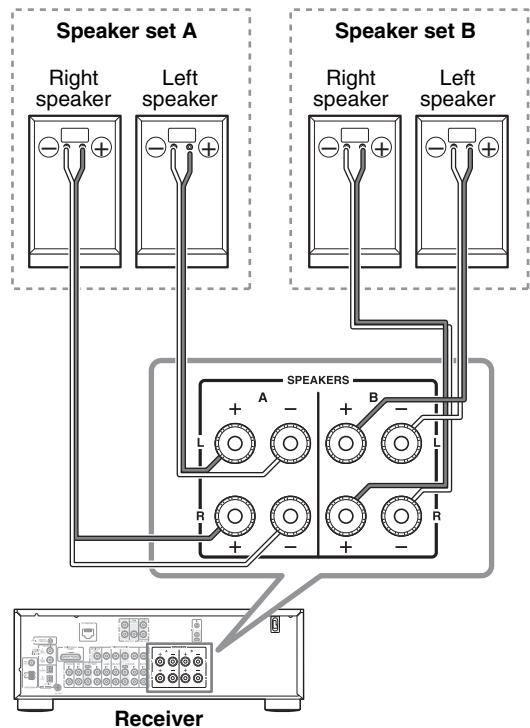

### Connecting a Powered Subwoofer

Using a suitable cable, connect the receiver's PRE OUT: SUBWOOFER to the input on your powered subwoofer. If your subwoofer is unpowered and you're using an external amplifier, connect the PRE OUT: SUBWOOFER to the amp's input.

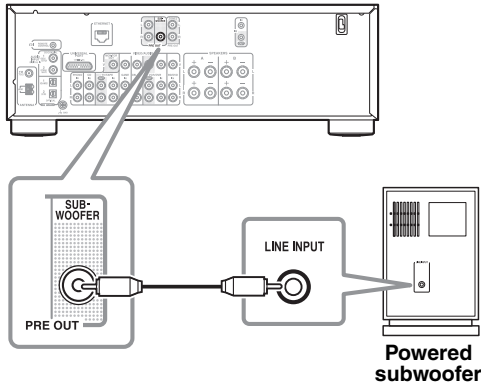

### Connecting a Power Amplifier

If you want to use a more powerful power amplifier and use the receiver as a preamp, connect the receiver's PRE OUT: L, R to the amp's input, and connect all speakers to the power amplifier.

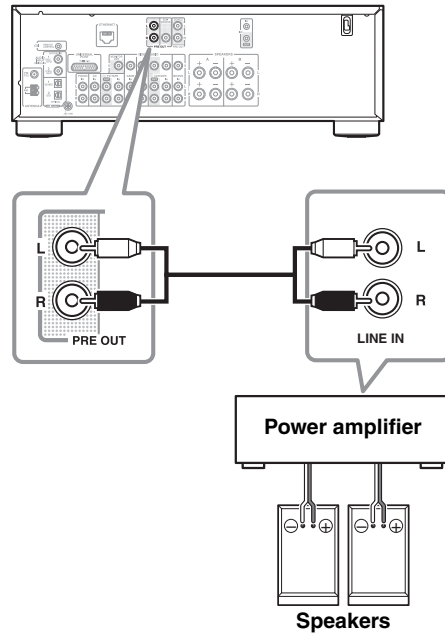

### Configuring the Speaker Impedance

On the receiver, the factory default for speaker impedance is “6 Ω”. If you need to change the speaker impedance setting, read “Speaker Connection Precautions” on page 10 carefully before performing the procedure below.

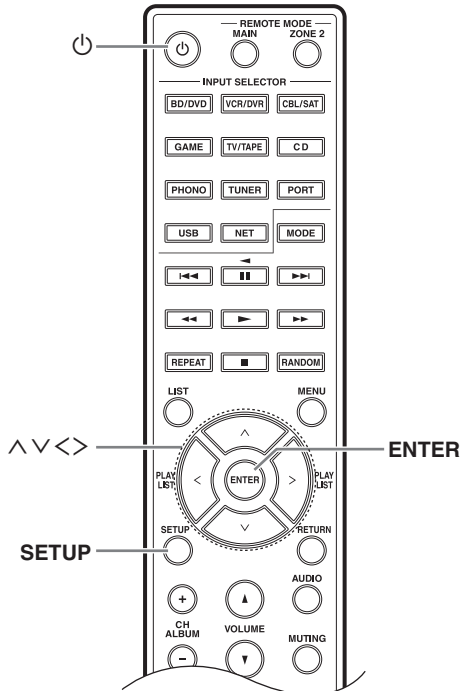

#### Note:

Be sure to minimize the volume level on the receiver before configuring the speaker impedance.

- 1** Press the [⏻] button to turn on the power.
- 2** Press the [SETUP] button on the remote controller.
- 3** Use the arrow [↑]/[↓] buttons to select “3. Hardware Setup,” and then press [ENTER].

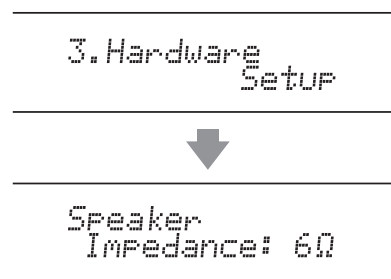

- 4** Change the impedance value to “4 Ω” using the arrow [←]/[→] buttons.
- 5** Press the [SETUP] button on the remote controller to complete the setting.

If you want to change the impedance setting back to the factory default setting of 6 Ω, follow the same procedure described above.

#### Notes:

- This procedure can also be performed on the receiver by using [SETUP], TUNING [▲]/[▼], PRESET [◀]/[▶], and ENTER.
- Press [RETURN] to return to the previous menu.

#### Setting example :

If you're using only one of the speaker sets connected to SPEAKERS A or B, choose the 4 Ω setting if each speaker's impedance is 4 Ω to less than 6 Ω, or choose the 6 Ω setting if each speaker's impedance is 6 Ω or more.

If you're using both of the speaker sets connected to SPEAKERS A and B, choose the 4 Ω setting if each speaker's impedance is 8 to 16 Ω.

# Connecting Antennas

This section explains how to connect the supplied indoor FM antenna and AM loop antenna. The receiver won't pick up any radio signals if no antenna is connected, so you must connect the antenna to use the tuner.

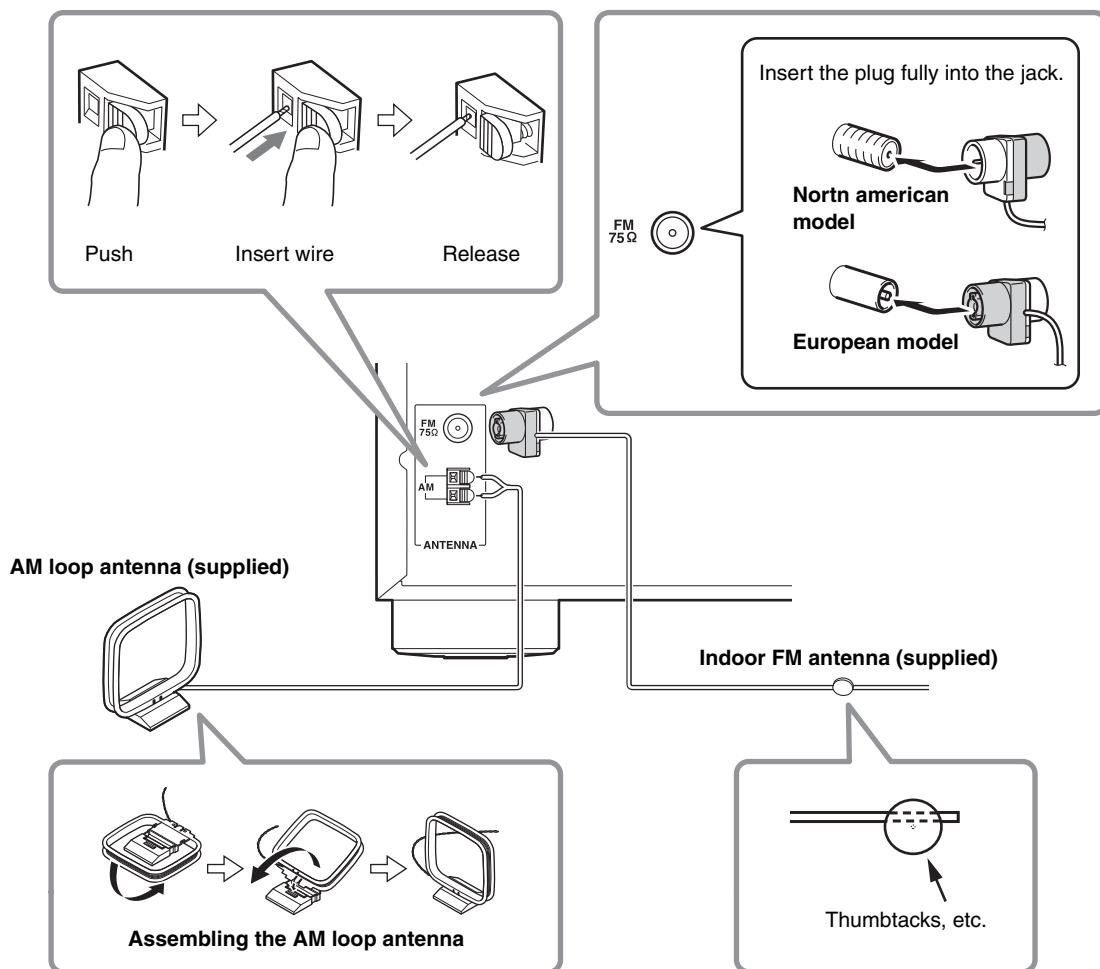

**Caution:**  
Be careful that you don't injure yourself when using thumbtacks.

## Notes:

- Once your receiver is ready for use, you'll need to tune into a radio station and position the antenna to achieve the best possible reception.
- Keep the AM loop antenna as far away as possible from your receiver, TV, speaker cables, and power cords.
- Refer to "Hardware Setup" on page 41 for more information on switching the frequency setup.

## Tips:

- If you cannot achieve good reception with the supplied indoor FM antenna, try a commercially available outdoor FM antenna instead.
- If you cannot achieve good reception with the supplied indoor AM loop antenna, try using it with a commercially available outdoor AM antenna.

# Connecting Your Components

## About AV Connections

### Connecting AV components

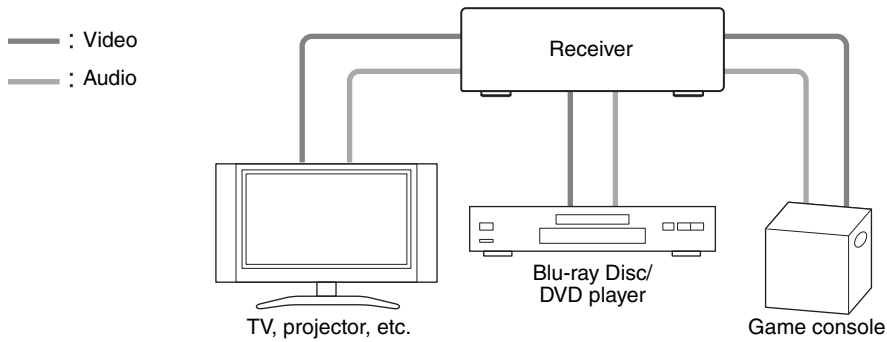

- Before making any AV connections, read the manuals supplied with your AV components.
- Don't connect the power cord until you've completed and double-checked all AV connections.
- Push plugs in all the way to make good connections (loose connections can cause noise or malfunctions).

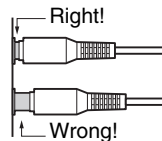

- To prevent interference, keep audio and video cables away from power cords and speaker cables.

### AV Cables and Jacks

Signal	Cable	Jack	Description
Video	Composite video	V Yellow	Composite video is commonly used on TVs, VCRs, and other video equipment.
Audio	Optical digital audio	OPTICAL	Optical digital connections allow you to enjoy digital sound. The audio quality is the same as coaxial.
	Coaxial digital audio	COAXIAL Orange	Coaxial digital connections allow you to enjoy digital sound. The audio quality is the same as optical.
	Analog audio (RCA)	L White R Red	Analog audio connections (RCA) carry analog audio.

#### Notes:

- The receiver does not support SCART plugs.
- The receiver does not support multichannel audio input. The PCM signal can be input only to digital input terminals. Make sure that PCM is selected on the playback component.
- The receiver's optical digital jacks have shutter-type covers that open when an optical plug is inserted and close when it's removed. Push plugs in all the way.

#### Caution:

To prevent shutter damage, hold the optical plug straight when inserting and removing.

## Connecting Your Components—Continued

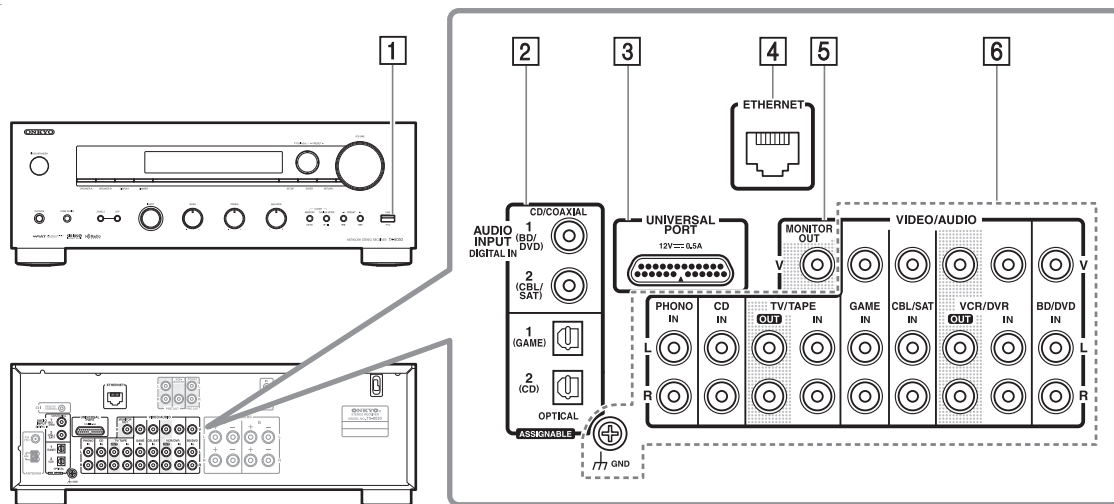

No.	Jack/Port	Connectable components	
1	USB	iPod/iPhone, MP3 player, USB flash drive	
2	DIGITAL IN	OPTICAL	1 (GAME) Game console 2 (CD) TV, CD player
		COAXIAL	1 (BD/DVD) Blu-ray Disc/DVD player 2 (CBL/SAT) Satellite/cable set-top box, RI dock, etc.
	UNIVERSAL PORT	Universal port option dock (UP-A1 etc.)	
	ETHERNET	Router	
5	MONITOR OUT	TV, projector, etc.	
6	BD/DVD IN	Blu-ray Disc/DVD player	
	VCR/DVR IN	VCR or DVD recorder/digital video recorder, RI dock	
	CBL/SAT IN	Satellite/cable set-top box, etc.	
	GAME IN	Game console, RI dock	
	TV/TAPE IN	TV, cassette tape deck, RI dock	
	CD IN	CD player, Turntable	
	PHONO IN	Turntable	

### Notes:

- **Refer to the connected component's instruction manual for details.**
- Do not connect the receiver's USB port to a USB port on your computer. Music on your computer cannot be played through the receiver in this way.
- Connect a turntable (MM) that has a built-in phono preamp to **CD IN**, or connect it to **PHONO IN** with the phono preamp turned off. If your turntable (MM) doesn't have a phono preamp, connect it to **PHONO IN**. If your turntable has a moving coil (MC) type cartridge, you'll need a commercially available MC head amp or MC transformer to connect to **PHONO IN**. See your turntable's manual for details. If your turntable has a ground wire, connect it to the **GND** screw. With some turntables, connecting the ground wire may produce an audible hum. If this happens, disconnect it.
- Connection 3 and 6 lets you listen to and record audio from the external components while you are in Zone 2. You can listen to and record audio from the external components in the main room; you can listen to the audio in Zone 2 as well.
- If your Blu-ray Disc/DVD player has both main stereo and multichannel outputs, be sure to connect the main stereo output using connection 6.

### ■ How to record a video source

See "Recording" to make connections for video recording (→ page 22).

Connecting Onkyo **RI** Components

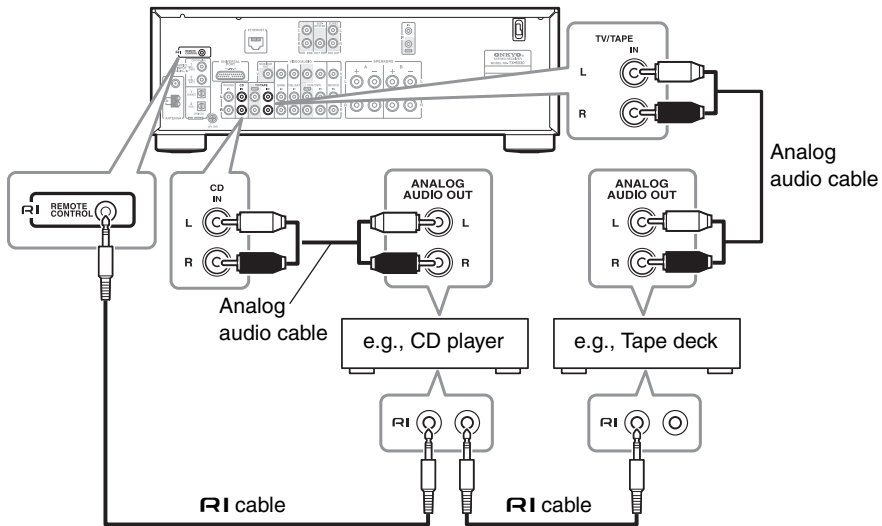

**1** Make sure that each Onkyo component is connected with an analog audio cable (connection 6 in the hookup examples) (→ page 15).

**2** Make the **RI** connection (see the illustration).

- Connect only Onkyo components to **RI** jacks. Connecting other manufacturer's components may cause a malfunction.
- Some components may not support all **RI** functions. Refer to the manuals supplied with your Onkyo components.
- While Zone 2 is on, the System On/Auto Power On and Direct Change **RI** functions do not work.

With **RI** (Remote Interactive), you can use the following special functions:

■ **System On/Auto Power On**

When you start playback on a component connected via **RI**, while the receiver is on Standby, the receiver will automatically turn on and select that component as the input source.

■ **Direct Change**

When playback is started on a component connected via **RI**, the receiver automatically selects that component as the input source.

■ **Remote Control**

You can use the receiver's remote controller to control your other **RI**-capable Onkyo components, pointing the remote controller at the receiver's remote control sensor instead of the component.

**Notes:**

- Use only **RI** cables for **RI** connections. **RI** cables are supplied with Onkyo players (CD, etc.).
- Some components have two **RI** jacks. You can connect either one to the receiver. The other jack is for connecting additional **RI**-capable components.



### Connecting a Recording Component

See “Recording” for an explanation of recording (→ page 22).

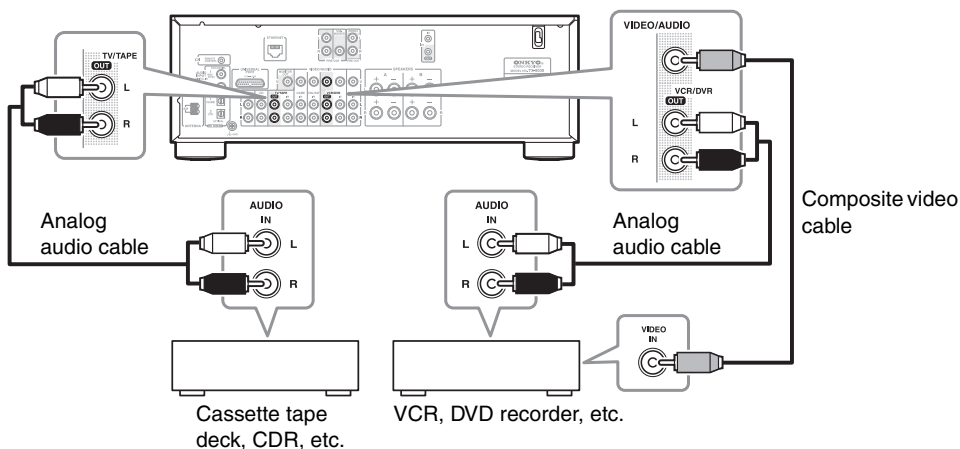

#### Notes:

- The receiver must be turned on for recording. Recording is not possible while it's in Standby mode.
- If you want to record directly from your TV or playback VCR to the recording VCR without going through the receiver, connect the TV/VCR's audio and video outputs directly to the recording VCR's audio and video inputs. See the manuals supplied with your TV and VCR for details.
- Video signals connected to composite video inputs can be recorded only via composite video outputs. If your TV/VCR is connected to a composite video input, the recording VCR must be connected to a composite video output.
- Copy-protected Blu-ray discs and DVDs cannot be recorded.
- Sources connected to a digital input cannot be recorded. Only analog inputs can be recorded.
- DTS signals will be recorded as noise, so don't attempt analog recording of DTS CDs or LDs.
- If Pure Audio is turned on, no video signal is output from the receiver. If you want to make recordings, select another listening mode.

### Connecting the Power Cord

Connect the receiver's power cord to a suitable wall outlet.

#### Notes:

- **Before connecting the power cord, connect all of your speakers and AV components.**
- Turning on the receiver may cause a momentary power surge that might interfere with other electrical equipment on the same circuit. If this is a problem, plug the receiver into a different branch circuit.

# Turning On the Receiver

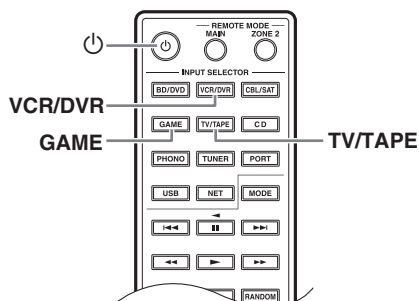
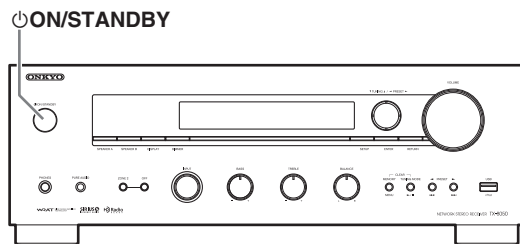

## Turning On and Standby

**Press the [ON/STANDBY] button.  
Alternatively, press the remote controller's [ON] button.**

The receiver comes on, and the display lights up.

To turn the receiver off, press the [ON/STANDBY] button, or press the remote controller's [ON] button. The receiver will enter Standby mode. To prevent any loud surprises when you next turn on the receiver, always turn down the volume before you turn it off.

### Note:

If you can't use the remote controller to turn the receiver on/off, make sure that REMOTE MODE is set correctly. (→ page 9)

## Changing the Input Display

For the [TV/TAPE], [VCR/DVR] and [GAME] buttons, the input display name can be changed as shown below. When the input display name has been changed for one of the buttons below, the display name for the other button cannot be changed.

- [TV/TAPE] button : TV/TAPE ↔ DOCK
- [VCR/DVR] button : VCR/DVR ↔ DOCK
- [GAME] button : GAME ↔ DOCK

### 1 Press the remote controller's appropriate INPUT SELECTOR button.

The selected input name appears in the display.

### 2 Press and hold down the INPUT SELECTOR button selected in the Step 1 above for approximately 3 seconds to change the display name.

# Enjoying Audio Sources

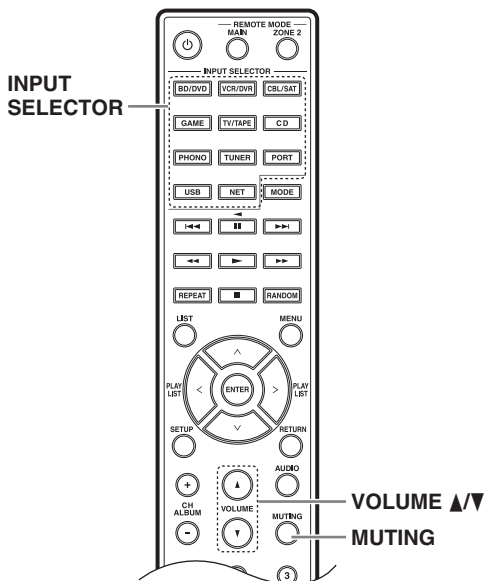
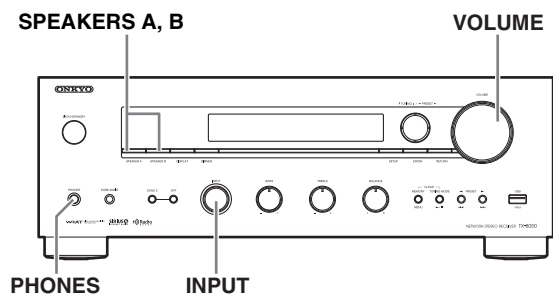

**1** Rotate the receiver's [INPUT] selector, or press the remote controller's INPUT SELECTOR buttons to select the source you want to hear.

**2** Use the [SPEAKERS A] and [SPEAKERS B] buttons on the receiver to select the speaker set that you want to use.

The A and B speaker indicators show whether each speaker set is on or off.

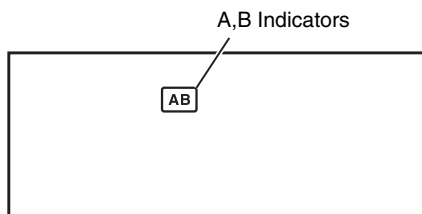

**3** Start playback on the selected component.

**4** To adjust the volume, use the receiver's [VOLUME] control, or the remote controller's VOLUME [▲]/[▼] buttons.

Turn the control clockwise to turn up the volume or counterclockwise to turn down the volume.

## Muting the Receiver (remote controller only)

You can temporarily mute the output of the receiver.

Press the remote controller's [MUTING] button.

The receiver is muted.

To unmute the receiver, press the [MUTING] button again.

### Note:

The Mute function will be cancelled if the remote controller's [VOLUME] buttons are pressed or the receiver is set to Standby.

## Using Headphones

You can connect a pair of stereo headphones (1/4-inch phone plug) to the receiver's PHONES jack for private listening.

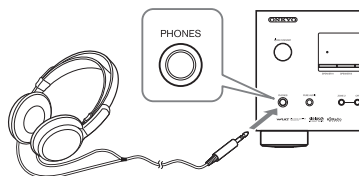

### Notes:

- Always turn down the volume before connecting your headphones.
- While the headphones plug is inserted in the PHONES jack, the speakers are turned off.
- If you connect an iPod or iPhone to the USB port on this device, no sound will be output from the headphones jack.

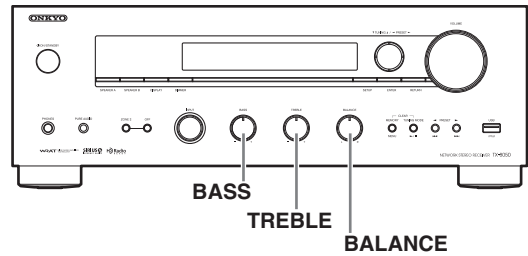
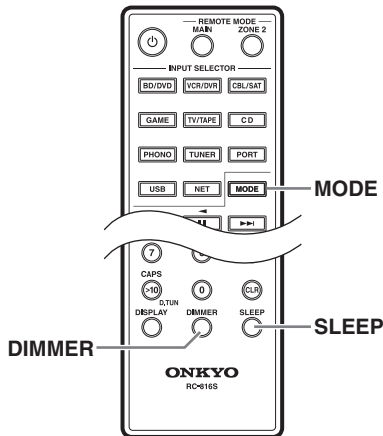

### Setting the Display Brightness

You can adjust the brightness of the display.

**Press the remote controller's [DIMMER] button repeatedly to select: dim, dimmer, or normal brightness.**

You can also use the receiver's [DIMMER] button (not European model).

### Using the Sleep Timer (remote controller only)

With the sleep timer, you can set the receiver so that it turns off automatically after a specified period.

**Press the remote controller's [SLEEP] button repeatedly to select the required sleep time.**

You can set the sleep time from 90 to 10 minutes in 10 minute steps.

The SLEEP indicator appears on the display when the sleep timer has been set, as shown. The specified sleep time appears on the display for about 5 seconds; then the previous display reappears.

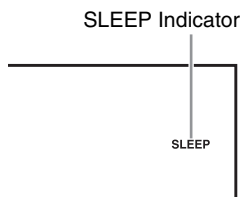

**To cancel the sleep timer,** press the [SLEEP] button repeatedly until the SLEEP indicator disappears.

**To check the remaining sleep time,** press the [SLEEP] button. Note that if you press the [SLEEP] button while the sleep time is being displayed, you'll shorten the sleep time by 10 minutes.

### Using the Tone and Balance Controls

This section explains the following functions that can be used with any input source.

#### Adjusting the Bass

The BASS control adjusts bass sounds. Turn it up to make them louder. Turn it down to make them quieter. Normally, it should be set midway.

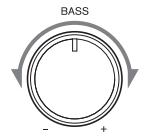

#### Adjusting the Treble

The TREBLE control adjusts treble sounds. Turn it up to make them louder. Turn it down to make them quieter. Normally, it should be set midway.

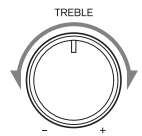

#### Adjusting the Balance

The BALANCE control is used to control the relative volume level of the left and right speaker systems.

**Note:**

If headphones are connected, the BALANCE control has no effect.

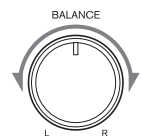

### Select the Audio Input

If a digital source is being input, the input selection will automatically switch to digital.

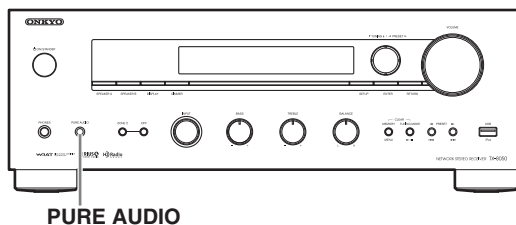
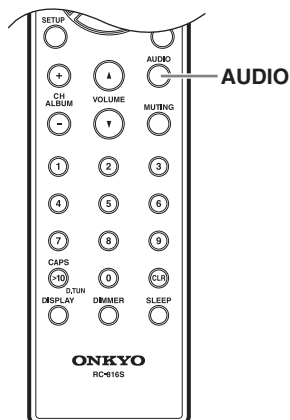

## Selecting the Listening Mode

Press the remote controller's [AUDIO] button repeatedly to select the listening mode. The setting will change as follows each time you press the [AUDIO] button.

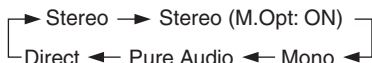

When the Stereo indication is shown, pressing the [AUDIO] button will make the display indicate “Music Optimizer: On” for several seconds, and the “M.Opt” indicator will also light. In this state, you can enjoy stereo sound enhanced by the Music Optimizer function.

When the DIRECT function is off, the tone controls can be used to adjust the sound, and the DIRECT indicator goes off.

When the DIRECT function is on, the tone controls are bypassed, so you can enjoy pure sound. The DIRECT indicator lights up.

You can configure whether the DIRECT function is applied or not for input sources individually.

The Music Optimizer function enhances the sound quality of compressed music files.

**To cancel the Music Optimizer function,** press the [AUDIO] button repeatedly to make the “M.Opt” indicator disappear.

**To cancel the DIRECT function,** press the remote controller's [AUDIO] button repeatedly to select Stereo.

### Note:

The Music Optimizer function only works with PCM digital audio input signals with a sampling rate below 48 kHz and analog audio input signals.

The Music Optimizer is disabled when the Direct or Pure Audio listening mode is selected.

## Enjoying the Pure Audio Sound

Pressing the [PURE AUDIO] button on the receiver activates the Pure Audio listening mode.

PURE AUDIO

The Pure Audio listening mode allows you to enjoy purer sound by disabling the video signal output and turning off the indication in the display.



In the Pure Audio listening mode, the tone controls are bypassed and adjustments using the BASS and TREBLE controls are ignored.

Pure Audio listening mode can be turned on/off individually for each input source.

### Note:

- You can't select Pure Audio mode if Zone 2 is on.

**To cancel the Pure Audio listening mode,** press the receiver's [PURE AUDIO] button.

# Recording

**Unless you have the full consent of the copyright holder, copyright laws prohibit using your recordings for anything other than personal enjoyment!**

This section explains how to record the selected input source to a component with recording capability, and how to record audio and video from different sources.

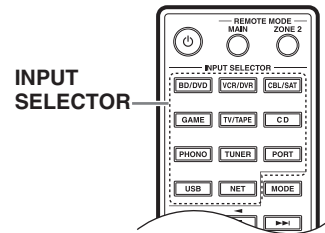
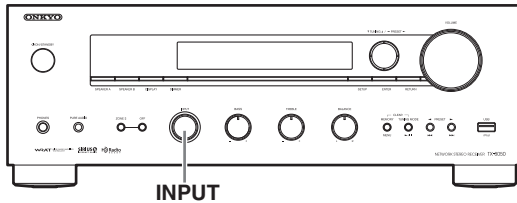

## Recording the Input Source

Audio sources can be recorded to a recorder (e.g., cassette tape deck, CDR, MD recorder). Video sources can be recorded to a video recorder (e.g., VCR, DVD recorder).

### 1 Prepare the recorder:

- Set the recorder so that it's ready for recording.
- If necessary, adjust the recording level on the recorder.
- See the recorder's manual for more information.

### 2 Use the receiver's [INPUT] selector, or the remote controller's INPUT SELECTOR buttons to select the component that you want to record from.

### 3 Start playback on the component selected in step 1.

#### Notes:

- If you select another input source during recording, the newly selected input source will be recorded.
- The volume, balance, mute and tone controls have no effect on the signal being recorded.

## Recording Audio and Video from Separate Sources

You can overdub audio onto your video recordings by simultaneously recording audio and video from two separate sources. This is possible because the audio source is recorded when an audio-only input source, such as TAPE, TUNER, or CD is selected; the video source can be recorded simultaneously when a video input source is connected to BD/DVD, CBL/SAT or GAME.

In the following example, audio from the CD player connected to the CD IN jacks and video from the camcorder connected to the GAME IN jack are recorded by the VCR connected to the VCR/DVR OUT jacks.

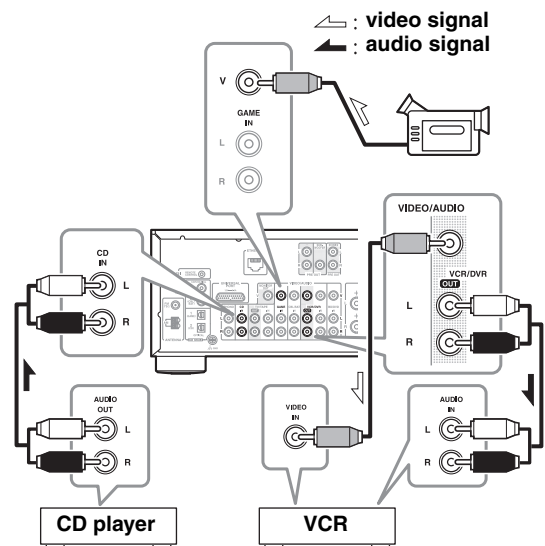

### 1 Prepare the camcorder and CD player for playback.

### 2 Prepare the VCR for recording.

### 3 Press the remote controller's [GAME] INPUT SELECTOR button.

### 4 Press the remote controller's [CD] INPUT SELECTOR button.

This selects the CD player as the audio source, but leaves the camcorder as the video source.

### 5 Start recording on the VCR, then start playback on the camcorder and CD player.

Video from the camcorder and audio from the CD player are recorded by the VCR.

# Listening to the Radio

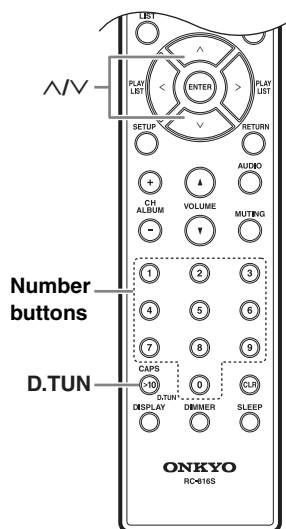
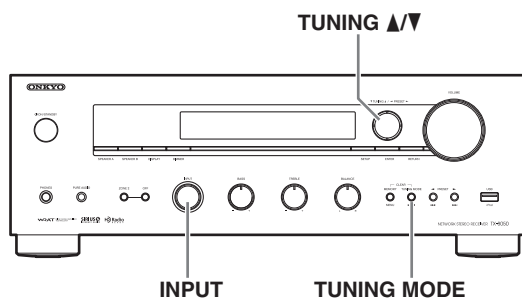

## Listening to AM/FM Stations

With the built-in tuner, you can enjoy AM and FM radio stations.

- 1 Use the receiver's [INPUT] selector, or the remote controller's INPUT SELECTOR buttons to select AM or FM.**

In this example, FM has been selected.

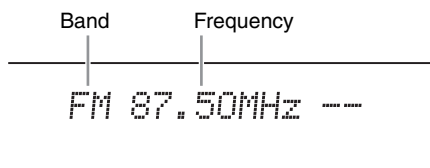

(Actual display depends on the country.)

- 2 Press the [TUNING MODE] button so that the AUTO indicator appears or disappears from the display.**

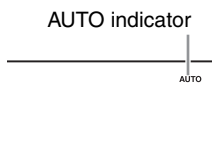

### Auto Tuning

To activate this mode, press the [TUNING MODE] button to turn on the "AUTO" indicator. In this mode, you will receive the broadcast in stereo sound.

### Manual Tuning

To activate this mode, press the [TUNING MODE] button to turn off the "AUTO" indicator. In this mode, you will receive the broadcast in monaural sound.

- 3 Press the TUNING [▲] or [▼] button.**

You can also use the remote controller's arrow [^]/[v] buttons to tune the radio.

### Auto Tuning

Searching stops when a station is found.

### Manual Tuning

The frequency stops changing when you release the button.

Press the buttons repeatedly to change the frequency one step at a time.

The frequency changes in 0.05 MHz steps (or 0.05 MHz to 0.2 MHz for North American model) for FM, and 9 kHz (or 10 kHz) steps for AM.

When tuned to a station, the TUNED indicator appears. When tuned to a stereo FM station, the FM STEREO indicator also appears.

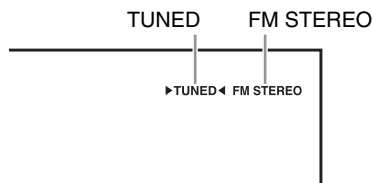

### Tuning to Weak FM Stereo Stations

If the signal from a stereo FM station is weak, it may be impossible to get good reception. In this case, switch to Manual Tuning mode and listen to the station in mono.

## Listening to the Radio—Continued

### ■ Tuning into Stations by Frequency

You can tune to AM and FM stations directly by entering the appropriate frequency.

- 1 Press the remote controller's [D.TUN] button.**



(Actual display depends on the country.)

- 2 Within 8 seconds, use the number buttons to enter the frequency of the radio station.**

For example, to tune to 87.5 (FM), press 8, 7, 5.

### Presetting AM/FM Stations

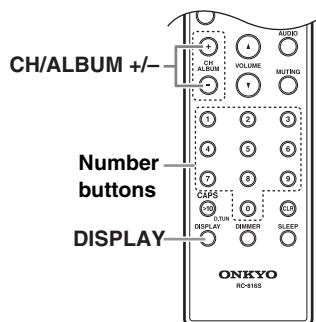
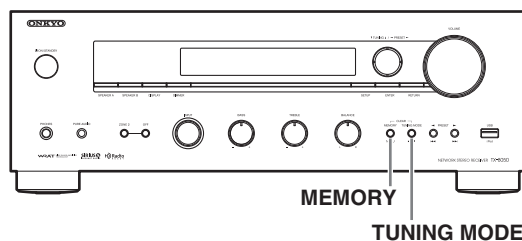

You can store up to 40 of your favorite AM/FM radio stations as presets.

Presetting FM/AM stations is performed by the receiver.

- 1 Tune to the AM/FM station that you want to store as a preset.**

- 2 Press the [MEMORY] button.**

The preset number flashes.



(Actual display depends on the country.)

- 3 While the preset number flashes (about 8 seconds), use the PRESET [◀]/[▶] buttons to select a preset from 1 through 40.**

- 4 Press the [MEMORY] button again to store the station or channel.**

The station or channel is stored and the preset number stops flashing.

Repeat this procedure for all of your favorite AM/FM radio stations.



### ■ Selecting Presets

---

To select a preset, use the number buttons on the remote controller, the remote controller's CH/ALBUM [ + ]/[ - ] buttons or the receiver's PRESET [ ◀ ]/[ ▶ ] buttons.

---

### ■ Deleting Presets

---

#### 1 Select the preset that you want to delete.

See the previous section.

---

#### 2 While holding down the [MEMORY] button, press the [TUNING MODE] button.

The preset is deleted and its number disappears from the display.

---

### ■ Name Edit

You can enter a custom name for radio preset for easy identification. When entered, the custom name will appear on the display.

The custom name is edited using the character input screen.

---

#### 1 Press the [SETUP] button on the remote controller.

---

#### 2 Use the arrow [ ^ ]/[ v ] button to select “2. Souce Setup,” and then press [ENTER].

---

#### 3 Use the arrow [ ^ ]/[ v ] button to select “Name Edit,” and then press [ENTER].

---

#### 4 Use the arrow [ ^ ]/[ v ]/[ < ]/[ > ] button to select a character, and then press [ENTER].

Repeat this step to enter up to 10 characters.

---

```
< █ >  
#bcdefghijklm
```

---

#### 5 When you've finished editing the name and want to store it, be sure to use the arrow [ ^ ]/[ v ]/[ < ]/[ > ] button to select “OK” and then press [ENTER]. If you fail to do this, the name won't be saved.

---

```
< favorite01 >  
Shift+BS OK
```

---

#### Shift\*1:

Switches the displayed character.

#### ←(Left)/→(Right):

Select these to move the cursor within the Name input area.

#### Space:

Enters a space character.

#### Back Space\*2:

“Back Space” moves the cursor backward one character space. In addition, “Back Space” deletes the character to the left of the cursor.

#### OK:

Specifies that the entry is complete.

#### Tips:

\*1 You can also perform this on the remote controller by using >10.

\*2 By pressing [CLR] on the remote controller, you can delete all characters in the input.

---

#### Notes:

- This procedure can also be performed on the receiver by using [SETUP], TUNING [▲]/[▼], PRESET [◀]/[▶], and ENTER.
- Press [RETURN] to return to the previous menu.

### ■ Switching the Display

When receiving AM or FM, you can press the remote controller's [DISPLAY] button to switch the display between the name you specified in Name Edit and the frequency that's being received.

## Using RDS (European model only)

RDS only works in areas where RDS broadcasts are available. When tuned into an RDS station, the RDS indicator appears.

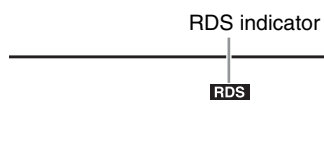

### ■ What is RDS?

RDS stands for Radio Data System and is a method of transmitting data embedded in FM radio signals. It was developed by the European Broadcasting Union (EBU) and is available in most European countries. Many FM stations use it these days. In addition to displaying text information, RDS can also help you find radio stations by type (e.g., news, sport, rock, etc.).

The receiver supports four types of RDS information:

#### **PS (Program Service)**

When tuned to an RDS station that's broadcasting PS information, the station's name will be displayed.

#### **RT (Radio Text)**

When tuned to an RDS station that's broadcasting text information, the text will be shown on the display (→ page 27).

#### **PTY (Program Type)**

This allows you to search for RDS radio stations by type (→ page 27).

#### **TP (Traffic Program)**

This allows you to search for RDS radio stations that broadcast traffic information (→ page 27).

#### **Notes:**

- In some cases, the text characters displayed on the receiver may not be identical to those broadcast by the radio station. Also, unexpected characters may be displayed when unsupported characters are received. This is not a malfunction.
- If the signal from an RDS station is weak, RDS data may be displayed intermittently or not at all.

### ■ Switching the Display

When receiving RDS, you can press the remote controller's [RT/PTY/TP] button to switch the information shown in the display.

## RDS Program Types (PTY)

Type	Display
None	NONE
News reports	NEWS
Current affairs	AFFAIRS
Information	INFO
Sport	SPORT
Education	EDUCATE
Drama	DRAMA
Culture	CULTURE
Science and technology	SCIENCE
Varied	VARIED
Pop music	POP M
Rock music	ROCK M
Middle of the road music	EASY M
Light classics	LIGHT M
Serious classics	CLASSICS
Other music	OTHER M
Weather	WEATHER
Finance	FINANCE
Children's programmes	CHILDREN
Social affairs	SOCIAL
Religion	RELIGION
Phone in	PHONE IN
Travel	TRAVEL
Leisure	LEISURE
Jazz music	JAZZ
Country music	COUNTRY
National music	NATION M
Oldies music	OLDIES
Folk music	FOLK M
Documentary	DOCUMENT
Alarm test	TEST
Alarm	ALARM

### Displaying Radio Text (RT)

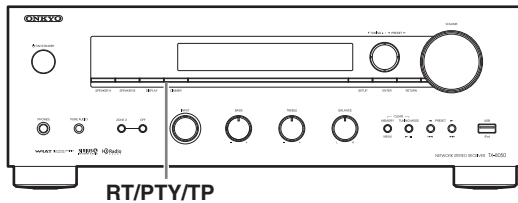

When tuned to an RDS station that's broadcasting text information, the text can be displayed.

**Press the [RT/PTY/TP] button once.**

The RT information scrolls across the display.

#### Notes:

- The message "Waiting" may appear while the receiver waits for the RT information.
- If the message "No Text Data" appears on the display, no RT information is available.

### Finding Stations by Type (PTY)

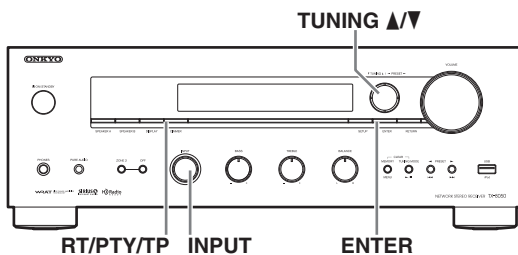

You can search for radio stations by type.

**1 Use the [INPUT] selector to select RDS.**

**2 Press the [RT/PTY/TP] button twice.**

The current program type appears on the display.

**3 Use the TUNING [▲]/[▼] buttons to select the type of program you want.**

See the table on page 26.

**4 To start the search, press [ENTER].**

The receiver searches until it finds a station of the type you specified, at which point it stops briefly before continuing with the search.

**5 When a station you want to listen to is found, press [ENTER].**

If no stations are found, the message "Not Found" appears.

### Listening to Traffic News (TP)

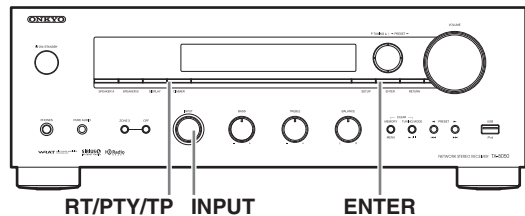

You can search for stations that broadcast traffic news.

**1 Use the [INPUT] selector to select RDS.**

**2 Press the [RT/PTY/TP] button three times.**

If the current radio station is broadcasting TP (Traffic Program), "[TP]" will appear on the display, and traffic news will be heard as and when it's broadcast. If "TP" without square brackets appears, this means that the station is not broadcasting TP.

**3 To locate a station that is broadcasting TP, press [ENTER].**

The receiver searches until it finds a station that's broadcasting TP.

If no stations are found, the message "Not Found" appears.

# Using the USB/Network Device

## Connecting the iPod/iPhone Directly to the USB Port

USB can be used to play music files stored on iPod/iPhone, which can be plugged into the receiver's USB port.

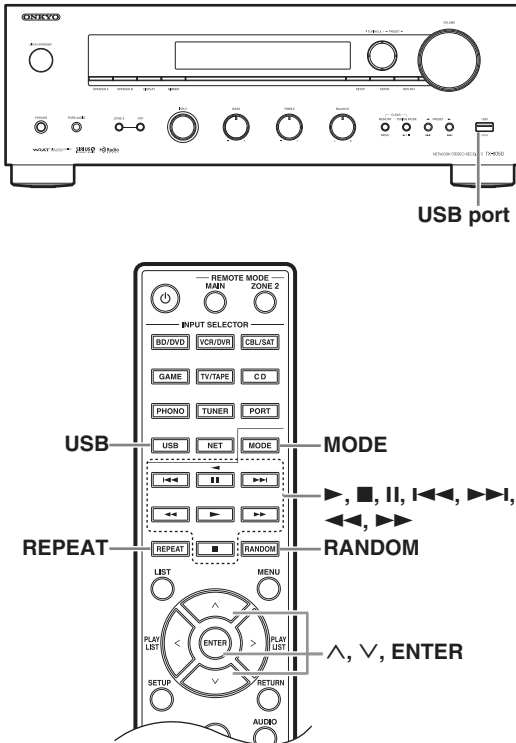

## Playing Music Files on the iPod/iPhone

This section explains how to play music files on the iPod/iPhone.

Compatible iPod/iPhone models

Made for:

iPod touch (1st, 2nd, 3rd and 4th generation), iPod classic, iPod with video, iPod nano (1st, 2nd, 3rd, 4th, 5th and 6th generation), iPhone 4, iPhone 3GS, iPhone 3G, iPhone

### 1 Press [USB] to select the USB input.

### 2 Connect the USB cable that comes with the iPod/iPhone to the USB port at the front of the receiver.

- The USB appears in the display if the receiver is able to read the iPod/iPhone.
- The USB flashes if the receiver cannot read the iPod/iPhone.

### 3 Press [MODE] to switch to Extended Mode\*<sup>1</sup>.

A list of your iPod model's contents appears. To open a folder, use [^]/[v] to select it, and then press [ENTER].

- With the default settings, the iPod/iPhone can be manipulated as Standard Mode\*<sup>2</sup>.
- Pressing [MODE] again switches back to Standard Mode.

### 4 Use [^]/[v] to select a music file, and press [ENTER] or [▶] to start playback.

- To return to the previous menu during playback, press [RETURN].
- To stop or pause playback, press [■] or [||], respectively.
- To select the next song, press [▶▶]. To select the beginning of the current song, press [◀◀]. To select the previous song, press [◀◀] twice.
- To fast forward the current song, press [▶▶]. To fast reverse the current song, press [◀◀].
- To switch the repeat mode, press [REPEAT]. To switch the random mode, press [RANDOM].

#### ■ Standard Mode control

The content information is not displayed on the receiver's display, but can be manipulated using the iPod/iPhone or the Remote Controller.

#### Note:

The audio of video content can be played back but no video will be displayed onscreen.

#### ■ Extended Mode control

The content information is displayed (lists are displayed) on the receiver's display, and you can select and manipulate the content while looking at the receiver's display.

Top display list:

Playlists, Artists, Albums, Genres, Songs, Composers, Shuffle Songs, Now Playing

\*1 When you disconnect the iPod/iPhone, the receiver stores the mode. This means that if you disconnect when in Extended Mode, the receiver will start in Extended Mode when you next connect the iPod/iPhone.

\*2 The following iPod models are not supported in Standard Mode. These iPod models can only be controlled in Extended Mode.

iPod (5th generation)

iPod nano (1st generation)

## Playing the USB Device

This section explains how to play music files from a USB device (e.g., USB flash drives and MP3 players). See also: “Network/USB Features” (→ page 34).

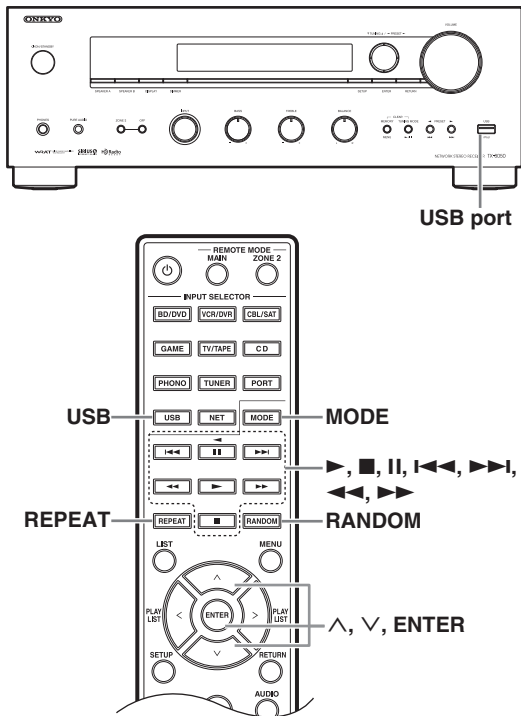

**1** Press [USB] button to select the “USB” input.

**2** Plug your USB device into the receiver’s USB port.

The USB appears in the display. It will flash if the receiver cannot read the USB device.

**3** Press [ENTER].

A list of the device’s contents appears. To open a folder, use [^]/[v] to select it, and then press ENTER.

**4** Use [^]/[v] to select a music file, and press [ENTER] or [▶] to start playback.

- To stop or pause playback, press [■] or [II], respectively.
- To select the next song, press [▶▶]. To select the beginning of the current song, press [I◀◀]. To select the previous song, press [I◀◀] twice.
- To fast forward the current song, press [▶▶]. To fast reverse the current song, press [◀◀].
- To switch the repeat mode, press [REPEAT]. To switch the random mode, press [RANDOM].

### Tip:

You can also use the receiver’s [MENU], [▶/II], [I◀◀] or [▶▶] buttons as follows.

- [MENU]: Hold down to move to the top menu.
- [▶/II]: Start playback / Pause playback
- [I◀◀]: Select the beginning of the current song (hold down to fast reverse)
- [▶▶]: Select the next song (hold down to fast forward)

### Notes:

- If the media you connect is not supported, the message “No Storage” will appear on the display.
- If you connect a USB hard disk drive to the receiver’s USB port, we recommend that you use its AC adapter to power it.
- The receiver supports USB MP3 players that support the USB Mass Storage Class standard, which allows USB devices to be connected to computers without the need for special drivers or software. Note that not all USB MP3 players support the USB Mass Storage Class standard. Refer to your USB MP3 player’s instruction manual for details.
- Protected WMA music files on an MP3 player cannot be played.
- Onkyo accepts no responsibility whatsoever for the loss or damage to data stored on a USB device when that device is used with the receiver. We recommend that you back up your important music files beforehand.
- MP3 players containing music files that are managed with special music software are not supported.
- Operation is not guaranteed for all USB devices, which includes the ability to power them.
- Do not connect your USB device via a USB hub. The USB device must be connected directly to the receiver’s USB port.
- If the USB device contains a lot of data, the receiver make take a while to read it.
- USB devices with security functions cannot be played.
- Do not disconnect the USB device or USB cable that comes with iPod/iPhone to the USB port at the front of the receiver, while the message “Connecting...” appears on the display.
- If you connect an iPod or iPhone to the USB port on this device, no sound will be output from the headphones jack.

### Listening to the Internet Radio

You need to connect the receiver to your home network; see “Network/USB Features” (→ page 34)

You can select Internet radio stations by connecting to the receiver from your computer and selecting stations in your web browser.

Internet radio URLs in the following formats are supported: PLS, M3U, and podcast (RSS). However, depending on the type of data or audio format used by the Internet radio station, you may not be able to listen to some stations.

#### Note:

Services available may vary depending on the region. See the separate instructions for more information.

### Listening to vTuner Internet Radio

This unit includes the full vTuner Internet Radio Service at no additional charge. Once you have connected your unit to the Internet you can select vTuner Internet Radio to search for and play Internet radio stations and podcasts at any time. To enhance your Internet radio experience, the <http://onkyo.vtuner.com/> portal is available to you as an easy way to browse to find stations, set up/organize your favorites, add your own stations, get help, etc. After the first time you try vTuner Internet Radio on your unit you can use the MAC Address of your unit to create a member login account (email address and password) on the <http://onkyo.vtuner.com/> portal. To verify your MAC Address, please see “Network Setup” (→ page 42).

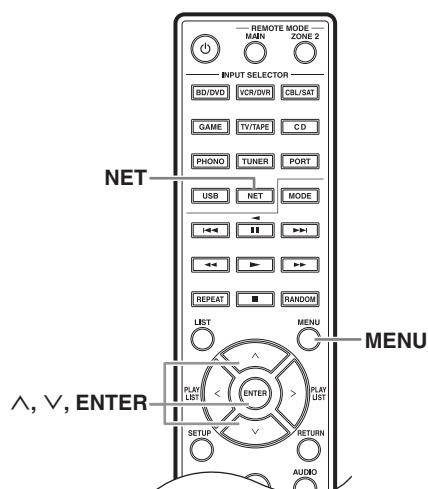

#### 1 Press [NET] button.

The “NET” appears on the display and the NET indicator lights. If it flashes, verify that the Ethernet cable is firmly connected to the receiver.

#### 2 Use [^]/[v] to select “vTuner Internet Radio” and then press [ENTER].

#### 3 Use [^]/[v] to select a program and then press [ENTER].

Playback starts.

Press [MENU] button to enable selection from the following menu items.

##### ► Stations like this:

Stations like the one currently being played back are displayed.

##### ► Add this station to My Favorites:

Adds a station to My Favorites list.

### Listening to Other Internet Radio

To listen to other internet radio stations, insert the following step after step 1 in the “Listening to vTuner Internet Radio”.

#### 1 On your computer, start your web browser and enter the receiver’s IP address in the browser’s Internet address (URL) field.

The browser connects to the receiver (WEB Setup Menu).

#### Notes:

- The receiver’s IP address is shown on “IP Address” (→ page 42).
- If you’re using DHCP, your router may not always allocate the same IP address to the receiver, so if you find that you can’t connect to the receiver, recheck the receiver’s IP address on the “Network Setup” display.

#### 2 Click on the “My Favorites” tab.

#### 3 Enter the preset name and Internet address (URL).

#### 4 Click “Save” to save the Internet radio station.

#### 5 The Internet radio station is then added to “My Favorites”.

### Registering Presets\*1

You can add the currently playing song or station to “My Favorites”. You can preset up to 40 Internet radio stations.

Once you’ve added a station to the list, simply select it in the “My Favorites” menu, and then press [ENTER] to start playback.

\*1 From the search results you can preset the stations and songs but cannot listen to them directly.

#### Top menu of Internet Radio

- ▶ **Create new station:**  
Add a favorite station or Internet radio to the presets.
- ▶ **Rename this station:**  
You can rename the preset.
- ▶ **Delete from My Favorites:**  
This will delete the preset.

**1** Press [MENU] button with the station selected or while a song is playing.

**2** Use [^]/[v] to select “Add to My Favorites”, and press [ENTER].

**3** Assign a name to the radio station you’ve registered.

For details of how to assign a name, refer to steps 4 and 5 of “Name Edit” on page 25

#### Tip:

You can also use the receiver’s [MENU], [▶/||], [◀◀◀] or [▶▶▶] buttons as follows.

- [MENU]: Hold down to move to the top menu.
- [▶/||]: Start playback / Pause playback
- [◀◀◀]: Select the beginning of the current song (hold down to fast reverse)
- [▶▶▶]: Select the next song (hold down to fast forward)

(These operations are available depending on the service and the items displayed.)

### Playing Music Files on a Server

You need to connect the receiver to your home network, see “Network/USB Features” (→ page 34)

This section explains how to play music files on a computer or media server through the receiver (Server Playback).

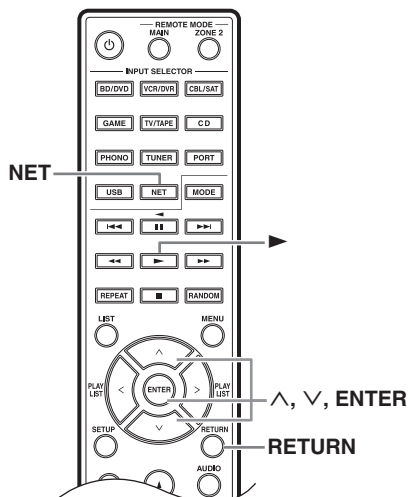

**1** Start your computer or media server.

**2** Press [NET].

“NET” appears in the display. If it flashes, confirm the network connection.

**3** Use [^]/[v] to select “DLNA”, and press [ENTER].

To go back to the previous display, press [RETURN].

**4** Use [^]/[v] to select a server, and then press [ENTER].

The menu is displayed according to the server functions.

#### Notes:

- The search function does not work with media servers which do not support this function.
- Photos and movies stored on a media server cannot be accessed from the receiver.
- Depending on the sharing settings in the media server, the receiver may not be able to access the content. See the instruction manual of the media server.

### Tip:

You can also use the receiver's [MENU], [▶/II], [◀◀] or [▶▶] buttons as follows.

- [MENU]: Hold down to move to the top menu.
- [▶/II]: Start playback / Pause playback
- [◀◀]: Select the beginning of the current song (hold down to fast reverse)
- [▶▶]: Select the next song (hold down to fast forward)

(These operations are available depending on the service and the items displayed.)

---

## 5 Use [^]/[v] to select an item, and then press [ENTER] or [▶] to start playback.

### Notes:

- Depending on the media server, [◀◀]/[▶▶]/[II] may not work.
- If the message “No Item.” appears, this means that no information can be retrieved from the server. In this case, check your server, network, and receiver connections.

---

## Windows Media Player 11 Setup

---

This section explains how to configure Windows Media Player 11 so that the receiver can play the music files stored on your computer.

- 1 Start Windows Media Player 11.**
  - 2 On the “Library” menu, select “Media Sharing”.**  
The “Media Sharing” dialog box appears.
  - 3 Select the “Share my media” check box, and then click “OK”.**
  - 4 Select the receiver in the list, and then click “Allow”.**
  - 5 Click “OK” to close the dialog box.**  
This completes the Windows Media Player 11 configuration.  
You can now play the music files in your Windows Media Player 11 library through the receiver.  
Windows Media Player 11 can be downloaded for free from the Microsoft web site.
- 

## Remote Playback

You need to connect the receiver to your home network, see “Network/USB Features” (→ page 34)

Remote Playback means you can play the music files stored on a media server or personal computer with the receiver by operating the controller device in the home network.

---

## Windows Media Player 12 Setup

---

This section explains how to configure Windows Media Player 12 so that the receiver can play the music files stored on your personal computer.

- 1 Start Windows Media Player 12.**
  - 2 On the “Stream” menu, select “Turn on media streaming”.**  
A dialog box appears.
  - 3 Move your cursor and click on “Turn on media streaming”.**  
A list of media server appears. Wording may vary slightly depending on the network location.
  - 4 Select the product in the list, and then click “Allowed”.**
  - 5 Click “OK” to close the dialog box.**  
This completes the Windows Media Player 12 configuration.  
You can now play the music files in your Windows Media Player 12 library.
- 

---

## Using Remote Playback

---

- 1 Start Windows Media Player 12.**  
To enable remote playback, you must first configure Windows Media Player 12.
  - 2 Press [NET] button.**  
The “NET” appears in the display. If it flashes, verify the network connection.
-



### **3 Use [^]/[v] to select “DLNA”, and press [ENTER].**

A list of media server appears.

**Note:**

Remote playback cannot be used while the music files of another media server are being played. You must stop their playback first.

---

### **4 On Windows Media Player 12, right-click on music file.**

Right-click menu appears. For selecting another media server, select media server from “Other Libraries” menu on Windows Media Player 12.

---

### **5 Select the receiver from right-click menu.**

“Play to” window appears and playback on the product starts. Operations during remote playback can be made from “Play to” window of Windows 7 on your personal computer. During remote playback, operations (such as Playback, Pause, Fast Forward, Fast Rewind, Previous, Next, Repeat, Random) cannot be made.

---

### **6 Adjusting the Volume**

You can adjust the volume by adjusting the volume bar in the “Remote playback” window. The default maximum volume level is 82 (0 dB). If you wish to change this, enter the value from the Web Setup in your browser.

The volume value of the remote window and the volume value of the receiver may not always match.

Adjustments you make to the volume in the receiver will not be reflected in the “Remote playback” window.

---

# Network/USB Features

## Connecting to the Network

The following diagram shows how you can connect the receiver to your home network. In this example, it's connected to a LAN port on a router, which has a 4-port 100 Base-TX switch built-in.

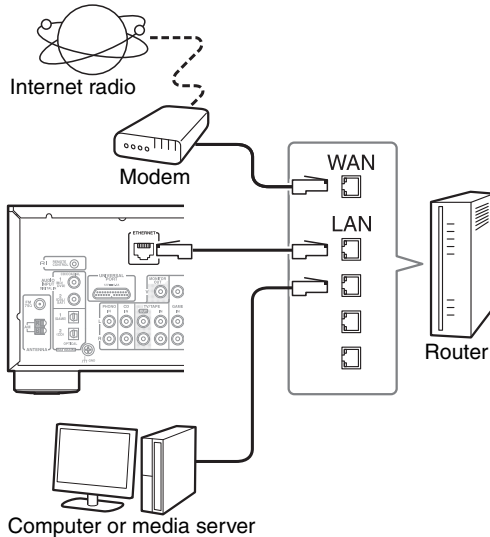

## Network Requirements

### ■ Ethernet Network

For the best results, a 100 Base-TX switched Ethernet network is recommended. Although it's possible to play music on a computer that's connected to the network wirelessly, playback may be unreliable, so it is recommended to use wired connections.

### ■ Ethernet Router

A router manages the network, data-routing and supplying of IP addresses. Your router must support the following:

- NAT (Network Address Translation). NAT allows several networked computers to access the Internet simultaneously via a single Internet connection. The receiver needs Internet access for Internet radio.
- DHCP (Dynamic Host Configuration Protocol). DHCP supplies IP addresses to the network devices, allowing them to configure themselves automatically.
- A router with a built-in 100 Base-TX switch is recommended.

Some routers have a built-in modem, and some ISPs require you to use specific routers. Please consult your ISP or computer dealer if you're unsure.

### ■ CAT5 Ethernet cable

Use a shielded CAT5 Ethernet cable (straight-type) to connect the receiver to your home network.

### ■ Internet Access (for Internet radio)

To receive Internet radio, your Ethernet network must have Internet access. A narrowband Internet connection (e.g., 56 K modem, ISDN) will not provide satisfactory results, so a broadband connection is strongly recommended (e.g., cable modem, xDSL modem, etc).

Please consult your ISP or computer dealer if you're unsure.

### Notes:

- To receive Internet radio with the receiver, your broadband Internet connection must be working and able to access the Web.  
Consult your ISP if you have any problems with your Internet connection.
- The receiver uses DHCP to configure its network settings automatically. If you want to configure these settings manually, see "Network Setup" (→ page 42).
- The receiver does not support PPPoE settings, so if you have a PPPoE-type Internet connection, you must use a PPPoE-compatible router.
- Depending on your ISP, you may need to specify a proxy server to use Internet radio. If your computer is configured to use a proxy server, use the same settings for the receiver (→ page 42).

## Server Requirements

### ■ Server playback

The receiver can play digital music files stored on a computer or media server and supports the following technologies:

- Windows Media Player 11
- Windows Media Player 12
- Windows Media Connect 2.0
- DLNA-certified media server

If the operating system of your computer is Windows Vista, Windows Media Player 11 is already installed. Windows Media Player 11 for Windows XP can be downloaded for free from the Microsoft web site.

- The computer or media server must be on the same network as the receiver.
- Each folder may contain up to 20000 music files, and folders may be nested up to 16 levels deep.

### Note:

Depending on the media server, the receiver may not recognize it, or may not be able to play its music files.

### ■ Remote playback

- Windows Media Player 12
- DLNA-certified (within DLNA Interoperability Guidelines version 1.5) media server or controller device
- Setting varies depending on the device. Refer to your device's instruction manual for details. If the operating system of your personal computer is Windows 7, Windows Media Player 12 is already installed. For more information, see the Microsoft web site.

### Minimum system requirements for Windows Media Player 11 on Windows XP

#### Operating system

Windows XP Home Edition (SP2), Windows XP Professional (SP2), Windows XP Tablet PC Edition (SP2), Update Rollup 2 for Windows XP Media Center Edition 2005 (KB900325), October 2006 Update Rollup for Windows XP Media Center Edition (KB925766)

<b>Processor:</b>	233 MHz Intel Pentium II, Advanced Micro Devices (AMD), etc.
<b>Memory:</b>	64 MB
<b>Hard disk:</b>	200 MB of free space
<b>Drive:</b>	CD or DVD drive
<b>Modem:</b>	28.8 kbps
<b>Sound card:</b>	16-bit sound card
<b>Monitor:</b>	Super VGA (800 x 600)
<b>Video card:</b>	64 MB VRAM, DirectX 9.0 b
<b>Software:</b>	Microsoft ActiveSync (only when using a Windows Mobile-based Pocket PC or smartphone)
<b>Web browser:</b>	Microsoft Internet Explorer 6 or Netscape 7.1

### USB Device Requirements

- USB mass storage device class (but not always guaranteed).
- FAT16 or FAT32 file system format.
- If the storage device has been partitioned, each section will be treated as an independent device.
- Each folder may contain up to 20,000 music files and folders, and folders may be nested up to 16 levels deep.
- USB hubs and USB devices with hub functions are not supported.

### Supported Audio File Formats

For server playback and playback from a USB device, the receiver supports the following music file formats. Not all servers support all formats.

Variable bit-rate (VBR) files are supported. However, playing times may not display correctly.

#### Notes:

- With remote playback, the receiver does not support the following music file formats: FLAC and Ogg Vorbis.
- In the case of server playback, the above-mentioned file formats may not be played depending on the server type.

#### ■ MP3 (.mp3 or .MP3)

- MP3 files must be MPEG-1/MPEG-2 Audio Layer 3 format with a sampling rate of 8 kHz, 11.025 kHz, 12 kHz, 16 kHz, 22.05 kHz, 24 kHz, 32 kHz, 44.1 kHz, 48 kHz and bitrates of between 8 kbps and 320 kbps. Incompatible files cannot be played.

#### ■ WMA (.wma or .WMA)

WMA stands for Windows Media Audio and is an audio compression technology developed by Microsoft Corporation. Audio can be encoded in WMA format by using Windows Media® Player.

- WMA files must have the copyright option turned off.
- Sampling rates of 8 kHz, 11.025 kHz, 12 kHz, 16 kHz, 22.05 kHz, 24 kHz, 32 kHz, 44.1 kHz, 48 kHz, bitrates of between 5 kbps and 320 kbps, and WMA DRM are supported.
- WMA Pro/Voice formats are not supported.

#### ■ WMA Lossless (.wma or .WMA)

- Sampling rates of 44.1 kHz, 48 kHz, 88.2 kHz, 96 kHz are supported.
- Quantization bit: 16 bit, 24 bit

#### ■ WAV (.wav or .WAV)

WAV files contain uncompressed PCM digital audio.

- Sampling rates of 8 kHz, 11.025 kHz, 12 kHz, 16 kHz, 22.05 kHz, 24 kHz, 32 kHz, 44.1 kHz, 48 kHz, 64 kHz, 88.2 kHz, and 96 kHz are supported.
- Quantization bit: 8 bit, 16 bit, 24 bit

#### ■ AAC

(.aac/.m4a/.mp4/.3gp/.3g2/.AAC/.M4A/.MP4/ .3GP or .3G2) AAC stands for MPEG-2/MPEG-4 Audio.

- Sampling rates of 8 kHz, 11.025 kHz, 12 kHz, 16 kHz, 22.05 kHz, 24 kHz, 32 kHz, 44.1 kHz, 48 kHz, 64 kHz, 88.2 kHz, 96 kHz and bitrates of between 8 kbps and 320 kbps are supported.

#### ■ FLAC (.flac or .FLAC)

FLAC is a file format for lossless audio data compression.

- Sampling rates of 8 kHz, 11.025 kHz, 12 kHz, 16 kHz, 22.05 kHz, 24 kHz, 32 kHz, 44.1 kHz, 48 kHz, 64 kHz, 88.2 kHz, and 96 kHz are supported.
- Quantization bit: 8 bit, 16 bit, 24 bit

#### ■ Ogg Vorbis (.ogg or .OGG)

- Sampling rates of 8 kHz, 11.025 kHz, 12 kHz, 16 kHz, 22.05 kHz, 24 kHz, 32 kHz, 44.1 kHz, 48 kHz and bitrates of between 48 kbps and 500 kbps are supported. Incompatible files cannot be played.

#### ■ LPCM (Linear PCM)

- Sampling rates of 8 kHz, 11.025 kHz, 12 kHz, 16 kHz, 22.05 kHz, 24 kHz, 32 kHz, 44.1 kHz, 48 kHz, 64 kHz, 88.2 kHz, and 96 kHz are supported.
  - Quantization bit: 8 bit, 16 bit, 24 bit
- \* Only for playback via network.

### About DLNA

The Digital Living Network Alliance is an international, cross-industry collaboration. Members of DLNA develop a concept of wired and wireless interoperable networks where digital content such as photos, music, and videos can be shared through consumer electronics, personal computers, and mobile devices in and beyond the home. The receiver complies with the DLNA Interoperability Guidelines version 1.5.

# iPod/iPhone Playback via Onkyo Dock

## Using the Onkyo Dock

Dock is sold separately. Models sold are different depending on the region.

For the latest information on Onkyo Dock components, see the Onkyo web site at: <http://www.onkyo.com>

Before using an Onkyo Dock, update your iPod/iPhone with the latest software, available from the Apple web site.

For supported iPod/iPhone models, see the instruction manual of the Onkyo Dock.

## UP-A1 Dock

With the UP-A1 Dock, you can easily play the music stored on your Apple iPod/iPhone through the receiver and enjoy great sound.

You can use the receiver's remote controller to operate your iPod/iPhone.

### ■ System Function

The receiver may take several seconds to start up, so you might not hear the first few seconds of the first song.

#### Auto Power On

If you start iPod/iPhone playback while the receiver is on Standby, the receiver will automatically turn on and select your iPod/iPhone as the input source.

#### Direct Change

If you start iPod/iPhone playback while listening to another input source, the receiver will automatically select your iPod/iPhone as the input source.

#### Using the receiver's Remote Controller

You can use the receiver's remote controller to control basic iPod/iPhone functions (→ page 37).

## Operating Notes

- Functionality depends on your iPod/iPhone model and generation.
- Before selecting a different input source, stop iPod/iPhone playback to prevent the receiver from selecting the iPod/iPhone input source by mistake.
- If any accessories are connected to your iPod/iPhone, the receiver may not be able to select the input source properly.
- When connecting UP-A1 Dock to the radio tuner UP-HT1 (North American model)/UP-DT1 (European model) with AUTO selected by the tuner's Mode Selector switch, you can switch the input source between UP-A1 Dock and the tuner, by pressing PORT repeatedly on the remote controller.
- While your iPod/iPhone is in the UP-A1 Dock, its volume control has no effect. If you adjust your iPod/iPhone model's volume control while it's in the UP-A1 Dock, make sure it's not set too high before you reconnect your headphones.

- The Auto Power On function will not work if you set your iPod/iPhone in the UP-A1 Dock while it is playing.
- When Zone 2 is turned on, you can't use Auto Power On and Direct Change functions.
- Do not turn off the power with the iPod/iPhone still connected to this unit via the UP-A1 Dock.
- Set your iPod/iPhone in the UP-A1 Dock after the receiver turns on.

### ■ Using Your iPod/iPhone model's Alarm Clock

You can use your iPod/iPhone model's Alarm Clock function to automatically turn on your iPod/iPhone and the receiver at a specified time. The receiver's input source will automatically be set to PORT.

#### Notes:

- To use this function, your iPod/iPhone must be in the UP-A1 Dock, and the UP-A1 Dock must be connected to the receiver.
- When you use this function, be sure to set the receiver's volume control to a suitable level.
- When Zone 2 is turned on, you can't use this function.
- You cannot use this function for sound effects on your iPod/iPhone.

### ■ Charging Your iPod/iPhone model's Battery

The UP-A1 Dock charges your iPod/iPhone model's battery while your iPod/iPhone is in the UP-A1 Dock connected to the receiver. While your iPod/iPhone is seated in the UP-A1 Dock, its battery will be charged when the receiver is set to On or Standby.

You can specify how the power is fed to your iPod/iPhone when the receiver is in Standby Mode.

#### Note:

When a UP-A1 Dock with an inserted iPod/iPhone is connected, the power consumption on standby mode slightly increases.

### ■ Status Messages

If none of the following messages are displayed on the receiver's display, check the connection to your iPod/iPhone.

#### PORT Connecting

The receiver is checking the connection with the dock.

#### PORT Not Support

The receiver does not support the connected dock.

#### PORT UP-A1

UP-A1 Dock is connected.

#### Note:

The receiver displays the message "UP-A1" for several seconds after recognizing the UP-A1.

### RI Dock

---

With the RI Dock, you can easily play the music stored on your Apple iPod/iPhone through the receiver and enjoy great sound. You can even use the receiver's remote controller to operate your iPod/iPhone.

#### Notes:

- Connect the RI Dock to the receiver with an **RI** cable (→ page 16).
- Set the RI Dock's RI MODE switch to "HDD" or "HDD/DOCK".
- Set the receiver's Input Display to "DOCK" (→ page 18).

### ■ System Function

#### System On

When you turn on the receiver, the RI Dock and your iPod/iPhone turn on automatically. In addition, when the RI Dock and iPod/iPhone are on, the receiver can be turned on by pressing [⏻ON/STANDBY].

#### Auto Power On

If you start iPod/iPhone playback while the receiver is on Standby, the receiver will automatically turn on and select your iPod/iPhone as the input source.

#### Direct Change

If you start iPod/iPhone playback while listening to another input source, the receiver will automatically switch to the input to which the RI Dock is connected.

#### Other Remote Controllers

You can use the remote controller that came with the receiver to control other iPod/iPhone functions. The available functionality depends on the receiver.

#### iPod/iPhone Alarm

If you use the Alarm function on your iPod/iPhone to start playback, the receiver will turn on at the specified time and select your iPod/iPhone as the input source automatically.

#### Notes:

- Linked operations do not work with video playback or when the alarm is set to play a sound.
- If you use your iPod/iPhone with any other accessories, iPod/iPhone playback detection may not work.

#### Operating Notes

- Use the receiver's volume control to adjust the playback volume.
- While your iPod/iPhone is inserted in the RI Dock, its volume control has no effect.
- If you do adjust the volume control on your iPod/iPhone while it's inserted in the RI Dock, be careful that it's not set too loud before you reconnect your earphones.

#### Note:

On the iPod with video and iPod nano (1st generation), the click wheel is disabled during playback.

### Controlling Your iPod/iPhone

See the Dock's instruction manual for more information.

#### ■ UP-A1 Dock

You can control your iPod/iPhone when "PORT" is selected as the input source.

#### ■ RI Dock

- Set the RI Dock's RI MODE switch to "HDD" or "HDD/DOCK".
- You can control your iPod/iPhone when "DOCK" is selected as the input source.

Press the appropriate **INPUT SELECTOR** first.

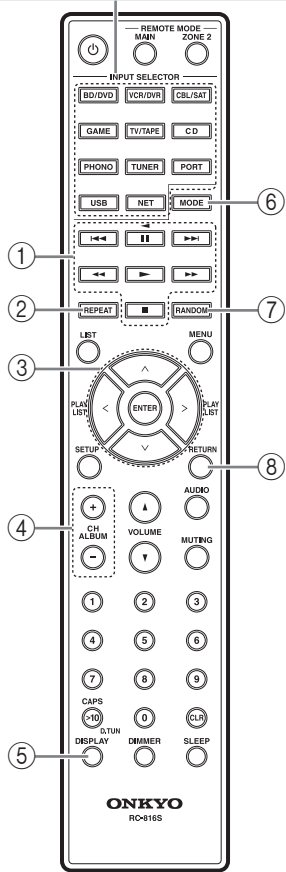

**Notes:**

- With some iPod/iPhone models or generations, or some RI Docks, certain buttons may not work as expected.
- For details on operating your iPod/iPhone, please refer to the instruction manual of the RI Dock.

✓: Available buttons

Onkyo Dock		UP-A1	RI Dock
Buttons			
①	▶, II, ■, ◀◀, ▶▶, ◀◀◀, ▶▶▶	✓	✓
②	REPEAT	✓	✓
③	∧/∨/◀/▶, ENTER	✓	✓
	PLAY LIST ◀/▶	✓*1	✓
④	ALBUM +/-	✓	✓
⑤	DISPLAY *2	✓	✓
⑥	MODE	✓*3	
⑦	RANDOM	✓	✓
⑧	RETURN	✓	

- \*1 If a UP-A1 is connected to UNIVERSAL PORT in Extended mode (→ page 8), the PLAY LIST buttons are used as the page jump buttons. With the page modes, you can quickly locate your favorite songs even when your song lists, artist lists, and so on are very long.
- \*2 [DISPLAY] turns on the backlight for 30 seconds.
- \*3 If a UP-A1 is connected to UNIVERSAL PORT, you can press [MODE] to switch between the following modes:

**Standard mode**

Nothing is displayed on the receiver’s display and you navigate and select your contents by using the display of your iPod/iPhone. Video playback is possible only in this mode.

**Extended mode**

Playlists (artists, albums, songs, and so on) are displayed on the receiver’s display, and you can navigate and select your music while looking at receiver’s display.

**Notes:**

- In Extended mode, you cannot operate your iPod/iPhone directly.
- In Extended mode, it may take some time to acquire the contents.
- In Extended mode, video content cannot be displayed on your TV.

# Controlling Other Components

You can use the receiver's remote controller to control your other AV components.

Use the REMOTE MODE buttons to select the zone of the component you want to control (MAIN or ZONE 2). Then press the INPUT SELECTOR button of the component you want to control.

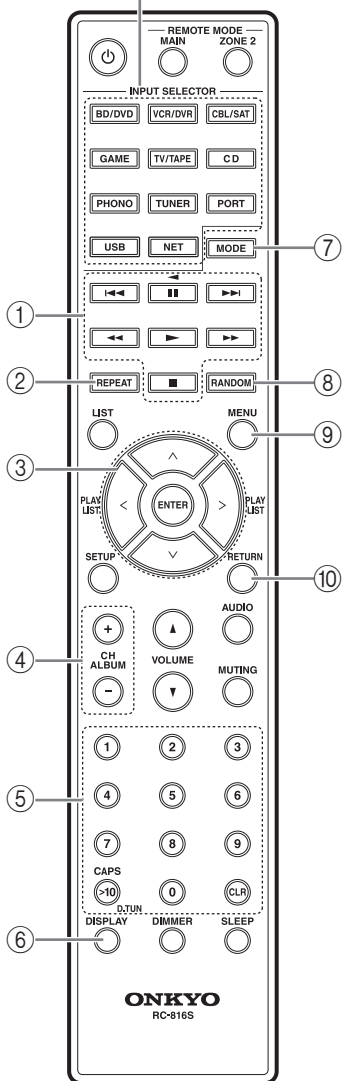

✓: Available buttons

Components		UNIVERSAL PORT	RI DOCK	CD player	Cassette tape deck *1
Buttons					
①	▶,   , ■, ◀▶, ▶▶, ◀◀, ◀◀◀	✓	✓	✓	✓ <sup>*2</sup>
②	REPEAT	✓	✓	✓	
③	^/∨/</>, ENTER	✓	✓	✓	
④	CH +/-	✓			
⑤	Number: 1 to 9, 0	✓	✓	✓	
	Number: +10	✓	✓	✓	
⑥	DISPLAY	✓	✓	✓	
⑦	MODE	✓			
⑧	RANDOM	✓	✓	✓	
⑨	MENU *3	✓			
⑩	RETURN	✓	✓		

\*1 If using a double cassette deck, cassette B will be operated.

\*2 [||] (Pause) functions as reverse playback. The [◀◀]/[▶▶] buttons will not operate.

\*3 If you're using a Universal Port device, this operates as the [SETUP] button.

## Note:

For details on controlling your iPod/iPhone, see "Controlling Your iPod/iPhone" on page 37.

## Note:

With some components, certain buttons may not work as expected, and some may not work at all.

# Advanced Setup

## Changing the Advanced Setup Settings

Here's how to change the Advanced Setup settings.

### Example: Intelli volume setting procedure

#### Intelli Volume

With IntelliVolume, you can set the input level for each input selector individually. This is useful if one of your source components is louder or quieter than the others.

Use the arrow [ $\leftarrow$ ]/[ $\rightarrow$ ] buttons to set the level.

If a component is noticeably louder than the others, use the arrow [ $\leftarrow$ ] button to reduce its input level. If it's noticeably quieter, use the arrow [ $\rightarrow$ ] button to increase its input level. The input level can be adjusted from  $-12$  dB to  $+12$  dB in 1 dB steps.

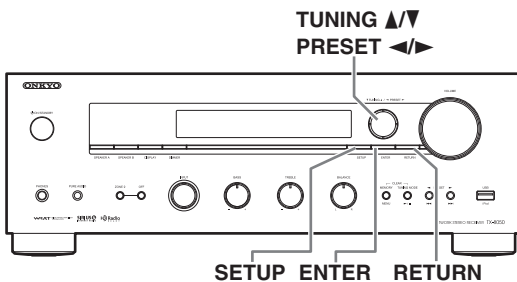
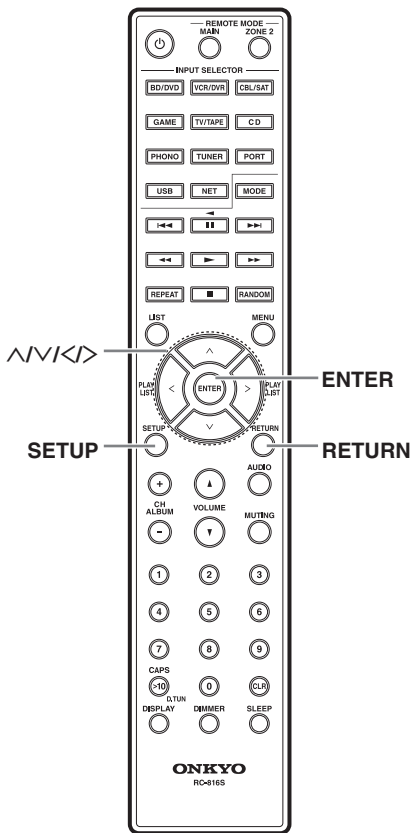

**1** Turn on the power.

**2** Press the [SETUP] button on the remote controller.

The setup menu appears in the display.

**3** Use the arrow [ $\wedge$ ]/[ $\vee$ ] buttons to select "2. Source Setup," and then press [ENTER].

The Hardware setup menu appears in the display.

2. Source Setup

**4** Use the arrow [ $\wedge$ ]/[ $\vee$ ] buttons to select "Intelli volume: 0 dB".

IntelliVolume  
: 0dB

**5** Change the Intelli volume to " $-2$  dB" using the arrow [ $\leftarrow$ ]/[ $\rightarrow$ ] buttons.

IntelliVolume  
: -2dB

**6** Press the [SETUP] button on the remote controller to complete the setting.

#### Notes:

- This procedure can also be performed on the receiver by using [SETUP], TUNING [ $\blacktriangle$ ]/[ $\blacktriangledown$ ], PRESET [ $\blacktriangleleft$ ]/[ $\blacktriangleright$ ], and ENTER.
- Press [RETURN] to return to the previous menu.



**Advanced Setup Menu**

**1. Digital Audio Input**

If you connect a component to a digital audio input, you must assign that input to an input selector. For example, if you connect your CD player to the OPTICAL IN 1, you must assign “OPTICAL1” to the “CD” input selector.

Here are the default assignments.

Input selector	Default assignment
BD/DVD	COAXIAL 1
VCR/DVR	-----
CBL/SAT	COAXIAL 2
GAME	OPTICAL 1
TV/TAPE	-----
CD	OPTICAL 2
PHONO	-----
PORT	-----

**COAXIAL1, COAXIAL2, OPTICAL1, OPTICAL2:**

Select the corresponding digital audio input, to which the component has been connected.

-----:

Select if the component is connected to an analog audio input.

**Notes:**

- Available sampling rate for PCM signals from a digital input (optical and coaxial) is 32/44.1/48/88.2/96 kHz/16, 20, 24 bit.
- If you connect a component (such as a UP-A1 Dock with an iPod inserted) to the UNIVERSAL PORT jack, you cannot assign any input to the PORT selector.

**2. Source Setup**

**Intelli Volume**

See page 40.

IntelliVolume does not apply for Zone 2.

**Name**

This changes the name displayed by the INPUT selector. First use the INPUT selector to select the name of the source you want to change, and then use this Setup Menu to change the name that's displayed. Use the [<]/[>] buttons to step through the following names.

--- → Blu-ray → DVD → HD DVD → VCR → DVR → Tivo → CableSTB → SAT STB → PS3 → Wii → Xbox → PC → TV → CD → TAPE → iPod → ---

**Name Edit**

You can edit the name of the radio preset if an FM or AM preset station is being received. (See page 25)

**3. Hardware Setup**

**Speaker Impedance**

See “Configuring the Speaker Impedance” on page 12.

**AM/FM Frequency Setup (North American model)**

For AM/FM tuning to work properly, you must specify the AM/FM frequency step (10 kHz/200 kHz or 9 kHz/50 kHz) used in your area. Note that when this setting is changed, all radio presets will be deleted.

Default setting: 10 kHz/200 kHz

**AM Frequency Setup (European model)**

For AM tuning to work properly, you must specify the AM frequency step (9 kHz/10 kHz) used in your area. Note that when this setting is changed, all radio presets will be deleted.

Default setting: 9 kHz

**Auto Standby**

When “Auto Standby” is set to “On”, the receiver will automatically enter Standby mode if there is no operation for 30 minutes with no audio and no video signal input.

Default setting: Off (North American model), On (European model)

**Notes:**

- With some sources, the Auto Standby function may activate itself during playback.
- The Auto Standby function does not work when Zone2 is on.

**UP-A1 Charge Mode**

You can specify how the power is fed to your iPod/iPhone when the receiver is in Standby Mode.

Auto: Power feeding is interrupted when your iPod/iPhone is fully charged.

On: Power feeding continues even if your iPod/iPhone is fully charged.

Off: Your iPod/iPhone is not charged.

Default setting: Auto

**Notes:**

- This cannot be selected if no device is connected to UNIVERSAL PORT.
- This setting cannot be selected when:
  - the UP-A1 Dock with docked iPod/iPhone is not connected to the receiver, or
  - the docked iPod/iPhone model is not supported.
- When the “UP-A1 Charge Mode” setting is set to “On”, or to “Auto” with your iPod/iPhone recharging, the SLEEP indicator is dimly lit in standby mode. In such conditions, the power consumption of the receiver slightly increases.

### 4. Zone2 Setup

---

#### Zone2 Out

If you have connected your Zone 2 speakers to an amp with no volume control, set the Zone 2 Out setting to Variable so that you can set the zone's volume, balance, and tone on the receiver.

**Fixed:** The Zone 2 volume must be set on the amp in that zone.

**Variable:** The Zone 2 volume can be set on the receiver.

Default setting: Fixed

#### Z2 Bass

With this setting, you can boost or cut low-frequency sounds output from the speakers for Zone 2.

The output can be adjusted from -10 dB to +10 dB in 2 dB steps.

Default setting: 0 dB

#### Z2 Treble

With this setting, you can boost or cut high-frequency sounds output from the speakers for Zone 2.

The output can be adjusted from -10 dB to +10 dB in 2 dB steps.

Default setting: 0 dB

#### Z2 Balance

With this setting, you can control the relative volume level of the left and right speaker for Zone 2.

Default setting: 0

### 5. Network Setup

---

This section explains how to configure the receiver's network settings manually.

If your router's DHCP server is enabled, you don't need to change any of these settings, as the receiver is set to use DHCP to configure itself automatically by default (i.e., DHCP is set to "Enable"). If, however, your router's DHCP server is disabled (you're for example using static IP), you'll need to configure these settings yourself, in which case, a knowledge of Ethernet networking is essential.

#### Note:

The setup menu display will become available several tens of seconds after the receiver has started up.

#### What's DHCP?

DHCP (Dynamic Host Configuration Protocol) is used by routers, computers, the receiver, and other devices to automatically configure themselves on a network.

#### What's DNS?

The DNS (Domain Name System) translates domain names into IP addresses. For example, when you enter a domain name such as [www.onkyousa.com](http://www.onkyousa.com) in your Web

browser, before accessing the site, your browser uses DNS to translate this into an IP address, in this case 63.148.251.142.

#### MAC Address

This is the receiver's MAC (Media Access Control) address. This address cannot be changed.

#### DHCP

This setting determines whether or not the receiver uses DHCP to automatically configure its IP Address, Subnet Mask, Gateway, and DNS Server settings.

Enable (Default setting)

Disable

#### Note:

If you select "Disable", you must configure the "IP Address", "Subnet Mask", "Gateway", and "DNS Server" settings yourself.

#### IP Address

Class A: "10.0.0.0" to "10.255.255.255"

Class B: "172.16.0.0" to "172.31.255.255"

Class C: "192.168.0.0" to "192.168.255.255"

Enter a static IP address provided by your ISP. Most routers use Class C IP addresses.

#### Subnet Mask

Enter the subnet mask address provided by your ISP (typically 255.255.255.0).

#### Gateway

Enter the gateway address provided by your ISP.

#### DNS Server

Enter a DNS server address provided by your ISP.

#### Proxy URL

To use a Web proxy, enter its URL here.

#### Proxy Port

If you're using a Web proxy, enter a proxy port number here.

#### Network Control

This setting enables or disables control over the network.

Enable

Disable (Default setting)

#### Note:

When set to "Enable", the NET indicator is dimly-lit and the power consumption slightly increases in standby mode.

#### Control Port

This is the network port used for control over the network.

"49152" to "65535"

If you've made a change to any item, the display will indicate "SAVE [ENTER]: [SELECT]" when you exit Network Setup. If you want to apply the changes you made, press [ENTER]. If you want to re-do the setup, press [RETURN] to re-do the procedure from the beginning.

**Note:**

When the "Network Control" setting is set to "Disable", this setting cannot be selected.

### 6. Firmware Update

---

See "Firmware Update" for the update procedure.

**Notes:**

- The setup menu display will become available several tens of seconds after the receiver has started up.
- Perform the firmware update only when such an announcement is posted on the Onkyo web site. Visit the Onkyo web site for the latest information.
- It takes about 5 minutes to complete the firmware update.

**Version**

Displays the current version of the firmware.

**Receiver**

**via NET:**

Performs the firmware update via Internet. Check the network connection before updating.

**via USB:**

Performs the firmware update from a USB device.

These settings allow you to update the receiver's firmware. Do not shutdown the power of the receiver while updating.

**Universal Port**

**via NET:**

Performs the firmware update via Internet. Check the network connection before updating.

**via USB:**

Performs the firmware update from a USB device.

You can update the Onkyo dock's firmware. Do not shutdown the power of the receiver while update.

**Note:**

This update must not be performed if no dock is connected to the UNIVERSAL PORT jack.

# Zone 2

In addition to your main listening room, you can also enjoy playback in a second room referred to as Zone 2. In addition, you can select a different source for each room.

## Connecting Zone 2

This setup allows 2-channel playback (with the speaker set A and B) in your main listening room and 2-channel stereo playback in Zone 2, with a different source in each room.

### Hookup

- Use an RCA audio cable to connect the receiver's ZONE 2 PRE OUT L/R jacks to an analog audio input on your Zone 2 amp.
- Connect your Zone 2 speakers to the speaker terminals on your Zone 2 amp.

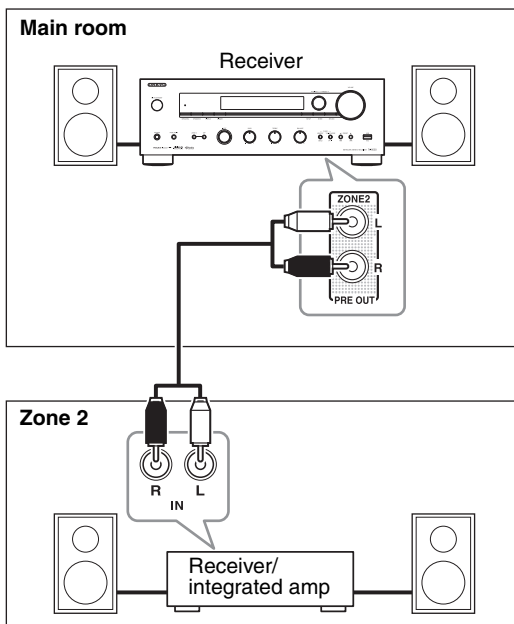

### Notes:

- The Zone 2 volume must be set on the Zone 2 amp.
- If you're using a power amp with no volume control in Zone 2, you must set the Zone 2 Out setting to Variable (→ page 42).

## Zone 2 Out Settings

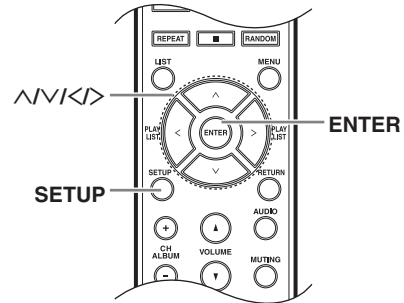

If you have connected your Zone 2 speakers to an amp with no volume control, set the Zone 2 Out setting to Variable so that you can set the zone's volume, balance, and tone on the receiver.

### 1 Press the [SETUP] button.

The setup menu appears on the display.

### 2 Use the arrow [^]/[v] buttons to select "4. Zone 2 Setup" and then press [ENTER].

The Zone 2 Setup menu appears.

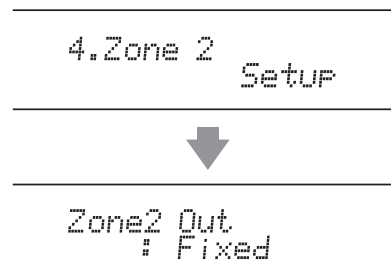

### 3 Use the arrow [<]/[>] buttons to select:

**Fixed:** The Zone 2 volume must be set on the amp in that zone.

**Variable:** The Zone 2 volume can be set on the receiver.

### 4 Press the [SETUP] button.

Setup closes.

## Using Zone 2

This section explains how to turn Zone 2 on and off, how to select an input source for Zone 2, and how to adjust the volume for Zone 2.

### Controlling Zone 2 from the receiver

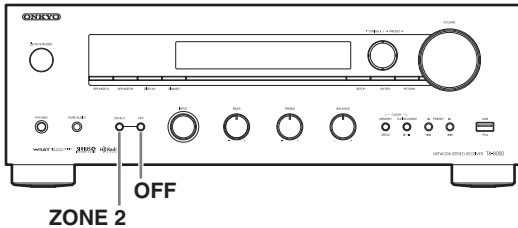

- 1 To turn on Zone 2 and select an input source, press the [ZONE 2] button repeatedly. Alternatively, press the [ZONE 2] button followed by an INPUT selector within 8 seconds.**

Zone 2 turns on and the Z2 (ZONE 2) indicator appears.

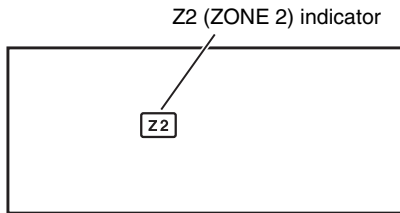

To select the same source as that of the main room, press the [ZONE 2] button repeatedly until “Zone 2 Selector: Source” appears.

```
Zone2 Selector
: Source
```

Rotate the INPUT selector to select AM or FM.

**Notes:**

- You cannot select different AM or FM radio stations for your main room and Zone 2. The same AM/FM radio station will be heard in each room.
- Similarly, you cannot select the NET and USB inputs separately for the main room and Zone 2.

- 2 To turn off Zone 2, press the Zone 2 [OFF] button.**

**Notes:**

- Only analog input sources are output by Zone 2. Digital input sources are not output. If no sound is heard when an input source is selected, check to make sure it's connected to an analog input.

- While Zone 2 is on, the Auto Power On and Direct Change RI functions do not work.

### Controlling Zone 2 with the Remote Controller

To control Zone 2, you must press the remote controller's [ZONE 2] button first.

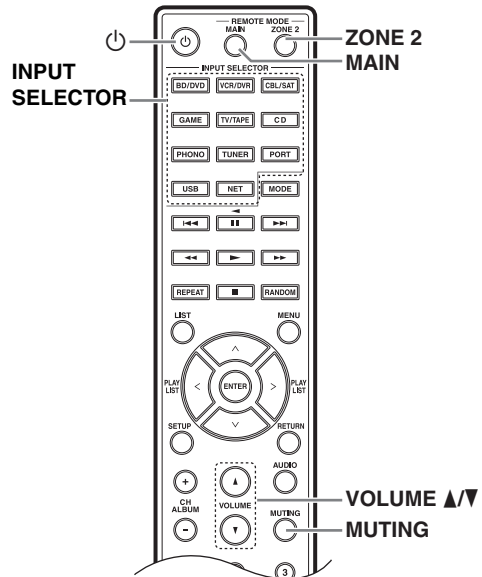

- 1 Press the [ZONE 2] button, then point the remote controller at the receiver and press the [⏻] button.**

Zone 2 turns on and the Z2 (ZONE 2) indicator appears.

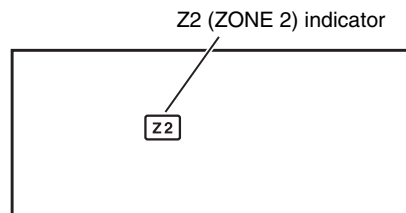

- 2 To select an input source for Zone 2, press the [ZONE 2] button, followed by an INPUT SELECTOR button.**

To select AM or FM press the [TUNER] Input Selector button repeatedly.

**Note:**

- You cannot select different AM or FM radio stations for your main room and Zone 2. The same AM/FM radio station will be heard in each room.
- Similarly, you cannot select the NET and USB inputs separately for the main room and Zone 2.

## Zone 2—Continued

---

- 3** To turn off Zone 2, press the [ZONE 2] button, followed by the [⏻] button.
- 

### Adjusting the Volume of Zone 2

---

Press the receiver's [ZONE 2] button, and then use the [VOLUME] control, or remote controller's [ZONE 2] button, and then use the VOLUME [▲]/[▼] buttons.

### Muting Zone 2

---

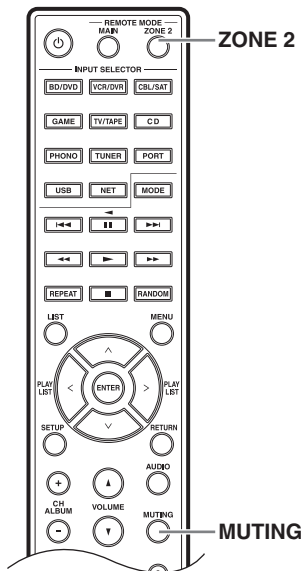

---

**On the remote controller, press the [ZONE 2] button, and then press the [MUTING] button.**

To unmute Zone 2, press the remote controller's [ZONE 2] button, and then press the [MUTING] button again.

---

#### Notes:

- Zone 2 can also be unmuted by adjusting the volume.
- The Zone 2 level, balance, and tone functions have no effect on the ZONE 2 PRE OUT when the Zone 2 Out setting is set to Fixed (→ page 42).
- To control the volume and mute of the receiver in the main room, press the remote controller's [MAIN] button and then perform the desired operation.

### Checking the Source Selected for Zone 2

---

Press the [ZONE 2] button on the receiver itself.  
The display will show the name of the selected source.

# Connecting Components Not Reached by the Remote Controller Signals (IR IN/OUT)

In order to use the remote controller to control the receiver from a remote location, you will need to prepare a multiroom kit (sold separately) such as one listed below:

- Multiroom A/V distribution and control system such as those from Niles® and Xantech®
- \* Xantech is a registered trademark of Xantech Corporation.
- \* Niles is a registered trademark of Niles Audio Corporation.

## If Remote Controller Signal Does Not Reach the Receiver Remote Sensor

### Effective Sensor Layout

#### Example for the main room

If the receiver is located inside a cabinet or other enclosure where the infrared rays from the remote controller cannot enter, then operation with the remote controller will not be possible. In such a case, it will be necessary to install a remote sensor at a location outside of the cabinet so that the infrared rays from the controller can be sensed.

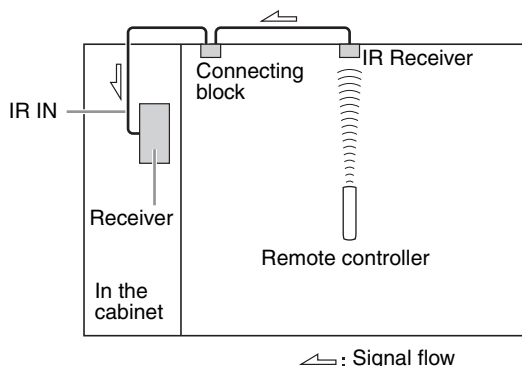

#### Example for Zone 2

The IR IN input allows you to control the receiver from Zone 2 with the remote controller even though Zone 2 may be on the other side of the building from the main zone. The diagram below shows how to make the proper connections for Zone 2.

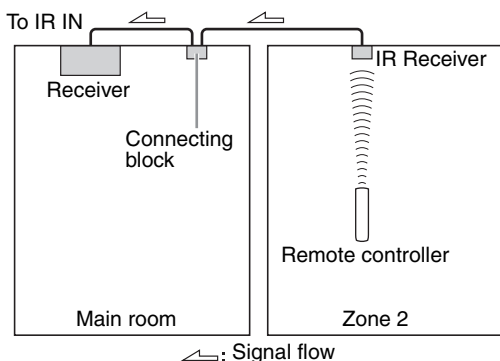

### Making Sensor Connections

When you place the IR receiver in the main room, connect the cable from the connecting block to the IR IN terminal. Make the connection as shown below. Do not plug any equipment into the power outlet until all the connections are complete.

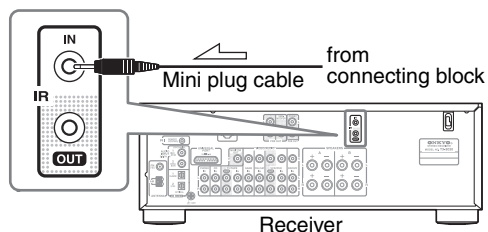

## If Remote Controller Signal Does Not Reach Other Components

### Effective Sensor Layout

In this situation, you will need to use a commercially available IR emitter. Connect the mini plug of the IR emitter to the IR OUT terminal on the receiver and then place the IR emitter on the remote sensor of the component or facing it. When the IR emitter is connected, only the signal input to the IR IN terminal is output to the IR OUT terminal. The signal input from the remote sensor on the front of the receiver will not be output to the IR OUT terminal.

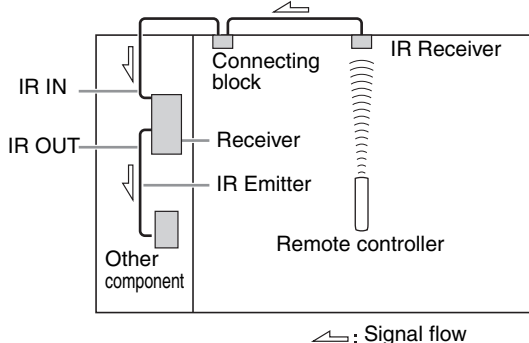

### Making Sensor Connections

The IR emitter should be connected to the receiver's IR OUT Terminal, as shown below.

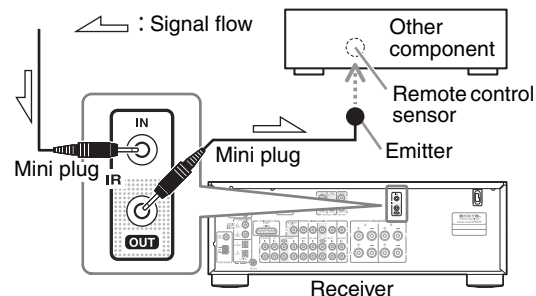

# Firmware Update

---

To update the firmware of the receiver, you can choose from the following two methods: update via network, or update via USB storage. Choose the one that best suits your environment. Before proceeding with the update, please read the corresponding explanations carefully.

## ■ Update via network

You need a wired Internet connection to update the firmware.

## ■ Update via USB storage (→ page 49)

Please prepare a USB storage device such as a USB flash memory stick. You need at least 32 MB of available space to update the firmware.

### Notes:

- Check the network connection before updating.
- Do not touch the any cable or device connected to the receiver during the updating process.
- Do not attempt to access the receiver from your PC while it is being updated.
- Do not shutdown the power of the receiver while it is being updated.
- The storage media in the USB card reader may not work.
- If the USB device is partitioned, each section will be treated as an independent device.
- If the USB device contains a lot of data, the receiver may take a while to read it.
- Operation is not guaranteed for all USB devices, which includes the ability to power them.
- Onkyo takes no responsibility whatsoever for the loss or damage of data resulting from the use of a USB device with the receiver. Onkyo recommends that you back up your important music files beforehand.
- If you connect a USB hard disk drive to the USB port, Onkyo recommends that you use its AC adapter to power it.
- USB hubs and USB devices with hub functions are not supported. Do not connect your USB device via a USB hub.
- USB devices with security functions are not supported.

### Limitation of liability

The program and accompanying online documentation are furnished to you for use at your own risk. Onkyo will not be liable and you will have no remedy for damages for any claim of any kind whatsoever concerning your use of the program or the accompanying online documentation, regardless of legal theory, and whether arising in tort or contract. In no event will Onkyo be liable to you or any third party for any special, indirect, incidental, or consequential damages of any kind, including, but not limited to, compensation, reimbursement or damages on account of the loss of present or prospective profits, loss of data, or for any other reason whatsoever.

See the Onkyo web site for latest information.

## Updating the Firmware via Network

The receiver allows you to update the firmware using the network connection on the rear panel.

### Notes:

- Make sure your receiver is turned on and an Ethernet cable is connected to the rear panel of the receiver.
- Never unplug or turn off the receiver while it is being updated.
- Never plug or unplug an Ethernet cable during the update process.
- Do not attempt to access the receiver from your PC while it is being updated.
- Never unplug the power cord during the update process.
- It takes about 5 minutes to complete the firmware update.
- The receiver will retain all your settings after the update is finished.

### Before you start

---

- Turn off the controller device connected via Ethernet cable.
- Turn off Zone 2.
- Stop playback of contents from Internet Radio, iPod/iPhone, USB or servers, etc.

### Update procedure

---

#### **1 Press the [SETUP] button on the remote controller.**

The Setup menu will be displayed on the receiver's display.

#### **2 Select "6 Firmware Update" and press [ENTER].**

The current firmware version will be displayed.

#### **3 Use [^] or [v] button to select "Via NET" and press [ENTER].**

#### **4 Select "Update" and press [ENTER].**

The update process will begin. During the update process, you can still view the update progress on the receiver's display.

#### **5 The message "Completed!" appears on the receiver's display, indicating that the update has been completed.**

#### **6 Using [⏻ ON/STANDBY] on the front panel, turn off and on the receiver.**

Do not use [⏻] on the remote controller.

Congratulations! You now have the latest firmware installed on your Onkyo receiver.

---



## Troubleshooting

### Case 1:

If “**No Update**” is displayed on the receiver’s display, it means that the firmware has already been updated. You do not need to do anything further.

### Case 2:

If an error occurs, “**Error!! \*-\*\* No media**” is displayed on the receiver’s display. (Alpha-numeric characters on the front display are denoted by asterisks.) Refer to the following table and take appropriate action.

### ■ Errors during an update via Network

Error Code	Description
*-10, *-20	The Ethernet cable was not detected. Reconnect the cable properly.
*-11, *-13, *-21, *-28	<p>Internet connection error. Check the following items:</p> <ul style="list-style-type: none"> <li>• Make sure the IP address, subnet mask, gateway address, and DNS server are configured properly.</li> <li>• Make sure the router is turned on.</li> <li>• Make sure the receiver and the router are connected with an Ethernet cable.</li> <li>• Make sure your router is configured properly. See the instruction manual of the router.</li> <li>• If your network allows only one client connection and there is any other device already connected, the receiver will not be able to access the network. Consult your Internet Service Provider (ISP).</li> <li>• If your modem does not function as a router, you will need a router. Depending on your network, you may need to configure the proxy server if necessary. See the document provided by your ISP. If you are still unable to access the Internet, the DNS or proxy server may be temporarily down. Contact your ISP.</li> </ul>

### Case 3:

If an error occurs during the update process, disconnect then reconnect the AC power cord and try again.

### Case 4:

If an error occurs due to a wrong selection of input sources, turn off and on the receiver. Then retry the update.

### Case 5:

If you do not have an Internet connection to the network, please contact Onkyo Support (→ page 50).

## Updating the Firmware via USB

The receiver allows you to update the firmware using a USB device.

### Notes:

- Never unplug or turn off the receiver during the update process.
- Never plug or unplug a USB device during the update process.
- Never unplug the USB storage device containing the firmware file or the AC power cord during the update process.
- Do not attempt to access the receiver from your PC while it is being updated.
- It takes about 5 minutes to complete the firmware update.
- The receiver will retain all your settings after the update is finished.

### Before you start

- Turn off the controller device connected via Ethernet cable.
- Turn off Zone 2.
- Stop playback of contents from Internet Radio, iPod/iPhone, USB or servers, etc.
- If there is any data in the USB device, remove it first.

### Update procedure

- 1 Connect a USB device to your PC. If there is any data in the USB device, remove it first.**
- 2 Download the firmware file from the Onkyo web site. The file name is as follows:**  
 ONKRCV\*\*\*\*\_\*\*\*\*\*.zip  
**Unzip the downloaded file. The following some/any files are created:**  
 ONKRCV\*\*\*\*\_\*\*\*\*\*.of1  
 ONKRCV\*\*\*\*\_\*\*\*\*\*.of2
- 3 Copy the extracted files to the USB device. Be careful not to copy the zip file.**
- 4 Remove the USB device from your PC and connect it to the USB port on the receiver.**
- 5 Make sure the receiver is turned on.**  
 If the receiver is in standby mode, press [⏻ ON/STANDBY] on the receiver to light the front display.

### 6 Select the USB input source.

“Now Initializing” is displayed on the front display and then the name of the USB device is displayed. It takes 20 to 30 seconds to recognize the USB device.

### 7 Press the [SETUP] button on the remote controller.

Setup menu will be displayed on the front display. The procedures thereafter can also be performed on the receiver by using its [SETUP], arrow and [ENTER] buttons.

### 8 Select “Update” and press [ENTER].

### 9 Select “Via USB” and press [ENTER].

### 10 Select “Update” and press [ENTER].

The update process will begin. During the update process, you can still view the update progress on the front display of the receiver. Do not turn off the receiver and do not remove the USB device during the update process.

### 11 The message “Completed!” appears on the front display of the receiver, indicating that the update has been completed.

### 12 Using [⏻ ON/STANDBY] on the front panel, turn off the receiver and then remove the USB device.

Do not use [⏻] on the remote controller. Congratulations! You now have the latest firmware installed on your Onkyo receiver.

## Troubleshooting

#### Case 1:

If “No Update” is displayed on the front display of the receiver, it means that the firmware has already been updated. You do not need to do anything further.

#### Case 2:

If an error occurs, “Error!! \*\_\*\* No media” is displayed on the front display of the receiver. (Alpha-numeric characters on the front display are denoted by asterisks.) Refer to the following table and take appropriate action.

### ■ Errors during an update via USB

Error Code	Description
*-10, *-20	The USB device was not detected. Make sure the USB flash memory or USB cable is properly connected to the USB port. If the USB storage device has its own power supply, use it to power the USB device.
*-14	The firmware file was not found in the root folder of the USB device, or the firmware file is for another model. Retry and download the file on the support page of the web site, following the on-site instructions. If the error persists, please contact Onkyo Support and provide the error code.
Others	Retry the update procedure from the beginning. If the error persists, please contact Onkyo Support and provide the error code.

#### Case 3:

If an error occurs during the update, disconnect then reconnect the AC power cord and try again.

#### Case 4:

If an error occurs due to a wrong selection of input sources, turn off and on the receiver. Then retry the update.

### ONKYO SOUND & VISION CORPORATION

2-1, Nisshin-cho, Neyagawa-shi, OSAKA 572-8540, JAPAN

#### The Americas

ONKYO U.S.A. CORPORATION

18 Park Way, Upper Saddle River, N.J. 07458, U.S.A.

Tel: 800-229-1687, 201-785-2600

Fax: 201-785-2650

Hours: M-F 9am-8pm/Sat-Sun 10am-4pm ET

<<http://www.us.onkyo.com/>>

#### Europe

ONKYO EUROPE ELECTRONICS GmbH

Liegnitzerstrasse 6, 82194 Groebenzell, GERMANY

Tel: +49-8142-4401-0 Fax: +49-8142-4401-555

<<http://www.eu.onkyo.com/>>

#### China, Hong Kong

ONKYO CHINA LIMITED

Unit 1&12, 9/F, Ever Gain Plaza Tower 1, 88, Container Port Road,

Kwai Chung, N.T., Hong Kong

Tel: 852-2429-3118 Fax: 852-2428-9039

<<http://www.onkyochina.com/>>

#### Asia, Oceania, Middle East, Africa

Please contact an ONKYO distributor referring to Onkyo SUPPORT site.

<[http://www.intl.onkyo.com/support/local\\_support/index.html](http://www.intl.onkyo.com/support/local_support/index.html)>

# Troubleshooting

If you have any trouble using the receiver, look for a solution in this section.

If you can't resolve the issue yourself, try resetting the receiver before contacting your Onkyo dealer.

**To reset the receiver to its factory defaults, turn it on and, while holding down the [TUNING MODE] button, press the [ON/STANDBY] button.**

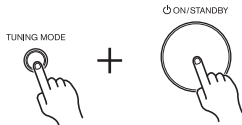

Note that resetting the receiver will delete your radio presets and custom settings.

## Power

### Can't turn on the receiver

- Make sure that the power cord is plugged into the electric outlet properly.
- Unplug the power cord from the electric outlet, wait 5 seconds or more, then plug it in again.

## Audio

### There's no sound or it's very quiet

- Make sure the speaker set A or B is on (→ page 19).
- Make sure that all audio connecting plugs are pushed in all the way (→ page 14-17).
- Make sure that the polarity of the speaker cables is correct, and that the bare wire is in contact with the metal part of each speaker terminal (→ page 10).
- Make sure that the speaker cables are not shorting.
- Make sure that the inputs and outputs of all components are connected properly.
- Make sure that the correct input source is selected (→ page 19).
- If the MUTING indicator is shown on the display, press the remote controller's [MUTING] button to unmute the receiver (→ page 19).
- If your turntable uses an MC cartridge, you must connect an MC head amp, or an MC transformer and a phono preamp.
- Make sure that the digital input source is selected properly (→ page 41).
- The receiver does not support multichannel audio input. The PCM signal can be input only to digital input terminals. Make sure that PCM is selected on the playback component (→ page 14, 41).
- While a pair of headphones is connected to the PHONES jack, no sound is output from the speakers. (→ page 19)

### Noise can be heard

- Using cable ties to bundle audio cables with power cords, speaker cables, and so on may degrade the

audio performance; do not bundle audio cables together with power cords or speaker cables.

- An audio cable may be picking up interference. Try repositioning your cables.

### The tone controls have no effect

- If the DIRECT is turned on, or PURE AUDIO button lights up, the tone controls have no effect. Press the [AUDIO] or [PURE AUDIO] button to turn the function off. The PURE AUDIO button's indicator will go off (→ page 20).

## Video

### There's no picture

- Make sure that all video connecting plugs are pushed in all the way. (→ page 14)
- Make sure that each video component is properly connected. (→ page 14, 16)
- If the video source is connected to a composite video input, your TV must be connected to the corresponding composite video output. (→ page 14)

## Tuner

### Reception is noisy, stereo FM reception suffers from hiss, or the FM STEREO indicator doesn't appear

- Relocate your antenna.
- Move the receiver away from your TV or computer.
- Listen to the station in mono (→ page 23).
- When listening to an AM station, operating the remote controller may cause noise.
- Passing cars and airplanes can cause interference.
- Concrete walls weaken radio signals.
- If nothing improves the reception, install an outdoor antenna.

## Remote Controller

### The remote controller doesn't work

- After inserting or replacing the batteries, press the remote controller's [MAIN] or [Zone 2] button before you start performing the desired operation (→ page 9).
- Make sure that the batteries are installed with the correct polarity (→ page 6).
- Install new batteries. Don't mix different types of batteries or old and new batteries (→ page 6).
- Make sure that the remote controller is not too far away from the receiver, and that there's no obstruction between the remote controller and the receiver's remote control sensor (→ page 6).
- Make sure that the receiver is not subjected to direct sunshine or inverter-type florescent lights. Relocate if necessary (→ page 6).

### Can't control other components

- Make sure that REMOTE MODE is set correctly (→ page 9).
- If you are unable to control another component, make sure that you selected an input source.
- If you have connected an **RI**-capable Onkyo DS- A1 Remote Interactive Dock to the TAPE IN or VCR/DVR IN jacks, you must set the input display to DOCK for the remote controller to work correctly (→ page 17).
- If it is an Onkyo component, make sure that the **RI** cable and analog audio cable are connected properly. Connecting only an **RI** cable won't work (→ page 17).
- With some components, certain buttons may not work as expected, and some may not work at all.
- To control an Onkyo component that's connected via **RI**, point the remote controller at the receiver.

### UP-A1 Dock for iPod/iPhone

#### There's no sound

- Make sure your iPod/iPhone is actually playing.
- Make sure your iPod/iPhone is inserted properly in the Dock.
- Make sure the UP-A1 Dock is connected to the UNIVERSAL PORT jack on the receiver.
- Make sure the receiver is turned on, the correct input source is selected, and the volume is turned up.
- Make sure the plugs are pushed in all the way.
- Try resetting your iPod/iPhone.

#### There's no video

- Make sure that your iPod/iPhone model's TV OUT setting is set to On.
- Make sure the correct input is selected on your TV or the receiver.
- Some versions of the iPod/iPhone do not output video.

#### The receiver's remote controller doesn't control your iPod/iPhone

- Make sure your iPod/iPhone is properly inserted in the Dock. If your iPod/iPhone is in a case, it may not connect properly to the Dock. Always remove your iPod/iPhone from the case before inserting it into the Dock.
- The iPod/iPhone cannot be operated while it's displaying the Apple logo.
- Make sure you've selected the right remote mode.
- When you use the receiver's remote controller, point it toward your receiver.
- If you've connected the UP-A1 Dock to the UP-DT1 radio tuner with the tuner's Mode Selector switch set to AUTO, you can switch the input source between the UP-A1 Dock and the tuner by pressing the [PORT] button repeatedly on the remote controller.
- If you still can't control your iPod/iPhone, start playback by pressing your iPod/iPhone model's Play button. Remote operation should then be possible.
- Try resetting your iPod/iPhone.

- Depending on your iPod/iPhone, some buttons may not work as expected.

### The receiver unexpectedly selects your iPod/iPhone as the input source

- Always pause iPod/iPhone playback before selecting a different input source. If playback is not paused, the Direct Change function may select your iPod/iPhone as the input source by mistake during the transition between tracks.

## Recording

### Can't record

- On your recorder, make sure the correct input is selected.
- To prevent signal loops and damage to the receiver, input signals are not fed through to outputs with the same name (e.g., TAPE IN to TAPE OUT, or VCR/DVR IN to VCR/DVR OUT).
- When the Pure Audio mode is selected, recording is not possible because no video signals are output. Disable the mode before recording.

## Zone 2

### There's no sound

- Only components connected to analog inputs can be played in Zone 2.

## Music Server and Internet Radio

### Can't access the server or Internet radio

- Check the network connection between the receiver and your router or switch.
- Make sure that your modem and router are properly connected, and make sure they are both turned on.
- Make sure the server is up and running and compatible with the receiver.
- Check the "Network Setup".

### Playback stops while listening to music files on the server

- Make sure your server is compatible with the receiver.
- If you download or copy large files on your computer, playback may be interrupted. Try closing any unused programs, use a more powerful computer, or use a dedicated server.
- If the server is serving large music files to several networked devices simultaneously, the network may become overloaded and playback may be interrupted. Reduce the number of playback devices on the network, upgrade your network, or use a switch instead of a hub.

### Can't connect to the receiver from a Web browser

- If you're using DHCP, your router may not always allocate the same IP address to the receiver, so if you find that you can't connect to a server or Internet radio station, recheck the receiver's IP address.
- Check the "Network Setup".

### USB Device Playback

#### Can't access the music files on a USB device

- Make sure the USB device is plugged in properly.
- The receiver supports USB devices that support the USB mass storage device class. However, playback may not be possible with some USB devices even if they conform to the USB mass storage device class.
- USB memory devices with security functions cannot be played.

### Others

#### Standby Power Consumption

- In the following cases, the power consumption may reach up to a maximum of 32 W:
  1. You are using the Universal Port jack.
  2. "Network Control" is set to "Enable" in the "Network Setup" setting.

#### The display doesn't work

- The display is turned off when the Pure Audio mode is selected.

#### The functions don't work

- To use **RI**, you must make an **RI** connection and an analog audio connection (RCA) between the component and receiver, even if they are connected digitally (→ page 16).
- While Zone 2 is selected, the **RI** functions don't work.

The receiver contains a microcomputer for signal processing and control functions. In very rare situations, severe interference, noise from an external source, or static electricity may cause it to lockup. In the unlikely event that this happens, unplug the power cord from the wall outlet, wait at least five seconds, and then plug it back in again.

Onkyo is not responsible for damages (such as CD rental fees) due to unsuccessful recordings caused by the unit's malfunction. Before you record important data, make sure that the material will be recorded correctly.

Before disconnecting the power cord from the wall outlet, set the receiver to Standby.

# Specifications

## Amplifier Section

Rated Output Power	<b>(North American)</b> 80 watts minimum continuous power per channel, 8 $\Omega$ loads, 2 channels driven from 20 Hz to 20 kHz with a maximum total harmonic distortion of 0.08 % (FTC) <b>100 watts minimum continuous power per channel, 6 <math>\Omega</math> loads, 2 channels driven at 1 kHz with a maximum total harmonic distortion of 0.1 % (FTC)</b> <b>(European)</b> 2 ch $\times$ 130 W at 6 $\Omega$ , 1 kHz, 1 ch driven of 1 % (IEC)
Dynamic Power	180 W (3 $\Omega$ , Front) 160 W (4 $\Omega$ , Front) 100 W (8 $\Omega$ , Front)
THD +N (Total Harmonic Distortion +Noise)	0.08 % (20 Hz–20 kHz, half power)
Damping Factor	60 (1 kHz, 8 $\Omega$ )
Input Sensitivity and Impedance	200 mV/ 47 k $\Omega$ (LINE) 2.5 mV/ 47 k $\Omega$ (PHONO MM)
Rated RCA Output Level and Impedance	200 mV/ 2.2 k $\Omega$ (REC OUT)
Maximum RCA Output Level and Impedance	2 V/ 2.2 k $\Omega$ (REC OUT)
Phono Overload	60 mV (MM, 1 kHz, 0.5 %)
Frequency Response	5 Hz–100 kHz/ +1 dB–3 dB
Tone Control Characteristics	$\pm$ 10 dB, 50 Hz (BASS) $\pm$ 10 dB, 20 kHz (TREBLE)
Signal to Noise Ratio	106 dB (LINE, IHF-A) 80 dB (PHONO MM, IHF-A)
Speaker Impedance	4 $\Omega$ –16 $\Omega$

## Video Section

Input Sensitivity/Output Level and Impedance 1 Vp-p /75  $\Omega$  (Composite)

## Tuner Section

### ■ FM

Tuning Frequency Range	<b>(North American)</b> 87.5 MHz– 107.9 MHz <b>(European)</b> 87.5 MHz– 108.0 MHz RDS
------------------------	--

### ■ AM

Tuning Frequency Range	<b>(North American)</b> 530 kHz–1710 kHz <b>(European)</b> 522/530 kHz–1611/1710 kHz
------------------------	---

Preset Channel 40

## General

Power Supply	<b>(North American)</b> AC 120 V, 60 Hz <b>(European)</b> AC 230 V, 50 Hz
Power Consumption	<b>(North American)</b> 3.1 A <b>(European)</b> 295 W
No-sound Power Consumption	<b>(North American)</b> 55 W <b>(European)</b> 45 W
Stand-by Power Consumption	<b>(North American)</b> 0.2 W <b>(European)</b> 0.3 W
Dimensions (W $\times$ H $\times$ D)	435 $\times$ 149.5 $\times$ 328 mm (17-1/8" $\times$ 5-7/8" $\times$ 12-15/16")
Weight	<b>(North American)</b> 8.6 kg (19 lbs.) <b>(European)</b> 8.8 kg (19.4 lbs)

### ■ Video Inputs

Composite BD/DVD, VCR/DVR, CBL/SAT, GAME

### ■ Video Outputs

Composite MONITOR OUT, VCR/DVR

### ■ Audio Inputs

Digital Inputs Optical: 2  
Coaxial: 2

Analog Inputs PHONO, CD, TV/TAPE, GAME, CBL/SAT, BD/DVD, VCR/DVR

### ■ Audio Outputs

Analog Outputs TV/TAPE, VCR/DVR

Pre Outputs L/R, SUBWOOFER, ZONE 2 L/R

Speaker Outputs SPEAKERS A  
SPEAKERS B

Phones 1 (6.3  $\phi$ )

### ■ Others

Ethernet	1
IR Input/Output	1/1
USB	Front 1
Universal Port	1
	1

Specifications and features are subject to change without notice.

# Memo

---

---

# ONKYO®

## ONKYO SOUND & VISION CORPORATION

2-1, Nisshin-cho, Neyagawa-shi, OSAKA 572-8540, JAPAN  
Tel: 072-831-8023 Fax: 072-831-8163  
<http://www.onkyo.com/>

## ONKYO U.S.A. CORPORATION

18 Park Way, Upper Saddle River, N.J. 07458, U.S.A.  
Tel: 800-229-1687, 201-785-2600 Fax: 201-785-2650  
<http://www.us.onkyo.com/>

## ONKYO EUROPE ELECTRONICS GmbH

Liegnitzerstrasse 6, 82194 Groebenzell, GERMANY  
Tel: +49-8142-4401-0 Fax: +49-8142-4401-555  
<http://www.eu.onkyo.com/>

## ONKYO EUROPE ELECTRONICS GmbH (UK BRANCH)

The Coach House 81A High Street, Marlow, Buckinghamshire, SL7 1AB, UK  
Tel: +44-(0)1628-473-350 Fax: +44-(0)1628-401-700

## ONKYO CHINA LIMITED

Unit 1 & 12, 9/F, Ever Gain Plaza Tower 1, 88, Container Port Road, Kwai Chung,  
N.T., Hong Kong. Tel: 852-2429-3118 Fax: 852-2428-9039  
<http://www.ch.onkyo.com/>

## ONKYO CHINA PRC

1301, 555 Tower, No.555 West NanJin Road, Jin an, Shanghai,  
China 200041, Tel: 86-21-52131366 Fax: 86-21-52130396

SN 29400685A

(C) Copyright 2011 ONKYO SOUND & VISION CORPORATION Japan. All rights reserved.

I1103-2



\* 2 9 4 0 0 6 8 5 A \*