

**ONKYO®**

**AV Receiver**

***TX-SR502***  
***TX-SR502E***  
***TX-SR8250***

**Instruction Manual**

Thank you for purchasing an Onkyo AV Receiver.  
Please read this manual thoroughly before making  
connections and plugging in the unit.  
Following the instructions in this manual will enable  
you to obtain optimum performance and listening  
enjoyment from your new AV Receiver.  
Please retain this manual for future reference.

**Contents**

**Introduction ..... 2**

**Connection ..... 16**

**Turning On & First Time Setup..... 31**

**Basic Operation**

Playing your AV components ..... 34  
Using the Tuner..... 36

**Enjoying the Listening Modes ..... 40**

**Advanced Operation ..... 45**

**Troubleshooting ..... 56**

**En**

**WARNING:**

TO REDUCE THE RISK OF FIRE OR ELECTRIC SHOCK, DO NOT EXPOSE THIS APPARATUS TO RAIN OR MOISTURE.

**CAUTION:**

TO REDUCE THE RISK OF ELECTRIC SHOCK, DO NOT REMOVE COVER (OR BACK). NO USER-SERVICEABLE PARTS INSIDE. REFER SERVICING TO QUALIFIED SERVICE PERSONNEL.



**WARNING**  
RISK OF ELECTRIC SHOCK  
DO NOT OPEN

**AVIS**  
RISQUE DE CHOC ELECTRIQUE  
NE PAS OUVRIR



The lightning flash with arrowhead symbol, within an equilateral triangle, is intended to alert the user to the presence of uninsulated "dangerous voltage" within the product's enclosure that may be of sufficient magnitude to constitute a risk of electric shock to persons.



The exclamation point within an equilateral triangle is intended to alert the user to the presence of important operating and maintenance (servicing) instructions in the literature accompanying the appliance.

## Important Safety Instructions

1. Read these instructions.
2. Keep these instructions.
3. Heed all warnings.
4. Follow all instructions.
5. Do not use this apparatus near water.
6. Clean only with dry cloth.
7. Do not block any ventilation openings. Install in accordance with the manufacturer's instructions.
8. Do not install near any heat sources such as radiators, heat registers, stoves, or other apparatus (including amplifiers) that produce heat.
9. Do not defeat the safety purpose of the polarized or grounding-type plug. A polarized plug has two blades with one wider than the other. A grounding type plug has two blades and a third grounding prong. The wide blade or the third prong are provided for your safety. If the provided plug does not fit into your outlet, consult an electrician for replacement of the obsolete outlet.
10. Protect the power cord from being walked on or pinched particularly at plugs, convenience receptacles, and the point where they exit from the apparatus.
11. Only use attachments/accessories specified by the manufacturer.
12. Use only with the cart, stand, tripod, bracket, or table specified by the manufacturer, or sold with the apparatus. When a cart is used, use caution when moving the cart/apparatus combination to avoid injury from tip-over.
 

PORTABLE CART WARNING



S3125A
13. Unplug this apparatus during lightning storms or when unused for long periods of time.
14. Refer all servicing to qualified service personnel. Servicing is required when the apparatus has been damaged in any way, such as power-supply cord or plug is damaged, liquid has been spilled or objects have fallen into the apparatus, the apparatus has been exposed to rain or moisture, does not operate normally, or has been dropped.
15. Damage Requiring Service
 

Unplug the apparatus from the wall outlet and refer servicing to qualified service personnel under the following conditions:

  - A. When the power-supply cord or plug is damaged,
  - B. If liquid has been spilled, or objects have fallen into the apparatus,
  - C. If the apparatus has been exposed to rain or water,
  - D. If the apparatus does not operate normally by following the operating instructions. Adjust only those controls that are covered by the operating instructions as an improper adjustment of other controls may result in damage and will often require extensive work by a qualified technician to restore the apparatus to its normal operation,
  - E. If the apparatus has been dropped or damaged in any way, and
  - F. When the apparatus exhibits a distinct change in performance this indicates a need for service.
16. Object and Liquid Entry
 

Never push objects of any kind into the apparatus through openings as they may touch dangerous voltage points or short-out parts that could result in a fire or electric shock.

The apparatus shall not be exposed to dripping or splashing and no objects filled with liquids, such as vases shall be placed on the apparatus.

Don't put candles or other burning objects on top of this unit.
17. Batteries
 

Always consider the environmental issues and follow local regulations when disposing of batteries.
18. If you install the apparatus in a built-in installation, such as a bookcase or rack, ensure that there is adequate ventilation.
 

Leave 20 cm (8") of free space at the top and sides and 10 cm (4") at the rear. The rear edge of the shelf or board above the apparatus shall be set 10 cm (4") away from the rear panel or wall, creating a flue-like gap for warm air to escape.

# Precautions

1. **Recording Copyright**—Unless it's for personal use only, recording copyrighted material is illegal without the permission of the copyright holder.
2. **AC Fuse**—The AC fuse inside the AV Receiver is not user-serviceable. If you cannot turn on the AV Receiver, contact your Onkyo dealer.
3. **Care**—Occasionally you should dust the AV Receiver all over with a soft cloth. For stubborn stains, use a soft cloth dampened with a weak solution of mild detergent and water. Dry the AV Receiver immediately afterwards with a clean cloth. Don't use abrasive cloths, thinners, alcohol, or other chemical solvents, because they may damage the finish or remove the panel lettering.

#### 4. Power

##### WARNING

BEFORE PLUGGING IN THE UNIT FOR THE FIRST TIME, READ THE FOLLOWING SECTION CAREFULLY.

AC outlet voltages vary from country to country. Make sure that the voltage in your area meets the voltage requirements printed on the AV Receiver's rear panel (e.g., AC 230 V, 50 Hz or AC 120 V, 60 Hz).

The Worldwide model has a voltage selector for compatibility with power systems around the world. Before you plug in this model, make sure that the voltage selector is set to the correct voltage for your area.

##### For American model

Setting the [STANDBY/ON] switch to STANDBY does not fully shutdown the AV Receiver. If you do not intend to use the AV Receiver for an extended period, remove the power cord from the AC outlet.

## Memory backup

The AV Receiver uses a battery-less memory backup system in order to retain radio presets and other settings when it's unplugged or in the case of a power failure. Although no batteries are required, the AV Receiver must be plugged into an AC outlet in order to charge the backup system.

(On non-American models, the AV Receiver's POWER switch must be set to ON in order to charge the backup system.) Once it has been charged, the AV Receiver will retain the settings for several weeks, although this depends on the environment and will be shorter in humid climates.

## For British models

Replacement and mounting of an AC plug on the power supply cord of this unit should be performed only by qualified service personnel.

##### IMPORTANT

The wires in the mains lead are coloured in accordance with the following code:

Blue: Neutral  
Brown: Live

As the colours of the wires in the mains lead of this apparatus may not correspond with the coloured markings identifying the terminals in your plug, proceed as follows:

The wire which is coloured blue must be connected to the terminal which is marked with the letter N or coloured black.

The wire which is coloured brown must be connected to the terminal which is marked with the letter L or coloured red.

##### IMPORTANT

A 5 ampere fuse is fitted in this plug. Should the fuse need to be replaced, please ensure that the replacement fuse has a rating of 5 amperes and that it is approved by ASTA or BSI to BS1362. Check for the ASTA mark or the BSI mark on the body of the fuse.

**IF THE FITTED MOULDED PLUG IS UNSUITABLE FOR THE SOCKET OUTLET IN YOUR HOME THEN THE FUSE SHOULD BE REMOVED AND THE PLUG CUT OFF AND DISPOSED OF SAFELY. THERE IS A DANGER OF SEVERE ELECTRICAL SHOCK IF THE CUT OFF PLUG IS INSERTED INTO ANY 13 AMPERE SOCKET.**

If in any doubt, consult a qualified electrician.

## For European Models

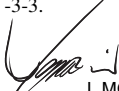
Declaration of Conformity	
We, ONKYO EUROPE ELECTRONICS GmbH LIEGNITZERSTRASSE 6, 82194 GROEBENZELL, GERMANY	
declare in own responsibility, that the ONKYO product described in this instruction manual is in compliance with the corresponding technical standards such as EN60065, EN55013, EN55020 and EN61000-3-2, -3-3.	
GROEBENZELL, GERMANY	 I. MORI
ONKYO EUROPE ELECTRONICS GmbH	

## Precautions—Continued

### For U.S. models

#### Note to CATV system installer:

This reminder is provided to call the CATV system installer's attention to Section 820-40 of the NEC which provides guidelines for proper grounding and, in particular, specifies that the cable ground shall be connected to the grounding system of the building, as close to the point of cable entry as practical.

#### FCC Information for User

##### CAUTION:

The user changes or modifications not expressly approved by the party responsible for compliance could void the user's authority to operate the equipment.

##### NOTE:

This equipment has been tested and found to comply with the limits for a Class B digital device, pursuant to Part 15 of the FCC Rules. These limits are designed to provide reasonable protection against harmful interference in a residential installation.

This equipment generates, uses and can radiate radio frequency energy and, if not installed and used in accordance with the instructions, may cause harmful interference to radio communications. However, there is no guarantee that interference will not occur in a particular installation. If this equipment does cause harmful interference to radio or television reception, which can be determined by turning the equipment off and on, the user is encouraged to try to correct the interference by one or more of the following measures:

- Reorient or relocate the receiving antenna.
- Increase the separation between the equipment and receiver.
- Connect the equipment into an outlet on a circuit different from that to which the receiver is connected.
- Consult the dealer or an experienced radio/TV technician for help.

### For Canadian Models

**NOTE:** THIS CLASS B DIGITAL APPARATUS COMPLIES WITH CANADIAN ICES-003.

For models having a power cord with a polarized plug:

**CAUTION:** TO PREVENT ELECTRIC SHOCK, MATCH WIDE BLADE OF PLUG TO WIDE SLOT, FULLY INSERT.

### Modèle canadien

**REMARQUE:** CET APPAREIL NUMÉRIQUE DE LA CLASSE B EST CONFORME À LA NORME NMB-003 DU CANADA.

Sur les modèles dont la fiche est polarisée:

**ATTENTION:** POUR ÉVITER LES CHOCS ÉLECTRIQUES, INTRODUIRE LA LAME LA PLUS LARGE DE LA FICHE DANS LA BORNE CORRESPONDANTE DE LA PRISE ET POUSSER JUSQU'AU FOND.

## Supplied Accessories

Make sure you have the following accessories:

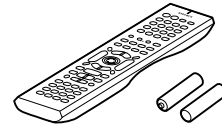

Remote controller & two batteries (AA/R6)

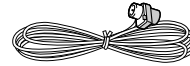

Indoor FM antenna

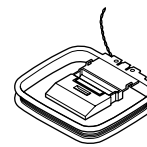

AM loop antenna

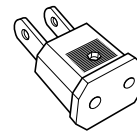

#### Power-plug adapter

Only supplied in certain countries. Use this adapter if your AC outlet does not match with the plug on the AV Receiver's power cord. (Adapter varies from country to country.)

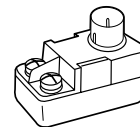

#### 75/300-ohm antenna adapter

(Not supplied with American and European models.)

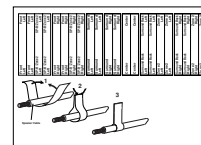

Speaker cable labels

- \* In catalogs and on packaging, the letter added to the end of the product name indicates the color of the AV Receiver. Specifications and operation are the same regardless of color.

## Features

### **Amp**

- 6-channel amplifier
- 75 watts per channel min. RMS at 8  $\Omega$ , 2 channels driven from 20 Hz to 20 kHz with no more than 0.08% total harmonic distortion
- WRAT (Wide Range Amplifier Technology)
- Optimum gain volume circuitry

### **Processing**

- Dolby<sup>1</sup> Digital EX and Dolby Pro Logic IIx
- DTS, DTS-ES Matrix/Discrete, DTS Neo:6, and DTS 96/24 processing<sup>2</sup>
- Cinema Filter function
- Linear PCM 96 kHz/24-bit D/A converters on all channels
- Pure Audio listening mode (not American model)

### **Audio/Video**

- Adjustable crossover (60, 80, 100, 120, 150 Hz)
- HDTV-capable component video (2 inputs, 1 output)
- 4 S-Video inputs, 2 outputs
- 4 assignable digital inputs (3 optical, 1 coaxial)
- Subwoofer pre out
- Color-coded multichannel input for use with Super Audio CD and DVD-Audio
- A/B speaker drive
- Color-coded speaker terminal posts

### **FM/AM Tuner**

- 30 FM/AM presets
- FM/AM auto tuning
- RDS (Radio Data System) (Europe only)

### **Remote Controller**

- Preprogrammed for use with other AV components

## Table of Contents

### Introduction

<b>Important Safety Instructions.....</b>	<b>2</b>
<b>Precautions .....</b>	<b>3</b>
<b>Supplied Accessories .....</b>	<b>4</b>
<b>Features.....</b>	<b>5</b>
<b>Front &amp; Rear Panels .....</b>	<b>6</b>
<b>Before Using the AV Receiver.....</b>	<b>9</b>
<b>Remote Controller .....</b>	<b>10</b>

### Connection

<b>Connecting Your Speakers.....</b>	<b>16</b>
<b>Connecting Antenna .....</b>	<b>18</b>
<b>Connecting the AV Receiver .....</b>	<b>20</b>

### Turning on & First Time Setup

<b>Turning On .....</b>	<b>31</b>
<b>First Time Setup .....</b>	<b>31</b>

### Basic Operation

<b>Playing Your AV Components.....</b>	<b>34</b>
<b>Using the Tuner .....</b>	<b>36</b>
<b>Common Functions.....</b>	<b>38</b>

### Enjoying the listening Modes

<b>Using the Listening Modes.....</b>	<b>40</b>
---------------------------------------	-----------

### Advanced Operation

<b>Recording.....</b>	<b>45</b>
<b>Advanced Function .....</b>	<b>46</b>
<b>Advanced Setup .....</b>	<b>48</b>
<b>Controlling Other Components.....</b>	<b>50</b>

### Troubleshooting .....

<b>56</b>
-----------

1. Manufactured under license from Dolby Laboratories. "Dolby", "Pro Logic" and the double-D symbol are trademarks of Dolby Laboratories.
2. "DTS," "DTS 96/24," "DTS-ES," and "Neo:6" are trademarks of Digital Theater Systems, Inc.

# Front & Rear Panels

## Front Panel

### American Model

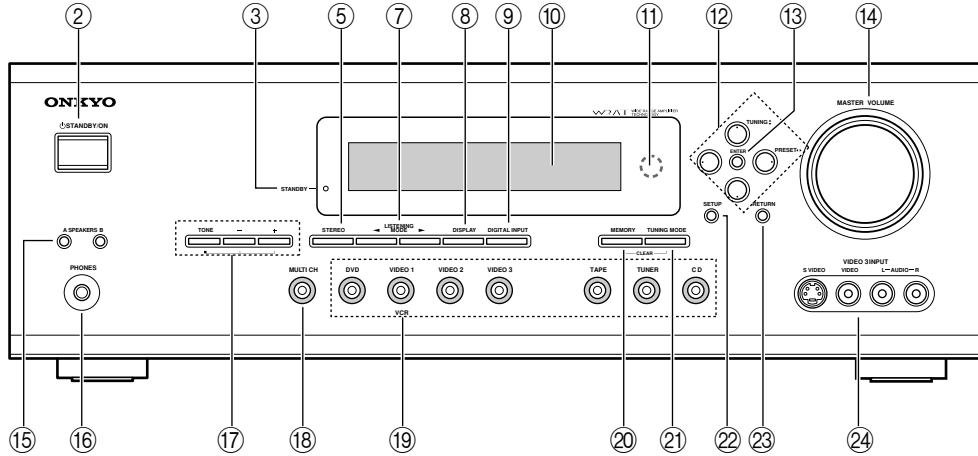

### Other Models

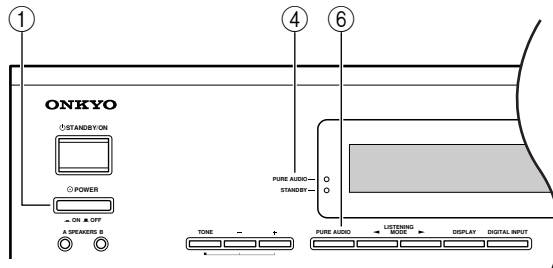

For detailed information, refer to the pages in parenthesis.

#### ① POWER switch (31)

The American model doesn't have this switch. This is the main power switch. When set to OFF, the AV Receiver is completely shutdown. When set to ON, the AV Receiver is in Standby mode and the STANDBY indicator lights up. Don't turn on the power until you've completed, and double-checked all connections (pages 17–30).

#### ② STANDBY/ON button (31)

This button is used to set the AV Receiver to On or Standby. For models with a POWER switch, this button has no effect unless the POWER switch is set to ON.

#### ③ STANDBY indicator (31)

This indicator lights up when the AV Receiver is in Standby mode, and it flashes while a signal is being received from the remote controller.

#### ④ PURE AUDIO indicator (41)

The American model doesn't have this indicator. This indicator lights up when the Pure Audio listening mode is selected. (No video signals are output in this mode.)

#### ⑤ STEREO button (41)

This button is used to select the Stereo listening mode. (American model only)

#### ⑥ PURE AUDIO button (41)

The American model doesn't have this button. This button is used to select the Pure Audio listening mode.

#### ⑦ LISTENING MODE [◀] [▶] buttons (41)

These buttons are used to select the listening modes.

#### ⑧ DISPLAY button (35)

This button is used to display various information about the currently selected source.

#### ⑨ DIGITAL INPUT button (31, 47)

This button is used to assign the digital inputs and to specify the format of digital input signals.

#### ⑩ Display

## Front & Rear Panels—Continued

- ⑪ **Remote control sensor (9)**  
This sensor receives control signals from the remote controller.
- ⑫ **Arrow buttons**  
These buttons are used to select and adjust settings.  
**TUNING [▲] [▼] buttons**  
These buttons are used to tune into radio stations.  
**PRESET [◀] [▶] buttons**  
These buttons are used to select radio presets.
- ⑬ **ENTER button**  
This button is used to confirm settings.
- ⑭ **MASTER VOLUME control (34)**  
This control is used to set the volume of the AV Receiver.
- ⑮ **SPEAKER A & B buttons (34)**  
These buttons are used to turn speaker sets A and B on and off.
- ⑯ **PHONES jack (39)**  
This 1/4-inch phone jack is for connecting a standard pair of stereo headphones for private listening.
- ⑰ **TONE, [-] & [+] buttons (38)**  
These buttons are used to adjust the bass and treble.
- ⑱ **MULTI CH button (35)**  
This button is used to select the multichannel DVD input.
- ⑲ **Input selector buttons (31, 34, 45)**  
These buttons are used to select the input sources.
- ⑳ **MEMORY button (36, 37)**  
This button is used to preset radio stations.
- ㉑ **TUNING MODE button (37)**  
This button is used to select the Auto or Manual Tuning mode.
- ㉒ **SETUP button**  
This button is used to access various settings.
- ㉓ **RETURN button**  
This button is used to return to the previous screen when changing settings.
- ㉔ **VIDEO 3 INPUT (27)**  
These S-Video, composite video, and analog audio inputs can be used to connect a camcorder or games console.

## Display

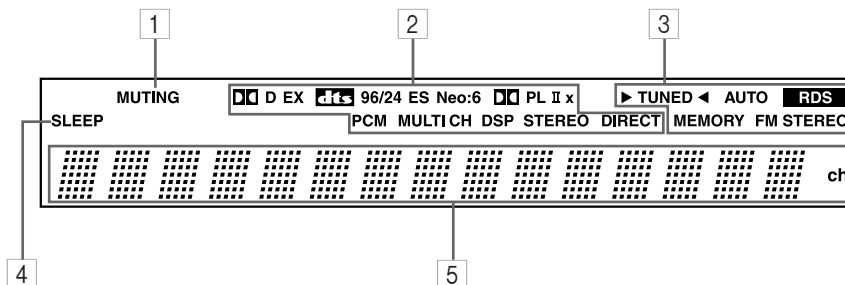

For detailed information, refer to the pages in parenthesis.

- ① **MUTING indicator (39)**  
This indicator flashes when the AV Receiver is muted.
- ② **Source/listening mode indicators (42)**  
These indicators show the currently selected listening mode and digital audio format.
- ③ **Tuning indicators (36)**  
**TUNED (36):** This indicator lights up when the AV Receiver is tuned into a radio station.  
**AUTO (36):** This indicator lights up when Auto Tuning is selected, and disappears when Manual Tuning is selected.  
**RDS (European model only) (36):** This indicator lights up when the AV Receiver is tuned to a radio station that supports RDS (Radio Data System).
- ④ **SLEEP indicator (39)**  
This indicator lights up when the Sleep function has been set.
- ⑤ **Message area**  
This area of the display shows various information about the currently selected source.
- MEMORY (36):** This indicator lights up when pre-setting radio stations.
- FM STEREO (36):** This indicator lights up when the AV Receiver is tuned to a stereo FM station.

## Front & Rear Panels—Continued

### Rear Panel

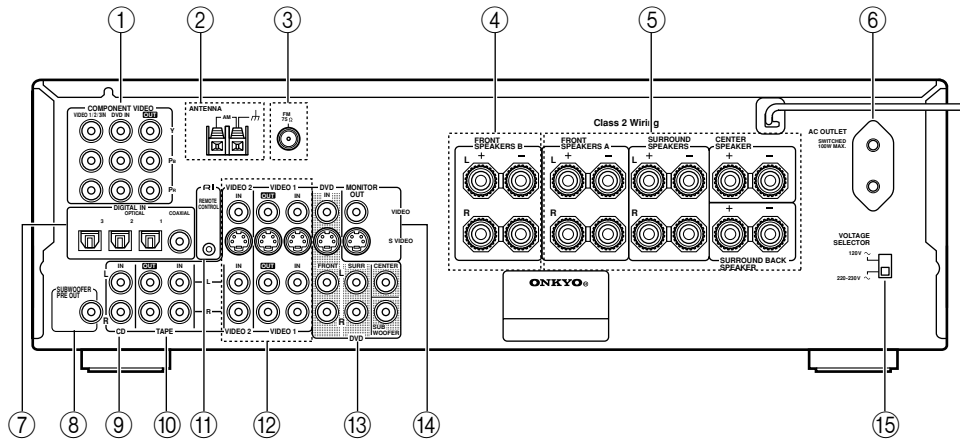

For detailed information, refer to the pages in parenthesis.

① **COMPONENT VIDEO (20–23, 25, 26)**

A DVD player, TV, or other component that supports component video can be connected here.

② **AM ANTENNA (18, 19)**

These push terminals are for connecting an AM antenna.

③ **FM ANTENNA (18, 19)**

This socket is for connecting an FM antenna.

④ **FRONT SPEAKERS B (17)**

These terminal posts are for connecting speaker set B.

⑤ **FRONT SPEAKERS A, SURROUND SPEAKERS, CENTER SPEAKER & SURROUND BACK SPEAKER (17)**

These terminal posts are for connecting speaker set A.

⑥ **AC OUTLET (30)**

This switched AC outlet can be used to supply power to another component. The connector type depends on the country in which you purchased your AV Receiver.

⑦ **DIGITAL IN OPTICAL 1, 2, 3 & COAXIAL (20–23, 25, 26, 28, 29)**

These optical and coaxial sockets can be used to connect a CD, DVD, or LD (laser disc) player and other components with digital audio outputs.

⑧ **SUBWOOFER PRE OUT (17)**

A powered subwoofer can be connected here.

⑨ **CD IN (28)**

These analog inputs can be used to connect a CD player with analog outputs.

⑩ **TAPE IN/OUT (28, 29, 33)**

These analog inputs and outputs can be used to connect a cassette recorder, Mini Disc recorder, or other recorder with analog inputs and outputs.

⑪ **RI (30)**

This **RI** (Remote Interactive) socket can be connected to the **RI** socket on another Onkyo component. The AV Receiver's remote controller can then be used to control that component. To use **RI**, you must make an analog audio connection (RCA) between the AV Receiver and the other component, even if they are connected digitally.

**Note:**

**RI** can only be used with Onkyo components.

⑫ **VIDEO 1 IN/OUT & VIDEO 2 IN (24, 25, 45)**

The VIDEO 1 S-Video, composite video, and audio inputs and outputs can be used to connect a VCR. The VIDEO 2 S-Video, composite video, and audio inputs can be used to connect another video source (e.g., cable TV, satellite TV, or a set-top box).

⑬ **DVD IN/MULTI CH INPUT (23, 24)**

The FRONT, SURR, CENTER, and SUBWOOFER inputs can be used to connect components with multiple analog audio outputs, including DVD players with individual 5.1-channel analog outputs. The S-Video or composite video input should be connected to a video output on the DVD player.

⑭ **MONITOR OUT (21, 22)**

The S-Video or composite video output should be connected to a video input on your TV or projector.

⑮ **VOLTAGE SELECTOR (Worldwide model only) (9)**

This voltage selector provides compatibility with power systems around the world.



# Before Using the AV Receiver

## Setting the Voltage Selector (Worldwide model only)

The Worldwide model has a voltage selector for compatibility with power systems around the world. Before you plug in this model, make sure that the voltage selector is set to the correct voltage for your area. If it isn't, use a small screwdriver to set it as appropriate. For example, if the voltage in your area is 120 volts, set the selector to "120V." If it's between 220 and 230 volts, set it to "220-230V."

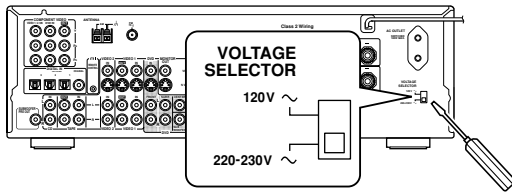

## Installing the Batteries

- 1 To open the battery compartment, press the small hollow and slide off the cover.

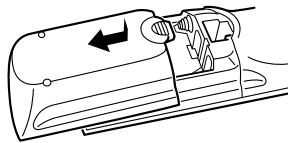

- 2 Insert the two supplied batteries (AA/R6) in accordance with the polarity diagram inside the battery compartment.

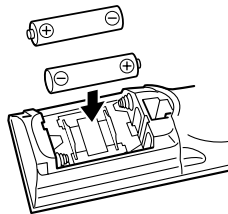

- 3 Put the cover onto the remote controller and slide it shut.

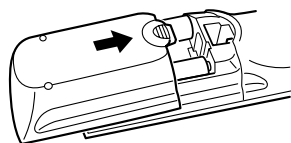

### Notes:

- The batteries should last for about six months, although this will vary with usage.
- If the remote controller doesn't work reliably, try replacing the batteries.
- Don't mix new and old batteries or different types of batteries.
- If you intend not to use the remote controller for a long time, remove the batteries to prevent damage from leakage or corrosion.
- Expired batteries should be removed as soon as possible to prevent damage from leakage or corrosion.

## Using the Remote Controller

To use the remote controller, point it at the AV Receiver's remote control sensor, as shown below.

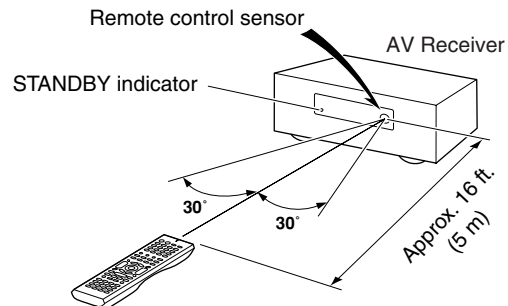

### Notes:

- The remote controller may not work reliably if the AV Receiver is subjected to bright light, such as direct sunlight or inverter-type fluorescent lights. Keep this in mind when installing.
- If another remote controller of the same type is used in the same room, or the AV Receiver is installed close to equipment that uses infrared rays, the remote controller may not work reliably.
- Don't put anything, such as a book, on the remote controller, because the buttons may be pressed inadvertently, thereby draining the batteries.
- The remote controller may not work reliably if the AV Receiver is installed in a rack behind colored glass doors. Keep this in mind when installing.
- The remote controller will not work if there's an obstacle between it and the AV Receiver's remote control sensor.

# Remote Controller

## How to Use the Remote Controller

Including the AV Receiver, the remote controller can be used to control up to 10 different components, including Onkyo components connected via **RI**. The remote controller has a specific operating mode for use with each type of component. Modes are selected by using the nine REMOTE MODE buttons.

### ■ AMP/TUNER & TAPE Mode



In AMP/TUNER & TAPE mode you can control the AV Receiver and an Onkyo cassette recorder connected via **RI**.

### ■ DVD, CD, MD & CDR Modes

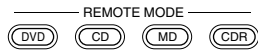

With these modes you can control an Onkyo DVD player, CD player, MiniDisc recorder, or CD recorder connected via **RI** (the remote controller should be pointed at the AV Receiver). By entering the appropriate remote control code, the DVD mode can also be used to control another manufacturer's DVD player and the [CD], [MD], and [CDR] mode buttons can also be used with other manufacturer's components (e.g., DVD, TV, VCR, satellite or cable receiver). (See page 50.)

### ■ TV, VCR, CABLE & SAT Modes



With these modes you can control a TV, VCR, cable receiver, and satellite receiver. You must enter the appropriate remote control code first (see page 50).

- 1 Use the REMOTE MODE—[AMP], [DVD], [CD], [MD], [CDR], [TV], [VCR], [CABLE], [SAT]— buttons to select the modes.**
- 2 Uses the buttons supported by that mode to control the component.**
  - AMP/TUNER mode see page 10
  - DVD mode see page 12
  - CD mode see page 13
  - MD/ CDR mode see page 14
  - TAPE mode see page 15
  - TV mode see page 55
  - see page 15 for TV control buttons
  - VCR/CABLE / SAT mode see page 55

**Note:**

- Some of the functions described in this manual may not work as expected with other components.

## AMP/TUNER Mode

AMP/TUNER mode is used to control the AV Receiver. To select AMP/TUNER mode, press the [AMP] mode button.

### American model

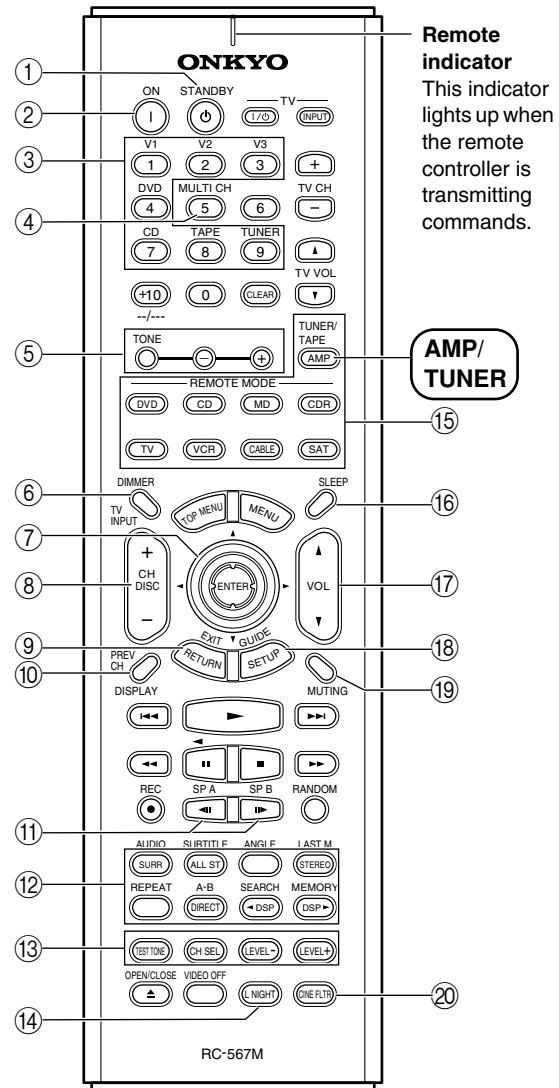

### Other models

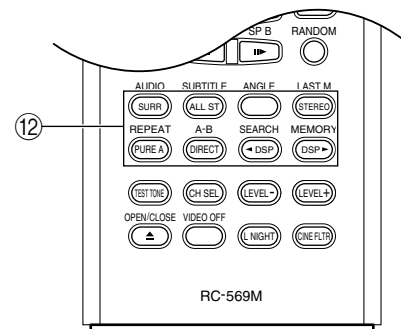

## Remote Controller—Continued

For detailed information, refer to the pages in parenthesis.

- ① **STANDBY button (31)**  
This button is used to set the AV Receiver to Standby.
- ② **ON button (31)**  
This button is used to turn on the AV Receiver.
- ③ **Input selector buttons (34)**  
These buttons are used to select the input sources.
- ④ **MULTI CH button (35)**  
This button is used to select the multichannel DVD input.
- ⑤ **TONE, [-] & [+] buttons (38)**  
These buttons are used to adjust the bass and treble.
- ⑥ **DIMMER button (38)**  
This button is used to adjust the display brightness.
- ⑦ **Arrow [▲]/[▼]/[◀]/[▶] & ENTER button**  
This button is used to select and adjust settings.
- ⑧ **CH +/- button (37)**  
This button is used to select radio presets.
- ⑨ **RETURN button**  
This button is used to return to the previous screen when changing settings.
- ⑩ **DISPLAY button (35, 37)**  
This button is used to display various information about the currently selected input source.
- ⑪ **SP A & SP B buttons (34)**  
These buttons are used to turn on and off speaker sets A and B.
- ⑫ **Listening mode buttons (42)**  
  - SURR button**  
This button is used to select the Dolby and DTS listening modes.
  - ALL ST button**  
This button is used to select the All Ch Stereo listening mode.
  - STEREO button**  
This button is used to select the Stereo listening mode.
  - PURE A button (not American model)**  
This button is used to select the Pure Audio listening mode. In this mode, the display and internal video circuitry are turned off, minimizing the possibility of interference, for a high fidelity sound that's true to the original. (No video signals are output in this mode.)
  - DIRECT button**  
This button is used to select the Direct listening mode.
  - [◀ DSP] & [DSP ▶] buttons**  
These buttons are used to select the Onkyo original DSP (digital signal processor) listening modes.
- ⑬ **TEST TONE, CH SEL, LEVEL- & LEVEL+ buttons**  
These buttons are used to adjust the level of each speaker individually.
- ⑭ **L NIGHT button**  
This button is used to set the Late Night function.
- ⑮ **REMOTE MODE buttons (10)**  
These buttons are used to select the remote controller modes. When you use the remote controller, the mode button for the currently selected mode lights up.
- ⑯ **SLEEP button (39)**  
This button is used to set the Sleep function.
- ⑰ **VOL button (34)**  
This button is used to set the volume of the AV Receiver.
- ⑱ **SETUP button (32, 48)**  
This button is used to access various settings.
- ⑲ **MUTING button (39)**  
This button is used to mute the AV Receiver.
- ⑳ **CINE FLTR button (46)**  
This button is used to set the CinemaFILTER function.

## Remote Controller—Continued

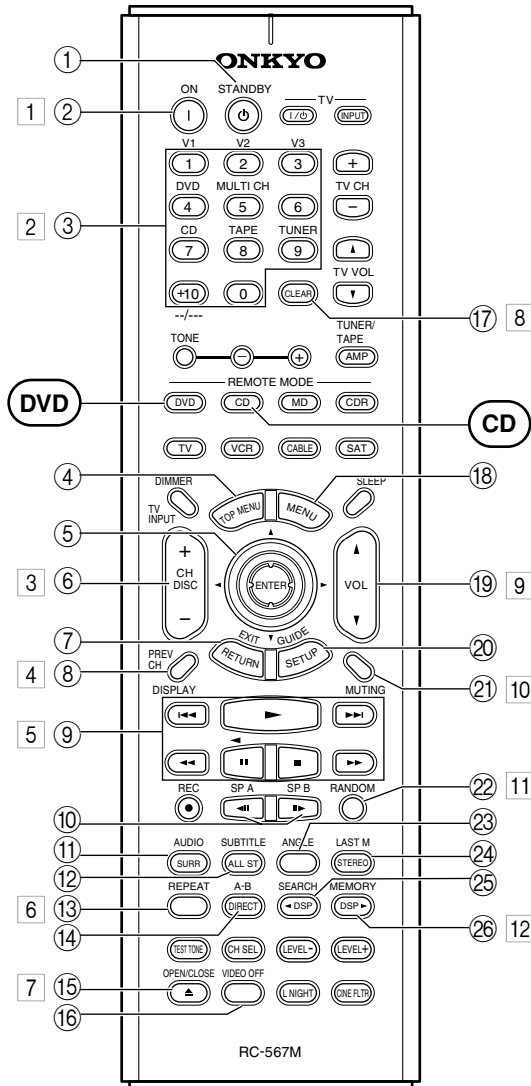

### DVD Mode

DVD mode is used to control an Onkyo DVD player connected to the AV Receiver via **RI**.

To set the remote controller to DVD mode, press the [DVD] mode button.

**Before selecting DVD mode and starting playback, you should press the [AMP] mode button followed by the [DVD] input selector button to select your DVD player as the input source.**

- ① **STANDBY button**  
This button is used to set the DVD player to Standby.
- ② **ON button**  
This button is used to turn on the DVD player and set it to Standby.
- ③ **Number buttons**  
These buttons are used to enter title, chapter, and track numbers and to enter times for locating specific points in time.
- ④ **TOP MENU button**  
This button is used to select a DVD's top menu.
- ⑤ **Arrow [▲]/[▼]/[◀]/[▶] & ENTER button**  
This button is used to navigate DVD menus and the DVD player's onscreen setup menus.
- ⑥ **DISC +/- button**  
This button selects discs on a DVD changer.
- ⑦ **RETURN/EXIT button**  
This button is used to exit the DVD player's onscreen setup menu and to restart menu playback.
- ⑧ **DISPLAY button**  
This button is used to display information about the current disc, title, chapter, or track on the DVD player's display, including the elapsed time, remaining time, total time, and so on.
- ⑨ **Playback buttons**  
From left to right: Previous, Play, Next, Fast Reverse, Pause, Stop, and Fast Forward.
- ⑩ **Step & Slow [◀|||]/[|||▶] buttons**  
These buttons are used for frame-by-frame playback and slow-motion playback.
- ⑪ **AUDIO button**  
This button is used to select foreign language soundtracks and audio formats (e.g., Dolby Digital or DTS).
- ⑫ **SUBTITLE button**  
This button is used to select subtitles.
- ⑬ **REPEAT button**  
This button is used to set the repeat playback functions.

## Remote Controller—Continued

- ⑭ **A-B button**  
This button is used to set the A–B repeat playback function.
- ⑮ **OPEN/CLOSE [▲] button**  
This button is used to open and close the disc tray.
- ⑯ **VIDEO OFF button**  
This button is used to turn off the internal video circuitry, eliminating the possibility of interference when playing audio-only discs.
- ⑰ **CLEAR button**  
This button is used to cancel functions and to clear entered numbers.
- ⑱ **MENU button**  
This button is used to display a DVD's menu.
- ⑲ **VOL button**  
This button is used to set the volume of the AV Receiver.
- ⑳ **SETUP/GUIDE button**  
This button is used to access the DVD player's onscreen setup menus.
- ㉑ **MUTING button**  
This button is used to mute the AV Receiver.
- ㉒ **RANDOM button**  
This button is used with the random playback function.
- ㉓ **ANGLE button**  
This button is used to select different camera angles.
- ㉔ **LAST M button**  
This button is used with the last memory function, which allows you to resume DVD playback from where you left off.
- ㉕ **SEARCH button**  
This button is used to search for titles, chapters, tracks, and specific points in time.
- ㉖ **MEMORY button**  
This button is used with the memory playback function, which allows you to create a custom playlist of titles, chapters, or tracks.

### CD Mode

CD mode is used to control an Onkyo CD player connected to the AV Receiver via **RI**.

**To set the remote controller to CD mode, press the [CD] mode button.**

**Before selecting CD mode and starting playback, you should press the [AMP] mode button followed by the [CD] input selector button to select your CD player as the input source.**

- 1 **ON button**  
This button is used to set the CD player to On or Standby.
- 2 **Number buttons**  
These buttons are used to enter track numbers and to enter times for locating specific points in time.
- 3 **DISC button**  
This button is used to select discs on a CD changer.
- 4 **DISPLAY button**  
This button is used to display information about the current disc or track on the CD player's display, including the elapsed time, remaining time, total time, and so on.
- 5 **Playback buttons**  
From left to right: Previous, Play, Next, Fast Reverse, Pause, Stop, and Fast Forward.
- 6 **REPEAT button**  
This button is used to set the repeat playback functions.
- 7 **OPEN/CLOSE [▲] button**  
This button is used to open and close the disc tray.
- 8 **CLEAR button**  
This button is used to cancel functions and to clear entered numbers.
- 9 **VOL button**  
This button is used to set the volume of the AV Receiver.
- 10 **MUTING button**  
This button is used to mute the AV Receiver.
- 11 **RANDOM button**  
This button is used with the random playback function.
- 12 **MEMORY button**  
This button is used with the memory playback function, which allows you to create a custom playlist of tracks.

## Remote Controller—Continued

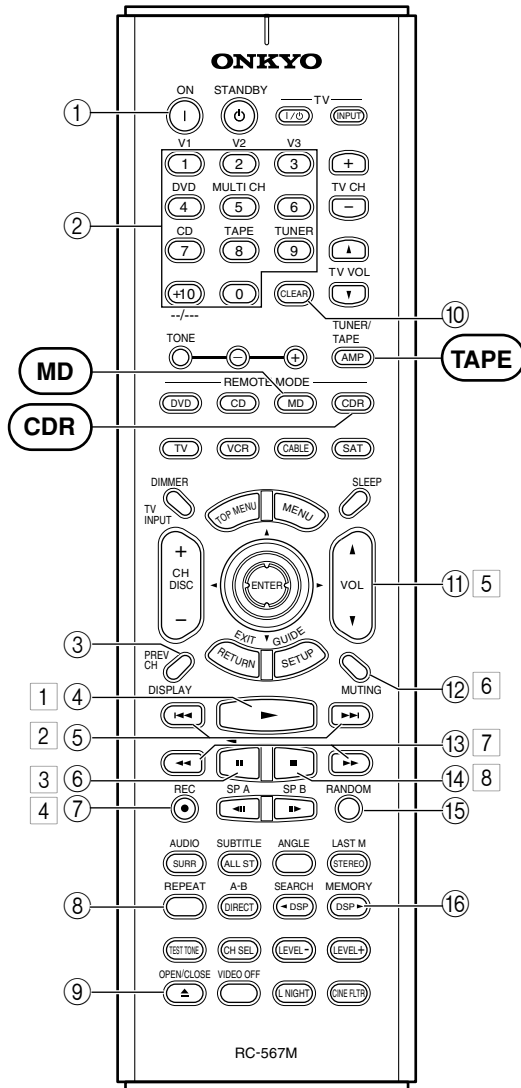

### MD Mode & CDR Mode

MD mode is used to control an Onkyo MiniDisc recorder connected to the AV Receiver via **RI**. CDR mode is used to control an Onkyo CD recorder connected to the AV Receiver via **RI**.

To select MD mode, press the [MD] mode button. To select CDR mode, press the [CDR] mode button.

**Before selecting MD or CDR mode and starting playback, you should press the [AMP] mode button followed by the [TAPE] input selector button to select your MiniDisc or CD recorder as the input source.**

- ① **ON button**  
This button is used to set the MiniDisc recorder or CD recorder to On or Standby.
- ② **Number buttons**  
These buttons are used to enter track numbers and to enter times for locating specific points in time.
- ③ **DISPLAY button**  
This button is used to display information about the current disc or track on the MD/CD recorder's display, including the elapsed time, remaining time, total time, and so on.
- ④ **Play [▶] button**  
This button is used to start playback.
- ⑤ **Previous & Next [◀◀]/[▶▶] buttons**  
The Previous [◀◀] button is used to select the previous track. During playback it selects the beginning of the current track. The Next [▶▶] button is used to select the next track.
- ⑥ **Pause [⏸] button**  
This button is used to pause playback.
- ⑦ **REC [●] button**  
This button is used to start recording.
- ⑧ **REPEAT button**  
This button is used to set the repeat playback functions.
- ⑨ **OPEN/CLOSE [▲] button**  
This button is used to eject the MiniDisc or open and close the disc tray of the CD recorder.
- ⑩ **CLEAR button**  
This button is used to cancel functions and to clear entered numbers.
- ⑪ **VOL button**  
This button is used to set the volume of the AV Receiver.
- ⑫ **MUTING button**  
This button is used to mute the AV Receiver.

## Remote Controller—Continued

### 13 FR & FF [◀◀]/[▶▶] buttons

The FR [◀◀] button is used to start fast reverse. The FF [▶▶] button is used to start fast forward.

### 14 Stop [■] button

This button is used to stop playback.

### 15 RANDOM button

This button is used with the random playback function.

### 16 MEMORY button

This button is used with the memory playback function, which allows you to create a custom playlist of tracks.

## Tape Mode

Tape mode is used to control an Onkyo cassette recorder connected to the AV Receiver via **RI**.

To set the remote controller to Tape mode, press the [AMP] mode button.

**Before selecting TAPE mode and starting playback, you should press the [AMP] mode button followed by the [TAPE] input selector button to select your cassette recorder as the input source.**

For double cassette decks, only Deck B can be controlled.

### 1 Play [▶] button

This button is used to start playback.

### 2 Previous & Next [◀◀]/[▶▶] buttons

The Previous [◀◀] button is used to select the previous track. During playback it selects the beginning of the current track. The Next [▶▶] button is used to select the next track.

The Previous and Next [◀◀]/[▶▶] buttons may not work properly with some cassette tapes depending on how they were recorded.

### 3 Reverse Play [◀] button

This button is used to start reverse playback.

### 4 REC [●] button

This button is used to start recording.

### 5 VOL button

This button is used to set the volume of the AV Receiver.

### 6 MUTING button

This button is used to mute the AV Receiver.

### 7 Rewind & FF [◀◀]/[▶▶] buttons

The Rewind [◀◀] button is used to start rewind. The FF [▶▶] button is used to start fast forward.

### 8 Stop [■] button

This button is used to stop playback.

## TV Control Buttons

The remote controller has dedicated buttons for controlling a TV, which can be used regardless of which remote controller mode is currently selected. To use these buttons, you must first program the [TV] mode button with the appropriate remote control code for your TV (see page 50).

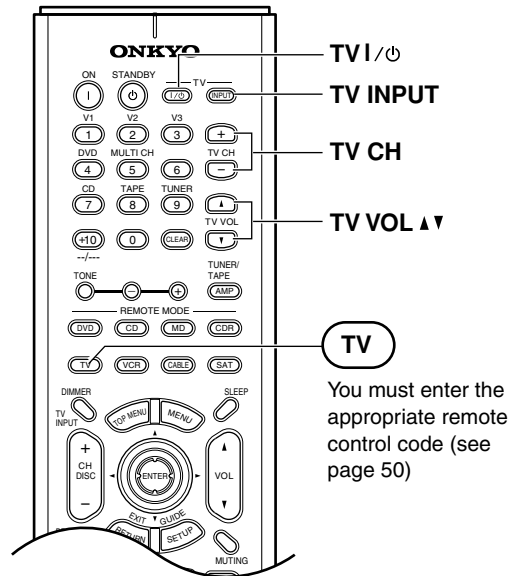

TV [⏻/ ]	Set the TV to On or Standby
TV CH [+]/[-]	Selects channels on the TV
[TV INPUT]	Selects the TV's VCR input
TV VOL [▲]/[▼]	Adjusts the TV's volume

# Connecting Your Speakers

## Enjoying Home Theater

You can use two sets of speakers with the AV Receiver: speaker set A and speaker set B.

**Speaker set A** should be installed in your main listening room and can be used with Dolby Digital and DTS surround material. Each speaker must be positioned at a specific location in your listening room to get the best from surround sound material. The following illustration shows the best positions for your surround-sound speakers.

**Speaker set B** can be installed in another room and used with stereo and mono material. Speakers can be positioned in the standard position for stereo speakers or however you like.

### Front left and right speakers

These output the overall sound. Their role in a home theater is to provide a solid anchor for the sound image. They should be positioned facing the listener at about ear level, and equidistant from the TV. Angle them inward so as to create a triangle, with the listener at the apex.

### Center speaker

This speaker enhances the front left and right speakers, making sound movements distinct and providing a full sound image. In movies it's used mainly for dialog. Position it close to your TV (preferably on top) facing forward at about ear level, or at the same height as the front left and right speakers.

### Subwoofer

The subwoofer handles the bass sounds of the LFE (Low-Frequency Effects) channel. The volume and quality of the bass output from your subwoofer will depend on its position, the shape of your listening room, and your listening position. In general, a good bass sound can be obtained by installing the subwoofer in a front corner, or at one-third the width of the wall, as shown.

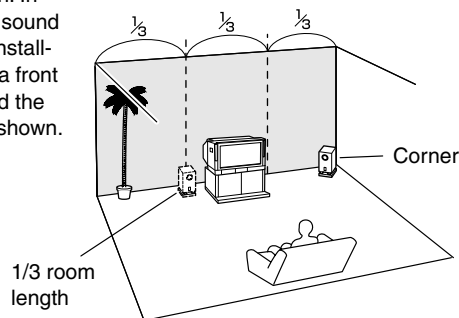

### Surround back speaker

This speaker further enhances the realism of surround sound and improves sound localization behind the listener. Position it behind the listener about 2–3 feet (60–100 cm) above ear level. Make sure that the listening position is within the range of the speaker.

### Surround left and right speakers

These speakers are used for precise sound positioning and to add realistic ambience. Position them at the sides of the listener, or slightly behind, about 2–3 feet (60–100 cm) above ear level. Ideally they should be equidistant from the listener.

## Speaker Configuration

For the best surround-sound experience, you should connect six speakers and a powered subwoofer.

No matter how many speakers you use, a powered subwoofer is recommended for a powerful and solid bass sound.

Before using the AV Receiver, you must specify which speakers are connected and their sizes (see page 32).

To get the very best from your surround-sound system, you should also specify the distance between the listener and each individual speaker so that the sound from each speaker arrives at the listener's ears at the same time (see page 48).

In addition, you should set the level of each individual speaker to achieve an equal balance (see page 49.)



## Connecting Your Speakers—Continued

### Connecting Your Speakers

Before you connect your speakers, read the following:

- Disconnect the power cord from the wall outlet.
- Read the instructions supplied with your speakers.
- Pay close attention to speaker wiring polarity. In other words, connect positive (+) terminals only to positive (+) terminals, and negative (–) terminals only to negative (–) terminals. If you get them the wrong way around, the sound will be out of phase and will sound odd.
- Only use speakers with an impedance of 6 ohms or higher. If you use speakers with a lower impedance, and use the amplifier at high volume levels for a long period of time, the built-in protection circuit may be activated.
- Unnecessarily long or very thin speaker cables may affect the sound quality and should be avoided.
- Be careful not to short the positive and negative connections. Doing so may damage the AV Receiver.
- Don't connect more than one cable to each speaker terminal. Doing so may damage the AV Receiver.
- If you want to connect a single speaker instead of a pair, connect it to either the left or right speaker terminals, not both.

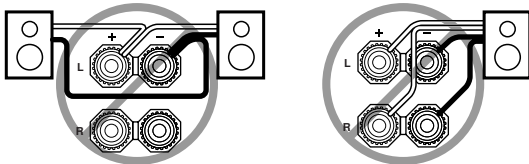
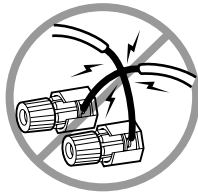

### Attaching the Speaker Labels

The AV Receiver's positive (+) speaker terminals are color-coded for ease of identification. (The negative (–) speaker terminals are all black.)

Speaker terminal	Color
Front left	White
Front right	Red
Center	Green
Surround left	Blue
Surround right	Gray
Surround back	Brown

The supplied speaker labels are also color-coded and you should attach them to the positive (+) side of each speaker cable in accordance with the above table. All you need to do then is to match the color of each label to the corresponding speaker terminal.



### Connecting the Speaker Cables

- 1 Strip 5/8" (15 mm) of insulation from the ends of the speaker cables, and twist the bare wires tightly, as shown.

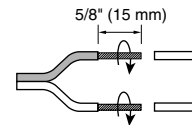

- 2 Unscrew the terminal. Fully insert the bare wires. Screw the terminal tight.

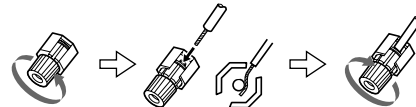

The following illustration shows which speakers should be connected to which terminals.

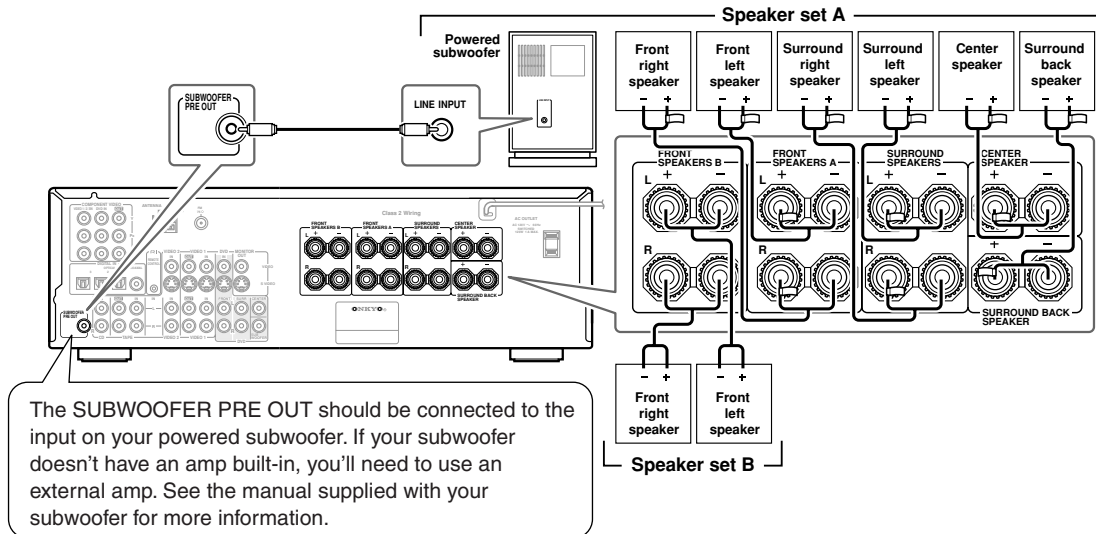

# Connecting Antenna

## Connecting Antenna

This chapter explains how to connect the supplied indoor FM antenna and AM loop antenna and how to connect commercially available outdoor FM and AM antennas. The AV Receiver won't pick up any radio signals without any antenna connected, so you must connect the antenna to use the tuner.

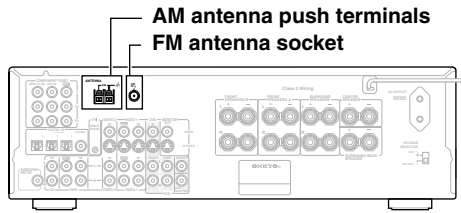

## Connecting the Indoor FM Antenna

The supplied indoor FM antenna is for indoor use only.

### 1 Attach the FM antenna, as shown.

#### ■ American Model

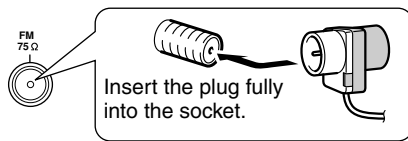

#### ■ Other Models

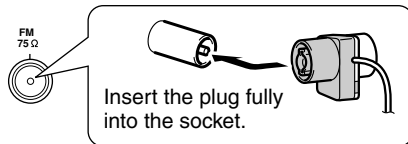

Once the AV Receiver is ready for use, you'll need to tune into an FM radio station and adjust the position of the FM antenna to achieve the best possible reception.

### 2 Use thumbtacks or something similar to fix the FM antenna into position.

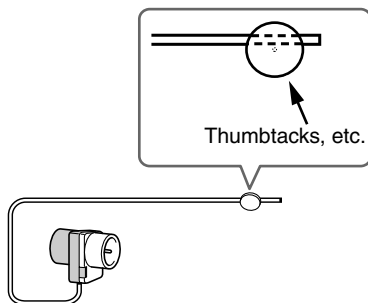

**Caution:** Be careful that you don't injure yourself when using thumbtacks.

If you cannot achieve good reception with the supplied indoor FM antenna, try a commercially available outdoor FM antenna instead (see page 19).

## Connecting the AM Loop Antenna

The supplied indoor AM loop antenna is for indoor use only.

### 1 Assemble the AM loop antenna, inserting the tabs into the base, as shown.

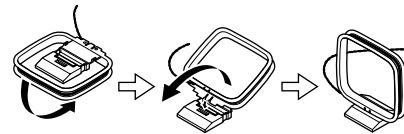

### 2 Connect both wires of the AM loop antenna to the AM push terminals, as shown.

(The antenna's wires are not polarity sensitive, so they can be connected either way around.) Make sure that the wires are attached securely and that the push terminals are gripping the bare wires, not the insulation.

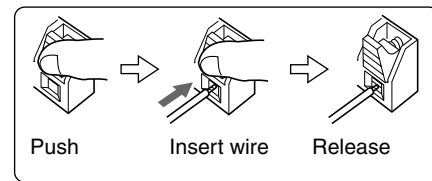

Once the AV Receiver is ready for use, you'll need to tune into an AM radio station and adjust the position of the AM antenna to achieve the best possible reception.

Keep the antenna as far away as possible from the AV Receiver, TV, speaker cables, and power cords.

If you cannot achieve good reception with the supplied indoor AM loop antenna, try using it with a commercially available outdoor AM antenna (see page 19).

## Connecting Antenna—Continued

### Connecting an Outdoor FM Antenna

If you cannot achieve good reception with the supplied indoor FM antenna, try a commercially available outdoor FM antenna instead.

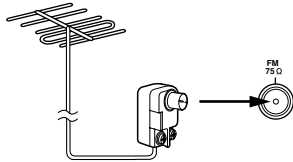

**Notes:**

- Outdoor FM antennas work best outside, but usable results can sometimes be obtained when installed in an attic or loft.
- For best results, install the outdoor FM antenna well away from tall buildings, preferably with a clear line of sight to the transmitter.
- Outdoor antenna should be located away from possible noise sources, such as neon signs, busy roads, etc.
- For safety reasons, outdoor antenna should be situated well away from power lines and other high-voltage equipment.
- Outdoor antenna must be grounded in accordance with local regulations to prevent electrical shock hazards.

#### ■ Using the 75/300-ohm Antenna Adapter

The 75/300-ohm Antenna Adapter is not supplied with American and European models. The 75/300-ohm antenna adapter can be used to connect an FM antenna using either 75-ohm coaxial cable or 300-ohm twin-core flat cable.

#### ■ Connecting 300-ohm Flat Cable

**1** Using a screwdriver, loosen the two screws on the adapter, wrap the bare wires around the screws, and then retighten them, as shown.

**2** Plug the adapter into the 75 Ω socket.

#### ■ Connecting 75-ohm Coaxial Cable

**1** Strip and prepare the 75 ohm coaxial cable, as shown.

**2** Using your fingernails or a small screwdriver, lever the adapter's tabs outward and remove the cover, as shown.

**3** Move the small wire inside the adapter from position A to position B, as shown.

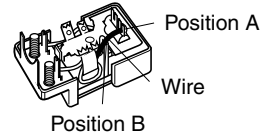

**4** Insert the central conductor (1), as shown, and use a small pair of pliers to clamp the shielding and outer insulation sections of the cable (2), as shown.

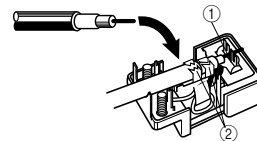

Make sure the shielding is not touching the central conductor.

**5** Refit the adapter's cover, and then plug the adapter into the 75 Ω socket.

#### ■ Using a TV/FM Antenna Splitter

It's best not to use the same antenna for both FM and TV reception, as this can cause interference problems. If circumstances demand it, use a TV/FM antenna splitter, as shown.

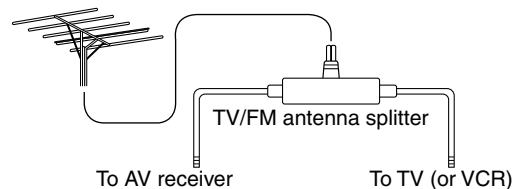

### Connecting an Outdoor AM Antenna

If good reception cannot be achieved using the supplied AM loop antenna, an outdoor AM antenna can be used in addition to the loop antenna, as shown.

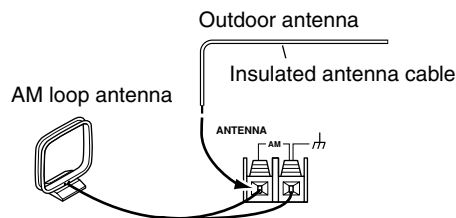

Outdoor AM antennas work best when installed horizontally outside, but good results can sometimes be obtained indoors by mounting horizontally above a window. Note that the AM loop antenna should be left connected.

Outdoor antenna must be grounded in accordance with local regulations to prevent electrical shock hazards.

# Connecting the AV Receiver

## Before Making Any Connections

- Read the manuals supplied with your AV components.
- Don't connect the power cord until you've completed and double-checked all audio and video connections.

## Optical Digital Inputs

The AV Receiver's optical digital inputs have shutter-type covers that open when an optical plug is inserted and close when it's removed. Push plugs in all the way.

**Caution:** To prevent shutter damage, hold the optical plug straight when inserting and removing.

## RCA AV Connection Color Coding

RCA-type AV connections are usually color coded: red, white, and yellow. Use red plugs to connect right-channel audio inputs and outputs (typically labeled "R"). Use white plugs to connect left-channel audio inputs and outputs (typically labeled "L"). And use yellow plugs to connect composite video inputs and outputs.

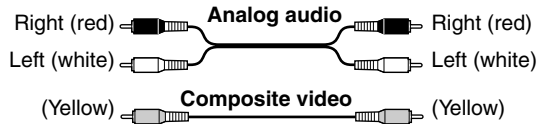

- Push plugs in all the way to make good connections (loose connections can cause noise or malfunctions).
- To prevent interference, keep audio and video cables away from power cords and speaker cables.

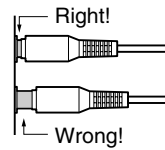

## AV Cables & Sockets

### Video

	Cable	Socket	Description
Component video cable		Y Pb Pr	Component video separates the luminance (Y) and color difference signals (PR, PB), providing the best picture quality. (Some TV manufacturers label their component video sockets slightly differently.)
S-Video cable		S-VIDEO	S-Video separates the luminance and color signals and provides better picture quality than composite video.
Composite video cable		VIDEO	Composite video is commonly used on TVs, VCRs, and other video equipment. Use only dedicated composite video cables.

### Audio

	Cable	Socket	Description
Optical digital audio cable		OPTICAL	Offers the best sound quality and allows you to enjoy surround sound (e.g., Dolby Digital, DTS). The audio quality is the same as for coaxial.
Coaxial digital audio cable		COAXIAL	Offers the best sound quality and allows you to enjoy surround sound (e.g., Dolby Digital, DTS). The audio quality is the same as for optical.
Analog audio cable (RCA)		-L- -R-	This cable carries analog audio. It's the most common connection format for analog audio, and can be found on virtually all AV components.
Multichannel analog audio cable (RCA)		FRONT SURR CENTER DVD S-VIDEO	This cable carries multichannel analog audio and it's typically used to connect DVD players with individual 5.1-channel analog audio outputs. Several standard analog audio cables can be used instead of a multichannel cable.

## Connecting the AV Receiver—Continued

### Connection Guide

#### Inputs

Up to five AV components can be connected to the AV Receiver's rear panel inputs, and one to its front panel input. The following table lists the type of component that you can connect to each input.

Input	Type of component you can connect	Page # for more info.
DVD	DVD player, etc.	23
VIDEO1	VCR, D-VHS, etc.	24
VIDEO2	TV, satellite receiver, cable receiver, set-top box, LD player, etc.	22 (for TV connections) 26
CD	CD player, etc.	28
TAPE	Cassette recorder, DAT, CD recorder, MiniDisc recorder, turntable, etc.	28, 29
VIDEO3	Camcorder, games console, etc.	27

#### Outputs (for recording)

The AV Receiver has two outputs for recording. The following table lists the type of component that you can connect to each output.

Output	Type of component you can connect	Page # for more info.
VIDEO1	VCR, etc.	25
TAPE	Cassette recorder, DAT, CD recorder, MiniDisc recorder, etc.	28, 29

#### MONITOR OUT

Video signals received by the video inputs are output by the MONITOR OUT sockets for display on the connected TV or projector.

The AV Receiver has three types of video output: composite video, S-Video, and component video. Connect the appropriate output to your TV or projector (see page 22).

### Which Connections Should I Use?

The AV Receiver offers several interconnection formats for compatibility with a wide range of AV equipment. The format you choose will depend on the formats supported by your other components. Use the following sections as a guide.

For video equipment you need to use two cables—one for video, one for audio.

### Video Connection Formats

Video equipment can be connected to the AV Receiver using one of the following video connection formats: composite video, S-Video, or component video, the latter offering the best picture quality.

When choosing a connection format, bear in mind that the AV Receiver doesn't convert between formats, so only outputs of the same format as the input will output the signal.

For example, if you connect your DVD player to the S-VIDEO DVD IN, a video signal will be output by the S-VIDEO MONITOR OUT (for your TV) and the S-VIDEO VIDEO 1 OUT (for your VCR), but not by any composite video or component video outputs.

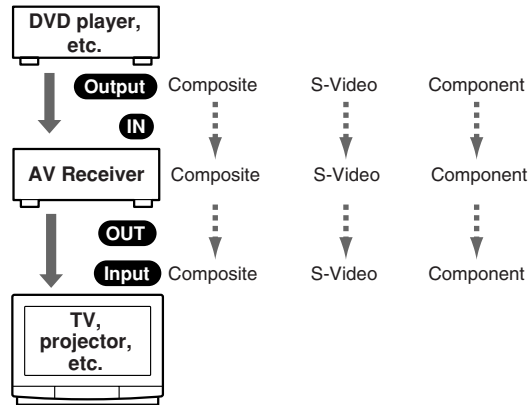

### Audio Connection Formats

Audio equipment can be connected to the AV Receiver using the following audio connection formats: analog, optical, coaxial, and multichannel.

When choosing a connection format, bear in mind that the AV Receiver doesn't convert between formats.

For example, audio signals connected to an OPTICAL or COAXIAL digital input are not output by the analog TAPE OUT, so if you want to record from, for example, your CD player, in addition to connecting it to a digital input, you must also connect it to the analog CD IN.

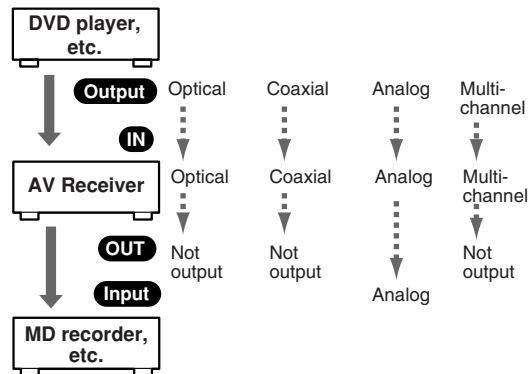

## Connecting the AV Receiver—Continued

### Connecting Your TV or Projector

#### Monitor Out

##### ■ Using Composite Video

Use a composite video cable to connect the AV Receiver's VIDEO MONITOR OUT to a composite video input on your TV, as shown.

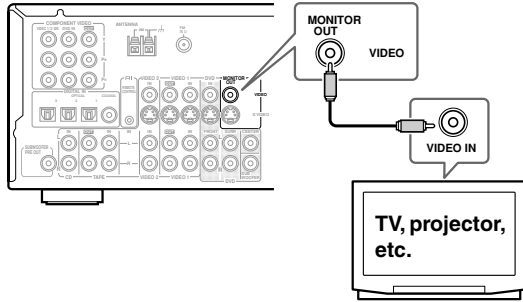

##### ■ Using S-Video

Use an S-Video cable to connect the AV Receiver's S VIDEO MONITOR OUT to an S-Video input on your TV, as shown.

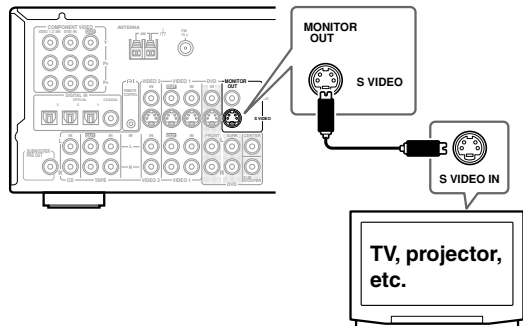

##### ■ Using Component Video

Use a component video cable to connect the AV Receiver's COMPONENT VIDEO OUT to a component video input on your TV, as shown.

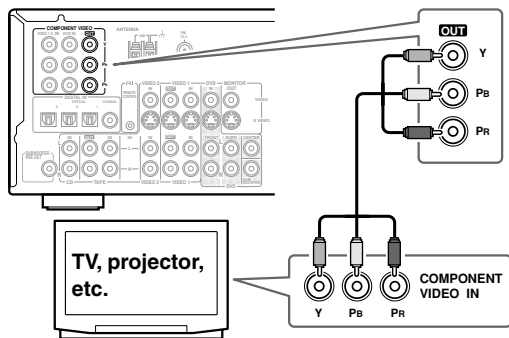

#### Audio Connections

The following connections will allow you to listen to audio from your TV via the AV Receiver.

If your TV has no audio outputs, connect the AV Receiver to your VCR and use its tuner (see page 24).

##### Note:

- Initially, the OPTICAL 2 digital input is assigned to the VIDEO 2 input source. If you connect to a different digital audio input or only to an analog input, you'll need to assign it to the VIDEO 2 input source (see page 31).

##### ■ Using a Coaxial or Optical Connection

- Use an optical digital audio cable to connect the AV Receiver's DIGITAL IN OPTICAL 2 to the optical output on your TV, as shown.

OR

- Use a coaxial digital audio cable to connect the AV Receiver's DIGITAL IN COAXIAL to the coaxial output on your TV, as shown.

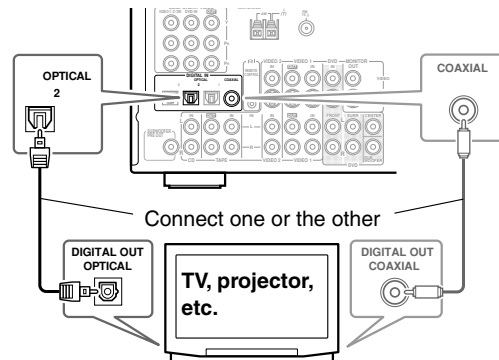

##### ■ Using Analog Connections

If your TV doesn't have digital audio outputs, or you want to record from it, you'll need to make the following analog audio connections.

Use an analog audio cable to connect the AV Receiver's VIDEO 2 IN L/R inputs to the analog audio outputs on your TV, as shown.

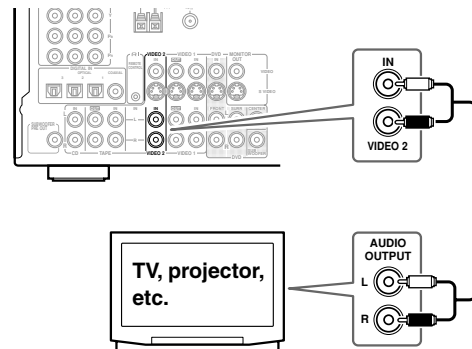

## Connecting the AV Receiver—Continued

### Connecting a DVD player

#### Video Connections

You only need to use one of the following video connection methods.

##### ■ Using Composite Video

Use a composite video cable to connect the AV Receiver's VIDEO DVD IN to the composite video output on your DVD player, as shown.

- Your TV must also be connected via composite video.

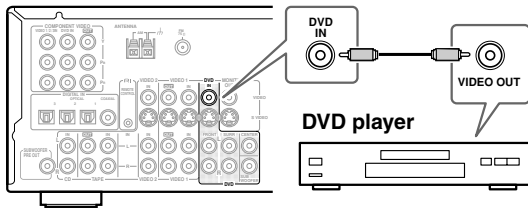

##### ■ Using S-Video

Use an S-Video cable to connect the AV Receiver's S VIDEO DVD IN to the S-Video output on your DVD player, as shown.

- Your TV must also be connected via S-Video.

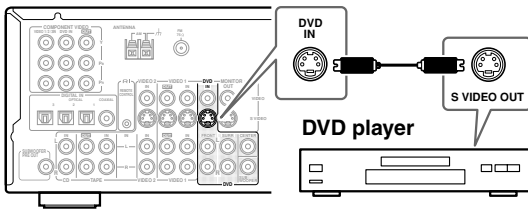

##### ■ Using Component Video

Use a component video cable to connect the AV Receiver's COMPONENT VIDEO DVD IN to the component video output on your DVD player, as shown.

- Your TV must also be connected via component video.

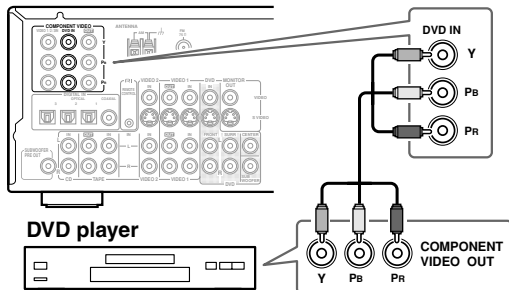

#### Audio Connections

##### Note:

Initially, the OPTICAL 1 digital input is assigned to the DVD input source. If you connect your DVD player to a different digital input or only to an analog input, you'll need to assign it to the DVD input source (see page 31).

##### ■ Using a Coaxial or Optical Connection

- Use an optical digital audio cable to connect the AV Receiver's DIGITAL IN OPTICAL 1 to the optical output on your DVD player, as shown.

OR

- Use a coaxial digital audio cable to connect the AV Receiver's DIGITAL IN COAXIAL to the coaxial output on your DVD player, as shown.

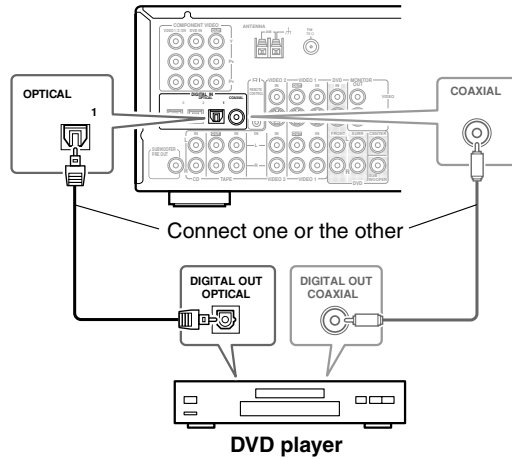

##### ■ Using Analog Connections

Even if your DVD player is connected digitally (coaxial or optical), to use **RI**, or to record audio from your DVD player, you'll need to make analog connections as well.

Use an analog audio cable to connect the AV Receiver's FRONT DVD IN to the analog audio outputs on your DVD player, as shown.

If your DVD player has left, right, and multichannel outputs, be sure to use the left and right outputs.

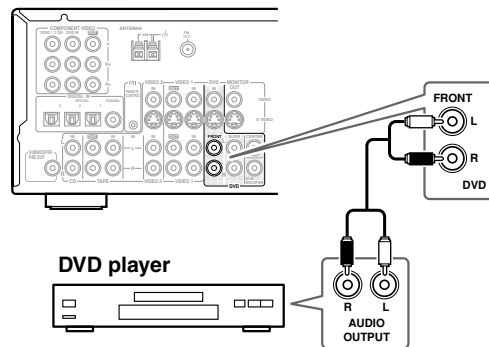

## Connecting the AV Receiver—Continued

### DVD Multichannel Connection

If your player supports multichannel audio formats such as DVD-Audio and Super Audio CD, and it has multichannel analog audio outputs, you can enjoy DVD-Audio and Super Audio CD playback.

Use a multichannel analog audio cable to connect the AV Receiver's MULTI CH INPUT FRONT, SUBWOOFER, CENTER, and SURR sockets to the 5.1-channel analog audio outputs on your DVD player, as shown. Alternatively, use three standard analog audio cables.

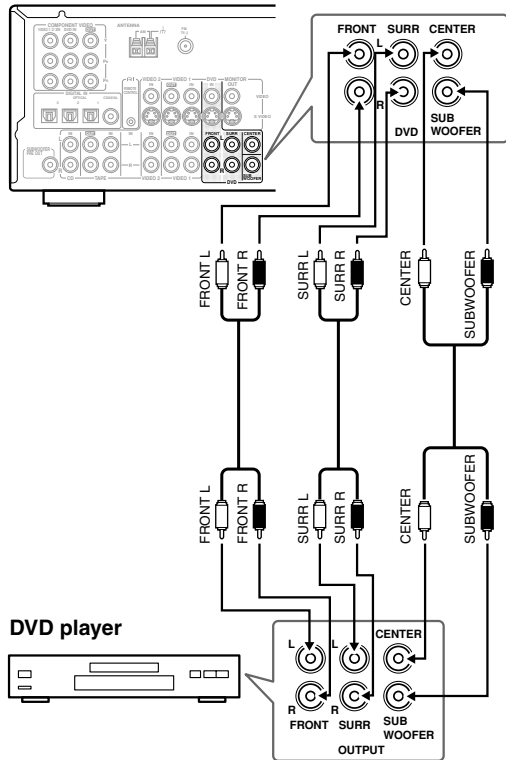

### Connecting a VCR for Playback

You can watch videos by connecting your VCR to the AV Receiver.

**By using your VCR's tuner, this connection example allows you to listen to the sound from your favorite TV programs through the AV Receiver. This is useful if your TV has no audio outputs.**

### Video Connections

- Use an S-Video cable to connect the AV Receiver's S VIDEO VIDEO 1 IN to the S-Video output on your VCR, as shown.

OR

- Use a composite video cable to connect the AV Receiver's VIDEO VIDEO 1 IN to a composite video output on your VCR, as shown.

An S-Video connection provides better picture quality than a composite video connection.

### Audio Connections

- Use an analog audio cable to connect the AV Receiver's VIDEO 1 IN L/R inputs to the analog audio outputs on your VCR, as shown.

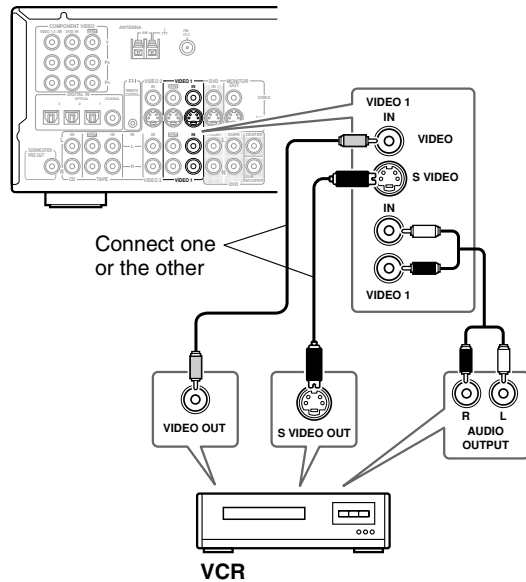





## Connecting the AV Receiver—Continued

### Connecting Other Video Sources— Satellite, Cable, Set-top box, LD Player, etc.

#### Video Connections

You only need to use one of the following video connection methods.

#### ■ Using Composite Video

Use a composite video cable to connect the AV Receiver's VIDEO 2 IN to the composite video output on your video component, as shown.

- Your TV must also be connected via composite video.

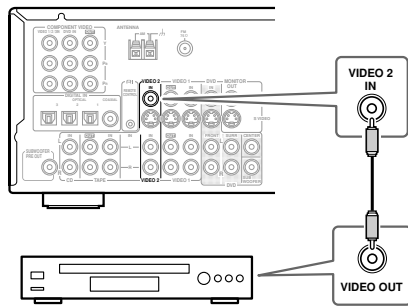

Satellite, cable, set-top box, LD player, etc.

#### ■ Using S-Video

Use an S-Video cable to connect the AV Receiver's S VIDEO 2 IN to the S-Video output on your video component, as shown.

- Your TV must also be connected via S-Video.

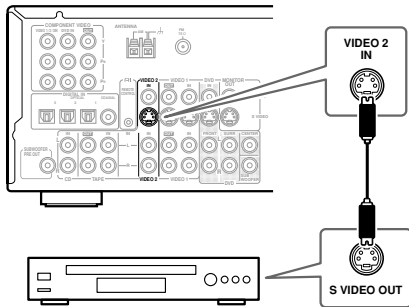

Satellite, cable, set-top box, LD player, etc.

#### ■ Using Component Video

Use a component video cable to connect the AV Receiver's COMPONENT VIDEO 1/2/3 IN to the component video output on your video component, as shown.

- Your TV must also be connected via component video.

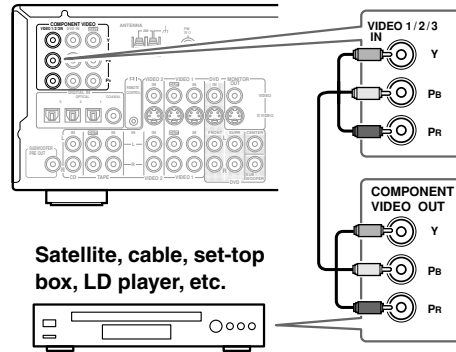

Satellite, cable, set-top box, LD player, etc.

#### Audio Connections

##### Notes:

- Initially, the VIDEO 2 input source is assigned to the OPTICAL 2 DIGITAL IN. If you connect to a different digital audio input, or you connect to only the analog VIDEO 2 input, you'll need to change the input assignment (see page 31).
- To connect an LD player with an AC-3RF output, you'll need a commercially available demodulator.

#### ■ Using a Coaxial or Optical Connection

- Use an optical digital audio cable to connect the AV Receiver's DIGITAL IN OPTICAL 2 to the optical output on your video component, as shown.

OR

- Use a coaxial digital audio cable to connect the AV Receiver's DIGITAL IN COAXIAL to the coaxial output on your video component, as shown.

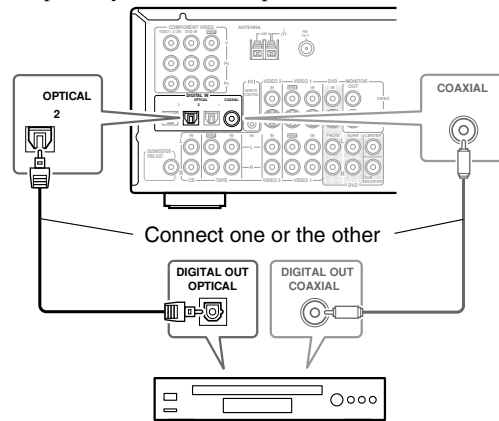

Satellite, cable, set-top box, LD player, etc.

## Connecting the AV Receiver—Continued

### ■ Using Analog Connections

If your video component doesn't have digital audio outputs, or you want to record from it, you'll need to make the following analog audio connections.

Use an analog audio cable to connect the AV Receiver's VIDEO 2 IN L/R inputs to the analog audio outputs on your video component, as shown.

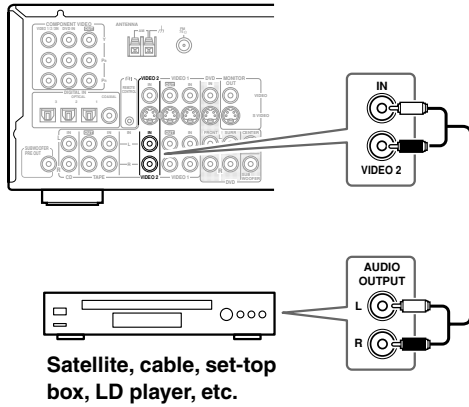

### Connecting a Camcorder, Games Console, etc.

#### Video Connections

You only need to use one of the following video connection methods.

##### ■ Using S-Video

Use an S-Video cable to connect the AV Receiver's VIDEO 3 INPUT S VIDEO input to the S-Video output on your camcorder, games console, etc., as shown.

- Your TV must also be connected via S-Video.

##### ■ Using Composite Video

Use a composite video cable to connect the AV Receiver's VIDEO 3 INPUT VIDEO input to the composite video output on your camcorder, games console, etc., as shown.

- Your TV must also be connected via composite video.

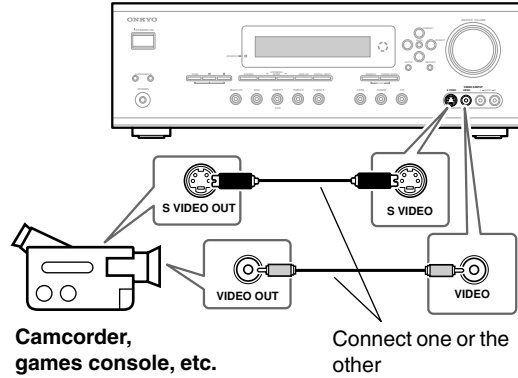

#### Audio Connections

Use an analog audio cable to connect the AV Receiver's VIDEO 3 INPUT AUDIO L/R inputs to the analog audio outputs on your camcorder, games console, etc., as shown.

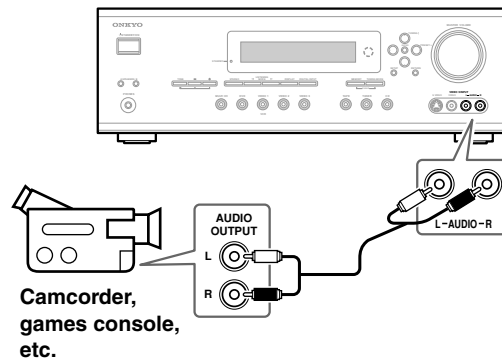

## Connecting the AV Receiver—Continued

### Connecting a CD Player

**Note:**

Initially, the CD input source is assigned to the COAXIAL DIGITAL IN. If you connect your CD player to a different digital input, or you connect it to only the analog CD IN, you'll need to change the input assignment (see page 31).

■ **Using a Coaxial or Optical Connection**

- Use a coaxial digital audio cable to connect the AV Receiver's DIGITAL IN COAXIAL to the coaxial output on your CD player, as shown.

OR

- Use an optical digital audio cable to connect the AV Receiver's DIGITAL IN OPTICAL 3 to the optical output on your CD player, as shown.

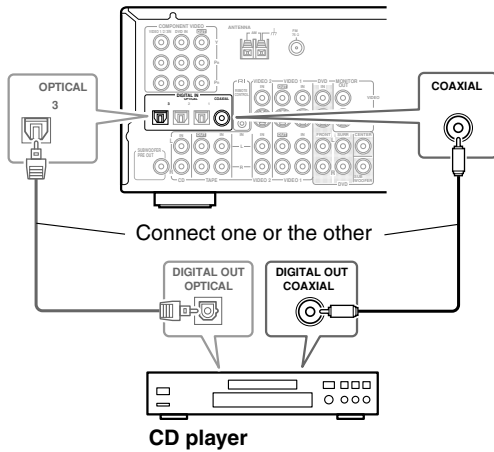

■ **Using Analog Connections**

Even if your CD player is connected digitally (coaxial or optical), to use **RI**, or to record audio from your CD player, you'll need to make analog audio connections as well.

Use an analog audio cable to connect the AV Receiver's CD IN L/R inputs to the analog audio outputs on your CD player, as shown.

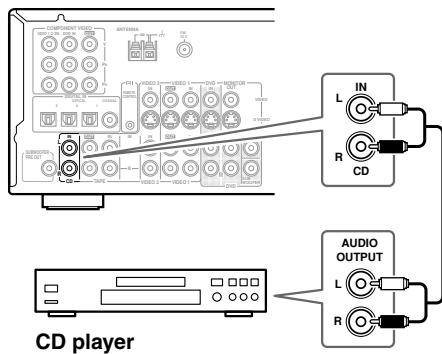

### Connecting a Cassette Recorder

Use an analog audio cable to connect the AV Receiver's TAPE IN L/R inputs to the cassette recorder's outputs, and use another analog audio cable to connect the AV Receiver's TAPE OUT L/R outputs to the cassette recorder's inputs, as shown.

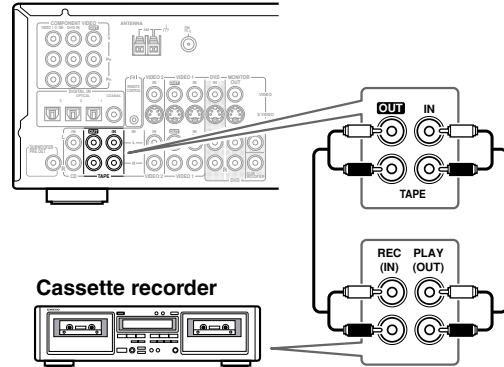

**Note:**

Initially, the TAPE input source is assigned to the OPTICAL 3 DIGITAL IN. If you connect your cassette recorder to only the analog TAPE IN, you'll need to set the TAPE input source to "----" (see page 31).

### Connecting a DAT, CD, or MiniDisc Recorder

You can connect a DAT, CD, or MiniDisc recorder instead of a cassette recorder.

**Note:**

Initially, the TAPE input source is assigned to the OPTICAL 3 DIGITAL IN. If you connect your DAT, CD, or MiniDisc recorder to a different digital input, or you connect it to only the analog TAPE IN, you'll need to change the input assignment (see page 31).

■ **Using Analog Connections**

Use an analog audio cable to connect the AV Receiver's TAPE IN L/R inputs to the recorder's outputs, and use another analog audio cable to connect the AV Receiver's TAPE OUT L/R outputs to the recorder's inputs, as shown.

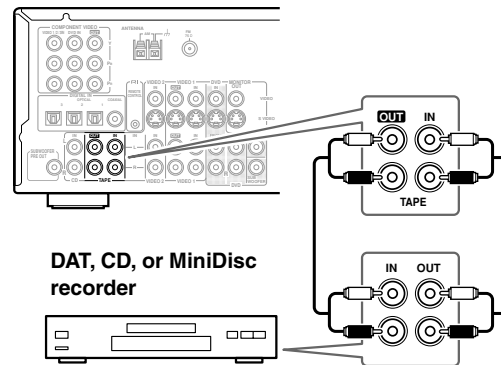

## Connecting the AV Receiver—Continued

### ■ Using a Coaxial or Optical Connection (playback only)

- Use an optical digital audio cable to connect the AV Receiver's DIGITAL IN OPTICAL 3 to the optical output on your recorder, as shown.

OR

- Use a coaxial digital audio cable to connect the AV Receiver's DIGITAL IN COAXIAL to the coaxial output on your recorder, as shown.

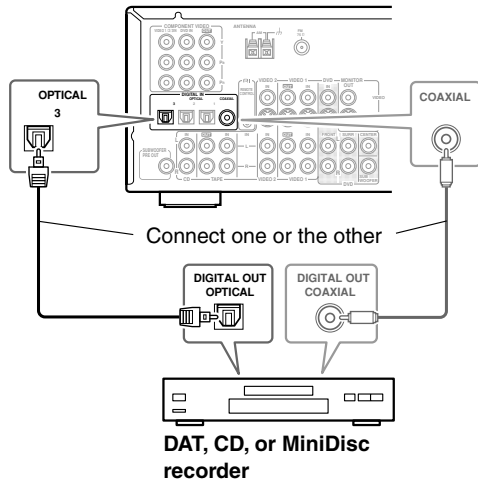

### ■ Turntable without a Built-in Phono Preamp

Use an analog audio cable to connect the AV Receiver's TAPE IN L/R inputs to the audio outputs on your phono preamp, and use another analog audio cable to connect the phono preamp's inputs to your turntable, as shown.

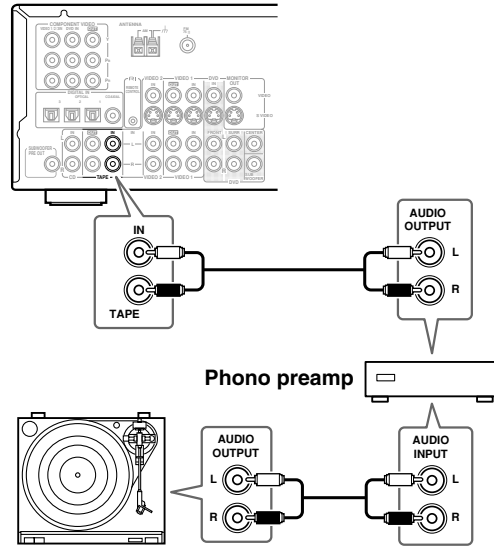

### ■ Turntable with an MC (Moving Coil) Cartridge

Use an analog audio cable to connect the AV Receiver's TAPE IN L/R inputs to the audio outputs on your phono preamp. Use another analog audio cable to connect the phono preamp's inputs to your MC head amp's outputs. And use another analog audio cable to connect the MC head amp's inputs to your turntable, as shown.

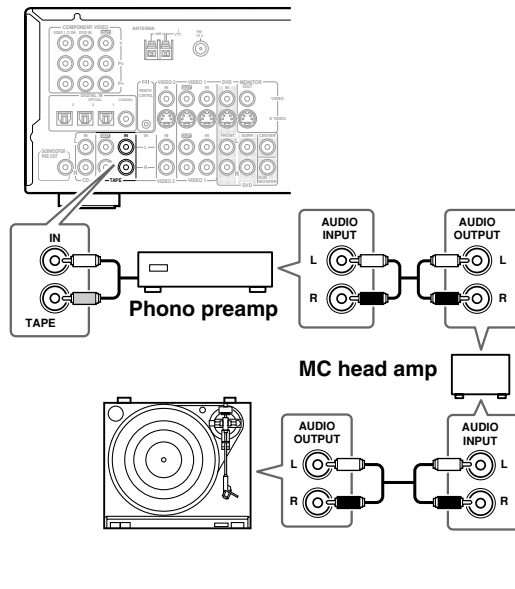

## Connecting a Turntable

### Note:

Initially, the TAPE input source is assigned to the OPTICAL 3 DIGITAL IN. If you connect your turntable to the analog TAPE IN, you'll need to set the TAPE input source to "----" (see page 31).

### ■ Turntable with a Built-in Phono Preamp

Use an analog audio cable to connect the AV Receiver's TAPE IN L/R inputs to the audio outputs on your turntable, as shown.

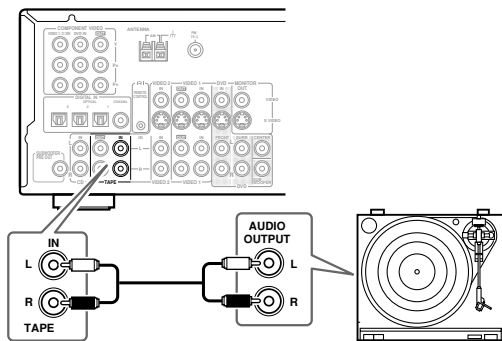

## Connecting the AV Receiver—Continued

### Connecting Onkyo **RI** Components

To use **RI**, you must make an analog audio connection (RCA) between the AV Receiver and the other component, even if they are connected digitally.

With **RI** (Remote Interactive) you can control your **RI**-compatible Onkyo CD player, DVD player, and so on with the AV Receiver's remote controller, and use the following special **RI** functions:

#### Auto Power On/Standby

When you start playback on a component connected via **RI**, if the AV Receiver is in Standby, it will turn on and select that component as the input source automatically. Similarly, when the AV Receiver is set to Standby, all components connected via **RI** also enter Standby. This function will not work if the component's power cord is connected to the AV Receiver's AC OUTLET.

#### Direct Change

When playback is started on a component connected via **RI**, the AV Receiver automatically selects that component as the input source. If your DVD player is connected to the AV Receiver's multichannel input, you must press the [MULTI CH] button to enjoy all channels (see page 35). This is because the Direct Change **RI** function only selects the FRONT DVD IN sockets.

#### Remote Control

You can use the AV Receiver's remote controller to control other **RI**-compatible Onkyo components.

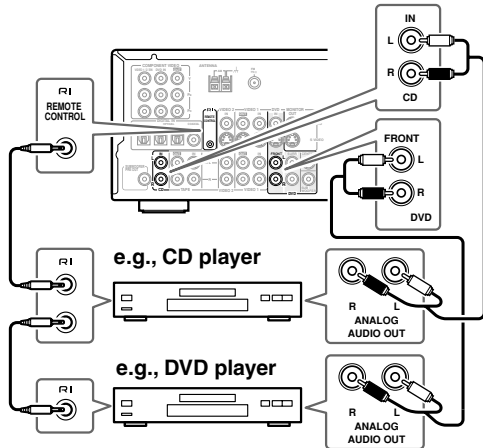

#### Notes:

- Push plugs in all the way to make good connections.
- Use only **RI** cables for **RI** connections. **RI** cables are supplied with Onkyo players (DVD, CD, etc.).
- Some components have two **RI** sockets, you can connect either one to the AV Receiver. The other is for connecting additional **RI**-compatible components.
- Connect the AV Receiver's **RI** socket to only Onkyo components. Connecting to other manufacturer's components may cause them to malfunction.

- Some components may not support all **RI** functions. Refer to the manuals supplied with your components.

### Connecting the Power Cords of Other Components

The AV Receiver has AC outlet on its rear panel for connecting the power cord of another AV component. The other component's power switch can be left in the ON position so that it turns on or off when the AV Receiver is set to On or Standby.

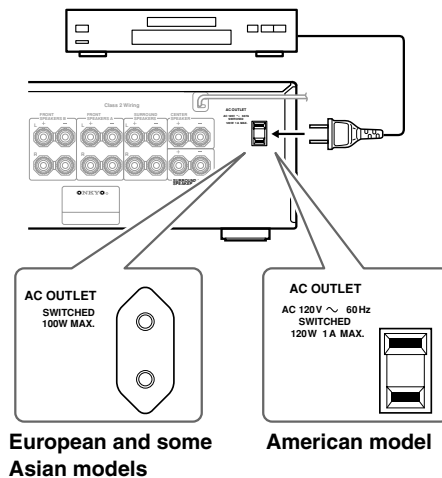

#### Caution:

- Make sure that the capacity of the component that you connect to the AC OUTLET does not exceed the stated capacity (e.g., 100 W).

#### Note:

- Onkyo components with **RI** sockets should be connected to regular wall outlets.
- The connector type and capacity will depend on the country in which you purchased the AV Receiver.

### Connecting the Power Cord

#### Notes:

- Before connecting the power cord, connect all of your speakers and AV components.
- Turning on the AV Receiver may cause a momentary power surge that might interfere with other electrical equipment on the same circuit. If this is a problem, plug the AV Receiver into a different branch circuit.

# Turning On

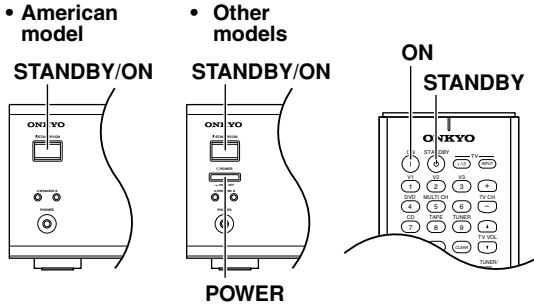

# First Time Setup

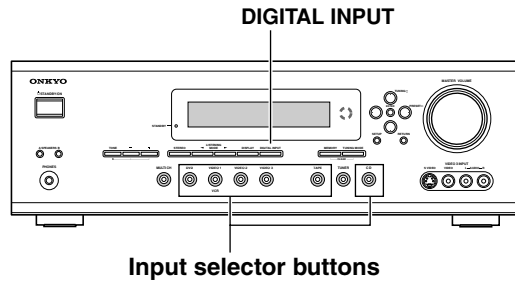

## Turning On the AV Receiver

**1** Set the [POWER] switch to the **ON** position (▲). (Skip this step if you have American model.)

The AV Receiver enters Standby mode, and the STANDBY indicator comes on.

**Note:**

- The remote controller has no effect while the [POWER] switch in the OFF position.

**2** Press the [STANDBY/ON] button. Alternatively, press the remote controller's [AMP] button followed by the [ON] button.

The AV Receiver comes on, the display lights up, and the STANDBY indicator goes off.

To turn off the AV Receiver, press the [STANDBY/ON] button. The AV Receiver will enter Standby mode. To prevent any loud surprises the next time you turn on your AV Receiver, always turn down the volume before turning it off.

- Notes: (not for the American model)**
- The AV Receiver is shipped with the POWER switch in the ON position (▲). When the power cord is connected for the very first time, the AV Receiver will enter Standby and the STANDBY indicator will light up.
  - To completely shutdown the AV Receiver, set the POWER switch to the OFF position (■).

## Assigning the Digital Inputs to Input Sources

To enjoy Dolby Digital and DTS, you must connect your DVD player to the AV Receiver by using a digital audio connection (coaxial or optical).

With this function you can assign digital audio inputs to input sources. You only need to change these assignments if your connections don't match the default assignments listed below.

Input source	DIGITAL INPUT
DVD	OPT1 (OPTICAL 1)
VIDEO 1	---- (Analog)
VIDEO 2	OPT2 (OPTICAL 2)
VIDEO 3	---- (Analog)
TAPE	OPT3 (OPTICAL 3)
CD	COAX (COAXIAL)

For example, if you connect your DVD player to the COAXIAL DIGITAL IN, you'll need to change the DVD input source from OPT 1 to COAX, and change the CD input source to something other than COAX.

If you want to use the TAPE input source with only the analog TAPE IN sockets, you'll need to change the TAPE assignment from "OPT3" to "----" (Analog).

You can change the assignments as follows.

**1** Press the input selector button for the source that you want to assign.

(Digital inputs cannot be assigned to the TUNER input source.)

**2** Press the [DIGITAL INPUT] button.

The current assignment appears.

DVD #OPT1

**3** Press the [DIGITAL INPUT] button repeatedly to select COAX, OPT1, OPT2, OPT3, or ----.

DVD #COAX

## First Time Setup—Continued

### Speaker Configuration

This section explains how to specify which speakers are connected and their sizes.

For speakers with a cone diameter larger than 6-1/2 inches (16 cm), specify **Large**. For those with a smaller diameter, specify **Small**.

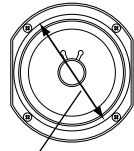

Cone diameter

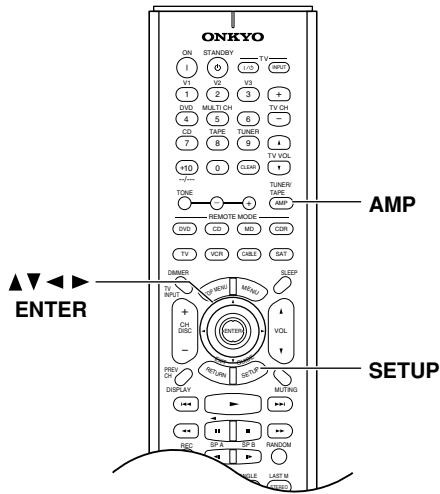

<p><b>1</b></p>	<p>Press the [AMP] button followed by the [SETUP] button.</p>
<p><b>2</b></p>	<p>Use the Up and Down [▲]/[▼] buttons to select “1. SP Config,” and then press the [ENTER] button.</p> <div style="border: 1px solid black; padding: 5px; width: fit-content; margin: 10px auto;">1. SP Config</div>

<p><b>3</b></p>	<p>While the Subwoofer setting is selected, use the Left and Right [◀]/[▶] buttons to select <b>Yes</b> or <b>No</b>.</p> <p><b>Yes:</b> Select if a subwoofer is connected.</p> <p><b>No:</b> Select if no subwoofer is connected.</p>
<p><b>4</b></p>	<p>Use the Down [▼] button to select “Front,” and then use the Left and Right [◀]/[▶] buttons to select <b>Small</b> or <b>Large</b>.</p> <p><b>Small:</b> Select if the front speakers are small.</p> <p><b>Large:</b> Select if the front speakers are large.</p> <p><b>Note:</b></p> <ul style="list-style-type: none"> <li>If the Subwoofer setting in step 3 is set to No, this setting is fixed at Large and does not appear.</li> </ul>
<p><b>5</b></p>	<p>Use the Down [▼] button to select “Center,” and then use the Left and Right [◀]/[▶] buttons to select <b>Small</b>, <b>Large</b>, or <b>None</b>.</p> <p><b>Small:</b> Select if the center speaker is small.</p> <p><b>Large:</b> Select if the center speaker is large.</p> <p><b>None:</b> Select if no center speaker is connected.</p> <p><b>Note:</b></p> <ul style="list-style-type: none"> <li>If the Front setting in step 4 is set to Small, the Large option cannot be selected.</li> </ul>
<p><b>6</b></p>	<p>Use the Down [▼] button to select “Surround,” and then use the Left and Right [◀]/[▶] buttons to select <b>Small</b>, <b>Large</b>, or <b>None</b>.</p> <p><b>Small:</b> Select if the surround left and right speakers are small.</p> <p><b>Large:</b> Select if the surround left and right speakers are large.</p> <p><b>None:</b> Select if no surround left and right speakers are connected.</p> <p><b>Note:</b></p> <ul style="list-style-type: none"> <li>If the Front setting in step 4 is set to Small, the Large option cannot be selected.</li> </ul>



## First Time Setup—Continued

**7**



**Use the Down [▼] button to select “Surr Back,” and use the Left and Right [◀]/[▶] buttons to select **Small, Large, or None.****

**Small:** Select if the surround back speaker is small.

**Large:** Select if the surround back speaker is large.

**None:** Select if no surround back speaker is connected.

**Notes:**

- If the Surround setting in step 6 is set to None, this setting does not appear.
- If the Surround setting in step 6 is set to Small, the Large option cannot be selected.

**8**



**Press the [SETUP] button.**  
Setup closes.

To test that all of your speakers are working properly, press the remote controller’s [TEST TONE] button. The test tone will be output by each speaker in turn and the name of each speaker will appear on the display. To turn off the test tone, press the [TEST TONE] button again.

- If the test tone is not produced by a speaker, or it’s produced by a speaker other than that shown on the display, you may have wired your speakers incorrectly and you should check your connections (see page 17).
- If the test tone is not produced by a speaker and its name does not appear on the display, you may have set the speaker settings incorrectly (see page 32).

### Changing the TAPE/MD/CDR Display

If you connect an **RI**-compatible Onkyo MiniDisc recorder or CD recorder to the TAPE IN/OUT sockets, for **RI** to work properly, you must change this setting. This setting can only be changed on the AV Receiver.

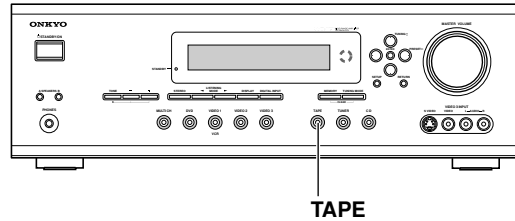

**1**



**Press the [TAPE] input selector button so that “TAPE” appears on the display.**

TAPE

**2**



**Press and hold down the [TAPE] input selector button (about 3 seconds) to set the display.**  
Repeat this step to select TAPE, MD, or CDR.

MD

CDR

# Playing Your AV Components

This chapter explains how to use the AV Receiver with your other AV components.

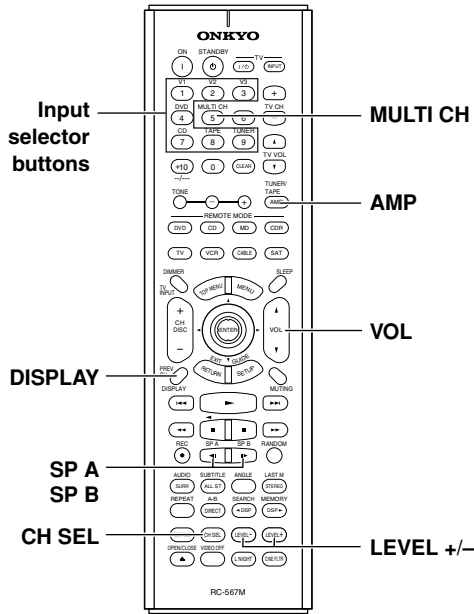

## Selecting the Source Component

**1** Press the [AMP] button followed by an input selector button to select the component that you want to play.

The name of the selected source appears on the display, as shown.

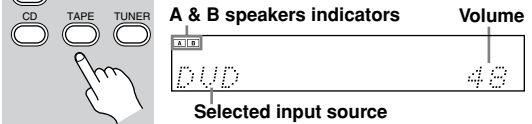

**2** Use the [SP A] and [SP B] buttons to select the speaker set that you want to use.

The A and B speaker indicators show whether each speaker set is on or off.

**Note:**

When you turn on speaker set B, the listening mode for speaker set A is set to Stereo automatically.

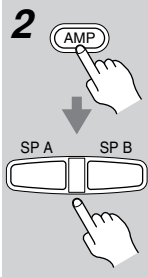

**3** Start playback on the selected component.

**4** To adjust the volume, use the MASTER VOLUME control or the remote controller's VOL button.

The volume can be set to MIN, 1 through 79, or MAX.

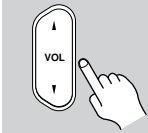

**5** Enjoy listening modes. See page 40.

## Playing Your AV Components—Continued

### Displaying Source Information

You can display various information about the current input source as follows.

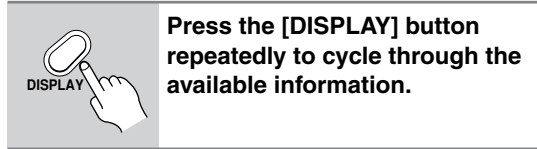

Press the [DISPLAY] button repeatedly to cycle through the available information.

The following information can typically be displayed for input sources.

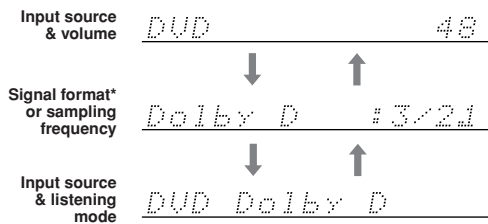

\*If the input signal is analog, no format information is displayed. If the input signal is PCM, the sampling frequency is displayed. If the input signal is digital but not PCM, the signal format is displayed. Information is displayed for about three seconds, then the previously displayed information reappears.

### Interpreting Surround Channel Information

3/21  
A B C

- A: The number of front channels (front left, front right, and center).
- B: The number of surround channels (surround left and surround right). If there's a surround back channel information, this number will be 3.
- C: LFE channel for subwoofer (1 means yes).

### Using the Multichannel Input

The multichannel input is for connecting a component with individual 5.1-channel analog audio outputs, such as a DVD player or MPEG decoder.

See "DVD Multichannel Connection" on page 24 for connection information.

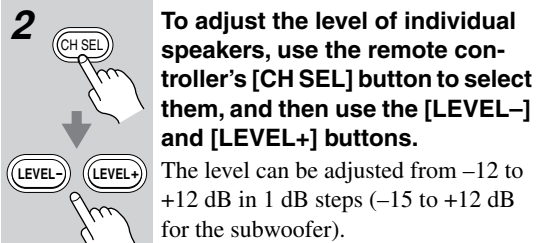
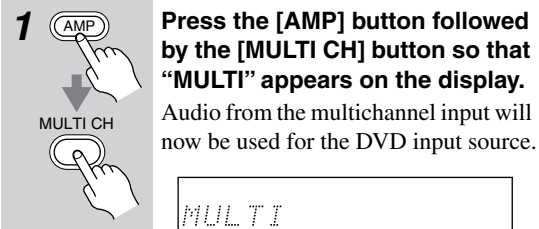

Note that the individual speaker level settings for the multichannel input are independent of those explained on page 49.

#### Notes:

- While the multichannel input is selected, you can select only the **Pure Audio** or **Direct** listening mode. If you select the multichannel input while using another listening mode, that listening mode is cancelled.
- While the multichannel input is selected, the Speaker Configuration settings on page 32 are ignored, and signals from the multichannel input are fed to the front left, front right, center, surround left, and surround right speakers and subwoofer regardless of those settings.

## Using the Tuner

With the built-in tuner you can enjoy AM and FM radio stations. You can store your favorite stations as presets for quick selection.

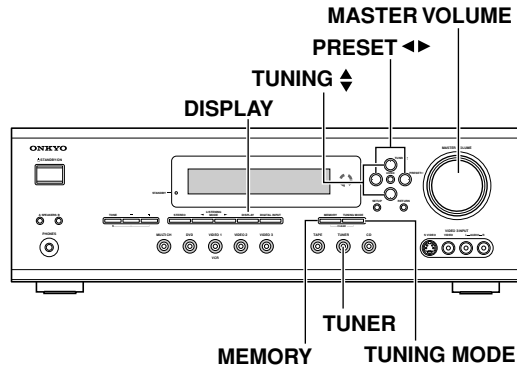

### Listening to the Radio

**1** Use the [TUNER] input selector button to select either AM or FM. In this example, FM has been selected.

The diagram shows a hand pressing the TUNER button. Below it, the display shows 'FM 87.50MHz'. The display is divided into 'Band' (FM) and 'Frequency' (87.50MHz) sections.

### Setting the AM Tuning Interval (Worldwide model only)

If you're using the Worldwide model (i.e., your AV Receiver has a VOLTAGE SELECTOR on the rear panel), you need to set the AM tuning interval for compatibility with AM broadcasts in your particular country. The initial setting is 9 kHz.

North America: 10 kHz

Other countries: 9 kHz

**To set the AM tuning interval, while holding down the [TUNER] button, press the [MEMORY] button.**

The diagram shows a hand holding the TUNER button and another hand pressing the MEMORY button. A plus sign (+) is shown between the two buttons.

#### Note:

All presets will be deleted when you change the AM tuning interval.

### Tuning into Radio Stations

#### Auto Tuning Mode

**1** Press the [TUNING MODE] button so that the AUTO indicator appears on the display.

The diagram shows a hand pressing the TUNING MODE button. The display shows 'TUNING MODE' and 'AUTO'.

**2** Press the TUNING Up or Down [▲]/[▼] button. Searching stops when a station is found.

The diagram shows a hand pressing the TUNING Up and Down buttons. The display shows 'TUNING' and 'FM STEREO'.

When tuned into an FM station, the TUNED and FM STEREO indicators appear on the display, as shown. When tuned into an AM station, the TUNED indicator appears.

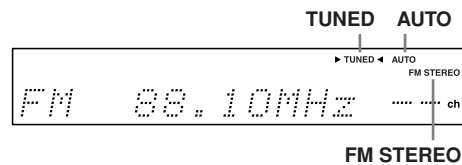

#### Using RDS (European model only)

When tuned into an RDS (Radio Data System) station that's broadcasting PS (Program Service Name) information, the RDS indicator appears, and the name of the station appears on the display. Only European models support RDS, and only in areas where RDS is used.

#### Manual Tuning Mode

**1** Press the [TUNING MODE] button so that the AUTO indicator disappears from the display.

The diagram shows a hand pressing the TUNING MODE button. The display shows 'TUNING MODE' and 'FM STEREO'.

**2** Press and hold the TUNING Up or Down [▲]/[▼] button. The frequency stops changing when you release the button. Press the buttons repeatedly to change the frequency one step at a time.

The diagram shows a hand pressing the TUNING Up and Down buttons. The display shows 'TUNING' and 'FM STEREO'.

The American model changes FM frequency in 0.1 MHz steps, 10 kHz steps for AM. For other models it's 0.05 MHz steps for FM and 9 kHz steps for AM.

In Manual Tuning mode, FM stations will be in mono. Switch back to Auto Tuning mode for stereo.

#### Tuning into weak FM stations

If the signal from a stereo FM station is weak, it may be impossible to get good reception. In this case, switch to Manual Tuning mode and listen to the station in mono.

## Using the Tuner—Continued

### Presetting Radio Stations

You can store up to 30 of your favorite radio stations as presets.

- 1** Tune into the station that you want to store as a preset.
- 2** Press the [MEMORY] button. The MEMORY indicator appears and the preset number flashes.

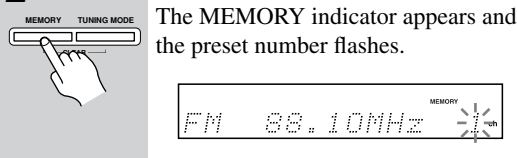

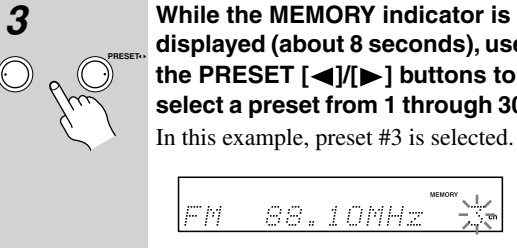
- 3** While the MEMORY indicator is displayed (about 8 seconds), use the PRESET [◀]/[▶] buttons to select a preset from 1 through 30. In this example, preset #3 is selected.

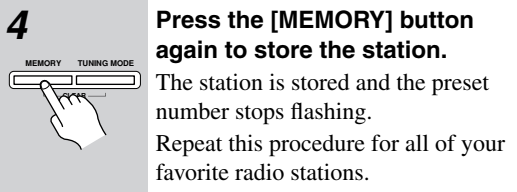

- 4** Press the [MEMORY] button again to store the station. The station is stored and the preset number stops flashing. Repeat this procedure for all of your favorite radio stations.



### Selecting Preset Stations

- 1** Use the [TUNER] input selector button to select either AM or FM.

- 2** Use the PRESET [◀]/[▶] buttons, or the remote controller's CH [+/-] button to select the presets.



### Deleting Presets

- 1** Select the preset that you want to delete. See the previous section.
- 2** While holding down the [MEMORY] button, press the [TUNING MODE] button. The selected preset is deleted and its number disappears from the display.

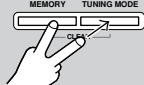

### Displaying Radio Information

- 1** Press the [DISPLAY] button repeatedly to cycle through the available information.



When the input source is AM or FM:

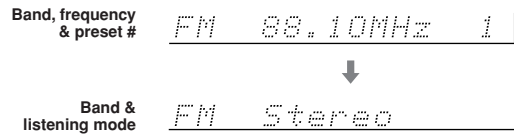

When tuned to an RDS radio station broadcasting PS information (European models only):

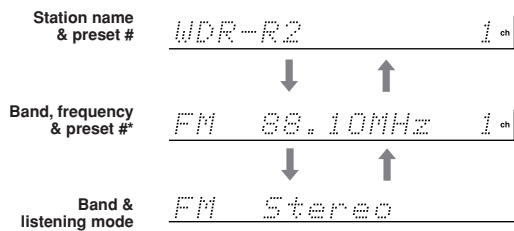

\*This information is displayed for about five seconds, then the previously displayed information reappears.

# Common Functions

This chapter explains functions that can be used with any input source.

Before performing any of the procedures in this chapter, press the [AMP] button first to select AMP mode.

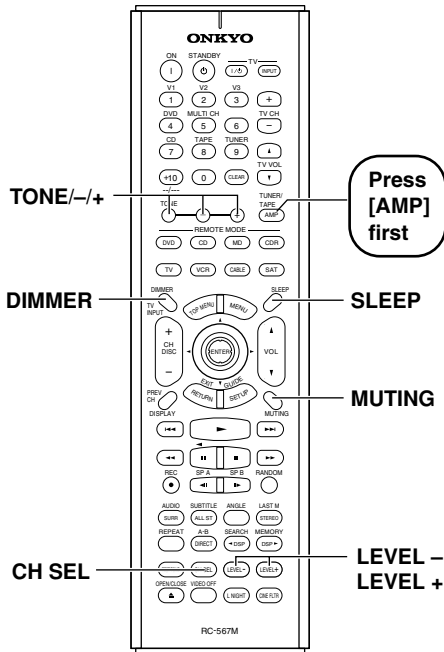

## Setting the Display Brightness

With this function you can adjust the brightness of the display.

DIMMER



Press the [DIMMER] button repeatedly to select: dim, dimmer, or normal brightness.

## Adjusting the Bass & Treble

You can adjust the bass and treble for the front speakers at any time, except when the Direct listening mode is selected.

If you've selected the multichannel DVD input, before pressing the [TONE] button, press the remote controller's [AMP] button followed by the [SURR] button so that "Tone On" appears on the display.

MLT Tone On

1

TONE



Press the [TONE] button repeatedly to select either Bass or Treble.

2

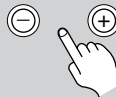

Use the TONE [-]/[+] buttons to adjust.

### ■ Bass

You can boost or cut low-frequency sounds output by the front speakers from -12 dB to +12 dB in 2 dB steps.

### ■ Treble

You can boost or cut high-frequency sounds output by the front speakers from -12 dB to +12 dB in 2 dB steps.

### Note:

- To bypass the bass and treble tone circuits, press the [DIRECT] or [PURE A] button to select the Direct or Pure Audio listening mode.

## Common Functions—Continued

### Muting the AV Receiver

With this function you can temporarily mute the output of the AV Receiver.



**Press the remote controller's [MUTING] button.**

The output is muted and the MUTING indicator flashes on the display, as shown.



**To unmute the AV Receiver,** press the remote controller's [MUTING] button again, or adjust the volume. The output is unmuted and the MUTING indicator goes off. Muting is cancelled when the AV Receiver is set to Standby.

### Adjusting Speaker Levels Temporarily

You can adjust individual speaker levels while listening to an input source. These temporary adjustments are cancelled when the AV Receiver is set to Standby.



**1 Use the remote controller's [CH SEL] button to select each speaker, and use the [LEVEL-] and [LEVEL+] buttons to adjust the volume.**

Speakers are selected in the following order: Left → Center → Right → Surr Right → Surr Back → Surr Left → Subwoofer.

You can adjust the volume of each speaker from -12 dB to +12 dB (-15 dB to +12 dB for the subwoofer).

The name of the currently selected speaker and its volume appear on the display, as shown.

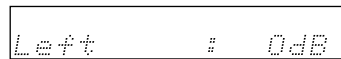

#### Notes:

- You cannot use this function while the AV Receiver is muted.
- Speakers that are set to No or None in the Speaker Configuration cannot be adjusted.

### Using the Sleep Timer

With the sleep timer you can set the AV Receiver so that it automatically turns off after a set period.



**Press the [SLEEP] button repeatedly to select the required sleep time.**

You can set the sleep time from 90 to 10 minutes in 10 minute steps.

The SLEEP indicator appears on the display when the sleep timer has been set, as shown. The specified sleep time appears on the display for about five seconds, then the previous display reappears.

SLEEP indicator

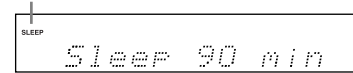

**To cancel the sleep timer,** press the [SLEEP] button repeatedly until the SLEEP indicator disappears.

**To check the remaining sleep time,** press the [SLEEP] button. Note that if you press the [SLEEP] button while the sleep time is being displayed, you'll shorten the sleep time by 10 minutes.

### Using Headphones

You can connect a pair of stereo headphones (1/4-inch phone plug) to the AV Receiver's PHONES jack for private listening, as shown.

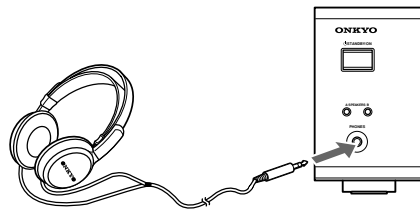

#### Notes:

- Always turn down the volume before connecting your headphones.
- Speaker sets A and B are turned off while the headphones plug is inserted in the PHONES jack.
- When you connect a pair of headphones, the listening mode is set to Stereo, unless it's already set to Pure Audio, Stereo or Direct. When you disconnect the headphones, the previous listening mode is selected.
- When the multichannel DVD input is selected, only the front left and front right sounds can be heard in the headphones.

# Using the Listening Modes

With its built-in surround-sound decoders and DSP programs, the AV Receiver can transform your home listening room into a movie theater or concert hall.

To get the most from surround sound, it's important that you install and configure your speakers correctly. See "Connecting Your Speakers" on page 17 and "Speaker Configuration" on page 32.

Listening mode availability depends on the format of the current input signal. For example, the Dolby Digital listening modes are available only while a Dolby Digital format signal is being input.

The following table lists all the possible listening modes and indicates which modes can be selected for each input signal format.

Input Signal Format	PCM, analog	PCM			Dolby Digital			DTS		
		96 kHz	3/2.1 or 3/3.1	2/0 (stereo)	Other	3/2.1	2/0 (stereo)	96/24 *5	DTS-ES	
<b>Source</b>	CD, TV, LD, VHS, MD, vinyl, radio, cassette, cable, satellite, etc.	96 kHz/24 bit DVD, etc.	DVD, digital cable/satellite, etc.			DVD, LD, CD, etc.				
<b>Listening mode</b>										
Pure Audio (not American model)	<input type="radio"/>	<input type="radio"/>								
Direct	<input type="radio"/>	<input type="radio"/>								
Stereo	<input type="radio"/>	<input type="radio"/>	<input type="radio"/>	<input type="radio"/>	<input type="radio"/>	<input type="radio"/>	<input type="radio"/>	<input type="radio"/>	<input type="radio"/>	
PLII Movie/Music/Game *1	<input type="radio"/>			<input type="radio"/>			<input type="radio"/>			
PLIIX Movie/Game *2	<input type="radio"/>			<input type="radio"/>			<input type="radio"/>			
PLIIX Music *2	<input type="radio"/>		<input type="radio"/> *3	<input type="radio"/>		<input type="radio"/> *3	<input type="radio"/>	<input type="radio"/> *3		
Neo:6 Cinema/Music	<input type="radio"/>									
Dolby Digital			<input type="radio"/>		<input type="radio"/>					
Dolby Digital EX *4			<input type="radio"/>							
DTS						<input type="radio"/>			<input type="radio"/>	
DTS 96/24								<input type="radio"/>		
DTS-ES Discrete *4									Discrete	
DTS-ES Matrix *4									Matrix	
DTS+Neo:6 *3						<input type="radio"/>		<input type="radio"/>		
DTS+Dolby EX *3						<input type="radio"/>		<input type="radio"/>		
Onkyo original DSP	Orchestra	<input type="radio"/>								
	Unplugged	<input type="radio"/>								
	Studio-Mix	<input type="radio"/>								
	TV Logic	<input type="radio"/>								
	All Ch Stereo	<input type="radio"/>								

- \*1: Available when the Surr Back setting in the Speaker Configuration is set to None (see page 32).
- \*2: Available when the Surr Back setting in the Speaker Configuration is NOT set to None (see page 32).
- \*3: Available when the Surr Back setting in the Speaker Configuration is NOT set to None (page 32) and the Dolby Digital/DTS setting (page 44) is set to On.
- \*4: Available when the Surr Back setting in the Speaker Configuration is NOT set to None (page 32) and the Dolby Digital/DTS setting (page 44) is set to either On or Auto.
- \*5: For DTS 96 kHz/24-bit material, if the listening mode is Stereo or DTS 96/24, audio is processed at 96 kHz. For all other listening modes, it's processed at 48 kHz.

**Tip:** You can check the format of a digital input signal on page 35, "Displaying Source Information."



## Using the Listening Modes—Continued

### Selecting Listening Modes

See “About the Listening Modes” on page 42 for detailed information about the listening modes.

- The Dolby Digital and DTS listening modes can only be selected if your DVD player is connected to the AV Receiver with a digital audio connection (coaxial or optical).
- Listening mode availability depends on the format of the current input signal.
- While speaker set B is on or a pair of headphones are connected, you can only select the Pure Audio, Direct or Stereo listening mode.
- While the multichannel input is being used, only the Pure Audio and Direct listening modes can be selected.

### Selecting with the Remote Controller

#### American model

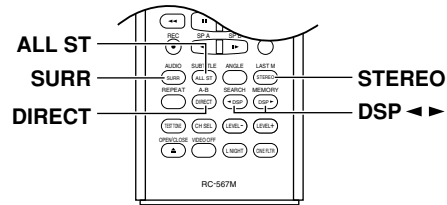

#### Other models

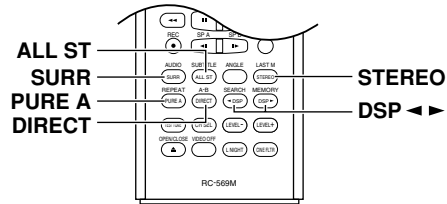

### Selecting on the AV Receiver

#### American model

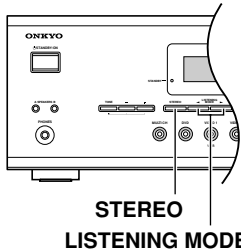

#### Other models



- **[PURE AUDIO] button (not American model)**  
This button selects the Pure Audio listening mode. When this mode is selected, the AV Receiver outputs no video signals and its display is turned off.
- **[STEREO] button (American model only)**  
This button selects the Stereo listening mode.
- **LISTENING MODE [◀] [▶] buttons**  
These buttons select all of the listening modes that can be used with the current input source. The surround modes available also depends on the Dolby Digital/DTS setting (see page 44).

#### ■ [PURE A] button (not American model)

This button selects the Pure Audio listening mode. When this mode is selected, the AV Receiver outputs no video signals and its display is turned off.

#### ■ [DIRECT] button

This button selects the Direct listening mode.

#### ■ [STEREO] button

This button selects the Stereo listening mode.

#### ■ [SURR] button

This button selects the Dolby Digital and DTS listening modes. The modes available depends on the Dolby Digital/DTS setting. When the multichannel DVD input is selected, this button is also used when adjusting the bass and treble (see page 38).

#### ■ [◀ DSP] & [DSP ▶] buttons

These buttons select the Onkyo original DSP modes.

#### ■ [All ST] button

This button selects the All Ch Stereo listening mode.

## Using the Listening Modes—Continued

### About the Listing Modes

The AV Receiver's surround indicators show which speakers are active in each listening mode.

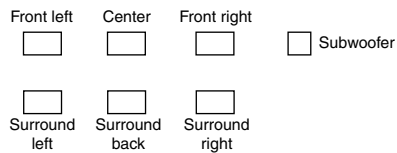

### Basic Modes

#### Pure Audio (not North America)

This mode turns off the display, turns off the video circuitry, and minimizes any other possible noise sources, providing a high fidelity sound that's true to the original. (Since the power to the video circuitry is turned off, no video signals are output while this mode is selected.)

#### Direct

The selected input source is output by the front left and right speakers only, with minimal processing for a pure sound.

#### Stereo

The selected input source is processed as a stereo signal and output by the front left and right speakers and the subwoofer.

### Surround Modes

#### Dolby Pro Logic II

Dolby Pro Logic II creates 5.1-channel surround from two-channel material.



- **Dolby Pro Logic II Movie**  
Use this mode with DVDs and videos that bear the Dolby Surround logo or TV programs that feature Dolby Surround. You can also use this mode with stereo movies or TV programs.
- **Dolby Pro Logic II Music**  
Use this mode with the stereo sources such as music CDs and DVDs.
- **Dolby Pro Logic II Game**  
Use this mode with video games that feature stereo sound.

#### Dolby Pro Logic Ix

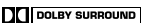
Dolby Pro Logic Ix can create 6.1-channel surround from two-channel material (except 96 kHz PCM). The Dolby Pro Logic Ix Music mode can create 6.1-channel surround from 5.1-channel audio material.

- **Dolby Pro Logic Ix Movie**  
Use this mode with DVDs and videos that bear the  or TV programs that feature Dolby

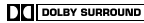
Surround. You can also use this mode with stereo movies, TV programs, or other 2-channel sources.

- **Dolby Pro Logic Ix Music**  
Use this mode with CDs and DVDs that bear the  or . It can also be used with other 5.1-channel sources to create 6.1-channel surround.
- **Dolby Pro Logic Ix Game**  
Use this mode with video games that feature stereo sound.

#### Neo:6

This mode creates 6.1-channel surround from 2-channel analog sources. It offers six full-bandwidth channels with excellent separation. There are two modes of operation: Cinema mode, which is suited to movies, and Music mode, which is for listening to music.

- **Cinema** mode simulates the realistic sense of movement that you get with 6.1-channel surround sound sources. Use this mode with videos, DVDs, and TV programs that feature stereo sound.
- **Music** mode uses the surround channels to simulate a natural sound field that cannot be produced with conventional stereo. Use this mode with stereo source material such as music CDs.

#### Dolby Digital

With this format you can experience the same superb sound that you get at a movie theater or concert hall. Use this mode with DVDs that bear the Dolby Digital logo.



#### Dolby Digital EX

With an added surround-back channel, this 6.1 channel format offers a heightened sense of space, for added realism with moving sounds, such as those that rotate 360 degrees or pass overhead. Dolby Digital EX material can also be played on conventional 5.1 channel systems, in which case the surround-back channel audio is divided between the surround left and right channels. Use this mode with DVDs that have a 6.1-channel soundtrack and bear the Dolby Digital logo.



#### DTS

This digital surround format offers a surround sound experience with exceptional fidelity. It uses compressed digital audio data, with six discrete channels (5.1), and has the ability to handle large amounts of audio data while remaining faithful to the original. DTS provides very high-quality sound. You'll need a DTS compatible DVD player in order to enjoy DTS material. Use this mode with DVDs, LDs, or CDs that bear the DTS logo.



#### DTS 96/24



This mode provides better audio quality. Use it with CDs, DVDs, and LDs that bear the .

## Using the Listening Modes—Continued

### DTS-ES

DTS-ES supports up to 6.1 channels. The AV Receiver supports both DTS-ES Discrete and DTS-ES Matrix.

**Discrete** mode is for use with DTS 6.1  material. With an additional surround-back channel, each 6.1 channel is digitally recorded for a realistic sense of movement and space. Use it with CDs, DVDs, and LDs that bear the DTS-ES logo.

**Matrix** mode creates 6.1-channel surround from DTS 5.1 material. Since DTS 5.1 includes surround-back channel information, the channel can be reconstructed for playback on 6.1-channel systems. Use this mode with CDs, DVDs, and LDs that bear the DTS-ES or DTS logo.  

### DTS+Neo:6

This mode uses the Neo:6 decoder to create 6.1-channel surround from DTS 5.1-channel material. Use it with CDs, DVDs, and LDs that bear the DTS or DTS 96/24 logo.

### DTS+Dolby EX

This mode uses the Dolby EX decoder to create 6.1-channel surround from DTS 5.1-channel material. Use it with CDs, DVDs, and LDs that bear the DTS or DTS 96/24 logo.

## Onkyo Original DSP Modes

### Orchestra

Suitable for classical or operatic music. The center speaker is turned off and the surround channels are emphasized in order to widen the stereo image. In addition, it simulates the natural reverberation of a large hall.

### Unplugged

Suitable for acoustic instrument sounds, vocals, and jazz music. By emphasizing the front stereo image, it simulates the stage-front experience.

### Studio-Mix

Suitable for rock and pop music. Listening to music in this mode creates a lively sound field with a powerful acoustic image, like being at a club or rock concert.











### TV Logic

Adds realistic acoustics to TV programs produced in a TV studio. In addition, it adds surround effects to the entire sound and clarity to voices.

### All Ch Stereo

Ideal for background music. The front, surround, and surround back channels create a stereo image that fills the entire listening area.

## Listening mode indicators

Listening mode	Display
Pure Audio	Pure Audio indicator
Direct	DIRECT
Stereo	STEREO
PL II Movie/Music/Game	 PL II
PL IIx Movie/Music/Game	 PL II x
Neo:6 Cinema/Music	 Neo:6
Dolby Digital	 D
Dolby Digital EX	 D EX
DTS	
DTS 96/24	 96/24
DTS-ES	 ES
DTS+Neo:6	 Neo:6
DTS+Dolby EX	 EX 
Onkyo Original DSP	DSP

## Using the Listening Modes—Continued

### Dolby Digital/DTS setting (5.1 or 6.1-channel playback)

If the Surr Back setting is set to anything other than None in the Speaker Configuration (page 32), and if the surround information in the current input signal is “3/2.1” or “3/3.1 (you can check the format of a digital input signal on page 35, “Displaying Source Information.”), you can determine whether Dolby Digital and DTS material is played using 6.1-channels or 5.1-channels.

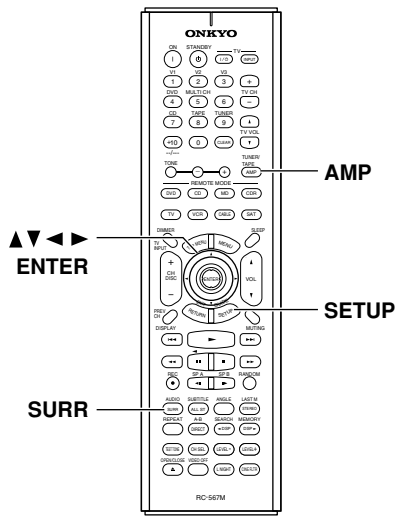

<b>1</b>	<p>Press the [AMP] mode button followed by the [SETUP] button.</p>
<b>2</b>	<p>Use the Up and Down [▲]/[▼] buttons to select “4. Audio Adjust,” and then press the [ENTER] button.</p> <div style="border: 1px solid black; padding: 2px; width: fit-content; margin: 5px auto;">4. Audio Adjust</div>

<b>3</b>	<p>When playing Dolby Digital material: Use the Up and Down [▲]/[▼] buttons to select “SB (Dolby D),” and then use the Left and Right [◀]/[▶] buttons to select “Auto,” “On,” or “Off.”</p> <p>When playing DTS material: Use the Up and Down [▲]/[▼] buttons to select “SB (DTS),” and then use the Left and Right [◀]/[▶] buttons to select “Auto,” “On,” or “Off.”</p>
<b>4</b>	<p>Press the [SETUP] button. Setup closes.</p>
<b>5</b>	<p>Use the remote controller’s [SURR] button, or the AV Receiver’s LISTENING MODE [◀]/[▶] buttons to select the required listening mode.</p>

#### Dolby Digital Setting

- Auto:** If the source signal contains a Dolby Digital EX flag, Dolby Digital EX 6.1 is used. If not, Dolby Digital 5.1 is used.
- On:** Dolby Digital EX 6.1 is used regardless of whether the source signal contains a Dolby Digital EX flag. You can switch between Dolby Digital EX and PL IIX Music.
- Off:** Dolby Digital 5.1 is used even if a Dolby Digital EX flag is present.

#### DTS Setting

- Auto:** If the source signal contains a DTS-ES flag, DTS-ES Discrete (6.1) or DTS-ES Matrix (6.1) is selected automatically. If not, DTS 5.1 is used.
- On:** DTS-ES 6.1 is used regardless of whether the source signal contains a DTS-ES flag. If the source signal contains a DTS-ES flag, DTS-ES Discrete (6.1) or DTS-ES Matrix (6.1) is selected automatically. If the source signal does not contain a DTS-ES flag, you can select DTS+Dolby EX, PL IIX Music, or DTS+Neo:6.
- Off:** DTS 5.1 is used for all DTS sources, even if a DTS-ES flag is present.

# Recording

This chapter explains how to record the selected input source to an AV component with recording capability, and how to record audio and video from two different sources.

## Recording the Input Source

You can record only to AV components that are connected to the TAPE OUT or VIDEO 1 OUT sockets. See pages 22–30 for information on connecting your AV components to the AV Receiver.

<b>1</b>	<p><b>Use the input selector buttons to select the AV component that you want to record.</b></p> <p>Audio signals from the selected input source are output by the VIDEO 1 OUT and TAPE OUT sockets.</p> <p>You can listen to the source while recording. The AV Receiver's VOLUME control has no effect on recording.</p>
<b>2</b>	<p><b>Start recording on the AV component connected to the TAPE OUT or VIDEO 1 OUT sockets.</b></p>
<b>3</b>	<p><b>Start playback on the source AV component.</b></p>

### Notes:

- You cannot record from AV components that are connected to the digital inputs. You must use analog connections.
- The surround effects produced by the surround and DSP listening modes cannot be recorded.
- You cannot record from an AV component that is connected to the multichannel input.
- If you select another input source while recording, that input source will be recorded instead.

## Recording from Different AV Sources

With this function you can record audio and video from different sources, allowing you to overdub audio onto your video recordings. This function takes advantage of the fact that when an audio-only input source (i.e., TAPE, TUNER, or CD) is selected, the video input source remains unchanged. For example, if you first select the VIDEO 3 input source, followed by the CD input source, you can watch the video from the VIDEO 3 input and listen to the audio from the CD input.

In the following example, audio from the CD player connected to the CD IN sockets, and video from the camcorder connected to the VIDEO 3 INPUT VIDEO socket are recorded by the VCR, which is connected to the VIDEO 1 OUT sockets.

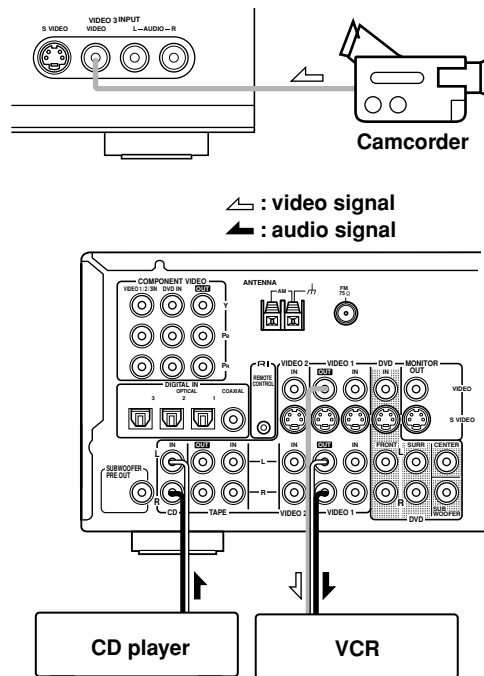

- Prepare the camcorder and CD player for playback.**
- Prepare the VCR for recording.**
- Press the [VIDEO 3] input selector button.**
- Press the [CD] input selector button.**  
This selects the CD player as the audio source, but leaves the camcorder as the video source.
- Start recording on the VCR and start playback on the camcorder and CD player.**  
The video from the camcorder and the audio from the CD player are recorded by the VCR.

# Advanced Function

## Using the Audio Adjust Functions

These functions only work with speaker set A. Audio Adjust provides various functions for adjusting the sound.

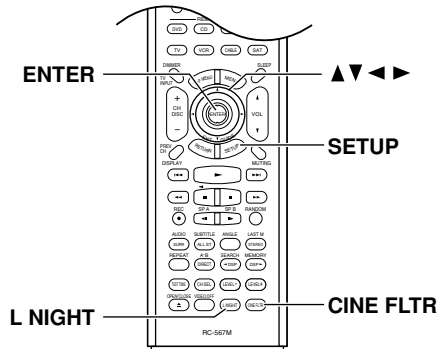

	<p><b>1</b> Press the [SETUP] button.</p>
	<p><b>2</b> Use the Up and Down [▲]/[▼] buttons to select "4. Audio Adjust," and then press the [ENTER] button.</p> <div style="border: 1px solid black; padding: 5px; width: fit-content; margin: 10px auto;">4. Audio Adjust</div>
	<p><b>3</b> Use the Left and Right [◀]/[▶] buttons to specify the settings.</p>
	<p><b>4</b> Press the Down [▼] button to select the next setting.</p>
<p><b>5</b></p>	<p>Repeat steps 3 and 4 to complete all settings.</p>
	<p><b>6</b> Press the [SETUP] button. Setup closes.</p>

The Audio Adjust functions are explained below.

### ■ Double Bass

The Double Bass function boosts the bass by feeding bass sounds from the front left and right channels to the subwoofer. To use this function, in the Speaker Configuration, the Subwoofer setting must be set to Yes and the Front setting must be set to Large (see page 32).

The Double Bass function works well with mono and 2-channel sources, including 96 kHz PCM.

**On:** Double Bass function on.

**Off:** Double Bass function off.

### ■ Late Night (Dolby Digital only)

With this function you can reduce the dynamic range of Dolby Digital material so that you can still hear quiet parts even when listening at low volume levels—ideal for watching movies late at night when you don't want to disturb anyone.

**Off:** Late Night function off.

**Low:** Small reduction in dynamic range.

**High:** Big reduction in dynamic range.

Note that the effect of the Late Night function depends on the Dolby Digital material that you are playing, and with some material there will be little or no effect.

This function is turned off when the AV Receiver is set to Standby.

**Tip:** You can also set this function by using the remote controller's [L NIGHT] button.

### ■ CinemaFILTER

With this function, you can soften the harshness, or brightness sometimes experienced with movie soundtracks, which are typically mixed for reproduction in a movie theater.

You can set the CinemaFILTER function to **On** or **Off**. The CinemaFILTER function can be used with the following listening modes: Dolby Digital, Dolby Digital EX, Dolby Pro Logic II Movie, Dolby Pro Logic IIx Movie, DTS, DTS-ES, DTS Neo:6 Cinema, DTS 96/24, DTS+Neo:6, and DTS+Dolby EX.

**Tip:** You can also set this function by using the remote controller's [CINE FLTR] button.

### Adjusting the DTS Neo:6 Music Mode

#### ■ Center Image

DTS Neo:6 derives a center-channel signal from stereo material, either analog or digital. In Music mode, the center speaker is intended to augment the left and right speakers, allowing them to faithfully reproduce the original stereo mix. For this reason, the center channel sound is not fully subtracted from the left and right channels. With this function, you can adjust the amount of subtraction depending on your room layout and personal preference.

## Advanced Function—Continued

**0 to 5:** Adjustable range.

When set to 5, nothing is subtracted from the left and right channels. When set to 0, the left and right channel levels are halved (–6 dB), making the center channel more dominant, particularly useful when the listener is off-center.

This function has no effect on the level of the center speaker.

### Adjusting the PL II or PL IIx Music Mode

The following Panorama, Dimension, and Center Width parameters can only be adjusted while the PL II Music or PL IIx Music listening mode is selected.

These parameters cannot be adjusted if you're using the Pro Logic IIx listening mode for 6.1-channel playback from a 5.1-channel source.

#### ■ Panorama

With this function, you can extend the front stereo image to the surround speakers to provide a “wraparound” effect, especially useful when not much sound is being output by the surround speakers.

#### ■ Dimension

With this function, you can move the soundfield backward or forward.

**0 to 6:** Adjustable range.

When set to 3, the soundfield is in the normal position. Choose a lower setting to move the soundfield forward. Choose a higher setting to move it backward.

If the stereo image is too wide, or there's too much surround information, try moving the soundfield forward to achieve a better balance. If the stereo image is too narrow, or it sounds almost like it's in mono, try moving the soundfield backward.

#### ■ Center Width

With Pro Logic II/Pro Logic IIx decoding, the center-channel signal is normally output by the center speaker. If a center speaker is not used, the decoder divides the center signal equally between the front left and right speakers, producing what's known as a “phantom” center. With this function you can choose to have the center-channel signal output by the center speaker only, by the front left and right speakers only (“phantom” center), or by a mix of the two.



**0 to 7:** Adjustable range.

When set to 0, the center-channel signal is output by the center speaker only. When set to 7, it's output by the front left and right speakers only (“phantom” center).

In home theaters, adding some width to the center channel can improve the balance between the center and front left and right speakers. Most stereo material will benefit from appropriate use of this function.

## Digital Input Signal Formats

The following table shows the display indicators for each supported digital signal format.

Format	Display
Dolby Digital	 D
DTS	
PCM	PCM

Normally, the AV Receiver detects the signal format automatically. However, if you experience either of the following issues when playing PCM or DTS material, you can set the signal format to PCM or DTS:

- If the beginnings of tracks from a PCM source are cut off, try setting the format to PCM.
- If noise is produced when fast forwarding or reversing a DTS CD or LD, try setting the format to DTS.

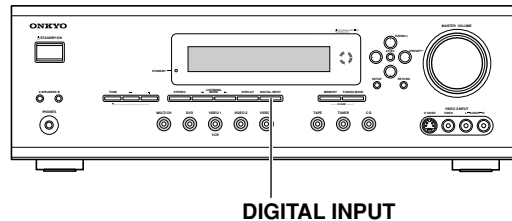

- 1 Press and hold the AV Receiver's [DIGITAL INPUT] button on the front panel for about 3 seconds.**
- 2 While “Auto” is displayed (about 3 seconds), use the Left and Right [◀]/[▶] buttons to select: PCM, DTS, or Auto.**  
**DTS or PCM;** the DTS or PCM indicator, depending on which format you have set, flashes, and only signals in that format are output. Digital signals in other formats are ignored.  
**Auto (default);** the format is detected automatically. If no digital input signal is present, the corresponding analog input is used instead.

# Advanced Setup

Advanced setup cannot be set while headphones are connected, Speaker B is on, or the multi channel input is being used.

## Crossover Frequency

To get the best bass performance from your speaker system, you need to set the crossover frequency according to the size and frequency response of your subwoofer and other speakers (front, center, and surround).

**1**  **Press the [AMP] button followed by the [SETUP] button on the remote controller.**

**2**  **Use the Up and Down [▲]/[▼] buttons to select "1. SP Config," and then press the [ENTER] button.**

1. SP Config

**3**  **Use the Down [▼] button to select "Crossover," and then use the Left and Right [◀]/[▶] buttons to select a crossover frequency.**

Choose a crossover frequency suitable for your setup.

**If you're using a subwoofer,** choose a crossover frequency based on the diameter of your front speakers.

**If you're not using a subwoofer,** use the diameter of the first speaker that you specified as Small in steps 4 through 7 in the "Speaker configuration" setting.

Speaker cone diameter	Crossover frequency
Over 8 in. (20 cm)	60Hz
6-1/2 to 8 in. (16–20 cm)	80Hz
5-1/4 to 6-1/2 in. (13–16 cm)	100Hz (default)
3-1/2 to 5-1/4 in. (9–13 cm)	120Hz
Under 3-1/2 in. (9 cm)	150Hz

**4**  **Press the [SETUP] button.**  
Setup closes.

**Note:**

- For a more accurate setting, look up the frequency response in the manuals supplied with your speakers and set accordingly. In addition, listen to some music that you know well and choose a higher crossover frequency if you think there's not enough sound coming from the subwoofer; a lower setting if you think there's too much.

## Speaker Distance

To get the best from surround sound, it's important that the sound from each speaker reaches the listener at the same time. To achieve this, you need to specify the distance from each speaker to the listening position.

**1** **Measure and make a note of the distance from each speaker to the listening position.**

**2**  **Press the [AMP] button followed by the [SETUP] button on the remote controller.**

**3**  **Use the Up and Down [▲]/[▼] buttons to select "2. SP Distance," and then press the [ENTER] button.**

2. SP Distance



**4**  **Use the [DISPLAY] button to switch ft or m.**

**ft:** distances in feet. Can be set from 1 to 30 feet in 1-foot steps.

**m:** distances in meters. Can be set from 0.3 to 9 meters in 0.3-meter steps.



## Advanced Setup—Continued

<b>5</b>	 <p>Use the Left and Right [◀]/[▶] buttons to specify the distance for "Front," then press the Down [▼] button to select the next speaker.</p>
<b>6</b>	<p><b>Repeat step 5 for all speakers.</b></p> <p><b>Note:</b> Speakers that you set to No or None in the Speaker Configuration (page 32) cannot be selected.</p>
<b>7</b>	 <p>Press the [SETUP] button. Setup closes.</p>

**Notes:**



- The Center and Subwoofer distances can be set up to 5 ft. (1.5 m) more or less than the Front distance. For example, if the Front distance is set to 20 ft. (6 m), the Center and Subwoofer distances can be set between 15 and 25 ft. (4.5 and 7.5 m).
- The SurrRight, Surr Left, and Surr Back distances can be set up to 5 ft. (1.5 m) more or 15 ft. (4.5 m) less than the Front distance. For example, if the Front distance is set to 20 ft. (6 m), the SurrRight, Surr Left, and Surr Back distances can be set between 5 and 25 ft. (1.5 and 7.5 m).

### Speaker Levels

With this function you can adjust the volume of each speaker so that all speakers can be heard equally at the listening position.

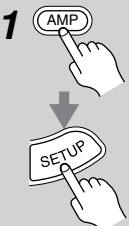
**Speaker levels cannot be set while the AV Receiver is muted.**

<b>1</b>	 <p>Press the [AMP] button followed by the [SETUP] button on the remote controller.</p>
----------	----------------------------------------------------------------------------------------------------------------------------------------------------------------------------

<b>2</b>	 <p>Use the Up and Down [▲]/[▼] buttons to select "3. Level Cal," and then press the [ENTER] button.</p> <p>A pink noise test tone is output by the front left speaker.</p> <div style="border: 1px solid black; padding: 5px; text-align: center; font-family: monospace;">3. Level Cal</div>
<b>3</b>	<p>Turn up the volume so that you can hear the test tone sufficiently.</p> <p>While each speaker outputs the test tone, its name appears on the display, as shown.</p> <div style="border: 1px solid black; padding: 5px; text-align: center; font-family: monospace;">Left : 0dB</div>
<b>4</b>	 <p>Use the Left and Right [◀]/[▶] buttons to adjust the speaker level, and use the Down [▼] button to select the next speaker.</p> <p>The level can be adjusted from -12 to +12 dB in 1 dB steps (-15 to +12 dB for the subwoofer).</p>
<b>5</b>	<p>Repeat step 4 so that the level of the test tone from each speaker is the same.</p> <p>Speakers that you set to No or None in the Speaker Configuration (page 32) do not output the test tone.</p>
<b>6</b>	 <p>Press the [SETUP] button. Setup closes.</p> <p>Don't forget to turn down the volume if you turned it up while setting the levels.</p>

**Notes:**

- This procedure can also be performed by using the remote controller. First press the [TEST TONE] button to output the test tone. Use the [LEVEL-] and [LEVEL+] buttons to adjust the levels, and use the [CH SEL] button to select the speakers.

## Controlling Other Components

You can use the AV Receiver's remote controller (RC-567M/RC-569M) to control your other AV components, including those made by other manufacturers. To do this you first need to enter the appropriate remote control code for your DVD player, TV, VCR, cable receiver, or satellite receiver. Then you need to select the corresponding remote controller mode (see page 10).

By entering the appropriate remote control code, the [CD], [MD], and [CDR] mode buttons can also be used with other manufacturer's components (e.g., DVD, TV, VCR, satellite or cable receiver).

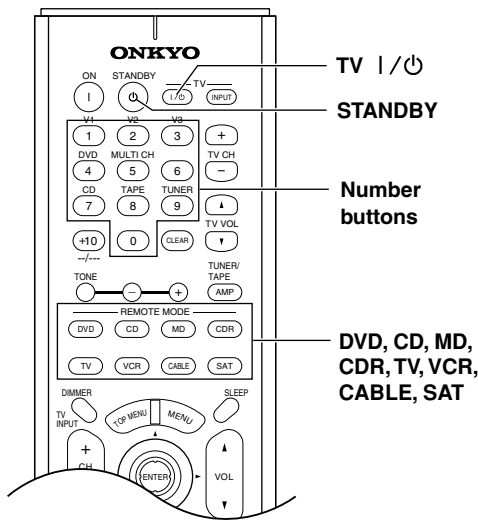

### Entering Remote Control Codes

Entering the appropriate remote control code for your TV, VCR, and so on will allow you to control it with the AV Receiver's remote controller. You'll need to perform this procedure for each component that you want to control.

- 1** Look up the remote control code for your component.  
See "Remote Control Codes" on page 51.
- 2** While holding down the [DVD], [TV], [VCR], [CABLE], [SAT], [CD], [MD], or [CDR] mode button, press the [STANDBY] button.
- 3** Within 30 seconds, use the number buttons to enter the 4-digit remote control code.

### 4 Select the remote controller mode, point the remote controller at the component, and check its operation.

Remote controller buttons that can be used in DVD mode are shown on page 12. Those that can be used with the TV, VCR, CABLE, and SAT modes are shown on page 55.

If the remote controller works as expected, the code has been entered correctly. If not, try again or try another code.

### Codes for Onkyo DVD Players

The remote control code for an Onkyo DVD player depends on whether it's connected via **RI**, as follows:

- 5001:** Use this code if you've connected an **RI** cable and an analog audio cable (RCA) to your DVD player. This is the default setting, so if you're using **RI**, you don't need to change anything. Point the remote controller at the AV Receiver to operate the DVD player.
- 5002:** Use this code if your DVD player doesn't have an **RI** socket, or you're not using **RI**. Point the remote controller at the DVD player to operate it.

### Resetting the [DVD], [CD], [MD] or [CDR] Mode Button

By default, the [DVD], [CD], [MD] & [CDR] mode buttons are preprogrammed with remote control codes for controlling Onkyo components connected via **RI**. If you've entered another code for a button and now want to return to its default, perform the following procedure.

- 1** While holding down the mode button that you want to reset, press the TV [I/O] button.  
Release both buttons and wait two seconds.
- 2** Press the mode button again.  
The mode button is reset.

### Resetting the Remote Controller

This section explains how to reset the remote controller to its default settings.

- 1** While holding down the [AMP] mode button, press the [STANDBY] button.  
Release both buttons and wait five seconds.
- 2** Press the [AMP] mode button again.  
The remote controller is reset.

## Controlling Other Components—Continued

### Remote Control Codes

When two or more codes are given, try each one in turn, and choose the one that works best.

Depending on the manufacturer and component, the remote controller may not work as expected.

DVD (DVD player)	
Manufacturer	Control code
Aiwa	5010
Akai	5019
Apex	5015, 5016
CyberHome	5027
Denon	5017, 5020
GE	5003
Hitachi	5009
Integra	5001, 5002
Integra Research	5001, 5002
JVC	5023
Kenwood	5017
Magnavox	5004, 5021
Marantz	5025, 5026
Mitsubishi	5005
Onkyo	5001, 5002
Panasonic	5011, 5017, 5020
Philips	5004, 5021, 5028
Pioneer	5006
Proscan	5003
RCA	5003
Sanyo	5012
Sony	5007, 5013, 5018, 5029
Technics	5020
Thomson	5022, 5024
Toshiba	5008, 5021
Xbox	5022
Yamaha	5020
Zenith	5014, 5021

SAT (satellite receiver)	
Manufacturer	Control code
Alba	4014, 4017, 4025, 4027
Allsat	4015, 4027
Alltech	4022, 4025
Amstrad	4013, 4019, 4025, 4030, 4031
Anglo	4025
Ankaro	4025
Antron	4017
Apollo	4017
Arcon	4016
Armstrong	4013
Asat	4016
Astra	4013, 4016, 4024
Astro	4019, 4020
AudioTon	4015
Bush	4012, 4014
Condor	4024

SAT (satellite receiver)	
Manufacturer	Control code
Conrad	4024
Cosat	4015, 4023
Crown	4013
Daewoo	4016, 4017, 4025
Diamond	4022
Dishnet	4008
Dual	4016
Echostar	4010, 4018, 4025
Einhell	4013, 4017, 4025
Elta	4015, 4017
Engel	4025
Eurosat	4013, 4022
Eurosky	4013, 4024
Eurostar	4024
Fagor	4015, 4023
Ferguson	4012
Fidelity	4030
Fracarro	4017
FTE	4025, 4030
Fuba	4017
Galaxis	4015, 4023
GE	4001, 4002
General Instruments	4003
GMI	4013
Grundig	4021, 4029, 4031
Hinari	4017
Hirschmann	4019, 4035
Hitachi	4036, 4037
Hughes Network Systems	4011
Huth	4013, 4015, 4024
Imperial	4014
Intertronic	4013
Intervision	4015, 4023, 4024
Johansson	4015
JVC	4009, 4021
Kathrein	4025
Kolon	4017
K-SAT	4025
Kyostar	4017
Lasat	4013, 4020, 4024
Lenco	4016, 4017, 4025
Lennox	4023
Loewe	4013
Lorenzen	4024
Macab	4022
Manhattan	4015, 4020, 4023
Maspro	4021, 4025
Matsui	4021
Mediamarkt	4013
Medion	4025
Metronic	4013, 4017, 4020
Micro Technology	4025
Minerva	4021
Morgan's	4013, 4015, 4025
Mysat	4025
Neuhaus	4019, 4023, 4024, 4025
Neusat	4025

SAT (satellite receiver)	
Manufacturer	Control code
Nikko	4013, 4025, 4027
Nokia	4033
Nordmende	4017, 4020
Oceanic	4022
Octagon	4016, 4017
Okano	4013
Optex	4015, 4023
Orbit	4016
Orbitech	4017, 4019
Pace	4012, 4026, 4031
Pacific	4022
Palladium	4013, 4017, 4021
Palsat	4019
Panasonic	4006, 4031
Panda	4024
Philips	4021, 4029
Phonotrend	4015, 4023
Predki	4017
Premier	4023
Primestar	4007
Proscan	4001, 4002
Protek	4022
Pye	4021
Quelle	4024
Radix	4035
RCA	4001, 4002
Roadster	4025
Rover	4025
Saba	4014, 4020, 4024, 4027
Samsung	4017
Satcom	4024
SatPartner	4017, 4020, 4027, 4030
Schneider	4029
Sede Electronique	4017
Seemann	4013
SEG	4017, 4028
Seleco	4015, 4023
Skymaster	4025, 4034
Skyvision	4015
Sony	4005, 4031
Strong	4016, 4017, 4020
Sunstar	4013
Techniland	4015, 4023
TechniSat	4019
Teco	4013, 4016
Teleciel	4027
Telefunken	4017
Teleka	4013
Telemaster	4020
Telewire	4015, 4023
Tensai	4016
Thomson	4024, 4025
Thorens	4022
Tonna	4015, 4023, 4025
Toshiba	4004
Triasat	4019

## Controlling Other Components—Continued

<b>SAT (satellite receiver)</b>	
Manufacturer	Control code
Tristar	4016
Unisat	4013
Universum	4021, 4024
Vortec	4017
Wela	4025
Zehnder	4020
Zenith	4032

<b>CBL (cable receiver)</b>	
Manufacturer	Control code
ABC	3001, 3002, 3021
Archer	3006
Cabletime	3028, 3032
Cableview	3004
Contec	3009
Eastern	3010
GE	3001, 3002
Gemini	3011
General Instruments	3002, 3022
Grundig	3031
Hamlin	3012
Hitachi	3002
Jerrold	3002, 3011, 3013, 3021, 3022, 3023, 3026
Magnavox	3014
Memorex	3015
Movie Time	3016
NEC	3003
Nokia	3033
NSC	3016
Oak	3009
Panasonic	3020
Philips	3007, 3008, 3014
Pioneer	3017, 3024
Proscan	3001, 3002
RCA	3004, 3020, 3022
Realistic	3006
Sagem	3034
Salora	3029
Samsung	3017
Signature	3002
Sprucer	3020
Standard Component	3018
Starcom	3011, 3021
Stargate	3011
Tele+1	3030
Tocom	3013
United Cable	3021, 3023
Universal	3005, 3006
Videoway	3025
View Star	3009, 3014, 3016
Zenith	3019

<b>VCR</b>	
Manufacturer	Control code
Aiwa	2012, 2046, 2047
Akai	2003, 2004, 2022
Alba	2033, 2041, 2044, 2045, 2047
Anitech	2033
ASA	2034
Baird	2036
Bell & Howell	2007
Blaupunkt	2039, 2042
Bush	2033, 2041, 2044, 2045, 2047
Canon	2010, 2011
Carver	2014
Cimline	2033
Citizen	2008, 2009
Colortyme	2005
Craig	2008
Crown	2033
Curtis Mathes	2001, 2005, 2008, 2009, 2010, 2011, 2023, 2026
Cyrus	2034
Daewoo	2012
Dansai	2033
Decca	2034
Dimensia	2001, 2026
Dumont	2034, 2036, 2037
Elcotech	2033
Emerson	2003, 2010, 2012, 2022
ESC	2043
Ferguson	2035
Finlandia	2034, 2036
Finlux	2034, 2036, 2037
Firstline	2033, 2041
Fisher	2007, 2030, 2036
Fuji	2004, 2010, 2024
Funai	2012
Garrard	2012
GE	2001, 2002, 2008, 2010, 2011, 2023, 2025, 2026
GEC	2034
GoldHand	2033
GoldStar	2005, 2009
Goodmans	2031, 2033
Gradiente	2012
Graetz	2036, 2043
Granada	2030, 2034, 2036
Grandin	2033
Grundig	2029, 2033, 2034, 2039, 2040, 2042, 2044
Harman Kardon	2005
HCM	2033, 2044
Hinari	2028, 2033, 2043, 2044, 2047
Hitachi	2013, 2021, 2025, 2028, 2037, 2038, 2043
Ingersol	2028
Interfunk	2034
ITT	2030, 2036, 2043, 2048
JC Penney	2005, 2006, 2007, 2008, 2010, 2011, 2013, 2014, 2021

<b>VCR</b>	
Manufacturer	Control code
Jensen	2013
JVC	2005, 2006, 2007, 2009, 2032, 2035, 2040, 2048
Kaisui	2033
Kendo	2041, 2046
Kenwood	2005, 2006, 2007, 2009
Kodak	2010
Loewe	2028, 2034
Logik	2028, 2043
Luxor	2030, 2031, 2036
Magnavox	2010, 2011, 2014, 2019, 2020
Marantz	2005, 2006, 2007, 2009, 2010, 2014, 2031, 2034
Matsui	2028, 2041, 2046, 2047
Matsushita	2010
Memorex	2007, 2008, 2010, 2012, 2019, 2030, 2036
Metz	2039
MGA	2022
Minerva	2039
Minolta	2013, 2021
Mitsubishi	2013, 2022, 2032, 2034
Motorola	2010
MTC	2008
Multitech	2008, 2012, 2033
NEC	2005, 2006, 2007, 2009, 2032
Neckermann	2034
Nesco	2033
NOBLEX	2008
Nokia	2030, 2036, 2043
Nordmende	2048
Okano	2046
Olympus	2010
Optonica	2017
Orion	2028, 2041, 2045, 2046, 2047
Osaki	2033
Otto Versand	2034
Palladium	2033
Panasonic	2010, 2011, 2042
Pentax	2013, 2021, 2025, 2037
Pentax Research	2009
Philco	2010, 2011, 2014
Philips	2010, 2014, 2017, 2034, 2048
Phonola	2034
Pioneer	2006, 2013, 2032, 2034
Proline	2044
Proscan	2001, 2002, 2026
Pye	2034
Quasar	2010, 2011
Quelle	2034
Radio Shack	2017
Radio Shack/ Realistic	2007, 2008, 2010, 2011, 2012, 2017
Radiola	2034

## Controlling Other Components—Continued

VCR	
Manufacturer	Control code
RCA	2001, 2002, 2003, 2008, 2010, 2013, 2021, 2023, 2025, 2026, 2027
Realistic	2007, 2008, 2010, 2011, 2012, 2017
Rex	2048
Roadstar	2033, 2043
Runco	2019
Saba	2040, 2048
Saisho	2028, 2041
Salora	2030
Samsung	2008, 2043, 2049
Sansui	2006, 2032
Sanyo	2007, 2008, 2030, 2036
Saville	2047
SBR	2034
Schaub Lorenz	2036
Schneider	2033, 2034
Scott	2015
Sears	2007, 2010, 2013, 2021
SEG	2043
SEI	2028, 2034
Sharp	2016, 2017, 2031
Shintom	2004, 2033, 2036
Shorai	2028
Siemens	2034, 2036, 2039
Singer	2010
Sinudyne	2028, 2034
Sonorol	2030, 2031
Sony	2004, 2018, 2024
STS	2010, 2021
Sunkai	2046
Sylvania	2010, 2011, 2012, 2014
Symphonic	2012
Tandy	2007
Tatung	2034
Teac	2012
Technics	2010, 2042
Teknika	2010, 2012
Telefunken	2048
Thomson	2048
Thorn	2035, 2036
Toshiba	2013, 2015, 2022, 2034, 2048
Totevision	2008
Uher	2043
Unitech	2008
Universum	2034, 2039, 2043
Vector Research	2005, 2006
Video Concepts	2005, 2006, 2022
Wards	2008, 2010, 2012, 2013, 2017, 2021, 2027
XR-1000	2010, 2012
Yamaha	2005, 2006, 2007, 2009
Yoko	2043
Zenith	2004, 2019, 2024

TV	
Manufacturer	Control code
Admiral	1026, 1040, 1062
Akai	1002, 1067
Akura	1045
Alba	1035, 1043
Amplivision	1063
Amstrad	1035, 1067
Amtron	1009
Anam National	1003, 1009
Anitech	1035
AOC	1004, 1005, 1006
Arc en Ciel	1066
Arcam	1063
ASA	1040
Audiovox	1009
Autovox	1040, 1068
Baird	1069
Bang & Olufsen	1040
Baur	1036, 1054, 1055, 1058, 1059, 1068
Beko	1052
Bell & Howell	1010, 1017
Binatone	1063
Blaupunkt	1041, 1042, 1044, 1058, 1059
Boots	1063
Brionvega	1040
Bruns	1040
BSR	1048
Bush	1035, 1043, 1048, 1050, 1053, 1057
Cascade	1035
Celebrity	1002
Century	1040
Cimline	1035, 1043
Citizen	1004, 1006, 1009, 1017, 1022, 1025
Clatronic	1052
Colortyme	1004, 1006
Condor	1052
Contec	1035
Contec/Cony	1007, 1009
Continental Edison	1066
Craig	1009
Crosley	1040
Crown	1009, 1014, 1035, 1052
Curtis Mathes	1001, 1004, 1006, 1010, 1017, 1022, 1025, 1034
Daewoo	1004, 1005, 1006, 1025, 1035, 1053
Daytron	1004, 1006, 1025, 1035
Decca	1067
Dimensia	1001, 1034
Dixi	1035
Dual	1057, 1068
Dumont	1004, 1039, 1040
Electroband	1002
Electrohome	1002, 1003, 1004, 1006, 1008
Elta	1035

TV	
Manufacturer	Control code
Emerson	1004, 1006, 1007, 1009, 1010, 1017, 1025, 1027, 1029, 1033, 1040, 1070
Envision	1004, 1006
Erres	1037
Europhon	1067
Fidelity	1068
Finlux	1039, 1040, 1067
Firstline	1035, 1043, 1048, 1049, 1063
Fisher	1010, 1017, 1052, 1063, 1068
Formenti	1040
Frontech	1045, 1062
Fujitsu	1070
Funai	1009, 1045, 1048, 1070
GE	1001, 1003, 1004, 1006, 1011, 1012, 1019, 1034
GEC	1038, 1063, 1067, 1069
Geloso	1035
Genexxa	1062
GoldStar	1004, 1005, 1006, 1007, 1008, 1025, 1047, 1063
Goodmans	1043, 1053, 1063
Gorenje	1052
Graetz	1062, 1069
Granada	1063, 1067
Grundig	1039, 1041, 1042, 1058, 1059, 1064
Hallmark	1004, 1006
Hanseatic	1060, 1068
Hantarex	1067
HCM	1035
Hinari	1035, 1043
Hitachi	1004, 1006, 1007, 1013, 1027, 1038, 1062, 1063, 1069
Huanyu	1053
ICE	1045, 1063
Imperial	1052
Infinity	1014
Inno Hit	1056, 1067
Interfunk	1055, 1062, 1066, 1069
Intervision	1045, 1063
ITT	1062, 1068, 1069
JBL	1014
JC Penney	1001, 1004, 1005, 1006, 1011, 1012, 1016, 1019, 1022, 1025, 1034
Jensen	1004, 1006
JVC	1007, 1012, 1013, 1015, 1033
Kaisui	1035, 1063
Kapsch	1062, 1069
Kathrein	1060
Kawasho	1002, 1004, 1006
Kendo	1043
Kenwood	1004, 1006, 1008
Kloss Novabeam	1009
Korting	1040
KTV	1009, 1025
LG	1005

## Controlling Other Components—Continued

TV	
Manufacturer	Control code
Loewe	1014, 1040, 1055
Luxman	1004, 1006
LXI	1001, 1006, 1010, 1014, 1016, 1017, 1034
M Electronic	1035, 1053, 1062, 1063
Magnadyne	1040, 1067, 1068
Magnafon	1067
Magnavox	1004, 1006, 1008, 1014, 1018, 1020
Marantz	1004, 1006, 1014, 1060
Matsui	1035, 1043, 1048, 1050, 1063, 1064, 1067, 1068
Megatron	1006
Memorex	1005, 1006, 1010, 1017, 1035
Metz	1040, 1051, 1058
MGA	1004, 1005, 1006, 1008
Minerva	1039, 1058, 1059, 1064
Mitsubishi	1004, 1005, 1006, 1008, 1040, 1055, 1058
Mivar	1047, 1056, 1067
Motorola	1003, 1026
MTC	1004, 1005, 1006, 1022, 1055
Multitech	1009, 1035
NAD	1006, 1016
NEC	1003, 1004, 1005, 1006
Neckermann	1040, 1041, 1054, 1059, 1060
Nikkai	1045
Nikko	1006
Oceanic	1062
Onwa	1009
Optonica	1021, 1026
Orion	1029, 1043, 1048, 1049, 1050, 1067, 1068
Osaki	1045, 1063
Otto Versand	1036, 1041, 1043, 1054, 1055, 1058, 1059, 1060, 1063
Palladium	1052
Panasonic	1003, 1012, 1014, 1031, 1044, 1046, 1051, 1061, 1062, 1069
Pathe Marconi	1066
Philco	1003, 1004, 1005, 1006, 1007, 1008, 1014, 1018, 1040
Philips	1003, 1004, 1007, 1008, 1014, 1018, 1019, 1020, 1037, 1038, 1040, 1053, 1059, 1060
Phoenix	1040
Phonola	1037, 1040
Pioneer	1004, 1006, 1027, 1062
Portland	1004, 1005, 1006, 1025
Price Club	1022
Prism	1012
Profex	1035
Proline	1049
Proscan	1001, 1034
Protech	1035, 1045, 1063
Proton	1004, 1006, 1007
Pye	1037

TV	
Manufacturer	Control code
Quasar	1003, 1012, 1031
Quelle	1036, 1039, 1054, 1055, 1058, 1059, 1068
Radio Shack	1010, 1017, 1034
Radio Shack/ Realistic	1001, 1004, 1006, 1007, 1009, 1010, 1017, 1021, 1025
Radiola	1037
Radiomarelli	1040, 1067
RCA	1001, 1003, 1004, 1005, 1006, 1008, 1027, 1034
Realistic	1010, 1017, 1034
Rex	1045, 1062
RFT	1040
Roadstar	1035, 1045
Saba	1040, 1062, 1066, 1069
Saisho	1035, 1043, 1045, 1067, 1068
Salora	1062
Sambers	1056, 1067
Sampo	1004, 1006, 1025
Samsung	1004, 1005, 1006, 1007, 1008, 1022, 1025, 1035, 1045, 1047, 1052, 1056, 1060, 1063, 1065
Sansui	1029
Sanyo	1004, 1010, 1017
SBR	1037, 1038
Schaub Lorenz	1069
Schneider	1068
Scott	1004, 1006, 1007, 1009, 1070
Sears	1001, 1004, 1006, 1008, 1010, 1015, 1016, 1017, 1028, 1034, 1070
SEG	1045, 1063
SEI	1036, 1040, 1048, 1067, 1068
Seleco	1062
Sharp	1004, 1006, 1007, 1021, 1023, 1025, 1026
Shorai	1048
Siarem	1040, 1067
Siemens	1041, 1042, 1058, 1059
Singer	1040
Sinudyne	1036, 1040, 1043, 1067, 1068
Solavox	1062
Sonoko	1035
Sonolor	1062
Sony	1002, 1030, 1032, 1036, 1054
Soundesign	1004, 1006, 1009, 1070
Starlite	1009
Stern	1062
Sunkai	1043, 1048, 1049, 1050
Sylvania	1004, 1006, 1008, 1014, 1018, 1020
Symphonic	1009, 1028
Tandy	1026, 1062, 1063
Tashiko	1038, 1063
Tatung	1003, 1063, 1067
Tec	1063

TV	
Manufacturer	Control code
Technics	1012, 1044, 1061
Techwood	1004, 1006, 1012
Teknika	1004, 1005, 1006, 1007, 1009, 1022, 1025, 1031, 1070
Teleavia	1066
Telecaption	1024
Telefunken	1066
Teletex	1035
Teleton	1063
Tensai	1048
Thomson	1066
Thorn	1054, 1055, 1058
Toshiba	1010, 1016, 1017, 1022, 1024, 1039
Totevision	1025
Triumph	1067
Universal	1011, 1019
Universum	1045, 1052, 1058
Voxson	1040, 1062
Waltham	1063
Wards	1001, 1004, 1005, 1006, 1008, 1011, 1014, 1018, 1019, 1020, 1021, 1034, 1070
Watt Radio	1068
Wega	1040
Yamaha	1004, 1005, 1006, 1008
Yoko	1045, 1063
Zenith	1004

## Controlling Other Components—Continued

1. Use the mode buttons to select the appropriate remote controller mode.
2. Point the remote controller at your AV component, and use the following buttons (you must enter the appropriate remote control code first).

### Controlling a TV

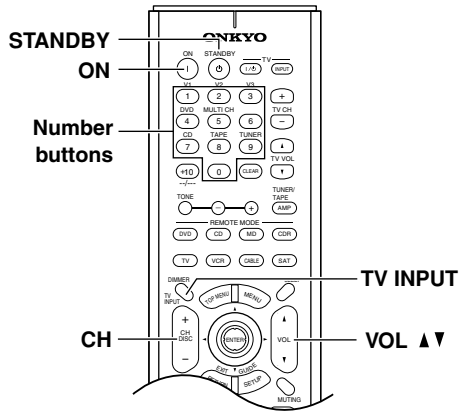

[ON], [STANDBY]	Set the TV to On or Standby
Number buttons	Enter numbers
[CH +/-]	Selects channels on the TV
[TV INPUT]	Selects the TV's VCR input
VOL [▲]/[▼]	Adjusts the TV's volume

In addition to these buttons, the remote controller has dedicated buttons for controlling a TV, which can be used regardless of which remote controller mode is currently selected (see page 15).

### Controlling a Cable Receiver

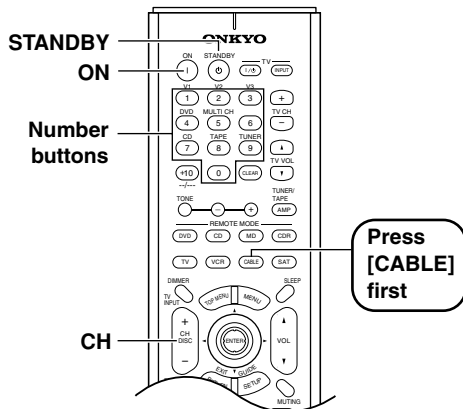

[ON], [STANDBY]	Set the cable receiver to On or Standby
[CH +/-]	Select cable channels
Number buttons	Enter numbers

### Controlling a VCR

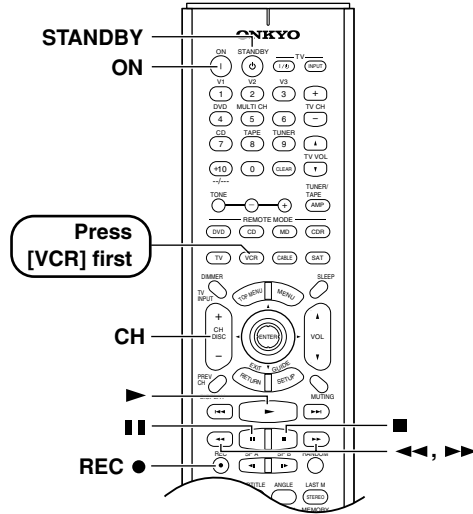

[ON], [STANDBY]	Set the VCR to On or Standby
[CH +/-]	Selects channels on the VCR
[▶]	Play
[■]	Stop
[◀◀]	Rewind
[▶▶]	Fast forward
[  ]	Pause
REC [●]	Record

### Controlling a Satellite Receiver

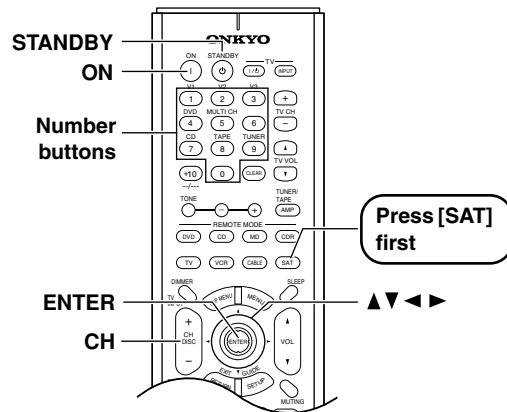

[ON], [STANDBY]	Set the satellite receiver to On or Standby
[CH +/-]	Select satellite channels
[▲]/[▼]/[◀]/[▶]	Select menu items
[ENTER]	Confirm selection
Number buttons	Enter numbers

# Troubleshooting

	Symptom	Possible cause	Remedy	
<b>Power</b>	<b>The AV Receiver shuts down immediately after being turned on?</b>	The amp protection system has been activated.	Contact your Onkyo dealer.	
	<b>Audio</b>	<b>There's no sound coming from the speakers?</b>	The AV Receiver is muted and the MUTING indicator is on.	Unmute the AV Receiver (page 39).
The AV Receiver is not connected properly.			Make sure that all audio connecting plugs are pushed in all the way. And make sure that the inputs and outputs of all components are connected properly (page 20).	
			If your turntable doesn't have a built-in phono preamp, you must connect one between your turntable and the AV Receiver.	
			If your turntable uses an MC cartridge, you must use a compatible phono preamp.	
The speaker cables are not connected properly.			Make sure that the polarity of the speaker cables is correct and that the bare wires are in contact with metal part of each speaker terminal (page 17).	
The wrong input source is selected.			Select the correct input source (page 34).	
A pair of headphones are connected.			Disconnect the headphones (page 39).	
The input signal format is set to PCM or DTS.			Set the input signal format to Auto (page 47).	
The volume is set at minimum.			Turn up the volume (page 34).	
The speakers are configured incorrectly.			Specify which speakers are connected (page 32), the speaker distances (page 48) and adjust the individual speaker levels (page 49).	
The source component is not outputting digital audio.			Check the digital audio output setting on the connected device. On some games consoles, such as those that support DVD, the default setting is off.	
A compatible digital audio format is not selected on the source component.			With some DVD-Video discs, you need to select an audio output format from a menu.	
<b>The center speaker is not working or is very quiet?</b>			The Stereo, Direct, Pure Audio, or Orchestra listening mode is selected.	The center speaker is not used with these modes (page 42).
			The level of the center speaker is set at minimum.	Check the volume of the center speaker (page 49).
	The Center setting is set to None in the Speaker Configuration.	Check the Center setting in the Speaker Configuration (page 32).		
<b>Only the center speaker is working?</b>	You're listening to a mono sound source (e.g., TV or AM broadcast) and the PL II/PL IIX Movie or PL II/PL IIX Music listening mode is selected, so the sound is concentrated in the center speaker.	Select another listening mode (page 42).		
<b>The surround speakers are not working?</b>	Selected listening mode doesn't use surround speakers.	When the Stereo, Direct, or Pure Audio listening mode is selected, the surround speakers produce no sound (page 42).		
	Surround speaker output depends on the source material, and some material may not use the surround speakers much.			
	The level of the surround speaker is set at minimum.	Check the volume of the surround speaker (page 49).		
	The Surround setting is set to None in the Speaker Configuration.	Check the Surround setting in the Speaker Configuration (page 32).		



## Troubleshooting—Continued

	Symptom	Possible cause	Remedy
Audio	<b>The surround back speakers produce no sound?</b>	The level of the surround back speaker is set at minimum.	Check the volume of the surround back speaker (page 49).
		The Surround Back setting is set to None in the Speaker Configuration.	Check the Surround Back setting in the Speaker Configuration (page 32).
		The selected listening mode doesn't use the surround back speakers.	Select another listening mode. See page 42 for information on listening modes.
		Surround speaker output depends on the source material, and some material may not use the surround speakers much.	If you're playing a Dolby Digital EX or DTS-ES source, make sure that the Dolby Digital/DTS setting is set to On (page 44).
	<b>A low-frequency noise or hum can be heard?</b>	The audio connecting cables at the rear of the AV Receiver are too close to the power cord.	Untangle the audio cables and position them as far away as possible from the power cord.
	<b>The sound is too bright or harsh and the high range is not clear?</b>	The treble is set too high.	Adjust the treble (page 38).
<b>The subwoofer is not working or is very quiet?</b>	The Subwoofer setting is set to No in the Speaker Configuration.	Check the Subwoofer setting in the Speaker Configuration (page 32).	
	The volume of the subwoofer is set at minimum.	Check the volume of the subwoofer (page 49, 35).	
	Speaker set A is turned off. The subwoofer output does not work while only speaker set B is on.	Turn on speaker set A.	
Video	<b>There's no picture on the TV?</b>	The Pure Audio listening mode is selected.	When this mode is selected, the display and the internal video circuits are all turned off and no video signals are output.
		The TV's input selector is set incorrectly.	Select the correct input on the TV (i.e., the input to which the AV Receiver is connected).
		The video input and output are different formats.	The AV Receiver doesn't convert between video formats. It works as a video signal switcher. Composite video input signals are output only by composite video outputs. S-Video input signals are output only by S-Video outputs. And component video input signals are output only by component video outputs.
Remote controller	<b>The buttons on the AV Receiver work OK but those on the remote controller don't?</b>	The wrong remote controller mode is selected.	Select the correct mode (page 10).
		The batteries are installed incorrectly.	Check the batteries and correct as necessary (page 9).
		You're not pointing the remote controller at the AV Receiver's remote sensor.	Point the remote controller at the AV Receiver's remote sensor (page 9).
	<b>Can't use the remote controller with other AV components?</b>	You've connected a MiniDisc recorder or CD recorder to the AV Receiver but haven't changed the TAPE/MD/CDR display.	Press and hold the [TAPE] input selector button until MD or CDR, as appropriate, appears on the display.
		The wrong remote control code has been entered.	If more than one code is listed, try each one (page 50). With some AV components, certain buttons may not work as expected and some may not work at all.
		You're pointing the remote controller at the wrong AV component.	To control a component connected via <b>RI</b> , point the remote controller at the AV Receiver. To control a component that's not connected via <b>RI</b> , point the remote controller at that component (page 50)
		You've made an <b>RI</b> connection but not an analog audio connection (RCA).	To use <b>RI</b> , you must make an <b>RI</b> connection and an analog audio connection (RCA) between the component and AV Receiver, even if they are connected digitally (page 30).

## Troubleshooting—Continued

	Symptom	Possible cause	Remedy
Tuner	<b>Reception is noisy, intermittent, and the FM STE-REO indicator flashes?</b>	You're too far away from the transmitter. Or, your FM antenna is in the wrong position or pointing in the wrong direction. Or, the station's signal strength is poor.	Use the [TUNING MODE] button to select Manual Tuning mode, and tune the station in mono (page 36). Adjust the position, height, and direction of your FM antenna. Install an outdoor FM antenna, preferably one with many elements. Installing an outdoor antenna is a specialist job, so contact your nearest dealer for advice (page 19).
	<b>Reception is hindered by a crackling noise?</b>	Interference is being caused by fluorescent lights being turned on or off or by passing cars.	Install an outdoor antenna as far away as possible from nearby roads. Adjust the position or direction of your outdoor antenna. Move your antenna as far away as possible from fluorescent lights.
	<b>AM reception is hindered by a buzzing noise, especially at night or with weak signals?</b>	Interference caused by electrical equipment, including fluorescent lights.	Relocate your AM antenna. Install an outdoor AM antenna (page 19).
	<b>AM reception is hindered by a high-pitched noise?</b>	Interference caused by your TV.	Move the AM loop antenna as far away as possible from your TV. Move the AV Receiver as far away as possible from your TV.
	<b>The tuner presets no longer work?</b>	The power cord has not been connected to a wall outlet, or the power has been turned off for an extended period.	Preset your favorite radio stations again (page 37). The power cord must be plugged into a wall outlet a few times each month in order to preserve the presets.
Recording	<b>Sound can be heard from the speakers, but it cannot be recorded?</b>	From the VIDEO 1 OUT, you're trying to record the signal being fed into the VIDEO 1 IN, or from the TAPE OUT, you're trying to record the signal being fed into the TAPE IN.	To prevent signal loops and damage to the AV Receiver, input signals are not fed through to outputs with the same name (e.g., TAPE IN/OUT or VIDEO 1 IN/OUT).
		You're playing Dolby Digital or DTS source material. You cannot record from an AV component that is connected digitally.	Although you cannot record Dolby Digital or DTS surround channels, you can record the left and right channels by connecting the source AV component's analog left and right outputs to a pair of analog inputs on the AV Receiver.
		The wrong input source is selected on your recorder.	Select the correct input source. See your recorder's manual for more information.
	<b>Can't record the surround-sound effects produced by the listening modes?</b>	This is normal. The surround-sound effects produced by the listening modes cannot be recorded.	
Others	<b>The Late Night function doesn't work?</b>	The Late Night function only works with Dolby Digital.	"DIGITAL" appears on the display when using a Dolby Digital source.
	<b>The multichannel DVD input doesn't work?</b>	The multichannel input is not selected.	Press the [MULTI CH] button to select the multichannel input (page 35).
		The AV component is not properly connected.	Connect the AV component's 5.1-channel outputs to the AV Receiver's DVD IN FRONT, SURR, CENTER, and SUB-WOOFER sockets (page 24).
	<b>The listening mode changes to Stereo when headphones are connected?</b>	This is normal. When you connect a pair of headphones, the Stereo listening mode is selected automatically.	
	<b>There's nothing shown on the display.</b>	The Pure Audio listening mode is selected.	When this mode is selected, the display and the internal video circuits are all turned off and no video signals are output.

# Specifications

## Amplifier Section

Power output:	<b>75 W (8 Ω, 20 Hz–20 kHz, FTC)</b>
All channels:	105 W (6 Ω, 1 kHz, DIN)
	130 W (6 Ω, 1 kHz, EIAJ)
Dynamic power:	2 x 180 W (3 Ω, front)
	2 x 150 W (4 Ω, front)
	2 x 95 W (8 Ω, front)
THD (total harmonic distortion):	0.08% (rated power)
Damping factor:	60 (front, 1 kHz, 8Ω)
Input sensitivity and impedance:	200 mV/47 k Ω (LINE)
Output level and impedance:	200 mV/470 Ω (REC OUT)
Frequency response:	10 Hz–100 kHz/+1 dB, -3 dB (Direct mode)
Tone control:	±12 dB, 50 Hz (BASS)
	±12 dB, 20,000 Hz (TREBLE)
S/N ratio (Direct mode):	100 dB (CD, IHF-A)
Speaker impedance:	6 Ω~

## Video Section

Input sensitivity, output level and impedance:	1.0 V <sub>p-p</sub> /75 Ω (component and S-Video Y)
	0.7 V <sub>p-p</sub> /75 Ω (component P <sub>b</sub> /C <sub>b</sub> , P <sub>r</sub> /C <sub>r</sub> )
	0.28 V <sub>p-p</sub> /75 Ω (S-Video C)
	1.0 V <sub>p-p</sub> /75 Ω (composite)
Component video frequency response:	5 Hz–50 MHz

## Tuner Section

### FM

Tuning frequency range:	87.5–108.0 MHz
Usable sensitivity:	FM STEREO 17.2 dBf, 2.0 μV (75 Ω IHF)
	FM MONO 11.2 dBf, 1.0 μV (75 Ω IHF)
S/N ratio:	FM STEREO 70 dB (IHF-A)
	FM MONO 76 dB (IHF-A)
THD:	FM STEREO 0.3% (1 kHz)
	FM MONO 0.2% (1 kHz)
FM stereo separation:	45 dB at 1 kHz

### AM

Tuning frequency range:	530–1700 kHz (American model)
	522–1611 kHz (Other models)
Usable sensitivity:	30 μV
S/N ratio:	40 dB
THD:	0.7%

## General

Power supply:	American model: AC 120 V, 60 Hz
	Worldwide model: AC 220–230 V and 120 V switchable 50/60 Hz
	Other models: AC 230–240 V, 50 Hz
	AC 220–230 V, 50 Hz
Power consumption:	American model: 4.6 A
	Other models: 370 W
Standby power consumption:	2.5 W
Dimensions (W x H x D):	17-1/8" x 5-7/8" x 14-13/16" (435 x 150 x 376 mm)
Weight:	American, European and Australian models: 22.5 lbs. (10.2 kg)
	Asian model: 24.3 lbs. (11.0 kg)

### Video Inputs

Component video inputs:	2 (DVD, Video 1/2/3)
S-Video inputs:	4 (DVD, Video 1–3)
Video inputs:	4 (DVD, Video 1–3)

### Video Outputs

Component video outputs:	1 (Component Video Out)
S-Video outputs:	2 (Video 1 Out, Monitor Out)
Video outputs:	2 (Video 1 Out, Monitor Out)

### Audio Inputs

Digital inputs:	4 (Optical 1–3, Coaxial)
Analog inputs:	6 (CD, Tape, DVD, Video 1–3)
Multichannel analog inputs:	5.1 ch (Front L/R, Center, Surround L/R, Subwoofer)

### Audio Outputs

Analog outputs:	2 (Tape Out, Video 1 Out)
Subwoofer pre out:	1
Speaker outputs:	6+2
Phones:	1

Specifications and features are subject to change without notice.

- The AV Receiver contains a microcomputer for signal processing and control functions. In very rare situations, severe interference, noise from an external source, or static electricity may cause it to lockup. In the unlikely even that this should happen, unplug the power cord from the wall outlet, wait at least five seconds, and then plug it back in again. That should fix it.
- To reset the AV Receiver to its factory defaults, turn it on and, while holding down the [VIDEO 1] button, press the [STANDBY/ON] button. "Clear" will appear on the display and the AV Receiver will enter Standby mode.

## **ONKYO CORPORATION**

Sales & Product Planning Div. : 2-1, Nisshin-cho, Neyagawa-shi, OSAKA 572-8540, JAPAN  
Tel: 072-831-8023 Fax: 072-831-8124

### **ONKYO U.S.A. CORPORATION**

18 Park Way, Upper Saddle River, N.J. 07458, U.S.A.  
Tel: 201-785-2600 Fax: 201-785-2650 <http://www.onkyousa.com>

### **ONKYO EUROPE ELECTRONICS GmbH**

Liegnitzerstrasse 6, 82194 Groebenzell, GERMANY  
Tel: +49-8142-4401-0 Fax: +49-8142-4401-555 <http://www.onkyo.net>

### **ONKYO CHINA LIMITED**

Units 2102-2107, Metroplaza Tower I, 223 Hing Fong Road, Kwai Chung,  
N.T., HONG KONG Tel: 852-2429-3118 Fax: 852-2428-9039



SN 29343629C

(C) Copyright 2004 ONKYO CORPORATION Japan. All rights reserved.

I0406-4