



OpenOffice.org 3 Draw Guide

Drawing Vector Graphics in OpenOffice.org

Free eBook Edition

Copyright

This document is Copyright © 2005–2011 by its contributors as listed below. You may distribute it and/or modify it under the terms of either the GNU General Public License (<http://www.gnu.org/licenses/gpl.html>), version 3 or later, or the Creative Commons Attribution License (<http://creativecommons.org/licenses/by/3.0/>), version 3.0 or later. All trademarks in this guide belong to their legitimate owners.

Contributors

Agnes Belzunce
Thomas Hackert
Jared Kobos
Bernd Schukat
Claire Wood

Daniel Carrera
Regina Henschel
Hazel Russman
Wolfgang Uhlig
Linda Worthington

Martin Fox
Peter Hillier-Brook
Gary Schnabl
Jean Hollis Weber

Feedback

Please direct any comments or suggestions about this document to: odfauthors-discuss@lists.odfauthors.org

Acknowledgments

Several chapters in this book are based on an original French document written for OpenOffice.org 1.x by Michel Pinquier (translated into English by Alex Thurgood) and previous content revised by Jim Taylor. The chapters were revised for OOo 2.0 by Linda, Daniel, Jean, and Agnes, and later translated into German by Bernd, Regina, and Wolfgang. The German revisions were then translated into English and revised for OOo 3.3 by Martin Fox.

Publication date and software version

Published 27 August 2011. Based on OpenOffice 3.3.

Contents

Copyright.....	2
Chapter 1	
Introducing Draw.....	7
Introduction.....	8
The Draw workplace.....	8
Rulers.....	9
Status bar.....	10
Toolbars.....	11
Drawing grid and guides.....	15
Floating and moving toolbars.....	15
Quick printing.....	17
Controlling printing.....	18
Exporting to PDF.....	22
Exporting to other formats.....	22
Exporting Draw documents as web pages.....	23
E-mailing documents.....	23
Chapter 2	
Drawing Basic Shapes.....	24
Creating simple drawings.....	25
Custom shapes.....	25
Drawing basic shapes.....	25
Gluepoints and connectors (basics).....	32
Drawing geometric shapes.....	33
Adding text to objects.....	35
Chapter 3	
Working with Objects and Object Points.....	38
Introduction.....	39
Moving and dynamically adjusting an object's size.....	41
Rotating and shearing an object using the mouse.....	44
Setting size and position exactly.....	46
Editing object points.....	48
Another way to change the form of basic shapes.....	48
How curves work.....	49
Chapter 4	
Changing Object Attributes.....	55
Toolbars and menus.....	56
Editing lines and borders.....	57
Editing the inside (fill) of an object.....	63
Using styles.....	71
Special effects.....	72
Chapter 5	
Combining Multiple Objects.....	78

Introduction: grouping and combining objects.....	79
Grouping objects.....	79
Combining objects.....	80
Merging, subtracting, or intersecting shapes.....	81
Aids for positioning objects.....	83
Chapter 6	
Editing Pictures (Raster Graphics).....	88
Introduction.....	89
Importing raster and vector graphics.....	89
Exporting graphics.....	92
Modifying raster object properties.....	95
The picture (editing) toolbar.....	95
Cropping.....	97
The graphic filter toolbar.....	98
Changing colors using the eyedropper.....	101
Conversion.....	105
Print options with raster graphics.....	109
Chapter 7	
Working with 3D Objects.....	111
Creating 3D objects.....	112
Editing 3D objects.....	116
Combining objects in 3D scenes.....	134
Chapter 8	
Tips and Tricks.....	138
Positioning objects with zoom.....	139
Positioning objects with snap functions.....	140
Drawing to scale.....	146
Splitting drawings on multiple layers.....	146
Creating a multi-page document.....	150
Color palette: adding or changing single colors.....	153
Changing colors using the Color dialog.....	155
Creating cool effects.....	157
Chapter 9	
Organization Charts, Flow Diagrams, and More.....	159
Drawing an organization chart.....	160
Drawing a flow diagram.....	162
Glue points and connectors.....	164
Adding text to connectors.....	168
Chapter 10	
Advanced Draw Techniques.....	171
Drawing to scale.....	172
Dimensioning a drawing.....	180
Working with text in Draw.....	183
Guide to Bézier curves.....	196

Adding comments to a drawing.....	202
Connecting and breaking lines.....	203
Index.....	204

Note for Mac users

Some keystrokes and menu items are different on a Mac from those used in Windows and Linux. The table below gives some common substitutions for the instructions in this chapter. For a more detailed list, see the application Help.

Windows/Linux	Mac equivalent	Effect
Tools > Options menu selection	OpenOffice.org > Preferences	Access setup options
<i>Right-click</i>	<i>Control+click</i>	Open context menu
<i>Ctrl (Control)</i>	<i>⌘ (Command)</i>	Used with other keys
<i>F5</i>	<i>Shift+⌘+F5</i>	Open the Navigator
<i>F11</i>	<i>⌘+T</i>	Open Styles & Formatting window



Chapter 1

Introducing Draw

Free eBook Edition

Introduction

Draw is a vector graphics drawing tool, although it can also perform some operations on raster graphics (pixels). Using Draw, you can quickly create a wide variety of graphical images.

Vector graphics store and display a picture as simple geometric elements such as lines, circles, and polygons rather than as a collection of pixels (points on the screen). This permits simpler storage and supports precise scaling of the picture elements.

Draw is fully integrated into the OpenOffice.org suite, and this simplifies exchanging graphics with all components of the suite. For example, if you create an image in Draw, reusing it in a Writer document is as simple as copying and pasting the image. You can also work with drawings directly from within Writer or Impress, using a subset of the functions and tools from Draw.

Draw's functionality is extensive, and even though it was not designed to rival high-end graphics applications, it possesses significantly more functionality than the drawing tools that are generally integrated with most office productivity suites.

A few examples of the drawing functions are: layer management, magnetic grid-point system, dimensions and measurement display, connectors for making organization charts, 3D functions that enable small three-dimensional drawings to be created (with texture and lighting effects), drawing and page-style integration, and Bézier curves.

The *Draw Guide* is not a course book to be worked through from beginning to end. Rather, it is a reference work in which you can browse for guidance on particular topics.

This document describes only the functions associated with Draw. Some concepts, such as file management or the way the OpenOffice.org environment works, are mentioned only briefly; they are covered in more detail in the *Getting Started* guide.

The Draw workplace

The main components of the **Draw** interface are shown in Figure 1.

The large area in the center of the window is where you make the drawings. You can surround the drawing area with toolbars and information areas. The number and position of the visible tools vary with the task in hand and user preferences. Therefore, your setup may look different. For example, many users put the main Drawing toolbar on the left-hand side of the workspace—not at the bottom, as shown here.

You can split drawings in Draw over several pages. Multi-page drawings are used mainly for presentations. The *Pages* pane, on the left side of the Draw window in Figure 1, gives an overview of the pages that you create. If the Pages pane is not visible on your setup, you can enable it from the View menu (**View > Page Pane**). To make changes to the page order, just drag and drop one or more pages.

In Draw 3.3, the maximum size of a drawing page is 300 cm by 300 cm.

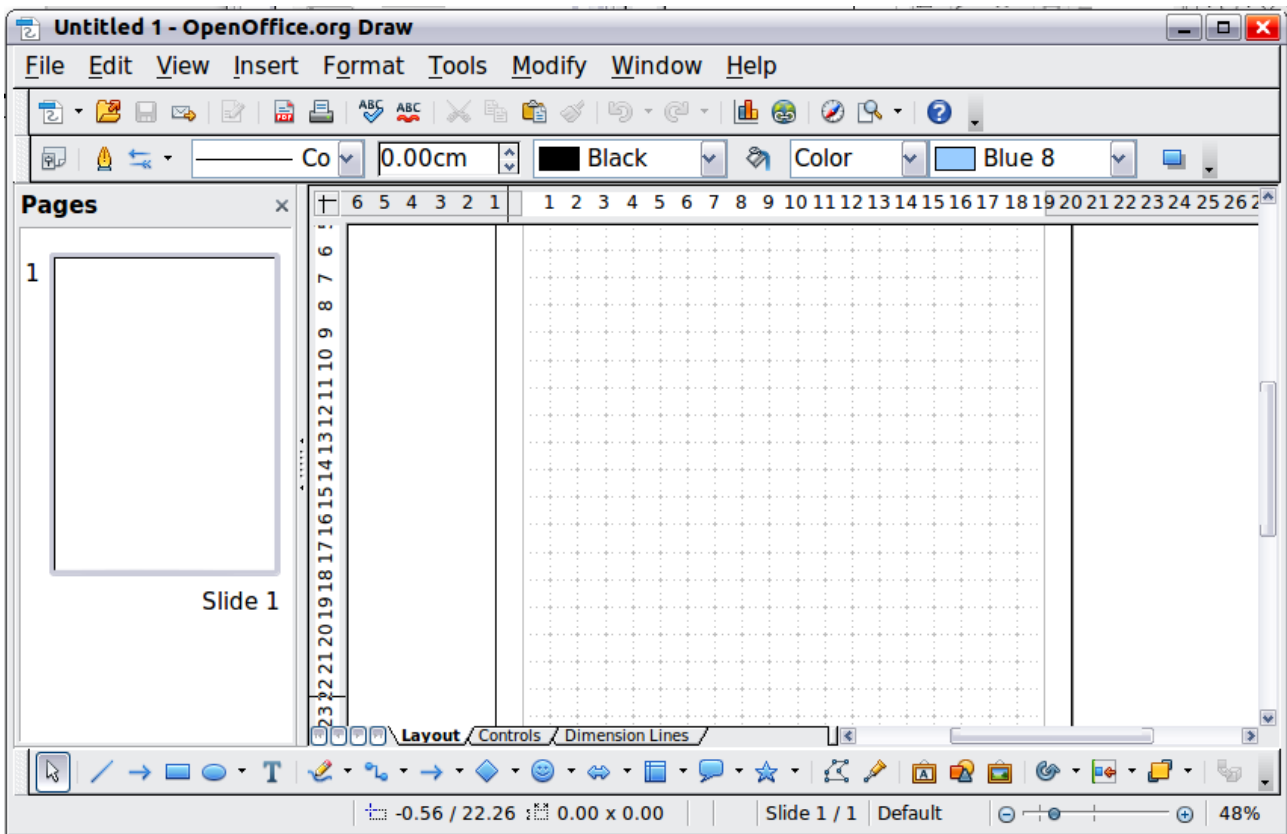

Figure 1: Initial Draw window

Rulers

You should see rulers (bars with numbers) on the upper and left-hand sides of the workspace. If they are not visible, you can enable them by selecting them from the View menu (**View > Ruler**).

The rulers show the size of a selected object on the page (see the gray double lines, highlighted in Figure 2). When no object is selected, they show the location of the mouse pointer, which helps to position drawing objects more accurately.

You can also use the rulers to manage object handles and guide lines, making it easier to position objects.

The page margins in the drawing area are also represented on the rulers. You can change the margins directly on the rulers by dragging them with the mouse.

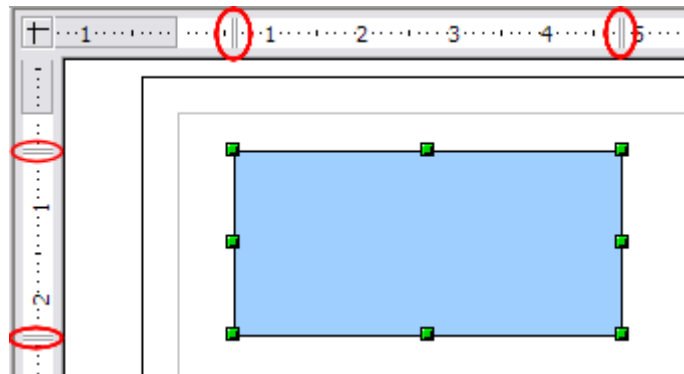

Figure 2: Rulers show the size of the selected object

To modify the units of measurement of the rulers (which you can define independently), right-click on the desired ruler, as illustrated for the horizontal ruler in Figure 3.

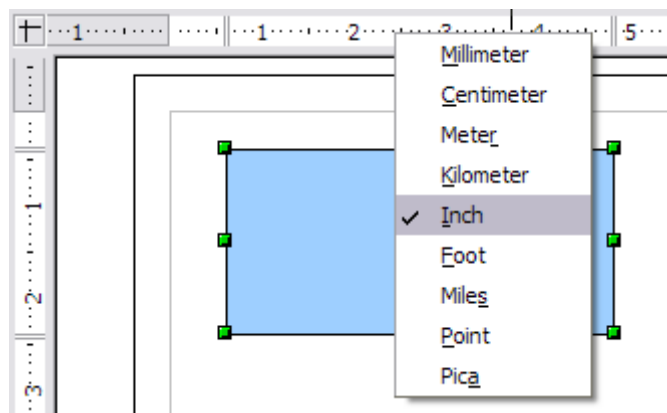

Figure 3: Rulers in a drawing

Status bar

The Status bar is located at the bottom of the Draw window and includes several Draw-specific fields, as identified in Figures 4 and 5.

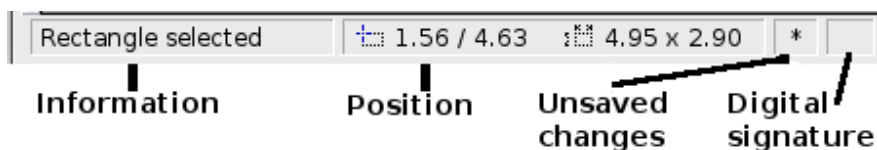

Figure 4: Left end of Draw status bar

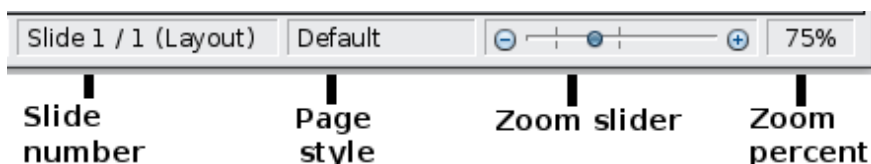

Figure 5: Right end of Draw status bar

The *Information* field shows which action is being carried out, or which object type is selected.

The *Position* field shows different information, depending on whether objects are currently selected or not:

- When no object is selected, the left number pair shows the current position (in X,Y Cartesian coordinates) of the mouse cursor.
- While an object is being resized with the mouse, the right number pair shows the size of the object (width and height).

Note

The sizes are given in the current measurement unit (not to be confused with the ruler units). This unit is defined in **Tools > Options > OpenOffice.org Draw > General**, where you can also change the scale of the page. Another way to change the scale is to double-click on the number shown in the status bar.

- If an object is selected, the left number pair shows the X,Y coordinates of the upper-left corner, and the right number pair displays the size of the object, as seen in Figure 4. These numbers do not relate to the object itself, but to the selection outline, which is the smallest possible rectangle that can contain the visible part or parts of the object; see also Chapter 3 (Working with Objects and Object Points).
- When an object is selected, a double-click on this field opens the Position and Size dialog, which is described in detail in Chapter 4 (Changing Object Attributes).

In the *Indicator* field, an asterisk (*) is shown whenever any change is made to the document but not yet saved to disk.

If you wish to digitally sign the document, a double-click or right-click in the *Signature* field brings up the signature box. Note that a document must be saved at least once before it can be signed. After it is signed, an indicator is present in this field.

The *Slide* field shows the sequence number for the current drawing page, in addition to the total number of pages that you created so far. This is useful when your drawing has a number of pages. If you select an object, the field enclosed by parentheses shows the layer in which the object resides within the drawing. In the example of Figure 5, the object is on the Layout layer of Slide 1, and there is a total number of one slide so far.

The *Page style* field shows which template is being used.

The vertical bar in the middle of the *Zoom* slider represents a zoom factor of 100%. To change the view magnification, drag the Zoom slider, or click on the + and - signs, or right-click on the zoom level percent to pop up a list of magnification values from which to choose. Double-clicking on the zoom level percent to open the **Zoom & View Layout** dialog.

Toolbars

You can display or hide the various Draw toolbars, according to your needs. To display or hide a toolbar, click **View > Toolbars**. On the menu that appears, choose which toolbars you want to display.

You can also select the icons that you wish to appear on the toolbars. To change the visible icons on any toolbar, click the arrow at the right-hand end of that toolbar and

choose **Visible Buttons** from the drop-down menu. Visible icons are indicated by an outline around the icon. Click on icons to hide or show them on the toolbar.

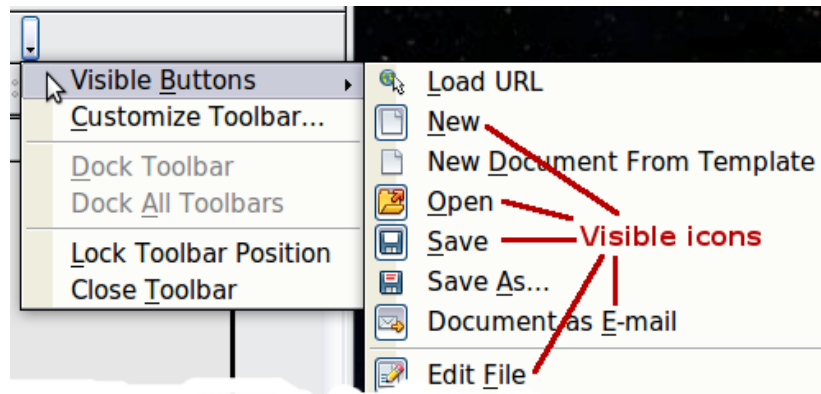

Figure 6: Selection of visible toolbar icons

The tools available in the various toolbars are explained in the following sections.

Standard toolbar

The Standard toolbar is the same for all OpenOffice.org components and is not described in detail here.



Figure 7: Standard toolbar

Drawing toolbar

The Drawing toolbar is the most important toolbar in Draw. It contains all the necessary functions for drawing various geometric and freehand shapes and for organizing them on the page. It is described in detail in Chapter 2 (Drawing Basic Shapes).



Figure 8: Drawing toolbar

Line and Filling toolbar

The Line and Filling toolbar lets you modify the main properties of a drawing object: the icons and pull-down lists vary with the type of object selected. For example, to change the thickness of a line with the spinner, hover the mouse over the spinner and click the up or down arrow to achieve the desired thickness.

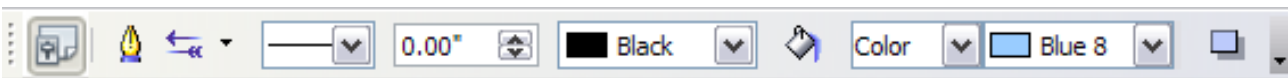

Figure 9: Line and Filling toolbar

In the example above, the available functions enable you to change the color, style, and width of the line drawn or the fill color, style, and other properties of an object. The object must first be selected with a mouse click. If the selected object is a text frame, the buttons for line style and fill color are changed to *Invisible* by default. You can change them to something else if you want.

Text Formatting toolbar

When text is selected, the Line and Filling toolbar changes to the Text Formatting toolbar, which is very similar to the Formatting toolbar in Writer. A more detailed explanation of the buttons on this toolbar can be found in Chapter 4 (Changing Object Attributes).



Figure 10: Text Formatting toolbar

Color bar

To display the Color bar, use **View > Toolbars > Color Bar**. The toolbar then appears at the bottom of the workspace and displays the current color palette.



Figure 11: Color bar

This toolbar lets you rapidly choose the color of the various objects (lines, areas, and 3D effects) in your drawing. The first box in the panel corresponds to transparency (no color).

Choosing a color palette

You can access several specialized color palettes in Draw, as well as change individual colors to your own taste. This is done using the Area dialog, reached by choosing **Format > Area**, or the *pouring can* icon on the Line and Filling toolbar (Figure 9).

On the Area dialog, choose the **Colors** tab (Figure 12).

To load another palette, click on the **Load Color List** button (circled). The file selector dialog asks you to choose one of the standard OpenOffice.org palettes (files bearing the file extension *.soc). For example, web.soc is a color palette that is particularly adapted to creating drawings that are going to appear in Web pages. These colors will display correctly on workstations with screens capable of at least 256 colors.

A more detailed description of color palettes and their options can be found in Chapter 8 (Tips and Tricks).

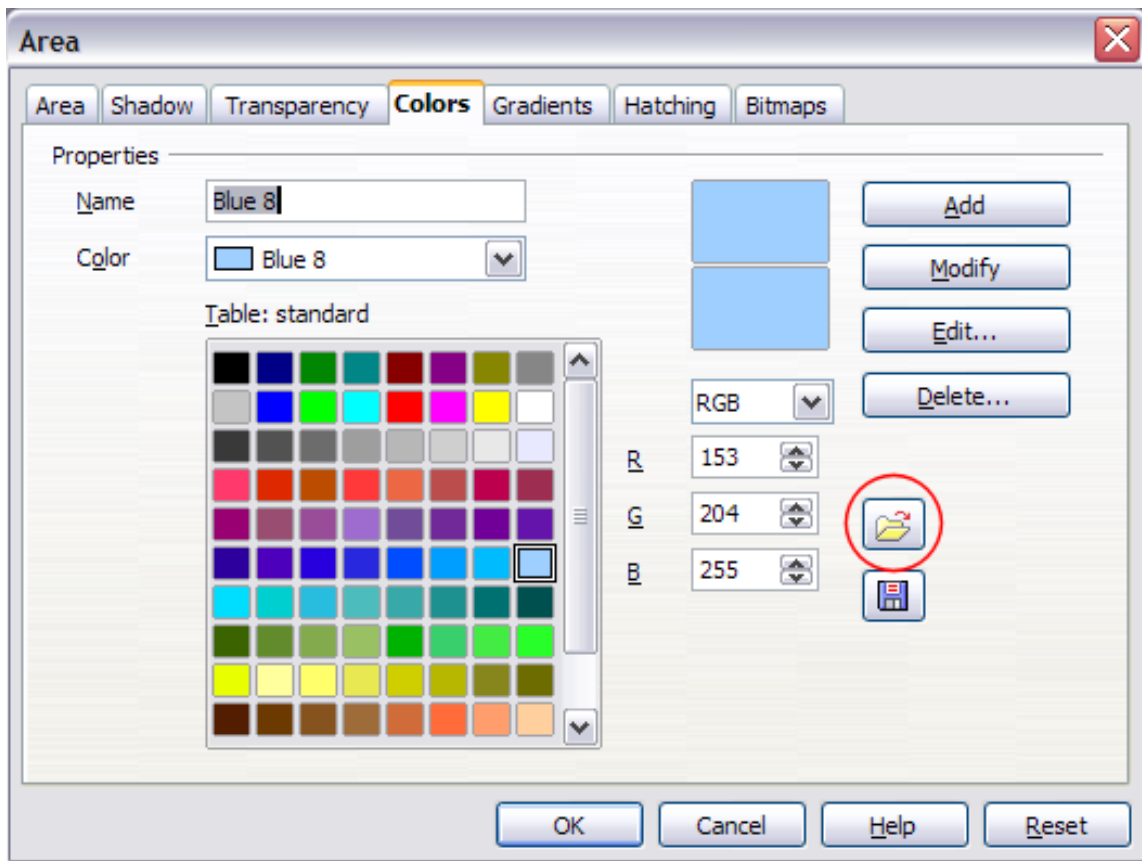

Figure 12. Changing the color palette

Options toolbar





The Options toolbar lets you activate or deactivate various drawing aids. The Options Bar is not one of the toolbars displayed by default. To display it, select **View > Toolbars > Options**.















Figure 13: Options toolbar

The options are described in the table below and in greater detail in other chapters of the *Draw Guide*.

Table 1: Functions on the Options toolbar

Icon	Function
	Rotation mode after clicking object
	Display (or hide) the grid
	Display (or hide) the guides
	Display (or hide) guides when moving

Icon	Function
	Snap to grid
	Snap to guides
	Snap to page margins
	Snap to object borders
	Snap to object points
	Allow quick editing
	Select text area only
	Double-click to edit text
	Simple handles
	Large handles
	Modify object with attributes
	Exit all groups

Drawing grid and guides

Draw offers a grid as a drawing aid. The grid can be turned on or off by clicking on the **Grid** icon on the Options toolbar. The points of the grid displayed on the screen are not shown on the printed drawing. The color, spacing, and resolution of the grid points can be individually chosen for each axis. This is described in more detail in Chapter 8 (in the section titled “Configuring the grid”).

Guides are special “helper lines” that can be turned on or off by clicking on the **Guides** icon on the Options toolbar. Draw offers a “Snap” function, with which you can place drawings exactly on these guides or on a grid point, a page margin, or a border or point of another object. All snap functions are described in detail in Chapter 8 (Tips and Tricks).

Showing the position of the object while moving it makes positioning the object much easier. If the Guides function is activated, pairs of vertical and horizontal lines enclosing the object are shown while moving the object. These lines extend to the edges of the drawing area. This function is also described in detail in Chapter 8.

Floating and moving toolbars

Many toolbar icons are marked with a small arrow. The arrow indicates that this icon has additional tools. Click the arrow to display the full set of tools (see Figure 14).

You can “tear off” this tool set so it becomes a floating toolbar. Click the area at the bottom of the toolset, drag it across the screen to a location you want, and then release the mouse button.

To dock a floating toolbar to the top or side of the Draw workspace, *Ctrl+click* on the title of the toolbar. To float a docked toolbar, click on its handle and drag it off the side of the workspace (see Figure 15). The floating-toolbar capability is common to all components of OpenOffice.org.

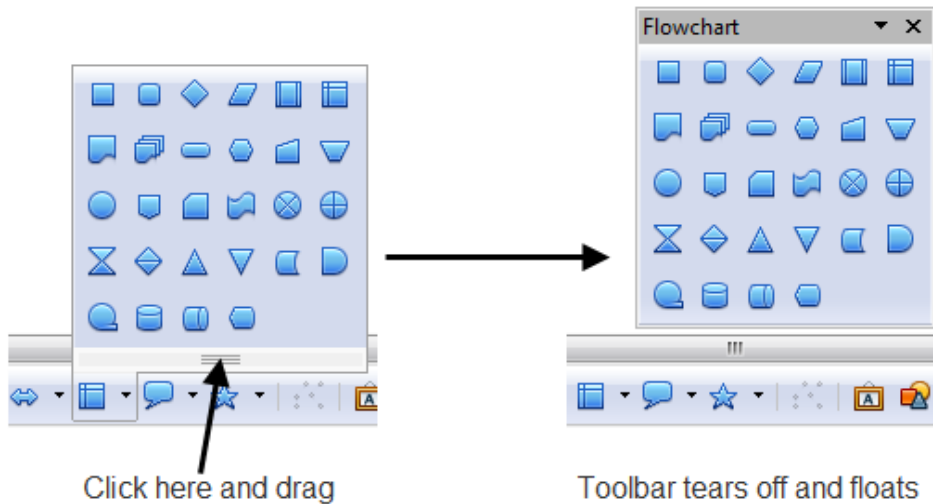

Figure 14: An arrow next to an icon indicates additional functions

Note

When a toolset is made into a floating toolbar, the icon on the existing toolbar remains in the toolbar and always shows the last command you used. This means that the icon you see on your screen may differ from the icon shown in this Guide.

Handles of docked toolbars

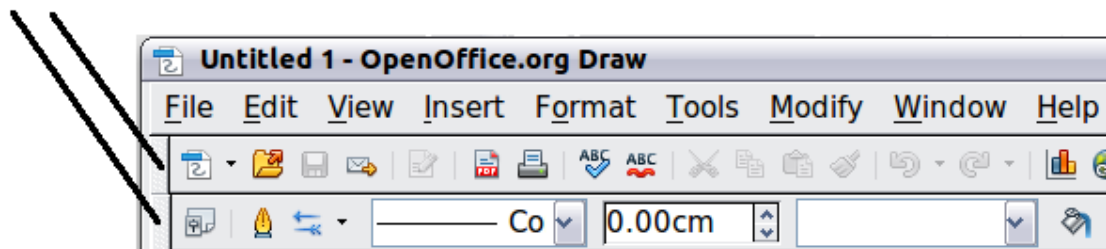



Figure 15: Moving a docked toolbar

Tip

When you double-click on an icon on a floating toolbar, the command corresponding to that icon will run. You can then repeat this action as often as you like. To exit from this mode, press the *Esc* key or click on another icon (for example ). This may not work for every icon on every toolbar.

Customizing toolbars

You can customize toolbars in several ways. To show or hide icons defined for a toolbar, see Figure 6 on page 12.

To add functions to a toolbar, move tools between toolbars, or create new toolbars., choose **View > Toolbars > Customize**, select the **Toolbars** tab (Figure 16) and the toolbar you want to change, and then select the desired buttons for that toolbar.

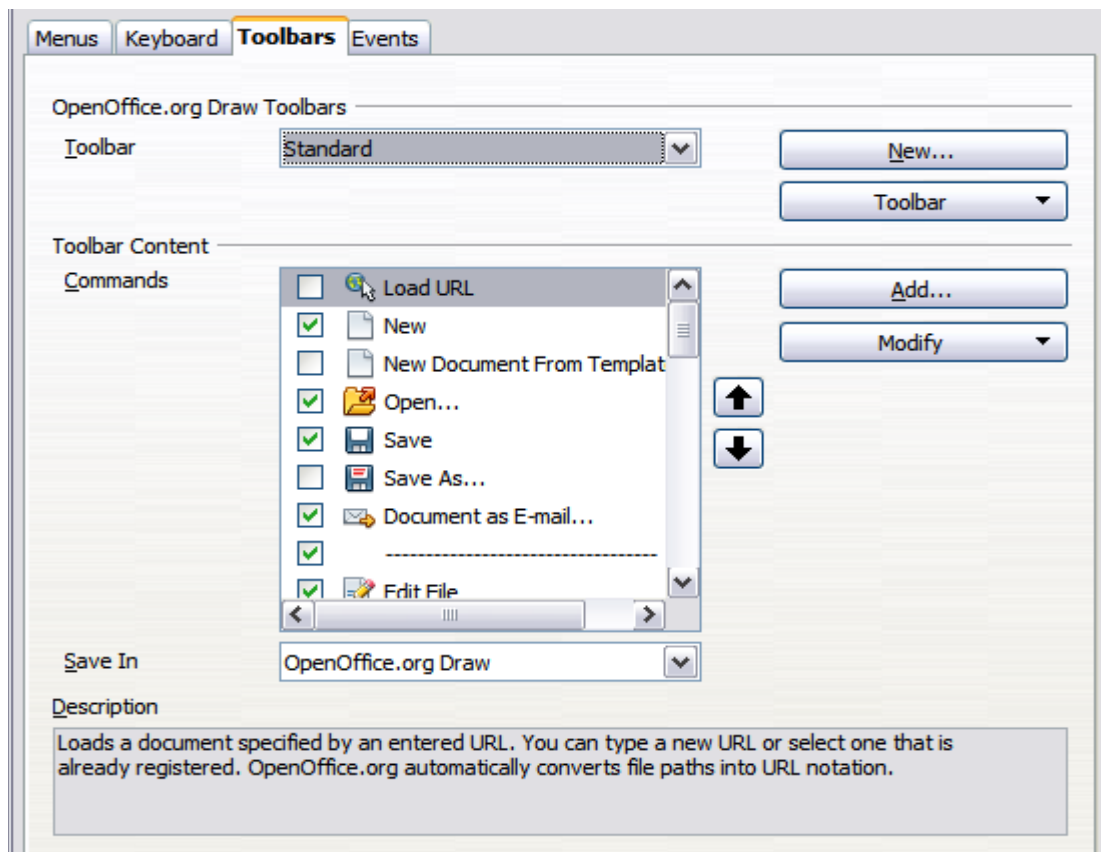



Figure 16: Customizing a toolbar

Each toolbar has a different list of functions. For details, see Chapter 14 (Customizing OpenOffice.org) in the *Getting Started* guide. That chapter also describes how to customize menus.

Quick printing

Click the **Print File Directly** icon  to send the entire document to the default printer defined for your computer.

Note

You can change the action of the **Print File Directly** icon to send the document to the printer defined for the document instead of the default printer for the computer. Go to **Tools > Options > Load/Save > General** and select the **Load printer settings with the document** option.

Controlling printing

For more control over printing, use the Print dialog (**File > Print** or *Ctrl+P*).

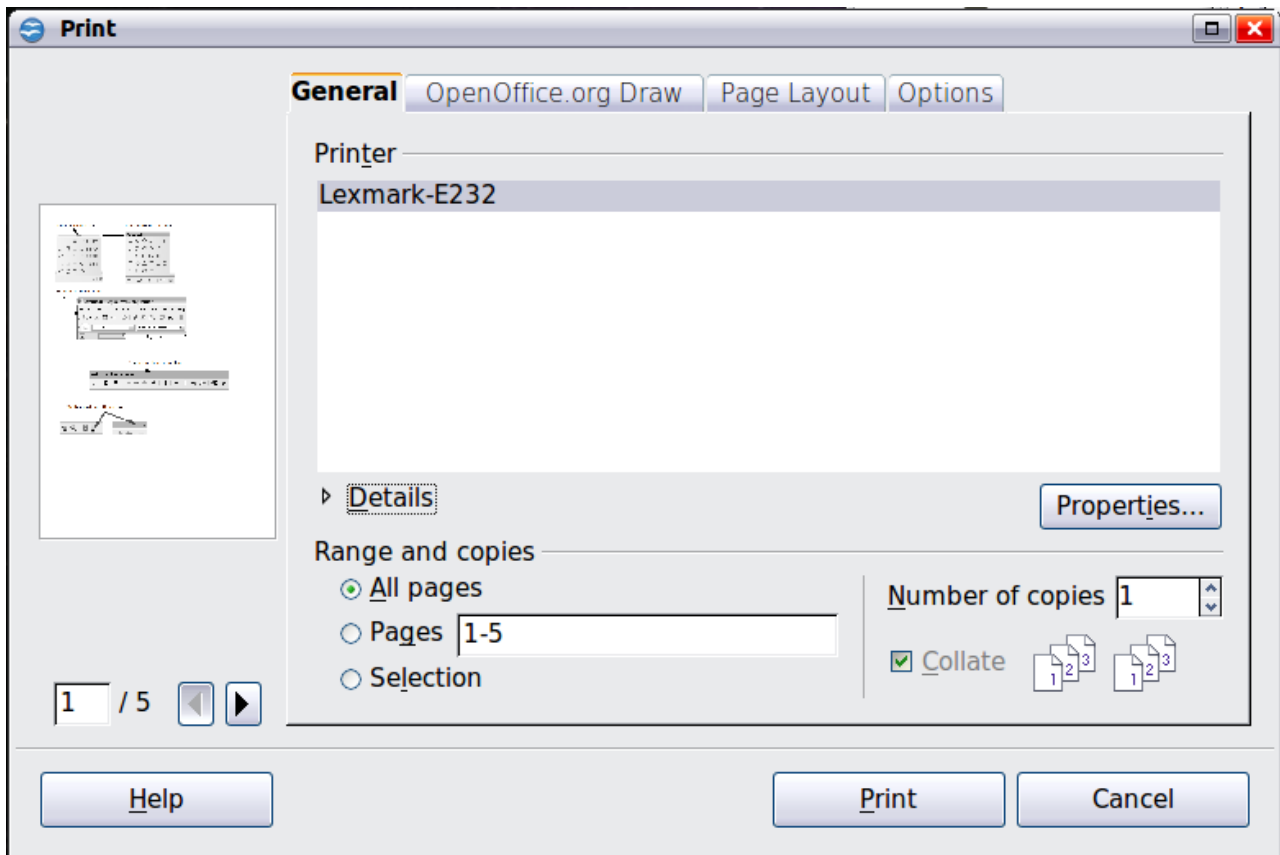

Figure 17. The Print dialog

Note

The options selected on the Print dialog apply to this printing of this document only.

To specify default printing settings for OpenOffice.org, go to **Tools > Options > OpenOffice.org - Print** and **Tools > Options > OpenOffice.org Draw - Print**.

The Print dialog has four tabs, from which you can choose a range of options, as described in the following sections.

Selecting general printing options

On the *General* tab of the Print dialog, you can choose:

- The **printer** (from the printers available)
- Which **pages** to print, the number of copies to print, and whether to collate multiple copies (*Range and copies* section)

Select the **Properties** button to display a dialog where you can choose portrait or landscape orientation, which paper tray to use, and the paper size to print on.

On the *Options* tab of the Print dialog (Figure 18) you can set a number of other, lesser used, options for printing.

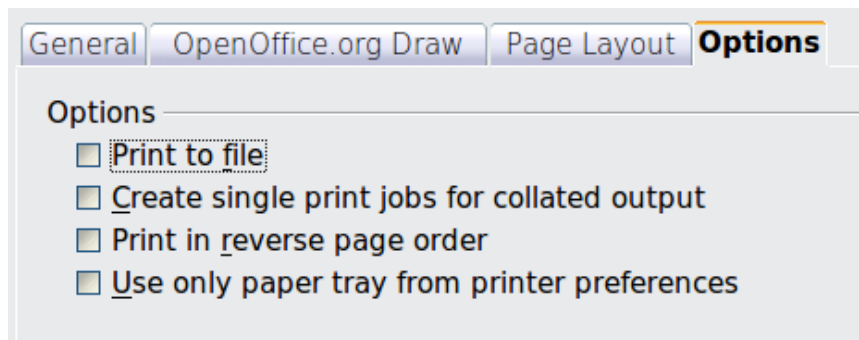

Figure 18: General print options

Printing multiple pages on a single sheet of paper

You can print multiple pages of a document on one sheet of paper. To do this:

- 1) In the Print dialog, select the *Page Layout* tab.
- 2) In the *Layout* section, select from the drop-down list the number of pages to print per sheet. The preview panel on the left of the Print dialog shows how the printed document will look.

When printing more than two pages per sheet, you can choose the order in which they are printing across and down the paper. The two pictures below show the difference.

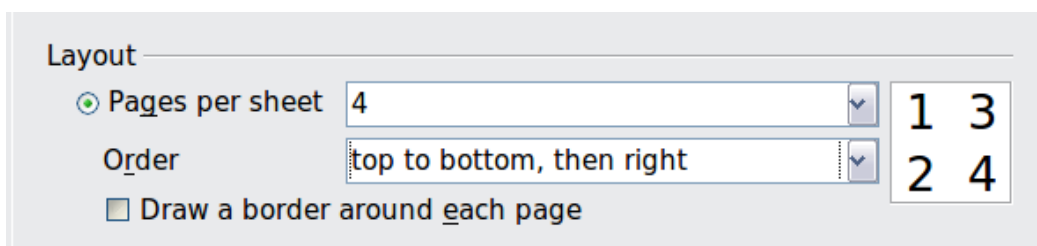
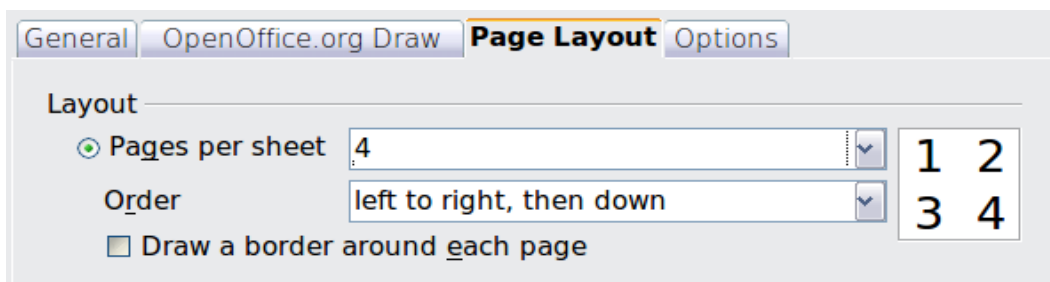

- 3) In the *Page sides* section, select whether to print all pages or only some pages.
- 4) Click the **Print** button.

Selecting pages to print

In addition to printing a full document, you can choose to print individual pages, ranges of pages, or a selection of a document.



To print an individual page:

- 1) Choose **File > Print** from the menu bar.
- 2) Select the page to print.
 - a) In the *Ranges and copies* section of the Print dialog, select the *Pages* option.
 - b) Enter the number of the page to print.
- 3) Click the **Print** button.

To print a range of pages:

- 1) Choose **File > Print** from the menu bar.
- 2) Select the pages to print.
 - a) In the *Ranges and copies* section of the Print dialog, select the *Pages* option.
 - b) Enter the number of the pages to print (for example 1-4 or 1,3,7,11), or any combination of the two, for example: 1-4,5-9,10.
- 3) Click the **Print** button.

To print a selection of a page, or a selection from multiple pages:

- 1) In the document, select the section of the page to print.
- 2) Choose **File > Print** from the menu bar.
- 3) Choose the *Selection* option in the *Ranges and copies* section of the Print dialog.
- 4) Click the **Print** button.

Printing a brochure

In Writer, Impress, and Draw, you can print a document with two pages on each side of a sheet of paper, arranged so that when the printed pages are folded in half, the pages are in the correct order to form a booklet or brochure.

Tip

Plan your document so it will look good when printed half size; choose appropriate margins, font sizes, and so on. You may need to experiment.

To print a brochure on a single-sided printer:

- 1) Choose **File > Print**.
- 2) In the Print dialog, click **Properties**.
- 3) Check the printer is set to the same orientation (portrait or landscape) as specified in the page setup for your document. Usually the orientation does not matter, but it does for brochures. Click **OK** to return to the Print dialog.
- 4) Select the *Page layout* tab in the Print dialog.

- 5) Select the **Brochure** option.
- 6) In the *Page sides* section, select *Back sides / left pages* option from the Include drop-down list.
- 7) Click the **Print** button.
- 8) Take the printed pages out of the printer, turn the pages over, and put them back into the printer in the correct orientation to print on the blank side. You may need to experiment a bit to find out what the correct arrangement is for your printer.

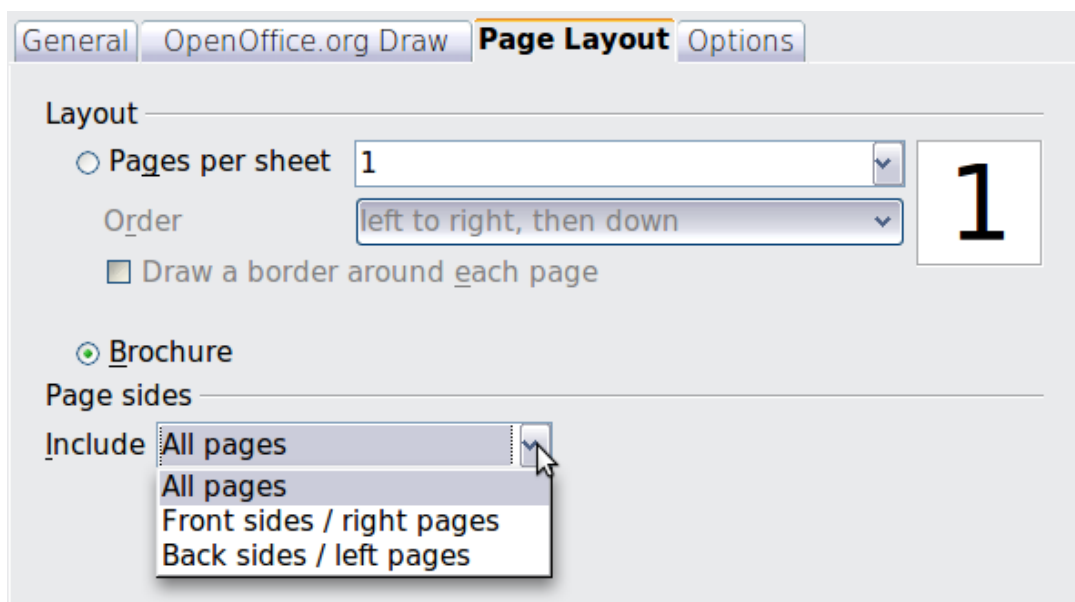

- 9) On the Print dialog, in the *Page sides* section, select *Front sides / right pages* option from the Include drop down box.
- 10) Click the **Print** button.

Tip If your printer can print double-sided automatically, choose **All pages**.

Printing in black and white (on a color printer)

You may wish to print documents in black and white on a color printer. Several choices are available. Please note that some color printers may print in color regardless of the settings you choose.

To change the printer settings to print in black and white or grayscale:

- 1) Choose **File > Print** to open the Print dialog.
- 2) Click **Properties** to open the Properties dialog for the printer. The available choices vary from one printer to another, but you should find options for the Color settings. See your printer's help or user manual for more information.
- 3) The choices for color might include *black and white* or *grayscale*. Choose the required setting.
- 4) Click **OK** to confirm your choice and return to the Print dialog,
- 5) Click the **Print** button to print the document.

Tip Grayscale is best if you have any graphics in the document.

To change the OpenOffice.org settings to print all color text and graphics as grayscale:

- 1) Choose **Tools > Options > OpenOffice.org > Print**.
- 2) Select the **Convert colors to grayscale** option. Click **OK** to save the change.
- 3) Open the Print dialog (**File > Print**).
- 4) Click the **Print** button to print the document.

To change the Draw settings to print all color text as black, and all graphics as grayscale:

- 1) Choose **Tools > Options > OpenOffice.org Draw > Print**.
- 2) Under *Contents*, select the **Print text in black** option. Click **OK** to save the change.
- 3) Open the Print dialog (**File > Print**).
- 4) Click the **Print** button to print the document.

Exporting to PDF

OpenOffice.org can export documents to PDF (Portable Document Format). This industry-standard file format is ideal for sending the file to someone else to view using Adobe Reader or other PDF viewers.

The process and dialogs are the same for Writer, Calc, Impress, and Draw, with a few minor differences mentioned in this section.

Quick export to PDF

Click the **Export Directly as PDF** icon  to export the entire document using your default PDF settings. You are asked to enter the file name and location for the PDF file, but you do not get a chance to choose a page range, the image compression, or other options.

Controlling PDF content and quality

For more control over the content and quality of the resulting PDF, use **File > Export as PDF**. The PDF Options dialog opens. This dialog has five pages (General, Initial View, User Interface, Links, and Security). Select the appropriate settings, and then click **Export**. In the following dialog, enter the location and file name of the PDF to be created, and click **Save** to export the file. See Chapter 10 (Printing, Exporting, Emailing) in the Getting Started book for details.

Exporting to other formats

OpenOffice.org uses the term “export” for some file operations involving a change of file type. If you cannot find what you want under **File > Save As**, look under **File > Export** as well.

OpenOffice.org can export files to XHTML. In addition, Draw can export to Adobe Flash (.swf) and a range of image formats.

To export to one of these formats, choose **File > Export**. On the Export dialog, specify a file name for the exported document, then select the required format in the *File format* list and click the **Export** button.

See Chapter 6 (Editing Pictures) for more about exporting graphics.

Note

The content of the exported file will depend on the element(s) selected on the page. No selection results in the entire image being exported. For most export formats only the image on the current page will be exported.

Exporting Draw documents as web pages

To export a multi-page Draw document to a series of web pages, choose **File > Export** and select **HTML Document** as the file type. The HTML Export wizard opens. Follow the prompts to create the web pages. If you wish, the wizard can generate a navigation aid to help in moving from page to page.

E-mailing documents

OpenOffice.org provides several ways to send documents quickly and easily as an e-mail attachment in one of three formats: OpenDocument (OpenOffice.org's default format), Microsoft Office formats, or PDF.

Note

Documents can only be sent from the OpenOffice.org menu if a mail profile has been set up.

To send the current document in OpenDocument format:

- 1) Choose **File > Send > Document as E-mail**. OpenOffice.org opens your default e-mail program. The document is attached.
- 2) In your e-mail program, enter the recipient, subject, and any text you want to add, then send the e-mail.

If you choose **E-mail as PDF**, OpenOffice.org first creates a PDF using your default PDF settings (as when using the **Export Directly as PDF** toolbar button) and then opens your email program with the PDF file attached.

You can email a document to several recipients. For details, see Chapter 10 (Printing, Exporting, Emailing) in the Getting Started book.

Chapter 2
Drawing Basic Shapes

Creating simple drawings

You can create 2D and 3D objects in Draw. This chapter shows how to draw simple 2D objects. The following chapters describe how to work with and edit such objects.

All shapes, whether they are lines, rectangles, or more complicated shapes, are called *objects*. This is common notation in vector drawing software.

The drawing tools are found on the Drawing toolbar. Figures 19 and 32 show parts of the standard form of the toolbar, as installed with Draw.

As described in Chapter 1 (Introducing Draw), the Drawing toolbar is normally located at the bottom of the window. If you do not see it, you can activate it from the **View > Toolbars** menu. As in all components of OpenOffice.org, you can place the toolbar on the Draw window wherever you wish, and you can configure toolbars as you wish by adding, moving, hiding, or deleting toolbar icons.

Custom shapes

Draw 3 offers the ability to create *custom shapes*. These correspond to *autosshapes* in Microsoft Office.

The two types of shapes differ in their properties and are dealt with separately in the relevant chapter of this guide. The main differences relate to the behavior of 3D objects and text handling. Beginners can safely ignore both for the present.

Text frames in Draw 3 have their own geometric format.

Drawing basic shapes

Basic shapes include:

- Lines
- Arrows
- Rectangles and squares
- Ellipses and circles
- Curves and polygons
- Connectors
- Lines and arrows

Note

When you draw a basic shape or select one for editing, the *Information* field in the status bar changes to reflect the action taken or in progress: Line created, Text frame xxyy selected, TextEdit: Paragraph 1, Row 1, Column 8 and so on.

Figure 19 shows part of the Drawing toolbar with the icons needed in the following sections. The *Text* icon is also included.



Figure 19: Part of the Drawing toolbar

Drawing a straight line

We begin with the drawing of the simplest element—a straight line.

Click on the **Line** icon  on the Drawing toolbar and place the mouse pointer at the point where you want to start the line (see Figure 20). Drag the mouse while keeping the mouse button pressed. Release the mouse button at the point where you want to end the line. A blue selection handle appears at each end of the line, showing that this is the currently selected object.

Holding down the *Shift* key while you draw a line restricts the angle of the line to a multiple of 45 degrees (0, 45, 90, 135, and so on).

Caution



This is the default behavior of the *Shift* key. However, if you have used **Tools > Options > OpenOffice.org Draw > Grid** to set *Snap position* to *When creating or moving objects*, the action of the *Shift* key is the opposite: lines will always be at a multiple of 45 degrees *unless* the *Shift* key is pressed.

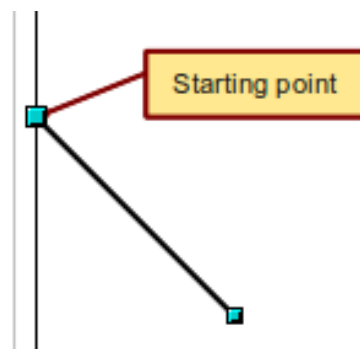

Figure 20: Drawing a straight line

Keeping the *Ctrl* key pressed while drawing a line enables the end of the line to snap to the nearest grid point.

Caution



The effect of the *Ctrl* key depends on the settings of the **Snap to Grid** option on the **View->Grid** menu:

Snap to Grid on: *Ctrl* deactivates the snap option for this activity.

Snap to Grid off: *Ctrl* activates the snap option for this activity.

The spacing (resolution) of the grid points can be adjusted under **Tools > Options > OpenOffice.org-Draw > Grid**. See also Chapter 8 (Tips and Tricks).

Holding down the *Alt* key while drawing a line results in the line extending outwards symmetrically in both directions from the start point. This lets you draw lines by starting from the middle of the line.

The line just drawn has all the standard line attributes, such as color and line style. To change any of these properties, select the line by clicking on it, then right-click and select **Line**.

While you are working with a line (or any other element), you can use the information field on the status bar to monitor the activity. A description of the current activity or selection is shown when you are working with elements. Figure 21 shows two examples.

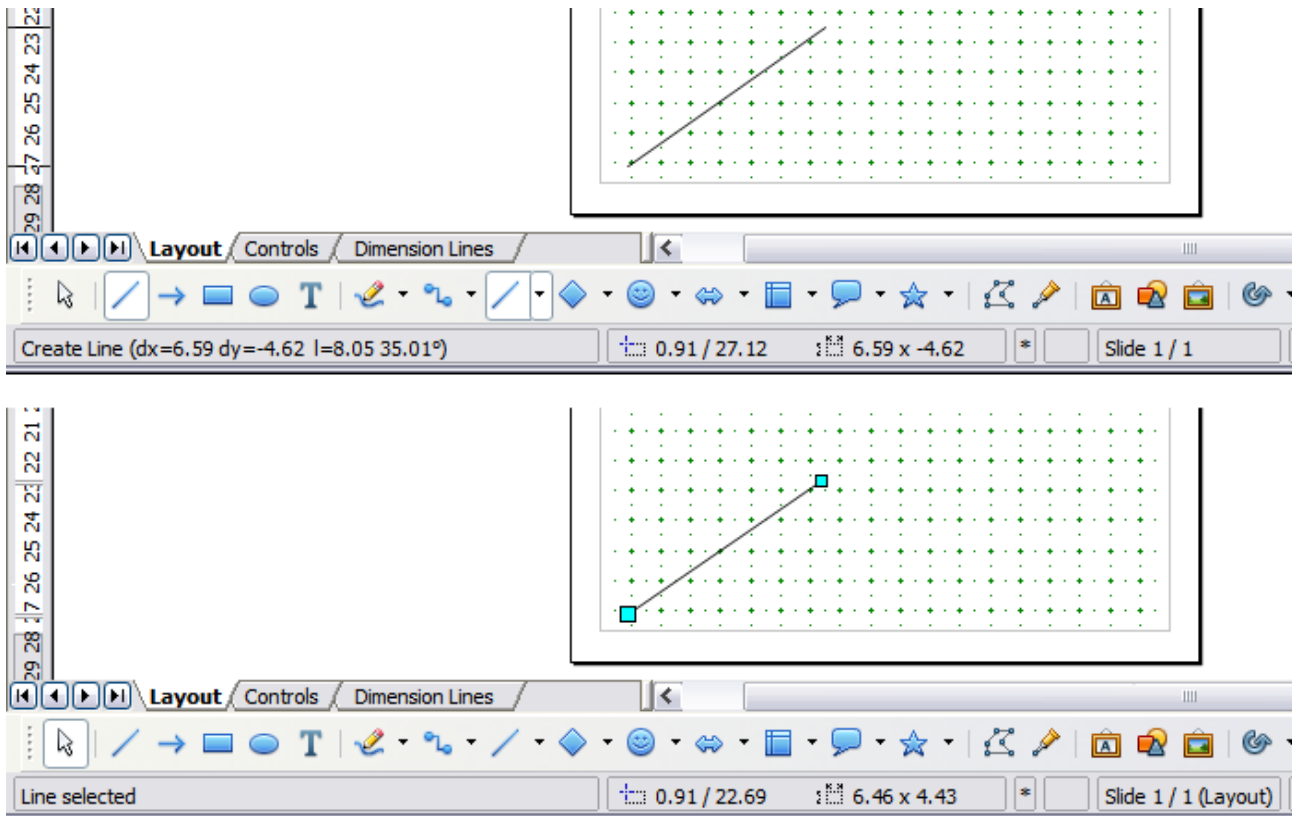



Figure 21: The information area in the status bar

Drawing an arrow

Arrows are drawn like lines. Draw classifies *arrows* as a subgroup of lines: lines with arrowheads. The information field on the status bar shows them only as lines. Click on the **Line Ends with Arrow** icon  to draw an arrow.

Drawing lines and arrows

If you added the lines and arrows toolbar to the main Drawing toolbar you can click on the small black triangle on the **Lines and Arrows**  icon on the Drawing toolbar to open a toolbar with ten tools for drawing lines and arrows (Figure 22). (Alternatively **View > Toolbars > Arrows** opens the toolbar as a floating toolbar.) In both cases, the last-used command will be stored on the toolbar to make it quicker to call it up again: click directly on the symbol to repeat the last used command chosen from this toolbar.

After drawing the line, you can change the arrow style by clicking on the **Arrow** button in the **Line and Filling** toolbar and choose from 13 arrow start and end options.

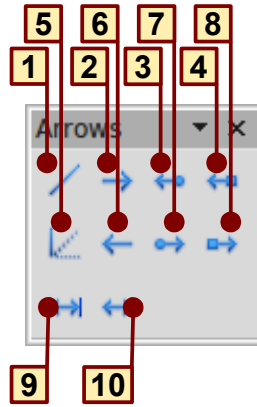

- | | | |
|---------------------------------|---------------------------------|---------------------------------|
| 1 Line | 5 Line (45°) | 8 Line with square/arrow |
| 2 Line Ends with Arrow | 6 Line starts with arrow | 9 Dimension line |
| 3 Line with arrow/circle | 7 Line with circle/arrow | 10 Line with arrows |
| 4 Line with arrow/square | | |
- Figure 22: Arrows toolbar*

Drawing a rectangle or square

Drawing a rectangle is similar to drawing a straight line, except that you click on the **Rectangle** icon  on the Drawing toolbar, and the (imaginary) line drawn by the mouse corresponds to a diagonal of the rectangle. In addition, the outline of the future rectangle changes shape as you drag the mouse around. The outline may be shown as a dashed line until you release the mouse button.

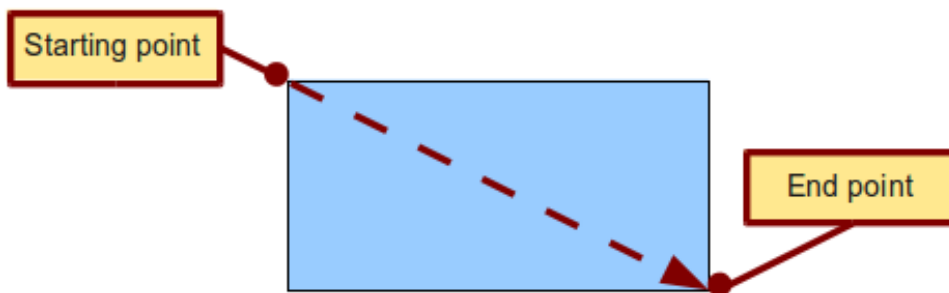



Figure 23: Drawing a rectangle

Draw considers squares to be rectangles with sides of equal length. Hold down the *Shift* key to draw a square. Hold down the *Alt* key while dragging with the mouse to create a rectangle with its center (rather than a corner) at the start point (where you first clicked the mouse).

Note Blue or green selection handles appear around an object made up of more than 2 points, showing that this is the currently selected object. The colors depend on the standard selection mode—green with a normal selection or blue if you are in the point edit mode. This effect is easily seen if both **Simple Handles** and **Large Handles** are switched on in the Options toolbar. See Chapter 3 for more details on points.

Drawing ellipses (ovals) and circles

To draw an ellipse (also called an oval) or a circle, click on the **Ellipse** icon  on the main Drawing toolbar. (A circle is simply an ellipse with both axes the same length.) The ellipse drawn is the largest ellipse that fits within the (imaginary) rectangle drawn by the mouse (Figure 24).

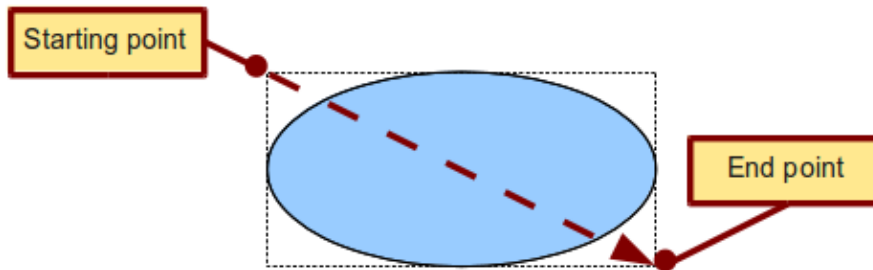

Figure 24: Drawing an ellipse

There are three ways to draw an ellipse or a circle:

- Holding down the *Shift* key while dragging with the mouse draws a circle.
- Holding down the *Alt* key (together with the *Shift* key) draws a symmetrical ellipse (a circle) with the starting point at the center.
- Holding down the *Ctrl* key while dragging with the mouse draws an ellipse or circle that snaps to the nearest grid points.

Note

If you first press and hold the *Ctrl* key down and then click on one of the icons for Line, Rectangle, Ellipse or Text, a standard sized object is drawn automatically in the work area: the size, shape, and color are all standard values. These attributes can be changed later, if desired. This only works if the icon has no associated toolbar—no arrow on the right side of the icon.

Adding ellipse and arc tools to the Drawing toolbar

In previous versions of Draw, a long-click on the ellipse button opened a new toolbar that contained tools for drawing elliptical and circular arcs. This function is not directly available in Version 3.3.

If you really need this tool, you can add an *Ellipse* toolbar to the Drawing toolbar:

- 1) Click on the arrow on the right-hand end of the Drawing toolbar and select **Customize Toolbar**.
- 2) On the **Toolbars** page of the Customize dialog, select **Drawing** in the *Toolbar* field and click **Add**.
- 3) In the Add Commands dialog (Figure 25), select **Drawing** in the *Category* list, select the *first Ellipse* command in the *Commands* list, click **Add**, and then click **Close**.

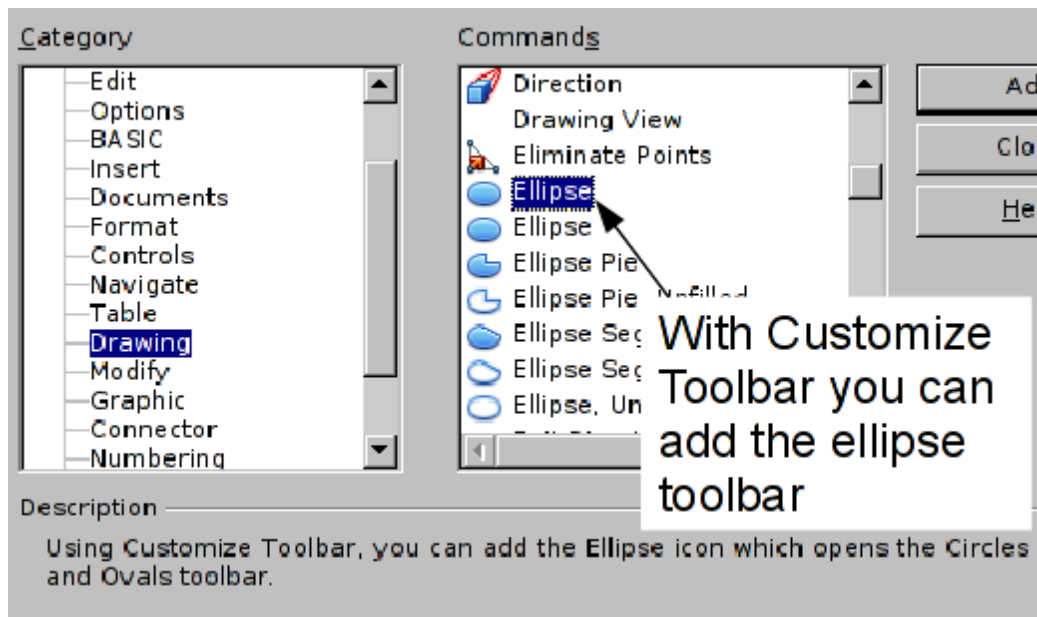



Figure 25: Adding the extended Ellipse toolbar

- 4) On the Customize dialog, ensure that the checkbox by the new **Ellipse** command is selected, and then use the up and down arrow buttons to move it to the desired position on the toolbar.
- 5) To remove the simple **Ellipse** icon from the Drawing toolbar, click to highlight it in the Customize dialog, and press the *Delete* key (or click the **Modify** button and choose **Delete** from the drop-down menu).
- 6) Click **OK** to complete the process.

You should now see this **Ellipse** icon  on the Drawing toolbar. If you use this icon instead of the standard **Ellipse** icon, all the extended ellipse functions are available. Clicking on the black arrow by the icon opens the floating **Circles and Ovals** toolbar (Figure 26).

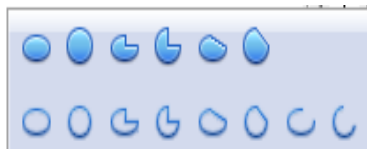

Figure 26: Circles and Ovals toolbar

Drawing elliptical and circular arcs

To draw an arc, choose the appropriate **Arc** symbol in the **Circles and Ovals** toolbar. Drag with the mouse to create a guide circle or ellipse.

Release the mouse button and move the cursor to the position where you want the arc to start. In the status bar, you can measure the actual angle in degrees. Single-click this point; the circle (or ellipse) disappears and moving the mouse creates the arc. Again, the status bar shows the current angle.

When you have drawn the arc to the length you want, click once more. The drawing of the arc is complete.



Curves

The tools for drawing curves or polygons are on the toolbar that appears when you click the **Curve** icon  on the Drawing toolbar. This toolbar contains eight tools (Figure 27).

Note

Hovering the mouse pointer over this icon gives a tooltip of *Curve*. If you convert the icon to a floating toolbar, however, the title is *Lines*, as shown in Figure 27.

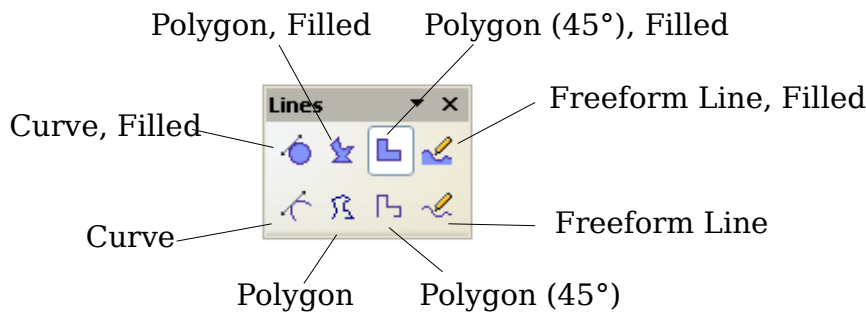

Figure 27: Curves toolbar (incorrectly titled “Lines”)

If you move the mouse cursor over one of the icons, a tooltip pops up with a description of the function. For a more detailed description of the handling of Bézier curves (curves and filled curves), see Chapter 10 (Advanced Draw Techniques).

- **Polygons:** Draw the first line from the start point with the left mouse button held down. As soon as you release the mouse button, a first corner point is drawn; move the mouse to see how subsequent lines will look. Every mouse click sets another corner point. A double-click ends the drawing. A filled polygon automatically joins the last point to the first point to close off the figure and fills it with the current standard fill color. A polygon without filling will not be closed at the end of the drawing.
- **Polygon 45°:** Like ordinary polygons, these are formed from lines but with angles of only 45 or 90 degrees between them.

- *Freeform Line*: With this tool you can draw just like with a pencil. Press and hold the left mouse button and drag the mouse. It is not necessary to end the drawing with a double-click. Just release the mouse button and the drawing is completed. If you have selected *Freeform Line, Filled*, the end point is joined automatically to the start point and the object is filled with the appropriate color.

Gluepoints and connectors (basics)

Gluepoints

All Draw objects have associated invisible *gluepoints*, which become visible when you choose any of the connectors under the **Connectors** icon  on the Drawing toolbar and then move the mouse pointer over the object.

Most objects have four gluepoints, as shown in Figure 28. You can add more gluepoints, and customize gluepoints, using the toolbar of the same name (Figure 29).

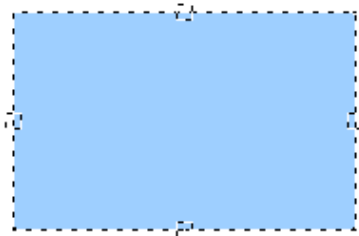

Figure 28: Four gluepoints



Figure 29: Gluepoints toolbar

Gluepoints are not the same as the little blue or green “handles” of an object. The handles are for moving or changing the shape of an object, as described in Chapter 3 (Working with Objects and Object Points), but the gluepoints are used to “glue” a connector to an object.

For a more detailed description of the use of gluepoints, see Chapter 9 (Organization Charts, Flow Diagrams, and More).

Connectors

Connectors are lines or arrows whose ends automatically dock to a gluepoint of an object. Connectors are especially useful in drawing organization charts, flow diagrams, and mind-maps. Even when objects are moved or reordered, the connectors remain attached.

Figure 30 shows two Draw objects and a connector.

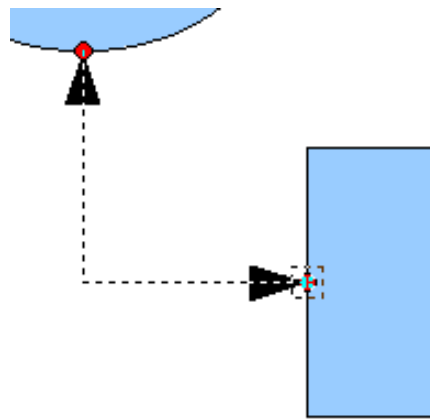

Figure 30: A connector between two objects

Draw offers a range of different connectors and connector functions. Open the floating Connectors toolbar by clicking on the arrow next to the **Connector** icon (Figure 31).

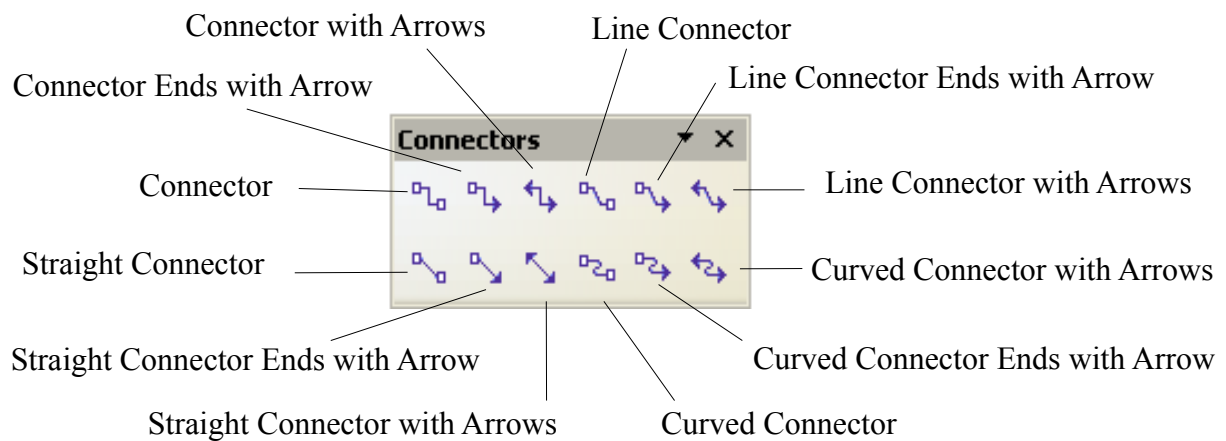

Figure 31: The Connectors toolbar

For a more detailed description of the use of connectors, see Chapter 9 (Organization Charts, Flow Diagrams, and More).

Drawing geometric shapes

Geometric shapes include:

- Basic shapes
- Symbol shapes
- Block arrows
- Flowcharts
- Callouts
- Stars

Note

If you select shapes for editing, the information field in the toolbar shows the type of shape selected and, if more than one object is selected, the total number.

Figure 32 shows part of the Drawing toolbar with the icons referred to in the following sections. Clicking on the arrow next to the icon opens a floating toolbar with the relevant work tools.



Figure 32: Part of the main Drawing toolbar

Tip

The use of all these tools is similar to that of the Rectangle tool, even though they produce different geometric shapes.

Basic shapes

The **Basic Shapes** icon  makes available a range of tools for drawing basic shapes, including a rectangle tool identical to the one on the main toolbar.

The only differences you will see are in the information field in the status bar (in this case “Shape selected” rather than “Rectangle selected”).

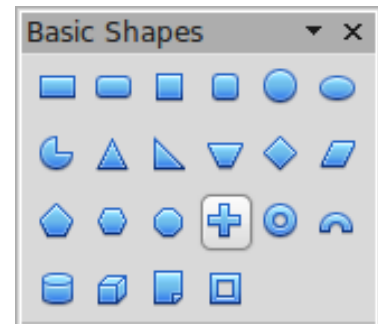

Symbol shapes

The **Symbol Shapes** icon  gives you an array of tools for drawing various symbols.

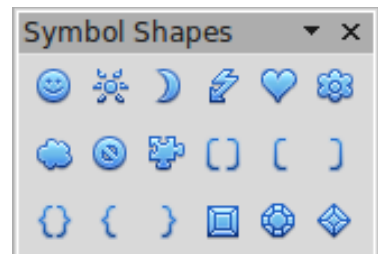

Block arrows

The **Block Arrows** icon  opens the Block Arrows toolbar.

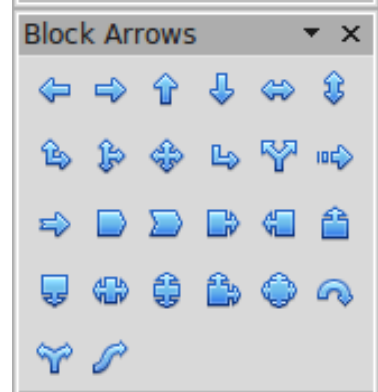

Flowcharts

The tools for drawing flowcharts are accessed by clicking on the **Flowcharts** icon .

The creation of flowcharts, organization charts, and similar planning tools are described in Chapter 9 (Organization Charts, Flow Diagrams, and More).

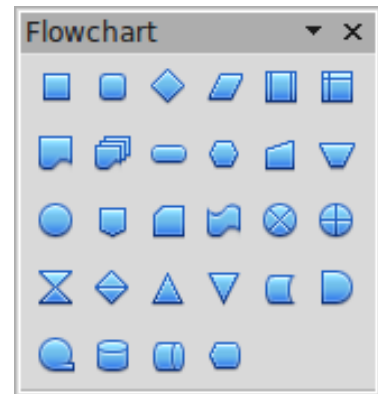

Callouts

Use the **Callouts** icon , to open the Callouts toolbar.



Stars and banners

These tools are associated with the **Stars** icon .

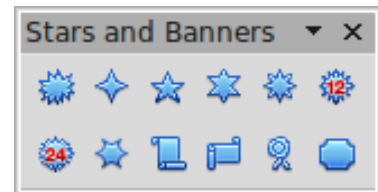

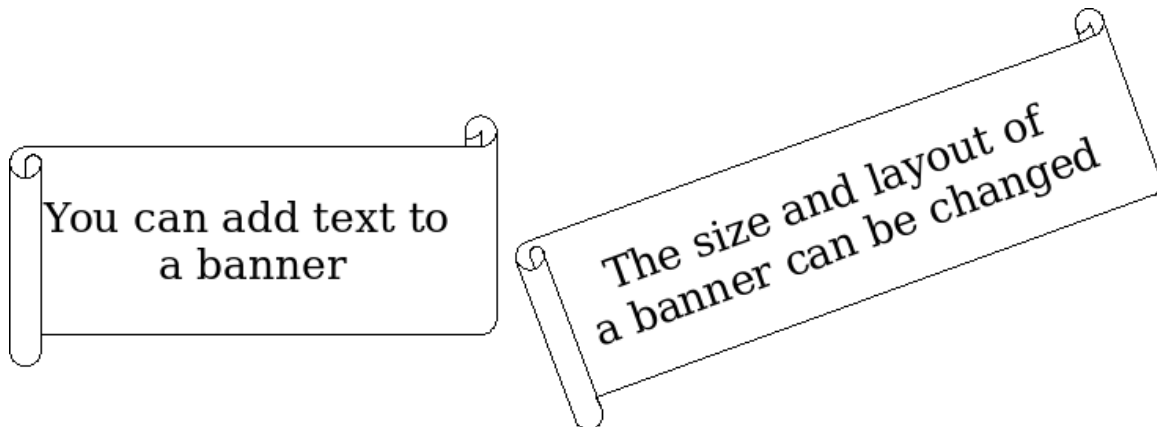

You can add text to all these shapes. See “Using text elements in Draw objects” on page 37.



Adding text to objects

Draw offers two ways to add text to a drawing: in a dynamic text frame as an independent Draw object or as text contained within a previously drawn object. In the latter case, the text is integrated with the object.

Using dynamic text frames

The text tool is activated by clicking on the **Text** icon  for horizontal text or the **Vertical Text** icon  for vertical script (to be able see the icon and use this latter option, you must check *Enabled for Asian languages* under **Tools > Options >**

Language Settings > Languages). If you still do not see the Vertical Text icon, enable it on the Drawing toolbar by clicking the arrow on the right hand side of the toolbar, select Visible Buttons, and click on Vertical Text to make this icon show on the toolbar.

Text frames can be moved and rotated like all draw objects. For more details on text input, see Chapter 10 (Advanced Draw Techniques).

After activating Text command mode, click at the location where you want to position the text. A small text frame appears. It contains only the cursor. You can move the frame, if desired. The Text Formatting toolbar appears (Figure 33), and you can choose the font type, font size, and other text properties and begin to type in your text.

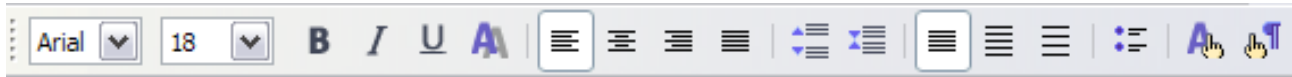

Figure 33: Text Formatting toolbar

The text frame grows with the text. You can insert a line break with the *Shift+Enter* key combination. The *Enter* key begins a new paragraph. Neither line breaks nor new paragraphs terminate the text frame.

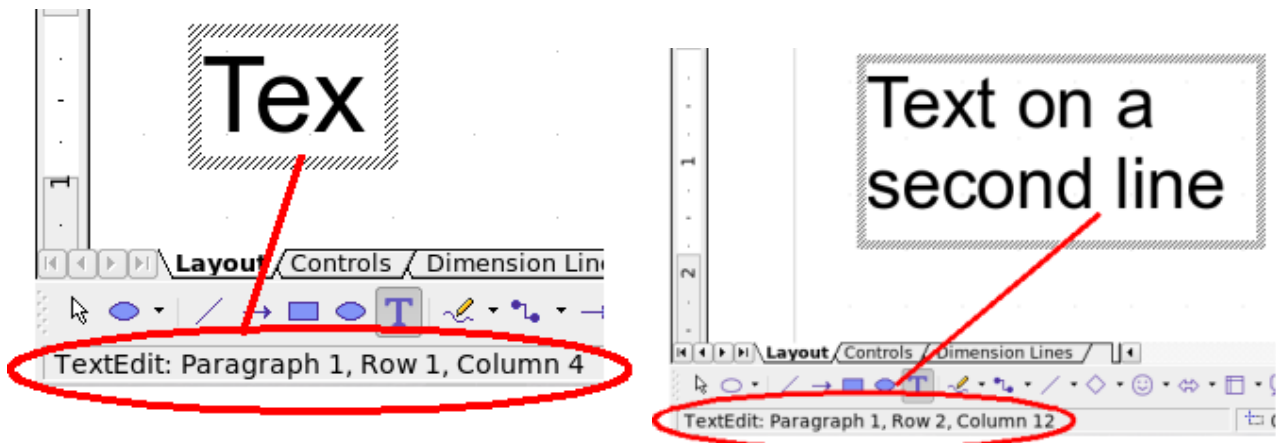

Figure 34: Text input in a dynamic text frame

Observe the information field in the status bar: it shows that you are editing text and also provides details about the current cursor location—paragraph, line, and column numbers.

Text properties can also be changed during text input. Any changes will be reflected from the cursor position onwards (Figure 35).

Text input – properties
changed

Figure 35: Changing text properties

After choosing the **Text** icon, you can also draw a frame with the mouse to contain future text. You can move the frame only after typing some text in it. Line breaks are inserted automatically at the right edge of the frame when the text fills the frame

width (Figure 36). You can, however,—just as when editing any other text—insert your own line breaks, begin new paragraphs, or change any of the text properties.

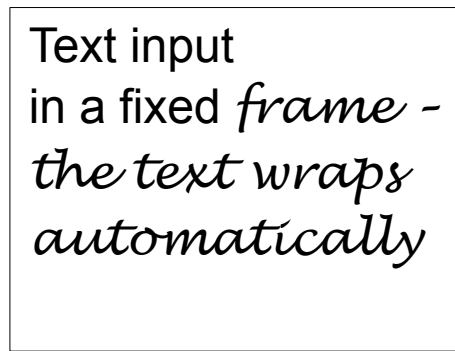



Figure 36: Text frame

Using text elements in Draw objects

A text element is associated with most Draw objects. By means of these elements, text can be added to an object (see Figure 37).

The exceptions to this are control elements like buttons or list boxes, as well as 3D scenes and their associated elements and groups.

If the **Double-click to edit Text** icon  on the Options toolbar is active, you can start editing an object by double-clicking on it (or by pressing *F2*). In the middle of the Draw object, a black bar indicates the text cursor; start typing to input text. The status bar shows “Text Edit” at the lower left and the position of the cursor within the text.

Text can contain paragraphs, and these can be in the form of bulleted or numbered lists. To begin a new line without beginning a new paragraph, use the key combination *Shift+Enter* (as in text documents). To end the text input, click next to the object or press the *Esc* key.

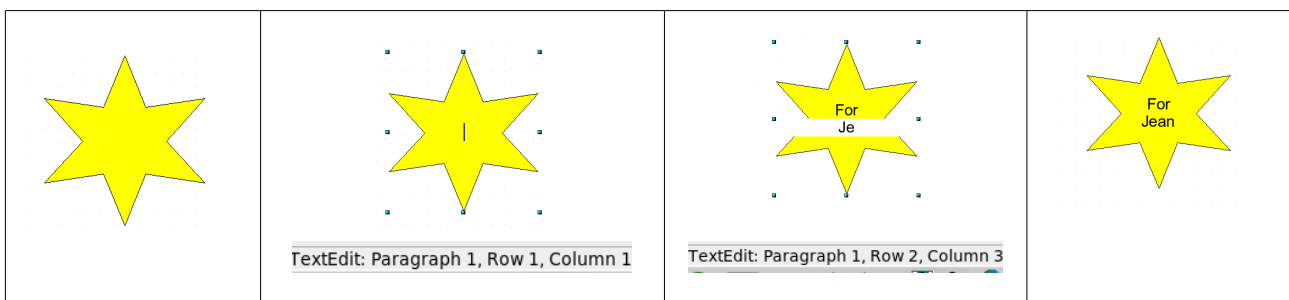

Figure 37: Adding text to objects

Chapter 3
Working with Objects
and Object Points

Introduction

This chapter looks at the tools and functions that let you modify existing drawings. All of the functions apply to a selected object or group of objects, which can be distinguished by small colored squares or circles located around it. These points are called *handles*.

The handles form a rectangular frame that is just big enough to contain the object. Where several objects are selected, the frame around them corresponds to the smallest rectangle that can contain all of the objects. This frame is called the *selection rectangle*.

If the Options toolbar is displayed (select **View > Toolbars > Options** to turn it on, if it is not displayed), you can change the size of the handles using two buttons: **Simple Handles** shows the handles as flat squares; otherwise they are shown in 3D. **Large Handles** increases the size of the handles. You can combine the two effects. The figure below shows the location of the handles and other buttons.



Figure 38: Location of handles on the Options toolbar

Selection modes

There are three selection modes:

- 1) Moving and changing size
- 2) Editing
- 3) Rotating points

To set the default mode (1 or 2) for selecting objects, click on the **Points** button  on the **Drawing** toolbar.

In standard mode (when you begin a new drawing), the Points button is not active, and the default mode is for selections to be moved or changed in size; these selections are indicated by small green squares.

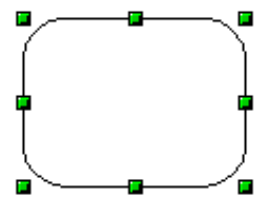

When the Points button is active, the default mode is for selections to be edited; these selections are indicated by blue squares. Some objects will have one or more extra handles, which are larger or colored differently. This is explained in more detail in “Editing object points” on page 48.

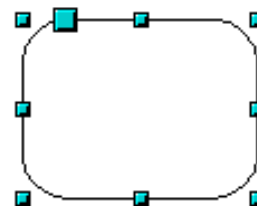



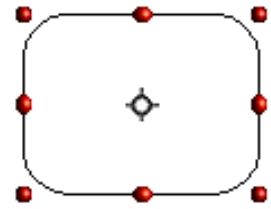

Selections for rotating objects are indicated by small red circles and a symbol representing the center of rotation. To choose these selections, click on the Effects drop-down button  from the Drawing toolbar and after that on the object.



Changing the selection mode

To go from one mode to another, you can do one of the following:

- Choose the **Points** button  from the **Drawing** toolbar to switch from simple selection mode to Points mode. You can also use the keyboard shortcut *F8* (Points). See “Editing object points” on page 48 for details on using Points mode.
- Choose the **Effects** drop-down button from the **Drawing** Toolbar  to activate the Rotation mode for a selected object. To exit Rotation mode, click on the **Selection** icon .
- If you often work in Rotation mode, you can choose the **Rotation Mode after Clicking Object** button  from the **Options** bar and cycle through normal and rotation modes just by clicking on the object. This can be more convenient than repeatedly clicking the selected object, then clicking the **Rotate** button from the **Drawing** toolbar.

Selecting objects

Direct selection

The easiest way to select an object is to click directly on it. For objects that are not filled, click on the object’s outline to select it. One click selects; a second click deselects. To select or deselect more than one object, hold the shift button down while clicking.

Selection by framing

You can also select several objects at once by using the mouse to drag a large rectangle around the objects with the **Select** button, as shown. For this to work, the  icon on the Drawing toolbar must be active.

Only objects that lie entirely within the rectangle will be selected.

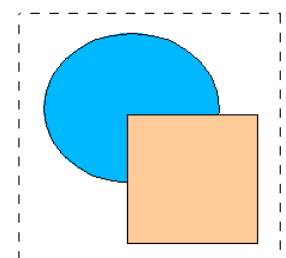

Selecting hidden objects

Even if objects are located behind others and not visible, they can still be selected. Hold down the *Alt* key and click where the object is located. If there are several overlapping objects, hold down the *Alt* key and click until you reach the object you want. To cycle through the objects in reverse order, hold down the *Alt+Shift* keys and

click. The number and type of the selected objects is shown at the left of the status bar to help you to select the correct object.

Note

This method generally works in Windows, but on a Linux system it usually does not. If the *Alt* key on your system does not operate as described above, use the *Tab* key method described below.

To select an object that is covered by another object using the keyboard, use the *Tab* key to cycle through the objects, stopping at the object you wish to select. To cycle through the objects in reverse order, press *Shift+Tab*. This is a very quick way to reach the object you want, but it may not be practical if you have a large number of objects in your drawing.

When you click on the selected object, its outline will appear briefly through the objects covering it.

In the illustration to the right, the square located beneath the circle was selected in this way (the circle has been made semi-transparent in order to show the square).

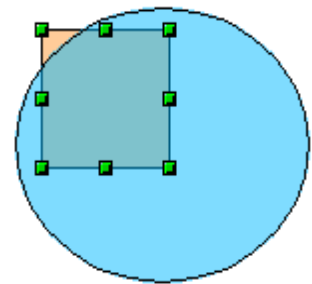

Arranging objects

In a complex drawing, several objects may be stacked on top of one another. To rearrange the stacking order (move an object to the front or to the back of the stack), select the object, click **Modify > Arrange** and choose **Bring Forward** or **Send Backward**. Or right-click the object, choose **Arrange** from the context menu, then choose **Bring Forward** or **Send Backward**.

These options are also available from the Arrange tear-off toolbar accessible from the  icon on the Drawing toolbar. A keyboard shortcut is *Shift+Ctrl+plus sign* to bring an object to the top, and *Shift+Ctrl+minus sign* to send an object to the bottom.

Note, however, that an object located on the Controls layer always lies above all other objects.

Moving and dynamically adjusting an object's size

There are several ways of moving or changing the size of an object. The *dynamic* method described here uses the mouse.

When you dynamically change an object, remember to check the left-hand area of the status bar at the bottom of the Draw window. This area shows detailed information about the ongoing manipulation

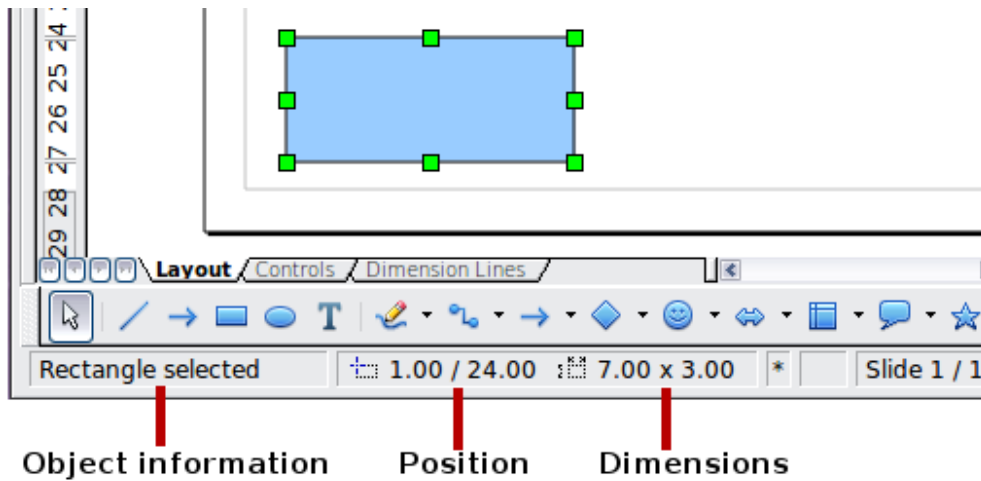
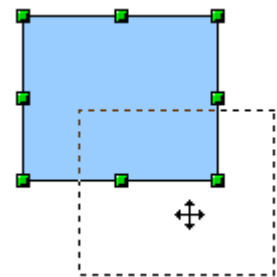

Figure 39: Left end of status bar during dynamic adjustment

For example, when you are resizing an object, the object information fields show which object is selected, the current position in X/Y coordinates, and object dimensions (width x height). The information changes as the mouse is moved. The units of measurement are those selected under **Tools > Options > OpenOffice.org Draw > General**.

Dynamic movement of objects

To move an object, select it and then click within the object's border and hold down the left mouse button while dragging the mouse. During movement, the shape of the object appears as dotted lines to help with repositioning.



To drop the object at its new location, release the mouse button. The new position appears immediately in the Status Bar.

Dynamic size modification of objects

To change the size of a selected object (or a group of selected objects) with the mouse, move one of the handles located around the selection. As shown in the illustration, the outline of the resulting new object appears as a dotted line while the mouse button is pressed.

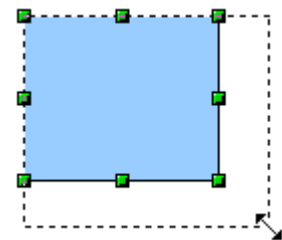

The results depend on which handle you use. To resize an object along one axis, use the appropriate side handle. To resize along both axes, use a corner handle. The new size appears immediately in the status bar.

Note

If you press the *Shift* key while resizing an object, the change in size will be carried out symmetrically with respect to the two axes, so that the aspect ratio of the object remains the same.

Caution



This is the default behavior of the *Shift* key. However, if you have used **Tools > Options > OpenOffice.org Draw > Grid** to set *Snap position* to *When creating or moving objects*, the action of the *Shift* key is the opposite: the aspect ratio will be preserved *unless* the *Shift* key is pressed.

Dynamic size modification of objects with the help of the status bar

If you select an object and modify it using the mouse, the changes are immediately reflected in the information field of the status bar. With geometric *shapes* (such as basic shapes, symbol shapes, block arrows), the only information shown in the status bar is that the shape is being resized, as shown in the top-left image in Figure 40. With geometric *elements* (rectangles, circles, and so on), the changes to the attributes of the element (either relative or absolute) are also shown, as in the top-right image in Figure 40.

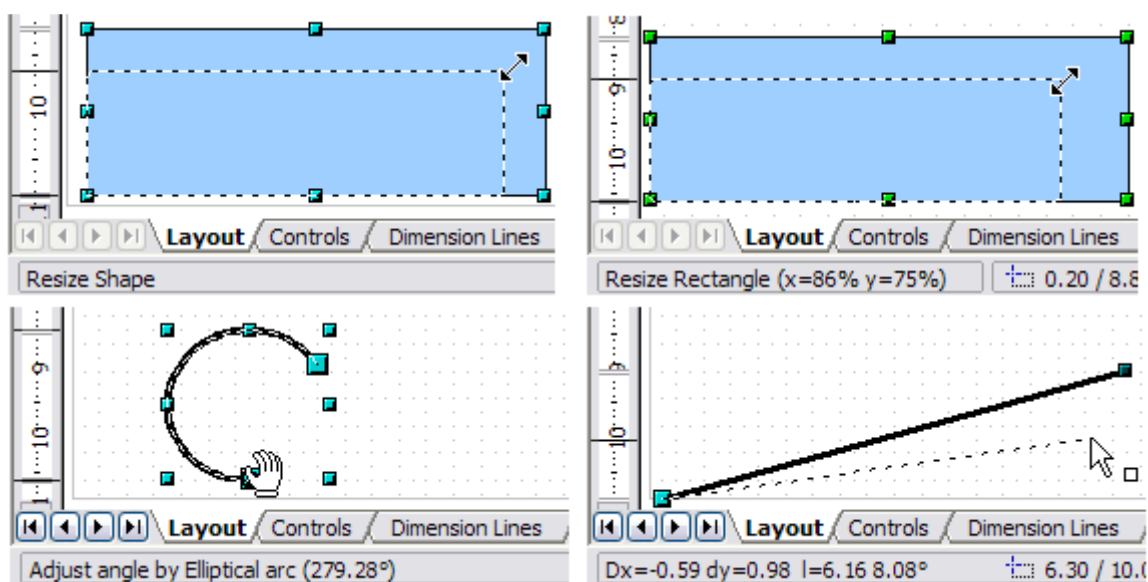

Figure 40: The Information field during dynamic size modification of objects

In the case of a rectangle, the new size is shown as percentages of the original x and y dimensions. For a line, much more information is given: the absolute change in x and y coordinates of the end point being moved, together with the current length and bearing of the modified line. These are updated dynamically as the end point is moved (see Figure 40).

This is the only place where the exact start and end angles of an arc or the length and bearing of a sloping line are shown. This information enables you to size the object with considerable accuracy.

Modifying an arc

The beginning and end points of an arc can be modified. Select the arc and click on

the **Points** icon  on the Drawing toolbar to enter the Edit points mode (described later in this chapter). In this mode, the handles on the selection frame change—two larger blue handles appear at the beginning and end points of the arc. When the mouse hovers over one of these points the cursor will change to a hand.



Figure 41: Editing an arc

If you click and hold the mouse button when the hand cursor appears, moving the mouse will change the location of the start or end point of the arc. The actual coordinates are shown in the Status Bar (see lower left graphic in Figure 40).

Rotating and shearing an object using the mouse

Use the red rotation handles to either rotate an object around an axis or slant or shear the object.

Rotating

To rotate an object (or a group of objects), drag a red corner handle point of the selection with the mouse. The mouse cursor takes the shape of an arc of a circle with an arrow at each end. A dotted outline of the object being rotated appears and the current angle of rotation is dynamically shown in the status bar.

Note

Rotation works in a slightly different way for 3D objects because the rotation occurs in 3D space and not in one plane. See Chapter 7 (Working with 3D Objects) regarding rotation when the Edit Points mode is active.

Rotations are made about an axis which is displayed as a small symbol. This is normally located at the midpoint of the object, but you can move the axis of rotation with the mouse to any location you like, even outside the object.

If you hold down the *Shift* key during the rotation, the operation will be carried out in increments of 15° (subject to whether *Snap position* is set to *When creating or moving objects* under **Tools > Options > OpenOffice.org Draw > Grid**).

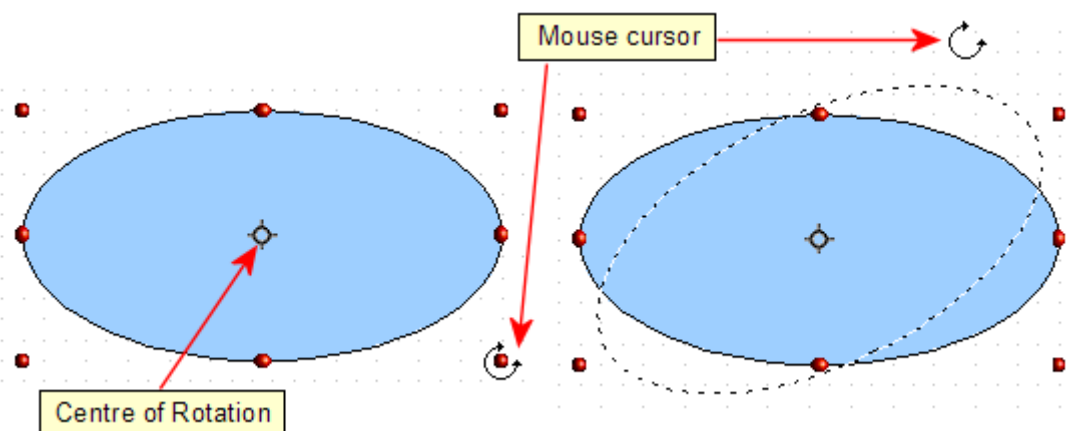



Figure 42: Rotating an object

Changing inclination or perspective

To slant or shear objects, use the red handles located at the midpoint of an edge of the selected objects. The mouse pointer changes to a  when the pointer hovers over one of these midpoint handles.

Note

In current versions of Draw, basic shapes can be sheared and slanted. The effect however will probably be different to that obtained when a classic object has the same slant or shear applied to it, particularly when the mouse is used to create the effect.

The slant axis is the point directly opposite the midpoint handle to be used for shearing the object. This point stays fixed in location; the other sides and edges move in relation to it as the mouse is dragged (make sure that the  icon is showing before dragging).

Figure 43 shows how the vertices move in relation to each other during the shearing process. The circles represent the path of the vertices. The inclination axis is the bottom vertex of the triangle (the slanting handle used is the midpoint of the upper enclosing frame). All points on the figure will move through the same angle irrespective of the final shape. The actual angle is shown in the status bar.

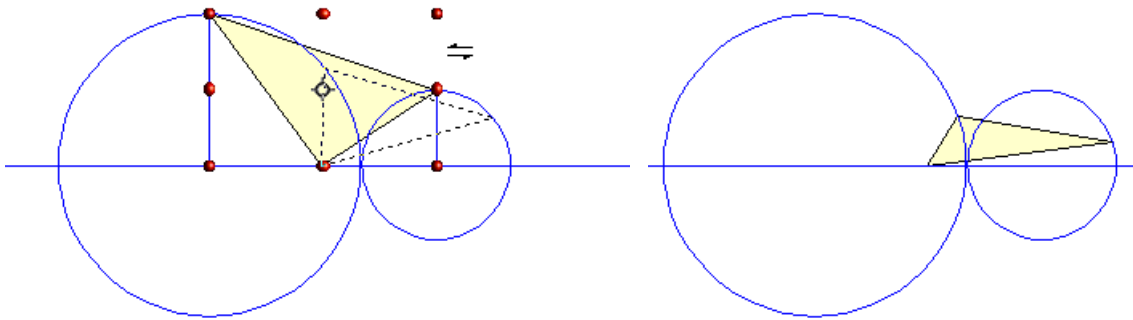

Figure 43: Shearing an object

Note

The triangle in Figure 43 was produced with the (unfilled) polygon tool and then **Close Object** was selected from the context menu.

This tool can be used to produce perspective drawings. The series of pictures in Figure 44 shows the method of constructing a cuboid or rectangular prism. To shorten the edges leading from front to back, reduce the length before you distort the height or width of the surface.

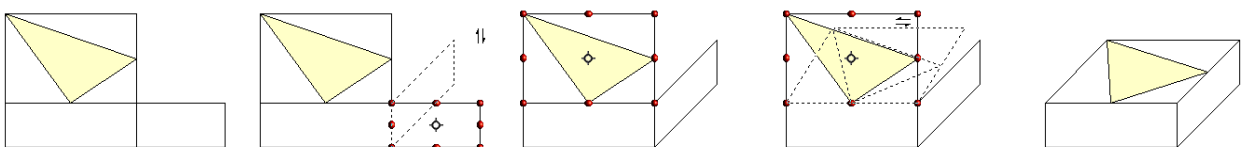

Figure 44: Perspective production of a cuboid

As with rotation, you can make the slanting occur in steps of 15° by pressing the *Shift* key while moving the handle.

Setting size and position exactly

You can position and resize objects with the mouse, but this method is not very exact. If you need accurate positioning of objects, use **Format > Position and Size** from the menu bar, or right-click the object and select **Position and Size** from the context menu, or press *F4*.

Position and Size

Open the **Position and Size** dialog (see Figure 45) and click on the first tab to set the appropriate values.

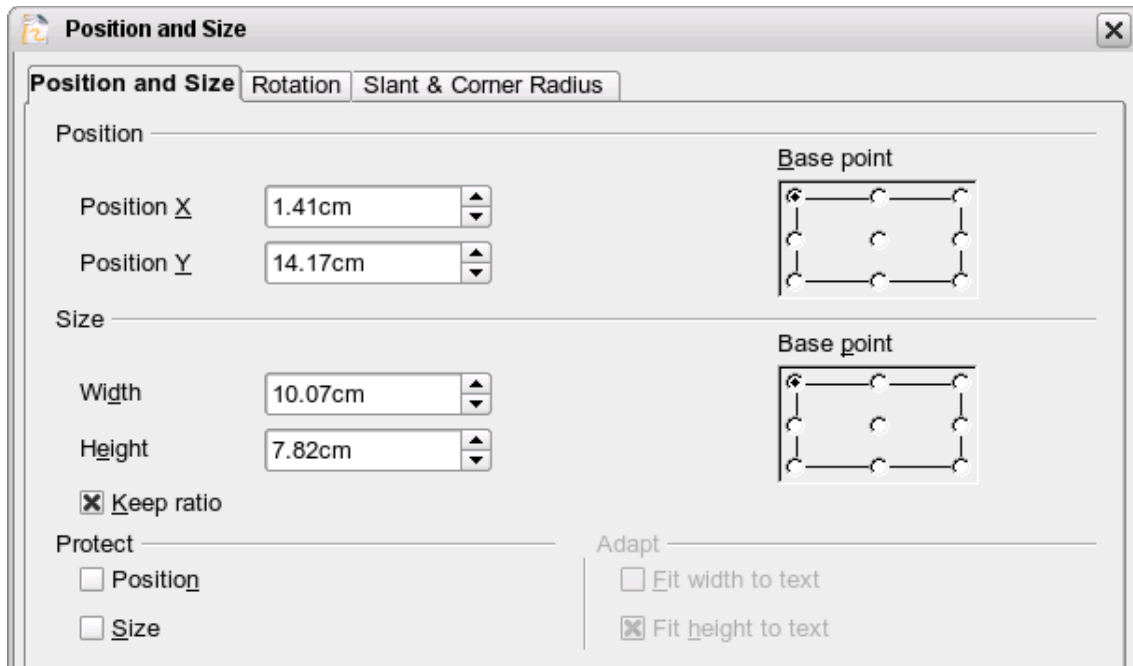

Figure 45: Position and size of an object

Position is defined as an X,Y coordinate relative to a fixed point (the *base point*), typically located at the upper left of the drawing area. If desired, you can temporarily change this base point to make positioning or dimensioning simpler (click on the radio button corresponding to the location of the base point in either of the two selection windows on the right side of the dialog—upper for positioning or lower for dimensioning). The possible base point positions correspond to the handles on the selection frame plus a central point. The change in position lasts only as long as you have the dialog open; when you close this dialog, Draw resets the base point to the standard position.

Tip The **Keep ratio** checkbox is very useful. Click it to keep the ratio of width to height fixed while you change the size of an object.

Either or both the size and position can be protected so that they cannot be inadvertently changed. Check the appropriate boxes to achieve this.

Tip You cannot move an object? Check to see if the position is protected!

Rotating objects

Click on the **Rotation** tab of the **Position and Size** dialog (see Figure 46). Here you can define the rotation angle, as well as the location of the pivot point.

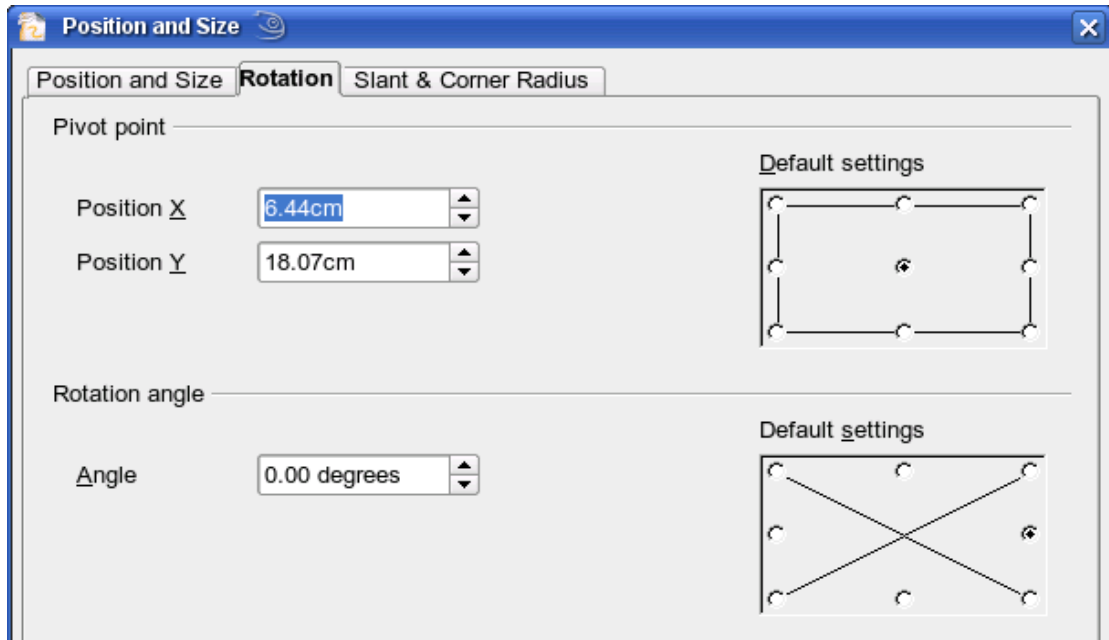

Figure 46: Rotating an object

Slant and corner radius

The slant angle (inclination or shearing) and corner radius can be set in this dialog (Figure 47).

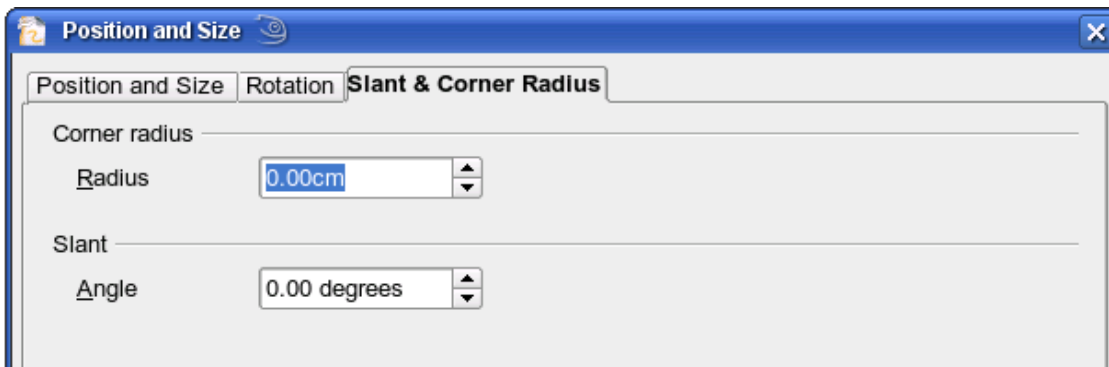

Figure 47: Setting rounded corners and slant angle

Corner radius

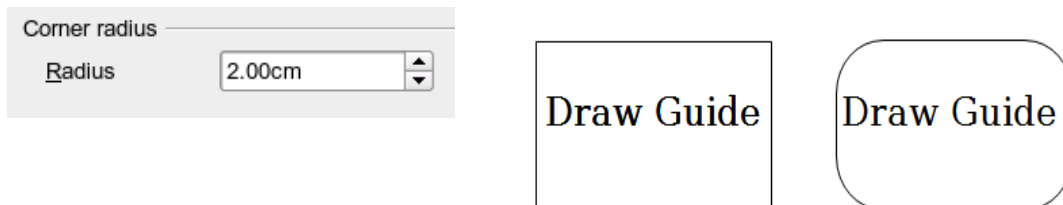

Figure 48: Example of setting rounded corners

You can use this dialog to round the corners of the usual Draw objects—text boxes, legends, rectangles, and squares, as shown in Figure 48. The same effect can be achieved when you are in the points mode (click the **Points** icon on the Drawing toolbar), by dragging the large handle with the mouse. The larger the value for the corner radius, the rounder the object becomes.

Slant

You can shear both the older, classic Draw objects and the newer Shape objects. Enter the slant angle in the box marked *Slant Angle*.

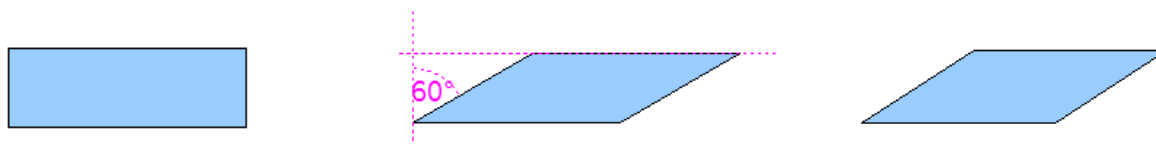

Figure 49: Example of setting the slant angle

Editing object points

For polygons and Bézier curves, Draw offers a complete set of tools that let you accurately edit the contour of an object. To edit other objects in the same way, you must first convert them into curves. To do this, select the object, then right-click and choose **Convert > To Curve** or choose **Modify > Convert > To Curve** from the menu bar.

You can also convert the shapes to a polygon (**Convert > To Polygon**). With polygons, the edge points are always connected with straight lines and not with curves. Some of the techniques described work equally with polygons as with curves.

Another way to change the form of basic shapes

In current versions of Draw, many of the new shapes can be directly edited without having to convert them to curves first. You can recognize these objects by the presence of one or more circular yellow handles as shown in Figure 50.

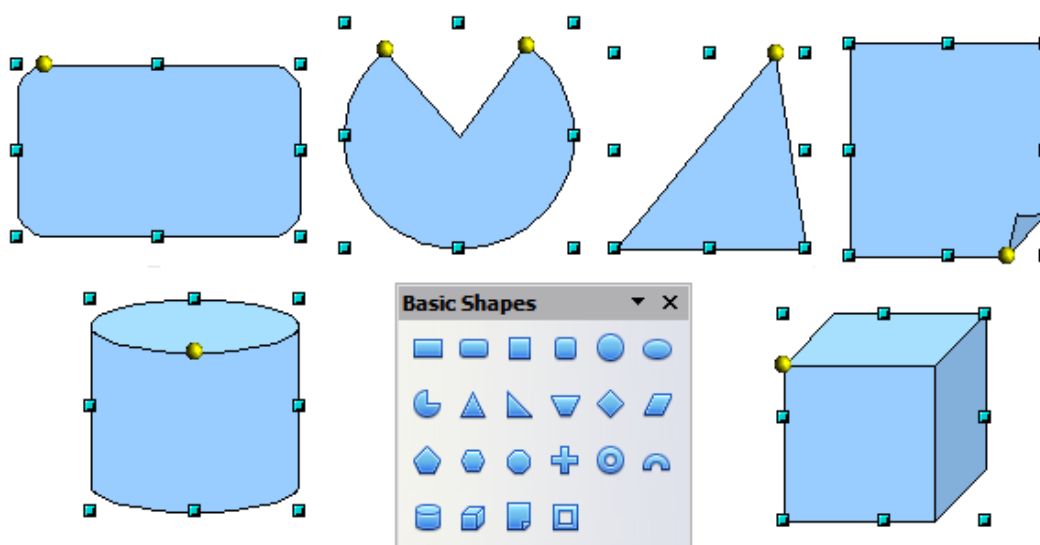

Figure 50: Some basic shapes with yellow “handles”

The mouse pointer changes shape when hovered over a yellow handle. If you drag one of these handles, you can modify the shape of the object; the type of change is dependent on the shape itself. For example, you can round the corners of a rectangle or square, change the angles of an arc or ellipse, or alter the control points of a circular or elliptical segment.

How curves work

The editing of curves depends on the mathematics of Bézier curves¹. The complete study of such curves goes beyond this scope of this guide, and only the basics are covered here. Chapter 10 (Advanced Draw Techniques) provides more information on drawing and manipulating Bézier curves.

The editing of a Bézier curve consists in principle of moving points or tangents passing through these points. Each tangent has two control points—one at each end—and a junction point where it meets the curve. The relative angle and distance between the control points determine the shape of the curve. Figure 51 shows several variations starting from a basic circle and changing only one point on the circle.

You can create many different shapes by moving either the junction point itself, or one or both of the round handle points at either end of the tangent.

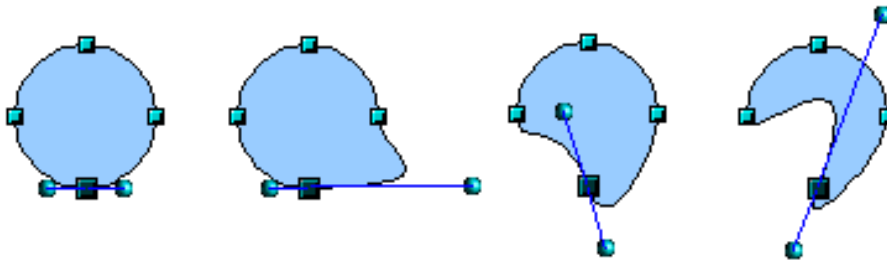

Figure 51: Creating different shapes by changing the tangent

Draw offers even more possibilities when you use the functions on the Bézier curve Edit Points toolbar.

The Edit Points toolbar

When you work in Edit Points mode, use the Edit Points toolbar, shown in Figure 52. To activate this toolbar, choose **View > Toolbars > Edit Points**. It will then appear whenever you select a curve and the Edit Points icon on the Drawing toolbar is active.

On this toolbar, icons may be active or inactive depending on the selected object and object point. With the Convert to Curve icon, you can determine for individual points whether their connection will be made with straight lines or with curves.

Only with curves are the icons for tangents activated. An object that contains no curves is treated as a polygon.

¹ Bézier curves were invented by Pierre Bézier, an engineer working with the Renault car manufacturer, who developed the technique in the 1960s. The technology was intended to make modeling the surface of vehicles easier.

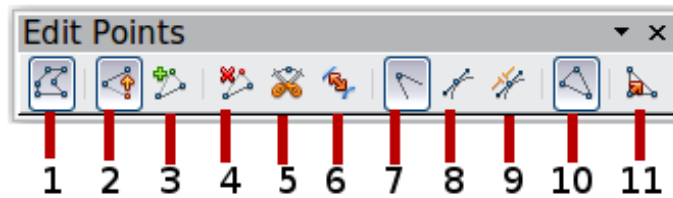

- | | | |
|-----------------|---------------------|------------------------|
| 1 Points | 5 Split Curve | 9 Symmetric Transition |
| 2 Move Points | 6 Convert to Curve | 10 Close Bézier |
| 3 Insert Points | 7 Corner Point | 11 Eliminate Points |
| 4 Delete Points | 8 Smooth Transition | |

Figure 52: Edit Points toolbar

The three kinds of tangent

Three buttons in the Edit Points Toolbar let you select the type of tangent and convert from one type to another. Only one of these buttons can be active at any given time. Their use is described in the following chapter.



Figure 53:
Symmetric
tangent



Choose the **Symmetric Transition** button  to work with a symmetrical tangent (Figure 53). Any movement of one or the other of the handles is carried over symmetrically to the other handle.



Figure 54:
Asymmetric
tangent

Choose the **Smooth Transition** button  to separately adjust the lengths of the two parts of a tangent and so make the curve flatter or steeper. In Figure 54, the curve is flatter on the longest side of the tangent. The tangent remains as a single straight line. This kind of tangent is known as a smooth junction.

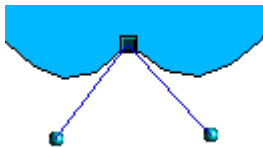



Figure 55:
Inflexion point

It is also possible to separate both sides of the tangent from the curve. In this case, the central point is known as the *inflexion point*. Using this technique, you can draw spikes and troughs in objects. Choose the **Corner Point**

button  to create an inflexion point around the selected point.

Examples

The other buttons in the Edit Points Toolbar are described here in relation to working examples. The following examples start from a filled circle. As mentioned earlier, in order to use Edit Points mode, you first need to convert the object to a curve.

You will notice that after the conversion, the handles located in the corners of the rectangle have disappeared. This behavior is normal in that the handles which are used in the Edit Points mode are located along the outline or trace of the drawn object.

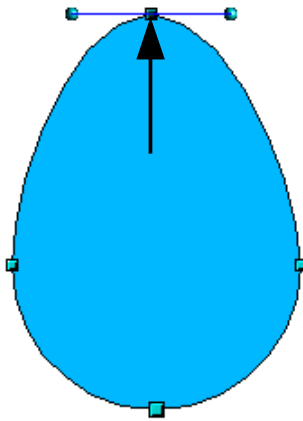

Figure 56: Moving a junction point

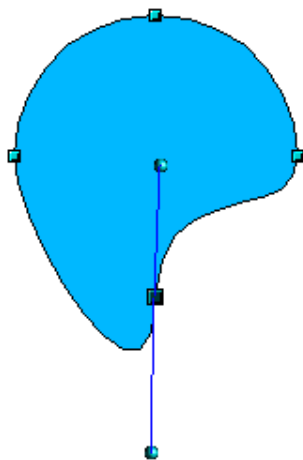

Figure 57: Rotating a tangent

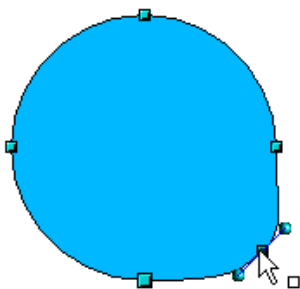



Figure 58: Adding an edit point to a curve

The **Move Points** button  is the default mode when editing points. If it has not been activated, click on its button. When this mode is active, the mouse pointer has the following shape when it is hovered over an edit point:



Movement of a point is one of the easiest manipulations to do. Figure 56 illustrates how you can draw an egg very easily by starting from a circle and dragging the top point upwards.

To change the direction or location of the tangents, move the circular handles at each end. The mouse pointer then looks like this:

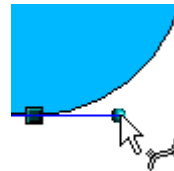

Use the **Points** button  to add an extra edit point to an existing curve. Click on the curve at the spot where you want to insert a point and then move the mouse slightly in any direction while holding down the button.

Caution



If you just click, the new point will not be added.

The tangent attributes associated with the new point depend on the buttons that are selected on the toolbar.

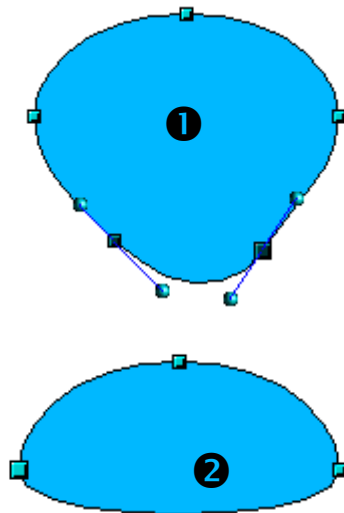



Figure 59: Deleting points from a curve

The **Delete Points** button  has the opposite effect: it subtracts one or more points from the curve. The resulting curve stretches itself automatically around the remaining points after subtraction.

Select one or more points to delete. You can select several points by holding down the *Shift* key (❶).

When you have selected the points you want to delete,

click the **Delete Points**  button. The selected points disappear from the curve, which then reforms around the remaining points (❷).

You can also delete the selected points by pressing the *Del* key on the keyboard.

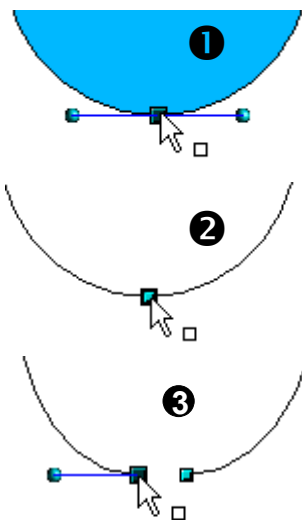



Figure 60: Cutting a curve

Use the **Split Curve** button  to split or cut a curve at the location of the selected handle. If the object is filled, it will be emptied because the curve that represented the edge is no longer closed.

Check that you have selected the correct handle (❶), click the **Split Curve** button (❷) and notice that the object is no longer filled. You can then check, by moving the point, that the curve has indeed been separated (❸).

If you have an open curve, the start point of the curve is larger than the others.

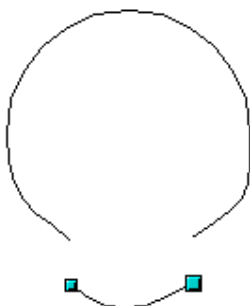
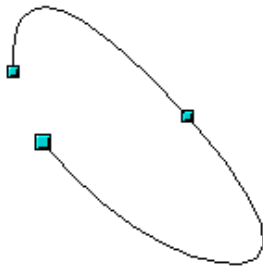



Figure 61: Moving a segment

You can also separate a curve at several points simultaneously. Keep the *Shift* key pressed down and select all of the points at which the cut should occur.

Drag and drop segments with the mouse to move them from the original curve.



To close an existing curve, select an open curve and click on the **Close Bézier** button  .

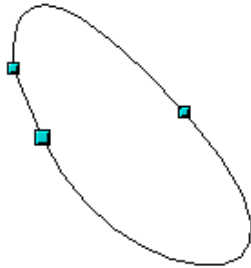

The opening point is identified by a slightly larger handle (Figure 62).

Figure 62: Closing an open curve



The **Eliminate Points** button  button only functions with lines with multiple points.

1.
Select object and set Edit points mode

If the button is active, click on a point, hold the mouse button down and move the mouse to draw virtual straight lines between the neighboring left and right points.

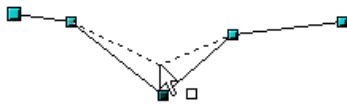

Release the mouse button when the two lines have more or less coalesced into one straight line. The point is deleted and the new line replaces the previous two lines, eliminating one point.

2.
Draw virtual lines

Note that this only works when the angle between the two lines (shown dashed in Figure 63) is less than a certain amount.

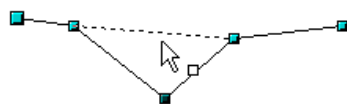

3.
Release mouse button

In the **Tools > Options > OpenOffice.org Draw > Grid** window there are options for snap settings relating to editing points when rotating and in point reduction mode.

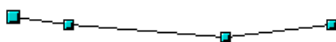
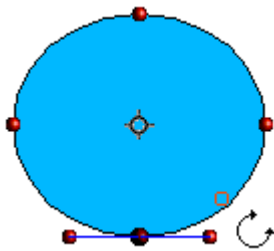
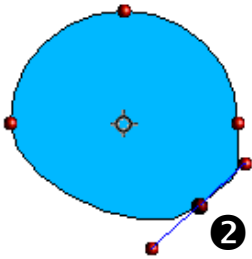

Figure 63: Reducing a line by one point





①



②

Figure 64: Moving a point on a curve

The **Rotate** function from the **Effects** drop-down button  on the Drawing toolbar and the **Rotation Mode**

after Clicking **Object** button  on the **Options** toolbar can be used in Edit Point mode. In this case, it can be used to move single points around the contour of an object.

Switch into rotation mode by clicking on either of the rotation buttons. Notice that in rotation mode, all of the tangent points become red dots.

Select the point to be moved and then drag it around the contour while keeping the left mouse button pressed down (①). When you release the mouse button, the point will be moved to the new position (②).

If you move one of the handles located at the end of the tangents during rotation, you will make the object rotate in exactly the same way as with the usual rotation operations.

Important: To exit the effects mode, do not just click on the **Effects** button; click the **Select** button  on the Drawing toolbar.



Chapter 4

Changing Object Attributes

Toolbars and menus

To change an object's attributes (such as color or border width) you can use the Line and Filling toolbar or the context menu.

Line and Filling toolbar

If the Line and Filling toolbar is not visible, you can display it using **View > Toolbars > Line and Filling**. From here you can edit the most common object attributes. You can also open the Line dialog by clicking on the Line  icon and the Area dialog by clicking on the Area  icon to see more options.

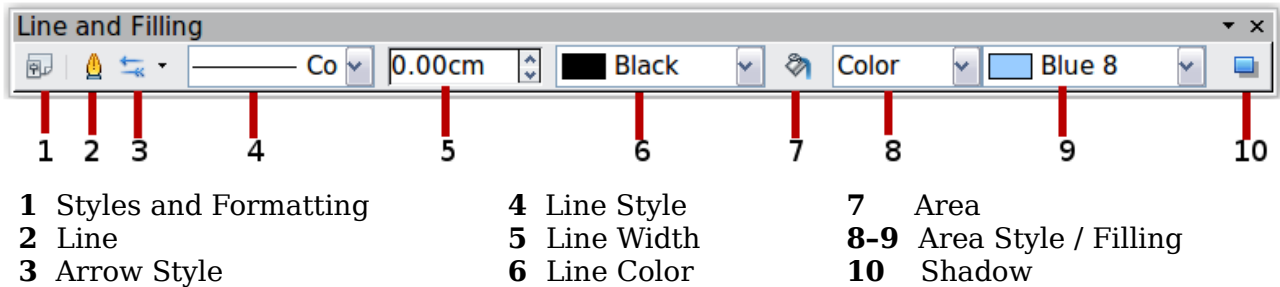

Figure 65: Line and Filling toolbar

Text Formatting toolbar

When you select text, the Line and Filling toolbar changes to show text formatting options. You can also display the Text Formatting toolbar by choosing **View > Toolbars > Text Formatting**.

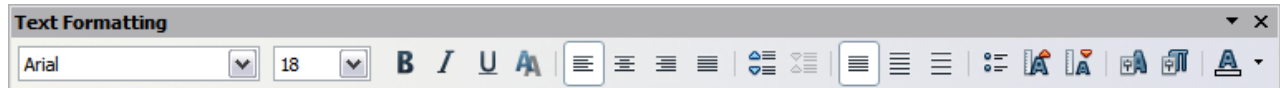

Figure 66: Text Formatting toolbar (when text is selected)

The context menu

When an object is selected, you can right-click on the object to bring up a context menu (Figure 67). The context menu provides additional access to the options shown above and another way to change an object's attributes. The entries with a small arrow on the right-hand side contain a submenu.

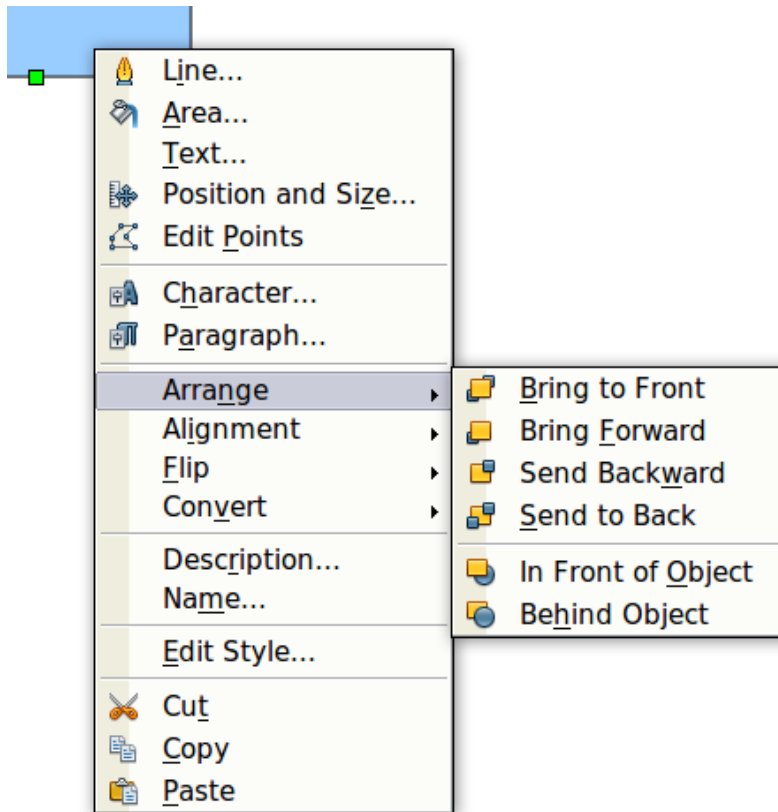

Figure 67: Right-click on an object to see the context menu

Editing lines and borders

Lines, arrows, and the borders of an object are managed through the same dialog (Figure 69).

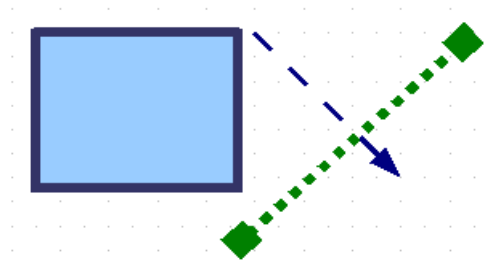

Figure 68: Lines and borders

You can change some properties from the **Line and Filling** toolbar. To see more options, select the object and right-click on the object and choose **Line** from the context menu. This opens the Line dialog.

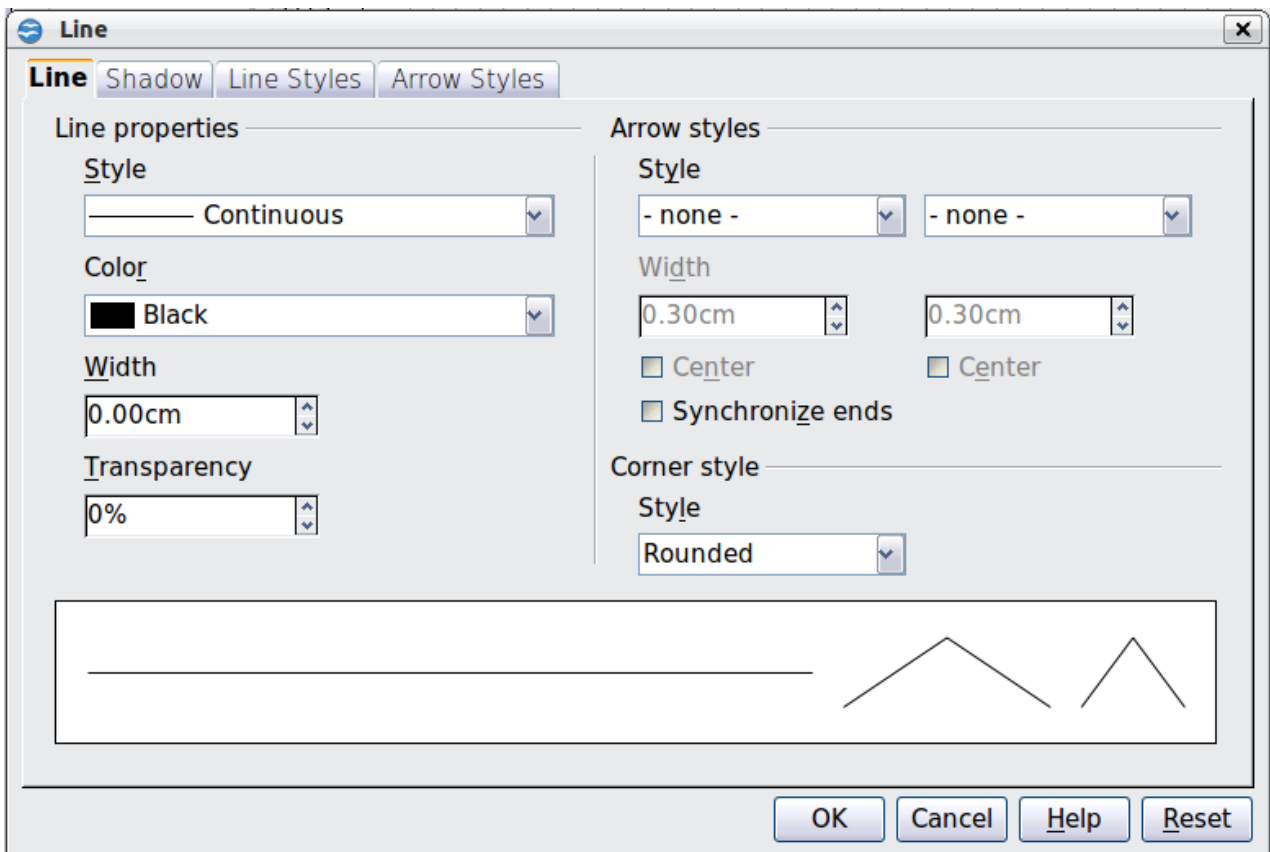

Figure 69: Line dialog (right-click on an object and choose Line).

Common line properties

In most cases the property you want to change is the line's style (solid, dashed, invisible, and so on), its color, or its width. These options are all available from the Line and Filling toolbar.



Figure 70: Common line options (style, width, color)

You can also edit these properties from the Line dialog. They are on the first tab, left column (see Figure 69). From the Line dialog you can also change the line's transparency. Figure 71 illustrates different degrees of transparency.

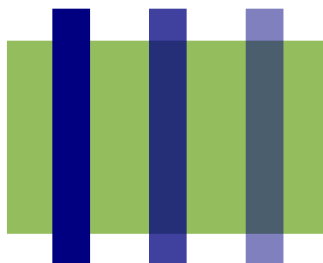

Figure 71: The vertical lines have different levels of transparency (0%, 25%, and 50%).

Drawing arrows

Arrowheads (and other line endings—usually referred to in this guide collectively as arrows) are a line property. Select a line and click on the **Arrow Style**  icon. This opens the Arrowheads menu.



Figure 72: Arrowheads menu

There are several types of arrowheads available. Each end of the line can have a different arrowhead (or no arrowhead).

Note

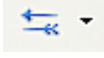
Arrowheads are only applicable to lines. They have no effect on the border of an object.

In the Line dialog (Figure 69), *Arrow styles* on the right-hand side contains a number of options to fine tune the arrow properties. If **Synchronize ends** is selected, both line endings will have the same appearance. The **Center** option places the center of the arrow over the end point of the line. If this option is not selected, the line ends at the far edge of the arrow. The following sketch illustrates the difference.

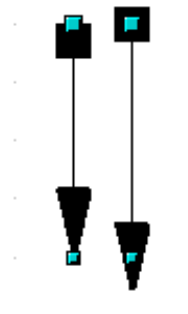

Figure 73: Default arrowheads (left) vs centered arrowheads (right)

Line shadows

Lines can have a shadow property associated with them.

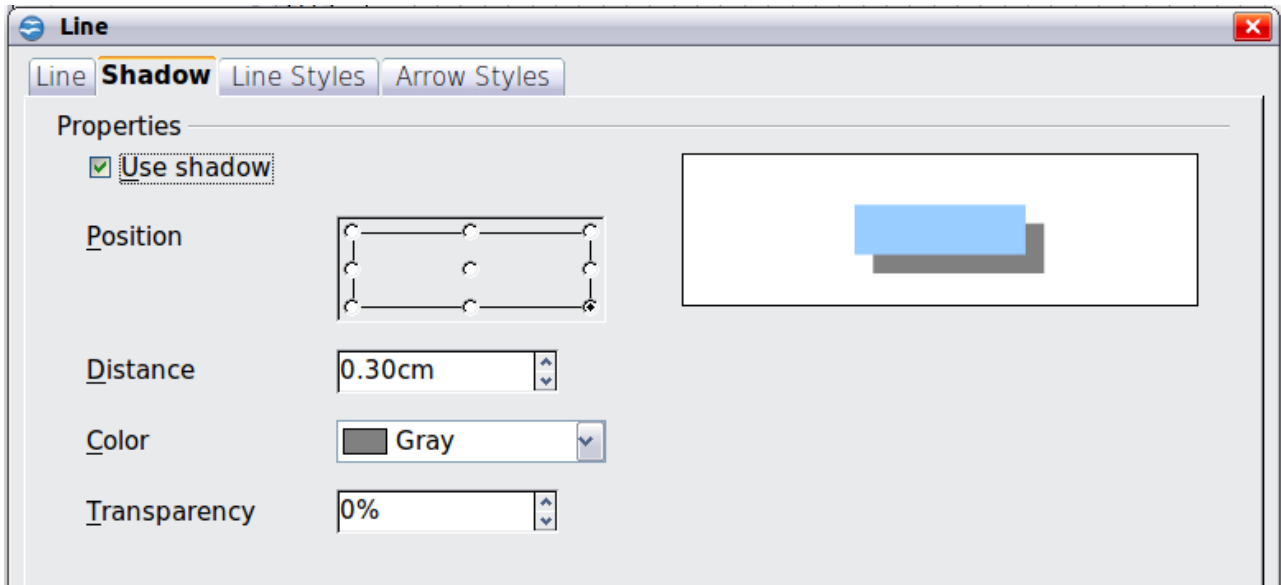



Figure 74: Shadow page of Line dialog



Check the box *Use shadow* to enable this feature. The properties shown—position, distance, color, and transparency—may be independently adjusted to your choice and the results seen in the preview window. You can also click on the Filling  icon on the **Line and Filling** toolbar—next to the area fill functions - to get a basic shadow.

Customizing line and arrow styles

You are not constrained to using the line and arrow styles provided by default in Draw. You can modify the styles and create your own.

Customizing line styles

In the Line dialog, click on the **Line Styles** tab (see Figure 75). From here you can customize the line styles or create your own by clicking on the **Add** button. You can change the length of the dashes, the space between them, and several other attributes.

Use the **Load Line Style**  and **Save Line Style**  icons to save a new definition or read one from disk (file extension .sod).

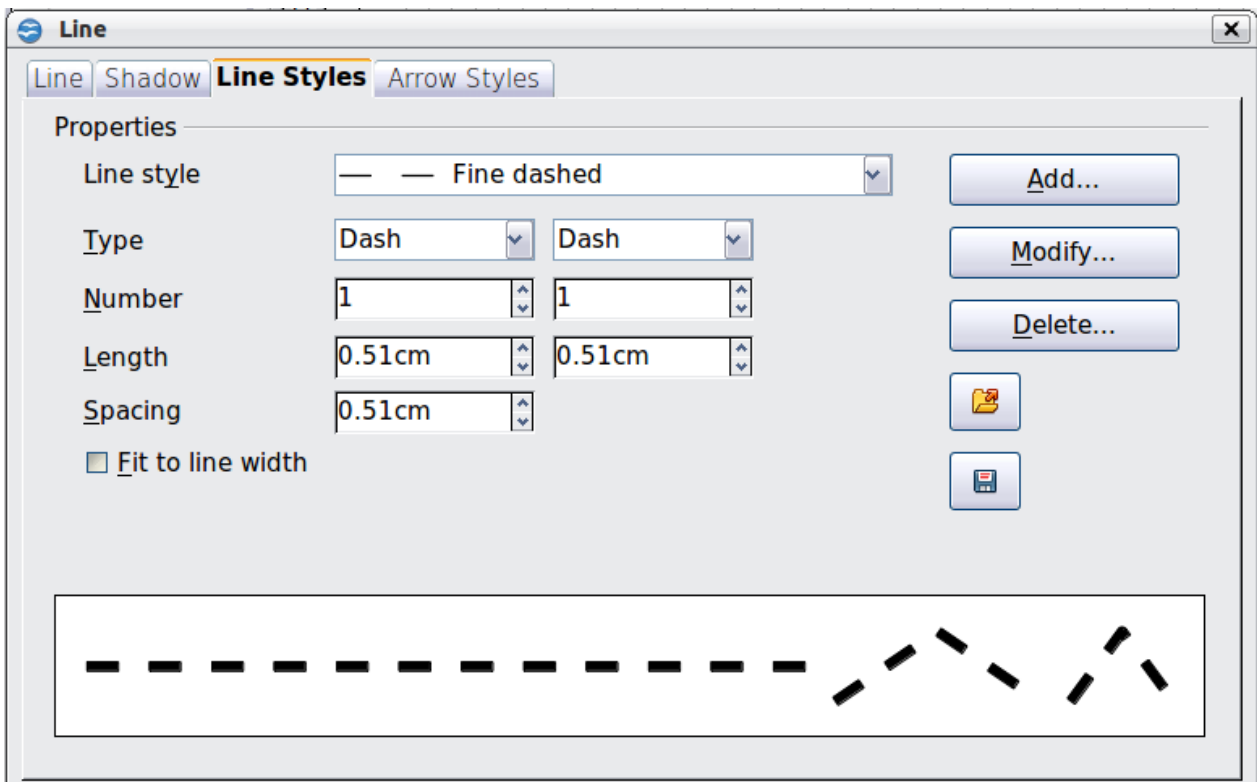
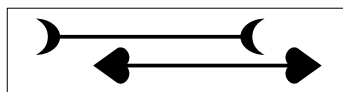

Figure 75: Editing line styles

Customizing arrow styles

You can also create your own arrowheads to provide some interesting effects, such as:



The first step is to draw a curve with the shape you want for the arrowhead.

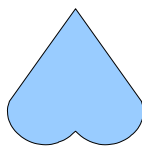

Figure 76: To create your own arrowhead, you must first draw a curve.

Note

The arrowhead must be a curve. A curve is something you could draw without lifting a pencil. For example, ☆ is a curve but ☺ is not a curve. You can however draw forms which are not curves and then convert them to a curve afterwards.

Select the curve, open the Line dialog, and go to the **Arrow Styles** page. Click on **Add**, enter a name for the arrow style and click OK (see Figure 77).

Tip

The part of the shape which should point in the direction of the line must be drawn facing upwards. In Figure 76 the top of the shape will point towards the “outside” of the line.

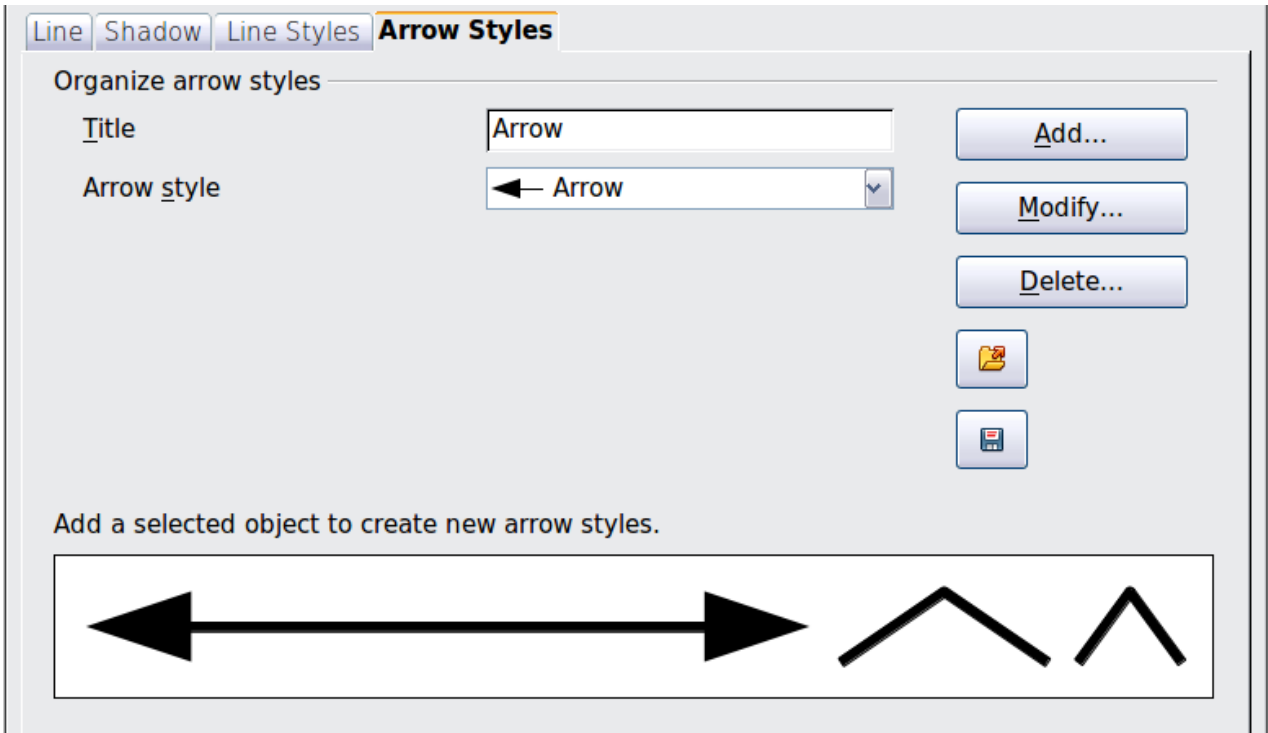

Figure 77: Adding an arrow style

Now you can access the new style from the *Arrow style* list (Figure 78) or the *Arrowheads* dialog (Figure 72).



Figure 78: Arrow style list

Editing the inside (fill) of an object

The OpenOffice.org term for the inside of an object is **Area fill**. The area fill of an object can be a uniform color, a gradient, a hatching pattern, or an image. It can be made partly or wholly transparent and can throw a shadow.

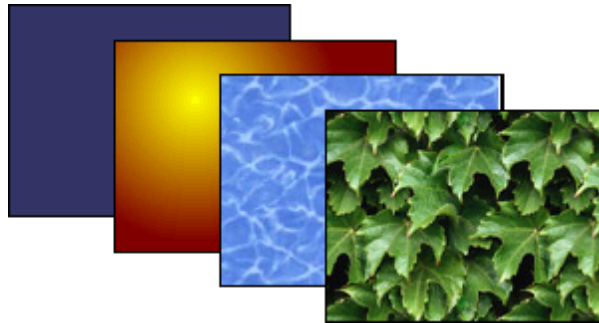

Figure 79: Different types of area fill

Common fill properties

In most cases, you will choose one of the standard fill options, whether it is a color, a gradient or an image. These options are all available from the Line and Filling toolbar.

If you want no fill at all, select the object you wish to edit and on the **Line and Filling** toolbar select the option **Invisible** on the pull down list at the right of the paint can.

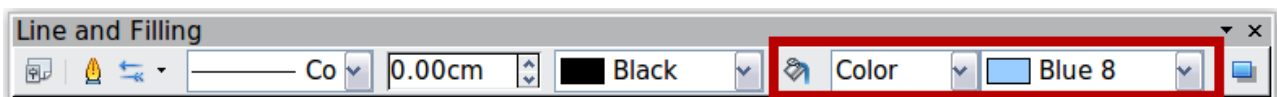

Figure 80: Common fill options

Fill with a uniform color

Select the object you wish to edit. On the **Line and Filling** toolbar, select **Color** on the pull down list at the right of the paint can, and then choose a color from the right-hand menu.

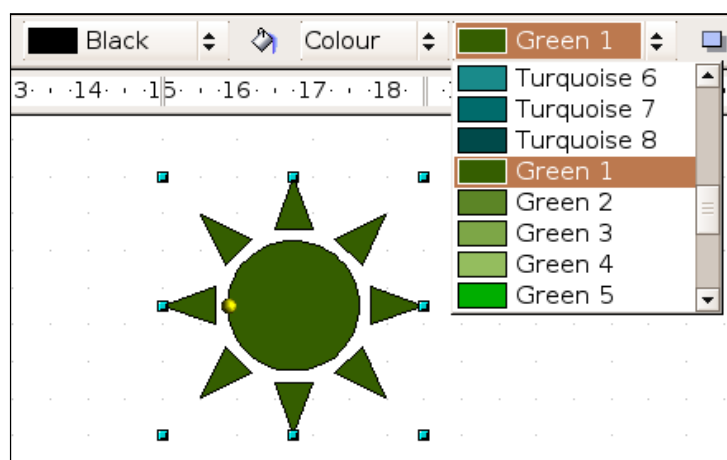

Figure 81: Filling with a color

Fill with a gradient

Select the object you wish to edit. On the **Line and Filling** toolbar, select **Gradient** and then choose a gradient from the right-hand menu.

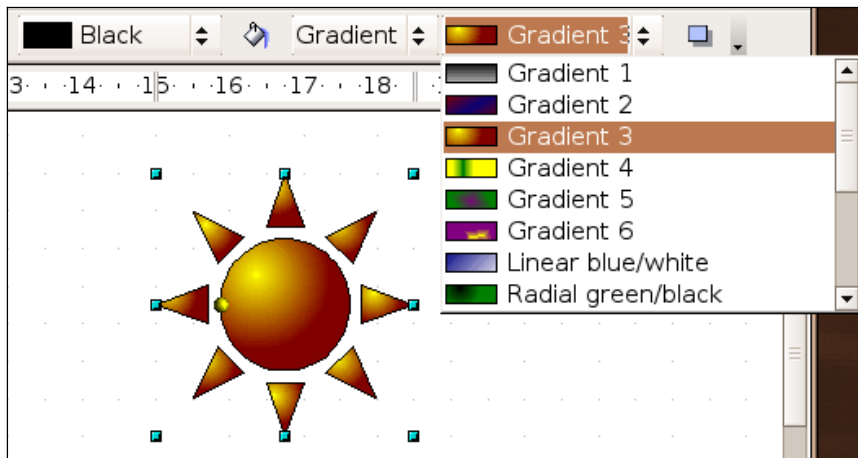

Figure 82: Filling with a gradient

Fill with a line pattern

The OOo term for line patterns is Hatching. Select the object you wish to edit. On the Line and Filling toolbar, select **Hatching** and then choose an option from the menu.

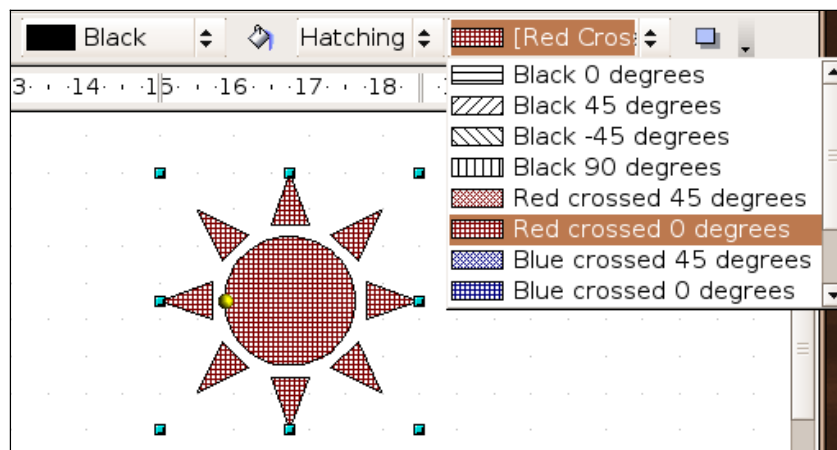

Figure 83: Filling with a line pattern

Fill with an image

You can fill an object with a bitmap image (as opposed to a vector graphic image). Select the object you wish to edit. On the **Line and Filling** toolbar, select **Bitmap** and then choose an option from the menu.

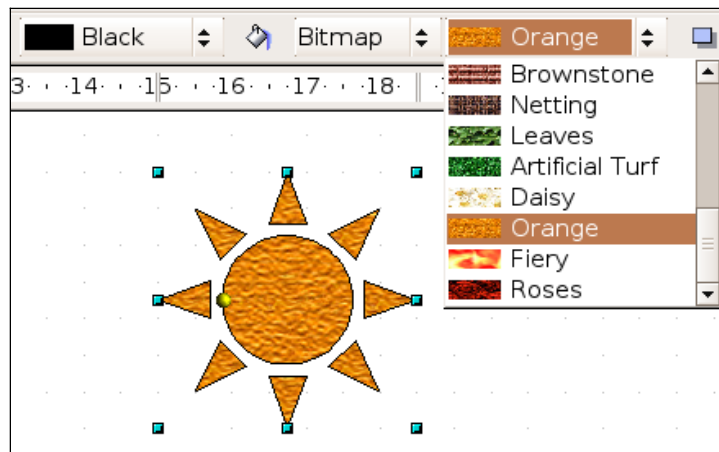



Figure 84: Filling with an image

Adding a shadow to an area

Click on the Filling  icon on the **Line and Filling** toolbar—next to the area fill functions (Figure 85).

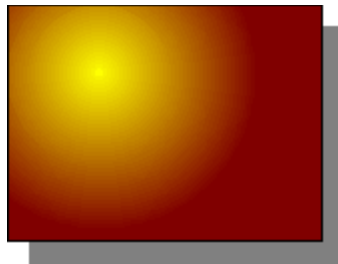



Figure 85: Adding a shadow

Advanced area fill options

Click on the **Area** icon  to bring up the Area dialog. From this dialog, you can fine tune the area fill of an object in greater detail.

Creating your own fill color

Click on the **Colors** tab of the Area dialog (Figure 86). From here you can modify existing colors or create your own.

Depending on the color model in use (RGB or CMYK can be selected from the pull down menu), you can change the individual values of the constituent colors—Red, Green, and Blue or Cyan, Magenta, Yellow, and Black. Click on **Add** to add this color to the color table. Clicking on the **Modify** button will change the values of the current color (here it is Blue 8, shown in the upper rectangle) to those on the screen in the lower rectangle. The **Edit** button allows you to fine tune the color using a palette with visual feedback.

Further explanation about color palettes can be found in Chapter 8 (Tips and Tricks).

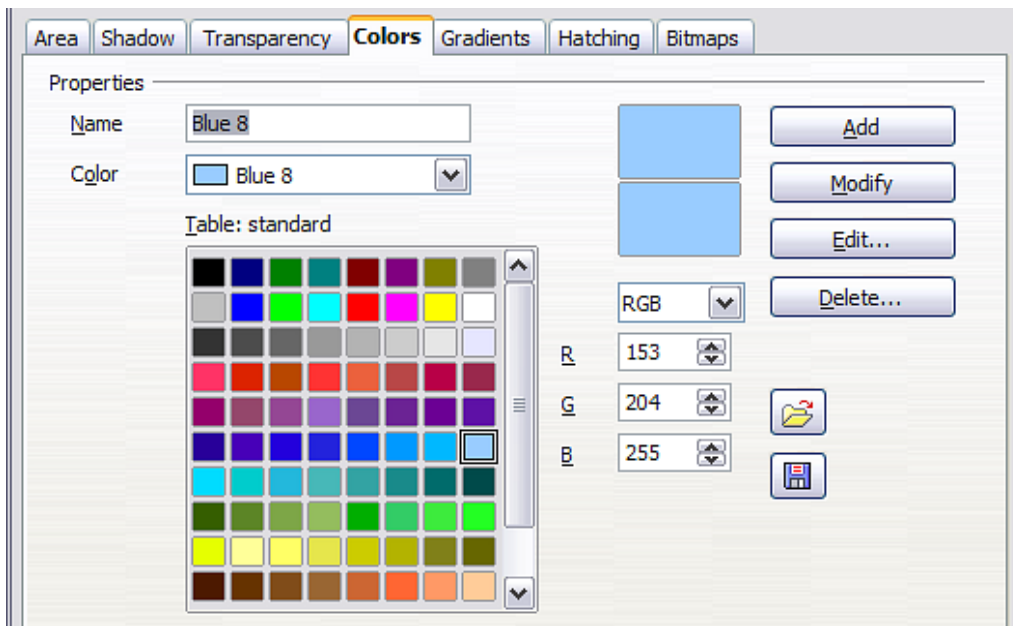

Figure 86: Customizing the color palette

Creating your own gradient

On the Area dialog, click on the **Gradients** tab. From here you can modify existing gradients or create your own.

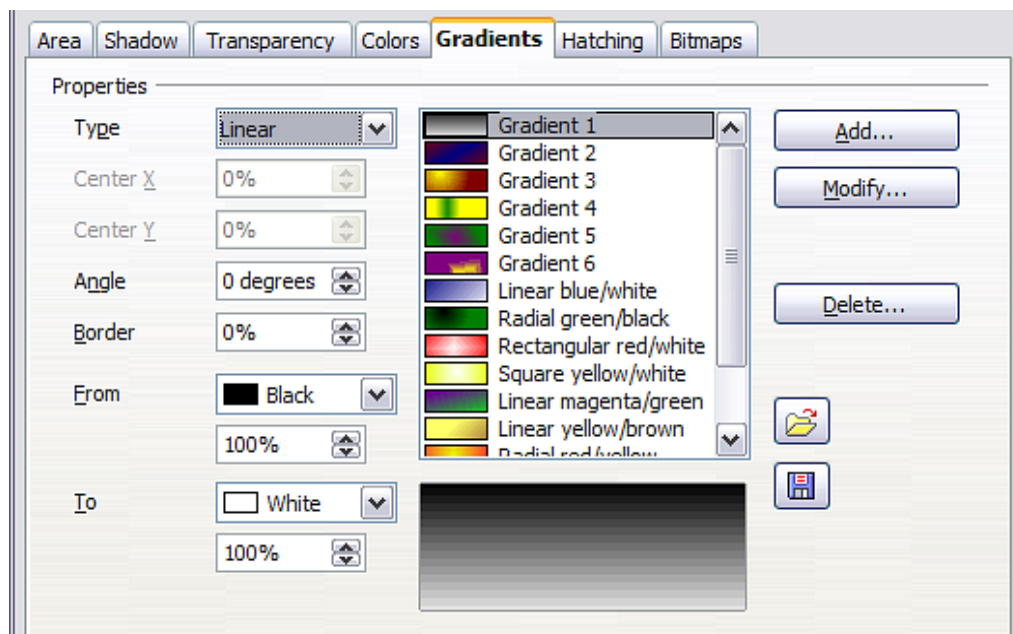

Figure 87: Customizing gradients

A gradient works by creating a smooth transition from one color to another. First, you need to choose two colors (Figure 88).

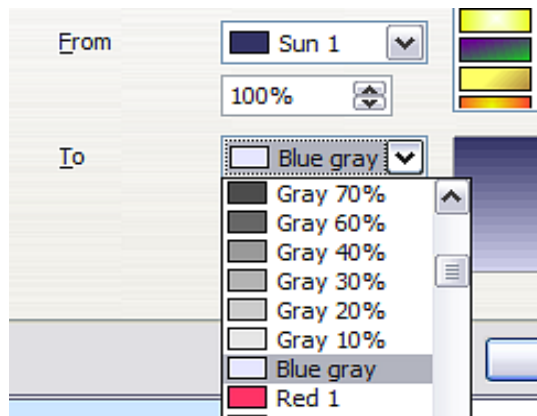

Figure 88: Choosing colors for a gradient

Then choose a type of gradient. There are several available (Linear, Axial, Radial, and so on) and each has up to four different options to specify it in detail. For example, a radial gradient has a center you can specify (Figure 89).



Figure 89: Center option in a radial gradient

Figure 90 shows how an ellipsoid gradient is rotated, moved vertically and horizontally, and the color of the border area varied.

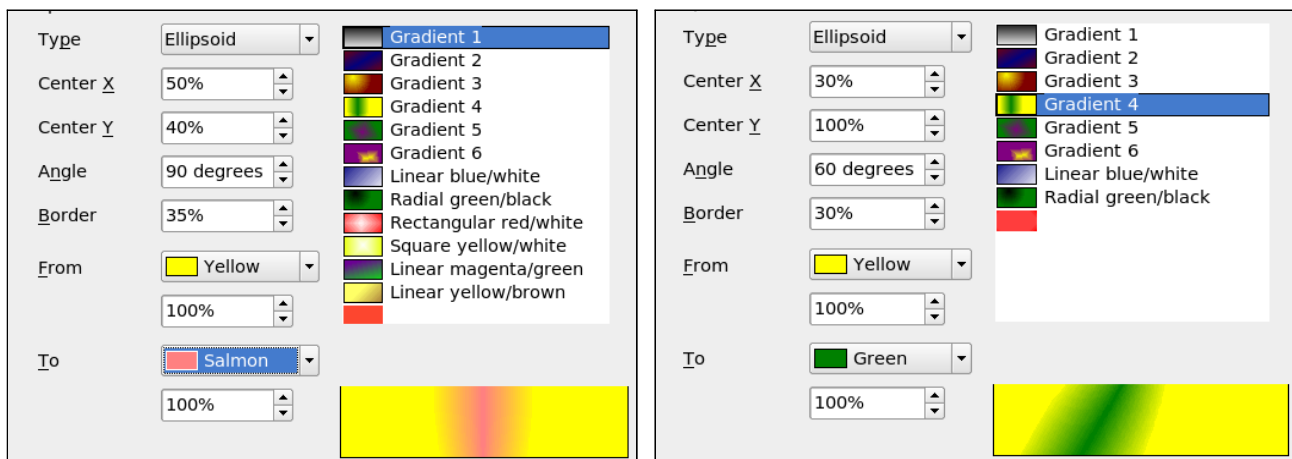

Figure 90: Center, Angle, and Border options for a gradient

Creating your own hatching (line pattern)

On the Area dialog, click on the **Hatching** tab (Figure 91). From here you can modify existing hatchings (line patterns) or create your own.

You can customize options like the spacing between lines, the angle and the color of the lines. There is no way to edit the line thickness.

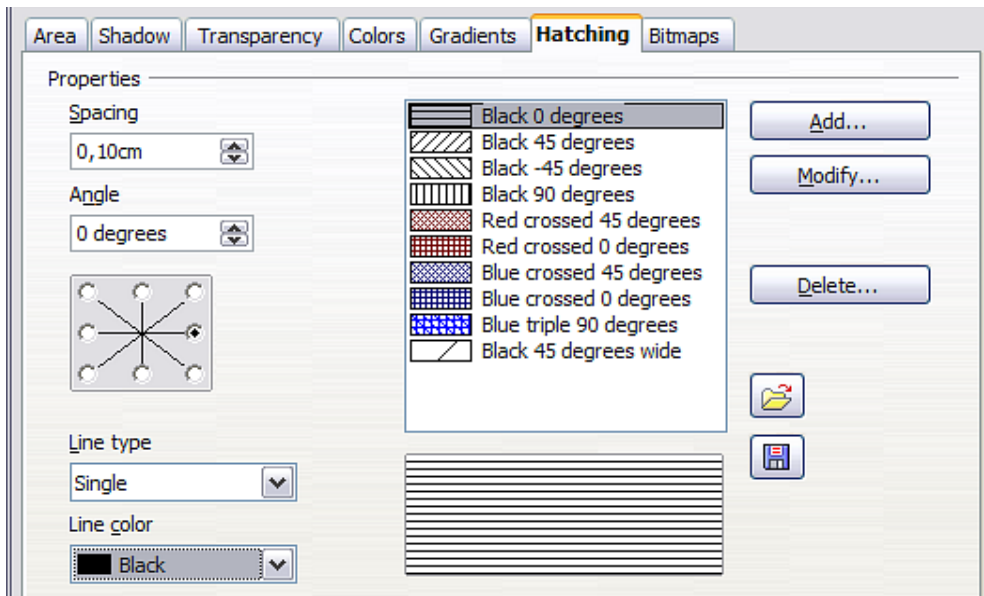

Figure 91: Modifying hatchings

Creating your own bitmap fill

You can add your own bitmap images to fill an area. First, you need to create the bitmap image. This could be a photo or another sketch you have created in another program. For example, you can draw something with Draw and **export** it as a PNG format image file.

To export a PNG image file: Create the image, select it, then choose **File > Export**, choose **PNG** from the pull-down list of file formats, give the file a name, and save it.

To use an image as a bitmap fill, open the Area dialog and click on the **Bitmaps** tab (Figure 92).

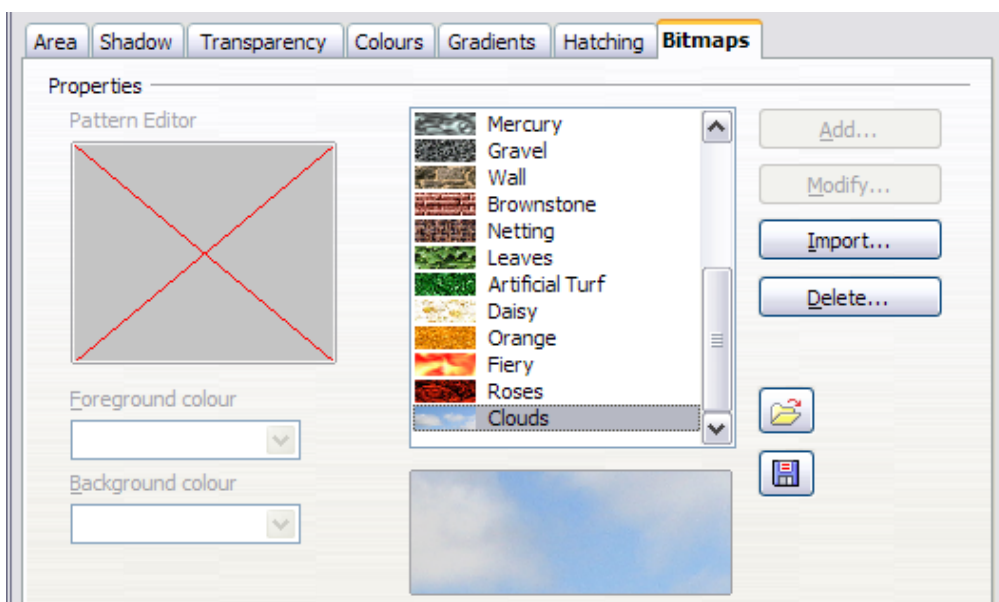

Figure 92: Adding your own bitmap images

From there you can add new bitmap images to serve as area fills. Click on **Import** and choose a file you previously saved. Give it a name that will make it easy to remember. The last imported image will appear at the bottom of the pull-down list of bitmap fills. Now you can use that image as an area fill.

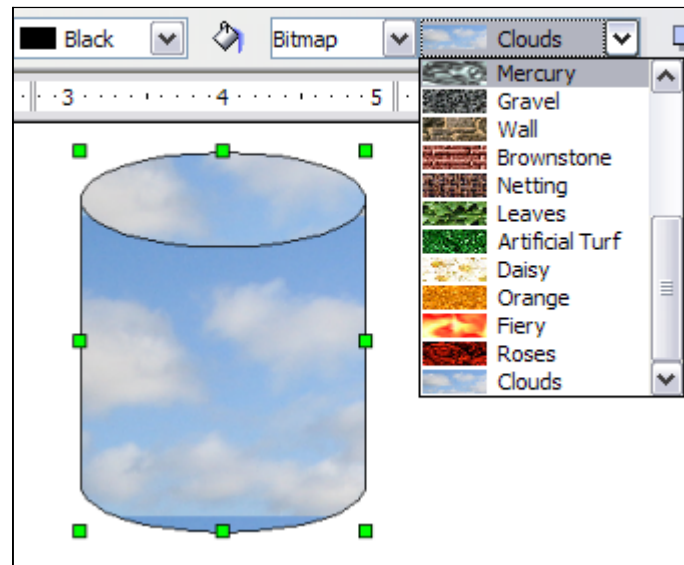

Figure 93: Adding your own bitmap images

Tip

If the imported image seems to be very small in the preview (Figure 92) you probably forgot to select the image before you exported it. In that case, the exported image would be the whole page with a (small) drawing on it.

Customizing shadows

First, select the object you want to apply a custom shadow to. Open the Area dialog and go to the **Shadow** tab (Figure 94). There you can customize the shadow's position, distance and color.

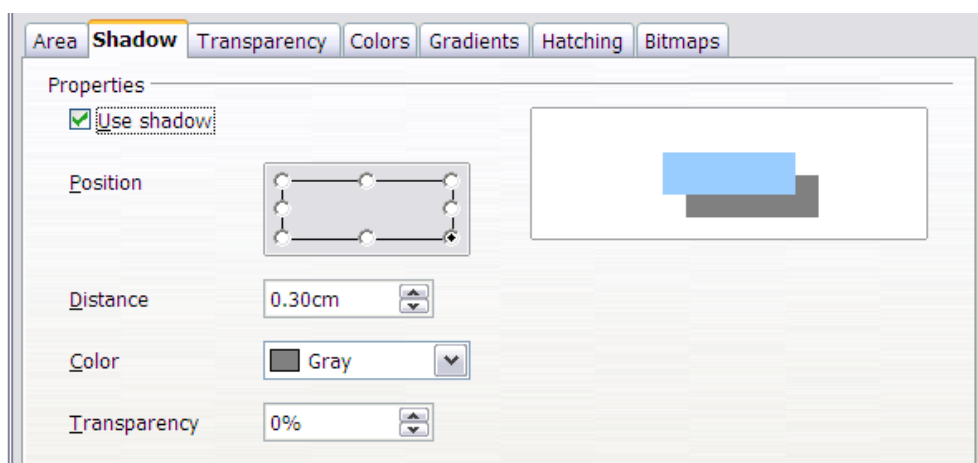

Figure 94: Customizing shadows

Shadows can also have transparency, so the shadow does not hide objects behind it.

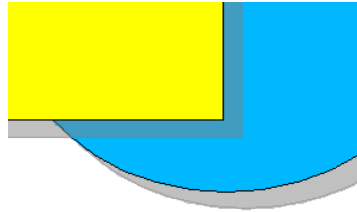

Figure 95: Shadow with 50% transparency

Adding transparency

You can make objects partly or fully transparent, or even a with a varying degree of transparency (as a gradient). On the **Transparency** page (Figure 96), choose **Transparency** (for a uniform transparency) or **Gradient** for a gradient transparency.

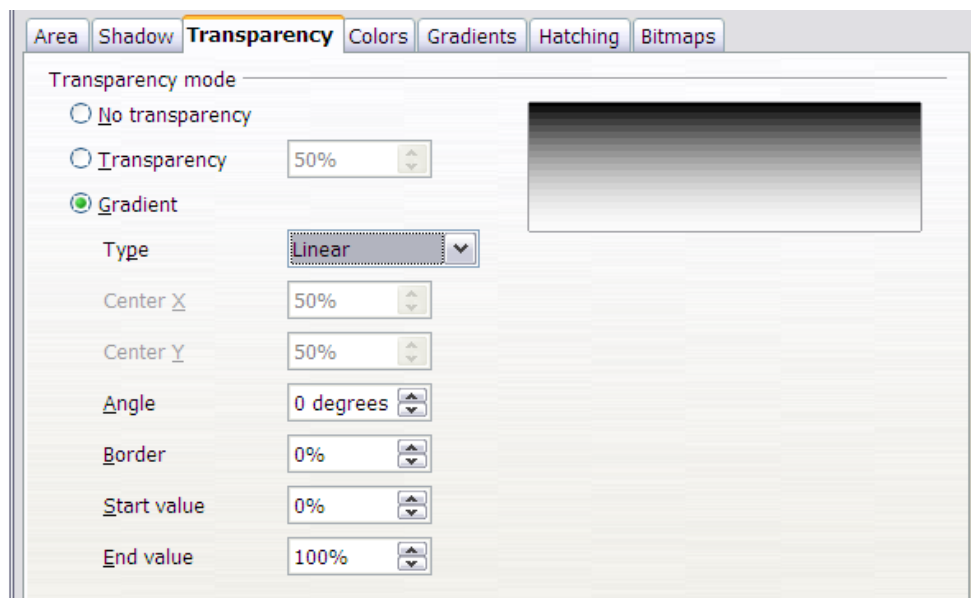

Figure 96: Transparency page of Area dialog

An example of gradient transparency is shown in Figure 97. See also “Dynamic gradients” on page 76.



Figure 97: Example of gradient transparency

Using styles

Suppose that you want to apply the same area fill, line thickness, and border to a set of objects. This repetitive process can be greatly simplified by the use of styles. Styles allow you to define a formatting template (a style) and then to apply that style to multiple objects. For more about styles, see Chapter 6 (Introduction to Styles) in the *Writer Guide*.

Click on the **Styles and Formatting**  icon on the **Line and Filling** toolbar or press the *F11* key to open the Styles and Formatting window (Figure 98). This window can be docked to the left or right side of the main Draw window, if you wish.

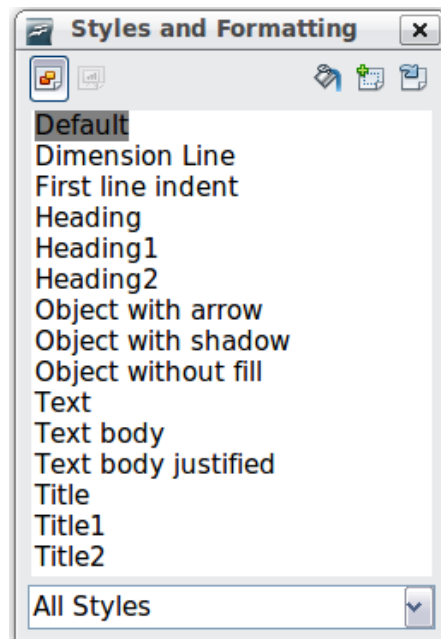



Figure 98: Styles and Formatting window

Creating a new style

Select an object and customize the area fill and border. When you are satisfied, click on the **New Style from Selection**  icon on the Styles and Formatting window. This defines a new style based on the selected object. Type a name for the new style and click **OK**.

Applying a style

Once the new style is defined, you can apply it to other objects. Select another object and double-click on the style name you defined. The new object will acquire the area fill and line properties of that style.

Tip

Question: What happens if I modify a style after it has been applied?

Answer: Then every object with that style is updated automatically!

Modifying a style

Modifying a style is similar to creating a new style. Select an object **with that style** and change the area and line properties. When satisfied, click on the **Update Style**

icon . Alternatively click the **Styles and Formatting** icon or press *F11*, right-click the style you wish to modify and select **Modify**. Edit the properties you want to change and click **OK** to finish.

Special effects

First make sure that the Drawing toolbar is selected (**View > Toolbars > Drawing**).

On the Drawing toolbar, locate the **Effects** icon . Click on the **arrow** next to that icon. This opens a submenu with all the special effect tools (see Figure 99).

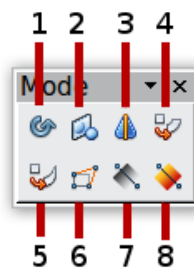

- | | | |
|-------------------------|-------------------------------|----------------|
| 1 Rotate | 4 Set in Circle (perspective) | 7 Transparency |
| 2 Flip | 5 Set to Circle (slant) | 8 Gradient |
| 3 In 3D Rotation Object | 6 Distort | |

Figure 99: Mode tear-off submenu

The tools are described in the following sections with the exception of the 3D rotation tool, which is described in Chapter 7 (Working with 3D Objects).

Rotating an object

Click on the **Effects**  icon to select the **Rotate** tool. Then select an object. The selected object will have red handles instead of the usual green handles.

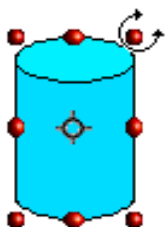

Grab one of the handles and move it to rotate the object. The black circle in the middle of the object is the pivot (center of rotation). You can move the location of the pivot with the mouse.

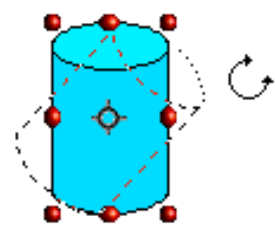

Flip an object

Select an object and click on the **Flip** icon . You will see a dashed line through the middle of the object.

This dashed line is the **axis of symmetry**. The object will be reflected about this line. Move one or both ends of the line with your mouse to set the orientation of the axis.

Then, grab any one of the eight green handles and move it across to the other side of the dashed line. The new position of the figure is shown faintly until the mouse is released.

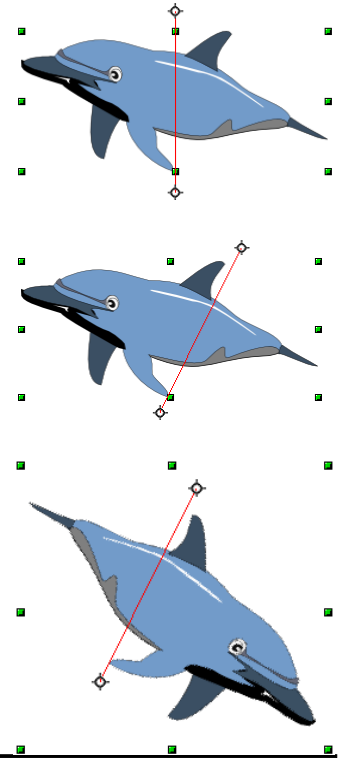

Note

If you press the *Shift* key while moving the line, the line will rotate in 45-degree increments.

Mirror copies

Officially, this useful command does not (yet) exist in Draw. It can, however, be easily emulated.

Move the axis of symmetry to the desired location of the mirror axis. Copy the object to the clipboard. Flip the object, then click on an empty area of the Draw screen in order to deselect the object. Paste from the clipboard to put a copy of the object in its original location and now you have a mirror copy.

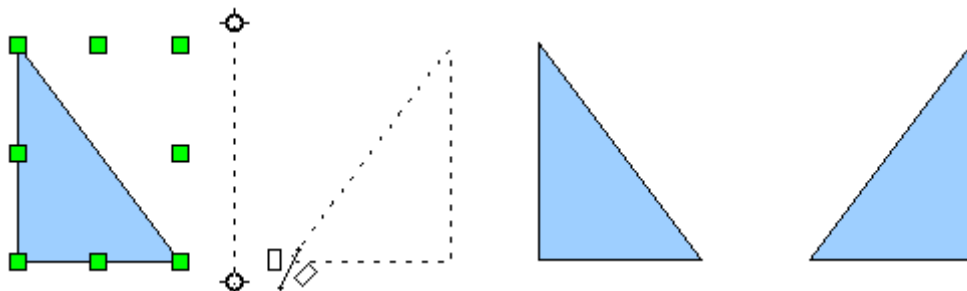

Figure 100: Making a mirror copy of an object

Distorting an image

There are three tools on the **Effects** menu that let you drag the corners and edges of an object to distort the image.

The **Distort** tool distorts an object in perspective, the **Set to Circle (slant)** and **Set in Circle (perspective)** tools both create a pseudo three-dimensional effect.

The results of using these tools are shown in the following figures.

Distort an object

Select an object and click on the **Distort** icon . Draw will ask if you want to transform the object to a curve. This is a necessary step before distortion, so click **Yes**. Then you can move the object handles to stretch it.

The corner handles distort, as shown in Figure 101. The midpoint handles distort the figure either horizontally (handle on vertical side of figure) or vertically (handle on horizontal side of figure).

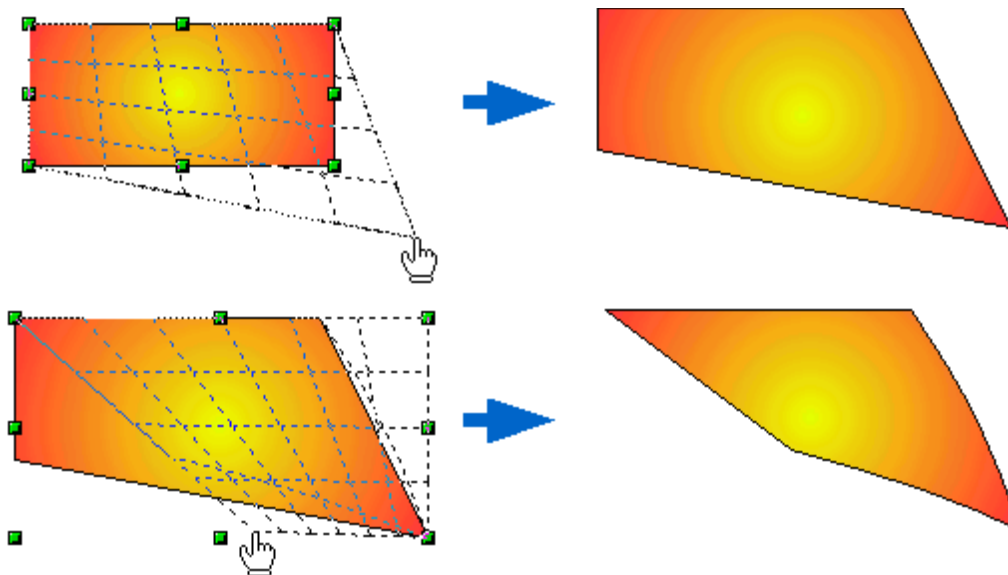



Figure 101: Distort an image

Set in circle (perspective)

Select an object and click on the **Set in Circle (perspective)**  icon. Draw will ask if you want to transform the object to a curve. This is a necessary step before distortion, so click **Yes**. Then you can move the object handles to give a pseudo three-dimensional perspective).

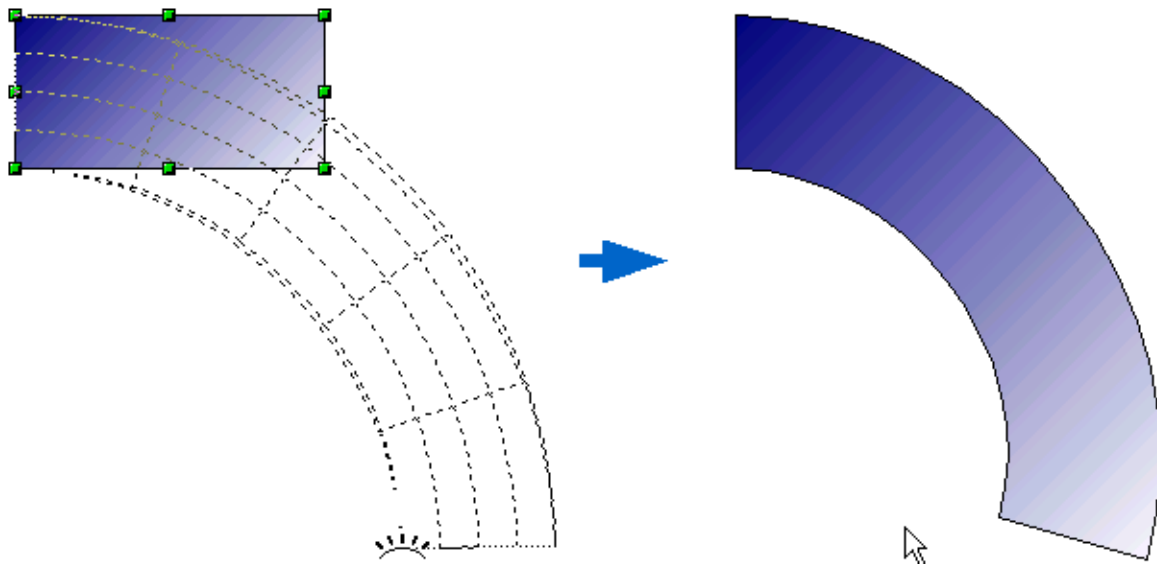



Figure 102: Set an image in a circle with perspective

Set to circle (slant)

Select an object and click on the **Set to Circle (slant)**  icon. Draw will ask if you want to transform the object to a curve. This is a necessary step before distortion, so click **Yes**. Then you can move the object handles to give a pseudo three-dimensional slant perspective.

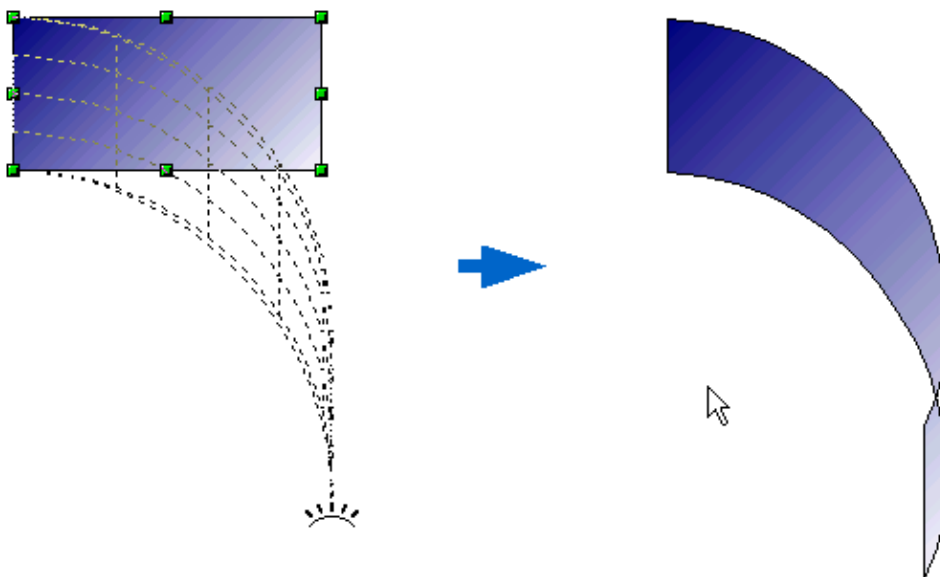



Figure 103: Set an image to a circle with slant perspective

Note

Transforming an object into a curve is a safe operation, but it cannot be reversed other than by clicking the **Undo** button.

Dynamic gradients

You can control transparency gradients in the same manner as color gradients. Both types of gradient can be used together. With a transparency gradient, the direction and degree of an object's fill color changes from opaque to transparent (in a regular gradient, the fill changes from one color to another, but the degree of transparency remains the same).

If you have assigned transparency to an object with a color fill, you can control the transparency by clicking on the **Transparency** icon . To define a transparent gradient, select an object, choose a transparency fill from the **Line and Filling** toolbar. The transparency icon is now active. When you click on this icon, a dashed line connecting two squares appears on the object. Move the two squares to modify the gradient. You can define the direction of the gradient (vertical, horizontal, or at any angle) and the spot at which the transparency begins.

A regular color gradient can be defined in the same manner. Select an object, choose a gradient fill from the **Line and Filling** toolbar. The **Gradient** icon  is now active. When you click on the gradient icon, a dashed line connecting two squares appears on the object, just as it does for a transparency gradient.

In both cases, click outside the object to set the gradient.

Note

If the transparency and gradient icons are not visible, you can display them using **View > Toolbars > Mode**.

Moving the squares will have different effects, depending on the type of gradient. For example, for a linear gradient, the start and end squares of the gradient will always be situated to either side of the center point of the object.

The three examples in Figure 104 demonstrate how the type and degree of transparency can be controlled.

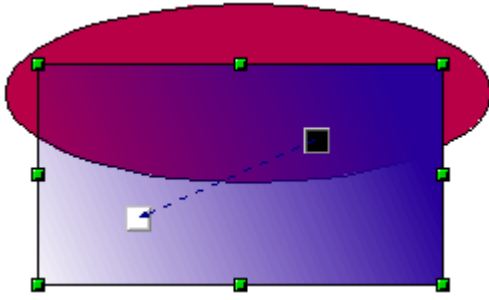

A single color object and a transparency gradient, covering part of the underlying object.

The gradient can be dynamically adjusted, made more transparent by moving the white square or more opaque by moving the black square.

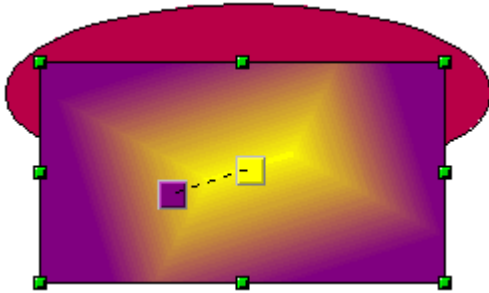

An object with a color gradient, completely covering another object.

The gradient is adjusted dynamically by moving the squares - the color of the square relating to the increase or decrease in that color.

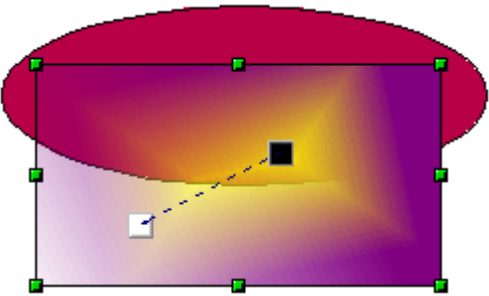

An object with both color and transparency gradients, partly covering the underlying object.

Figure 104: Dynamic gradients



Chapter 5

Combining Multiple Objects

Free eBook Edition

Introduction: grouping and combining objects

Using Draw, you can combine drawing objects together in two distinct ways: *grouping* and *combining*. These two methods allow you to treat multiple objects as one unit, or to merge objects to form a new shape.

Grouping is like putting objects in a container. You can move them as a group and apply global changes to them. A group can always be undone and the objects that make up the group can always be manipulated separately.

A *combination* is a permanent fusion of objects leading to a new object. The original objects are no longer available as individual entities and the operation is not reversible.

Tip To select multiple objects, click on each object while holding down the *Shift* key or click the **Select** icon (on the Drawing toolbar) and draw a rectangle around the objects.

Grouping objects

Grouping by common selection

When several objects are selected, any operations you carry out are applied to all of the objects. For example, you can rotate a group of objects in its entirety. Groups obtained through common selection of several objects are undone as soon as you click outside the group. However, you can choose to maintain a grouping so that the selected objects will remain together after they are deselected.

Maintaining groups and undoing groups

To group objects, first select the objects, then right-click and choose **Group** from the pop-up menu. You can also use the keyboard shortcut *Control+Shift+G* or choose **Modify > Group** from the menu bar.

When objects are grouped, any editing operations carried out on that group are applied to all members of the group. If you click on one member of the group, the whole group is selected.

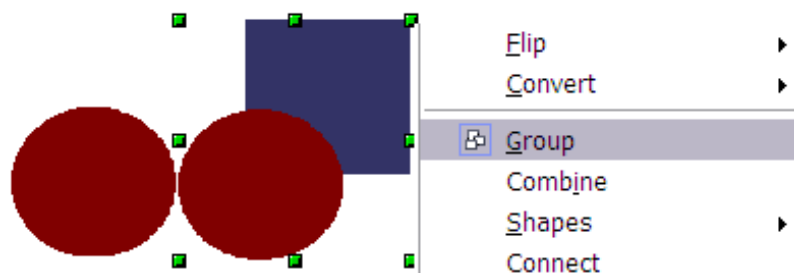

Figure 105: Grouping objects using the right-click menu

The objects of a group retain their own individual properties. To undo a group, right-click and choose **Ungroup** from the pop-up menu, use the keyboard shortcut *Control+Alt+Shift+G* or choose **Modify > Ungroup** from the menu bar.

Editing individual objects in a group

You can edit a member of a group individually without breaking the group. To do this, right-click and choose **Enter group** or double-click on the group.

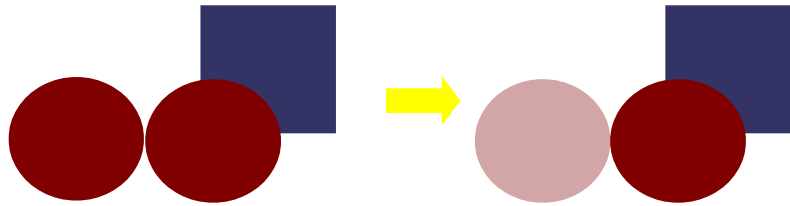

Figure 106: When you enter a group, objects outside the group cannot be selected and appear pale

Once inside the group, click on any object to edit it.

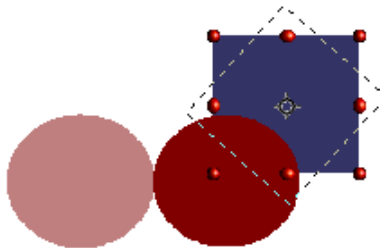

Figure 107: Editing an object inside a group

To leave this mode, right-click and choose **Exit group** or double-click outside the group.

Nesting groups

You can create “nested” groups, or groups of groups. In this case, Draw keeps the initial group hierarchy. If you ungroup a group made of other groups, you are left with individual groups that you can then ungroup further, until only single objects remain.

Combining objects

In contrast to grouping functions, *combinations* create a new object; it is not possible to edit an individual constituent afterwards. Select a collection of objects, then right-click and choose **Combine** from the pop-up menu or use the keyboard shortcut *Control+Shift+K*. The result of this operation is shown in Figure 108.

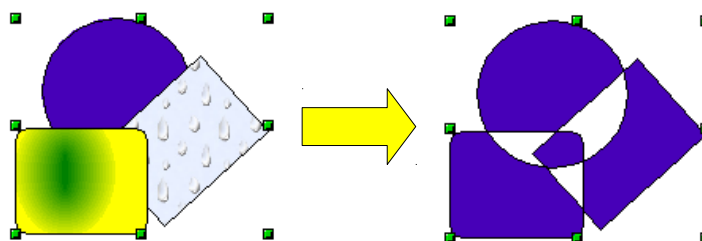

Figure 108: Combining objects

At first glance, the appearance of the combined objects can seem rather surprising. However, once you understand the rules governing combination in Draw, it will become clearer.

- The attributes (for example, area fill) of the resulting object are those of the object furthest back. In this example, it is the circle.
- Where the objects overlap, the overlapping zone is either filled or empty depending on the number of overlaps. When the number of overlaps is even, you get an empty space; when the number is odd, you get a filled area.

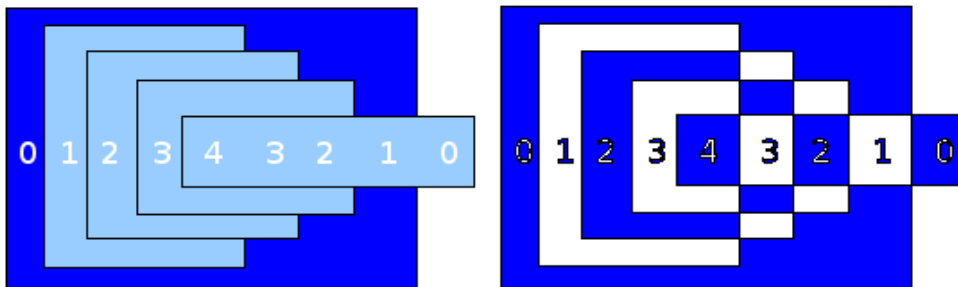

Figure 109: Odd numbered overlaps are filled, even numbered overlaps are empty

Tip

You can reorder objects before combining them so that they are further back or further forward: right-click on the object and select **Arrangement** from the pop-up menu. See also “Aids for positioning objects” on page 83.

An object which is a combination can be broken up again by selecting **Modify > Split** or using the keyboard shortcut *Control+Alt+Shift+K*. The combination can also be broken up into its constituent parts by selecting **Modify > Break**. These are not an exact equivalent to ungrouping, as the objects were converted to Bézier curves when they were combined. An object which is split will, for example, have an ellipse converted to a Bézier curve.

A object which is broken will consist of a set of base level objects (for example, a rectangle will be broken into 4 separate lines) and the original formatting—line thickness, colors, and area properties—is not retained.

Connecting lines

Lines may be connected by selecting them and using **Modify > Connect**. The connections established are based on joining the ends of pairs of lines with minimum separation. Once a group of lines is connected, you can “close” the remaining gap by selecting the line, right-clicking and choosing **Close Object**. The resultant object is filled with the default fill. If you modified the line properties (color, weight) these are retained in the resulting polygon.

Merging, subtracting, or intersecting shapes

After you have selected more than one object, the Merge, Subtract, and Intersect functions can be reached in the **Modify > Shapes** menu or through the group’s right-click menu under the heading **Shapes**.

Merge

When you merge objects, the new object covers the entire surface of the original objects (it is the *union* of the objects). In the same way as combining, the fill of the merged object is determined by the fill of the object furthest in the background. Other properties are not taken over into the new object.

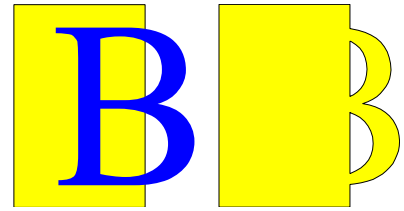

Subtract

When you subtract, the front object is subtracted from the object behind it.

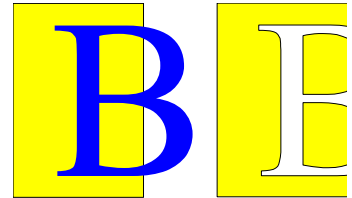

Intersect

When you intersect two objects, you get only the area covered by both objects.

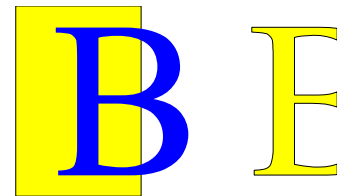

Tip For more information on moving objects to the front or back, see page 83.

Practical example

The following example shows how you can use the merge functions to create a complex shape—a knife with a wooden handle.

- 1) Draw an ellipse and then a rectangle overlapping half of its width.

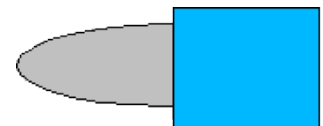

- 2) Select both shapes, right-click, and choose **Shapes > Subtract** from the pop-up menu. The result should resemble the shape to the right:

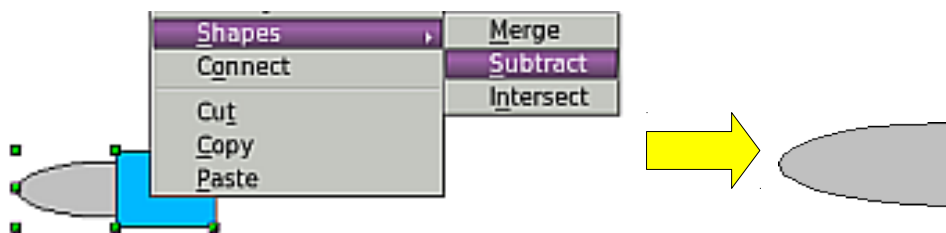

- 3) Draw another rectangle and put it over the top half of the ellipse. Then subtract again.

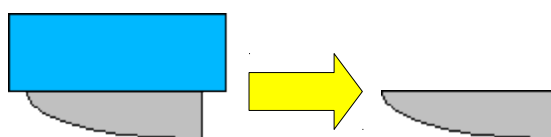

- 4) Draw a small ellipse covering just the lower right corner and subtract again.

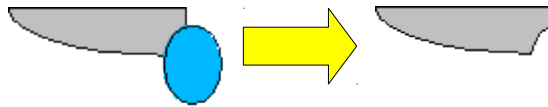

- 5) The knife blade is now complete. To make the handle, draw a rectangle and an ellipse as shown.



- 6) *Merge* the shapes together.



- 7) *Group* this image with the previous one.



Aids for positioning objects

Draw has various tools to help you arrange the objects with respect to each other. Here we explore some of the more important ones.

Moving an object to the front or to the back

When you combine or merge objects, the end result varies drastically depending on which object is “in front” and which one is “behind”. In Figure 110 you can see the difference.

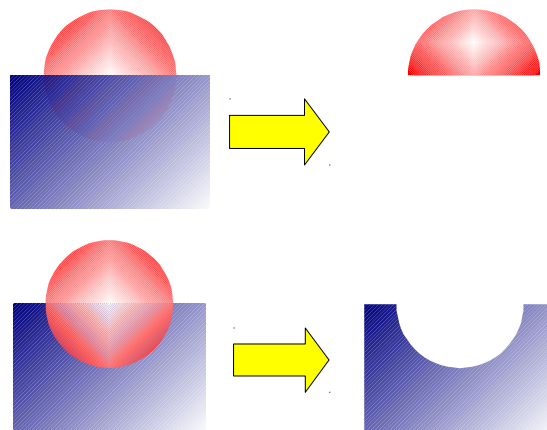

Figure 110: Subtracting objects: the result varies depending on which object is in front.

If you imagine several objects stacked one on top of the other, the one referred to as “Front” is the one on top of the stack. The one referred to as “Back” is the one on the very bottom of the stack.

First select an object, then on the Drawing toolbar, long-click on the Arrange icon



to open the **Position** toolbar. This toolbar can be torn off and made to float.

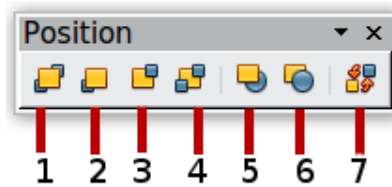

- | | |
|------------------|----------------------|
| 1 Bring to Front | 5 In Front of Object |
| 2 Bring Forward | 6 Behind Object |
| 3 Send Backward | 7 Reverse |
| 4 Send to Back | |

Figure 111: The floating Position toolbar

 brings the selected object to the front of the group.

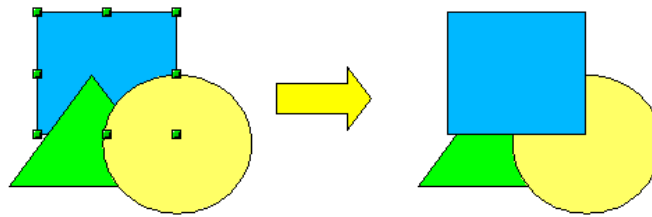

 brings the selected object one step forwards.

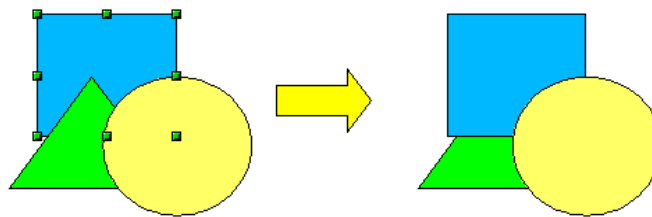

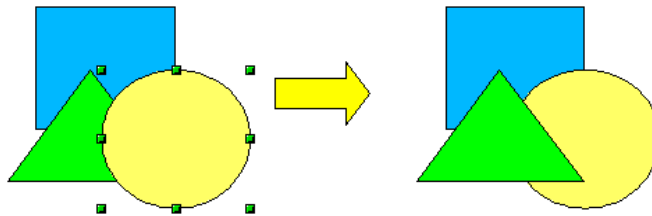

 sends the selected object one step backwards.

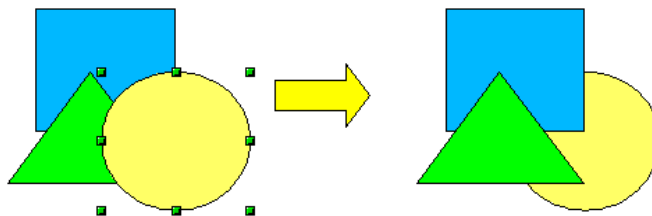

 sends the selected object to the back of the group.



 moves the selected object in front of another chosen object.

 moves the selected object behind another chosen object.

Click first on the object you want to change in position. Next click on the icon and then move the mouse over the other object. The mouse cursor changes

into a hand and the outline of the second object becomes a dashed line (see below). Clicking on this object completes the rearrangement of position.

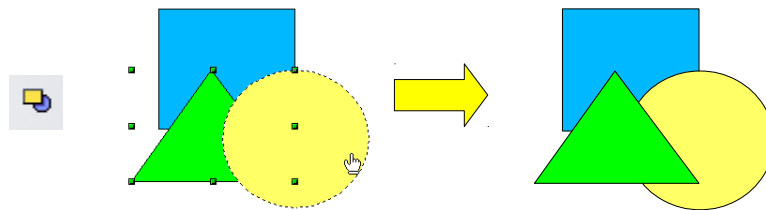

reverses the order of the selected objects (this option is grayed out if only one object is selected).

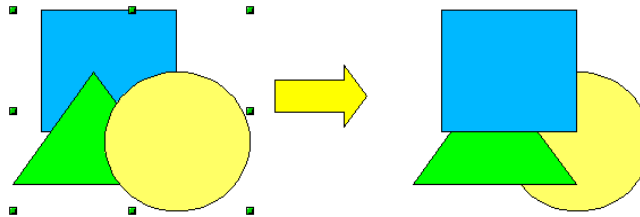

Aligning objects

Select two objects and long-click on  on the Drawing toolbar to open the **Align** toolbar. This toolbar can be torn off and made to float. The tools help you position objects with respect to each other.

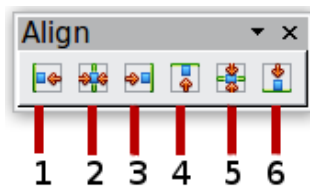

- | | |
|------------------------------|----------------------------|
| 1 Align left | 4 Align top |
| 2 Center horizontally | 5 Center vertically |
| 3 Align right | 6 Align bottom |

Figure 112: The floating Align toolbar



Align left.

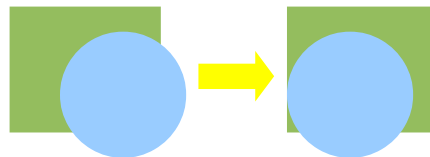

Center horizontally.

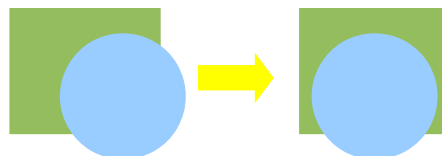

 Align right.

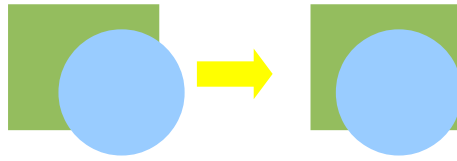

 Align top.

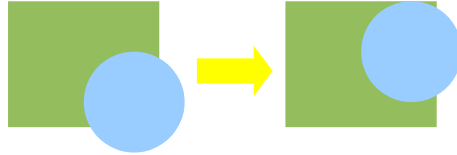

 Center vertically.

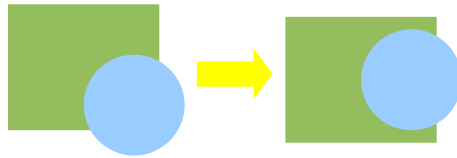

 Align bottom.

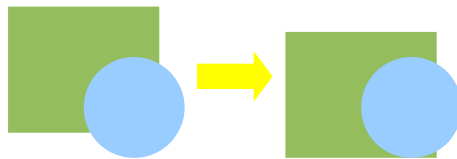

If you have selected only one object, clicking the various buttons on the Align toolbar positions the object in relation to the drawing page.

Distributing the distance and space between objects

Select at least three objects. Now you are able to select the option **Distribution** on the **Modify** menu or from the right-click menu. The Distribution dialog contains a number of options, described below.

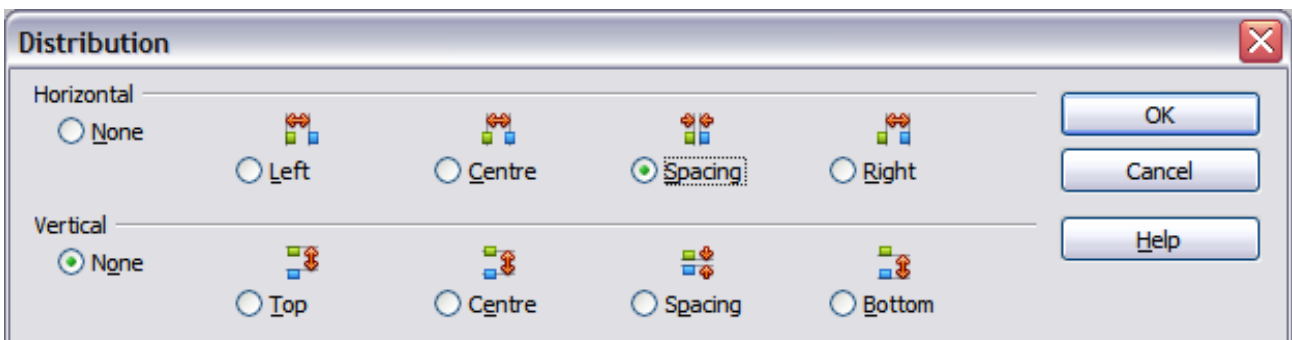

Figure 113: Distribution of spacing between objects

Horizontal distribution

None. Does not distribute the objects horizontally.

Left. The left edges of the objects are evenly spaced from one another.

Center. The horizontal centers of the objects are evenly spaced from one another.

Spacing. The horizontal spacing between the objects is evenly distributed.

Right. The right edges of the objects are evenly spaced from one another.

Vertical distribution

None. Does not distribute the objects vertically.

Top. The top edges of the objects are evenly spaced from one another.

Center. The vertical centers of the objects are evenly spaced from one another.

Spacing. The vertical spacing between the objects is evenly distributed.

Bottom. The bottom edges of the objects are evenly spaced from one another.

Figure 114 shows four objects before distribution of horizontal spacing.



Figure 114: Before distribution

The result of the selections made in Figure 113 is shown in Figure 115.



Figure 115: After distribution: change to equal horizontal spacing, no vertical change

Chapter 6
Editing Pictures
(Raster Graphics)

Introduction

Earlier chapters of the Draw Guide have dealt only with vector graphics. However, Draw also contains a number of functions for handling raster graphics (bitmaps) such as photographs and scanned pictures, including import, export, and conversion from one format to another.

Draw can read all the usual graphics file formats. It has a subset of the same capabilities as specialized raster graphics programs like Adobe Photoshop or The Gimp.

Importing raster and vector graphics

To import stored graphics files, choose **Insert > Picture > From File** on the menu

bar or click the  icon on the Draw toolbar. Draw possesses import filters for many different vector and raster graphics formats. If your file has a nonstandard extension, you must choose the format explicitly when importing it.

Note

A filter for *.svg (scaleable vector graphics) files is available as an extension (<http://extensions.services.openoffice.org/en/project/svgimport>), but rather than using **Insert > Picture > From File** just open the *.svg file with **File > Open**. The SVG graphic is translated during the import into OOo graphics primitives.

If you select the **Preview** option in the Insert picture dialog (Figure 116), Draw shows a preview of the picture in the box on the right-hand side. This makes it much easier to choose the picture you want and to see whether Draw can import a file of this format.

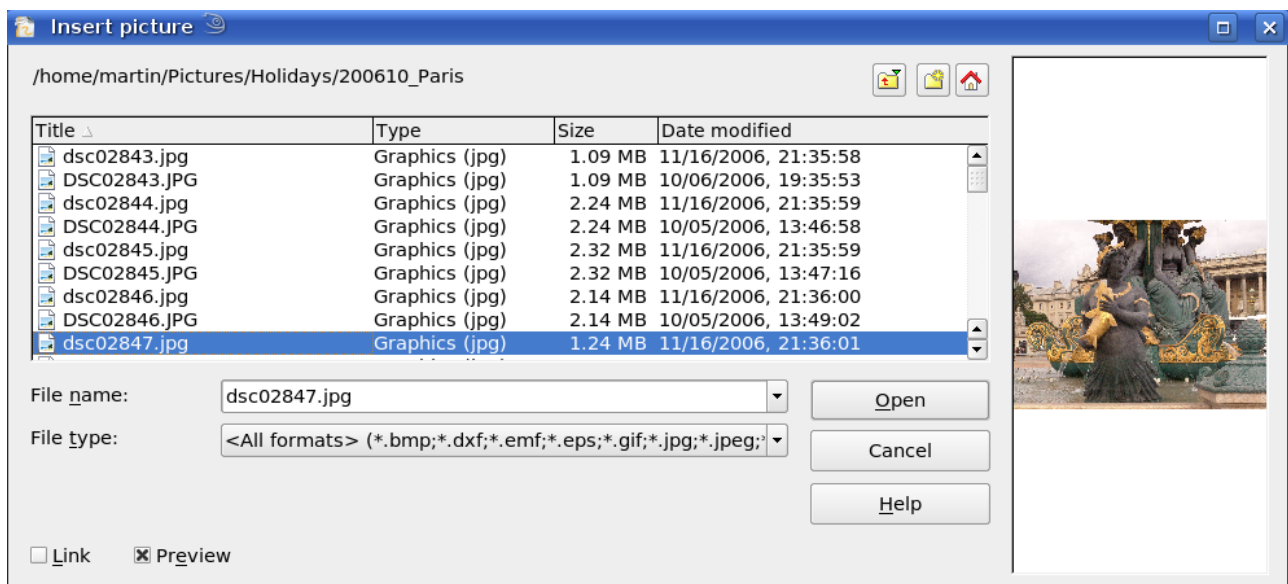

Figure 116: Inserting a picture; notice Link and Preview options in lower left of dialog

To link or to embed?

If you select the **Link** option in the Insert picture dialog, the graphic is linked rather than embedded. It is not actually inserted into the document; instead, a link to the graphic is created. This link is relative to the folder where the document is stored, even though it shows up in the Edit Links dialog (see Figure 117) as an absolute link. If you store the document and the graphic in the same folder, and transport the folder as a whole to another computer, the graphic will show up in the document as before.

Linked graphics are not changed as a result of any actions carried out within OpenOffice.org. Such changes affect only the view of the graphic in the document and not the graphic itself. In particular, the format of a linked graphic remains unchanged. In contrast, when a raster graphic is embedded in an OOO document, it is converted into PNG format.

Linking keeps the file size of the Draw document small. The picture can be edited or even replaced by another and the link will still function. As long as the new picture is given the same name as the old one, links will be re-established and updated when the document containing the link is next opened. However, some actions do not last beyond the current session (for example, Filter) or are simply not possible on a linked graphic (for example using the color replacer to exchange colors).

Links can easily be removed. The linked picture will then be embedded in the document. To break a link, choose **Edit > Links** from the main menu bar. In the Edit Links dialog (see Figure 117), choose the link to be broken and then click on the **Break Link** button.

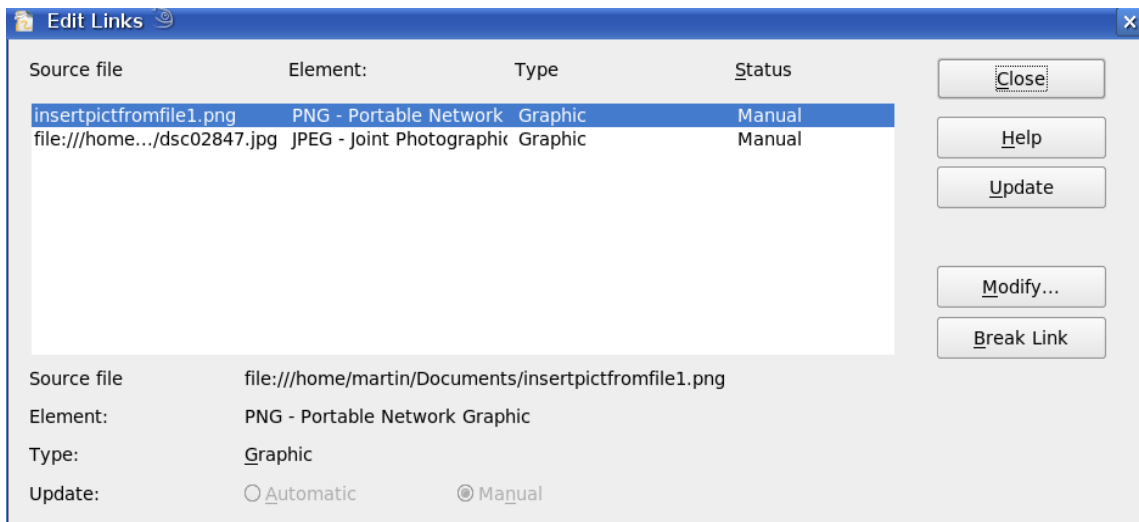

Figure 117: Editing links to documents

Scanning

With most scanners you can directly insert a scanned picture into a document. Scanned images are embedded in the document in PNG format.

Make sure that the scanner is supported by the SANE system if you are running a Linux (or other UNIX-like) operating system, or TWAIN if you are using Windows, and that it is already configured on the machine on which OpenOffice.org is running. If more than one scanner or equivalent device is present, you can select the source from **Insert > Picture > Scan > Select Source**.

To insert an image from the scanner:

- 1) Prepare the image in the scanner and make sure that the scanner is ready.
- 2) Choose **Insert > Picture > Scan > Request**.
- 3) The rest of the procedure depends on the scanner driver and interface. You will normally be required to specify the resolution, a scan window, and other options. Consult the scanner's documentation for more information.
- 4) When the image is scanned, Draw places it on the page. At this point it can be edited like any other image.

Pasting from the clipboard

The clipboard offers another way to insert graphics. Depending on the source and the operating system, figures may be in different formats. You can obtain an overview by choosing **Edit > Paste Special** from the menu bar or by clicking on the **Paste** icon's drop-down menu on the main toolbar. The choices on the list vary with the type of graphic on the clipboard.

Dragging and dropping

Drag and drop is also possible in many cases. The exact way that drag and drop works is determined by the operating system in use and the source of the graphic, regardless of whether the graphic is to be embedded or linked. The behavior can be controlled by the use of the *Control* or *Control+Shift* keys together.

Draw objects and images which are used frequently can be stored in the Gallery. Objects can be dragged from the Gallery to the Draw surface quite simply. Working with the Gallery is dealt with in Chapter 10 (Advanced Draw Techniques).

Inserting from a file

With this option, you can insert complete pages or single objects from existing Draw or Impress documents into your Draw document. In addition you can insert text in Rich Text Format (RTF), HTML format or plain text. The text will be contained within a text frame. The usual paragraph and character formatting options are available for this text.

Choosing **Insert > File** brings up the File selection dialog. Select the required file and click **Insert**. If the file is a Draw or Impress document, the Insert Slides/Objects dialog (Figure 118) opens.

To access single pages or slides of the document, click on the expansion symbol (usually a + or a small triangle, depending on your operating system) to the left of the file name in the selection area. The same method is used to display single objects within slides. Raster graphics (for example, photos) and Metafiles are marked with a



, drawing objects with a



, and OLE objects with a



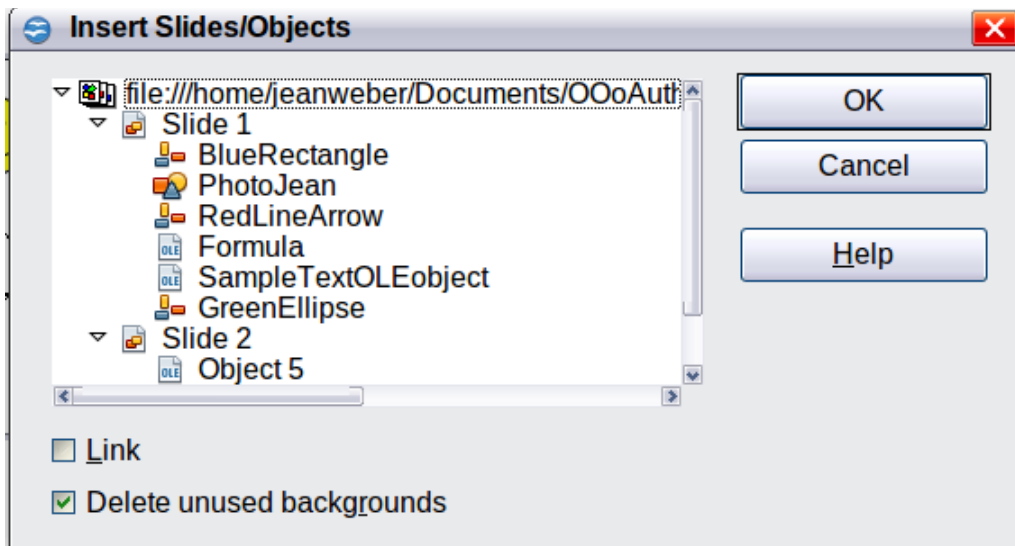

Figure 118: Inserting complete pages or objects on a page

Choose the slides or objects you want to insert; for multiple selections, press the *Control* or *Shift* key while clicking on the items. Click **OK** to insert the selected items.

If the inserted object was named in the source document, it keeps its original name unless the name already exists in the current document. In that case you must give the object a new name before it is inserted. To rename an inserted object, right-click and choose *Name* from the pop-up menu. Renaming has the advantage that the object is then listed in the Navigator.

You can choose whether to embed or link the selected page or object.

Exporting graphics

Draw saves drawings by default in the *.ODG format. Some programs cannot open these files. To use the drawings in other programs, you can export the graphics in various formats. Choose **File > Export** and then in the File format pull-down list select the desired format (see Figure 119).

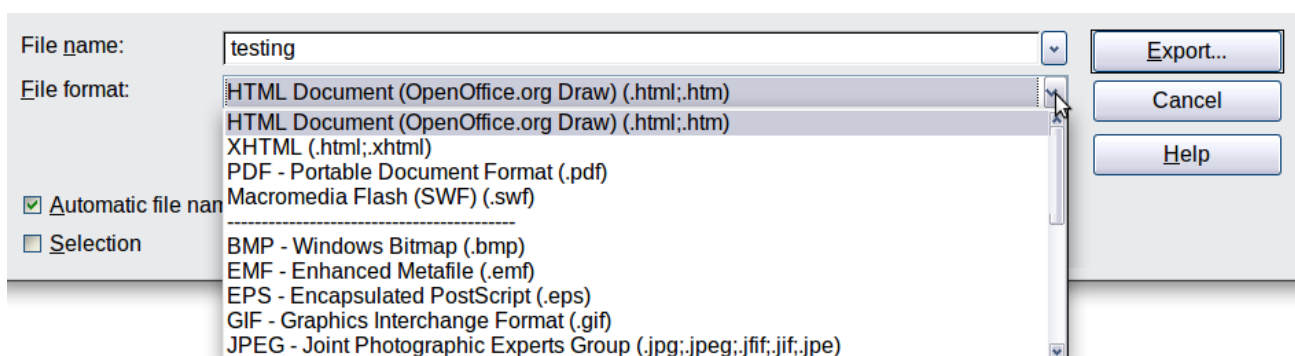

Figure 119: Lower part of the Export dialog

Exporting the entire file

The file format options in the upper area of the File format box (HTML, XHTML, PDF, and Flash) always apply to the complete file. Use of Flash or HTML format causes each page of the Draw document to be exported as a raster graphic. You will no longer be able to access individual objects on the page.

To export a multi-page Draw document as a series of web pages, choose **File > Export** and select **HTML Document** as the file type. The HTML Export wizard opens. Follow the prompts to create the web pages. If you wish, the wizard can generate a navigation aid to help in moving from page to page.

If you want to use the objects in other applications, select one of the Metafile formats (JPEG, PNG, TIFF, BMP and so on) in the lower part of the File format list (see Figure 120). With this type of export, only the currently active page is exported.

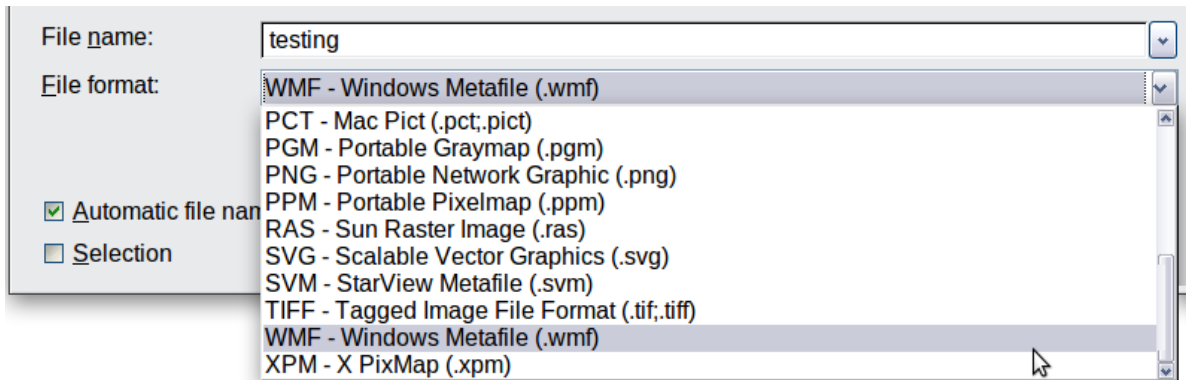

Figure 120: Section of the file selection list

Exporting single objects

In order to export individual drawing objects, you first need to select them. A selection can include more than one object. Take care to choose the *Selection* option on the Export dialog.

Exporting as a vector graphic

The choice of vector formats is still limited. An export to a DXF format file (Autocad) is not yet possible. Even the export of a graphic to a SVG format file is not yet fully implemented: 2D graphic objects are exported as paths and 3D objects only as preview images. Best supported are the Metafile formats and exporting to one of these is usually successful.

Exporting as a raster graphic

The choice of formats for export as a raster graphic is large enough to support most other applications. In case of doubt, test different formats to see which gives the best results; some programs behave differently depending on the format of the image imported into them.

After typing in a name for the exported file and selecting the file format, you may be able to set options for the exported image—compression, color format, version of Metafile—depending on the format chosen. Some examples of the various option dialogs are shown in Figure 121.

Where the export dialog allows you to specify the image resolution, this does not affect the number of raster points in the image. Rather it inserts information into the picture that tells other programs the dimensions to be used in displaying the image. This means that, among other things, missing raster points can be interpolated when the graphic is opened in the other program.

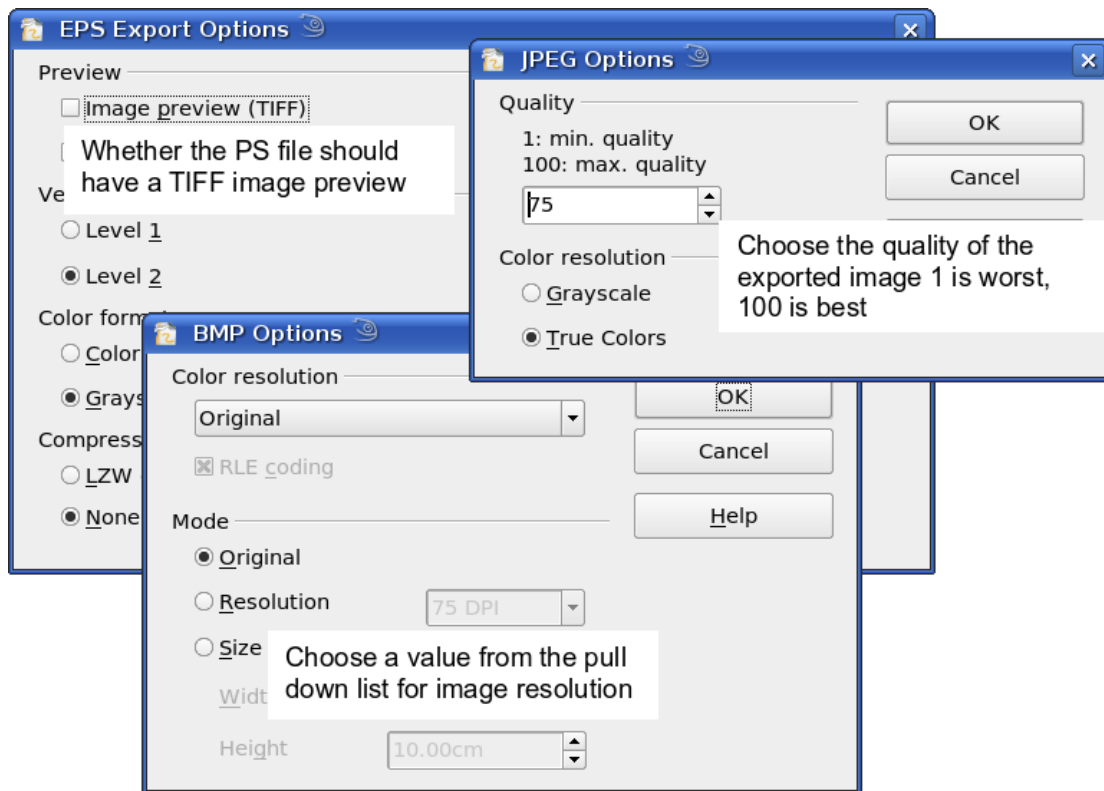

Figure 121: Adjusting format specific properties prior to export

The actual number of pixels used is determined by the screen resolution set up by the operating system and the Drawing scale factor set in **Tools > Options > OpenOffice.org Draw > General**. This is a limitation of the current user interface; it is possible to set other resolutions using macros.

Embedded raster graphics, or objects that have been converted to a bitmap or Metafile (from the context menu **Convert > To Bitmap / To Metafile**) may subsequently be saved as a picture; from the context menu choose **Save as Picture**. This saves the picture without Draw-specific additions such as text elements, borders, or shadows and without the possibility of setting any of the options available when exporting.

Draw objects can easily be imported into Writer, Calc, or Impress documents. For objects used often, this is most simply done by storing them in the Gallery or by using the clipboard. As Writer and Calc do not possess the same range of tools available within Draw, it makes sense to use Draw to produce a complex drawing and then to copy it into the other OoO application. A link to single drawing objects is not possible, but you can incorporate Draw documents in the other modules as linked OLE objects.

Tip To avoid problems when scaling Draw objects containing text after importing them into Writer, convert the object to a polygon before storing it in the Gallery or copying it to the clipboard. See “Convert to a polygon” on page 105.

Modifying raster object properties

As with other objects, the properties of a raster graphic can be modified. You can format the graphic using the Format menu or the context menu. Use the Picture toolbar to add or change filters using the Graphic Filter Bar; adjust the *Lines*, *Areas* and *Shadows* properties. The *Transparency* property in the Format menu does not relate to the transparency of the raster graphic itself but to the background area. To set the transparency of the graphic, you must use the Picture toolbar.

Graphics can also have a text element. For more on text, see Chapter 10 (Advanced Draw Techniques).

You can change the position and size of graphics, or rotate them, using the methods described in Chapter 3 (Working with Objects and Object Points). Raster graphics can be flipped (**Modify > Flip**), but note that some Metafile formats might have problems flipping text.

Graphics included as a member of a group behave like other drawing objects when the properties of the group are modified.

It is a good idea to (re-)name the graphic using **Name** from the **Modify** menu or the context menu. Only named objects are visible in the Navigator and only named objects can be directly imported from another file.

The picture (editing) toolbar

If you have enabled the Picture toolbar (in **View > Toolbars**), it will automatically appear on the screen whenever you select a (bitmap) picture (see Figure 122). It appears either directly under the menu bar in place of the formatting toolbar or as a floating toolbar elsewhere on the screen.

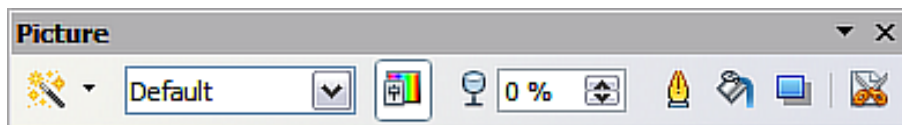



Figure 122: The Picture toolbar

The following table explains the individual functions on the Picture toolbar and illustrates their use with examples.

Filter		Opens the Filter toolbar, which is described in “The graphic filter toolbar” on page 98.
Graphics Mode		Use the Graphics mode menu to change the display of the graphic from normal color to grayscale, black and white, or a watermark. This setting affects only the display and printing of the picture; the picture itself remains unchanged.
Default:		The graphic is displayed unaltered in color.
Grayscale:		The graphic is displayed in 256 shades of gray.
Black/White:		The graphic is displayed in black and white.
Watermark:		The brightness and contrast of the graphic are reduced to the extent that the graphic can be used as a watermark (background).

Color



Use the Color tool to adjust the values of the three RGB colors, the brightness, contrast and the Gamma value. These adjustments do not affect the original picture but the values are stored in Draw as a separate formatting set.

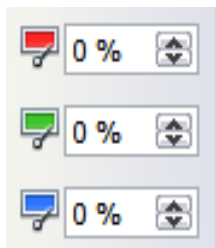

You can select values from between -100% (no color) to +100% (full intensity); 0% represents the original value of the property.

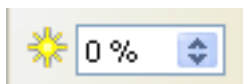

The brightness can be adjusted between -100% (totally black) and +100% (totally white).

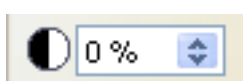

The contrast can be adjusted between -100% (minimum) and +100% (maximum).

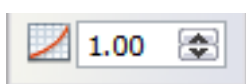

The Gamma value affects the brightness of the middle color tones. Values can range from 0.10 (minimum) to 10 (maximum)

Hint: Try adjusting this value if changing brightness /contrast does not give you the result you want.

Transparency

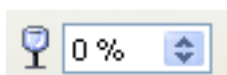

The degree of transparency of the picture can be adjusted between 0% (opaque) and 100% (fully transparent).

Line



Opens the Line dialog. In this context, line refers to the outline of the border. See also Chapter 4 (Changing Object Attributes).

Area



Opens the Area dialog. Here you can edit color, gradient, hatching and fills of the background area that contains the graphic—not the graphic itself. To see the background, you must set the transparency of the graphic to a suitably high value.

Shadow



Use this tool to set a shadow effect around the graphic.

Crop



Use this function to crop (trim) an image. When you click on this icon, crop marks appear on the image (Figure 123). Drag one or more of these marks to crop the picture to your desired size. For more accurate cropping, see “Cropping” below.



Figure 123: Interactive crop marks on an image

Cropping

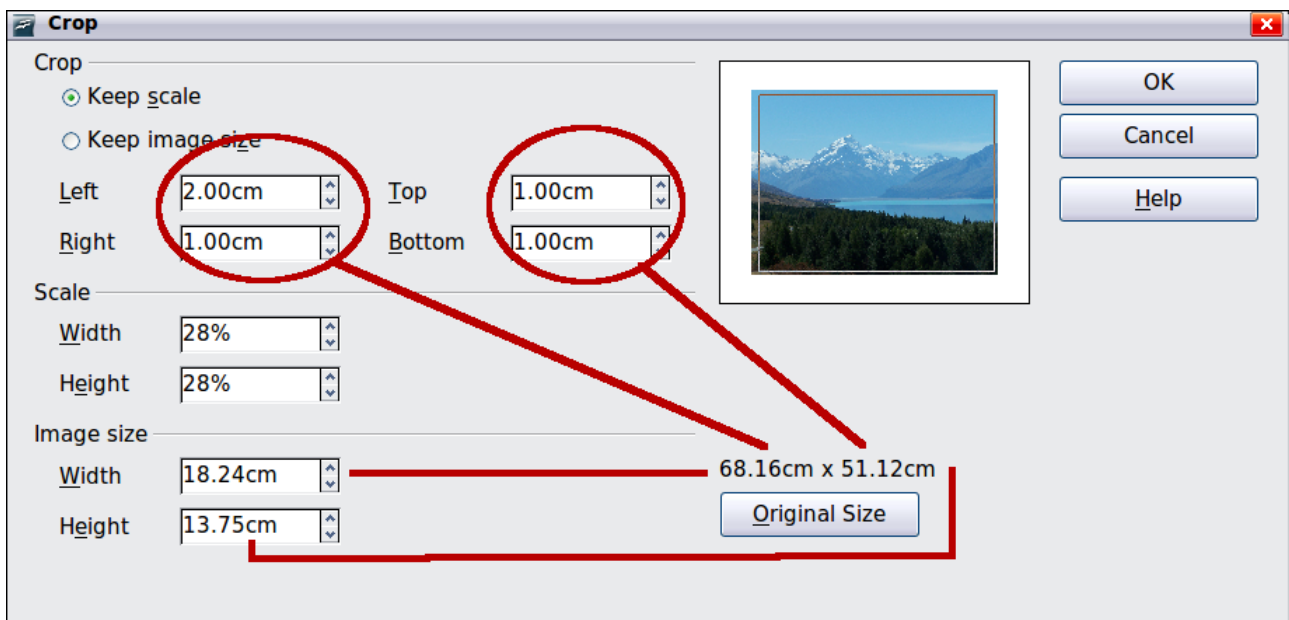

Figure 124: The Crop dialog

More control and accuracy over cropping functions are available via the Format menu. Click **Format > Crop Picture** and the dialog box in Figure 124 will appear. The fields *Left*, *Right*, *Top*, and *Bottom* establish the amount to be trimmed off the appropriate edge.

In addition to cropping, you can also enlarge or reduce the size of the graphic by changing the percentage scaling values. The new dimensions of the graphic are shown in the *Image Size* width and height boxes, which can also be directly adjusted.

In Figure 124 you can see that 2 cm from the left side and 1 cm from the top, bottom, and right side will be trimmed from the original object. The preview pane shows the location of the new edges of the graphic. In addition both height and width have been scaled down by 28%.

- If you choose *Keep Scale*, the graphic will be cropped to the scales shown in the width and height boxes and the picture reduced in size accordingly.
- If you choose *Keep image size*, the graphic will be cropped and then enlarged to the original image size.

Take care with these operations: in the Crop dialog the width and height are treated as totally independent values. Changing one without the other can result in significant distortion of the image; this might not be what you want. (The Position and Size dialog on the context menu has an option for keeping the width:height ratio fixed while changing one of the two dimensions.) Changing values in one area (Scale or Image Size) will show up correspondingly in the other area.

Caution



Any changes made in the Crop dialog change only the view of the picture. The original picture is not changed. If you want to export a cropped graphic, you must do it through **File > Export**. If you use the option **Save as Picture** from the context menu, the changes are not exported.

The graphic filter toolbar

Click the **Filter** icon  to open the Filter toolbar. Draw offers eleven filter effects. Filters work on the current view of an object and they can be combined. Filters always apply to the entire graphic; it is not possible to use filters to edit only a part of the object.



Invert reverses (inverts) the colors of an image so that it appears as a color negative of the image.

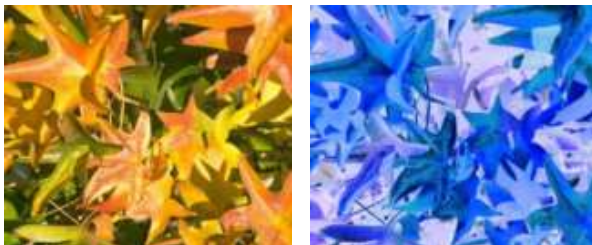

Smooth reduces the contrast between neighboring pixels and produces a slight lack of sharpness. If you use the filter several times in a row, the effect will be strengthened.





Sharpen increases the contrast between neighboring pixels, emphasizing the brightness difference. This will accentuate the outlines. The effect will be strengthened if you apply the filter several times in a row.



Remove noise compares every pixel with its neighbors and replaces the extreme values (those that deviate in color by a large amount from a mean value) by a pixel with a mean color value. The amount of picture information does not increase, but because there are fewer contrast changes our brains can better recognize the resulting graphic. This filter tends to make the picture also a little more smooth.



Solarization was originally a photochemical effect. If the location of a photograph is extremely highly lit, you can experience a reversal of color and brightness. Similarly, entry of light during the developing process reverses the brightness values. These phenomena were used for artistic production of pictures.

With this filter you input a threshold brightness value, above which the color values are reversed (middle picture, threshold value 70%). With the Invert option the whole of the resulting picture is inverted in color (right picture).

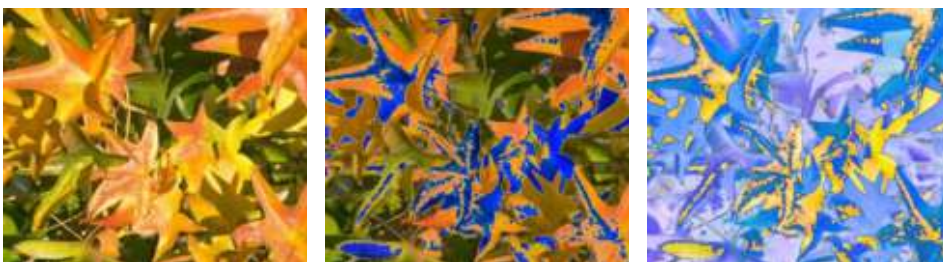



Aging lends pictures a certain “look” resembling that of old photos. The process first produces a grayscale picture from the original and then reduces the intensity of the blue and green color values, so that the final picture appears darker and redder. In the middle example, the aging degree was set to 0%, on the right it was 15%.



Posterize reduces the number of colors in the picture. The fewer colors, the more flat the picture appears. In the right hand picture below the number of colors was reduced to 8. The results of this filter are not always good.



The **Pop-Art** filter is supposed to change the colors of the picture to a pop-art format, but unfortunately it does not seem to function correctly at present.

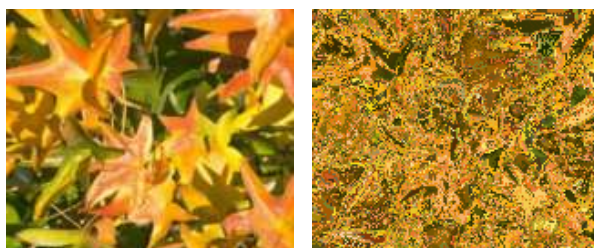

Charcoal sketch makes the picture appear as if it had been drawn with charcoal. The outlines are in black and the original colors are suppressed.

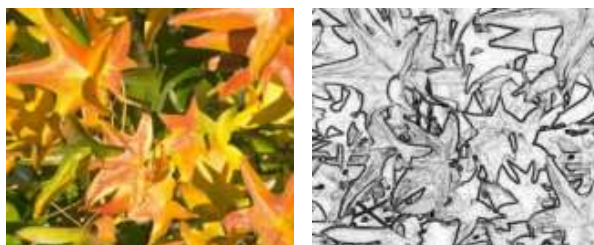



The **Relief** filter calculates the edges in relief of the picture and produces a picture as if illuminated by a light source, the position of the illuminating light being variable and producing shadows that differ in direction and magnitude.

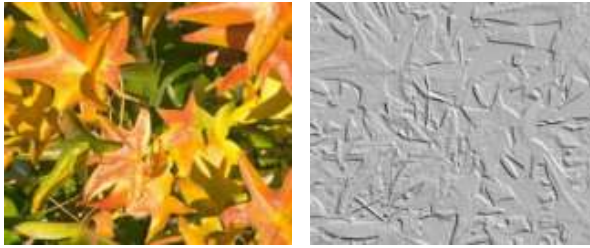

Mosaic takes groups of pixels and converts them into a single color rectangular tile. The whole picture appears to be a mosaic. The center and right pictures below had an element resolution of 5 pixels. The picture on the right also had the *Enhance edges* option selected; with the greater contrast at the edges, it appears to be a little sharper.



Caution



If your picture is linked, filters are applied only to the current view. The stored picture is not changed. When you close the document, all filtering is lost. You should ensure that you export the picture to create a copy with all the filters applied (**File > Export**).

If you have embedded the graphic in the document, all filters are applied directly on the embedded graphic and cannot be undone in a subsequent session. If you do not want to retain a filter, you must use **Edit > Undo** to return to an earlier state of editing. After you save and close the document, the filter effects are permanent.

Changing colors using the eyedropper

Use the eyedropper to change one color in a picture for another or set the color as transparent. The tool always works on the entire picture; you cannot select only a region for editing.

The changes are carried out on the graphic itself and therefore require it to be embedded. Attempts to use the eyedropper tool on a linked graphic result in the following message: *This graphic is linked to a document. Do you want to unlink the graphic in order to edit it?*

The tool can be used on all raster graphic formats and with many—but not all—Metafile formats.

Note

In OpenOffice.org 3.4, this feature is called the Color Replacer.

Practical example: Changing wrong colors to transparency

Some applications, which cannot correctly handle transparency, show transparent areas with the color **Magenta** and then store the graphic with this color and without the correct transparency information.



Bitmap graphic with area in magenta, which actually should be shown transparent. On the left is the original picture, right is the picture after saving it with MS Paint.

If you receive such a picture, you can recreate the transparency with the eyedropper tool.

Open the Eyedropper dialog with **Tools > Eyedropper** and click on the picture to be edited.

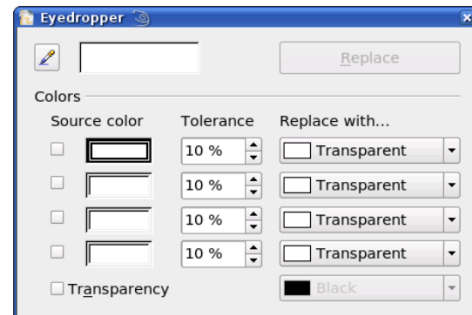

Now click on the icon , to change to the color selection mode. Outside the dialog the cursor changes to a hand. The field next to the icon shows the color immediately under the hand cursor.

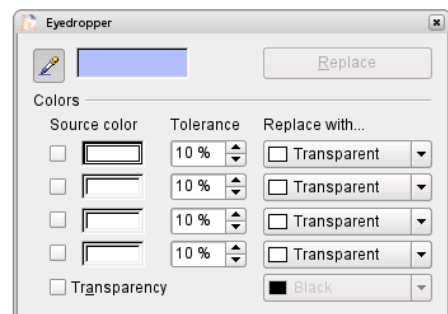

Click on the color to be changed. The first Source Color box is now marked and the color selected appears in the left box. In the *Replace with* selection list, the option *Transparent* is already selected. Click on the **Replace** button at the top right of the box to carry out the changes to the picture. There is no preview of the effect. If the result is not what you wanted, choose **Edit > Undo**.

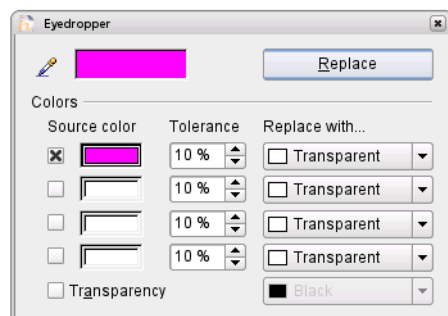

The dialog does not close automatically, so you can carry out further color replacements. Mark first the field for the Source color and choose again the color with the eyedropper. Close the dialog with **Ctrl+F4** or the **Close** icon on the window border. Draw uses a separate Alpha channel for transparency so that pixels of different colors can be made transparent.

It is also possible to carry out the operation in reverse to change a transparent area to a color. Select nothing in the graphic but choose the Transparency option at the lower left of the dialog and the replacement color at the lower right.

The selection list for replacement colors shows all the available colors in the current color palette of the document. You cannot define any new colors here but you can add colors to the available palette before using the eyedropper tool. For more on this topic, see Chapter 8 (Tips and Tricks).

Effect of the tolerance parameter

The tolerance parameter describes how closely a color value in the picture must agree with the source color in order to be replaced. In the figure below, the red color tone at the left edge of the rectangular color palette is used as the source color and a pure blue as the replacement color with several different tolerances. The original is a rectangle with color palette from red to green. Because the eyedropper is not usable on drawings, the rectangle on the left side was converted into a raster graphic (**Convert > Bitmap**). The picture was then exported in a Enhanced Metafile format and inserted on the right for comparison.

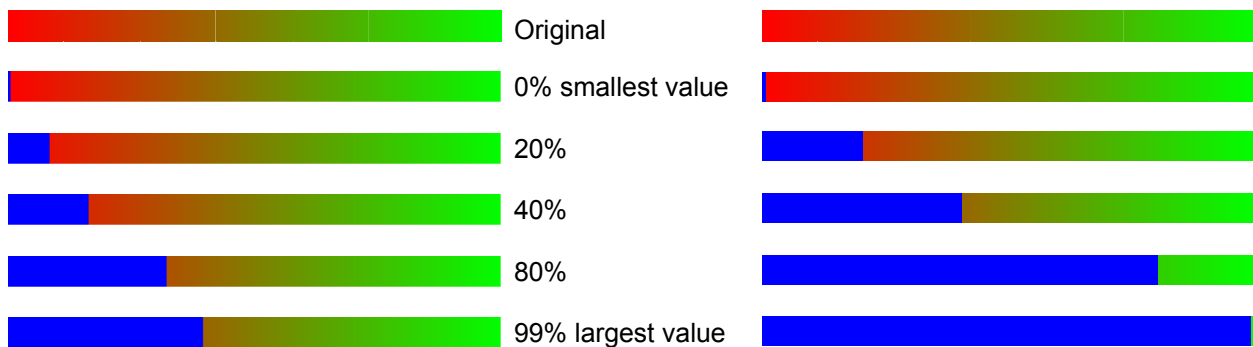

Note As shown, the application of transparency and color replacement effects on raster graphics and Metafiles leads to quite different results. This is a known problem, which will be corrected in a future version.

Color depth

It is possible to reduce the color depth in OOo. The tools are available but you must create a separate menu and add the tools to the menu if you wish to have them available (refer to OOo help if you are not sure how to do this). To find the tools, click on **Tools > Customize, Toolbars, and Add** (Command). The commands are in the category *Modify*, at the top of the list.

Reducing color depth



Original with a 24 bit pixel depth (=8 bits per channel)



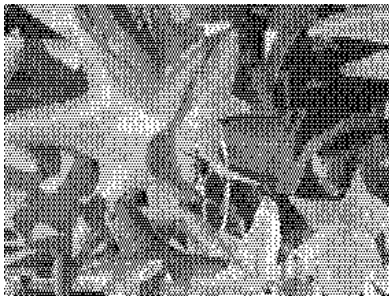

1 bit dithered

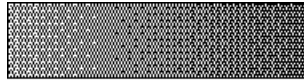

The impression of grayscale is produced by a raster. In reality there are only two colors.



1 bit threshold



The threshold determines which pixels are black and which are white. You cannot set it directly but you can influence which part of the image is set to black by varying color settings on the picture toolbar—red, green, blue level, brightness, contrast, and/or gamma value—to see what works best for your image. You must export and save the modified image with **File > Export** and then reopen it, before you finally change the color depth.

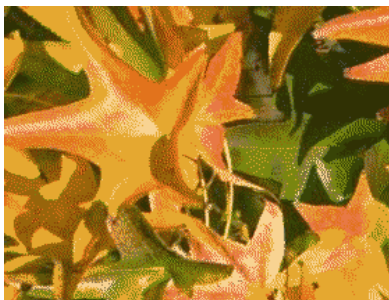

4 bit color palette



With 4 bits a total of 16 colors can be produced. The color steps are quite fine, because the process does not use the 16 RGB basic colors, but selects from the palette those that best match the colors in the image.



4 bit grayscale palette

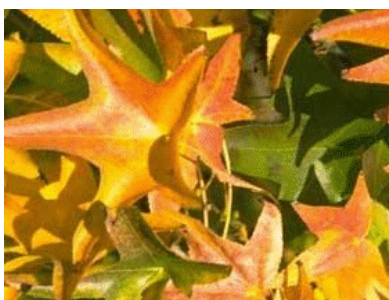

8 bit color palette



With 8 bits a total of 256 colors can be produced. The image at left is at first glance very difficult to distinguish from the original. A big difference is that the picture file is only one third of the size of the 24 bit version.



8 bit grayscale palette



Conversion

Convert to a contoured image

Select the picture so you see the green handles. From the context menu or from the **Modify** menu choose **Convert > to Contour**. This command creates from the original image a polygon or group of polygons, with four corner points and the image set as a background graphic. In this state you are not able to further edit the graphic. All your modifications must be completed before this point.

The polygon is in fact a vector graphic but the picture remains as a bitmap image. Using a polygon offers possibilities for further change; for example, you can modify the shape or define a transparency gradient.

Convert to a polygon

Select the picture so you see the green handles. From the context menu or from the **Modify** menu, choose **Convert > to Polygon**. This command converts areas of the same color into small filled polygons. The total image becomes a vector graphic and can be resized with no loss of image quality or distortion of text. The resulting format will be a Metafile.

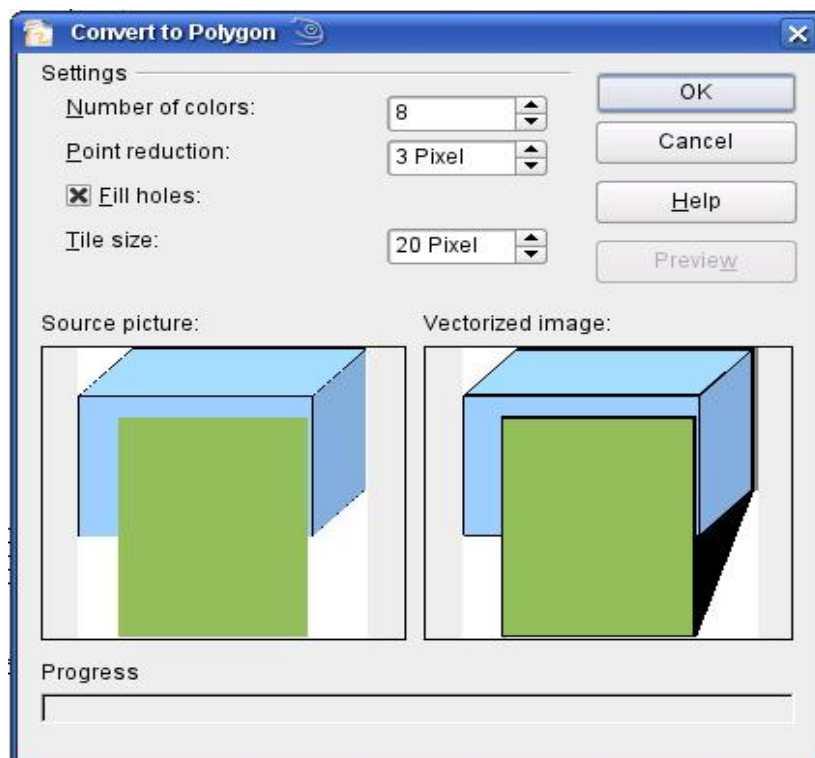

Figure 125: Conversion of a picture to polygons

The Convert to Polygon dialog has a number of settings which can be tested using the *Preview* button. Because graphics conversion can take some time, depending on the picture and the computer, a progress bar is included at the bottom of the dialog.

Number of colors

Draw considers between 8 and 32 colors in the conversion. The picture can, however, contain fewer colors than 8. For every color occurring in the picture, Draw creates a polygon, which may consist of several disconnected parts. These polygons are then filled with the relevant color.

The algorithm used to reduce the number of colors in the picture to the number specified is not yet optimal. For this reason you may prefer to try reducing the number of colors by changing the color depth or with the *Posterize* filter (page 100) from the Graphic Filter toolbar (page 98).

Point reduction

Polygons will only be created if they have a size greater than the value given in this setting. The section of the picture below, highly magnified, shows that with a larger point count small flecks of color—typical of irregular color patterns—simply disappear.



Fill holes

Point reduction can result in small areas or “holes” which are not covered by a polygon. If the **Fill holes** option is marked, additional square, tiled areas are created with a background color the same as the hole. The **Tile size** option allows the width in pixels of the width of these square areas to be preset.



Original picture



Original picture with 16 colors and 0 Pixel point reduction vectorized



Original picture transformed with the Poster filter and 64 colors ...



... and then with 16 colors and 0 pixel point reduction vectorized.

Here the picture is transformed with the Poster filter, but this time with a point reduction of 4 pixels and a tile size of 16 pixels.



The effect below was generated from the picture to the left (posterized and vectorized); the polygons were split with **Modify > Break**, and a number (in this case 6) of the (foreground) polygons were deleted until the resulting background was achieved.



Note: To select polygons for deletion, click on a curved colored area (the text in the status bar shows "Polygon nnn corners selected", where nnn is the number of corners of the polygon) and a frame with green handles encloses the area of the polygons selected. Press *Delete* to delete the polygons. Repeat until you have achieved the desired effect, (which here is to have only the background showing).

If you next 'split' the existing Metafile (**Modify > Split**), access is gained to individual polygons. To be able to operate on these together you should immediately group them after splitting.

With this vectorized form of the image, you can carry out operations familiar from classic drawing programs, for example a curved warping operation. For such transformations, it is much less effort to use a conversion with background tiles so that the edges of the picture are straight.

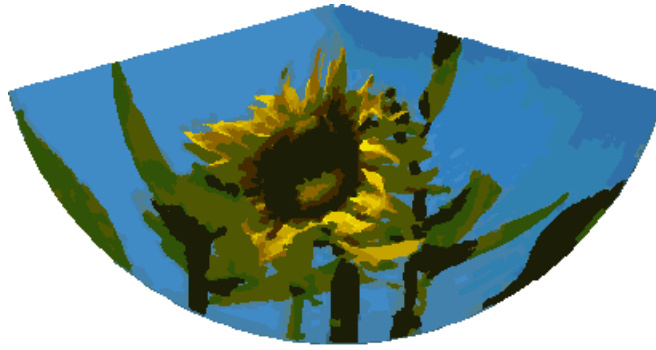

Using the graphic generated in the posterize and vectorize process above, Break and Split it, and then try out some operations using the tools on the Effects toolbar.

To use this tool to vectorize the first letter of a chapter in a special font, convert the graphic to a polygon, using no point reduction or background tiling. Use **Modify > Break** to generate two polygons. An example is shown below.



Original polygon, converted from a Metafile.
Break the graphic into two polygons.

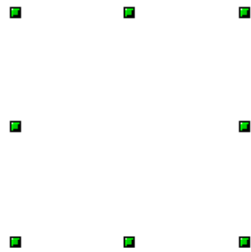

After the conversion there are two polygons, one with the visible letter and another polygon, not visible because the lines and area filling are all in white. You can select this “invisible” polygon by pressing the *Tab* button (click on the visible letter first, then press *Tab*; this moves the current selection to the next object). In the example at the left, the invisible polygon has been moved to the side. If you have Display Grid active and the grid points set to display behind objects, you can see where this invisible polygon is, since it obscures the grid points behind it.



This invisible polygon encloses the letter. After changing lines and/or area to a different color, the polygon becomes visible.

Convert to bitmap

All drawing objects are vector graphics. Use the command **Convert > To Bitmap** from the context menu to convert a vector graphic to a raster graphic. Draw creates the raster graphic in PNG format with a color depth of 24 bits. Unfortunately any transparency effects which were created in the vector graphic are lost in this conversion, although the PNG format used in Draw does support transparency. Only if you use the eyedropper tool to set transparency will an Alpha channel also be produced.

To determine the height and width of the converted graphic (number of pixels), Draw considers the dpi setting of the operating system for the screen and the percentage scaling factor set under **Tools > Options > OpenOffice.org > View** in the section *User Interface*.

Example:

Width of vector graphic: 1.5 inch

Monitor setting of operating system: 96 dpi (= 96 dots per inch)

Scaling 130 %

Calculation: 1.5 inch x 96 dpi *130% = 187 pixels

The actual number of pixels will vary somewhat from this value due to rounding. When the format permits, Draw uses a dpi value (in this case 125 dpi) which permits the calculation to be reversed and the picture with this pixel value reproduced with the correct width of 1.5 inch.

Print options with raster graphics

If you have only a black and white printer or are experiencing problems with printing, you should check the following settings.

You can set up printing so that all text and all graphics are printed in grayscale or black and white. The general settings are in **Tools > Options > OpenOffice.org Draw > Print** in the section *Quality* (see Figure 126). To set these for the current document only, use *Options* in the Print dialog (**File > Print**). With both Black/white printing and Grayscale printing, no background is printed.

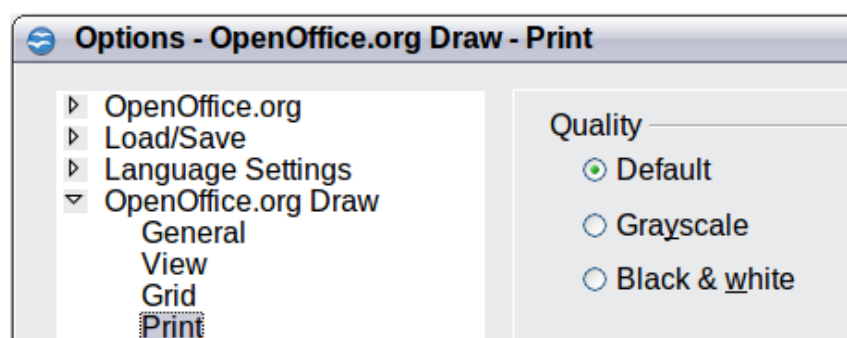

Figure 126: Options - OpenOffice.org Draw - Print

Other options are in **Tools > Options > OpenOffice.org > Print** (see Figure 127). They relate to page options (scaling) and other printing variables. They affect the size of the print file and the time taken to print the document. With most modern systems you can simply accept the defaults. As different operating systems and printers have their own requirements, you need to tailor the settings to your particular site conditions. Refer to the Help file for more information.

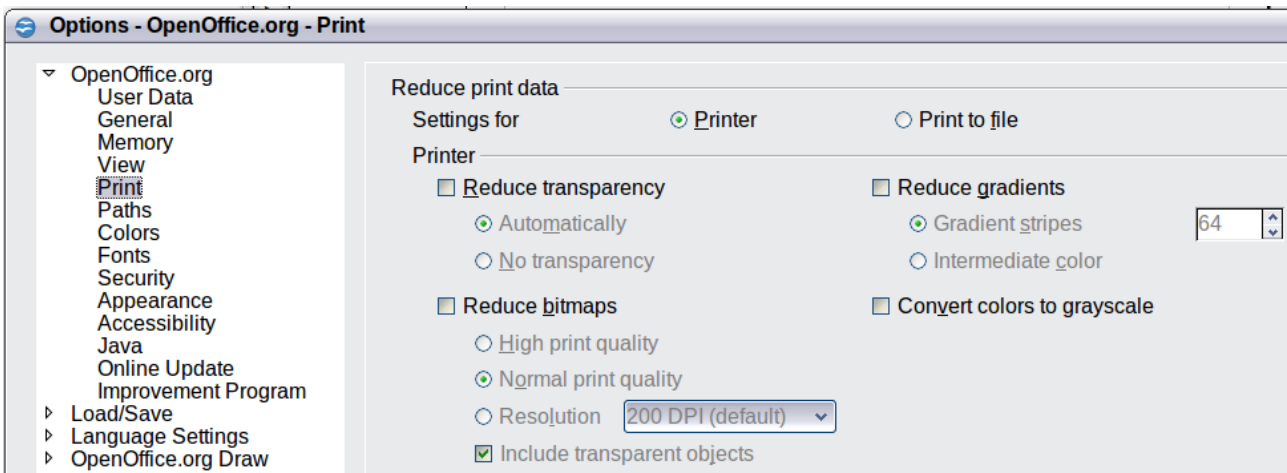

Figure 127: Options - OpenOffice.org - Print dialog



Chapter 7

Working with 3D Objects

Free eBook Edition

Creating 3D objects





Although Draw does not match the functionality of leading drawing or picture editing programs, it is capable of producing and editing very good 3D drawings and pictures.

Draw offers two different types of 3D objects: *3D bodies* and *3D shapes*. Depending on which type you choose, there are different possibilities for further editing of the object (rotation, illumination, perspective). 3D shapes are simpler to set up and edit than 3D bodies, but 3D bodies currently allow for more customization.

Creating 3D bodies

You can produce 3D bodies in three ways: extrusion, body rotation, and using ready made objects. In this chapter, these methods are called Variation 1, 2, and 3. Two further variations, extruding Basic Shapes and converting text to 3D, are also described.

Variation 1: Extrusion

First, draw one of the common Draw objects, for example a square/rectangle, circle/ellipse or a text box using the   or  icons on the Drawing toolbar. Next, choose **Modify > Convert > To 3D** (or right-click on the object and choose **Convert > To 3D**, or click the  icon) to produce a 3D object from the 2D surface.

The  icon is not usually visible on the Drawing toolbar. To make it visible, select **Visible Buttons** from the toolbar menu at the right-hand end of the toolbar and click on the icon to make it visible.



Figure 128: Extruding 3D objects from 2D surfaces

The procedure by which parallel surfaces are moved to create a 3D object is known as *extrusion*. In this case the 2D surface is moved forwards “out of” the drawing level. At the same time the object is slightly tilted and central projection turned on so that one can better recognize the object. Draw uses a default value for the extrusion (the body depth) based on the size of the 2D object. The value can be changed after the extrusion; see “Editing 3D objects” on page 116).

Variation 2: Body rotation

Choose a common drawing object, for example a (non-black) line. Then change this into a rotation body. Draw provides two methods to do this.

Method 1. Click the icon  in the Drawing toolbar (this icon also usually needs to be made visible) or choose **Modify > Convert > To 3D Rotation object**. With this rotation method, the axis of rotation coincides with the left edge of the enclosing selection rectangle, through the green rectangle handles.

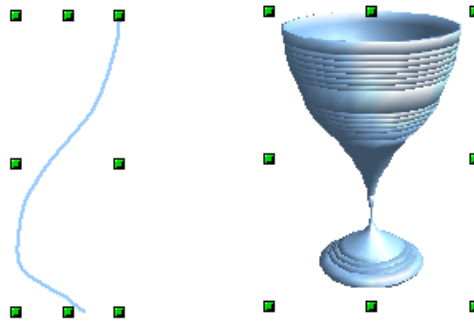



Figure 129: Rotation body created using variation 2.1

Method 2. Click the icon  on the *Effects* pull-down menu on the Drawing toolbar. This icon can also be accessed from the Mode menu, accessible from **View > Toolbars > Mode**. Notice that this icon lacks the curved red arrow of the fixed-axis rotation icon.

With this method, you can change the location of the rotation axis, which appears as a dotted line with two white circular endpoints.

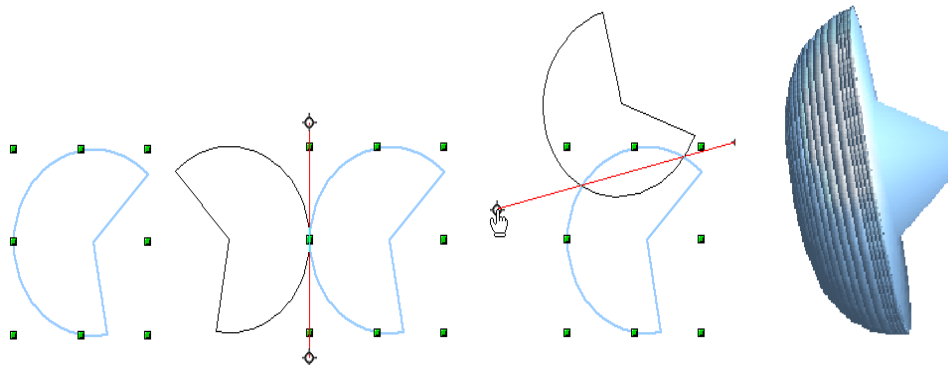

Figure 130: Rotation body created using variation 2.2

Click one of the white endpoints and drag it so that the axis moves to the desired position. You may need to move both ends to achieve this. The outline shows how the figure will be rotated. When you click on the figure again, the rotation is carried out and the new 3D body is produced.

Variation 3: Using ready-made objects

Use the 3D Objects toolbar/pull-down menu (Figure 131). To activate this toolbar, click **View > Toolbars > 3D Objects**).

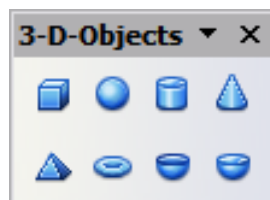



Figure 131: The 3D Objects toolbar

If you add the icon  to the Drawing toolbar, the 3D Object bar will be available as a pull-down menu or as a floating toolbar.

After choosing the type of object, left-click on the starting point and drag the mouse diagonally until the outline of the object is the size you want.

After releasing the mouse button, the 3D object appears. To change the height:width ratio of the object, keep the *Shift* key pressed while dragging the mouse. Most of these objects are constructed by rotation. Cubes and spheres are special types of 3D objects that are directly defined in the OOo program code.

3D scenes

Variations 1–3 all produce a result known as a *3D scene*. If you click on a 3D scene, the status bar text shows *3D scene selected*. Such a scene is actually a group of objects.

If you constructed the scene using one of the above methods, it consists of the 3D body as a single element. 3D scenes can, however, be extended to include other 3D objects, as described in “Combining objects in 3D scenes” on page 134.

As mentioned in Chapter 6 (Editing Pictures), you can access individual elements of the group using **Modify > Enter group** or the context menu. The status bar text then changes and shows the type of each individual element selected, for example *Sphere selected* or *Extrusion object selected*.

Producing 3D shapes

Since the release of Version 2.0 of OpenOffice.org, Draw contains a type of drawing object known as a (Basic) Shape. A special method of extrusion exists for these shapes.

Variation 4: Extrusion of basic shapes

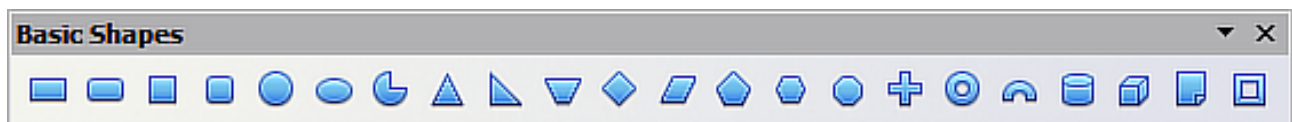



Figure 132: The Basic Shapes toolbar

You use the Basic Shapes toolbar (or another shape toolbar) to produce 2D surfaces. Shapes such as cylinders or cubes are technically possible but not very useful, because they produce curiously curved images. If you have drawn a shape, the last icon  on the Drawing toolbar is active. A click on this icon can transform a 2D surface into a 3D object (see Figure 133).

Extrusion of a shape does not create a new object type but just changes the shape’s appearance. All the object’s properties and settings are retained. You can use this button to toggle between a 2D and a 3D view. The actual object properties and settings are not lost in the switching operation from one view to another.

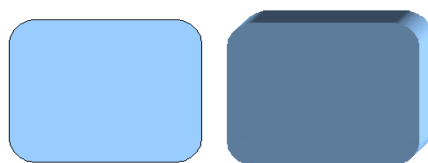



Figure 133: 3D objects from basic shapes

If you click on such an object, the 3D-Settings toolbar is available. If this is not automatically opened, switch it on with **View > Toolbars > 3D-Settings**.



Figure 134: 3D-Settings toolbar

The first icon  corresponds to the icon on the Drawing toolbar. This icon also works as a toggle switch. After changing to 2D, the 3D-Settings toolbar is again hidden. To change the object back to 3D, you must use the icon  on the Drawing toolbar.

Variation 5: Fontwork

For text you can also use the shapes from the Fontwork Gallery. These produce a similar type of extrusion objects to those from Variation 4.

To open the Fontwork Gallery, use the icon  on the Drawing toolbar.

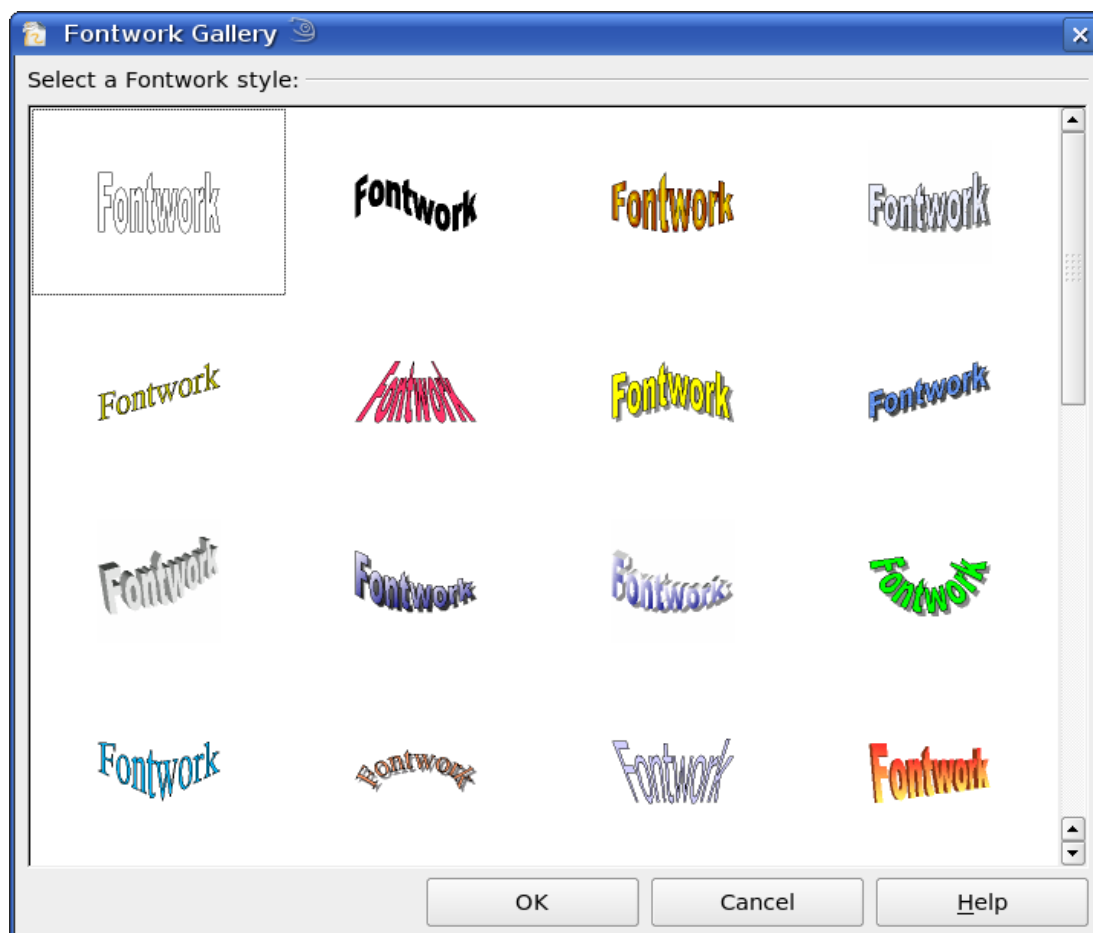

Figure 135: Extrusion Shapes from the Fontwork Gallery

Note

If you save a document with extruded shapes in the older *.sxd format, the shapes will be converted to 3D scenes.

Editing 3D objects

Rotating 3D objects

Procedure for 3D bodies

The Rotation command used for 2D objects also works with 3D objects, but due to the additional axis, there are a few differences with the editing of 3D objects (see Figure 136). The procedure for selecting the object is identical to that used for a 2D object.

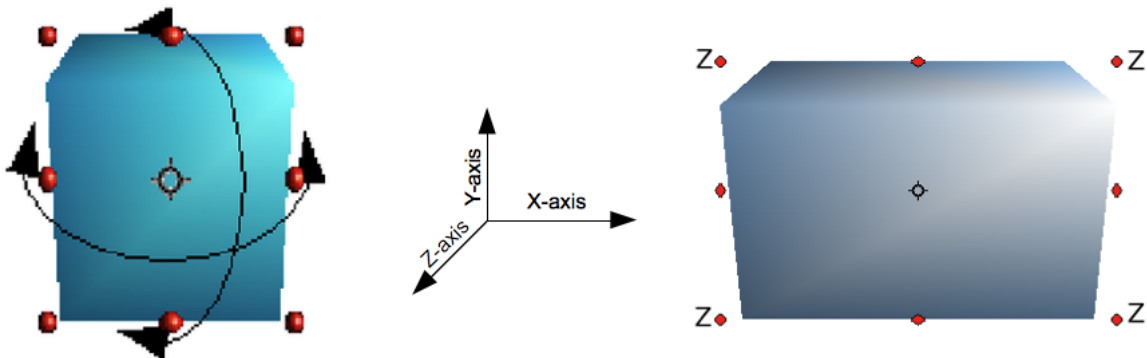



Figure 136: 3D object rotation

You can rotate the object about each axis (X,Y,Z). The X and Y axes are those parallel to the edges of the drawing layer, while the Z axis comes out of the page. It is not possible to change the axis orientation.

The three axes are not shown directly, but the  symbol indicates their intersection point.

If you want to ...

... rotate the object about the X or Y axis.

... rotate the object about the Z axis.

... move the axis intersection point.

You must ...

... put the mouse cursor over the object. With the left mouse key pressed you can now rotate the object as you wish. Moving one of the red points at the middle of an edge allows you to rotate the object about only one axis. Note that the cursor initially has the shape for a (2D) shearing movement but pressing the mouse button changes it to a rotation cursor.

... move the handle on one of the corner points with the left mouse button pressed. Rotation about the Z axis is independent of the setting of the rotation angle in the dialog *Position and Size*.

... simply drag the Symbol  to the desired location. The point is located by default in the middle of the object.

These rotations can be carried out on a 3D scene as a whole or on individual objects within a 3D scene.

Procedure for 3D shapes

Objects produced using variations 4 and 5 (see above) can only be rotated about the Z axis when using the three methods described in the previous section. This rotation is carried out on the underlying 2D object. It is also possible to rotate the 3D object in the same way as with a 2D object using **Format > Position and Size > Rotation** (shortcut key for Position and Size is *F4*) and specifying the pivot point location and the number of degrees of rotation desired.

Shape objects have their own procedure for rotation about the X and Y axes. If you have activated the 3D-Settings toolbar (under **View > Toolbars**), this becomes active when you select the 3D object; icons 2 to 5 on this toolbar (see Figure 137) rotate the object in 5 degree increments about the X and Y axes.



Figure 137: 3D-Settings toolbar with rotation icons indicated

3D settings for 3D bodies

3D Effects dialog - general buttons

The 3D Effects dialog offers a wide range of possible settings for 3D objects produced with variations 1 to 3 (see previous sections). To open the dialog, right-click on the object and choose **3D Effects** from the pop-up menu. You can also activate a 3D

Effects icon  on the Standard toolbar or add it to another toolbar using **Customize Toolbar > Add > Category Options > 3D Effects**.

Tip

If you cannot see **3D Effects** on the pop-up menu you probably have a 3D object extruded from a basic shape by clicking on the icon for Extrusion On/Off on the Drawing Toolbar.



The dialog can be docked in a similar manner to the Navigator or Template windows. The possible settings are arranged in various thematic categories on separate pages, accessible through the buttons at the top of the window, which act in a similar way to tabs. To apply the settings you have altered, click the Assign button . This applies *all* the changes you have made to the object on the other pages of the dialog as well as the current one.



Figure 138: Upper part of the 3D Effects dialog

Note

Only the selected effects are assigned to the object. There is no object conversion; thus a cylinder cannot be transformed into a ring through the application of a 3D effect. However, it is possible to change the appearance to resemble a wooden or metal body. By the assignment of a 3D effect, 2D objects are transformed into 3D objects.

In order for the Effects dialog to take over all the current properties of the object, you must click the  button. If you deactivate this button before you leave an object and click on it again when you open the Effects dialog for another object, the settings are carried over from the first object to the second object. You can use this to transfer favorite settings from one object to another, as all the settings are brought over to the new object. In normal use, however, the icon should be left activated.

At the bottom left of the dialog is another row of buttons (see Figure 139), which are available on each page.



Figure 139: Buttons for geometric transformations

The first two buttons correspond to the menu commands **Modify > Convert > To 3D / To 3D Rotation Object**. When the Effects dialog for a 3D object is called up, these buttons are inactive. Selecting a 2D object activates them. The third icon switches a perspective view of the object on or off.



Converts the selected 2D object to an extrusion body.



Converts the selected 2D object to a rotation body.



Switches between a central projection and a perspective projection.

With a *central* projection parallel edges are shown as meeting at some common point in the distance, as shown on the button symbol. *Parallel* projection retains all parallel edges as parallel, a procedure often used to produce oblique figures in school. The switching process is carried out on the entire 3D scene.

With central projection (see Figure 140), Draw creates the object with three vanishing points. The parameters for central projection are set (indirectly) through the camera settings on the *Shading* dialog page.

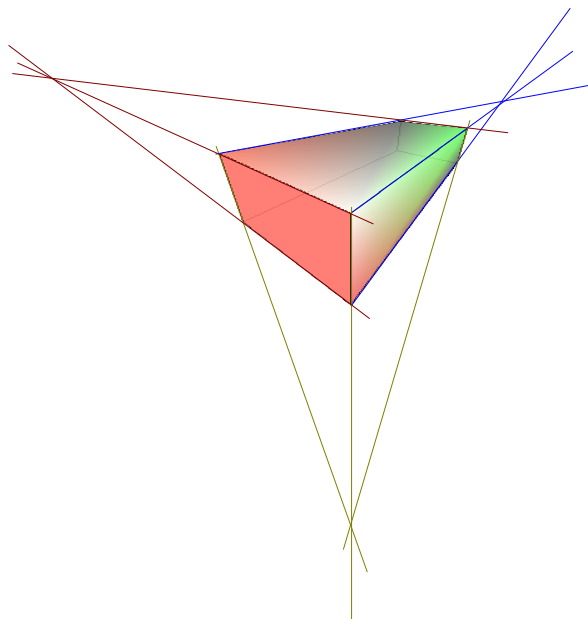



Figure 140: Figure shown using central projection.
For clarity, the projection lines have been added.

3D Effects - Geometry

On the Geometry page, you can make changes to the geometry of a 3D object. This page is opened with the Geometry button  in the upper part of the 3D Effects dialog.

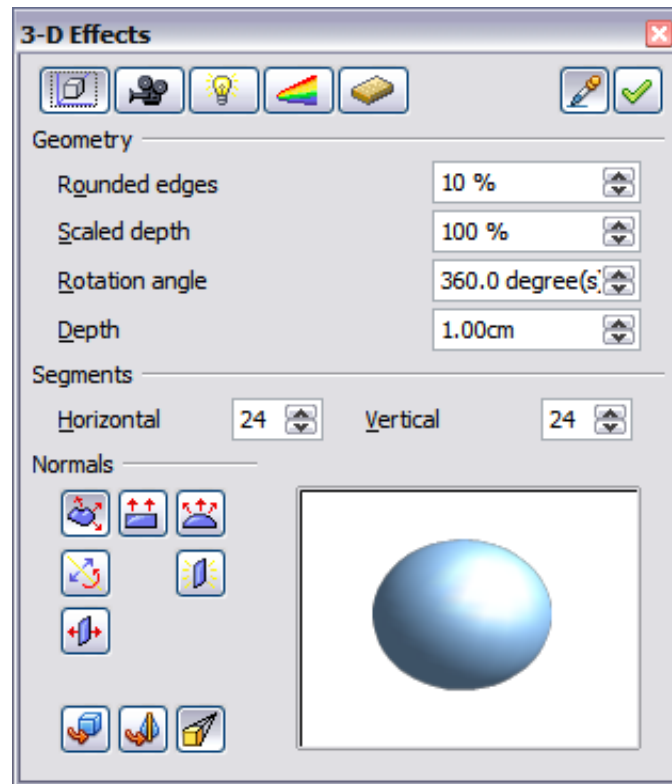



Figure 141: Geometry page

In the first example, the depth (length) of a body is to be changed. This is possible only if you created it through extrusion. To illustrate: draw a circle and convert it according to Variation 1 into a 3D object (a flat cylinder); see Figure 142 a and b.

If necessary, select the cylinder, open the 3D Effects dialog, make sure the Geometry page is active, change the parameter Depth to 3.5cm and click on the **Assign** icon . The cylinder should now resemble the figure in Figure 142c.

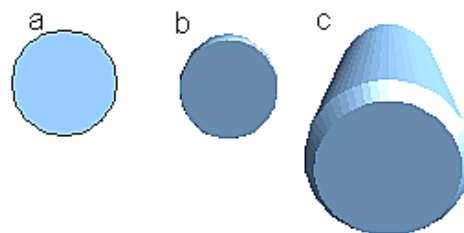

Figure 142: Conversion by extrusion of a 2D object (a) into a 3D object (b) and then changing its depth (c)

This parameter has no effect on a rotation body or on ready-made 3D objects, although the input field remains active.

With the *Rounding* parameter you can specify how strongly the edges of the 3D object are rounded. Select (if necessary) the lengthened cylinder again and use the

3D Effects dialog to change the rounding to 30%. The cylinder should now resemble that in Figure 143.

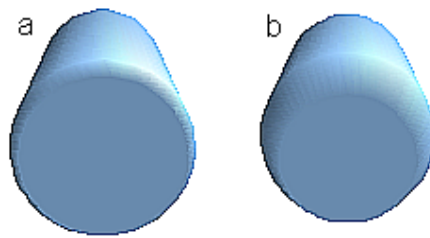

Figure 143: Edge rounding of 10% (a) and 30% (b)

This parameter also has interesting effects when you convert text into a 3D object.

The *Scaled Depth* parameter sets the size ratio of the front to the back for a 3D object produced by extrusion. The front side of such an object always protrudes out from the original surface; the rear side is the original surface of the 2D object (that is, the 2D exit surface) even if the object has been rotated in the meantime.

By default the scaling is set to 100%, which results in both surfaces being scaled by the same amount. If you set this scaling to 50% the cylinder becomes a truncated cone (see Figure 144).

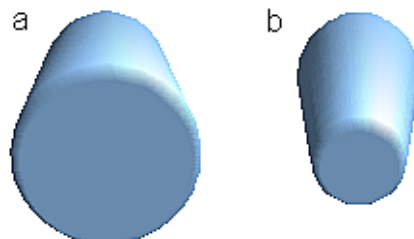

Figure 144: Cylinder with 50% scaling

The diameter of the front side is 50% that of the rear side. It is also possible to create the reverse effect, with the rear side smaller than the front, by using a scaling depth greater than 100%.

With rotation bodies this parameter influences the width of the surface parallel to the axis of rotation. At the end of the rotation the surface width of the figure is given by the scaling depth. The distance to the rotation axis remains unchanged. In Figure 145 a line is rotated to create a 3D object with a scaling depth figure of 0%.

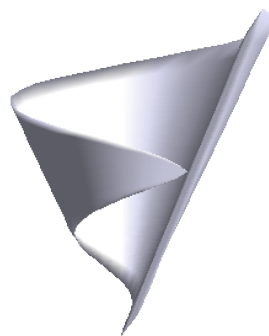

Figure 145: Scaling depth of a rotation body

The *Rotation Angle* parameter is only available for rotation bodies. With this parameter you can create a segment of a complete rotation body by choosing an angle less than 360 degrees. Figure 146 shows a hemisphere with a rotation angle of 270°.

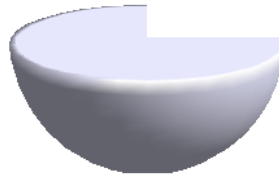

Figure 146: Hemisphere with a rotation angle of 270°

The *Horizontal* and *Vertical Segments* parameters define the number of segments out of which Draw builds spheres and rotation objects². For rotation objects, the horizontal segments are more important. The vertical segments influence the degree of edge rounding.

In Figure 147 the left sphere is made up of 10 horizontal and vertical segments while the right sphere has 25 segments. More segments give a smoother surface, but it will take longer to generate the figure on the screen. By default, spheres and hemispheres are constructed with 24 segments. For a square pyramid you need four horizontal segments.

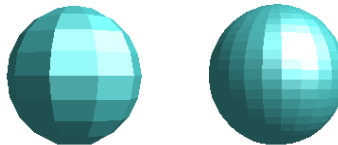



Figure 147: Sphere made from 10 segments (left) and 25 segments (right)

These are properties belonging to individual objects. If you use the setting for segments on a 3D scene, all the objects contained in the scene are modified accordingly.

If you extrude an unfilled circle or intersecting lines with a filling the result may not

be what you expect. In this case the Double-Sided  tool, on the lower part of the dialog page, may be able to help. It changes the line properties of an object from invisible to continuous and so enables all edges to be seen. Otherwise it may happen that some surfaces receive no filling (see Figure 148). For lines without filling the effect is switched on by default and cannot be switched off. This is also a property of single objects.

² To reduce both calculation time and data storage, circles are often constructed as regular polygons. If you cut a sphere or cylinder of 10 segments through the middle you end up with a 20-cornered cut section (10-cornered for a hemisphere).

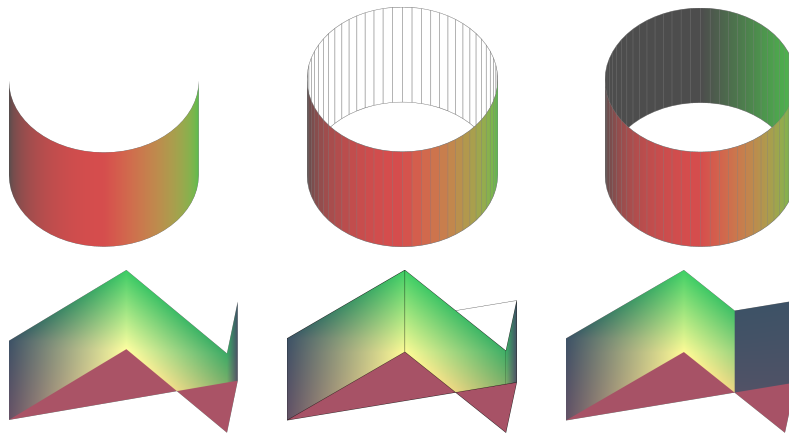

*Figure 148: Left: without “Double-Sided”
 Middle: with continuous lines but without “Double-Sided”
 Right: with “Double-Sided”*

Use the buttons in the section *Normals* to modify the normals of a 3D object.

A *Normal* is a straight line which is perpendicular to the surface of an object (in the same way that a vector, starting from an inner point and extending outwards, is at right angles to the surface of the object at the point where it exits). Figure 149 shows some normals extending outwards from a sphere made up of 10 segments.

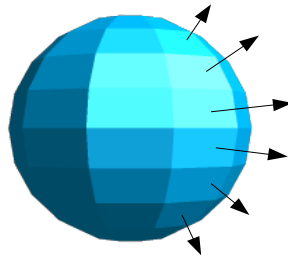

Figure 149: Normals (vectors) of a 3D sphere with 10 segments

Using normals, the display of the object surface and the variation in colors, textures and lighting can be controlled, influencing directly how the surface of the object is rendered.

The first three icons (in Figure 141) work as “either-or” switches. Only one of the effects can be active at a given time; an effect can be switched off by clicking on one of the other icons.

The settings belong to individual objects, not scenes; every object can have its own setting. The rest of the icons are normal toggle “on-off” switches. The following effects are available:



Object specific: The object is rendered to produce the best result independent of its shape. Single segments are changed but their “edges” will hardly be visible.



Flat: The surface of the 3D object will be divided into single polygons, whose edges are clearly recognizable. Every polygon is generated with a uniform color.



Spherical: The enclosing sphere is calculated for the object and then projected onto the object. This form of calculation produces an object with a smoother surface; the edges of individual segments are more smoothly rounded than with the Object-specific effect (see Figure 150). However surfaces that meet at a point do not show a realistic lighting effect.



Invert Normals: This results in a reversal of the lighting direction. The inside of the body then becomes the outside. This property is particular to each individual object.



Double sided illumination: The lighting is also computed for the inside of the object. In other cases the lighting value for the outside is simply transferred to the inner side. This property is of interest for open objects. It is a property of the 3D scene and affects all objects in the scene.

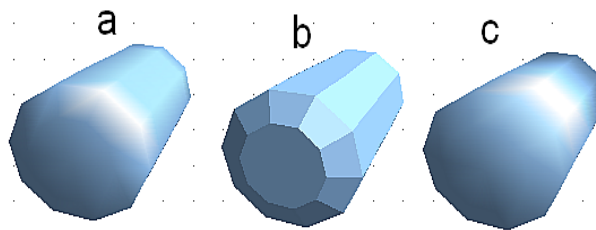

Figure 150: Cylinder with 10 segments
a= Object-specific b=Flat, c=Spherical

The following table shows the linkage between double-sided illumination and inverted normals.

The light source is on the right.	Normals not inverted	Normals inverted
No double sided illumination		
With double sided illumination		

3D Effects - Shading

The Shading page offers functions for shading the object surface, adding shadows and choosing camera settings.

Shading is a rendering method involving a consideration of lighting ratios, which is used to produce curved 3D surfaces. The surfaces are broken down into small triangular segments. Draw offers three methods to produce this effect: *Flat*, *Phong* and *Gouraud*. The setting selected applies to all objects in the 3D scene.

- *Flat* is the fastest and simplest method. For every individual segment a special color tone is determined, based on the lighting ratio and the direction of the segment area. This tone is used for the whole area of the segment. The segmentation is clearly visible.
- *Phong* is the most time-consuming method. With this method, for each pixel the associated normal is determined by interpolation, based on the normals of the segment edges. This causes the segment area to appear curved and the segment intersections are no longer visible.

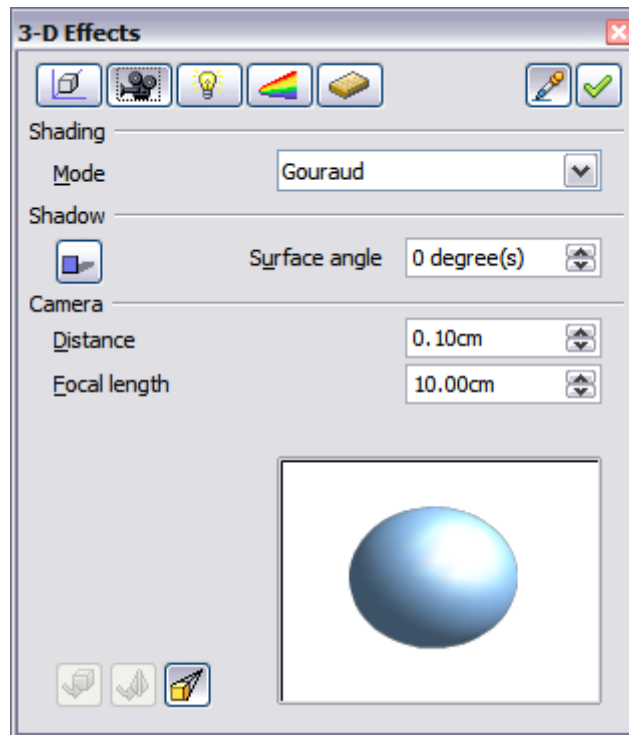

Figure 151: Shading page

- *Gouraud* is a relatively quick method. It determines the color value for the segment corners and calculates the color value for every pixel through linear interpolation. The segment edges are still recognizable, but significantly less so than with the flat method. The Gouraud method considers only light reflection on diffuse, reflecting surfaces (dispersal).



Figure 152: Flat, Phong and Gouraud shading

In Figure 152 the left sphere was rendered with flat shading, the middle with Phong and the right with Gouraud. The quality of the flat method is clearly inferior to the other two. The difference between Phong and Gouraud is small. With the Gouraud method the segments can be very faintly seen and rendered objects have a slightly less “shine” than with the Phong method.

All three methods function at the pixel level, and therefore shadowing and mirroring inside the 3D scene (as permitted by ray tracing methods) are not possible..

With the the Shadow button  you can provide a 3D object with a shadow. By changing the *Surface angle* you can influence the form of the shadow (see Figure 153). The left sphere has a surface angle of 0° (the paper represents a perpendicular surface behind the object) while the right sphere has a surface angle of 45° . With 90° the paper would be directly under the object.

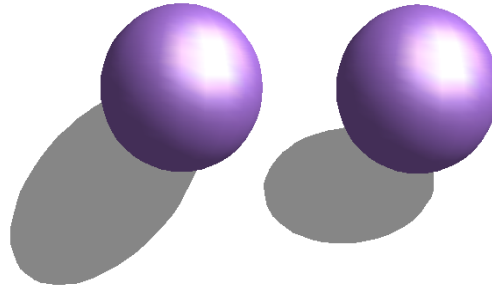

Figure 153: Shadows using different surface angles

The shape and size of the the shadow are also influenced by the lighting properties. These can be adjusted on the *Illumination* page of the dialog. Multiple light sources for shadows are not yet supported. The shadow properties can be set for individual objects in a drawing but where objects form part of a 3D scene, the shadow produced is that of the entire scene.

It is possible to set the shadow property for single objects using the *Area* property. The shadow is then shown with the color selected in the shadow dialog, but again the representation of the lighting of the scene determines the end result of the entire scene. In this way, colored shadows, with different distances to the object, and different color and transparency effects can be created.

In the *Camera* field of the shading dialog the settings of the virtual camera can be changed. These settings relate only to the view in central projection and apply to the entire 3D scene. The *Distance* parameter is used to adjust the spacing between the camera and scene. The default value for an extruded body is equal to the depth or length of the body. With equal length edges front and rear, the effect at large distances is quite small. The standard value of *Focal length* is 10cm. It has the same significance as with a real camera. Larger focal lengths simulate a telephoto lens, smaller ones a wide-angle lens. The effect that changes in the camera settings have on an object are shown in Figure 154.

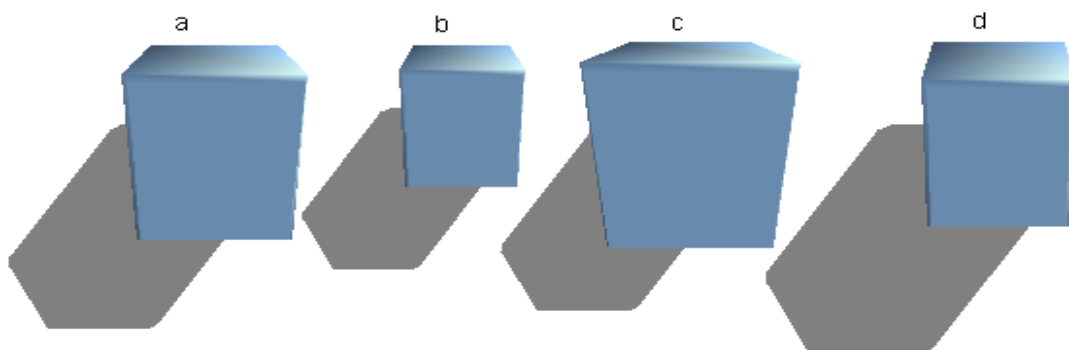

Figure 154: Effect of camera settings

Picture *a* shows a 3D object with the standard settings. The individual changes are listed in the following table.

	a	b	c	d
Distance:	0.81 cm	3.81 cm	0.81 cm	0.81 cm
Focal length:	10 cm	10 cm	5 cm	15 cm

3D Effects - Illumination

On the Illumination page (see Figure 155) you define how a 3D object is lit. The settings apply to all objects in a scene.

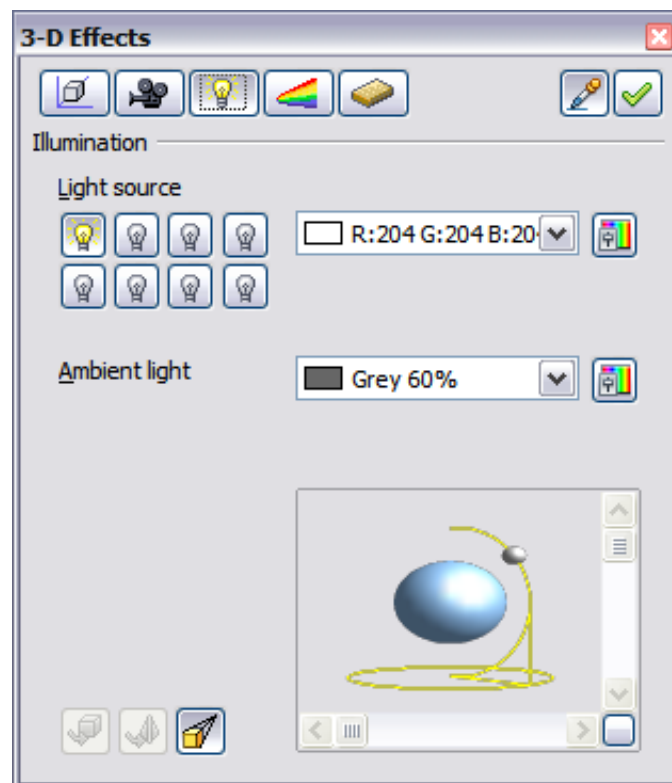



Figure 155: Illumination (lighting) page

You can light a scene with a maximum of eight individual *Light sources* at the same time. For each of these sources, the light color and position relative to the scene can be set. The light sources are represented by eight small light bulbs. When you select this page, the first bulb “lights up” . At least one light source must be active; otherwise the rendering and shading functions cannot function correctly.

Each symbol functions like a multi-function press switch. With the first mouse click the bulb is selected and with the second click the settings mode for this light source is activated (see Figure 156). A third click deactivates the light source.

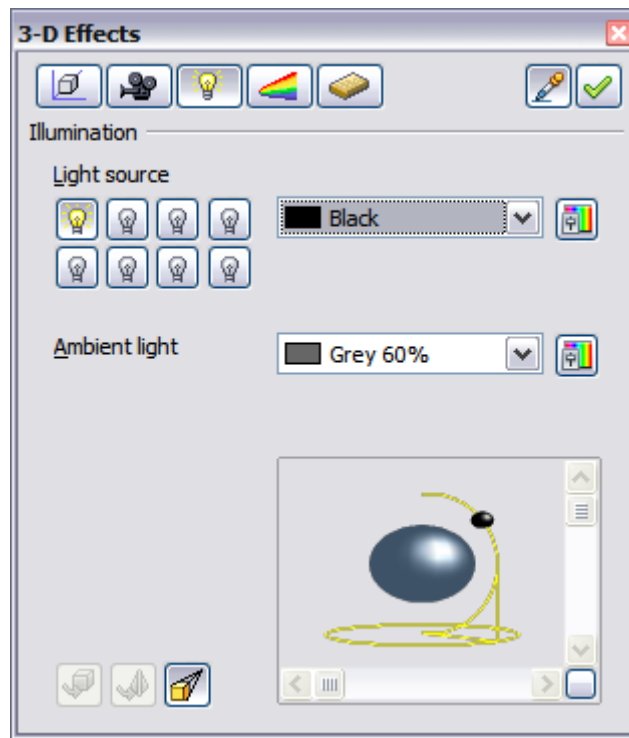



Figure 156: Adjustment of light source

In the selection list next to the symbols you can choose the color of the active light source. If desired, click the  button to open a color palette dialog, where you can define your own color and also adjust the brightness. For the first light source, it is best to retain the neutral color value (default is white); with several light sources it is advisable to reduce the brightness.

In the lower right corner of the menu the light source location and orientation is depicted. With the vertical slider bar you can adjust the lighting angle; with the horizontal bar the light is rotated about the object. Alternatively you can click on the light point and drag the point as you please (see Figure 157). Click on the small square in the bottom right (circled) to change the preview image from a sphere to a cube.

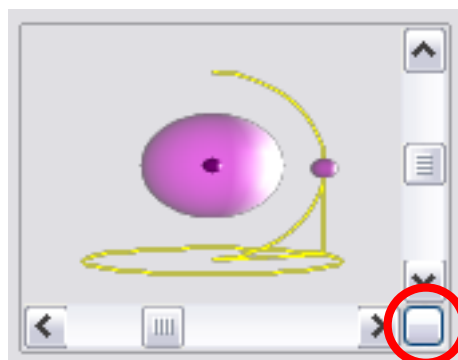



Figure 157: Moving the light source

To apply the changed settings to the selected object, click on the the **Assign** button .

The use of additional light sources can result in some interesting effects.

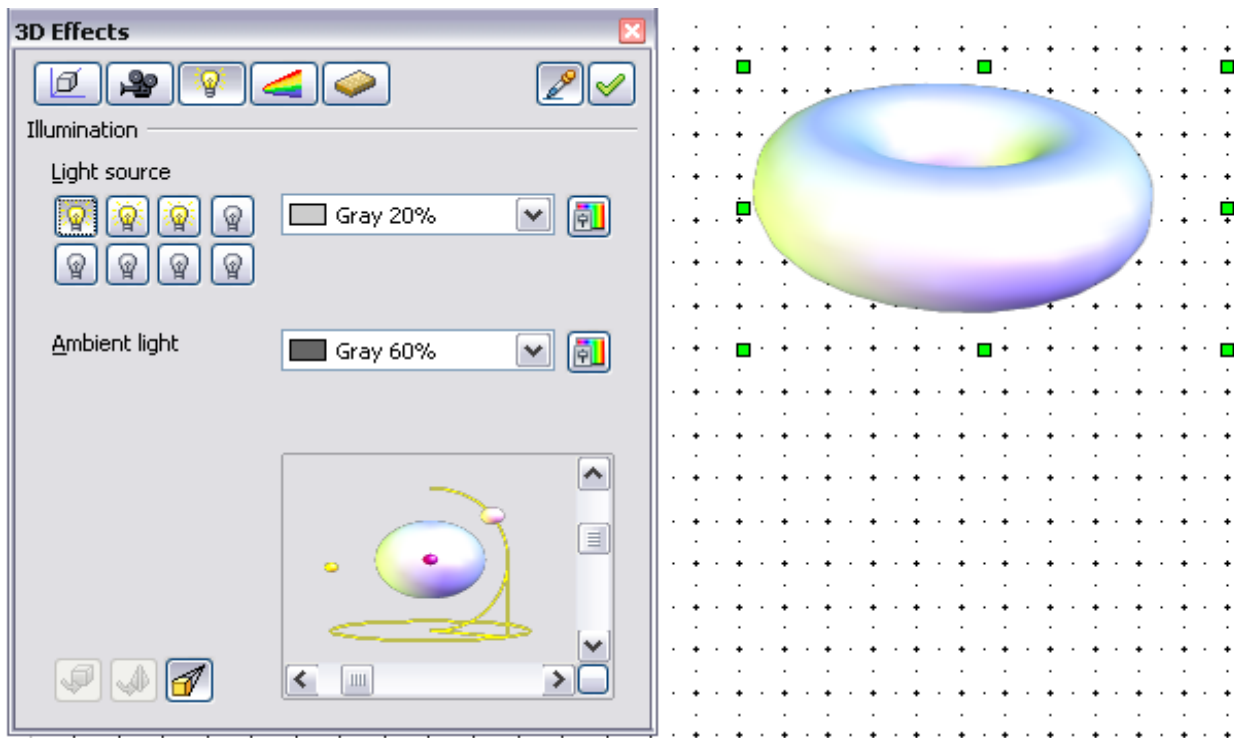



Figure 158: Lighting with three independent light sources

In Figure 158 the ring has the lighting settings from Figure 155 with the standard color white. In addition it was lit with magenta, and also from the left underside with yellow. The number and position of the light sources is shown in the window at the lower right. The three light sources in use can be recognized by the “lit” symbols . To see the effect of a particular lighting effect you can also temporarily turn it off.

With an object selected, clicking on a “lit” symbol turns it off . This new setting must then be applied (assigned) to the scene. With a further mouse click on the light source, the effect can be switched back on and then re-assigned.

You can also change the settings for the *Ambient lighting*. The selection of properties (lighting color, brightness, and so on) is carried out in same way as for light sources.

3D Effects - Textures

Textures are raster graphics (bitmaps) which can be used as an object property for the surface of an object. Every object in a 3D scene can have its own texture.

You can set a raster graphic as a texture for a 3D object in the same way as for a 2D object (**Format > Area > Bitmaps** or right-click on the object > Area > Bitmaps) – as is the case for Gradient and Hatching. More details are found in Chapter 4 (Changing Object Attributes).

If the Fill setting on the Area dialog is *Color*, then the Texture page is inactive. Change it to *Bitmap* to activate the Texture page for 3D objects. If the texture is not tiled or stretched and is smaller than the object, then the remainder of the area will have the color of the Object color property on the Material page.

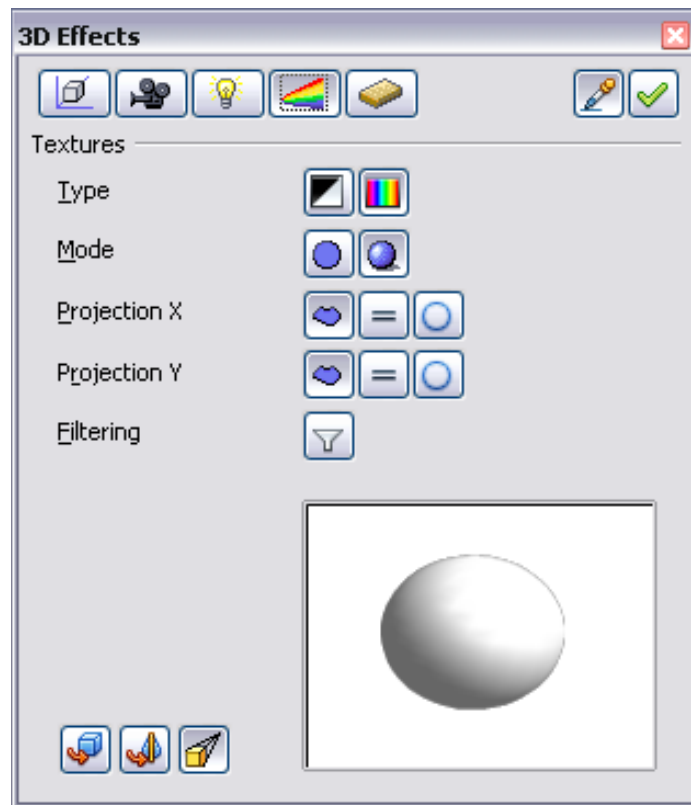

Figure 159: Textures page

In the first row of the page (Figure 159) are two *Type* switches allowing you to choose between black and white or color for the texture (see Figure 160).

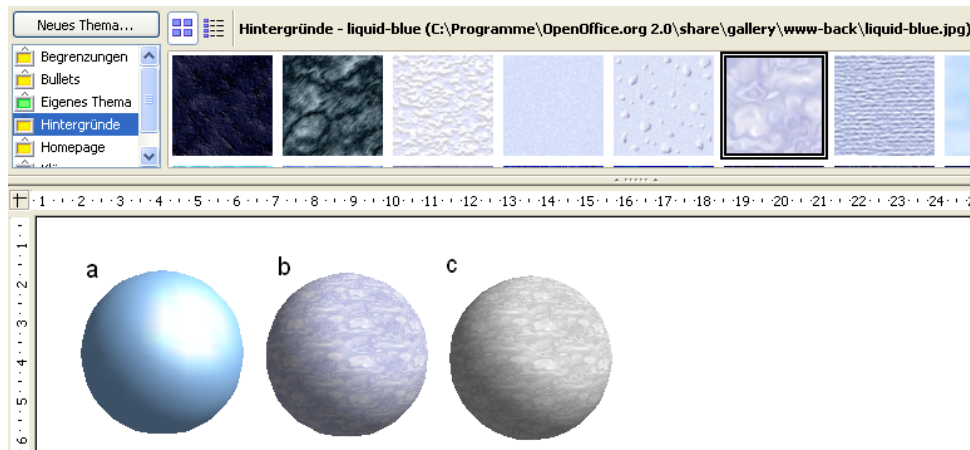

Figure 160: a - standard color setting, b - texture (color), c - texture (black and white)

With the two switches in the row *Mode* you can control whether the texture of the selected objects is rendered with light and shadows (Switch 2) or not (Switch 1); see Figure 161. Appropriate lighting and shading adjustments allow the graphic object to be more realistically rendered.

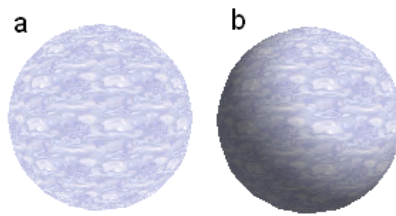





Figure 161: Texture without (a) and with (b) lighting and shadow effects

Projection X / Y

With one of these three buttons you can determine how the texture for this coordinate axis should be projected onto the object. The default setting, *Object specific*, usually gives the best result. Examples of the use of each button are shown below.

	Object specific	The texture is automatically adjusted for a best fit with the form and size of the object.
	Parallel	The texture is projected parallel to the axis of the object. It is mirrored on the rear side of the object.
	Circular	The axis of the texture pattern is wrapped around the object.

For a rotation body, the turning axis is the Z axis and the wrapping is the X direction; for an extrusion body, the extrusion direction is the Z axis and the extruded surface is the X direction. Depending on how the object was produced, different positions of the texture result.













 Area fill without tiling, with adjustments	Projection X 	Projection X 	Projection X 
Projection Y 			
Projection Y  (Difference is small)		 Front and rear side	

Figure 162: Cylinder as a rotation body



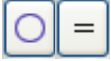

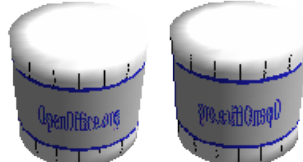







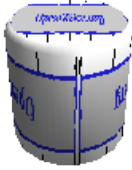

 Area fill without tiling, with adjustments	Projection X 	Projection X 	Projection X 
Projection Y 			
Projection Y   (Difference is small)		  Upper and under sides	

Figure 163: Cylinder as an extrusion object

The *Filter* button  switches on and off a soft-focus filter. It can often remove slight faults and errors in the texture.

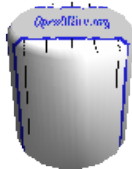
3D Effects - Material

On this page you can assign the appearance of different materials to the 3D object.

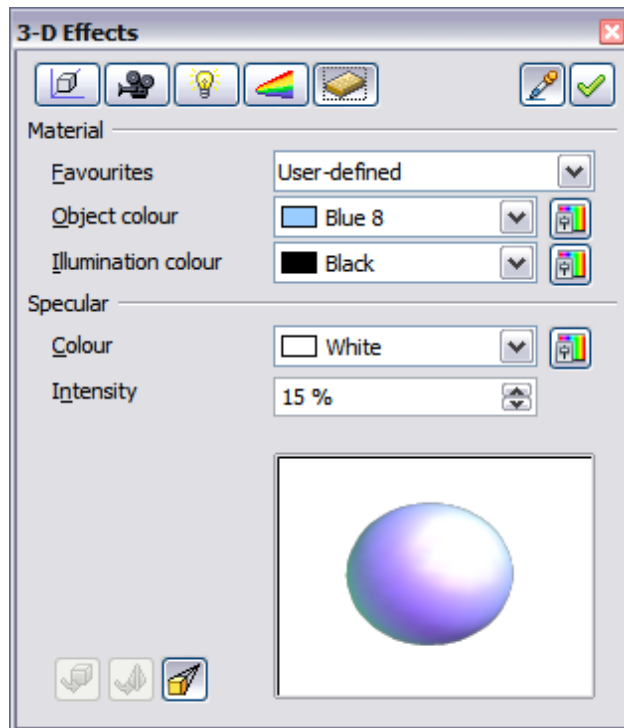

Figure 164: Material menu

In the selection list under Favorites are the most commonly used materials (see Figure 165).

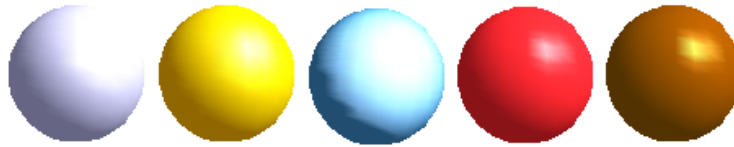

Figure 165: The favorites (from left to right): Metal, Gold, Chrome, Plastic and Wood

With the individual *color parameters*, additional effects can be produced. The meaning of these parameters corresponds to those on the Illumination dialog page. Materials and textures can be combined with one another. Settings only simulate materials and it is sometimes a matter of trial and error to achieve the desired result.

Tip

Do not use too high a brightness value for individual colors. These are all additive and it is easy to end up with a totally white “colored” area.

The *Illumination color* brightens those parts of the object which lie in shadow making the body seem more illuminated.

When textures are used as well, the Illumination color is combined with the white color part of the texture. On the left the object has a black Illumination color, on the right bright green.

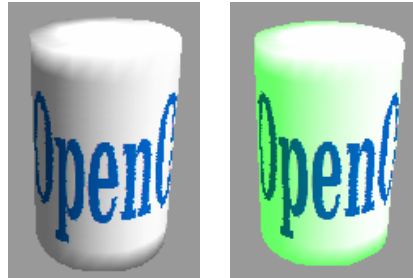

The *Specular color* simulates the reflecting capacity of the surface. The position of the illuminated point is determined by the setting of the first light source.

Left: Set the Specular color the same as the object color and the illumination point intensity to a low value, in order to give the impression of a matt body.

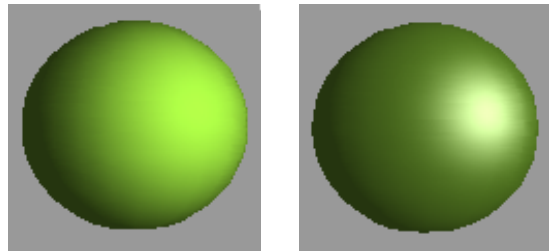

Right: Set the Illumination point color the same as the light source color, in order to give a shiny appearance to the object surface.

Metallic surfaces and glass are not so well simulated, because the impression of these materials is produced through reflection. Such simulation cannot (at the moment) be calculated by OpenOffice.org.

3D settings for 3D shapes

3D shapes are handled quite differently from objects in 3D scenes. The appearance of a shape object is changed using the *3D-Settings* toolbar (see Figure 166). The *3D Effects* dialog described above should not be used for shape objects as it will not give the correct formatting results.



Figure 166: 3D-Settings toolbar, indicating icons for formatting 3D shapes

If you have used it in error, you can remove the incorrect formatting with **Format > Default Formatting**.

With the buttons on this toolbar you can adjust the extrusion depth and perspective, lighting and material properties as well as the extrusion color. There are tear-off bars, which you open by clicking on the small black triangle. The purpose of each individual button is described by its tool tip. You do not need to assign the result of any of the functions to the object as you do with the 3D Effects dialog used with 3D scenes; every action is immediately applied and you can see its effect on the object in the main Draw window.

Note

The program may sometimes seem to generate the wrong formatting with shape objects. The exact cause is not known, but you can undo the action with **Format > Default Formatting**. One reason for bad formatting can be that you have used a function from the 3D Effect dialog on a 3D shape.

Here are some examples of formatting of 3D shapes:

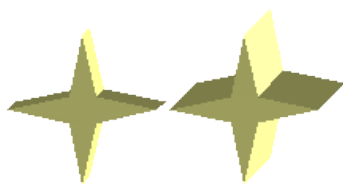

Depth 

left: 0.3cm (user defined)
right: 1cm (selection)

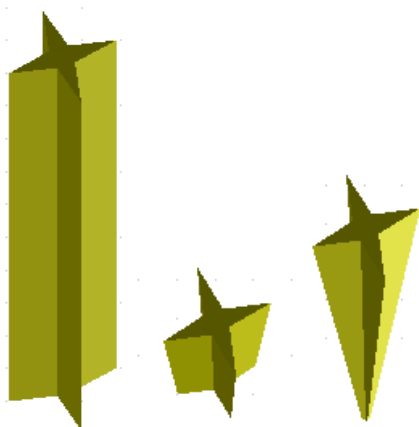

Direction 

The examples show “columns” at right angles to the drawing surface.

left: 5 cm depth, Parallel projection
Middle: 10 cm depth, Perspective
right: Infinity, Perspective



Illumination



The light color cannot be changed, the brightness can be changed only in three levels, and some effects may not be rendered with total correctness.

left: from left under, dim

middle: from left under, bright

right: from right under, normal



Surface



Only four built-in variations are possible. At present only *Wireframe* and *Matt* are correctly rendered.

left: *Wireframe*

right: *Matt*

You can also choose a gradient, hatching, or bitmap for the surface; these are only applied to the extruded surface—the sides remain in the color of the object.

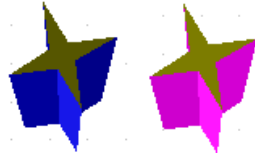

3D Color



Here you can choose the color of the sides of the extruded surface.

The symbol shows the color of the most recently chosen shape object.

Combining objects in 3D scenes

3D objects produced by extrusion or rotation are shown in the status bar as a *3D scene*. You can group together several of these objects. Other object types cannot be so grouped. Management of the group is carried out in the same way as described in other parts of this guide (**Modify > Enter Group**, or **Modify > Exit Group**), see also “Grouping Objects” in Chapter 5 (Combining Multiple Objects).

As an example, we will produce a game piece.

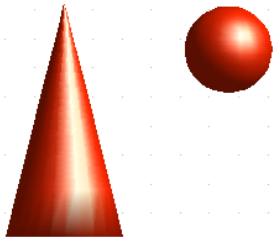

First produce both objects independently of each other. The subsequent combination is made easier if you use parallel projection and rotate the objects into an upright, straight position.

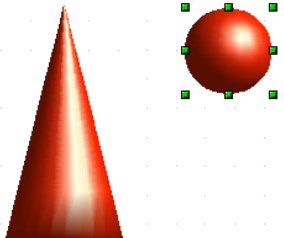

Click on the sphere and use **Edit > Copy** to take over the scene and put the sphere on the clipboard. If you are sure that you do not need the original anymore you can use **Edit > Cut**. In any case move the sphere a little to the side.

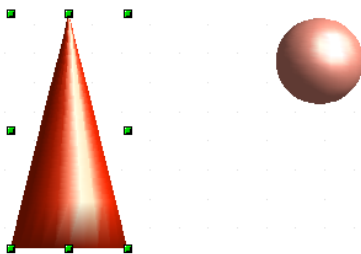

Click now on the cone. The status bar will show *3D Scene selected*. Right-click and enter the group. You will see that, as usual, elements that do not belong to the group are less bright.

Use **Edit > Paste**. Now the objects (not the whole scene) from the clipboard are pasted into this scene.

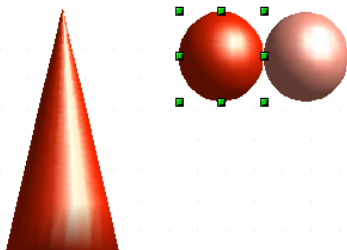

The original position of the sphere now contains a new sphere that belongs to the scene. This new sphere can be dragged over to the cone. Exit the group after moving the sphere.



Notice that combining 3D objects results in them being more or less “fused” together - there is no stacking or layering as with 2D objects.

Adjust the position of the objects as you wish. You cannot arrange objects in front or behind others, as with 2D objects, but can only move them parallel to the drawing plane.

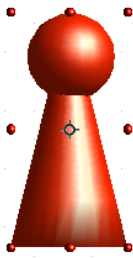

Enter the group again and adjust the objects. The status bar indicates which object is marked. Use the *Tab* key to change from one object to the next in the group, if it is not possible to do so with the mouse. Exit the group.

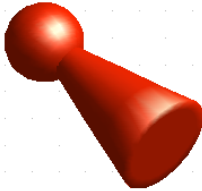

Now you can rotate the entire 3D scene and view your game piece from all sides.

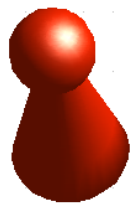

Examples for your own experiments

All examples use objects in 3D scenes.



Extruding a 2D object with text generates letters as separate objects and they have a larger extrusion depth than the background.

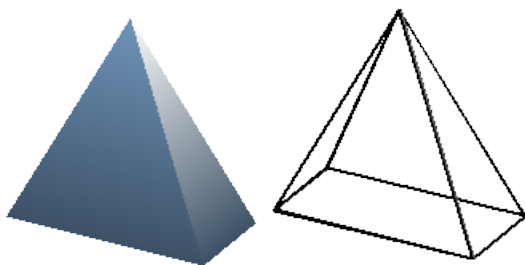

3D objects of the *Shape* type can be rendered as wireframe models. This effect can be produced in other 3D objects by setting the Area fill to *None* and the line style to *Continuous*.

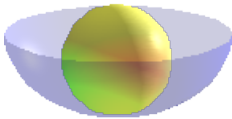
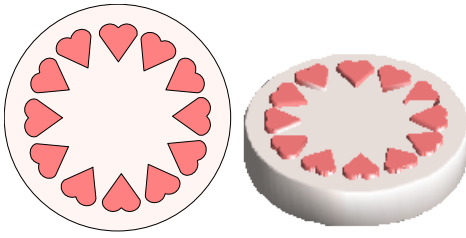

If you select several 2D objects—without grouping them—and extrude the selection, they are transformed, according to their stacking order, with different extrusion depths. The object previously on top will be uppermost on the extruded object.

For 2D objects use **Modify > Shapes > Merge/Subtract/Intersect** to produce complex objects. The resulting figures can be also extruded, rotated and so on.

Rotation of lines produces concave bodies. Use a bright line color. With a high number of vertical segments, the transition to the ground is relatively sharp-edged. Remember to switch on two-sided illumination.

The transparency of the platter is adjusted in the surface properties of the body. The best effect is obtained only when the transparent body is combined with other objects.

The color shadow of the fruit is produced by the use of multiple light sources – they are not “real” and do not rotate and change as the scene is rotated.



Chapter 8

Tips and Tricks

Free eBook Edition

Positioning objects with zoom

With zoom you can place objects with greater precision.

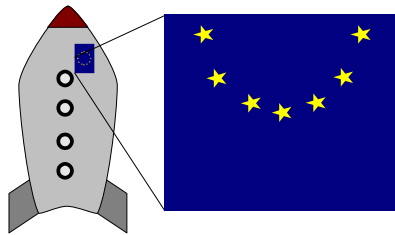

Figure 167: Using zoom to place objects with greater precision

Zoom adjustments using the status bar

The current zoom value is shown at the right-hand end of the status bar next to the zoom slider.



Figure 168: Zoom level on Status Bar

You can adjust the zoom value by using the slider, right-click on the zoom percent to select from a menu of preset values, or double-click to open the Zoom & View Layout dialog.

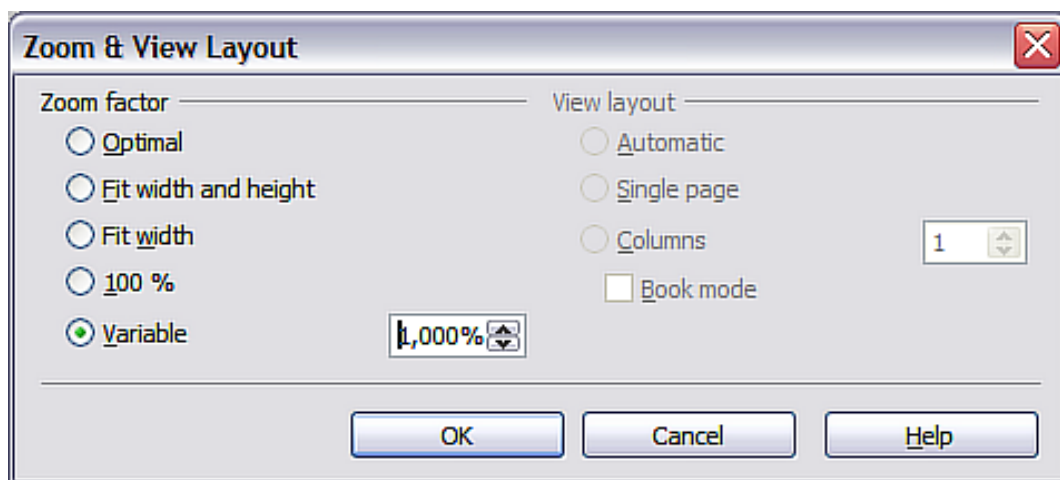

Figure 169: Zoom & View Layout

You can enter a zoom factor in the *Variable* field, select 100%, or use one of the three other choices. (The three options on the right hand side of the dialog are not available in Draw; they are active only for text documents.)

- *Optimal*: The drawing or selected object (not the page) is enlarged so that it just fits in the Draw page area.
- *Fit width and height*: The drawing page edges are set to show the entire page within the Draw page area. This is the same effect as choosing “Entire Page” from the right-click menu on the status bar.
- *Fit width*: The right and left page edges are set to the vertical edges of the Draw page area.

The exact effect of choosing one of these options depends on whether you have the Page pane switched on or off.

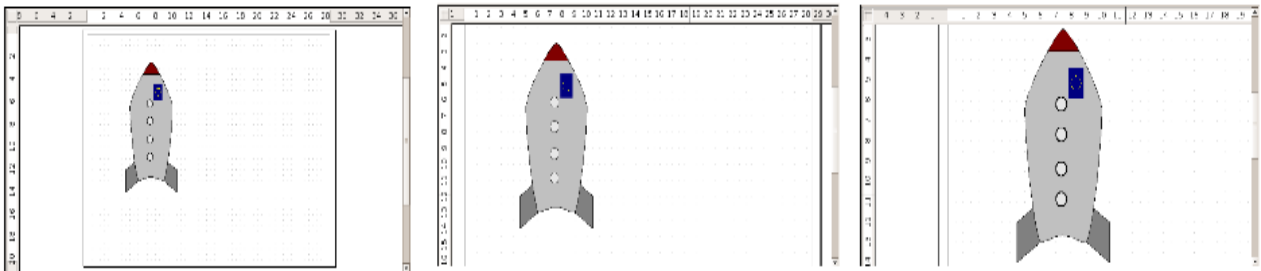



Figure 170: Zoom values – Fit width and height, Fit width, and Optimal

The Zoom toolbar

The Zoom toolbar provides additional zoom options. On the Standard toolbar (**View > Toolbars > Standard**), click on the downwards arrow of the **Zoom** button . You can also permanently display the toolbar by clicking on **View > Toolbars > Zoom**.

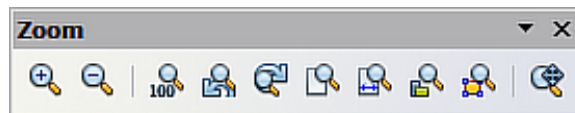











Figure 171: Zoom Toolbar

	Zoom in. Enlarges the monitor picture. First click on the button, then on the object. Alternatively, drag to create a zoom “window”.
	Zoom out. Makes the monitor picture smaller. Just click on the button.
	Reverts objects to their original size.
	Changes display to the previous and next zoom factors. If these buttons are not visible, turn them on by clicking on the small black arrow on the title bar of the Zoom toolbar, then on Visible Buttons and finally on either of these two buttons.
	Shows the entire page.
	Zooms to page width.
	Resizes the display to include all objects on the slide.
	Zooms the selected object to Optimal.
	Allows the whole drawing to be moved inside the Draw window, using the mouse.

Positioning objects with snap functions

In Draw, objects can be accurately and consistently positioned using grid points, special snap points and lines, object frames, individual points on objects, or page edges. This function is known as *Snap*.

To use the snap function easily, work with the highest practical zoom value. You can use two different snap functions at the same time, for example snapping to a guide

line and to the page edge. It is best, however, to activate only those functions that you really need.

Examples for setting up the snap functions are found in Chapter 10 (Advanced Draw Techniques).

Snap to grid

Use this function to move an object exactly to a grid point. This function can be switched on and off with **View > Grid > Snap to Grid** and on the Options toolbar with the icon .

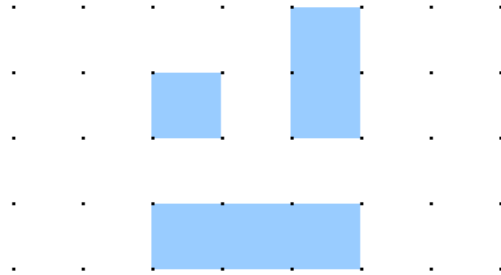

Figure 172: Exact positioning with the snap to grid function

Showing the grid

To make the grid visible, choose **View > Grid > Display Grid**. Alternatively, turn the grid on (or off) with the icon  on the Options toolbar.

Changing the color of the grid points

By default the grid points are bright gray and not always easy to see. Go to **Tools > Options > OpenOffice.org > Appearance**. In the *Drawing / Presentation* section, you can change the color of the grid points. On the *Color Settings* pull-down menu select a more suitable/visible color, for example black.

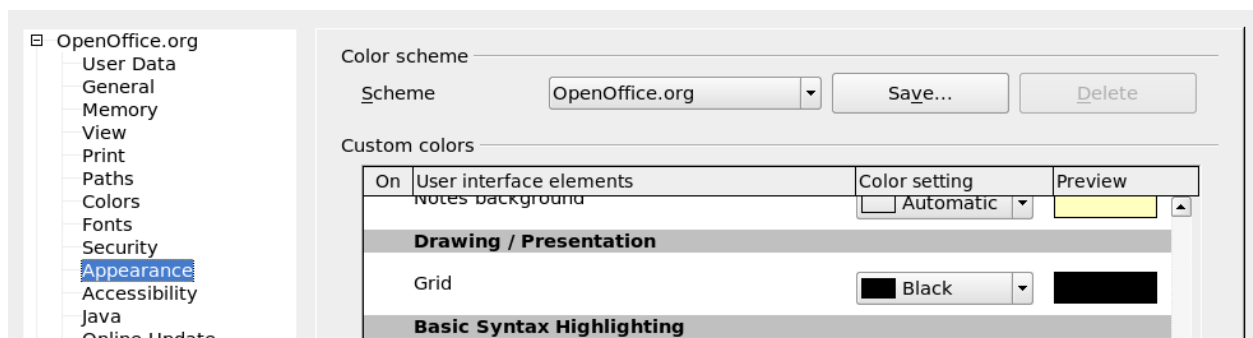

Figure 173: Changing the color of the grid points

Configuring the grid

Under **Tools > Options > OpenOffice.org Draw > Grid** you can change the settings of the grid (Figure 174).

There is no need to use the *Grid* section, as these settings can be changed directly from the icons on the Options toolbar.

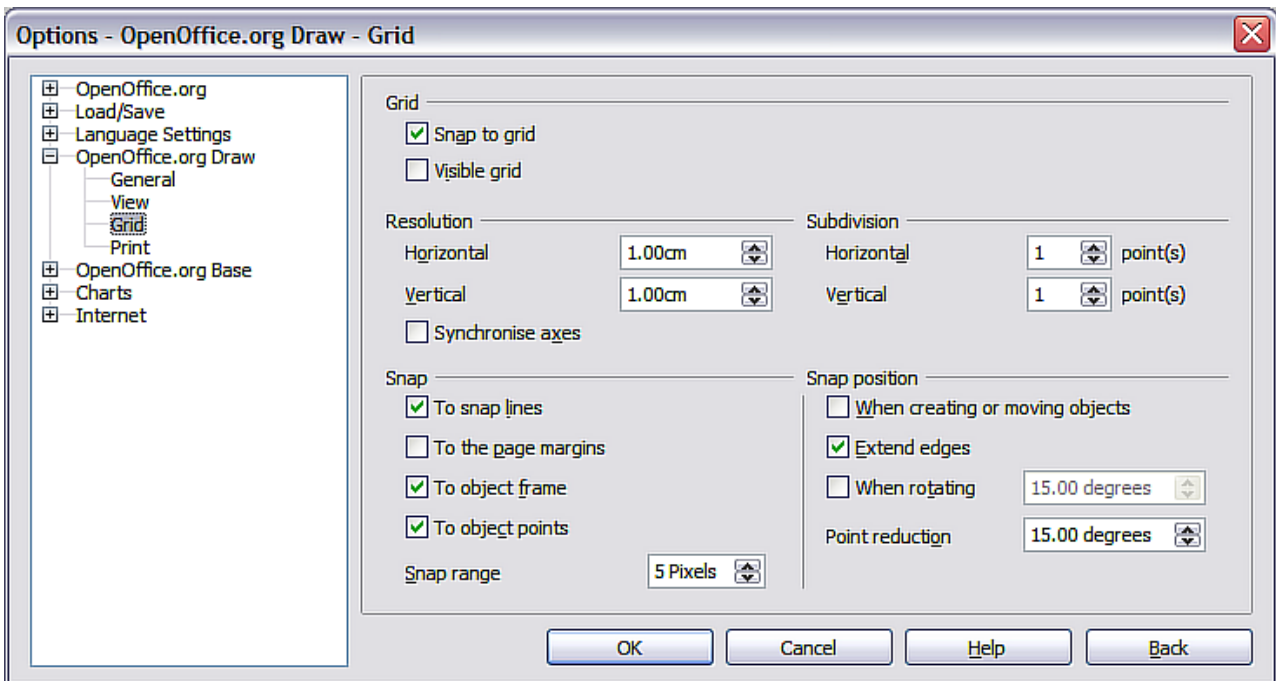

Figure 174: Configuring the grid

Resolution: sets the horizontal and vertical distance between two grid points.

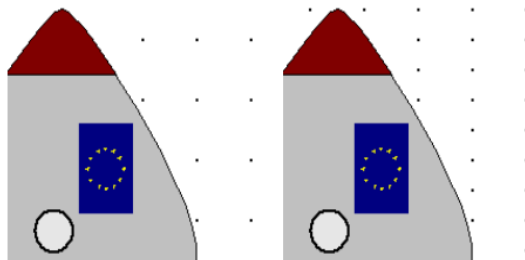

Figure 175: Grids with different resolutions

Subdivisions: determines how many steps there are between adjacent grid points. Intermediate steps make it possible to have a larger separation between two grid points, so the drawing remains clearer. Objects can snap to intermediate points in exactly the same way as to grid points.

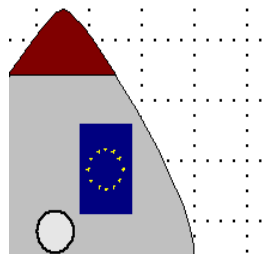

Figure 176: Grid with intermediate steps (subdivisions)

The snap field settings are largely self-explanatory. One important setting is the *Snap range*. Grid points and snap lines are both visual help elements that are managed separately by Draw. If you have activated a snap function and then move an object,

Draw looks in the vicinity of the object for these special help elements to determine the final position of the object; with the snap range setting, you can determine the extent of this search area. Exactly how large the snap area is depends on the current environment: which particular snap functions are in use, how the grid is configured, and whether or not there may be collisions with other objects. It is usually necessary to do a little experimenting to find what best suits your needs.



Snap to Snap objects (snap lines and snap points)

Unlike grid points, *Snap lines* and *Snap points* are created by the user. Snap lines run horizontally or vertically and appear as dashed lines. Snap points appear as small crosses, again with dashed lines.

Note

In Draw the names of the buttons in the Options toolbar are *Display Guides* and *Snap to Guides* when what is actually meant is *Display Snap line* and *Snap to Snap line*.

If you have activated this function, you can position objects exactly. Horizontal and vertical snap lines can be used together. Snap lines are not active immediately after

inserting them but are turned on (or off) using the **Display Guides**  icon or with the **View** menu. If the snap line is no longer needed you can hide it (or subsequently display it again) with the  icon or by using the **View** menu.

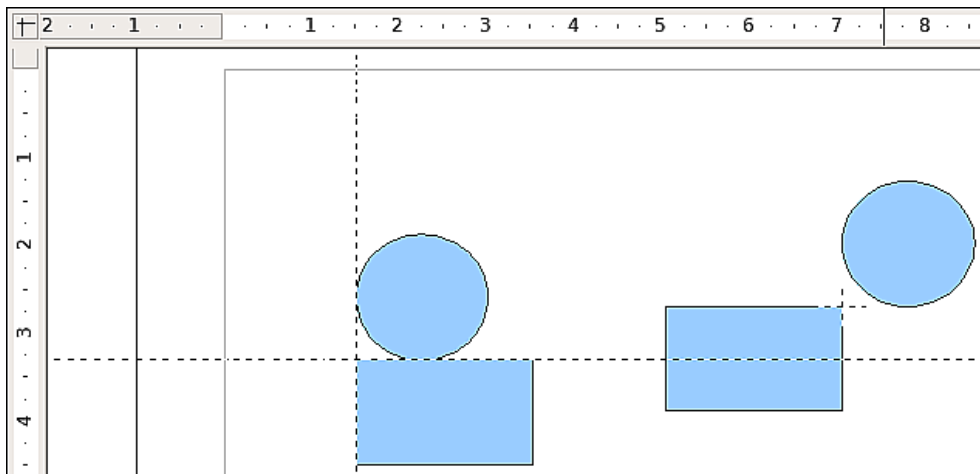

Figure 177: Objects 'connected' to snap lines (left) or to a snap point (right). Note that the snap point functions as if it were the intersection of two snap lines.

Inserting a snap line with the mouse

To insert a snap line in a drawing:

- 1) Hover the mouse cursor over the vertical ruler to create a vertical snap line or over the horizontal ruler to create a horizontal snap line. Click and hold the left mouse button.
- 2) Drag the mouse into the drawing area to produce a snap line.

The snap line can be moved at any time by dragging it with the mouse. Moving a snap line will not, however, move any objects that have already been snapped to that line.

Inserting snap points and snap lines using coordinates

The command **Insert > Snap point / line** opens a dialog where you can specify X and Y coordinates and choose the type of snap object: point, vertical line, or horizontal line. You can also access this menu by right-clicking in the draw area and selecting **Insert Snap Point/Line**.

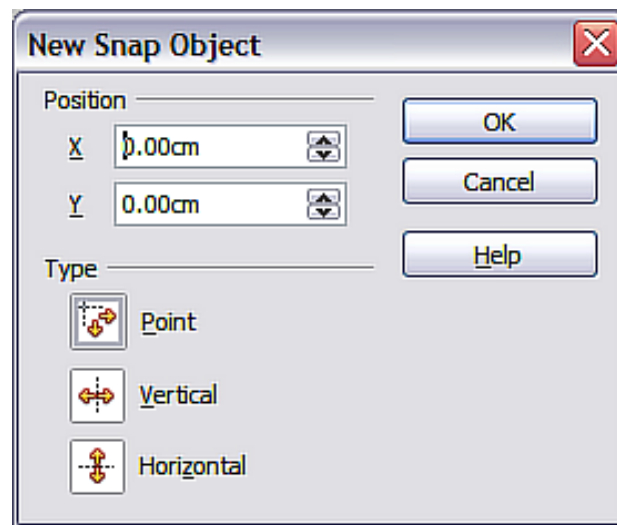

Figure 178: Setting a) snap object type and b) snap object position using X,Y coordinates

Editing snap points and snap lines

All snap objects can be edited after setting them. If you right-click on a snap object, an appropriate menu opens, allowing you to edit or delete the snap object. Snap points and lines can also be deleted by dragging them entirely off of the page.

Snap to page edge

With this function you can snap objects to the page edge. It is also possible to combine this with snap lines and snapping to grid.

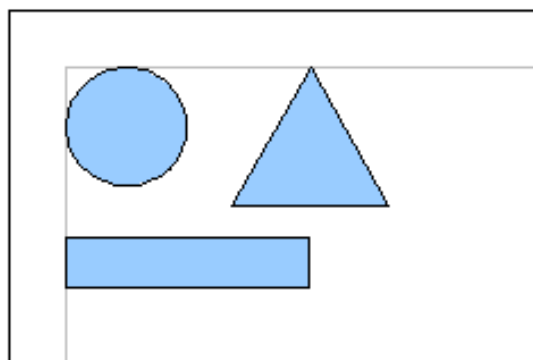

Figure 179: Objects positioned on the page margins

Snap to object border

With this function you can position one drawing object on the border of another. The connection point can lie anywhere on the object border. To use this function, first deactivate *Snap to grid*. Figure 180 shows some examples. Note that a typical object border will touch the border of a round object at only one of its four points.

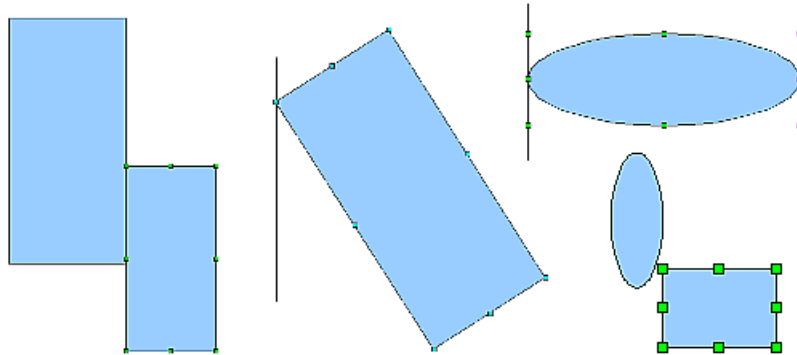

Figure 180: Objects positioned on the border of another object

Snap to object points

This function operates in a similar manner to the one just described. The difference is that the connection point can lie only at one of the four corner points of both the object being moved and the target object. This leads to the situation where two round objects have a connection point that does not lie on either object but at one of the red circled points.

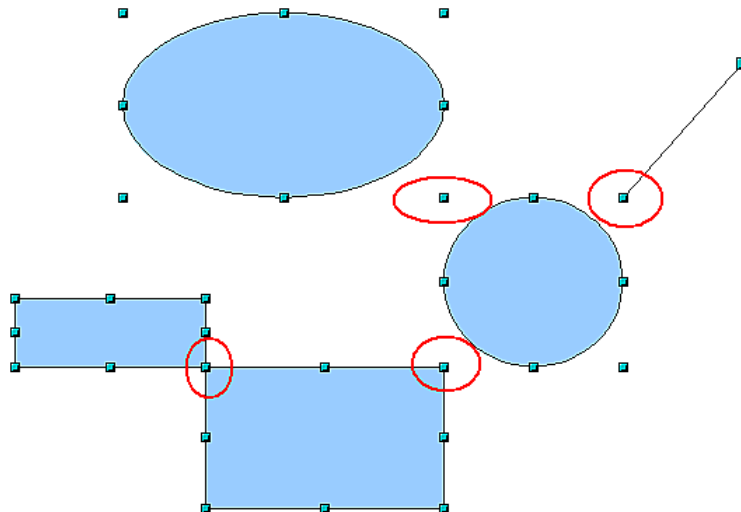



Figure 181: Objects connected to the object point of another object

Help to position objects with guiding lines

To simplify the positioning of objects it is possible to make visible guide lines—extensions of the edges of the object—while it is being moved. These guide lines have no snap function.

The guide lines can be (de-)activated under **Tools > Options > OpenOffice.org Draw > View > Guides when moving**, or by clicking the  icon on the *Options* toolbar.

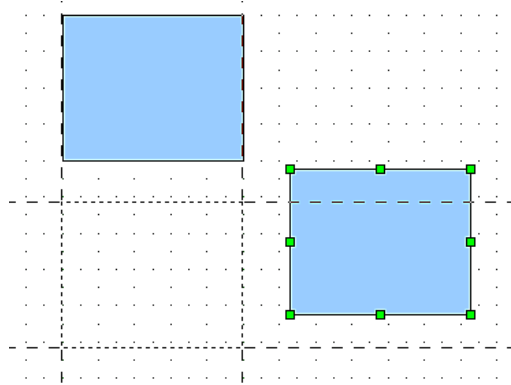

Figure 182: Working with guiding lines

Drawing to scale

In Draw a drawing is made on a predefined drawing area or canvas. This will usually be in the Letter or A4 format depending on your locale settings, and will be output to some “standard” printer that you have set up on your computer (usually referred to as the *default printer*). Depending on the actual size of the drawn objects, it is often necessary or convenient to reduce or enlarge the drawing by some scaling value. You can specify the scale that you wish to use under **Tools > Options > OpenOffice.org Draw > General**.

The scale and selected unit of measurement are automatically reflected in the rulers, the window position and the window size. Scale settings can be stored permanently in a template that you can then use for new drawings.

The scale you use has no effect on the basic drawing operations. Draw will automatically calculate the necessary values (for example, dimension lines). The grid spacing is independent of drawing scale as the grid is not a drawing element but only an optical drawing aid.

Note

If you want to insert elements into a drawing from the Gallery or Clipboard, you should draw these to the same scale as you are using for the drawing to ensure the proper size ratio is maintained.

Splitting drawings on multiple layers

Layers are like transparencies that lie one on top of another on an overhead projector. You can insert and extract single layers as desired. For example in architecture the floor plan, heating, and electrical wiring can all be on separate layers. With complex drawings this layer technique offers many advantages. You can make layers visible or invisible as needed, or you can protect a layer from further changes while you work.

In Draw three layers are always present by default: Layout, Controls, and Dimension Lines. Layout is the default layer when you create a new drawing.



To change to a layer, click on its tab. Everything that is drawn will be placed on the currently selected layer. The Controls layer is for control elements such as icons and pull-down menus and is not usually used for ordinary drawing elements. The Dimension Lines layer is used whenever you insert a dimension line on a drawing (unless the layer is made invisible). Use **Insert > Layer** to insert a new layer into a drawing (Figure 183).

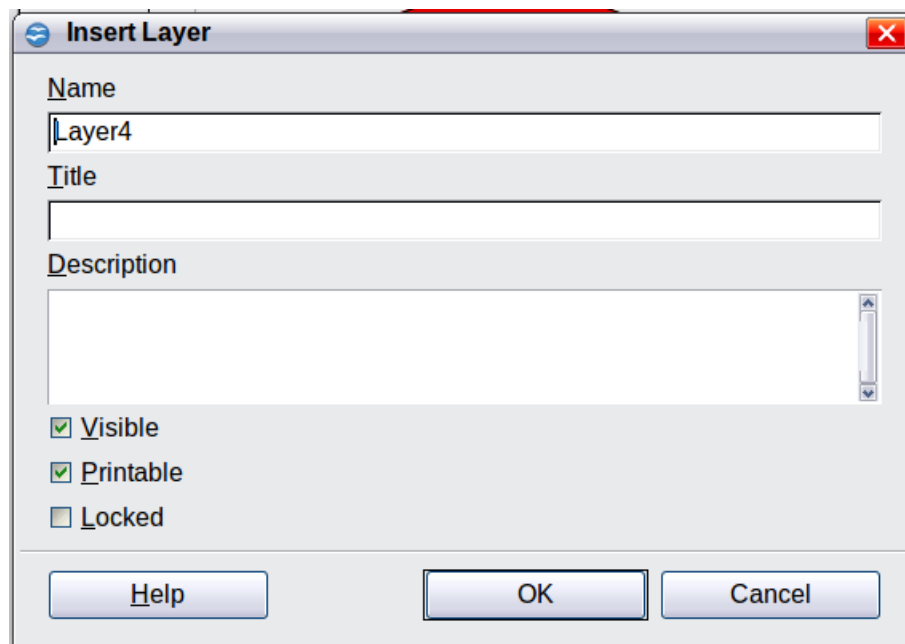

Figure 183: Inserting a new layer

On the **Insert Layer** dialog you can specify the following properties:

- *Visible*: If this property is not activated, the layer will not be shown (the layer is removed from the stack).
- *Printable*: If this property is not activated, the layer will not be printed. This is useful if you use a 'draft' layer for guides or annotations that you use in making the drawing but should not appear in the final output.
- *Locked*: All objects on this layer are protected from deletion, editing, or moving. No additional objects can be added to a protected layer. This property is useful when a base plan is to be protected while adding a new layer with other details.

Right-click on a layer tab to bring up a menu where you can insert or delete a layer, rename an existing layer, or modify a layer. You can change the names of the user-defined layers; the default layer names cannot be changed.

If you choose **Modify** the dialog is similar to Figure 183, but you cannot edit the Name. You can edit the Title and Description and change the properties of the layer (Visible, Printable, Locked).

Tip

You can move objects on one layer while you are working on another layer. To avoid doing this accidentally, you should lock layers that you are not currently working on.

An example drawing: house plan and furniture

A popular application for programs like Draw is the “moving the furniture” scenario. You can easily draw the floor plan of a room or a house using Draw. The simplest way is to draw walls as thick lines. Draw single rectangles or polygons and combine them: place them together, select them, then from the right-click menu use **Shapes > Merge** to make a single figure and add a hatching pattern. Before doing this, you should read the section “Drawing to scale” on page 146.

For this example, a suitable measurement unit is the centimeter. The drawing scale and grid settings depend on the size of the floor plan.

Use the Position and Size dialog (right-click and choose Position and Size) to position and dimension the individual wall sections easily. Make sure that the rectangles completely overlap (see Figure 184) otherwise the merging will give uneven edges.

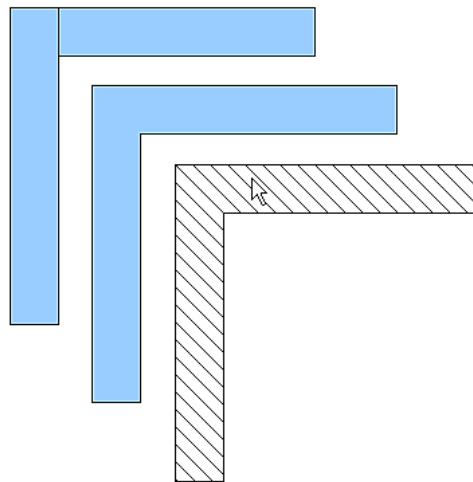

Figure 184: Wall corner from two rectangles. From upper to lower: before merging, after merging and after hatching

Figure 185 shows the finished floor plan. In addition, a chest of drawers has been added.

The body of the chest is drawn on the *Layout* layer; the pulled-out drawer and the open doors are drawn as a group and put on a separate user-defined layer (Layer4 in our example). Figure 186 shows how this is done. Making the layer with the drawers and doors visible or hidden will show them open and closed (see Figure 187). Hidden layers are shown with a colored tab.

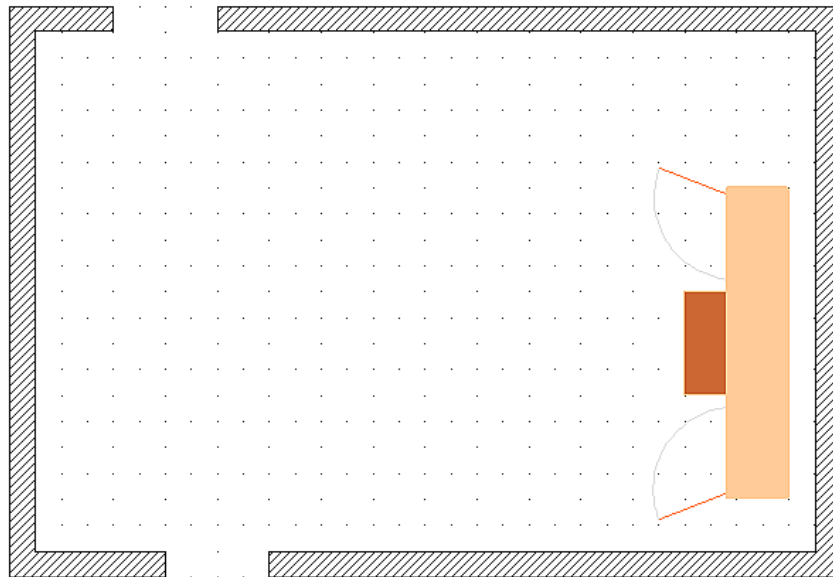

Figure 185: Floorplan with chest of drawers

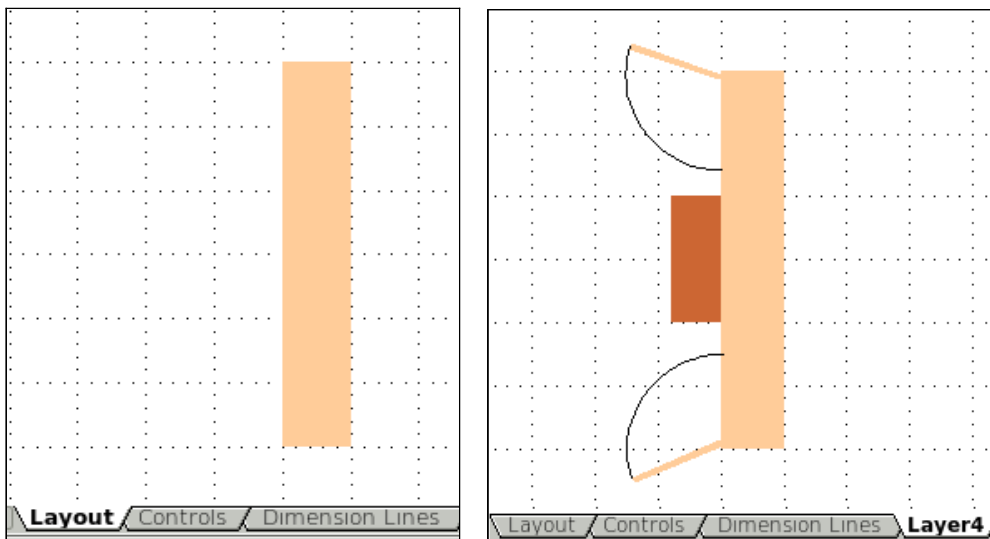

Figure 186: Using layers for different parts of a drawing. (Left) Draw the body of the chest on the Layout layer. (Right) Create a new layer and draw the open drawers and doors, keeping the Layout layer visible to help you position the additional objects.

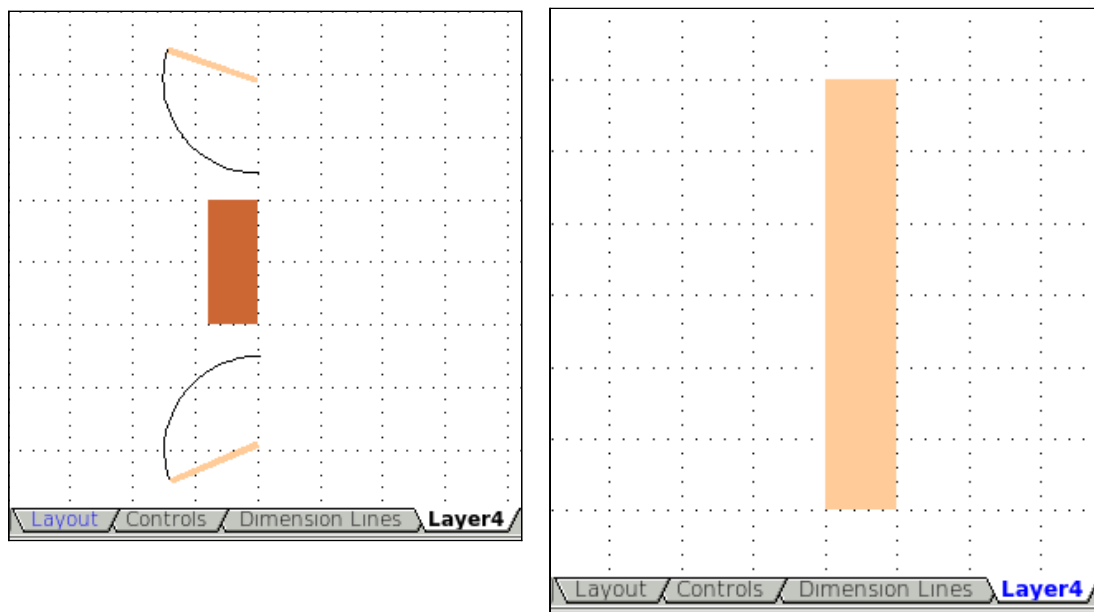

Figure 187: Making layers visible or hidden. (Left) Hide the Layout layer to see what is on Layer4. (Right) Show the Layout layer and hide Layer4 to show chest with drawers closed.

Caution



If you copy a drawing object to the Clipboard or into the Gallery, all layers other than the three standard layers (Layout, Controls and Dimension Lines) are lost. Furthermore all objects are pasted into the Layout layer. The reconstruction of layers is much easier if you assemble objects on a layer into a group before copying.

Changing the layer of a drawing object

Draw has no direct command to change layers. To move an object to another layer, change to the new layer, select the desired object or group, and then cut and paste it into position. Watch the status bar (the selected object's layer name is shown in the information field) to follow and check the change.

You can also click on the object, hold the mouse button pressed for about two seconds until the mouse cursor changes from a hand to a pointer with an open rectangle, and then drag and drop it on the appropriate layer.

Creating a multi-page document

Draw documents, like presentation (Impress) documents, can consist of multiple pages. As in Impress, tools to manage pages and backgrounds are available.

Pages are automatically named as *Slide 1*, *Slide 2*, and so on. This description is relative; if you move pages around, they are automatically renumbered. If you want to have fixed slide (page) names, you must name them yourself. Page names are useful for working with the Navigator and when you want to insert single pages into another document using **Insert > File**.

Using the Pages area

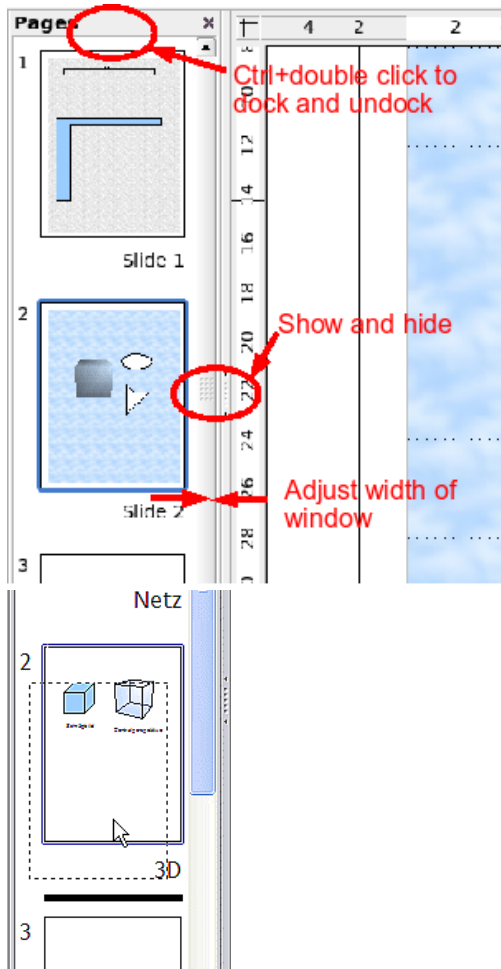

By default the Pages area is docked on the left of the Draw window. It shows every page in the document as a small picture. Select a picture from the Pages area and the corresponding page is loaded in the main workspace. Click on the page to activate it for editing.

The Pages area behaves similarly to the Styles and Formatting area. Drag on the gray separator line to change the width of the Pages pane. Click on the middle of this line to show or hide the pane. Double-click with the *Control* key pressed in the upper gray area to dock or undock the area, which can be turned into a floating window.

In the Pages area you can drag and drop a picture to change the order of pages in the document; a black horizontal line shows the position where the page will be inserted.

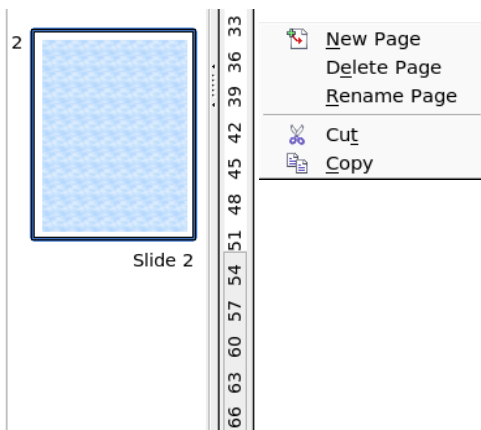

Using the context menu you can insert or delete pages or duplicate pages with copy and paste (alternatively create duplicate pages using **Insert > Duplicate Slide** on the menu).

Using page backgrounds

With background pages you can set common settings for multiple pages of the Draw document. These include setting the color or graphics of the background, background objects, and fields such as page numbering and author.

Note

The terms used in this area may not be completely consistent, so that the terms Slide/Page and Master/Background/Page Template are used more or less interchangeably in places. When looking for information in Help, it may be necessary to use alternative search terms.

Creating a page background

Change with **View > Master** to the Master view and note that a related Master View toolbar opens. If this toolbar does not appear, activate it with **View > Toolbars**. In this toolbar are switches for a new background page and for renaming the master page. These functions are also available by right-clicking on a page picture in the Pages area of the Master view. The button for deleting a master page is only available when you select a background page in the Pages area which has not yet been assigned to any page.

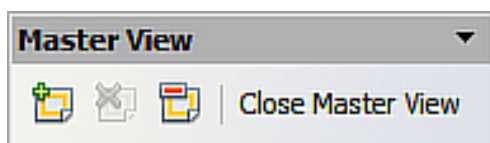

Figure 188: Master View toolbar

To return to normal mode, click the **Close Master View** button or **View > Normal**.

You can edit background pages just like normal pages. With **Format > Page > Background** you can set the color, pattern, or background picture. These settings are specific to each background page. In the Master view, you can set the size and orientation of the page; such settings apply to all pages.

If you insert drawing objects on a background page, they are visible on all pages that use this background. This a convenient way, for example, to place a logo on every page.

Master pages are organized in layers just like normal pages. The layers of normal pages are associated with the layer of the same name on the Master page. Accordingly the layers Layout/Control/Dimension Lines are considered to be a unit and the Master page layer Background objects is associated with them.

With **Insert > Fields** you can insert the date, time, page number, author and filename. No other fields are available. With page number you cannot insert a fixed page number but only a variable; the actual number appears on the page itself and is determined by the position of the page. The number is automatically adjusted if the page is subsequently moved.

Assigning and managing page backgrounds

You can open the Slide Design dialog (Figure 189) in two ways:

- Right-click on the page and choose **Page > Slide design**, or
- Look in the status bar to see which background page is the current one. Double-click in this field.

The Slide Design dialog (Figure 189) shows the available background pages for that page.

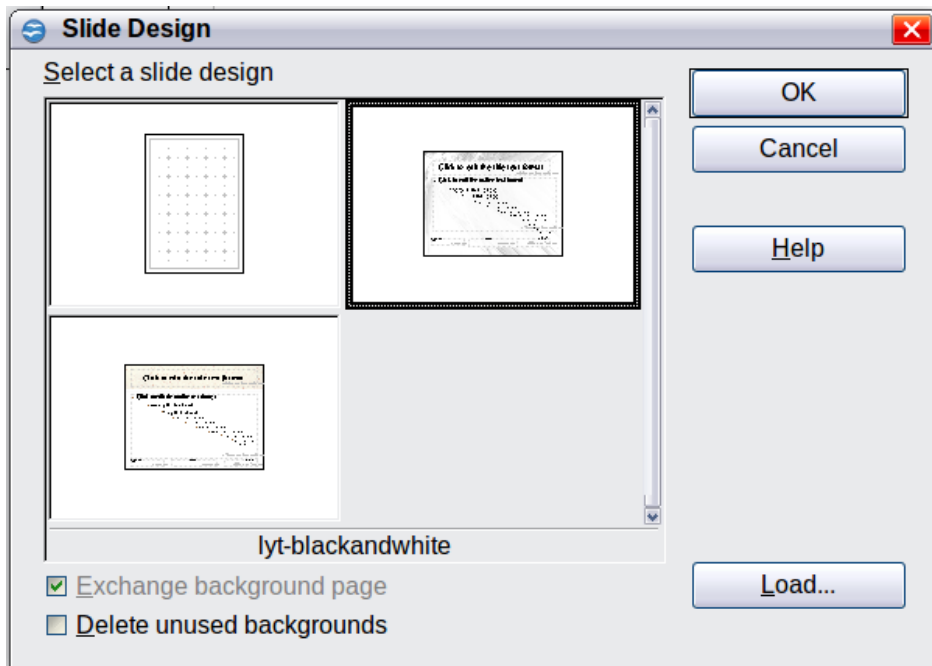

Figure 189: Slide design dialog

If the **Exchange background page** option is selected, the selected background page will be used on *all* pages of the document, not just on the currently active page.

The **Delete unused backgrounds** option deletes any backgrounds (as shown in the Slide Design dialog) that have not been assigned to a page.

Click the **Load** button to open the Load Slide Design dialog. From here you can load previously prepared background pages. All Draw and Impress templates can be used for this purpose. Note, however, that using Impress templates will bring in only the background and not the other elements prepared in Impress.

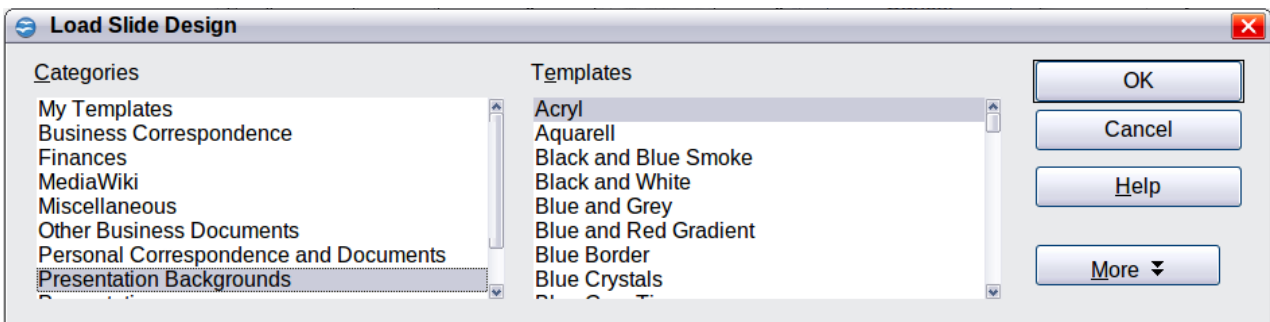

Figure 190: Load Slide Design dialog

There is no special option to store background pages as templates. Instead you can load a document with the desired background page and store this document as a document template with **File > Template > Save**.

Color palette: adding or changing single colors

Draw (like all OpenOffice.org components) uses color palettes for the representation of colors. In addition, you can customize the color palette to suit your own needs and wishes. You can modify colors in a palette, add other colors, or create new color palettes.

Reach these options with **Tools > Options > OpenOffice.org > Colors** or with **Format > Area > Colors** (tab) (see Figure 191). The latter method allows color palettes to be loaded or to be stored for future use. Any modifications made to colors apply only to the currently active palette.

OpenOffice.org always uses the RGB color model internally. Other methods are also available for the definition of a color value.

The color values can be input directly as numbers. Choose between the RGB color model (base colors Red, Green and Blue) and CMYK (base colors Cyan, Magenta, Yellow and Black, K= Key). The conversion to RGB values is made automatically.

Tip Information about color models can be found under:
http://en.wikipedia.org/wiki/Color_model

Individual color tones are produced by using different values of the base colors. The color value can be any integer value between 0 and 255. As an example, Red 3 has a red value of 184, a green value of 71 and a blue value of 0 in the RGB model. The CMYK color model uses percentages (in this case 0%, 44%, 72%, and 28% respectively).

Change these values to manipulate the color tone. Either enter a number directly or use the spinners on the right side of each field. The change in color will be shown in the lower color field (see Figure 191). Click the **Modify** button to apply and store the new setting.

To add a new color to the current palette, enter a new name in the Name field and set the desired color values. Click **Add**. The new color will be added to the end of the palette and stored in the currently active palette.

You can also delete colors from a palette. Select the color from the **Color** pull-down menu and click on the **Delete** button, then on **OK** to confirm the change.

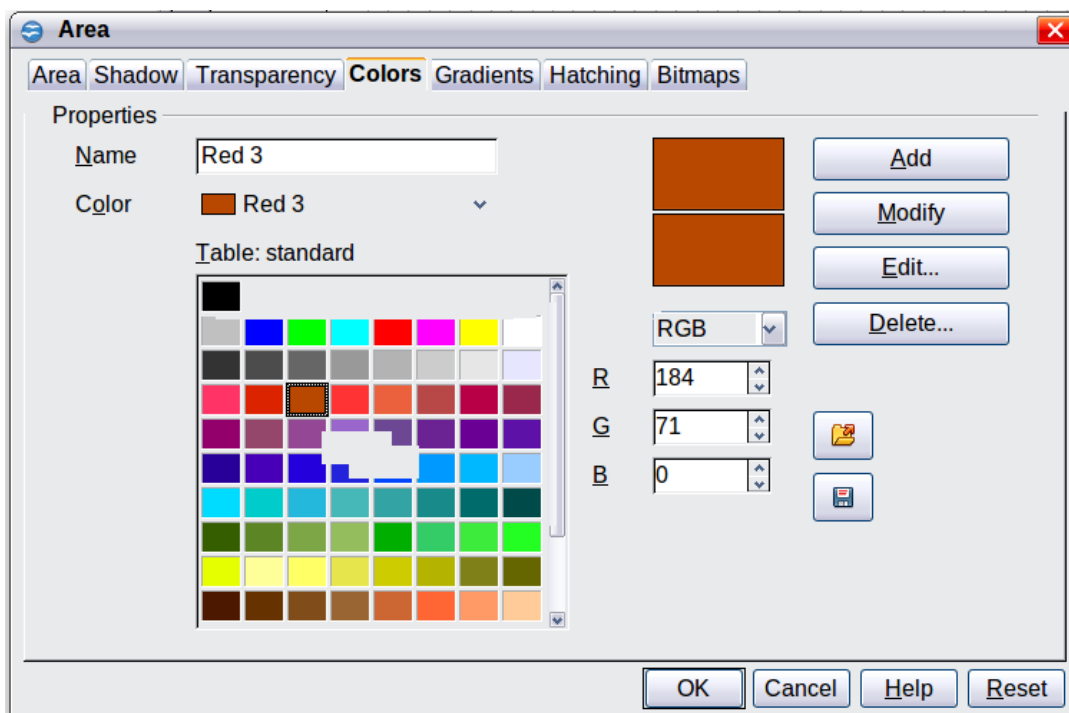

Figure 191: The Colors tab in the Area dialog

Click on the **Edit** button to open a dialog where you can set individual colors (see Figure 192). Many more input possibilities are available in this dialog.

In the lower area you can enter values in the RGB and CMYK models as well as the HSB (Hue, Saturation and Brightness) model.

The two color samples at the lower right show the current color (left) and the new color specified by the color value fields (right).

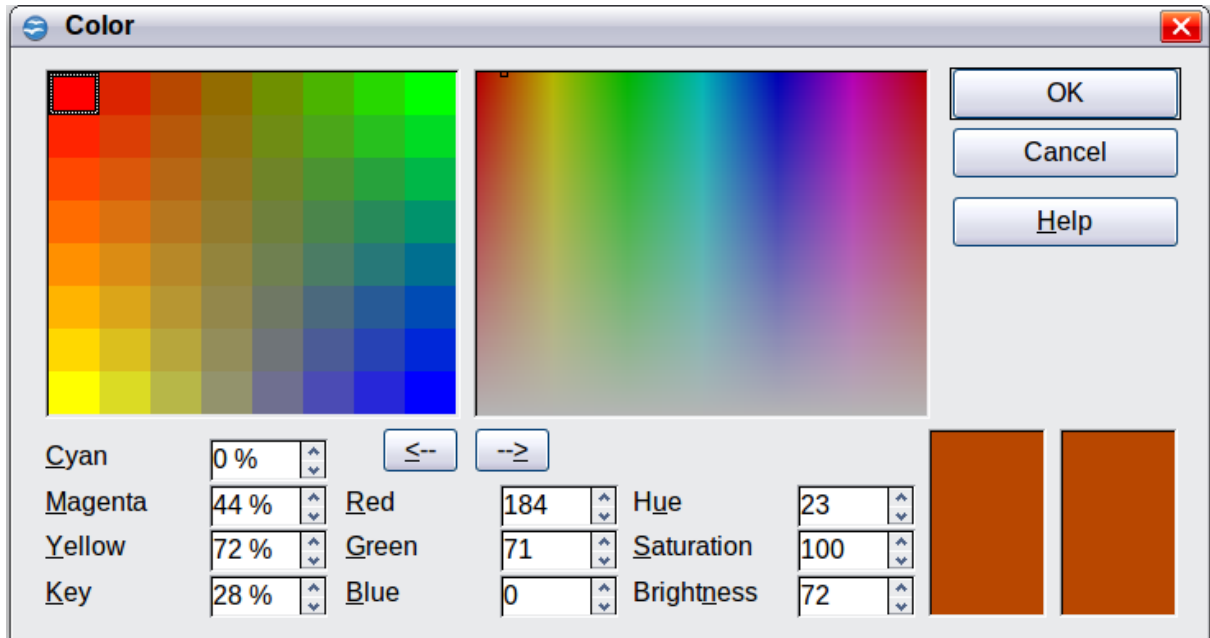

Figure 192: Color dialog

The color windows in the upper area permit a direct selection of color without any knowledge of color values. The right upper color window is linked directly with the various color model input fields; if you click on a color in this window the numbers change accordingly and a preview of the color appears in the right of the two color fields (lower right in Figure 192; see also Method 2 below).

If you click **OK**, the color window is closed and the input field is again active. You can at this stage select the color you have just defined, give it a new name, and store it by clicking the **Add** button. The old color will then (without any further warning) be overwritten.

Changing colors using the Color dialog

Method 1

You can change the current color by modifying the individual color values explicitly. It is possible to change from one color model to another during this process but the settings are always calculated and stored according to the RGB model. This may result in some slight adjustment to your input values in the other models.

The color wheel to the right illustrates the HSB color model. This model defines the color tone in terms of three parameters: Hue (possible values from 0 to 359), Saturation (possible values from 0 to 100) and Brightness (possible values from 0 to 100) is

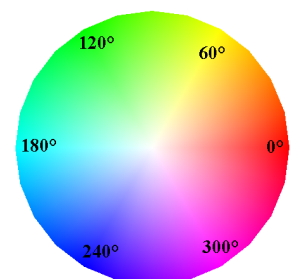

defined. The number for the hue represents the angle in the color wheel; the other two are both percentage values.

Method 2

You can select a new color by clicking on a point in the color window at the upper right of the dialog. The chosen color is shown in a black frame which can be dragged with the mouse. If this color is not quite right, you can fine tune it as described above in Method 1 by changing the color values.

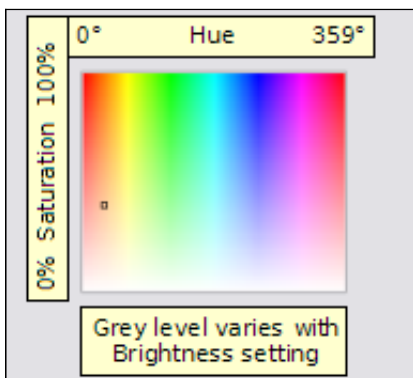

As you drag the small square you will see the value change in the number fields. The CMYK and RGB are more or less self explanatory. To make the HSB model a little clearer, some additional comments are necessary.

To better understand the working of the HSB model, move the frame from left to right and top to bottom. You will see that the Hue and Saturation values swing between their maximum and minimum (hue by horizontal movement and saturation by vertical movement), but the brightness remains the same (see figure at left). This latter can only be adjusted by entering a value into the number field.

Method 3

The left color window is divided like a chess board into 8 x 8 individual fields, each with a different color. Most important are the colors in each of the corner fields. The color red changes stepwise to green in the first row, and stepwise to yellow in the first column. The color green in the last column changes stepwise to blue.

This window thus contains a stepwise change between each of the four main colors in the corner points. If you hover the mouse over a square the RGB value is shown as a tooltip. For example, the yellow corner field (lower left) has RGB values of 255, 255 and 0 (full red, full green and no blue).

Click on this yellow field. A frame appears. If you click the --> arrow under the color windows the selected color is assigned.

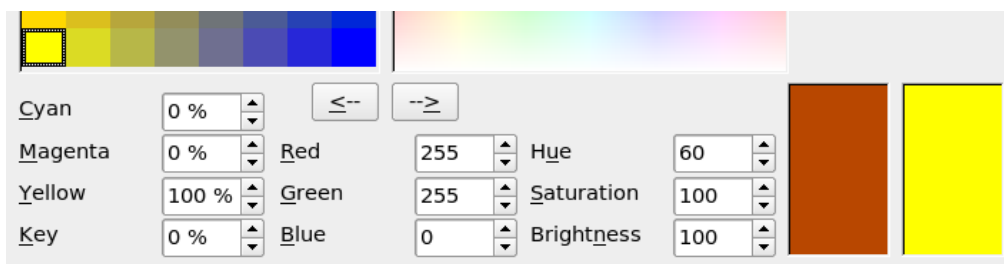

You can change the color spread in this window to a more specific range by changing one or more of the corner fields. Click on the corner you want to change, then select the preferred color from the right color window with the mouse and/or set it using the number fields. Now click on the <-- arrow; the new color will be assigned to the corner square you selected and the overall appearance of the window changes accordingly.

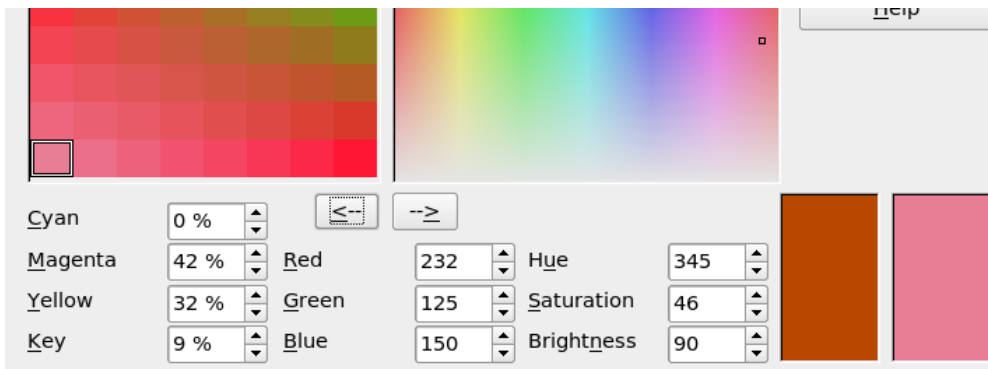

Figure 193: Changing the color of a corner square

Creating cool effects

Duplication

Duplication makes copies of an object while applying a set of changes (such as color or rotation) to the duplicates.

To start duplication, click on an object or group and choose **Edit > Duplicate**. The Duplicate dialog (Figure 195) appears.

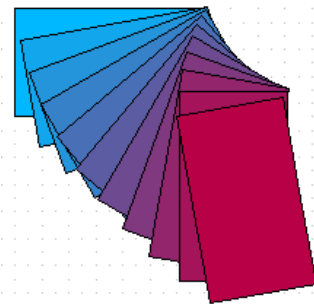

Figure 194: Duplication example

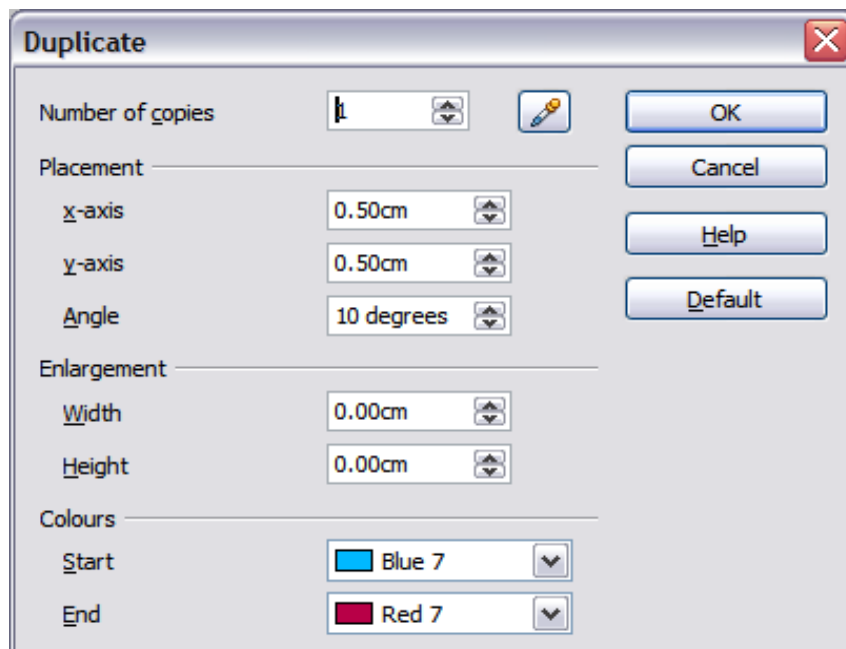

Figure 195: Duplicate dialog

Choose the number of copies, their separation (placement), rotation, and so on. The choices above applied to a blue rectangle produce the result shown in Figure 194.

Cross-fading

Cross-fading transforms one shape into another. The result is a new group of objects including the two end points and the intermediate steps.

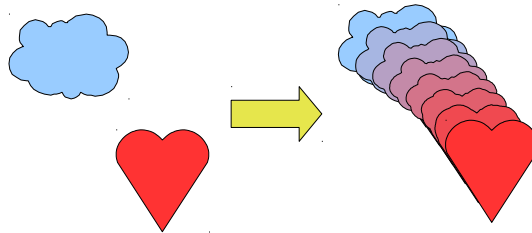

Figure 196: Cross-fading example

To do a cross-fade, first select two objects.

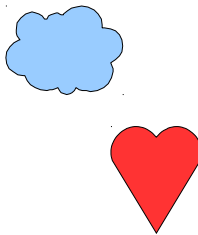

Figure 197: The two objects selected for cross fading

Then choose **Edit > Cross-fading**.

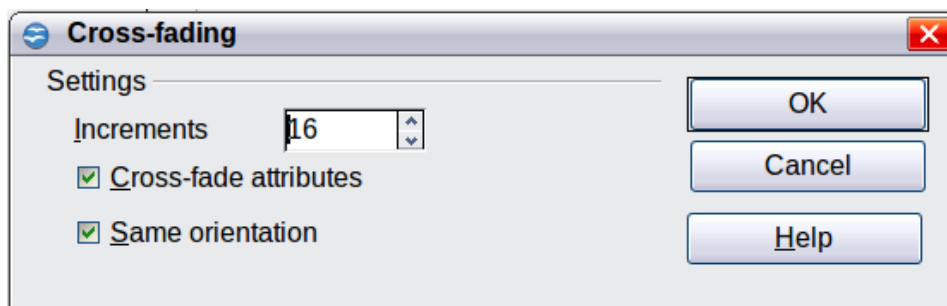





Figure 198: Cross-fading dialog

On the dialog choose the number of increments (transition steps). You probably want to have *Cross-fade attributes* and *Same orientation* both checked. The end result is shown in Figure 196.

Which object goes in front?

How do I tell Draw that I want  and not  ?

Select  (the object we want in front), right-click and choose **Arrange > Bring to Front** (or press *Ctrl+Shift+plus*). Or select  (the object we want behind), right-click and choose **Arrange > Send to Back** or press *Ctrl+Shift+minus*.



Chapter 9

Organization Charts, Flow Diagrams, and More

Free eBook Edition

Drawing an organization chart

Even though Draw does not have an organization chart toolbar, you can draw these charts by drawing rectangles and connector lines (see Figure 199). You can indicate hierarchies by using a color progression from dark to light tones. Your color choices should maintain a good contrast between text color and background so that you can easily read the printed diagram.

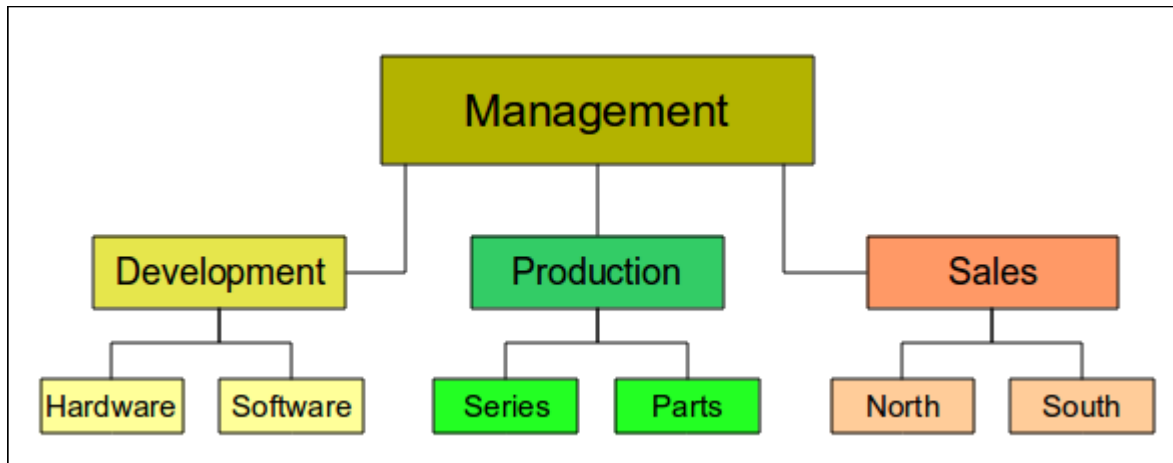

Figure 199: Example of an Organization Chart

Before you begin, prepare a setup page or draft, with snap lines, to assist in drawing the various hierarchies, responsibility paths, and typical boxes that you will use in drawing the chart.

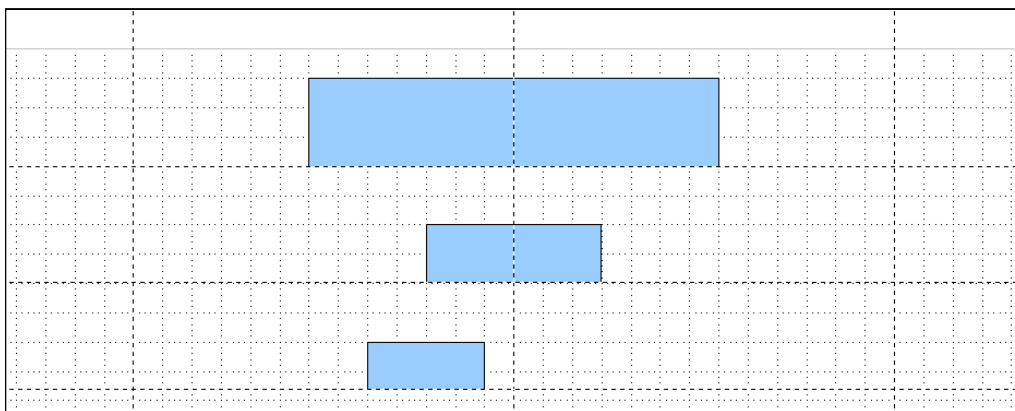

Figure 200: Draft with snap lines

Place and dimension the individual boxes according to the size of the overall chart. The exact size (particularly width), position, and color will be fixed later. It is sometimes easier to draw only one box per level; later you can copy and paste this box and then move the copies to the desired positions. Using styles can also be helpful; see the relevant section in Chapter 4 (Changing Object Attributes).

You can also select one or more boxes and use **Edit > Duplicate** to make copies (see Figure 201). The spacing of the duplicated objects relative to the original can be controlled using the placement fields for the X and Y axes. Note that positive values for X and Y are to the right and downwards from the original object.

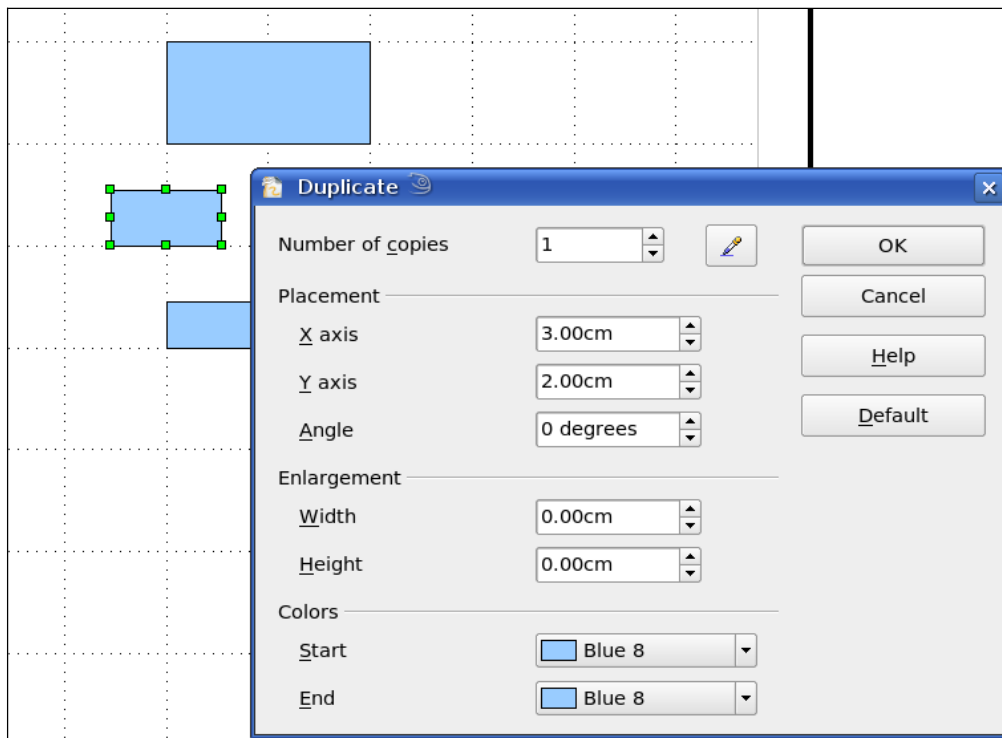

Figure 201: Duplicating an object

Which replication technique you use is up to you. The draft for the example in this chapter should look similar to that in Figure 202.

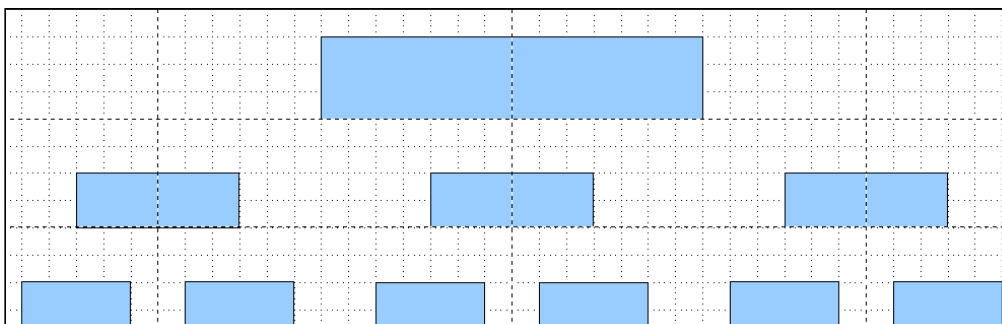



Figure 202: The finished draft

The next step is to add text to the boxes. It is easiest to insert it as a text element within the box as described in Chapter 2 (Drawing Basic Shapes). Activate the  icon on the Options toolbar and then double-click the box to enter text into it. Alternatively, select the box and press *F2*. You should then see a blinking cursor in the box and the Text Formatting toolbar should be visible.

Set the text formatting and type the text. Depending on the length and format of the text, you may need to adjust the size of the box and the spacing to neighboring boxes or else change the formatting of the text to fit the box. Adjustments can be made initially with the mouse and then fine-tuned with the Position and Size dialog.

Now set up the fill colors and save the drawing. The connections between the boxes are not drawn with ordinary lines but with Draw's *connectors*. How to draw these connectors and add text to them is described in "Glue points and connectors" starting on page 164.

You can use dynamic text frames instead of boxes. These have the advantage of automatic line breaks. Figure 203 shows the sequence of text input into a frame, adding borders, and setting the background color. The Line and Filling toolbar may not be visible until you have set a line type for the frame. Set the line type using **Format > Line** or right-clicking the text frame and selecting Line.

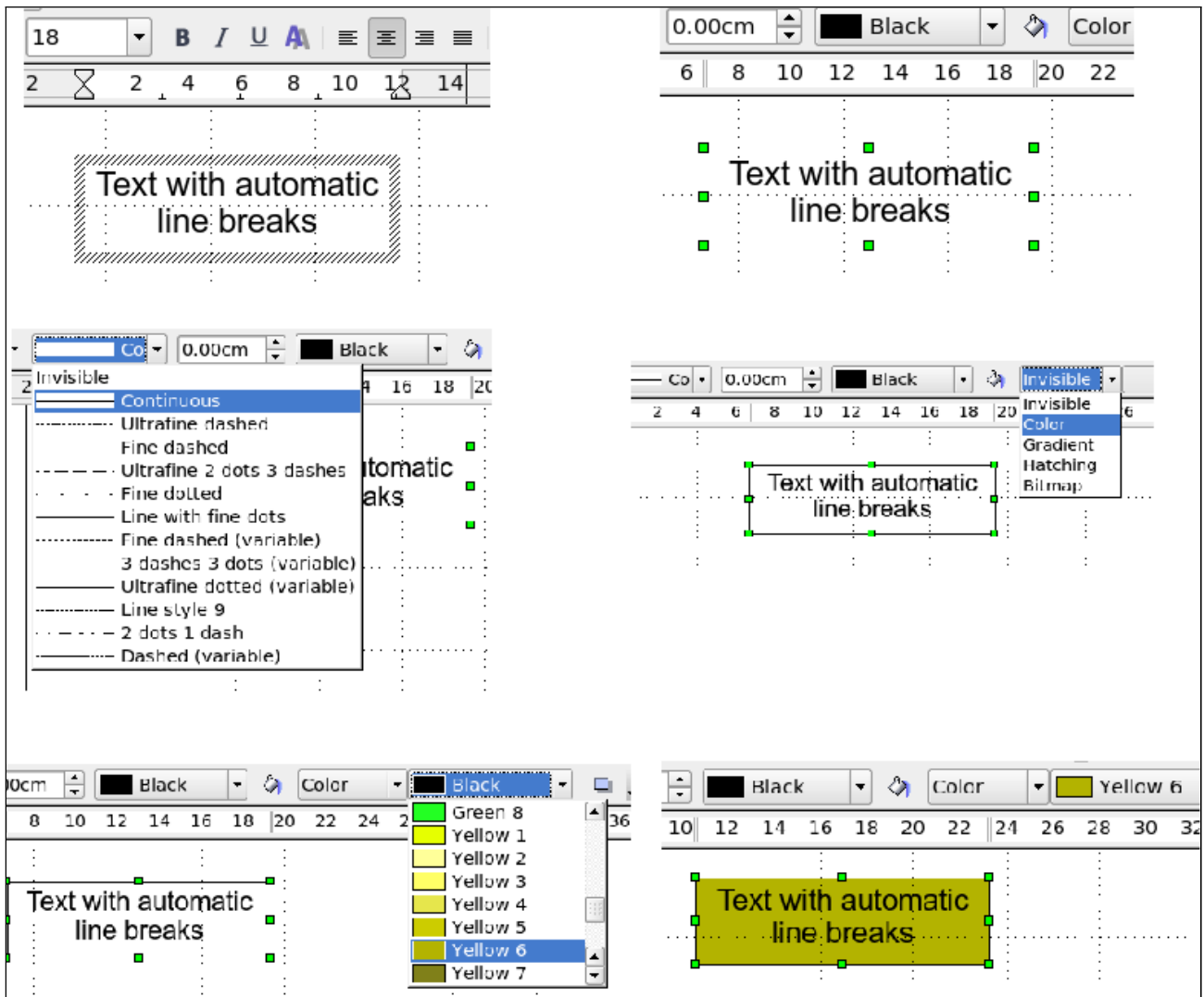



Figure 203: Working with text frames

Drawing a flow diagram

For drawing flow diagrams (also known as flowcharts), Draw offers a separate toolbar (Figure 204); click the flowchart icon  on the main Drawing toolbar.

The easiest way to draw a flowchart is to follow the same setup procedure as for organization charts. Select the symbols from the toolbar and drag them into position as described in Chapter 2 (Drawing Basic Shapes). See Figure 205 for an example of a typical flowchart.

The individual symbols must be exactly positioned if the connectors joining them are to form a vertical line. The midpoints of all the symbols that lie in a vertical straight line should have the same X coordinate and those on the same level on a horizontal line should have the same Y coordinate.

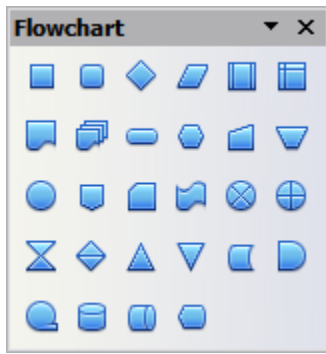

Figure 204: The Flowchart toolbar

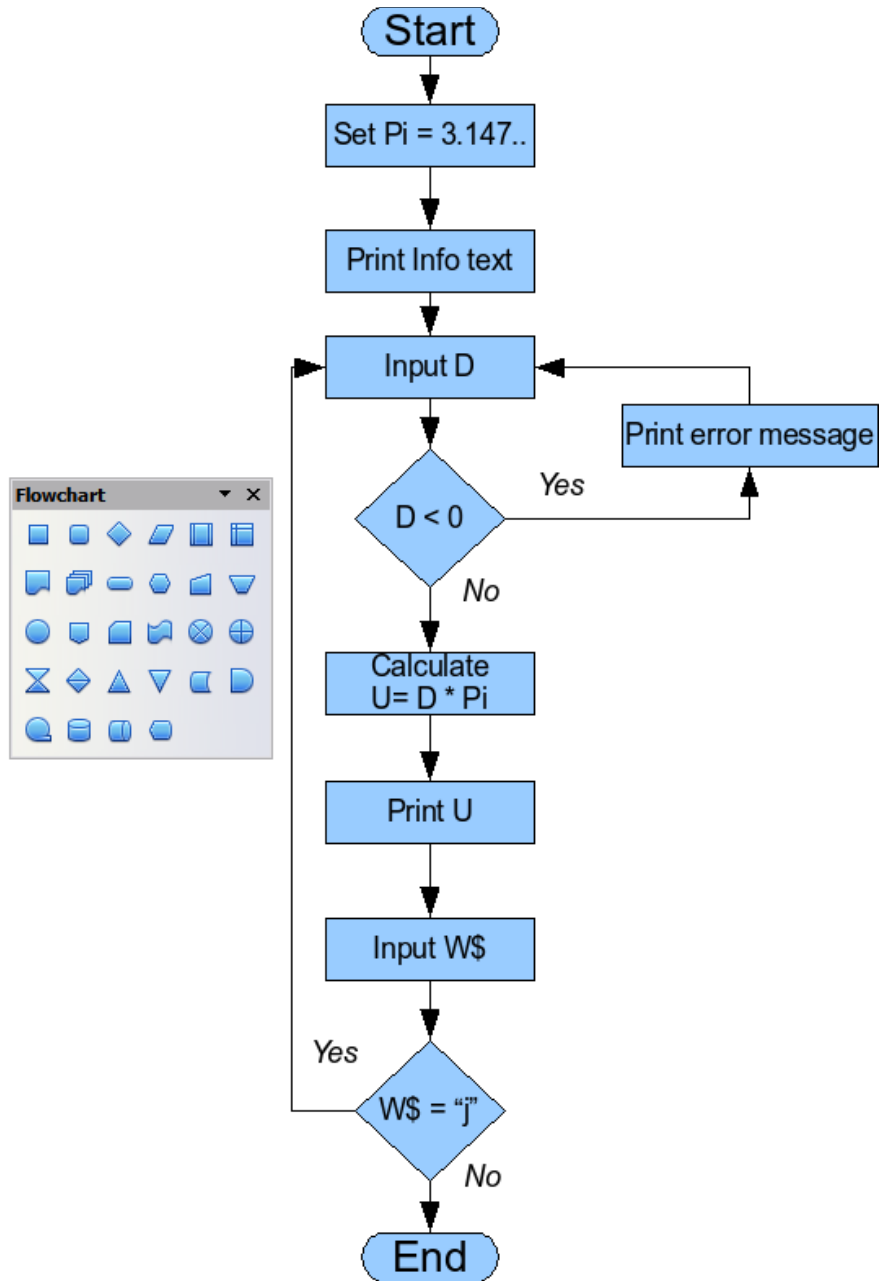

Figure 205: Example of a flow diagram

Select the shapes that are to lie in a vertical straight line and center them with **Modify > Alignment > Centered**. For those on a horizontal line, select the shapes and center them with **Modify > Alignment > Center**. You can also set snap lines if you need several vertical lines.



After adding text and setting the fill color, you can join individual symbols together and add text to the connectors. This technique is described in the next section.

Glue points and connectors

These elements were briefly introduced in Chapter 2 (Drawing Basic Shapes). This section describes how to use them.

Connectors are lines or arrows whose ends automatically dock to a connection or glue point on an object. Connectors are particularly useful when drawing organization charts, flow diagrams, and mind-maps. The connecting lines between the symbols remain intact even when the latter are moved or rearranged.

The Connector toolbar

Click on the  arrow of the  button on the Draw toolbar to open the Connectors toolbar.

If the type of connector you want is not shown, drag the toolbar to make it float, then click on the  arrow in the toolbar's title bar. In the list that appears, click on **Visible buttons** to open a menu from which you can activate additional types of connector (Figure 206).

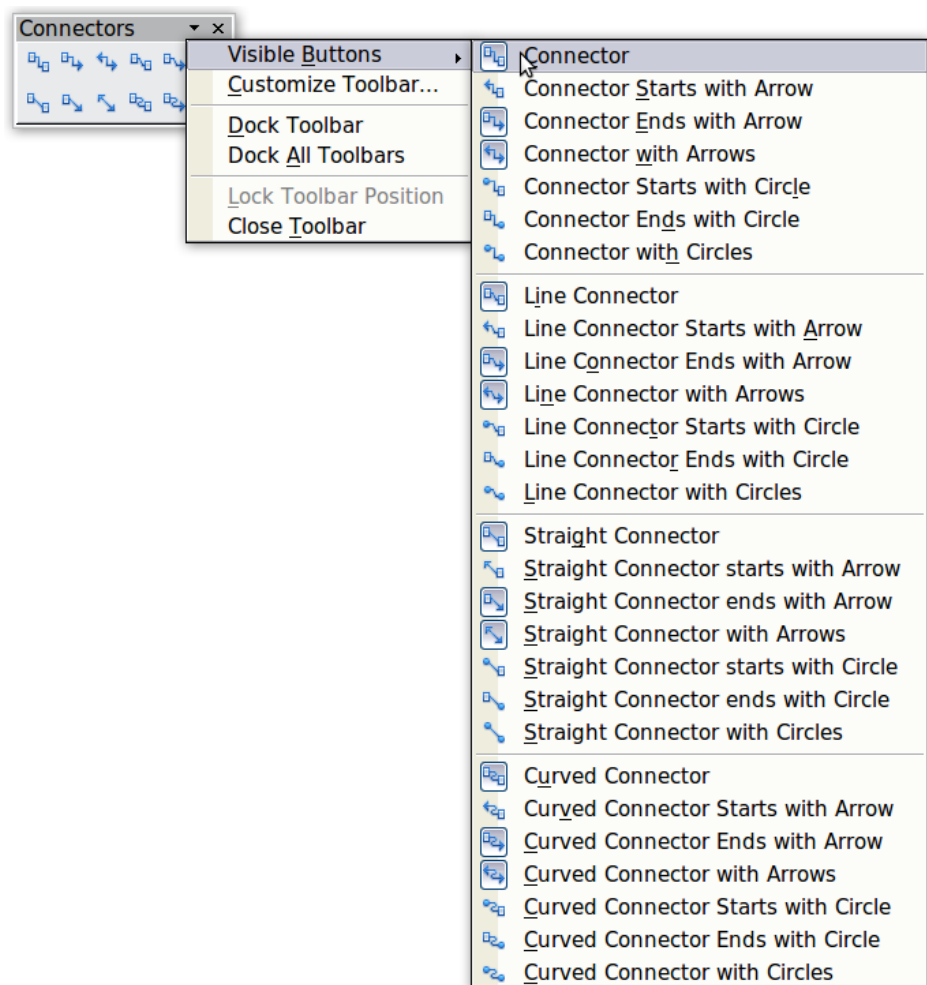



Figure 206: Activating additional connectors

Connector types fall into four groups:

- *Standard connectors* – the line segments run vertically and horizontally. All angles are right angles. The connector does not bend around the objects it binds.
- *Line connectors* – consist of a line segment and two smaller horizontal or vertical segments at the ends.
- *Straight connectors* – consist of a single line.
- *Curved connectors* – are based on Bézier curves, as described in Chapter 10 (Advanced Draw Techniques).

You can modify all the connector types from the context menu. Select **Connector** to change from one connector type to another (as well as some other properties). With the Line dialog you can change the appearance of the line (color, arrow style, and line style) but not the connector type.

Drawing connectors—basics

When you choose a connector from the toolbar, the mouse pointer changes to . As you move the cursor over an object, the available connection points (also referred to as glue points) become visible. To connect two shapes, move the mouse cursor over a glue point, click and hold down the left mouse button to establish the first point, and then drag the mouse cursor (left button still pressed) to the other glue point and release the mouse button. The ends of the line are now docked and the connection is established (see Figure 207).

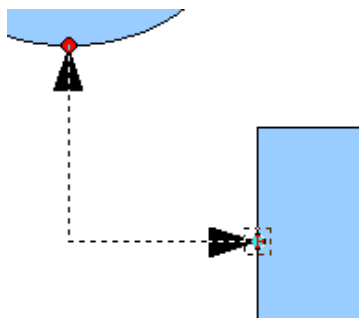

Figure 207: Gluing a connector to a shape

You can also attach the beginning or the end of a connector to the middle of an object. This is useful when the final position of the object is not yet determined. When you move the object, Draw automatically selects the optimal location for the connector ends (see Figure 208).

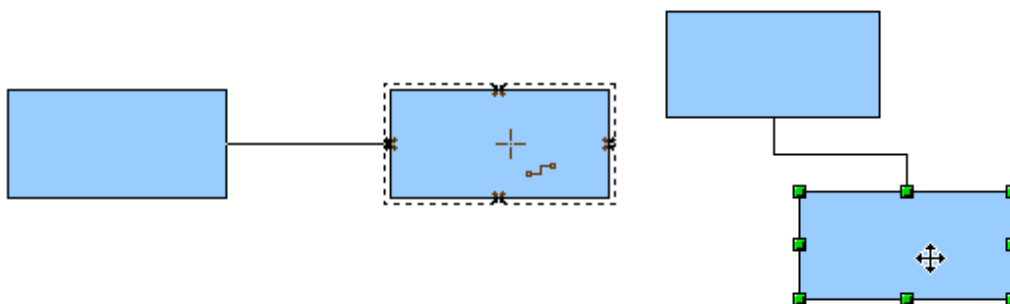

Figure 208: Connector attached to the middle of an object

As with all other objects, connectors have one or more control points to simplify the construction of the drawing. You can use these points to change the shape, length, and proportions of the connector line (see Figure 209).

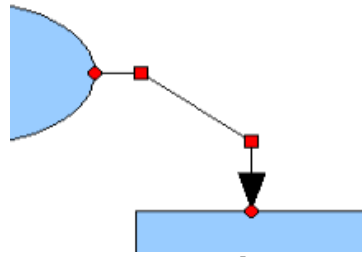

Figure 209: Control points of a connector

To remove a connector from an object, either move the end of the connector away from the glue point of the object or simply delete the connector entirely.

Editing glue points

Glue points can be edited using a separate toolbar (see Figure 210). This toolbar appears when you click on the *Glue Points* icon  or select **Edit > Glue Points** from the main menu.

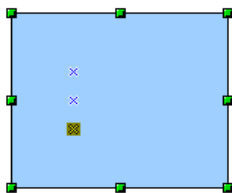

Figure 210: The Glue points toolbar

The following briefly describes the function of each button on this toolbar.



Use this button to insert a new glue point into an object you have drawn. If the object is filled, you can place a glue point anywhere inside the object or on its frame. With unfilled objects you can place a glue point only on the outside frame but you can then drag it inside the object provided that the *Glue Points* icon on the Drawing toolbar is still active .



The glue points that you add remain visible as long as the *Glue Points* icon is active. They appear as small blue crosses. A selected glue point has a gray square behind the cross. You can move a selected glue point with the mouse or delete it with the *Del* key.





Use these four buttons to choose one or more directions permitted for a connector to join to a particular glue point.

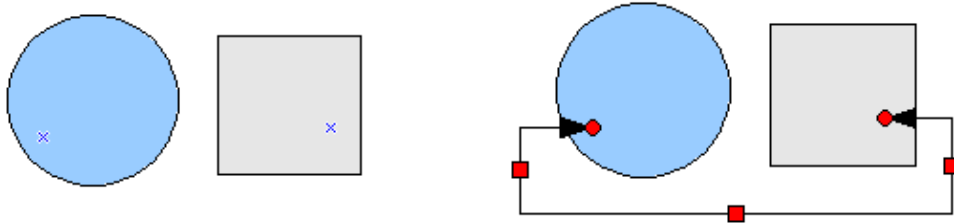

Activate *Glue Points* and then choose the direction. If, for example, you activate only the  button, every connector will be forced to come to that glue point from the left side.

In the left-hand drawing below is a glue point in the circle with a left entry and one in the square with a right entry. The effect of this when adding a connector between the two glue points is shown in the right-hand drawing..



If you are in glue point editing mode and you add another direction to a glue point (for example by activating the  button), Draw tries to optimize the length of the connector. For the example above, the connection inside the circle would change as shown below.

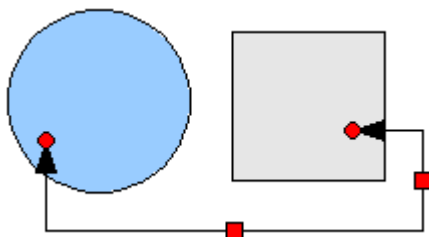

If the *Glue Point Relative* button is active (as it is by default) the glue point will move when you change the size of the object, as shown below.

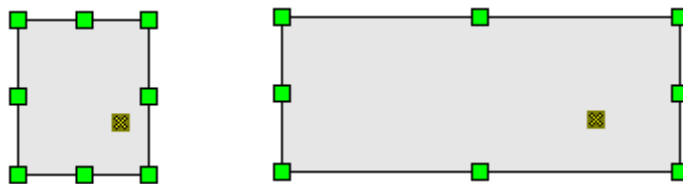

If the *Glue Point Relative* button is deactivated, the remaining buttons on the toolbar, previously grayed out, become active. With these buttons you can decide how a glue point will be placed when the size of the object is changed.



These buttons determine how the horizontal position of a glue point changes when you resize the object containing the glue point. You can choose whether the glue point remains at a fixed distance from the left edge of the object, from a vertical line through the middle, or from the right edge of the object when you change the size of the object. If the width of the object becomes less than that distance, the glue point is attached to the object frame.

The following example shows what happens when an object's width is changed and the glue point is set to be a fixed distance to the left frame.



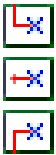

These buttons determine in a similar manner the vertical position of a glue point when the size of the object is changed.

Adding text to connectors

To add text to a connector, double-click the connector. The end and control points become active and the familiar flashing text cursor appears (the cursor position is determined by the most recent setting). The Text Formatting toolbar also appears (under the menu bar). Use this toolbar to set the text properties; you can directly insert the text.

If you draw a connector and then click on it, only the end points and control points become visible. In spite of this, a connector has its own object frame—in this case an invisible one. You can picture it easily by imagining a rectangle enclosing the start and end points of the connector (Figure 211).

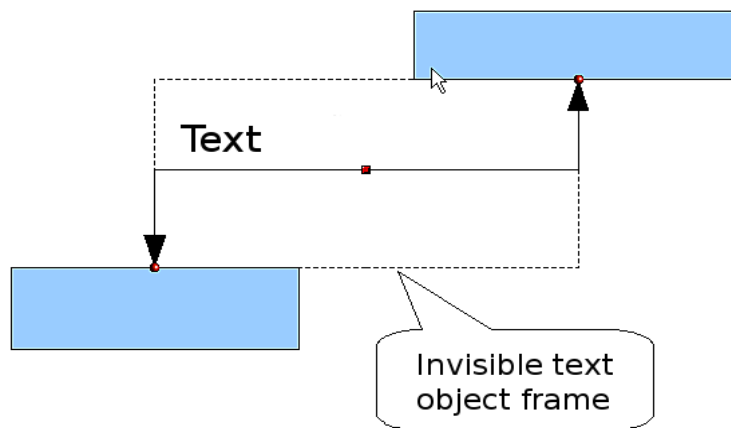

Figure 211: Object frame of a connector

When you add text to a connector, the location of the text is relative to this rectangle. The exact position of the text can be set in the Text dialog (Figure 212). This dialog appears when you double-click on text and then choose **Text** from the pop-up menu or when you single-click on the connector and select **Format > Text** from the menu bar.

Take particular note of the *Spacing to borders* and *Text anchor* sections in the Text dialog. In the *Text anchor* section you can see the possible locations for the text. In the example below the text is anchored at the top left. In the *Spacing to borders* section at the lower left, negative values of spacing will position the text outside the frame.

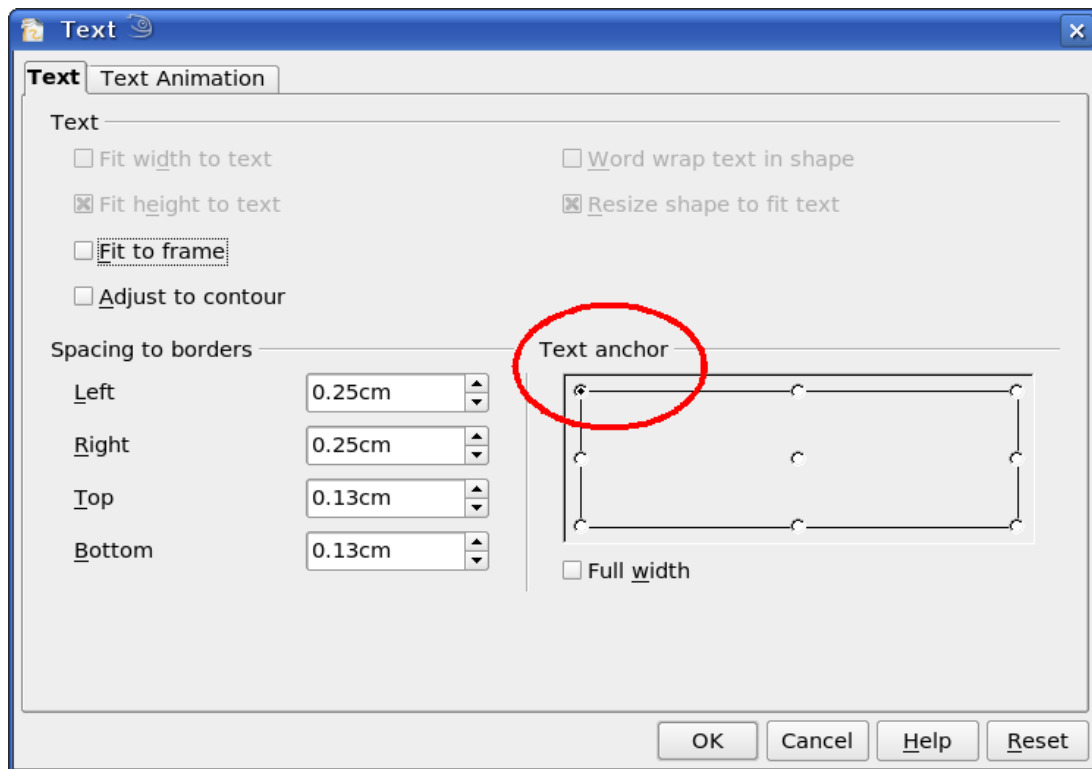



Figure 212: The Text dialog

Adjusting text to suit the connecting line

If you want the text to follow the slope or curve of a line, you need to activate and use the Fontwork tool. To add this tool to the Draw toolbar:

- 1) Choose **Tools > Customize** from the menu bar.
- 2) On the Toolbars tab, select *Drawing* from the Toolbars pull-down list. In the *Toolbar content* section, click **Add**.
- 3) On the Add Commands dialog, select *Format* from the left-hand list and the command *Fontwork*. Click **Add**, then **Close** to return to the Customize dialog.
- 4) In the list of commands under *Toolbar Content*, move the Fontwork icon  to the location you want by using the up/down arrows, and then click **OK**.

To write slanting text, follow these steps:

- 1) Add the text to the connector as described earlier. The anchor location of the text is not important at this stage.
- 2) Select the object with the text (in this case the connector) and click on the Fontwork icon  to open the Fontwork dialog.
- 3) To make the text lie along the inclined line, click the **Rotate** icon and set the distance to the line you wish.

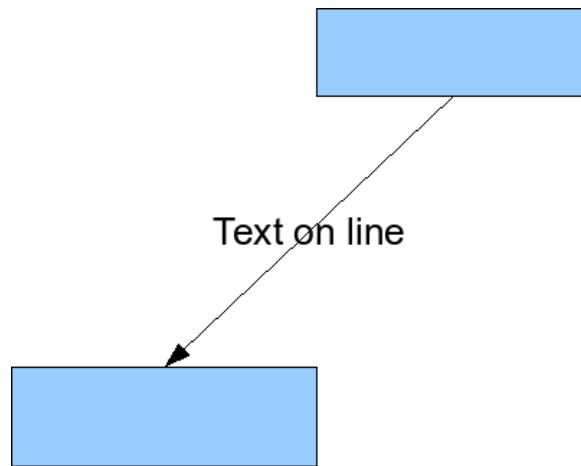

Figure 213: Adding text to an inclined line, Step 1

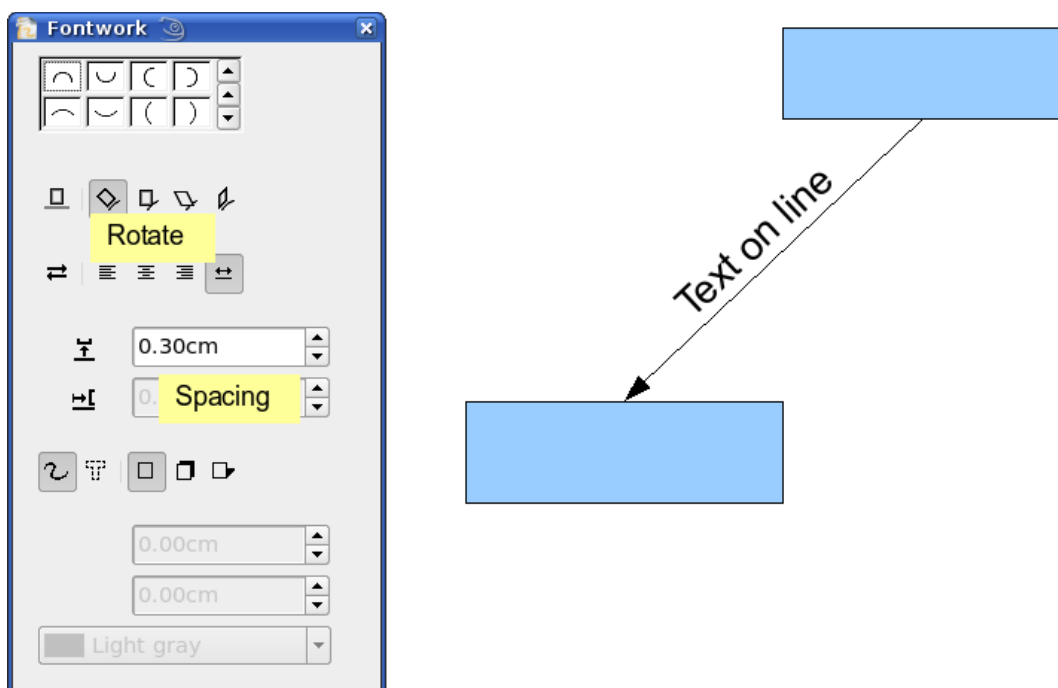



Figure 214: Adding text to an inclined line, Step 2

The Fontwork dialog provides many other possibilities for manipulating text. You can, for example, rotate the text 180 degrees with the Orientation  icon (which was done in the example above) or place the text under the line by assigning a negative value to the spacing between text and line.

In addition, you can use the Fontwork dialog to generate curved text that follows the shape of a curved line. Experiment a little to investigate some of the possibilities.

Chapter 10
Advanced Draw
Techniques

Drawing to scale

Draw is not a CAD (computer-aided design) program but a graphics program with which you can produce drawings to scale. The example used for this chapter is a drawing of a Logic Circuit Diagram. The exact meaning of the individual symbols is not described here as we are only interested in the drawing techniques used to produce the diagram.

The logic symbols in Figure 215 form the building block library for our scale drawing.

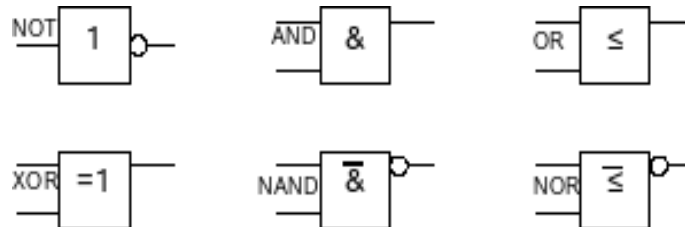

Figure 215: Logic Symbol library

Working with the Position and Size dialog

To ensure that the edges of the building block symbols do not coincide with the wiring, they should be 8 mm wide and 8 mm high. The connections to the symbols should have a length and separation of at least 5 mm. These values are somewhat arbitrary and you can substitute values that suit your own needs.

For the drawing we used a measurement unit of millimeters, a grid spacing of 5 mm, and a grid subdivision of 4 points. In addition you should probably activate *Display grid* and *Guides when moving* as well as *Snap to grid* (see Chapter 8). This drawing will serve later as a collection of available symbols, so you should not only draw the symbols but fully detail them as well.

The first step is to draw a base element, an AND gate block. You can then dimension and detail this element (use the Position and Size dialog, as shown in Figure 216; double-click on the status bar or context menu to help with dimensioning). For this example, the left upper corner of the block is at x=10 mm and y=5 mm.

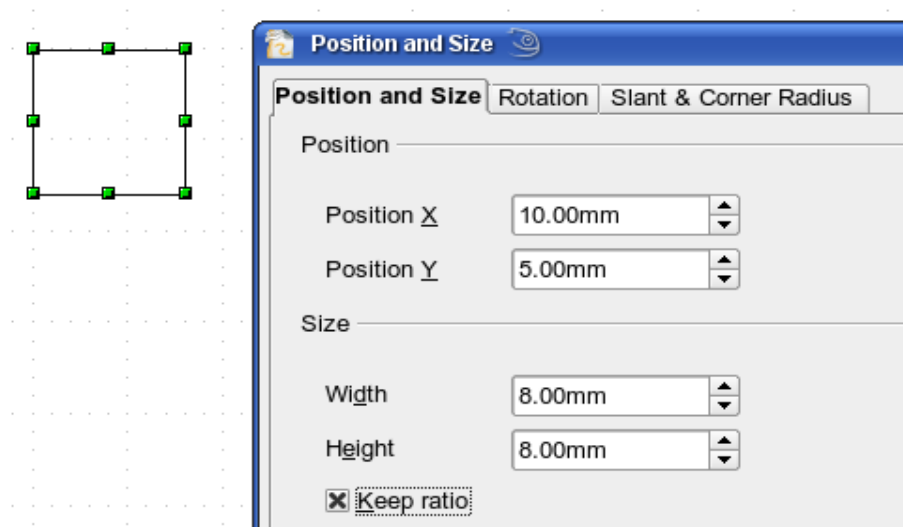

Figure 216: Positioning and dimensioning a Draw object

Draw the first connection lead by eye and dimension and position it using the Position and Size dialog.

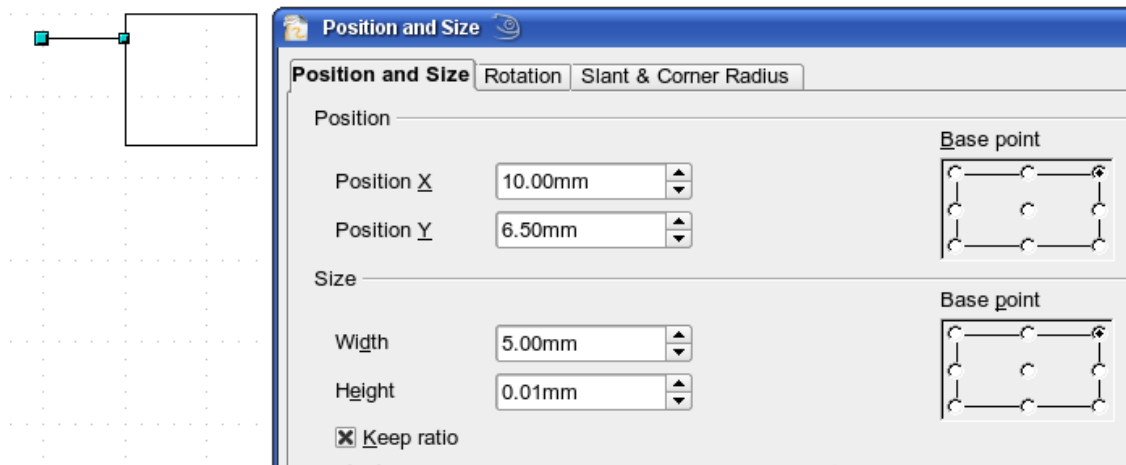

Figure 217: Setting the position and dimension of the upper input

Use the same method to draw the remaining two leads. For positioning the input leads, fix the right end points; for the output lead, fix the left one. The first wire lies 1.5 mm below the upper edge of the block. The leads have a 5 mm spacing between them. The following table shows the relevant coordinates of the upper corner points and the leads.

left (X/Y) [mm]	right (X/Y) [mm]	Input 1 (X/Y) [mm]	Output (X/Y) [mm]
10 / 5	18 / 5	10 / 6.5 (right EP.)	18 / 6.5 (left EP.)

For the lower input lead, increase the Y coordinate of Input 1 by 5 mm to 11.5.

The AND gate block is almost finished. We can use it as the basis for all the other gates. Use **Edit > Duplicate** to ensure uniformity of shape and size, so that the drawing gives a good visual impression

Because we want to copy the block vertically downwards, use a Placement on the X Axis of 0 mm and on the Y Axis 15 mm.

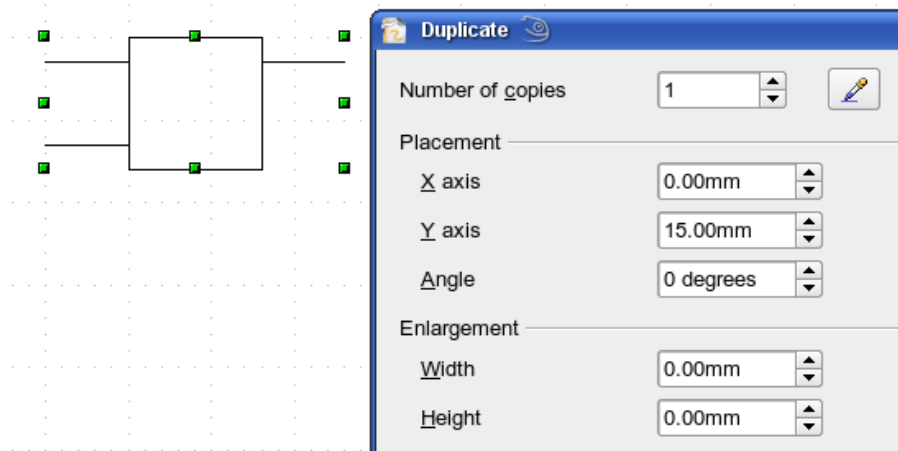

Figure 218: Duplicating an object

Using the same method, copy both blocks twice more to the right. Select both blocks, call up the Duplicate dialog, and use placement values of 30 mm (X) and 0 mm (Y). Your drawing should look similar to Figure 219.

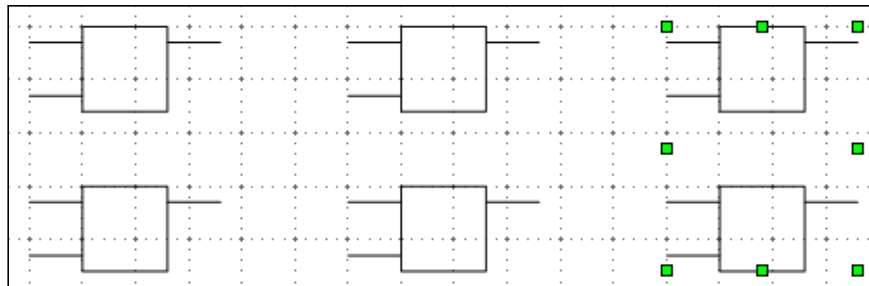



Figure 219: The blocks after duplication

For the INVERTER or NOT gate the connection leads must be amended. Move one input and one output lead to the middle of the block and delete the superfluous input lead.

Draw the missing circle for negation with a diameter of 2 mm, place it by eye in the center and then position it and dimension the connections from the Position and Size dialog as described above.

You can copy the circle to the Clipboard and then paste it as many times as you need, positioning it and adjusting the lead lengths as above.

A wiring diagram also needs a symbol to show a connection point. Draw a filled circle for this.

Next add text to the symbols (&, =1 etc.). Activate the icon  on the Options Toolbar. Double-clicking a symbol will now put you in a special text input mode. This integrates the text as an element in the object (see also Chapter 2 of this guide). You will find the OR symbol (\leq) in the list of special characters (**Insert > Special Characters**).

It is probably a good idea to create a group for each type of gate. This will make it easier to use them in a diagram. Your diagram should now resemble Figure 215; save it to disk.

If you want, you can add a name to each of the gate symbols (AND, OR ...). Use a separate layer to add this text so that you can switch it off when necessary.

You can place glue points at the end of each connection lead. This will simplify the actual “wiring up” later when you add in the connectors.

Setting glue points

This instruction assumes a basic knowledge of connectors and glue points. For additional information refer to Chapters 2, 8, and 9 of this guide.

Note

If objects are included in a group, it is not possible in Draw 3.3 or earlier to add glue points to them; glue points must be set before any grouping is done. This will change in Draw 3.4.

The glue points on the connection leads must be placed exactly at the ends of the lines (otherwise the wires will not be properly aligned). Unfortunately you cannot set the position of glue points using numerical values. It is necessary to do it by hand.

The best solution is to use the Zoom toolbar to enlarge the diagrams. You can find this as a tear-off toolbar on the standard Drawing toolbar. It contains (among others) tools for zooming in and out (enlarging or shrinking the view) of the current page. If you click on the **Zoom In** tool and then click on the page, the scale is doubled and the view is centered on the place where you clicked.

As the ends of the connection leads in this example do not lie on grid points, you must switch off *Snap to Grid* and activate *Snap to Object Points*.



When you have done this, you can open the Glue Points toolbar with the **Insert Glue Point** icon  on the Drawing toolbar or using **View > Toolbars** from the menu bar.



Figure 220: The Glue Points toolbar

Select the block on which you want to insert a glue point. Click the **Insert Glue**

Point icon . It is now activated and appears with a different background. The mouse cursor changes to a small cross and you can set the first glue point. Click the mouse at the desired location. If the point is not exactly where you want it, move it by dragging with the mouse.

When you are satisfied with the location, click on the Glue Points toolbar the icon with the exit direction you want (left, right, top or bottom). The selected icon now has a different (lighter or darker) background. Set the exit direction of the input connection leads to the left and the output leads to the right.

When you have set a glue point at the end of each gate's connection lead, you can copy it into the Gallery.

Copying individual pictures to the Gallery

The Gallery is a very convenient way of controlling building blocks for drawings. It also functions as a symbol library.

First open the Gallery using **Tools > Gallery** or by clicking on the  icon if it is present in one of the toolbars.

The Gallery appears above the drawing page. The left pane shows the folders available for use and the right pane shows the images contained in the current folder. Choose an image by clicking on it; additional information about the image appears in the header bar.

In the left pane, click the *New Theme* button to create a new folder. A new window opens. Click on the *General* tab and give the new theme a meaningful name (for example *Logic*) to replace the default of *New Theme*. You can rename a theme by right-clicking it in the folders pane on the left.

To import existing images into the Gallery, click on the *Files* tab and then on the *Find Files...* button. It is possible to bring in complete folders or individual files; the procedure is self-evident from the dialog windows that open, or see Chapter 14 (Working with the Gallery) in the *Getting Started* guide.

You can drag and drop Draw objects straight into the Gallery. (The Properties window can be closed after typing in the name.) First select the destination folder, then click on the first symbol that you wish to add to the Gallery. Position the mouse cursor

inside the selection frame of the symbol. When the crossed arrows are visible, click on the symbol and keep the mouse button pressed. After about 1 or 2 seconds the cursor will briefly blink and change to the drag symbol. Drag the object into the Gallery and release the mouse button. When you move the mouse into the Gallery field, the cursor shape changes once more (see Figure 221).

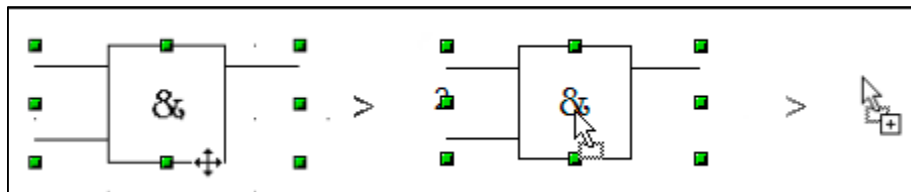

Figure 221: Crossed arrows > Drag symbol > Gallery symbol

Tip

Zoom in on very small graphics before you try to move them so that the crossed arrow symbol can be clearly seen.

When you have placed all the symbols in the Gallery they can be titled. Right-click on a symbol, choose **Title** from the menu and type the symbol name (AND, OR).

The symbol library is available to all OOo modules, for all users who have the permission/rights to access it. Making the drawing collection available as a Draw file is the simplest way to distribute a symbol library to other users. After opening the drawing, other users can easily transfer the drawing objects into their own Gallery, as described above.

Drawing a logic circuit diagram using the Gallery

The use of the symbol library which you have created and placed in the Gallery can be illustrated by using the blocks to draw a *half adder* (see http://en.wikipedia.org/wiki/Half_adder#Half_adder). You can precisely place all the drawing objects with the help of Draw's snap functions. The following instructions are only one way to achieve this objective.

Begin with a new drawing. Set the unit of measurement to centimeter, a grid point spacing of 0.5 cm and subdivision of 4 points. Activate the grid, guiding lines, and associated snap functions.

In the first part of the exercise you should draw only the two signal leads *a* and *b*, the two INVERTER gates and the two AND gates.

Begin by drawing the two signal leads. To make it a bit easier, you can use the values in the following table.

	Start point	Length
Signal wire a	X = 2 cm / Y = 3.0 cm	5.5 cm
Signal wire b	X = 3 cm / Y = 3.0 cm	5.5 cm

After drawing the two signal leads, you begin the hardest part. With grouped objects the snap function works only on points on the outside contours. The only way to work with these blocks as a unit, however, is as a grouped object. The input and output leads must lie precisely on grid points if the connecting lines are to be exactly horizontal or vertical.

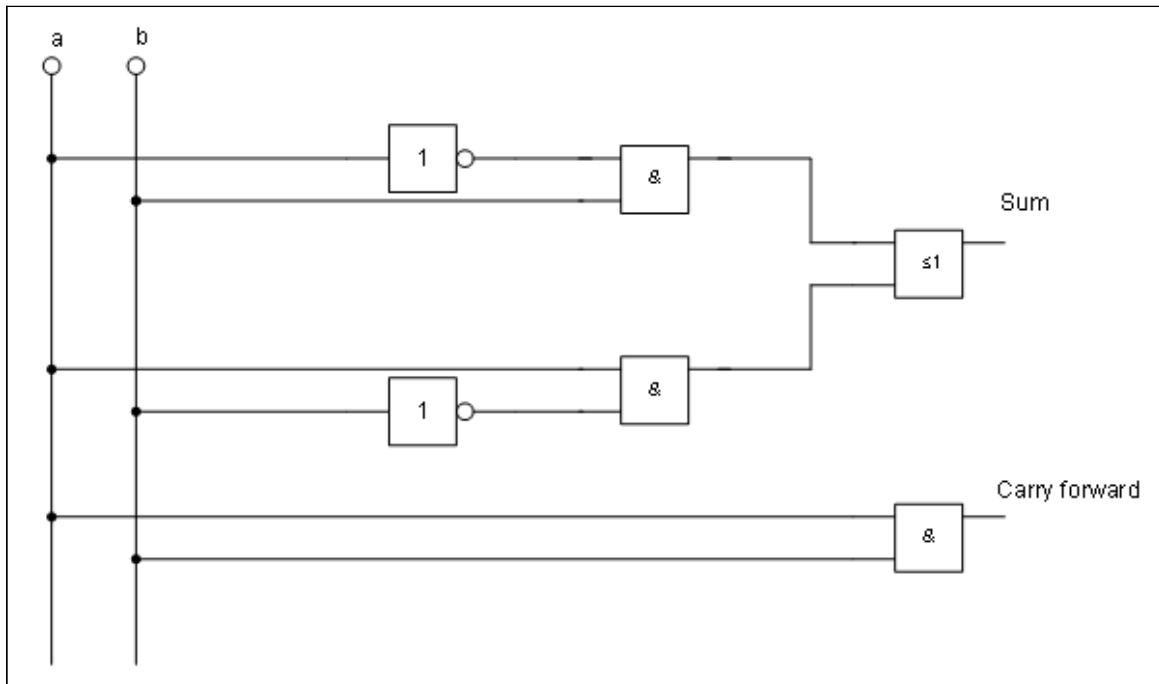

Figure 222: Half adder drawn using logic symbol building blocks

Position two horizontal guiding lines (A, B) on the grid with $Y=4.0$ cm and $Y=6.0$ cm. With *Snap to Grid* active, this should be no problem. With an INVERTER gate the input and output leads lie in the middle of the block, 4 mm below the upper edge. In order that the input and output are docked to the guiding line, the upper edges of the INVERTER gate must be positioned (for a 5 mm grid spacing) at $Y=4.1$ cm and $Y=6.1$ cm. Right-click on the guiding line, select **Edit guiding line** from the context menu and set the guiding lines to 4.1 cm and 6.1 cm.

In order that the blocks lie exactly underneath each other, insert vertical guiding lines at $X=5.0$ cm (INVERTER gate) and $X=8.0$ cm (AND gate).

Now open the Gallery and drag the Inverter gate into approximately 0.64, the position desired. If the function *Snap to guiding line* is still active, you will be able to accurately position both blocks in the correct location. Your diagram should now look like Figure 223.

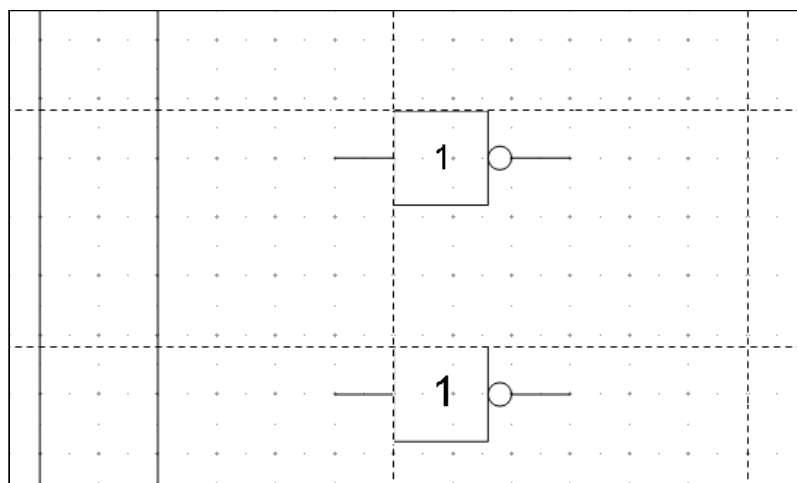

Figure 223: Drawing a half adder - Step 1

The input and output leads of the INVERTER lie at Y=4.5 cm and Y=6.5 cm. Move the mouse over a guiding line. When the mouse cursor changes to a double arrow, drag the guiding line (with the left mouse button pressed) onto the input and output leads of the block. If the grid snap is still active, this should be exactly positioned without much effort.

The leads of the AND gate lie 1.5 mm below the upper edges of the two horizontal guiding lines. They must be moved up for the next step. The Y coordinates are reduced to 4.35 cm and 6.35 cm (the top edges of the AND gates). When you have moved the lines, you can drag both AND gates from the Gallery and position them. Your drawing should now resemble that in Figure 224.

Next drag the horizontal guiding lines again over the input and output of the gates (Y=4.5/6.5 cm), so that when you position the connection point of the leads (a small black circle) it will sit exactly on top of the leads from the gates.

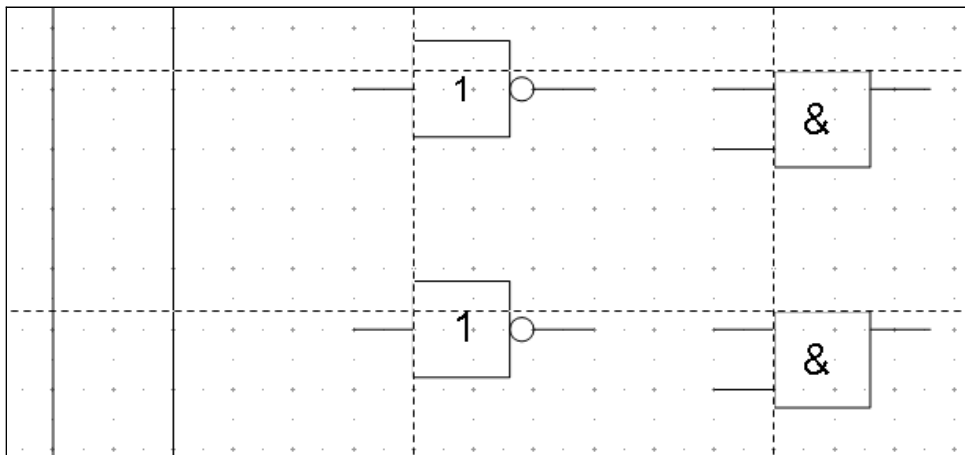

Figure 224: Drawing a half adder - Step 2

To position the two last gates, you need to set the following additional guiding lines: a vertical line with X=11 cm and two horizontal lines (C,D) at Y=5.5 cm and Y=7.5 cm respectively. Shift the horizontal lines C and D each 1.5mm upwards (so that Y=5.35 cm and Y=7.35 cm).

Drag the OR and the last AND gate from the gallery and position them as in Figure 225.

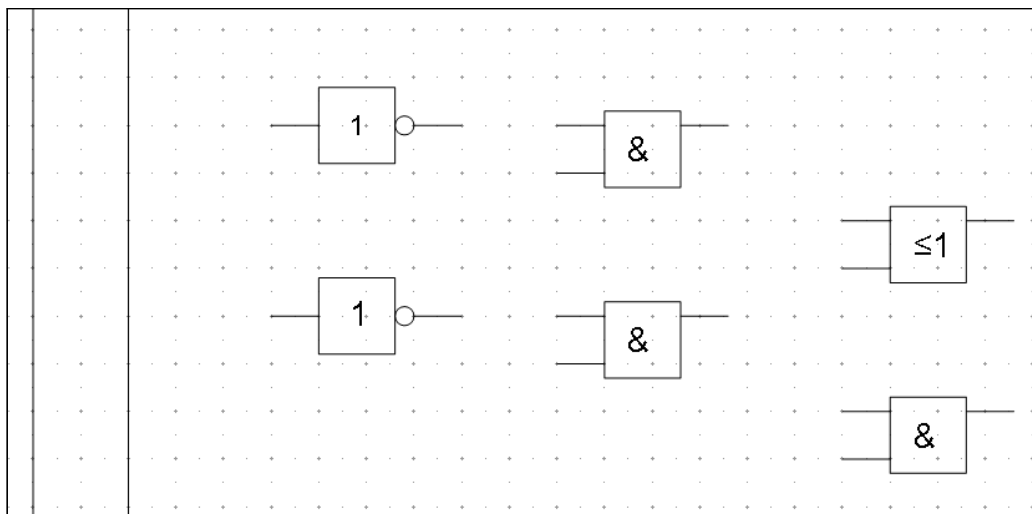

Figure 225: Drawing a half adder - Step 3

Since the OR gate will be connected to the two previously positioned AND gates, you can delete the guiding line of the OR gate. Drag the 0.64 horizontal guiding lines C and D over the inputs of the AND gates (Y=7.0 and 7.5 cm) and put two other lines (E,F) on the remaining connections (Y=5.0 and 8.0 cm) as shown in Figure 226.

Deactivate all snap functions except *Snap to grid*. It is a good idea to zoom in so that you can place the lead connections exactly over the intersection points. Drag the connections singly from the Gallery to where you want to position them. You will need to adjust their position with the mouse. The easiest way is to move the connection diagonally to the desired location (see Figure 227).

The guiding lines are no longer needed and can be hidden (it is better to wait until you have finished the drawing before you delete them). Your drawing should now start to look like Figure 226.

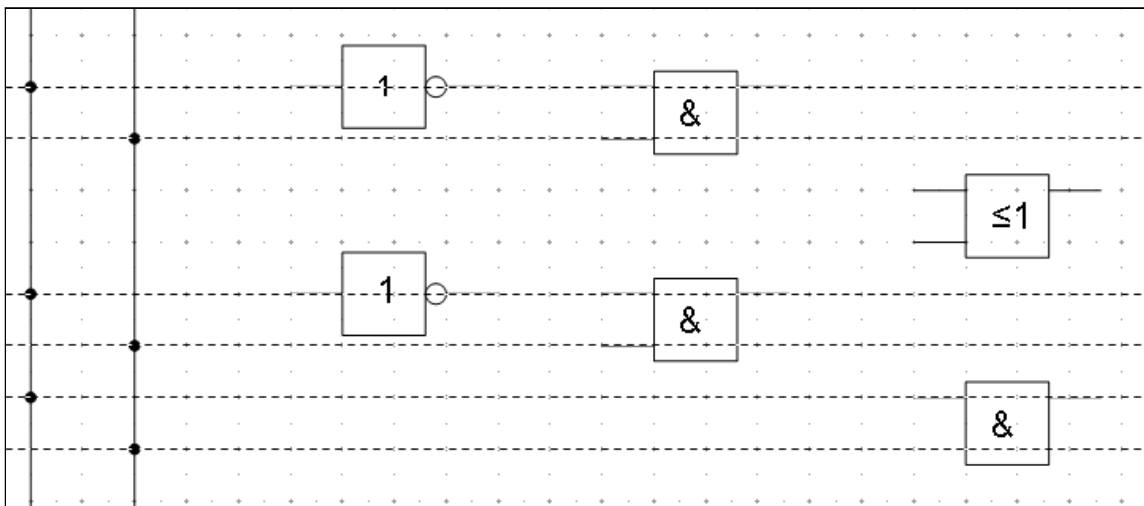



Figure 226: Drawing a half adder - Step 4

The individual blocks must now be joined up so that the gates function as a half adder system. To do this, you use connectors. Open the Connector toolbar. Use the standard connector  to join the OR to the two AND gates. All the other leads run horizontally and you can use the direct connector .

When all six lead connections have been positioned, both signal wires should have a small black circle added to their connection points. You can use the symbol for NOT from the Gallery as the basis for this.

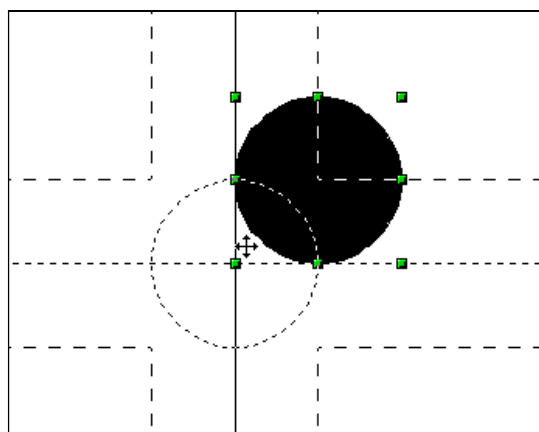

Figure 227: Setting the connections

If you have correctly positioned the symbols in the drawing, all the connection leads will be straight lines. At this time you can delete all the guiding lines, add text to the drawing and your finished drawing should resemble Figure 222 on page 177.

Dimensioning a drawing

Configuring the dimensioning style

As is usual with Draw, you configure dimensioning using a style.

After opening a drawing, press *F11* to access the Styles and Formatting window. In the Graphic Styles list, right-click on the style Dimension Line and select **Modify**. The dialog that opens contains the current settings. Click the Dimensioning tab (Figure 228).

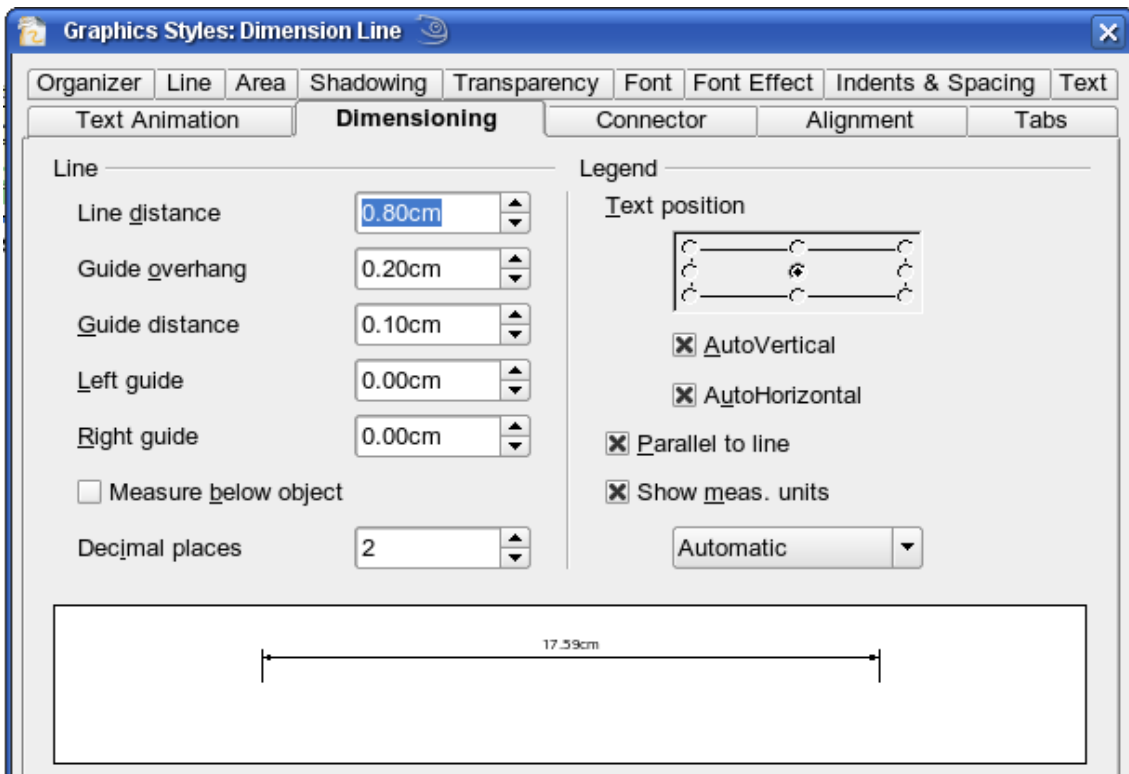

Figure 228: Configuring dimension lines

You can configure all the properties you see in this window to suit your own needs. The left section includes the basic settings for dimension lines and dimension guide lines (these indicate where on the object the dimension is referenced):

- Line distance: the distance of the dimension arrow from the object edge
- Guide overhang: the distance the guide line extends past the arrow
- Guide distance: the distance of the guide line from the object edge

You can individually set the line lengths of the right and left guide lines and use positive or negative values to have the line above or below the reference point. The direction of the line with positive or negative distances depends on the setting of the **Measure below object** option (box checked or not), but this is easy to check by referring to the example dimension line in the bottom window of the dialog. For this current exercise click the box and activate this option.

In the right section you can change the settings for the Legend, the text of the dimension line. You can use the Text position choices to change the location of the text - but only if one or both of the AutoVertical and AutoHorizontal checkboxes are unchecked. Use the various options on the Text and Alignment tabs to further change the text format.

Calculation of dimensions always takes into account the scale and dimension units contained in **Tools > Options > Draw > General**. If you set a scale of 1:10 and a unit of centimeter, then a 6 cm long object in the drawing will be shown with a dimension of 60 cm when the option Show meas. unit is activated and the selection window is set to Automatic. Deselecting this option turns off the display of units. You can change the units displayed from Centimeters to (for example) Millimeters by choosing Millimeter instead of Automatic in the selection window.

Adjust the font type and size for the text of a dimension line by means of the Text tab.

The **Standard** button at the bottom of the dialog sets all the properties of the dimension line to the (inherited) standard properties of the style.

Note

The dimensioning style Dimension Line is always linked and stored with the current work page. All the changes that you make apply only to this page. New drawings are started with the standard properties of Draw. If you want to use the amended style for future drawings, save the page as an additional template.

Dimensioning objects

In this exercise you will dimension some logic blocks (see Figure 229). They are used here to demonstrate the technique; you can use your own drawing or fetch a picture from the Gallery.

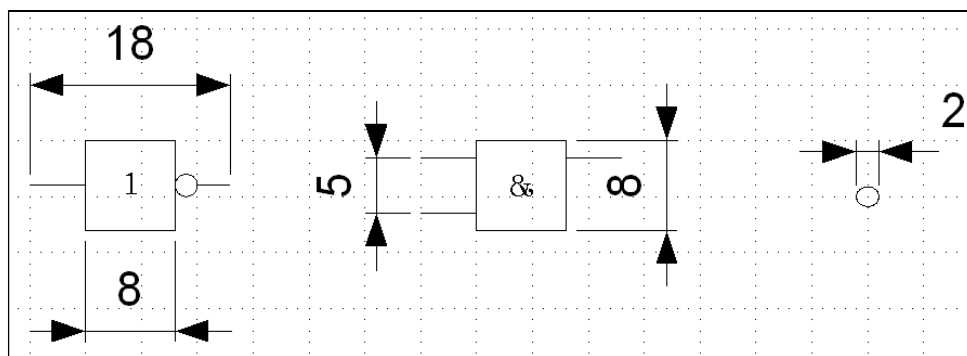



Figure 229: Dimensioned logic blocks

So that Draw can clearly recognize the edges to be measured, you should set a number of guide lines delineating the edges. The previous sections explain how to do this. To place the guide lines exactly and easily, change the resolution of the Grid. Suitable values for this work are a resolution of 5 mm and a subdivision of 4 points. With this setting you should have a snap to grid function with 1 mm point separation.

We will begin by dimensioning the NOT gate. For this block we want the total width (18 mm) and the width of the block itself (8 mm) to have dimension lines. The first step is to add guide lines to delimit the dimension lines. With *Snap to grid* activated, you can position these quite accurately (see Figure 230a). Be sure that the function *Snap to guide lines* is active and zoom in to the part of the block to be dimensioned. The block should *not* be selected.

Start the dimensioning command by clicking the **Dimension Line** icon  on the Arrows toolbar. This toolbar is not visible by default. The dimension line is placed automatically on the Dimension Lines layer so that you can hide dimension lines if you wish.

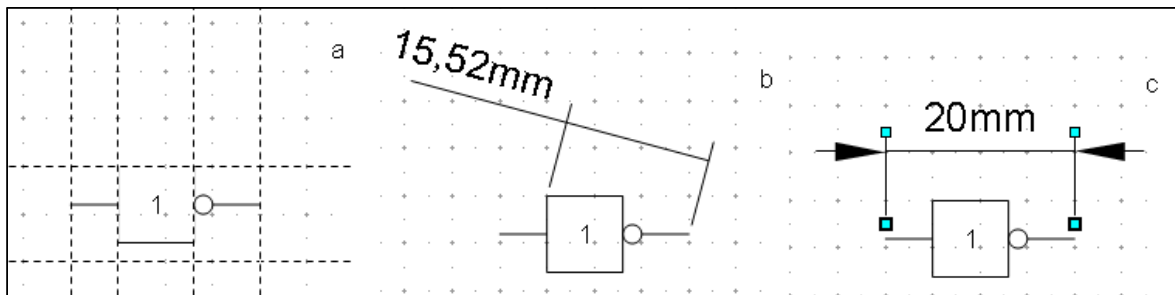

Figure 230: a) Delimiting the edges with guide lines
 b) Dragging the dimension line (anticlockwise)
 c) Finished dimension line

After clicking the Dimension Line icon, the mouse cursor changes into a small cross. As we activated the option *Dimension Line - Measure below Object*, the dimensioning should be made in a counterclockwise direction. Place the mouse cursor at the left dimensioning point. Press the left mouse button and drag the mouse to the right dimensioning point. Release the mouse button. If you press the *Shift* key while dragging the mouse, you will restrain the dimensioning line in a horizontal (or vertical) direction (see Figure 230b).

In the same way you can draw a vertical dimension line on the AND gate. The dimensioning of the NEGATION symbol should also be simple to accomplish, but it is important that for such small components you zoom in enough to accurately position the lines.

Editing dimension lines

Dimension lines can be subsequently edited. You can select single dimension lines which are displayed with four handles, located at the end of the dimension lines (Figure 231).

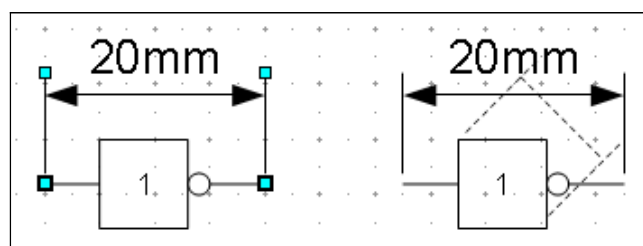

Figure 231: Editing dimension lines

With the upper handles you can (only) change the length of the guide lines. With the lower handles you can move the points that are being dimensioned. If you select the dimension text, you can edit the font type and size as well as changing the dimension units of the text.

If you only want to edit the text of the dimension, double-click on an unselected dimension line to enter text edit mode.

All the changes that you make relate only to the selected dimension line. They are stored and persistent, but do not affect the settings of the Dimension Line style. If you insert other dimension lines, they will have the settings contained in the style.

If you want to make general setting changes to the Dimension Lines style, change the appropriate style. As soon as you confirm the changes with **OK**, the new settings will be applied to *all* dimension lines.

Working with text in Draw

You can use text in Draw in various ways:

- as a text element
- as text associated with a picture
- as an element out of the Fontwork gallery
- as a Writer OLE object

Configuring text elements with styles

Text, like all drawing objects, can be associated with styles. The text settings in styles always affect the whole text element. You can format individual parts of a text element, but only by using manual formatting, which is not related at all to styles and templates. Styles for characters and paragraphs do not exist in Draw.

Open the Styles and Formatting dialog by pressing *F11*. Access the formatting dialogs using the toolbar icons, the context menu, or the Format menu.

The Indents and Spacing, Text, Text effects, Tabs and Alignment tabs of the style dialog function the same way as in text documents, although some options are not available in Draw. Specific to drawing objects are the tabs Text and Text Animation.

Text animation

On the Text Animation tab, you can set how the text moves within the object frame. Such effects are interesting mainly for documents that are to be shown on the screen. They are therefore more commonly used in the Impress module. For printed text they do not make any real sense and are not dealt with further in this guide.

Text

On the Text tab, you can determine the behavior of the text block in relation to the border of the drawing object. The same settings can be altered—as manual formatting—under the **Text...** command in the **Format** menu or in the context menu.

The type of drawing object determines which settings are active and what effect they have on the text. Shapes behave differently to other drawing objects. To experiment with the settings, use objects with rounded edges so that differences in spacing and alignment show up better.

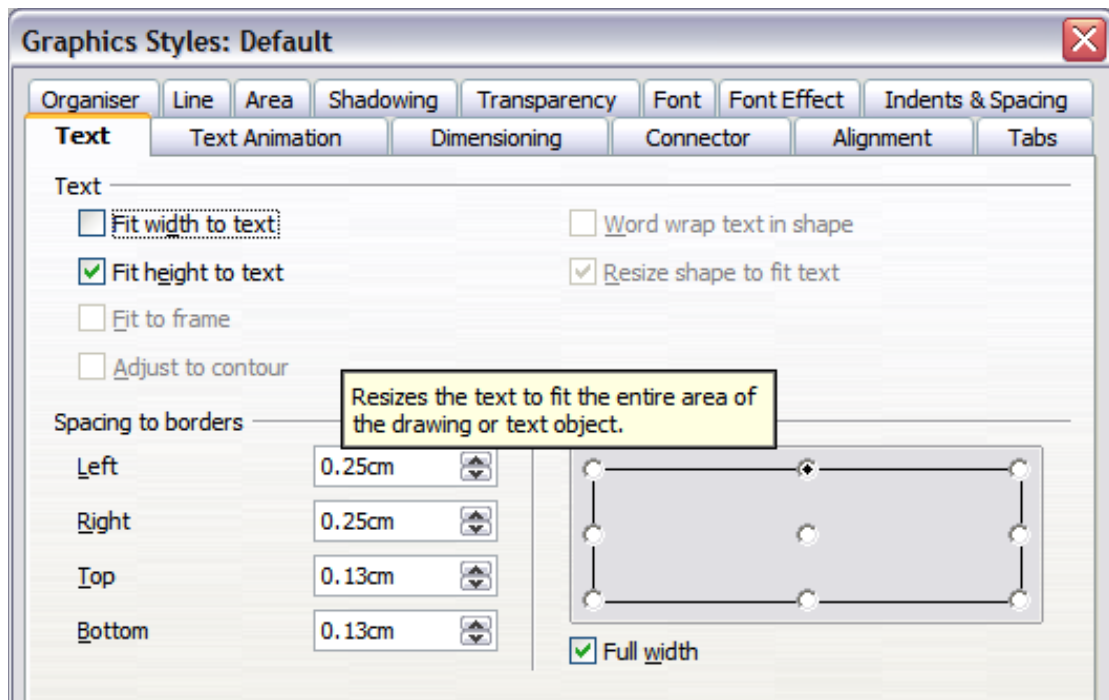



Figure 232: Text tab of Graphic Styles dialog

Anchoring text

To try out the different settings possible for text anchors, start by drawing an ellipse from the Drawing or Basic Shapes toolbars , change into Text edit mode by double-clicking on the ellipse and write several (not too long) lines of text. Repeat with an ellipse from the Circles and Ovals toolbar (a classical drawing object). This toolbar is not available by default; you must customize the Drawing toolbar to add it.

Note

To tell whether you have selected a basic shape or a classical drawing object, look in the left hand side of the status bar; you will see either *Ellipse selected* (Classical object) or *Shape selected* (Basic Shape).

In the *Text* tab of the Edit Style dialog, set the values of the *Spacing to Borders* to 0 cm for all four directions.

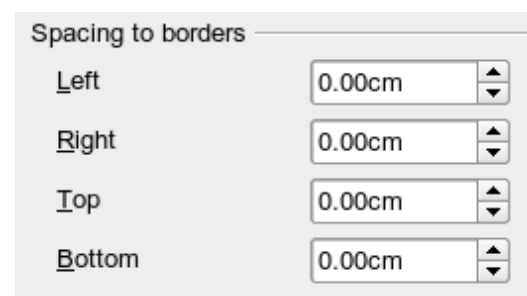

Set Options as Left in the tab Alignment.

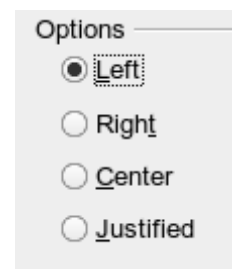

Now we can try out some of the different possibilities of text anchoring.

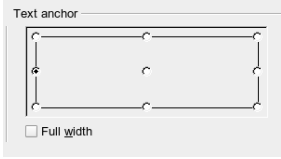
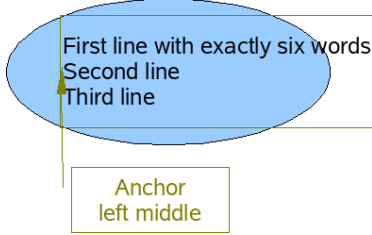
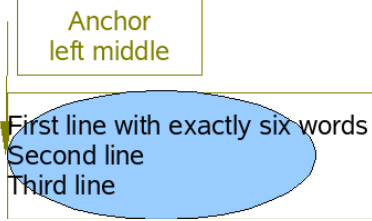
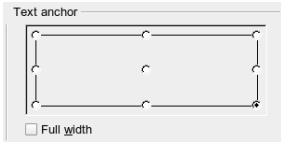
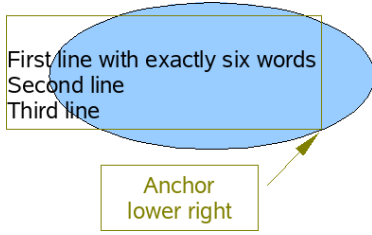
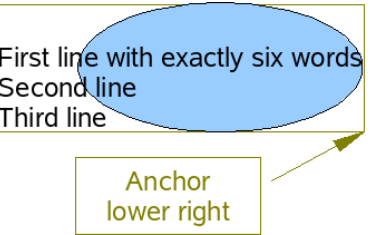
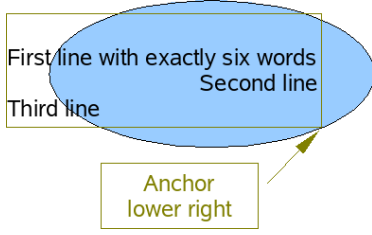
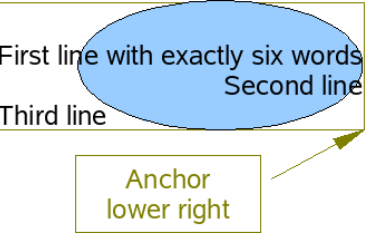
	Shapes	Classical drawing objects
 <p>Text anchored to left middle - the text block is placed on the left side and centered vertically.</p>	 <p>“Left edge” here means the edge of the text frame whose left side fits totally within the figure.</p>	 <p>“Left edge” here means the left side of the object frame - the frame with the green handles which is visible when you click on the object.</p>
 <p>Text anchor to lower right.</p>	 <p>The lower right corner of the text block sits against the edge of the figure.</p>	 <p>The lower right corner of the text block lies in the lower right corner of the (invisible) object frame.</p>
<p>The text anchoring always relates to the entire block, even when single lines are set differently to the other text through manual formatting.</p>		

If you checked the option **Full width**, the text block is always centered horizontally. The area of the text block is maximized; here it extends either to the edge of the figure or object frame or (when not that wide) to the width that is necessary to fit the longest line. The difference becomes clear if you position the text on the *left*, but you set single lines through hand formatting to be aligned on the *right*.

In the examples below, the first line of text was shortened to “First line with”, spacings were set to 0 and text anchor to middle left.

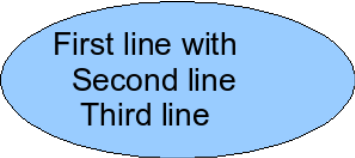
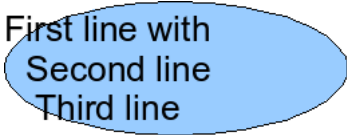
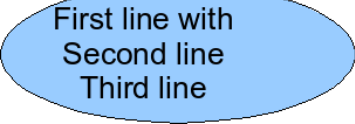
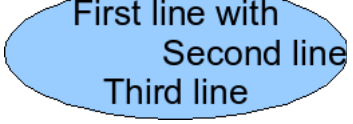
	Shapes	Classical drawing objects
Without option "Full width"		
With option "Full width"		

Fitting text in frames

Here you find that shapes and classic Draw objects behave completely differently. For *shapes* the options on the right are active.

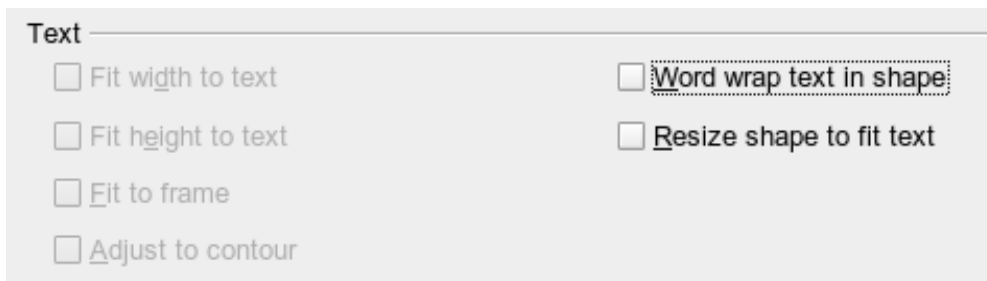
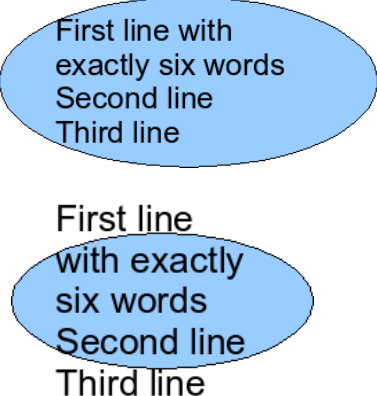
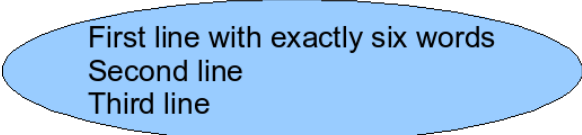
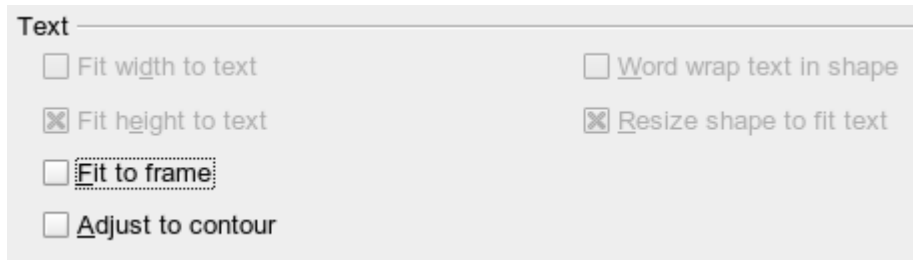

Figure 233: Options active for shapes

These have the following effects.

<p>Word wrap text in shape:</p> 	<p>No automatic hyphenation is available and you cannot insert a fixed hyphen.</p> <p>If the text does not fit within the shape, the overflow appears above or below the shape.</p>
<p>Resize shape to fit text:</p> 	<p>Watch out! If you turn on this option it is not possible to undo the size changes - whether by using the Undo function on the menu or by switching off the option in the dialog.</p>

For the classic *drawing objects*, both lower left options in the dialog are active.





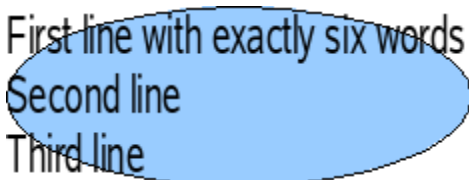
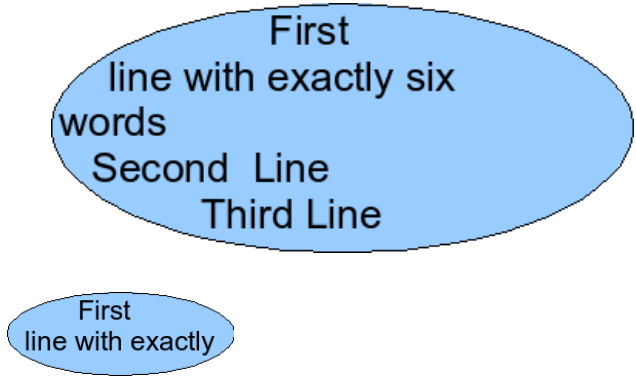

These options have the following effects.

<p>Fit to frame:</p> 	<p>The text is widened and compressed so that it fills out to the object frames.</p>
<p>Adjust to contour:</p> 	<p>All the text is contained within the figure. It is split over several lines if necessary. Any text which does not fit in the figure is not shown, but is still retained.</p> <p>Note that even if you have activated hyphenation, words will be split without regard to the hyphenation rules.</p>

Distance from frame

Spacing settings are added to the text. In this way the text block is invisibly reduced or (with negative values) made bigger.

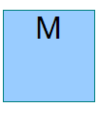
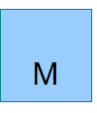
In the examples below, the text (M) is centered horizontally and the text block is anchored in the upper middle part of the frame.

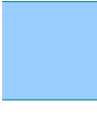
Value for spacing "Above"	-2 cm	-1 cm	0 cm	1 cm	2 cm	3 cm
The behavior is the same for classic drawing objects and shapes.	<p>M</p> 	<p>M</p> 	<p>M</p> 	<p>M</p> 	<p>M</p> 	<p>M</p> 

If you anchor the text above, below, right or left, a positive spacing value positions the text in such a way that it sits close to the outside of the object frame at the anchoring point. Anchoring in the middle does not result in this movement.

It is easier to add text to a straight line if the line is created as a very thin rectangle. Choose an anchor point in the middle of the rectangle and then determine the exact position of the text by setting the spacing accordingly.

Text added to open line types such as *Bézier curves* (curves and freehand lines), *Polylines* (polygon and polygon 45°), and *Arcs* is also positioned in relation to the enclosing object frame. If you want to see the extent of this frame, just click on the object. To add text along one of these lines, you can use the Fontwork tool described on page 191.

Text added as described above is rotated when the object is rotated. The property settings, particularly those dealing with spacing relative to the frame, relate only to situations where the object is not rotated.

Text frames and callouts

To test the range of possible settings, use a text frame or a callout with rounded corners. For text frames, as for rectangles, you can set the rounding in the Position and Size dialog (*Slant & Corner radius*) or in *Points* mode. The latter makes sense only if you have a visible outline. With callouts (as with text frames in *Points* mode), drag the larger handle in the left upper corner with the mouse to give the desired amount of rounding. An example of this is shown in Figure 234.

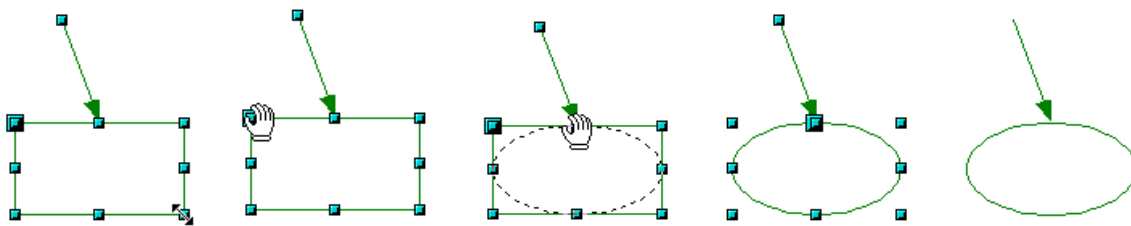



Figure 234: Legend with rounded corners

Unlike drawing objects, text frames and callouts support automatic line breaks and you can switch on automatic hyphenation under **Tools > Language > Hyphenation**.

Non-breaking dashes and protected separators are however not available. For a manual line break, use (as elsewhere) the key combination *Shift+Enter*.

With the text and callout icons ( and ) you can create text frames and callouts with vertical text. You need to activate *Enhanced language support > Enabled for Asian languages* in **Tools > Options > Language Settings > Languages**. Text frames can be rotated like drawing objects, but it is not possible to rotate callouts.

Text frames and callouts do not have a separate text element, but you still use the **Text** dialog to set formatting properties. As soon as you have input text, the upper three settings on the left side become active (Figure 235). The settings for Spacing to Borders and Text anchors in the lower window area function in a similar manner to normal drawing objects and are not dealt with further here.

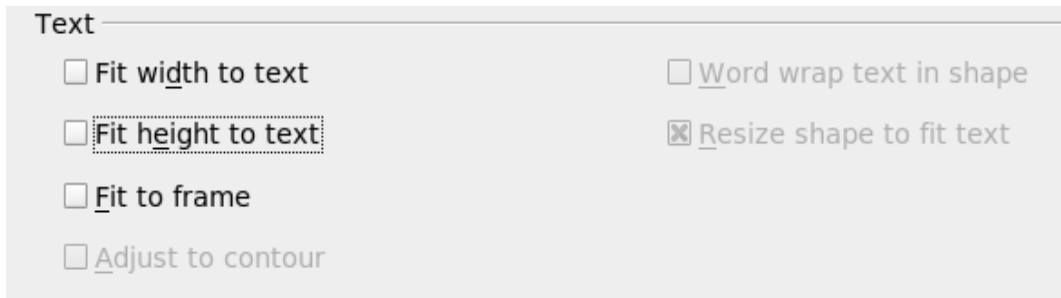

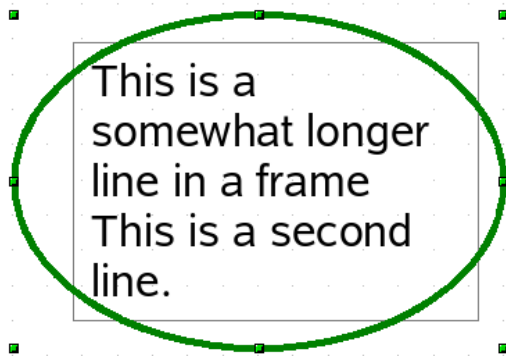

Figure 235: Text options active for text frames and callouts

<p>All options off</p>	<p>In versions of Draw before 3.2, the text is broken at the object frame. You do not see text that does not fit within the object frame. It is still available and if you enlarge the object it will be visible.</p> <p>In versions 3.2 and later, the breaking of the text at the frame border does not appear to function (this is probably a bug). If you double-click the frame to edit the text, it appears to be truncated but exiting text mode returns the original view.</p> <p>As with normal drawing objects, the text positioning relates not to the figure itself but to the object frame. Observe that the text frame in the example on the left extends outside the ellipse.</p>
<p>Fit width to text</p>	<p>The width of the text frame or callout is enlarged so that the longest line fits, without a line break, inside the object frame.</p> <p>A previously inserted manual line break (here after the word “longer”) remains in effect.</p>
<p>Fit to frame</p>	<p>The text is widened or compressed so it fits within the entire object frame. This effect is the same as with normal drawing objects.</p> <p>With the symbols  and  you can produce a text frame that has this property already set.</p>

Fit height to text



The height of the text frame or callout is enlarged so that all lines fit within the height of the object frame.

Pictures and text

Pictures also possess a text element. You can use this text element to place lettering over the picture or to give the picture a caption. To format this text, proceed in the same way as for a normal rectangle. Usually you produce text as a separate object and then group it with the picture, because this gives you more flexibility.

Here are two examples showing what is technically possible with text elements.



tab: *Font*, Comic Sans MS, Bold, 40pt
tab: *Font Effect*, color white, with shadows
tab: *Alignment*, Options Right
tab: *Text*, Text anchor “upper right” and
Spacing to borders right 0.5 cm, top
0.5 cm, others 0.0 cm



Where the mountains meet the sea,
empty beaches invite long walks

tab: *Font*, Bitstream Vera Serif, 14pt
tab: *Alignment*, Options Left
tab: *Text*, Text anchor “lower left” and
Spacing to borders bottom -1.3 cm
Note: the line break after the word “sea,”
was inserted manually.

The construction of each example was carried out using a graphics style. Right-click on the picture and choose **Edit Style** to open the Graphics Styles dialog (Figure 232). You may first wish to choose a different style to edit for the picture, or create a new style for a special purpose. For more about styles, see Chapter 4 (Changing Object Attributes).

If you store the picture using **File > Export**, the text is exported along with the graphic. If you use the context menu option **Save as Picture**, then the text is not exported.

Fontwork Gallery

Click the icon  to open the Fontwork Gallery (Figure 236) which you can use to insert an eye-catching caption to an image. Fontwork drawing objects belong to the *shape* category. The Gallery contains a selection of popular text forms.

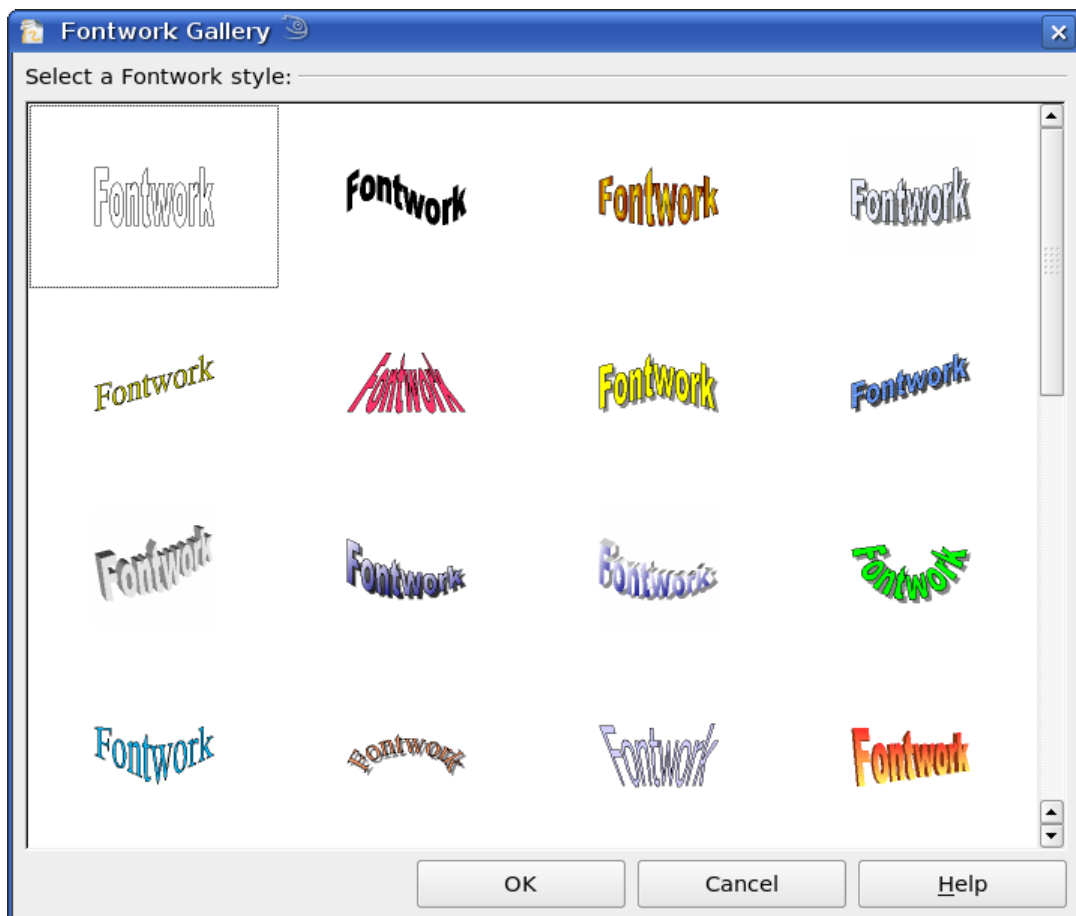

Figure 236: The Fontwork Gallery

You are not limited to these samples; you can subsequently edit and customize the chosen caption type. Proceed as follows.

Choose a caption type from the Gallery and click **OK**. The caption is then inserted into the middle of your document.

Use the green handles to drag and resize the caption.



Double-click to enter text editing mode and replace the placeholder text “Fontwork” with your own text.

Click outside the object or press the *Esc* key to leave editing mode.

With the Area dialog from the **Format** menu or the context menu, you can set fill and shadow properties. Use the Line dialog to set a frame around the lettering.

For further adjustments use the *Fontwork* toolbar. If this does not open automatically turn it on with **View > Toolbars > Fontwork**.

The symbol on the far left is already familiar. It opens the Fontwork Gallery.

Use the small triangle on the symbol  to open the tear-off Fontwork Shape toolbar and choose a shape for the frame of your caption.

Use the yellow handle to modify the form of the caption.

With the other icons you can further customize the text direction and spacings.

To change the font type of the caption, use (as for other text) the dialog from the **Format > Character** menu or the context menu.

To give the text a 3D appearance, refer to the relevant section in Chapter 7 (Working with 3D Objects).

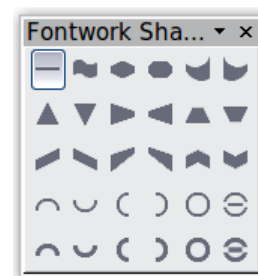
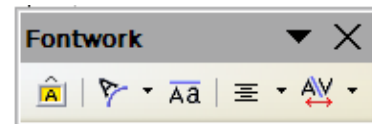
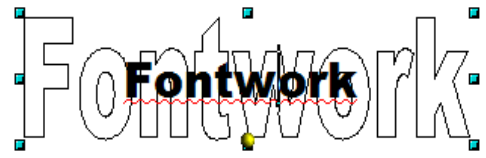

Writer OLE object

In some cases, text frames are not flexible enough to meet your needs and offer too few possibilities for adjustment. For example, you may want to show a figure in Draw in exactly the form it was created in Writer. The best solution might be to insert an OLE object. This means that the object is linked or connected to the application that created it. Draw makes available to other applications (only) one viewing window. The object itself is not edited in Draw but in the other application.

Insert

Use **Insert > Object > OLE Object** to open the dialog as shown in Figure 237. Use the **Create new** option to embed the OLE object in the Draw document. With the **Create from file** option, you can choose whether the object should be embedded or linked. With a linked file any change in the stored file will be shown in Draw and conversely: any change you make in Draw will be stored in the file on disk.

If you have decided to embed the object you can still create an independent text document from the OLE object. For this use the **Save Copy as** command from the context menu.

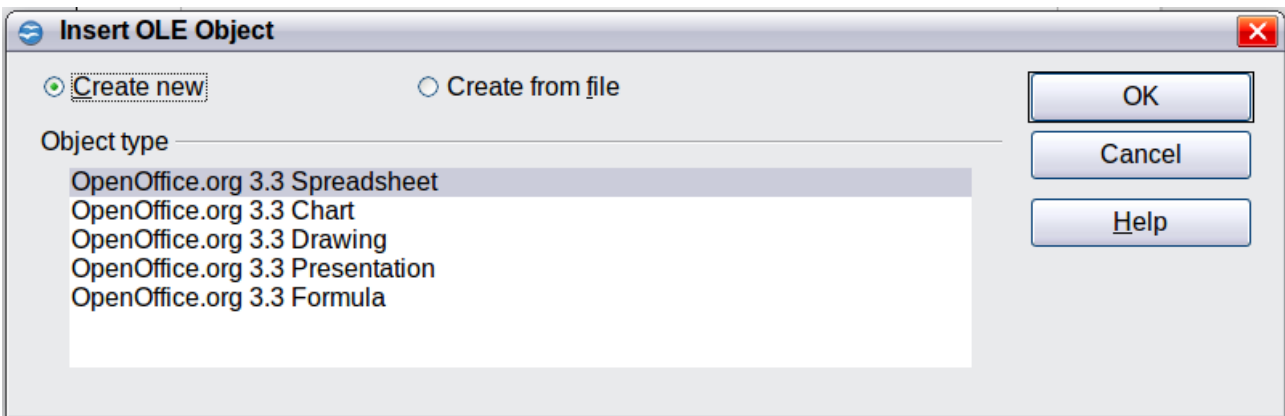

Figure 237: Inserting an OLE Object

Editing mode

As soon as you click on **OK**, the object is created and opens in editing mode. You can recognize this mode by the gray frame around the object and the small black handles.

Take special note of the toolbars. These are no longer those of the Draw module but of the Writer module. Input the text and format it almost the same as if you were in Writer itself. You now have available all the format styles from Writer.

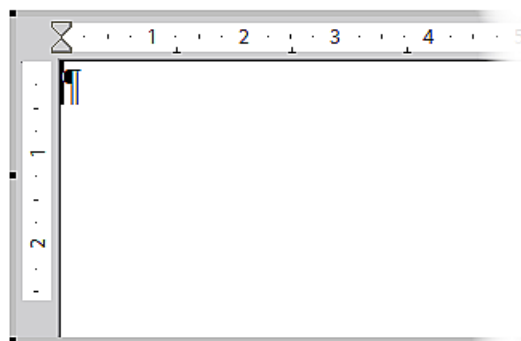

Figure 238: Writer OLE object in editing mode

With the handles of the gray frame you can determine which section of the entire text document is visible. You should switch off the ruler view.

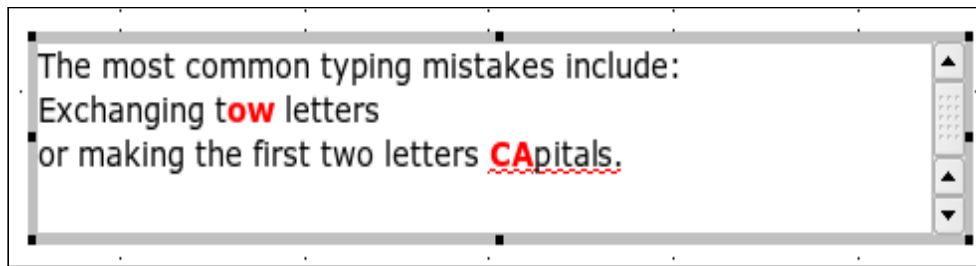

Figure 239: Editing in Writer as an OLE object

Click outside the object to leave editing mode. Double-click on the object or use **Edit > Object > Edit** to change again into editing mode.

In an embedded Writer OLE object, you can connect to further “sub” OLE objects. In current versions of Draw, this is possible only if you open the embedded object as a standalone object in Writer. Similarly you cannot edit a linked Writer “sub” OLE object directly in Draw; you must open it as a text document in Writer. This limitation can be illustrated by the use of formulas. Such formulas are technically OLE objects that belong to the Math module. To use mathematical formulas inside flowing text, save the text in a separate text document and insert it as a linked OLE object in Draw. Inserting graphics from a file is however possible within the OLE environment in Writer.

Object mode

Click on an object to enter object mode, recognizable by the presence of the green handles. In object mode you remain in the Draw module.

Possibly you noticed that in edit mode there is no Zoom. Set the size of the OLE object on the Draw page in Object mode from the Position and Size dialog. In the left-hand image of Figure 240 the object was inserted at the original size, in the right-hand image the size was reduced. If you change the size, take care that the option **Keep ratio** is checked or else the object will become distorted. Line and Area properties are not available for OLE objects, nor is it possible to rotate objects as with text frames.

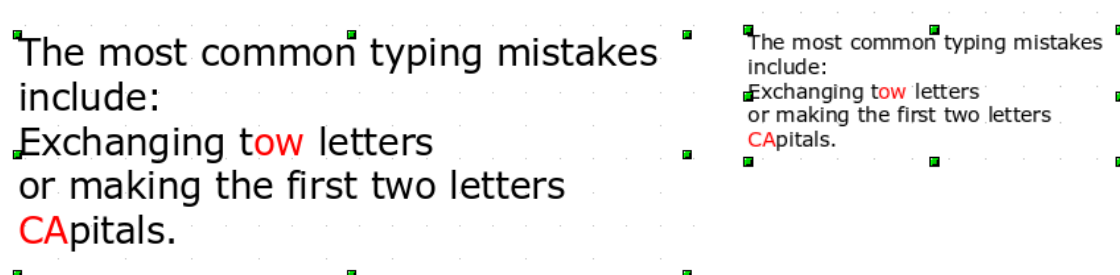

Figure 240: Zoom vs resizing of an OLE Writer object

OLE objects can be overlaid just like other drawing objects. In Figure 241 a drawing object from the basic shapes menu has been placed behind the OLE object.

The most common typing mistakes include:
Exchanging **to**w letters
or making the first two letters
CApitals.

Figure 241: Draw object behind an OLE object

The page with the text document has the background property set to *transparent*. If you change the background color of the OLE object in Edit mode, it will also show in the Draw document.

The **Format** menu has the entries *Area* and *Line* grayed out because they are not usable, but the menu entries *Paragraph*, *Character*, *Text*, and *Bullets and Numbering* are all available. These relate not to the text object which you are currently editing but rather to a separate independent text element within the object, which you can open by pressing *F2*. (This is similar to the way that pictures are linked with an OLE object.) The double-click, which opens the text element in images, does not work here because it puts you into the OLE object's edit mode. Whether it makes sense to use a text element within text like this is questionable!

Guide to Bézier curves

Bézier curves—what are they?

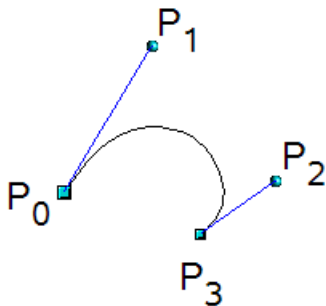



OpenOffice.org uses cubic Bézier curves. A curve is defined by means of a start point P_0 , an end point P_3 , and two control points P_1 and P_2 (see the figure at left). For points on the curve the terms *nodes* or *anchors* are often used.

For the mathematical background of Bézier curves, see http://en.wikipedia.org/wiki/Bezier_curve.

Bézier curves are very useful for experimenting with the shape and form of curves. In point mode you can change the curve alignment by dragging the points with the mouse. The curve leaves the starting point P_0 in the direction of the control point P_1 and arrives at the end point P_3 from the direction of the control point P_2 . These directions are shown in Draw by blue lines. The more distant a control is from its starting or end point the smaller the curvature at that point. If a control point lies directly on one of these points, it has no influence on the curve.

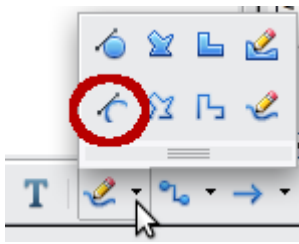
Direct drawing of a Bézier curve



Open the *Curve* toolbar by clicking on the small black triangle of the  symbol on the *Drawing* toolbar. Click on the Curve icon .

The mouse cursor changes to .



Click on the starting point of the curve and keep the mouse button pressed (starting and end points are shown here in the figures as snap points).



Drag the mouse to approximately the position of your first control point. It does not matter if this is not exactly right as you can move the control point location later. If you hold the *Shift* key down while dragging, the control point will lie on a 45 degree grid.

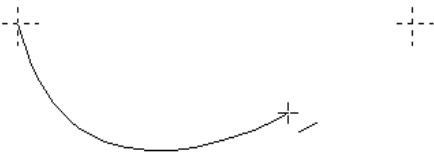

Release the mouse button and move the mouse to the position of the end point of the curve. You can see that the line of the curve follows the movement of the mouse. Double-click at the end position.

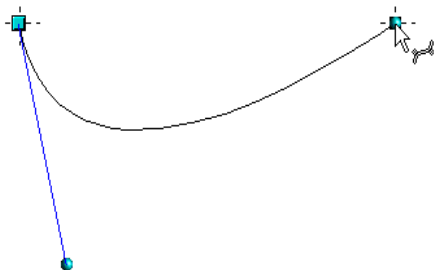



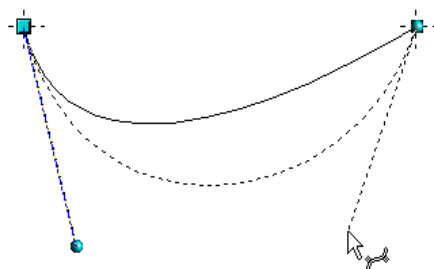

Turn on point mode with the  icon from the *Draw* toolbar.

At the end of the curve you will see not only the end point but also an associated control point, the round handle. Hover the mouse cursor over this point; the cursor shape changes to show that you are in edit mode of a control point. You may have to click on the control point to see this change in behavior (see next section).



Now you can drag the control point to its correct position, if necessary.

Point mode of the Bézier curve

After drawing a curve using the  icon from the Draw toolbar or with the *Edit points* command from the context menu, you can switch to point mode from which you edit individual points on the curve. Points on the curve are shown with a square handle ; the control points with a round handle . The starting point of a curve appears somewhat larger than the other points. When you hover the mouse over a curve point the mouse cursor changes to  - over a control point it changes to . In point mode the toolbar *Edit Points* should appear. If not, turn it on from **View > Toolbars > Edit Points**.

You can switch on the option *All control points in Bézier editor* under **Tools > Options > OpenOffice.orgDraw > View**. The default is to see the control points and guide lines only when a point is marked by clicking on it. By holding the *Shift* key down as you mark, you can select and mark several points at the same time. A marked point is shown a little darker .

Drawing a succession of Bézier curves

Several lines or Bézier curves can be linked together. The single parts are referred to as segments. Technically such a succession of Bézier curves and lines is known as a *path*.

Begin the drawing as with a simple Bézier curve. At the end position of the first segment, end not with a double-click but with one of the following:

- Click on the end point of the first segment but do not keep the mouse button pressed. In this way you produce a curve point which is a control point for both segments. This control point lies, however, on an actual curve point and so does not influence the direction of the following curve segment. Move the mouse to the end position of the second segment. This segment appears to be a straight line but is in fact a Bézier curve. Either double-click to finish the curve or repeat the above procedure to add successive segments.

or

- Go back and click once on the end point of the first segment and keep the mouse button pressed. Now you can drag the initial control point for the second segment into place, as described above. Release the mouse button at the desired position of the control point and move the mouse to the end position of the second segment. The curve follows the line of movement of the mouse.

You can either end the drawing here with a double-click or continue and link in further segments.

To generate a closed curve, select the curve and click on the **Close Bézier** icon  on the Edit Points toolbar, or right-click and select **Close object** from the context menu.

Transition points

For the transition from one segment to the next, there are three different types of points, each with its own properties.

Corner points

This is the only common point between two segments which are otherwise independent of each other. It is likely that the curve has a kink at this point (depending on the angle of the tangents, the lines from the corner point to each control point; see Figure 242).

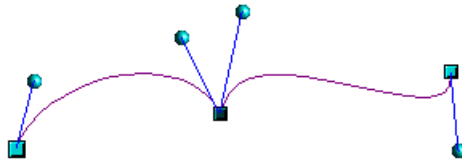

Figure 242: Corner point

Smooth transition points

The tangent lines to the common point have the same angle and form a straight line. If you change the position of one of the control points the other also moves, so that the tangents remain in a straight line. This also applies to the case where a Bézier curve meets a straight line: the tangent line lies on the straight line and cannot be moved sideways.

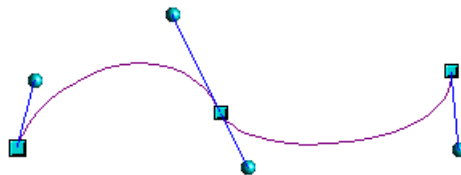

Figure 243: Smooth transition point

Symmetric transition points

In this case the tangents not only lie on a straight line but the distance of the control points from the curve point is the same. The segments have the same direction and the same curvature at the transition point.

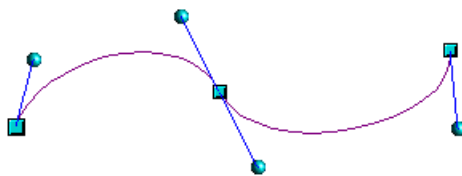

Figure 244: Symmetric transition point

Changing point types

When a point is selected, the *Edit Points* toolbar activates the three corner point icons (circled in the illustration below).



The circled icons are, from left to right, *Corner point*, *Smooth transition*, and *Symmetric transition*. The latter two icons appear the same but you can identify them by looking at the tooltip. At any time only one of the three icons will be active. To change the type of point, click on one of the other two icons.

Note If you cannot see the control point for a segment, try changing the point type from *Corner point* to *Smooth transition* and then back again. This often forces a redraw and you can then see both control points of the common corner point.

Closing the curve

To close an open curve, use **Close object** from the context menu or the **Close Bézier** icon  from the Edit Points toolbar. A straight line is drawn between the start and end points if these points are *Corner points*.

If the start and end points are *Smooth points* or *Symmetric points* and the control point does not lie directly on the curve point, it changes position so it is in a straight line with the line segment and the closing line will be a curve (see Figure 245 for a comparison).

To prevent this happening, change the curve point type before closing to a corner point.

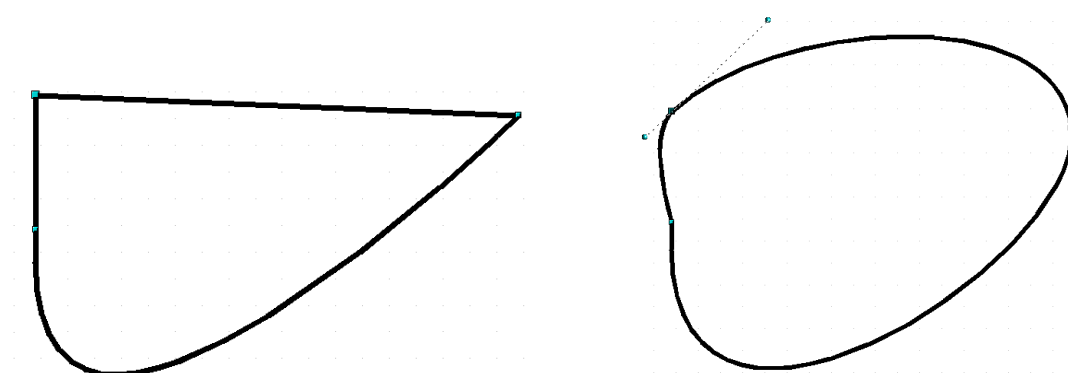



Figure 245: Close curve - start and end points are corner points (left), smooth or symmetric points (right)

Transformation between straight line and Bézier curve

Transform a straight segment into a Bézier curve

Select the larger of the two handles at the ends of the straight line; this will be the starting point of the curve. After a short time the **Convert to curve** icon  on the Edit Points toolbar becomes active. It starts in the “out” position. Click the icon to turn on the function. The straight line is transformed into a Bézier curve. The type of the segment end point remains as it was. Using this function you can convert one side of a polygon or a part of a polyline into a Bézier curve.

Transform a Bézier curve into a straight segment

Select the larger of the two handles at the ends of the curve; this will be the starting point of the straight segment. After a short time the **Convert to curve** icon  on the Edit Points toolbar becomes active. It starts in the “in” position. Click the icon to turn off the function. The Bézier curve segment is transformed into a straight line. The type of the segment end point remains as it was. If all segments are straight lines, Draw converts the object to a polygon or a polyline.

Transform complete curves, polylines and polygons

Transform a polygon or a polyline into a curve

Select the whole polygon or polyline. The object does not need to be in point mode. Choose **Convert to curve** from the context menu or the **Modify** menu. The points in the resulting curve are all of the type *Corner point* and the control points lie on the curve segments. All the segments thus appear as straight lines.

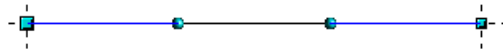

Transform a curve into a polygon or a polyline

Select the whole curve. Choose **Convert to polygon** from the context menu or the **Modify** menu. The curve does not need to be in point mode to do this. The individual segments are not replaced by straight lines. Instead additional points are generated on the curve so that the line of the polygon/polyline matches that of the curve as closely as possible. These points are placed closer together as the curvature increases.

before

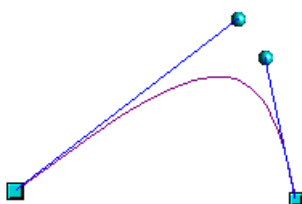

after

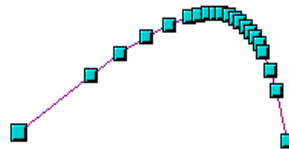

Freehand lines

You can also produce a curved line from a Bézier curve using the freehand line tool . This tool automatically inserts anchor points and control points to render the curve as close as possible to the original Bézier curve.

Place the mouse cursor at the beginning point and keep the mouse button pressed until you reach the end of the curve. As soon as you release the mouse button, the curve is complete.

Normal view

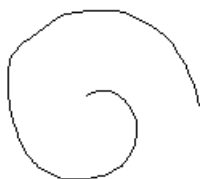

Point mode



Combining closed curves

If you draw a Bézier curve segment and, at the end point of the segment, click and hold the mouse button, followed by a single press of the *Alt* key, the curve is closed with a straight line and you are placed in *Combining* mode. You can now begin a second curve at an arbitrary point. Ending the drawing with a double-click also closes this curve. If you end it with an *Alt-click* as described above, you can draw further curves. The curves that you have just drawn form a common object, a so-called *Combination*. You can use this (for example) to place holes in filled curves.

If you want to bind two curves together into a Combination at some stage, select both curves and use **Modify > Combine**.

Even if you use a Combination, the individual curves are still available as objects. You can use **Modify > Split** to convert the Combination back to single objects.

You can create Combinations only from closed curves. Other objects, such as rectangles or polygons, will be automatically transformed into curves, and curves that are not closed will be closed with a straight line.

Connecting curves

To join curves together, select them and use **Modify > Connect**. A connection is only possible with open curves. If you use this tool on closed curves, they are first opened and an additional end point inserted at the starting point. A straight line is used to connect the curves.

The behavior of connected curves cannot (at present) be modified. It is not obvious in advance how the transition properties of the connected curves are calculated, nor which end points will be connected. It is therefore a good idea to work on a copy and try out the effect with different positions of the end points of the individual curves. To avoid changes to a shape, first set the property of the new connection point to the type *Corner point*.

Adding comments to a drawing

Starting with OOo 3.2, Draw supports comments (formerly called notes) similar to those in Writer and Calc. To insert a comment, choose **Insert > Comment** from the menu bar. A small box containing your initials appears in the upper left-hand corner of the Draw page, with a larger text box beside it. Draw has automatically added your name and the date at the bottom of this text box.

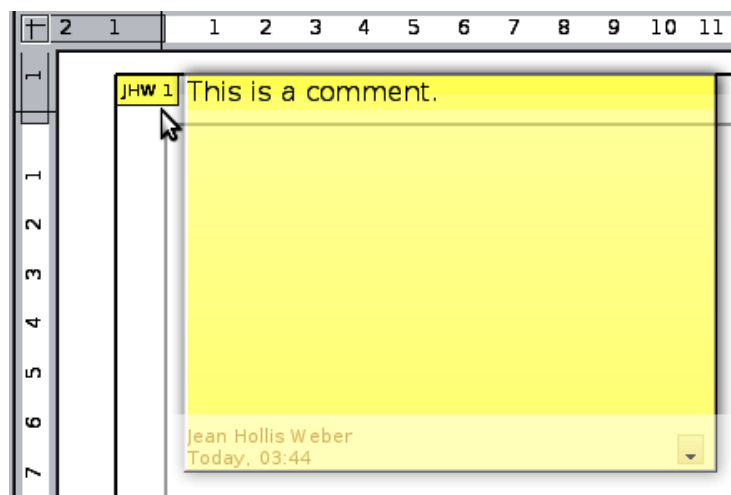

Type or paste your comment into the text box. You can optionally apply some basic formatting to parts of the text by selecting it, right-clicking, and choosing from the pop-up menu. From this menu, you can also delete the current comment, all the comments from the same author, or all the comments in the document.

You can move the small comment markers to anywhere you wish on the page. Typically you might place it on or near an object you refer to in the comment.

To show or hide the comment markers, choose **View > Comments**.

Select **Tools > Options > User Data** to configure the name you want to appear in the Author field of the comment, or to change it.

If more than one person edits the document, each author is automatically allocated a different background color.

Connecting and breaking lines

It is possible in Draw to join separate line elements into one line. Select a number of lines and choose **Modify > Connect**. The lines are converted to curves and adjacent end points are joined together. The resulting shape is a polyline, not a closed shape.

To add text to the polyline, press *F2* and type the text. To make a closed shape from the polyline, right-click the polyline and choose **Close Object**. You can add text and also change area properties and edit the object as with any polygon object. Note that you can only use the Close Object command on connected lines, freehand lines and unfilled curves.

If you select a shape and choose **Modify > Break**, this does not reverse the Connect process but simply converts the polygon into a collection of individual lines. Text added to the shape will be associated with one of the lines (often the last one). You cannot apply a fill to a closed shape made up of lines resulting from the Break command.

Index

3

- 3D bodies 112
 - creating by body rotation 112
 - creating by extrusion 112
 - extrusion 112
 - ready-made objects 113
 - rotating 116
 - segments 121
 - settings 117
- 3D effects
 - geometry 119
 - illumination 126
 - material 131
 - shading 123
 - textures 128
- 3D effects dialog 117
- 3D scenes 114
 - combining objects 134
- 3D settings for 3D shapes
 - 3D color 134
 - depth 133
 - direction 133
 - illumination 134
 - surface 134
- 3D shapes
 - extrusion 114
 - rotating 117

A

- add points 51
- aging filter 100
- aligning objects 85
- Alpha channel 102
- ambient lighting 128
- anchor point 188
- anchoring text 184
- AND gate 172
- arcs 188
- Area dialog 65, 96
- area fill, editing 63
- arranging objects 41
- arrow styles, customizing 60, 61
- arrows 59
- axis intersection point 116

B

- back, send object to 158
- background pages 151
- Basic Shapes toolbar 114
- Bézier curves 49, 188
 - linking 197
 - point mode 197
 - transition points 198
- bitmap fill 68

- bitmaps 64, 89, 94, 109, 128
- black and white printing 109
- booklet printing 20
- borders, editing 57
- breaking links 90
- brightness 96
- bring forward 41
- bring to front 83
- brochure printing 20

C

- CAD (computer-aided design) 172
- callouts 188
- camera field 125
- caption type 191
- central projection 118
- charcoal sketch 100
- close Bézier 53
- CMYK color model 154
- color adjustments 96
- Color bar 13
- color depth 103
- color fill 63
- color inversion 98
- color negative 98
- color options 95
- color palette 13, 153
- color parameters 132
- color picker dialog 155
- colors, number of 106
- combining objects 80
- combining objects in 3D scenes 134
- comments, adding 201
- connectors
 - adding text 168
 - adjusting text 169
 - definition 164
 - drawing 165
- Connectors toolbar 164
- context menu 56
- contoured image 105
- contrast 96
- controls layer 41
- convert
 - to bitmap 109
 - to contoured image 105
 - to polygon 105
- convert polygon to curve 200
- convert straight line to Bézier curve 199
- convert to polygon 200
- corner points 198
- cropping 97
- cross-fading 158
- curve toolbar 196
- curved connectors 165

- curved text 170
- curves 49
 - closing 199
 - combining closed curves 201
 - connecting 201
 - converting to 199
- customizing toolbars 17

D

- delete points 52
- delete unused backgrounds 153
- Dimension Line style 180
- dimension lines
 - editing 182
 - placing 182
- dimensioning 180, 181
- display grid 141
- distance camera parameter 125
- distorting an image 74
- distributing space between objects 86
- dithering 104
- double-sided illumination 123
- Double-Sided tool 121
- dragging and dropping 91
- drawing
 - arcs 31
 - arrows 27
 - banners 35
 - block arrows 34
 - callouts 35
 - circles 29
 - connectors 32
 - curves 31
 - ellipses 29
 - flowcharts 35
 - miscellaneous shapes 34
 - polygons 31
 - rectangles 28
 - squares 28
 - stars 35
 - straight lines 26
 - symbols 34
- drawing to scale 146
- Drawing toolbar 12
- duplicate 157, 160
- dynamic gradients 76
- dynamic size modification 43

E

- e-mailing documents 23
- Edit Points toolbar 50
- editing objects in a group 80
- effects 54, 72, 157
- effects menu 113
- embedding graphics 90
- exchange background page 153
- exporting

- as a raster graphic 93
- as a vector graphic 93
- as PDF 22
- directly as PDF 22
- graphics 92
- to other formats 22

- extrusion 112
- eyedropper 101

F

- fields 152
- file formats 92
- fill color, creating 65
- fill holes 106
- fill properties 63
- fill, editing 63
- filter toolbar 98
- fit width and height 139
- flat normal effect 122
- flat shading 124
- flip an object 73
- floating toolbar 16
- flowchart (flow diagram) 162, 164
- focal length 125
- Fontwork dialog 169
- Fontwork Gallery 115, 191
- freehand line 200
- front, bring object to 158

G

- Gallery 175
- Gamma value 96
- geometry - 3D effects 119
- Glue Point Relative button 167
- glue points 32
 - editing 166
 - Glue Points toolbar 175
 - inserting 166
 - setting 174
- Gouraud shading 124
- gradient fill 64
- gradients 76
 - fill 66
 - transparency 76
- graphic filter toolbar 98
- graphics mode 95
- grayscale 104
- grayscale printing 109
- grid 15
- grid points 140, 141
- grid settings 141, 148
- grouping objects 79
- guide distance 180
- guide lines 15, 145
- guide overhang 180

H

half adder 176
handles 39
hatching 64
hidden objects 40
horizontal distribution of objects 87
HSB color model 155
hyphenation 186, 188

I

illumination color 132
illumination of 3D objects 126
image 64
import filters 89
importing
 Draw objects 91
 Impress objects 91
 scanned images 90
Insert Layer dialog 147
intersecting objects 82
invert colors 98
invert normals 123

L

layer, changing object's 150
layers 146, 152
light source 127
Line and Filling toolbar 12, 56
line connectors 165
Line dialog 96
line distance 180
line pattern 64, 67
line properties 58
line styles, customizing 60
lines, connecting and breaking 202
lines, editing 57
linking 90
Load Slide Design dialog 153
logic circuit diagram 172

M

Master view 152
measure below object 180
merging objects 82
metafile 91, 94, 107
mindmaps 164
mirror copies 73
modifying raster object properties 95
mosaic 101
move points 51
move to front or back 83
multiple pages 150

N

Navigator 92
nesting groups 80
normals 122

O

object specific effect 122
objects
 adjusting size 41
 arranging 41
 dynamic movement 42
 dynamic size modification 43
 editing points 48
 framing 40
 hidden 40
 moving 41
 re-sizing 42, 46
 rotating 44, 47
 selecting 40
 slanting 45
OLE objects
 editing mode 193
 inserting 193
 object mode 194
Options toolbar 14, 39
organization charts 160, 164

P

page backgrounds 151
page margins 9
Pages area 151, 152
pasting from the clipboard 91
path 197
PDF
 export documents to 22
Phong shading 124
Picture (editing) toolbar 95
pictures and text 190
point reduction 106
point types, changing 198
polygon 105
polylines 188, 202
pop-art filter 100
Position and Size dialog 172
positioning objects 83
posterize filter 100
Print dialog 18
print file directly 17
Print options with raster graphics 109
printing
 black and white on color printer 21
 booklet 20
 brochure 20
 general options 18
 grayscale on color printer 21
 multiple pages per sheet 19
 page orientation 18
 selecting what to print 19
projection 130

R

raster graphics 89, 90, 128

- reducing color depth 103
- relief filter 101
- remove noise 99
- removing links to files 90
- renaming objects 95
- RGB colors 96, 154
- rotating 3D objects 116
- rotating an object 44, 72
- rotation angle of 3D bodies 121
- rotation mode 54
- rounding of 3D object 119
- rulers 9

S

- scale drawings 172
- scaled depth of 3D object 120
- segments of 3D bodies 121
- selecting objects 40
- selection mode 39, 40
- send backward 41
- send document as e-mail 23
- send to back 84
- set in circle (perspective) 74
- set to circle (slant) 75
- shading of 3D objects 123
- shadow effect 96
- shadows 65, 69
- shadows of 3D objects 125
- sharpen image 99
- slanting text 169
- Slide Design dialog 152
- slides 150
- smooth image 98
- smooth transition 50, 198
- snap functions 15, 140
- snap lines
 - definition 143
 - editing 144
 - inserting using coordinates 144
 - inserting with mouse 143
- snap points 143
- snap range 142
- snap to grid 141
- snap to object frame 145
- snap to object points 145
- snap to page edge 144
- solarization filter 99
- spacing settings 187
- spacing to borders 168
- special effects 72
- specular color 132
- spherical normal effect 123
- split curve 52
- standard connectors 165
- Standard toolbar 12
- Status bar 10

- straight connectors 165
- styles 71
- subtracting objects 82
- symbol library 176
- symmetric transition 50, 198

T

- tangents 50
- templates 153
- text anchors 168, 184
- text animation 183
- text frames 186
- text in drawings
 - addition to draw objects 37
 - dynamic frames 35
 - fixed frames 36
- text styles 183
- textures of 3D objects 128
- threshold, apply 104
- tile size 106
- tolerance parameter 103
- toolbars 11
 - basic shapes 34
 - block arrows 34
 - callouts 35
 - circles and ovals 30
 - connectors 32
 - curves 31
 - drawing 25
 - Edit Points 49, 50
 - flowcharts 35
 - lines and arrows 27
 - stars and banners 35
 - symbol shapes 34
 - text formatting 36
- transition points 198
- transparency 70, 95, 96, 102, 137

U

- ungrouping 79

V

- vectorize 105, 108
- vertical distribution of objects 87
- vertical text 188

W

- wiring diagram 172
- workplace 8
- Writer OLE object 193

Z

- zoom 11
- Zoom toolbar 140, 175
- zoom value 139