

***User's Manual***

***Laser Terminal PHL 2700***

***Cradle IRU 2700***

CAUTION: This user's manual may be revised or withdrawn at any time without prior notice.

Copyright 2000, Opticon Sensors Europe B.V. All rights reserved.

This manual may not, in whole or in part, be copied, photocopied, reproduced, translated or converted to any electronic or machine readable form without prior written consent of Opticon Sensors Europe.

**Limited warranty and disclaimers**

By opening the package of this product you agree to become bound by the liability and warranty conditions as described below.

Under all circumstances this manual should be read attentively, before installing and or using the product. In no event, Opticon Sensors Europe will be liable for any direct, indirect, consequential or incidental damages arising out of use or inability to use both the hardware and software, even if Opticon has been informed about the possibility of such damages.

A serial number appears on all Opticon products. This official registration number is strictly related to the device purchased. Make sure that the serial number appearing on your Opticon device has not been removed. Servicing by our Repair Department can only be carried out under warranty.

All Opticon products are warranted for a period of one year after purchase, covering defects in material and workmanship. Opticon will repair or, at its opinion, replace products that prove to be defective in material or workmanship under proper use during the warranty period.

Opticon will not be liable in case modifications are made by the customer. In such case the standard repair charge will be applicable. The standard charge for repair will also be applicable in case no defect is found at all. These rules also apply for products that are still under warranty. Therefore, you are advised to have the product specifications always at hand.

Trademarks used are property of their respective owners

**CONTENTS**

	page
<b>1 INTRODUCTION</b>	<b>3</b>
<b>2 INSTALLATION</b>	<b>4</b>
2.1 UNPACKING	4
2.2 DETAILED VIEW	5
2.2.1 Dimensions of terminal	5
2.2.2 Details of terminal	5
2.2.3 Display of terminal	6
2.2.4 Dimensions of cradle	7
2.2.5 Details of cradle	7
2.3 HANDLING PRECAUTIONS	8
2.4 ASSEMBLY	9
2.4.1 Terminal	9
2.4.2 Cradle	9
2.4.3 Terminal on cradle	10
2.5 INSTALLING, REPLACING AND CHARGING BATTERIES	10
2.5.1 Required batteries	11
2.5.2 How to charge the rechargeable battery pack in the cradle?	11
2.5.3 When to replace or recharge the main battery?	11
2.5.4 When to replace the backup battery?	11
2.5.5 How to (re)place the main battery in the terminal?	12
2.5.6 How to (re)place the backup battery in the terminal?	13
2.6 INSTALLING IN A SYSTEM	14
2.6.1 Terminal to computer	14
2.6.2 Single cradle to computer	14
2.6.3 Cradle network	14
2.6.4 Dip switch settings on cradle	15
<b>3 OPERATION OF THE TERMINAL</b>	<b>15</b>
<b>4 SCANNING</b>	<b>16</b>
4.1 How to read the barcode	16
4.2 Barcode reading problems	16

	page
<b>5 PIN OUT</b>	<b>17</b>
5.1 RS232 cable for terminal	17
5.2 RS485 cable for cradle network	17
5.3 RS232 cable for cradle	17
<b>6 SPECIFICATIONS</b>	<b>18</b>
6.1 SPECIFICATIONS TERMINAL	18
6.1.1 Electrical specifications	18
6.1.2 Optical specifications	18
6.1.3 Physical specifications	18
6.1.4 Functionality	18
6.1.5 Environmental specifications	19
6.1.6 Supported Barcode symbologies	19
6.2 SPECIFICATION CRADLE	19
6.2.1 Electrical specifications	19
6.2.2 Functionality	19
6.2.3 Environmental specifications	19
6.2.4 Physical specifications	19
<b>7 TROUBLESHOOTING</b>	<b>20</b>
7.1 COMMUNICATION PROBLEMS	21
7.2 READ OPERATION PROBLEMS	21
7.3 TERMINAL PROBLEMS	21
<b>8 PRODUCT ORDERING INFORMATION</b>	<b>23</b>

# 1 INTRODUCTION

This terminal is a compact, programmable handheld terminal, and is well suited for a variety of indoor portable applications. It has a built-in laser scanner that can scan all popular bar code labels at varying distances.

User's applications can be downloaded to the terminal to adapt the terminal to the user's situation.

Operating power is supplied by the main battery. The main battery may consist of a rechargeable Ni-MH battery pack (to be charged in cradle), or dry cell batteries, either non-rechargeable or rechargeable (to be charged in external charger).

The cradle is a communication station for data transmission between the (host) computer system and the terminal. It communicates with the terminal through their IrDA interface. The cradle will also charge the rechargeable battery pack in the terminal through the electrical contacts.

The IrDA interface on the terminal enables you to communicate with other devices that use IrDA communication, like portable computers, notebooks and organisers.

Additional a RS232 cable can be used. The RS232 cable can be used for direct communication between the (host) computer system and the terminal, for example to download software to the terminal.

The general use and functioning of the terminal together with the cradle will be described in this manual.

The exact behavior of the terminal depends on the user application that is running. For instructions about applications please consult the documentation of that software.

**Please read this manual carefully before using the terminal, to maximise the efficiency of this terminal.**

# 2 INSTALLATION

## TERMINAL PHL2700:

Package contents:

Terminal



Backup battery



Handstrap



## ADDITIONALS PHL2700:

**Battery Pack for terminal**  
Contents:  
Battery case



Dry cell batteries



**Battery Pack for terminal**  
rechargeable battery pack

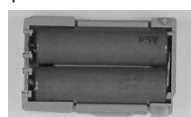

**Cable for terminal**  
RS232 cable

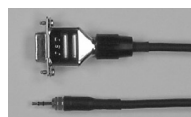

## 2.1 UNPACKING

When you remove the packing, please check for any physical damage. We recommend that you save all packing material, as it should be used whenever you need to ship your terminal (eg. for service). Damage due to improper repacking is not covered by the warranty.

**Apart from the terminal or cradle, additional items might be ordered and supplied.**  
If there are any missing parts please contact your supplier.

### Do not remove the label !

On the back of every unit you will find a label. The label is attached by the manufacturer and includes information about the function it supports and a serial number. Do not remove it.

## CRADLE IRU 2700:

Cradle



## ADDITIONALS IRU2700:

**Power Supply for cradle**



**Cable for cradle**  
RS232 cable DB9 F



**Cable for cradle**  
RS485 network cable



## 2.2 DETAILED VIEW

### 2.2.1 Dimensions of terminal

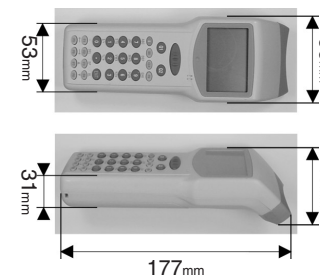

### 2.2.2 Details of terminal:

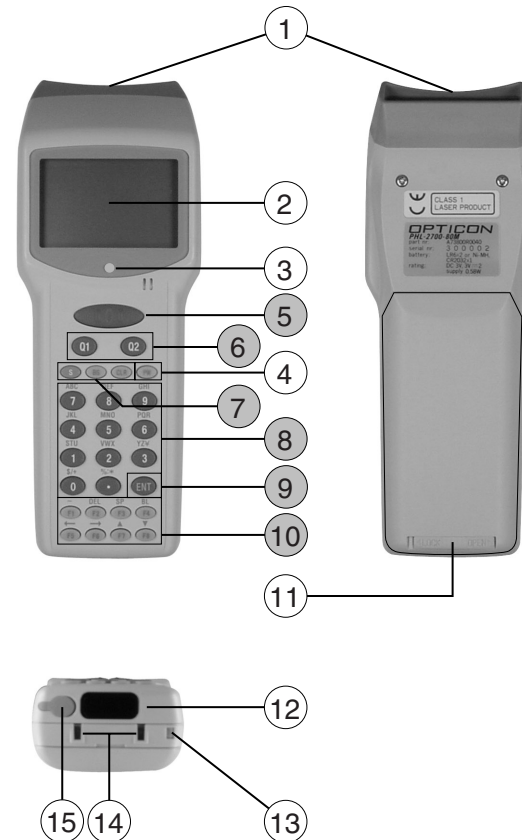

1. **Reading window**  
laser beam for barcode reading will be emitted from here
2. **LCD Display**  
for displaying information
3. **LED indicator**  
can be used to indicate results, for example bar code reading / status of communication
4. **Power key**  
for switching power On/Off
5. **Trigger key** ● definable by user's application  
typical use: read key, switches laser beam on for barcode reading
6. **Quick keys** ● definable by user's application  
typical use: menu scroll keys or yes/no input
7. **Control keys** ● definable by user's application  
for controlling basic functions  
typical use as below:  
CLR : Cancel input  
BS : Back space  
S : Shift key  
"S" on the LCD display indicates the terminal is in the shift mode
8. **Character keys** ● definable by user's application  
typical use: for input of alpha-numeric and punctuation characters
9. **ENT key** ● definable by user's application  
typical use: for confirming input
10. **Function keys** ● definable by user's application  
user programmable keys, to be used together with shift key.  
typical use as shown on next page
11. **Battery case cover**  
for housing main battery
12. **Optical interface window**  
for infra red communication
13. **Hand strap pillar**  
for attaching hand strap
14. **Electrical contacts**  
for power supply from the cradle IRU2700 to terminal
15. **RS-232C connector**  
for connecting external device, or for system expansion, through Opticon RS232 cable

**Description of the function keys**

In the shift mode, back light on/off, contrast adjustment, and cursor movement can be done by these keys.  
*(The user's application can give different definitions to the keys)*

- shift mode functions:
- F1 (-) input minus sign
  - F2 (DEL) delete one character
  - F3 (SP) input space
  - F4 (BL) toggle with back light
  - F5 (<--), F6 (-->) move cursor
  - F7 (▲), F8 (▼) adjust contrast

**2.2.3 Display of terminal**

The liquid crystal display of the terminal is typically used to show program prompts, instructions and data, as defined in the user's application.

The display has the following default options:

**Special purpose symbols in display:**

The symbols will be shown in the bottom part of the display and indicate status.

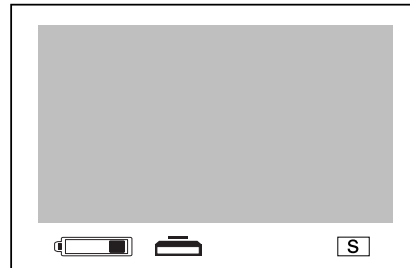

**Description of the display indicators**

 **Main Battery indicator**  
 Off: Sufficient battery power  
 On: Battery low.  
 Replace battery immediately.

 **Backup Battery indicator**  
 Off: Sufficient battery power  
 On: Battery low.  
 Replace battery immediately.

 **Alpha mode on**  
 (Shift-key activated)

**Backlight**  
 The display is provided with a backlight. When the backlight is turned on, the power consumption increases. To extend the life time of your batteries use the backlight as little as possible.

**2.2.4 Dimensions of cradle**

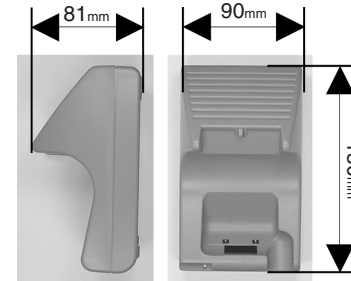

**2.2.5 Details of cradle**

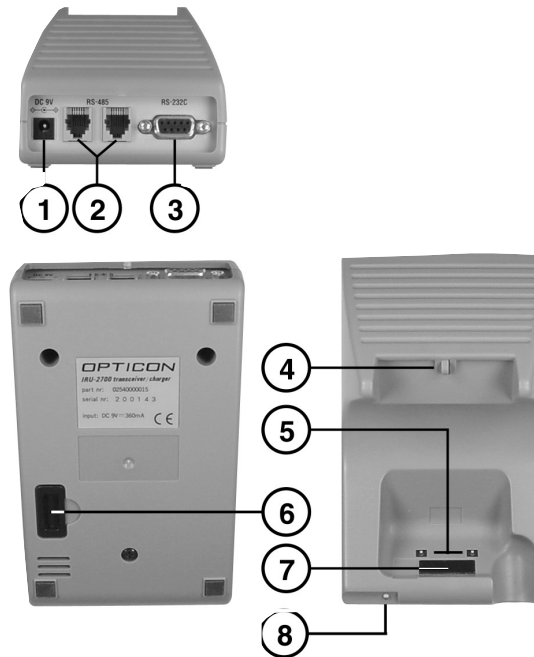

- 1. DC input socket**  
input for AC adaptor
- 2. RS 485 socket**  
for connecting another cradle in multi-drop RS485 network, through Opticon RS485 cable
- 3. RS 232 C socket**  
for connecting to PC or modem, through Opticon RS232 cable
- 4. Switch for terminal detection**  
to detect if a terminal is placed on the cradle
- 5. Electrical contacts**  
for power supply to terminal PHL2700  
If rechargeable Ni-MH battery pack is inserted in the terminal the pack will be charged through the electrical contacts
- 6. DIP switches**  
setting parameters of the infrared interface switches are located behind the cover
- 7. Optical window**  
window for optical data transmission
- 8. LED indicator**  
indicating power  
LED on: power is on  
LED off: power is off

## 2.3 HANDLING PRECAUTIONS

To avoid malfunctioning and to ensure years of trouble free operation, pay attention to the following:

### General use

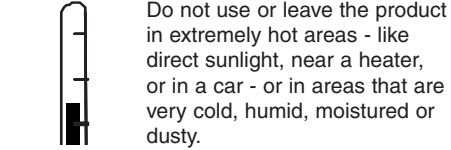

Do not use or leave the product in extremely hot areas - like direct sunlight, near a heater, or in a car - or in areas that are very cold, humid, moistured or dusty.



Do not expose the product to rain or water splash

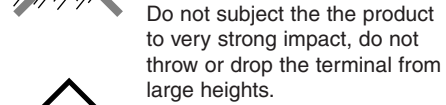

Do not subject the the product to very strong impact, do not throw or drop the terminal from large heights.



Do not allow a mechanical shock to the product.

### General cleaning instructions



Clean the exterior by wiping it with a soft, dry cloth. Do not use much water.



Do not use thinner, white spirit or other solvents. These can discolour the case and the keys and has a negative effect on the lifetime of the keys.

### Use of the cradle

Do not place any other product than the PHL-type terminal in the cradle.

### Cleaning of the cradle

Avoid touching the contacts in the cradle. The contacts must stay as clean as possible to maintain optimal charging capacity. Do not use water when cleaning the cradle. This can cause malfunction in the chargers.

### Use of the terminal



Operate the terminal keys by pressing them lightly with your fingertips or with something soft and round. Pressing the keys with a sharp pointed object (for eg. a ball-point) can damage the keys.



Avoid temperature changes. Sudden temperature changes can cause condensation to form on the terminal. Using the terminal while condensation is present can cause malfunction. Always wait until the condensation clears naturally before attempting operation.



Do not leave the terminal in an area where static charge is accumulated, or near devices where electromagnetic emission is generated.



Do not place any objects on top of the terminal. Do not lay the terminal face down. Doing so can cause accidental operation of the [PW] key or [ENTER] key, which can discharge your batteries or change settings you do not want to be changed.

### Cleaning of the terminal

Clean the optical interface window periodically.

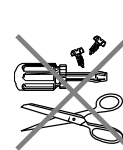

### Maintenance

There are no user-serviceable parts inside the terminal or the cradle. So do not try to take it apart. The manufacturer will not be liable for any damage caused by the customer.

In case of malfunction that can not be solved by the trouble-shooting instruction in the appendix, please consult our service department.

## 2.4 ASSEMBLY

Follow the next steps to make your terminal ready for installation in a system, that is described further in the manual.

### 2.4.1. Terminal

#### To avoid drop use the hand strap.

- Fix the small cord of the strap around the pillar of the terminal (ref. 1)
- Insert the handle of the strap in the thin loop (ref. 2)
- The strap is fixed to the terminal (ref. 3)
- Hold the handstrap around the wrist when carrying the terminal (ref. 4)

Do not swing the terminal around.

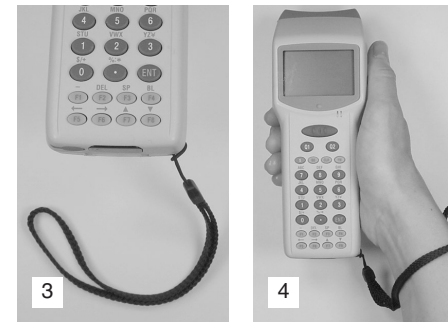
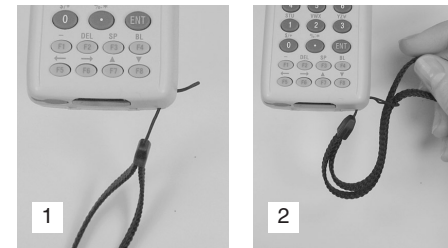

#### Start with a full battery

- To be sure of proper operation, it is advised to start with a full battery, charge the battery pack according to the instructions in the next chapter.
- Click the battery pack into the terminal, as instructed in the next chapter.

### 2.4.2 Cradle

#### Place for mounting

- Place the cradle in normal office conditions.
- Avoid a place under strong light. Otherwise IrDA communication may be disturbed.

#### Power Connection

- Attach the DC jack of the AC adapter into the socket of the cradle. Then connect the AC adapter to the mains outlet
- When the terminal PHL2700 with the rechargeable battery pack is placed in the cradle, the LED on the cradle turns green.
- When the terminal PHL2700 with penlite batteries is placed in the cradle, no indication is given by the cradle.

### 2.4.3. Terminal on cradle

Take notice that the IRU2700 cradle is designed for the PHL2700 terminal. No other types of terminals can be placed into this cradle.

Place the terminal in the cradle as shown in the illustration:



## 2.5 INSTALLING, REPLACING AND CHARGING BATTERIES

**Wrong use of batteries might cause serious damage to the terminal or to the cradle.**

**In order to avoid damage it is very important to take notice of the instructions.**

⚠ **Insert full batteries before use of the terminal.**

⚠ **Never remove the main battery pack while the terminal is turned on.**  
Doing so can cause data in the terminal to be deleted.

⚠ **When you do not use the terminal for a long time, make sure the main battery has enough capacity.**  
When there is not enough capacity the backup battery will be used up.

⚠ **Only use recommended batteries.**  
When other batteries are used, defects or other problems can occur. Before installing (new) batteries, please make sure you are using the recommended batteries.

⚠ **Do not make a mistake regarding the polarity (+, -) of the battery.**  
The terminal will not work when the polarity is incorrect.

⚠ **Use the right charger for batteries**  
Only the rechargeable Ni-MH battery pack of Opticon can be charged inside the terminal in the cradle IRU2700. Other rechargeable batteries need to be recharged in a separate battery charging device.

⚠ **Follow the instructions for installing, changing and removing the batteries very strictly.**  
The products are not warranted for damage, defects, malfunction or loss of data, resulting from incorrect use of batteries.

### 2.5.1 Required batteries

The terminal needs both main battery and backup battery for operation.

#### Main Battery

The main battery can consist of:

- ❑ Rechargeable Opticon battery pack (NiMH), to be recharged when placing the terminal PHL2700 in the cradle IRU2700.

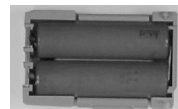

- ❑ Dry cel Opticon batteries (Alkaline). To be used together with Opticon battery case for dry cell batteries. These batteries are not rechargeable.

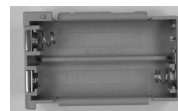

- ❑ Other batteries. All batteries have to be used together with Opticon battery case for dry cell batteries. Batteries that are not supplied by Opticon must be AA-size and absolutely leakproof. If rechargeable batteries are used, they need to be recharged by a separate battery charging device.

Opticon recommends to use Opticon batteries (Opticon rechargeable battery pack or Opticon dry cell batteries) only.

#### Backup Battery

Use only one type of battery for backup:

- ❑ Backup battery: CR2032 Li (Lithium, button type).

### 2.5.2 How to charge the rechargeable battery pack in the cradle?

⚠ Make sure that the Opticon rechargeable battery pack (Ni-MH) is inserted in the terminal.  
If the terminal with the right rechargeable battery pack is placed in the cradle, the LED on the cradle will turn green.

- ❑ The rechargeable battery pack inside the terminal will be charged automatically for a period of 8 hours when the terminal is placed in the cradle.

⚠ When the battery case with penlite batteries is inserted in the terminal, it will not be charged by the cradle. If the terminal with penlite batteries is placed in the cradle, the cradle will not show an indication.

### 2.5.3 When to replace or recharge the main battery?

There are 2 reasons for replacing the main battery;

- ❑ as soon as possible after the battery indicator  appears on the display.
- ❑ when you are not using the terminal for an extended period.

For instructions of (re)placing the main battery see paragraph 2.5.5.

### 2.5.4 When to replace the backup battery?

When low battery mark  appears, replace the battery without delay.

For instructions of (re)placing the backup battery see paragraph 2.5.6.

**2.5.5 How to (re)place the main battery in the terminal?**

- ⚠ **Only use batteries as specified in paragraph 2.5.1.**
- ⚠ **If you have data stored, make sure the backup battery is placed and full enough, to avoid data loss.**

Before installing a battery case with penlite batteries:

- ❑ Make sure you use the right battery size.
- ❑ Place 2 batteries in the battery holder aligning plus (+) and minus (-) ends as shown on the battery holder.

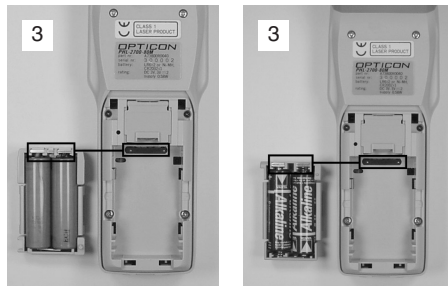
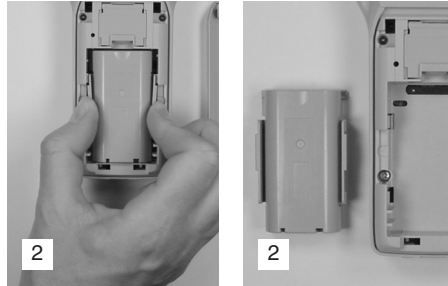
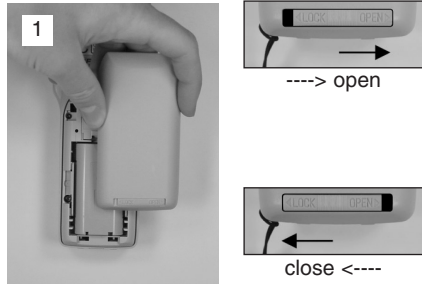
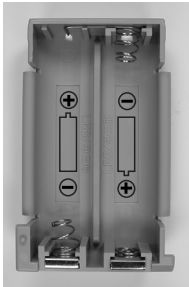

The instructions for installing the rechargeable battery pack are also applicable for the battery case with penlite batteries.

- ❑ **Unlock cover:** Open the switch (shift to the right) and remove the battery case cover (ref. 1)
- ❑ **Remove main battery:** Hold the battery case while pressing on both sides and lift it (ref. 2)
- ❑ **Place main battery:** Take the battery case. Check if the charging contacts of the case align with the contacts inside the battery compartment (ref. 3)
- ❑ **Fit main battery:** First press the pack into the direction of the terminal nose. Than press the pack tight into the housing untill it clicks (ref. 4)
- ❑ **Fit cover:** Place the battery case cover and lock the switch (shift to the left) (ref. 1)

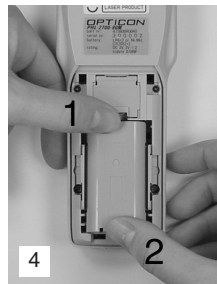

Opticon user's manual

**2.5.6 How to (re) place the backup battery in the terminal?**

- ⚠ **Make sure that the main battery is full enough while changing the backup battery.**
- ⚠ **Only use CR2032 Li (Lithium, button type) battery.**

- ❑ **Unlock cover:** Open the switch (shift to the right) and remove the battery case cover (ref. 1)
- ❑ **Open lid:** Place your thumbnail below the saving of the lid to open it (ref. 5)
- ❑ **Remove backup battery:** Take the old battery out of the compartment.
- ❑ **Place backup battery:** Make sure that the positive side of the backup battery is pointed upwards and place it in the compartment (ref. 6)
- ❑ **Close lid:** Press the lid downwards until it clicks into the compartment
- ❑ **Fit cover:** Place the battery case cover and lock the switch (shift to the left) (ref. 1)

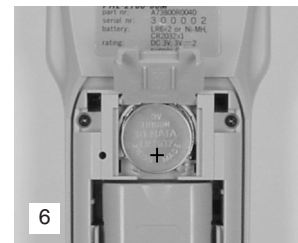

## 2.6 INSTALLING IN A SYSTEM

- ⚠ Exercise caution at all times when working with AC-powered equipment.
- ⚠ Turn off your devices before installation.
- ⚠ Because of the special pin-out of the connectors, use the cables supplied by the manufacturer.
- ⚠ When you need another cable for a certain device, that is not supplied, contact your supplier to purchase the right cable. In case another cable is used, take notice of the pin-out specifications further in this manual.

Connection sequence for single cradle:

- Place the cradle in normal office conditions, avoid a place under strong light.
- Disconnect the power supply.
- Set the required DIPswitches for baud rate and function.
- Connect the interface cables.
- Connect the power supply.
- Place the PHL2700 terminal in the cradle.

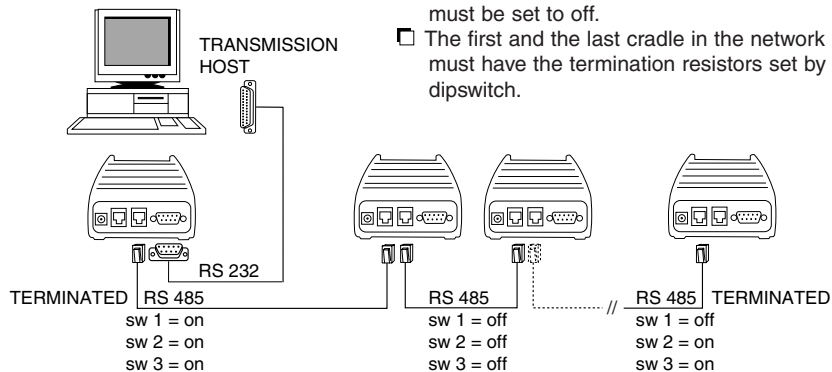

### 2.6.1 Terminal to computer

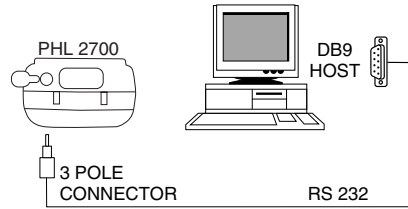

### 2.6.2 Single cradle to computer

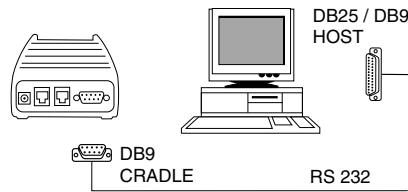

### 2.6.3 Cradle network

Connection sequence for cradle in network:

- Set all cradles to the same baud rate (by DIPswitch)
- Only 1 cradle in the network will be connected to the PC through one RS232 cable. On this cradle the DIPswitch for RS232 connection must be enabled. Through this connection all cradles can communicate to the PC.
- A maximum of 16 cradles can be connected in a network through RS485 cables. For the cradles that are not directly connected to the PC the DIPswitch for RS232 connection must be set to off.
- The first and the last cradle in the network must have the termination resistors set by dipswitch.

### 2.6.4 DIP switch settings on cradle

Setting the DIP switches on or off will result in different baudrates and enabled or disabled functions of the cradle.

- Open the cover of the DIP switches on the bottom of the cradle in order to reach the DIP switches.
- Turn the DIP switch ON by moving it upwards into the direction of the dipswitch number.
- Turn the DIP switch OFF by moving it downwards into the direction OFF.

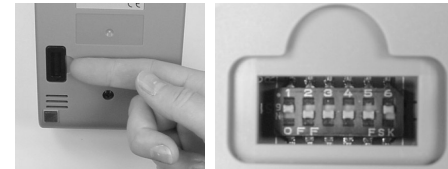

DIP SWITCH	FUNCTIONS	ON	OFF	DEFAULT
SW 1	RS 232 CONNECTION	in use	not in use	ON
SW 2	RS485 TERMINATOR	in use	not in use	OFF
SW 3	RS485 TERMINATOR	in use	not in use	OFF
SW 4	BAUDRATE *	--	--	OFF
SW 5	BAUDRATE *	--	--	OFF
SW 6	BAUDRATE *	--	--	ON

*) BAUDRATE	SW 4	SW 5	SW 6
1200	OFF	OFF	OFF
2400	ON	OFF	OFF
4800	OFF	ON	OFF
9600	ON	ON	OFF
19200 (default)	OFF	OFF	ON
38400	ON	OFF	ON
115200	OFF	ON	ON
NONE	ON	ON	ON

# 3 OPERATION OF THE TERMINAL

The functionality of the terminal is determined by software, the so-called user application, that is running on the terminal.

Usually, the terminal is not equipped with software and has no functionality. At first the user application must be loaded before the terminal can be used for barcode scanning.

Tools for developing a user application on the PC for use on the terminal, as supplied by Opticon are:

- Application Generator PotStar (Limited or Professional)
- C language: Microtec ANSI-C compiler and C library for handheld terminals.

The user application must be downloaded from the PC into the terminal. You can use the cradle, an RS232 cable or an infrared adapter for communication between the terminal and the PC. A program on the PC will send the user application to the terminal, where it is stored in FlashROM memory.

When the functionality of the terminal is defined by the application it is ready for operation.

In a typical application you will press the trigger key and scan a bar code label as described in the next chapter. Scanned data and data entered from the keyboard is stored in the terminal's RAM. The user application can use this data in subsequent steps.

The collected data can be transmitted to the PC for further processing. For data transmission you can use the cradle, an RS232 cable or an infrared adapter to connect the terminal to the PC.





# 4 SCANNING

 **The terminal is a Class I laser product conforming to the strictest laser safety standards. However, we recommend that you avoid looking directly into the laser beam emitter, or pointing the laser beam directly into someone's eyes.**

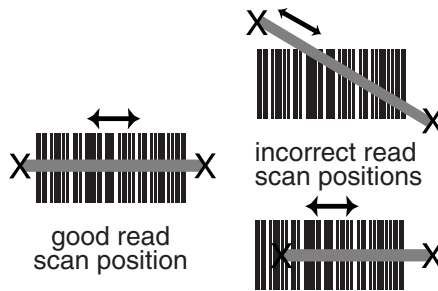
Fit the bar code in the laser beam from margin to margin and pass the scanner downward over the bar code, as shown in the scan position illustration.



-  Please take care of the handling precautions.
-  Please make sure that the terminal is installed according to the installation instructions.
-  Never remove the main battery pack while the terminal is turned on. Doing so can cause data in the terminal to be deleted or corrupted.

## 4.1 How to read the barcode

The scanning sequence is defined by the user's application. A typical sequence is:

- Press the [PW] key to turn power on.
- Check the display for the message: *READ BAR CODE*
- Point the terminal to the barcode and press the Trigger key.
- Point the laserbeam to barcode as shown in the scan position illustration.
- The barcode will be read and the reading results will be indicated.

A 'Good Read' means that the scanner has effectively recognised and decoded the bar code. In most cases, the application program will provide an indicator signal or a buzzer signal to indicate a good read to the user.

When the read is incorrect you can try again, paying attention to the instructions in this chapter.

When reading a small bar code, decrease the distance between the terminal and the bar code. For larger bar codes, position the terminal so that the bar code fits into the laser beam. When reading a very high density bar code, decrease the distance between the terminal and the bar code. For a low density bar code, increase the distance between the terminal and bar code.

## 4.2 Barcode reading problems

When the barcode can not be read, try the following:

- Change the angle between the bar code and the terminal.
- Change the distance between the bar code and the terminal.
- If the bar code is larger than the laser beam, try moving the terminal a bit further away from the bar code.

# 5 PIN-OUT

## 5.1 RS232 cable for terminal PHL1700

## 5.2 RS485 cable for cradle network IRU2700

## 5.3 RS232 cable for cradle IRU2700

**5.1**

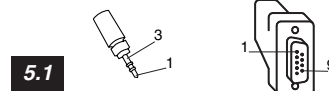

Jack plug 3 pole (terminal)	Signal	DB 9 connector Female (PC)	Signal
1	TxD	2	RxD
2	RxD	3	TxD
3	GND	5	GND

**5.2**



Network cable RS485	Modular plug (6P6)	Modular plug (6P6)	Signal
1	-	2	RD+
2	-	3	RD-
3	-	4	SD+
4	-	5	SD-
5	-	-	-
6	-	-	-

**5.3**



RS232 cable	DB 9 male (cradle)	Signal	DB 9 female (PC)	Signal	In/Out (cradle)	Note
3	TxD	2	RxD	IN	-	
2	RxD	3	TxD	OUT	-	
6 + 1	DSR	4	DTR	OUT	ON (fixed)	
5	GND	5	GND	-	-	
4	DTR	6 + 1	DSR	-	not used	
8	CTS	7	RTS	OUT	ON (fixed)	
7	RTS	8	CTS	-	not used	

# 6 SPECIFICATIONS

## 6.1 SPECIFICATIONS TERMINAL

### 6.1.1 Electrical specifications

Main battery	<input type="checkbox"/> rechargeable pack: Ni-MH <input type="checkbox"/> dry cell: Alkaline penlite <input type="checkbox"/> optional: other 2 x AA-size penlite
Main battery operating time	<input type="checkbox"/> Ni-MH: When making every 5 seconds 1 scan with 1 sec laserbeam on and 0.2 sec. green LED on and 0.2 sec. buzzer on, operating time is: approx. 40 hours <input type="checkbox"/> Alkaline: When making every 5 seconds 1 scan with 1 sec laserbeam on and 0.2 sec. green LED on and 0.2 sec. buzzer on, operating time is: approx. 78 hours <input type="checkbox"/> Different operation conditions affect the operating time <input type="checkbox"/> Use of other penlite batteries affect the operating time
Backup battery	Lithium (CR2032)
Backup battery operating time	If fully charged: 30 days backup time
Battery management	<input type="checkbox"/> Low voltage indicated on the terminal display. <input type="checkbox"/> When battery is low the terminal switches off automatically.
Charging method	<input type="checkbox"/> Rechargeable Ni-MH pack in terminal via cradle

### 6.1.2 Optical specifications

Light source	650 nm visible laser diode
Scan rate	100 scans/sec
Decode rate	100 decodes/sec
Reading width	62 mm at 30 mm 111 mm at 100 mm
Resolution at PCS 0.9	0.15 mm (6mil)
Depth of field	0 - 140 mm (at PCS 0.9, res. 0.25)

### 6.1.3 Physical specifications

Dimensions (l x w x d)	177 x 62 x 41 mm
Case material	ABS
Weight	body (excl. battery): 175 g
Direct cable (optional)	RS232 - DB9 female

### 6.1.4 Functionality

Memory	<input type="checkbox"/> ROM: 32 kB <input type="checkbox"/> FlashROM (for O/S and program): 512 kB <input type="checkbox"/> fast RAM: 2kB <input type="checkbox"/> battery backed up D-RAM (for data): 8 MB
Microprocessor	16-bit
Real time clock	Quartz RTC, time and date programmable, leap year handling, (accuracy $\pm$ 60 sec./month)
Display with backlight	<input type="checkbox"/> 128x64 Pixels graphic LCD <input type="checkbox"/> Character fonts: 4/8 lines x 16 characters 5/10 lines x 21 characters
Keyboard	<input type="checkbox"/> 27 keys total (26 keys user definable) <input type="checkbox"/> 8 Function keys <input type="checkbox"/> Alpha/Numeric mode
Trigger mode	Manual
Programming	Functionality is provided by user application. The application may be downloaded from PC via cable, com port or IrDA.
Interfaces supported	<input type="checkbox"/> RS232 by direct cable <input type="checkbox"/> RS232 by cradle <input type="checkbox"/> IrDA on terminal

Transmission speed	<input type="checkbox"/> RS232 direct cable: 2400 - 115200 baud <input type="checkbox"/> RS232 cradle: 2400 - 115200 baud <input type="checkbox"/> IrDA terminal: 2400 - 115200 baud
--------------------	---

### 6.1.5 Environmental specifications

Temperature	<input type="checkbox"/> 0 - 50 °C in operation <input type="checkbox"/> -10 - 60 °C in storage
Humidity (non condensing)	<input type="checkbox"/> 20 - 80 % in operation <input type="checkbox"/> 20 - 90 % in storage
Shock: drop:	1.5 m drop onto concrete surface
Shock: vibration:	10 - 50 Hz with 1G for 30 min, cycle for X,Y,Z.
Ambient light rejection	<input type="checkbox"/> fluorescent 3.000 lux max. <input type="checkbox"/> direct sun 50.000 lux max.
Emission	According to EN50081, part 1
Immunity	According to EN50082, part 1
Protection against dust and moisture	According to IEC529, IP 42
Safety, Laser class	According to IEC825, Class I laserproduct

### 6.1.6 Supported symbologies

Chinese Post 2of5  
 Codabar incl. ABC and CX  
 Code 39  
 Code 93  
 Code 128  
 EAN-8 incl. +2,+5  
 EAN-13 incl. +2,+5  
 IATA  
 Industrial 2of5  
 Interleaved 2of5  
 Italian Pharmaceutical  
 Laetus  
 Matrix 2of5  
 MSI/ Plessey  
 UK/ Plessey  
 S-Code  
 Telepen  
 UPC-A incl. +2,+5  
 UPC-E incl. +2,+5

## 6.2 SPECIFICATIONS CRADLE

### 6.2.1 Electrical specifications

Battery charging time	when battery in terminal: 8 hours charge
-----------------------	---

### 6.2.2 Functionality

Interfaces supported	<input type="checkbox"/> RS232 <input type="checkbox"/> RS485
Serial communication	<input type="checkbox"/> RS232 Baudrate: 1200 - 115200 <input type="checkbox"/> RS485 Baudrate: 1200 - 115200
Transmission modes	<input type="checkbox"/> Half duplex RS232 <input type="checkbox"/> Half duplex RS485
Parity	Odd, Even, None

### 6.2.3 Environmental specifications

Temperature	<input type="checkbox"/> 0 - 40 °C in operation <input type="checkbox"/> -20 - 60 °C in storage
Humidity (non condensing)	<input type="checkbox"/> 30 - 85 % in operation <input type="checkbox"/> 30 - 90 % in storage
Shock: vibration:	10 - 50 Hz with 1G for 30 min, cycle for X,Y,Z.
Emission	According to EN50081, part 1
Immunity	According to EN50082, part 1

### 6.2.4 Physical specifications

Dimensions (l x w x d)	150 x 90 x 81 mm
Case material	ABS
Weight	250 g
Standard connector	RS232 - D Sub 9P Female RS485 - 6 pins modular plug

# 7 TROUBLE SHOOTING

This chapter contains information on solving problems you may encounter when using the terminal and/or cradle. If problems occur, first carry out some general checks, before verifying the problem with the descriptions in this chapter.

## General checks:

- Make sure everything is installed properly
- Check the power supply of all devices
- Is the reading window of the terminal clean?
- Is the optical window of the cradle clean?
- Are the bar code labels readable, eg. not damaged or poorly printed?

If the equipment still does not work after these checks have been performed, please verify if one of the problems described in this chapter applies to the problem you have with the scanner.

It is possible that you may not solve the problems, despite our descriptions. In this instance, please contact your dealer or Opticon.

When the terminal needs to be repaired, please ensure that the label with the serial number is still present. If sending the terminal or cradle, please use the original packing to minimise the chances of damage.

## 7.1 COMMUNICATION PROBLEMS

**No communication from the cradle to the device, or data is transmitted distorted or corrupted.**

- Power indicator of the cradle is not green.*
  - Check if the battery case cover of the PHL2700 is closed properly.
  - Clean the optical interface window of the cradle and/or terminal, and try again.
  - Check all cables.
    - When the power indicator is still not green, the cradle needs service.

- No data transmitted*
  - The cradle will only work if connected to a PC.
  - Clean the optical interface window of the cradle and/or terminal, and try again.

- Data is corrupted, or no data is transmitted.*
  - Is the proper baudrate selected?
    - The computer needs the same baudrate as the terminal.
  - Clean the optical interface window of the cradle and/or terminal, and try again.

**The terminal loses data when the battery pack is removed for a short period.**

- The backup battery is empty.*
  - Replace the Lithium CR2032 battery by a new one.

## 7.2 READ OPERATION PROBLEMS

**When the terminal has a problem with reading the label:**

- The resolution of the bar code is too high.*
  - Decrease the distance between the bar code and the terminal.
- The angle between the label and the terminal is too high.*
  - Change the angle between the bar code and the terminal.

- The distance is too far or too close.*
  - Change the distance between the bar code and the terminal.

- The bar code is larger than the laser beam.*
  - Try moving the terminal a bit further away from the bar code.

- The read window is dirty.*
  - Clean the read window of the terminal.

- The type of the bar code label is not enabled.*
  - Enable the bar code symbology in the application program.

### 7.3 TERMINAL PROBLEMS

**Terminal does not respond to key presses, while the display stays on.**

- ◇ *Message "Application halted" or "No application installed" is shown.*
- ☐ There is no user's application for PHL2700 loaded in the terminal. Contact your supplier.
  
- ◇ *For example pressing the shift key does not toggle the shift indicator.*
- ☐ There is a flaw in the application program. Disconnect the battery pack, and place it then back in.  
The terminal will be in off-state. Activate the system menu and restart the application, or download new application.
- ☐ If problems appears continuously contact the supplier of the user's application.

**Laser stays off, when pressing the triggerkey.**

- ◇ *Power is off.*
- ☐ The triggerkey is no powerkey. Press the powerkey to get power.
- ☐ If the terminal is not used the scanner will switch off all functions.  
Press the powerkey to reactivate.
  
- ◇ *Laser temperature has become too high.*
- ☐ The laser is switched off automatically, when the laser temperature becomes above 50°C. Wait until the temperature has dropped.

**Terminal gets no power, when pressing the powerkey.**

- ◇ *The main battery is exhausted.*
- ☐ Replace the battery pack, or charge the terminal in the cradle.

**Terminal does still not operate and needs a service**

Send the terminal to your supplier for service, paying attention to the limited warranty.

## 8

### PRODUCT ORDERING INFORMATION

**Apart from the terminal, additional items might be ordered.**

	Article Code
<b>Terminal</b>	
☐ PHL 2700-80 (8MB)	A73800R0040
<b>Battery pack for terminal</b>	
☐ Rechargeable Battery Pack	O2540000020
☐ Dry Cell Battery Pack Assy (assy = case holder + penlite batteries)	O2510000030
☐ Battery Case Holder	Q2510000040
☐ Penlite Batteries	PBA30000010
<b>Cable for terminal</b>	
☐ RS232 cable DB 9 female	O2500000050
<b>Protective bags for terminal</b>	
☐ Leather bag	O2510000055
☐ Leather bag clip	O2510000060
<b>Software development tools</b>	
☐ Microtec ANSI-C cross compiler	O8010000010
☐ C-library for handheld terminals	D4030000020
☐ Application Generator Potstar Limited	D6010000010
☐ Application Generator Potstar Professional	D6020000010

**Apart from the cradle, additional items might be ordered.**

	Article Code
<b>Cradle</b>	
☐ IRU2700-S	O2540000015
<b>Power supply for cradle</b>	
☐ 9V DC adaptor	A50200N0020
<b>Cables for cradle</b>	
☐ RS232 cable DB 9 female	O2520000020
☐ Adapter DB25 female/DB9 male	P10AT000040
☐ RS485 cable	O2520000050

