

OPTICON H-27



Android Industrial Smartphone User Manual

Table of Contents

Introduction	1
Features	1
Package Contents	1
Product Overview	2
Front and Back	2
Left and Right	3
Top and Bottom	3
LED Indicators	4
Getting Started	5
Inserting the Battery	5
Charging the Battery	6
Inserting the MicroSD Card	7
Inserting the SIM Card	7
Powering the Device On/Off	8
Suspend Mode	8
Unlocking the Screen	9
Using the Android Industrial Smartphone	10
Understanding the Interface	10
Home Screen Overview	10
Status and Notifications	11
Using the Touch Screen	12
Managing the Home Screen	13
Opening Applications	14
Changing Basic Settings	15
Setting the Date and Time	15
Configuring Display Settings	16
Configuring Sound Settings	17
Managing Wireless and Network Settings	18
Connecting to Wireless Networks	18
Connecting to Bluetooth Devices	18
Configuring Language and Keyboard Settings	19
Changing the System Language	19
Changing the Input Settings	19
Using the User Dictionary	20
Advanced Settings	21
Configuring Location Services	21
Configuring Security Settings	21
Adding an Account	22
Managing Storage Space	24
Application and Operation	25
Browser	25
Launching a Web Page	25

Viewing the Current Web Page	25
Managing Web Pages	26
Additional Web Page Features	26
Camera	27
Capturing Photos	27
Reviewing Photos	28
Configuring Camera Settings	28
Recording Videos	30
Reviewing Videos	31
Configuring Video Settings	31
Capturing Panorama Shots	32
Email	33
Setting up an Email Account	33
Viewing Emails	34
Composing and Sending an Email	35
Reading and Replying an Email	35
Deleting Emails	36
Adding Other Email Accounts	37
Customizing Email Settings	37
File Manager	38
Browsing Files	38
Managing Files and Folders	38
Gallery	39
Viewing Photos	39
Playing Videos	40
Playing Slideshow	40
Messaging	41
Creating and Sending a Text Message	41
Adding an Attachment to a Message	41
Configuring Messaging Settings	42
Music	43
Playing a Song	43
Creating a Playlist	44
Assigning a Song as Ringtone	44
Deleting a Song	45
People	46
Adding a New Contact	46
Importing/Exporting Contacts	47
Managing Contacts	47
Phone	50
Making a Call	50
Answering a Call	51
Viewing Call Log	51
Barcode Scanner Module	52
Configuring Barcode Reader Settings	52
Scanning a Barcode	53

Appendix 54

- Specifications 54
 - RF Exposure Information (SAR) 57
 - WEEE Notice 58
 - FCC Regulations 59

Introduction

Industry's first revolutionary Android industrial smartphone. H-27 is a mobile computer powered by Qualcomm's dual core processor. The design is sleek and light weight. It also passes IP65 sealing protection and is 1.5m drop resistant on concrete floor. Optional features for H-27 are 1D or 2D barcode scanners. These features are combined in various ways to satisfy transportation and logistics, public sector and hospitality related application settings.

Features

Standard features:

- Dual core 1.5GHz CPU
- Android™ 4.2 OS
- WLAN 802.11 a/b/g/n
- WWAN GPRS/Edge/UMTS/HSDPA+
- Built-in GPS (accelerometer/ e-compass/gyroscope/ambient light/ vibrator)
- 1.5m drop resistance and IP54
- 5.0 Megapixels camera AF with LED flash
- Replaceable battery
- Support sunlight readable
- Gorilla class II touch screen
- RFID device 13.56MHz, built-in standard, ISO 14443 A/B, FeliCa R/W

Package Contents

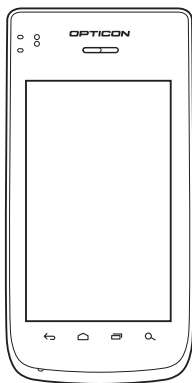

H-27

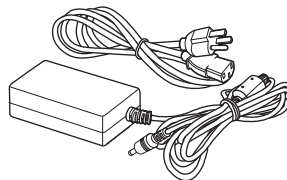

Power adaptor & cord

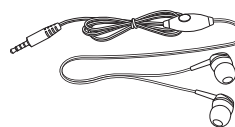

Headset



USB cable

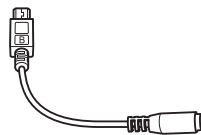

USB to DC cable



Quick Start Guide

Product Overview

Front and Back

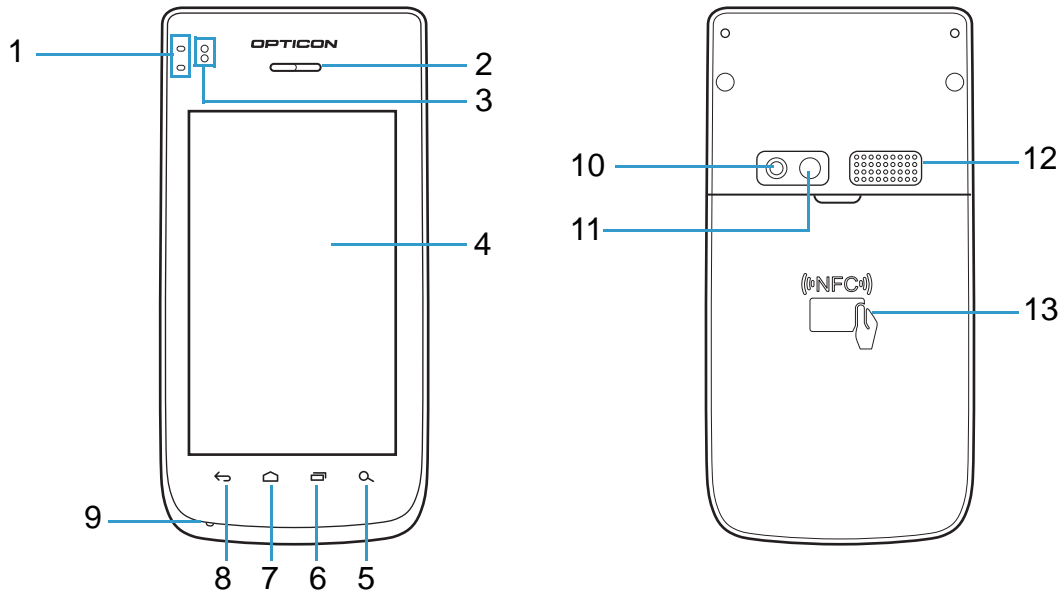

No.	Item	Description
1	LEDs	Used for power, system, and application notifications.
2	Receiver	Speaker for handheld phone calls.
3	Proximity and light sensor	Proximity sensor for detection of near objects (e.g., used for turning off touch display during voice calls). Light sensor for automatically adjusting display backlight to the environmental light.
4	Display with touch panel	
5	Search	Search action. Action depends on active application/view.
6	Recent App	Select a previously started activity.
7	Home	Touch to return to the Home screen.
8	Back	Return to previous activity.
9	Microphone	Audio input for voice calls and applications.
10	Flash LED	Flash LED for camera and applications.
11	Camera	For taking pictures or recording videos.
12	Speaker	Loudspeaker for ringtones, notifications, etc.
13	NFC	Read NFC tags and wireless smartcards.

Left and Right

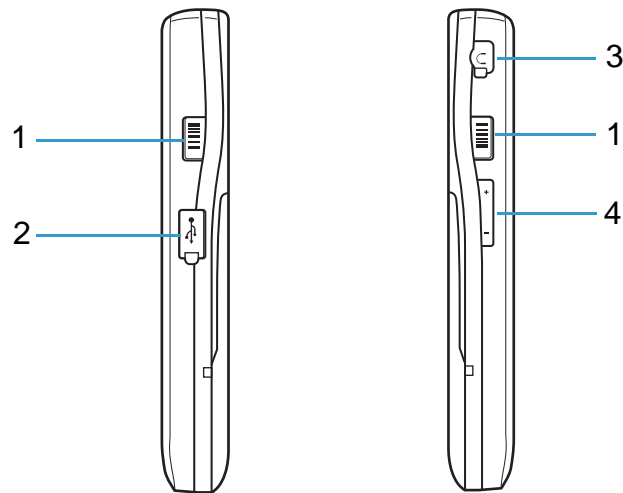

No.	Item	Description
1	Barcode scan trigger keys	Press to scan barcodes.
2	Micro USB OTG port	Connect to a USB cable for data transfer or battery charging purposes.
3	Earphone jack	3.5mm audio jack.
4	Volume keys	Press to adjust the volume.

Top and Bottom

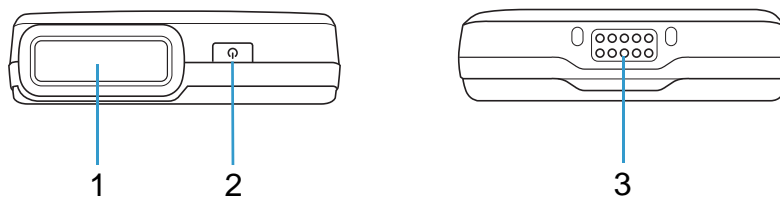

No.	Item	Description
1	Barcode scan window	
2	Power button	<ul style="list-style-type: none"> • Turn on/off the device. • Press once to put the device into Suspend mode. • Long press (~10s) for device hard reset.
3	System connector	Connect to the cradle unit.

LED Indicators

The H-27 industrial smartphone has two LED indicators.

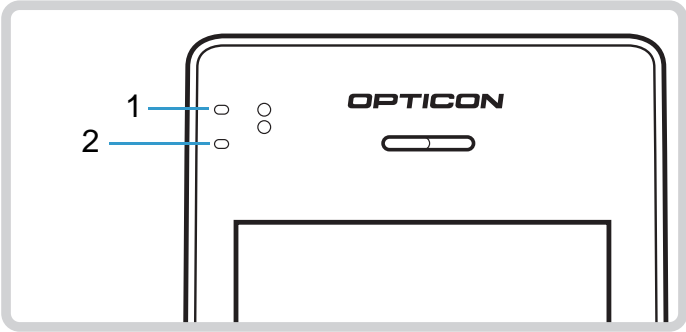

No.	Item	Description
1	Application LED	Used by barcode scanner to indicate scanning and successful read.
2	Power and System LED	Used to notify user about power and system status when display is OFF. <ul style="list-style-type: none">• Red when the battery is charging.• Green when charging is complete.

Getting Started

Inserting the Battery

1. Place the two thumbs on the back cover. Press firmly and slide down to open the battery cover. Lift up to remove the battery cover.

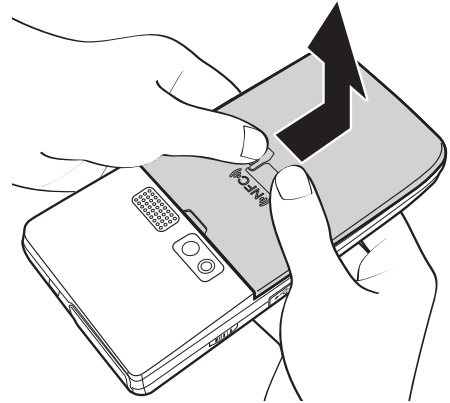

2. Insert the battery according to the interaction on the battery label.

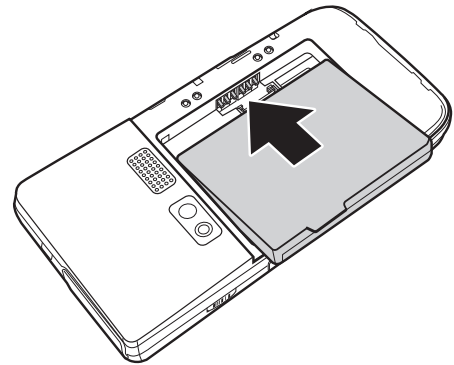

3. Replace the battery cover.

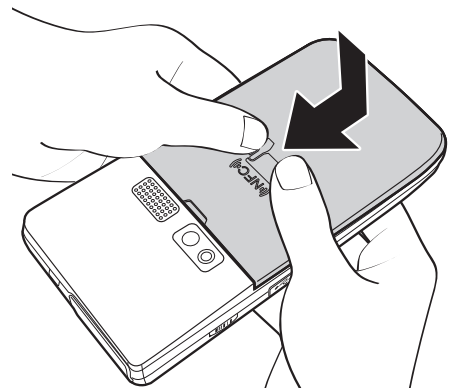

Charging the Battery

1. Open the USB cap.
2. Connect the device using the DC to USB cable and power adaptor.
3. Plug the other end of the power adaptor to the wall outlet to start charging.

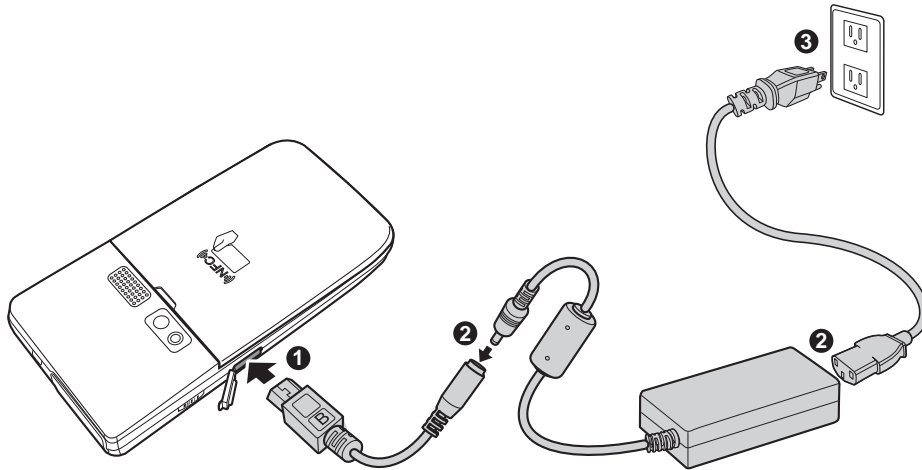

NOTE: H-27 can be charged with the supplied power adaptor and DC to USB cable, or from a PC via USB, or via H-27 cradle, or any micro USB charger which is compliant with USB battery charging 1.2 (http://www.usb.org/developers/devclass_docs/USB_Battery_Charging_1.2.pdf). Using improper adaptor, cradle or cable might cause damage to the device and void the warranty.

When the battery is charging:

- The status LED lights red.
- When the device is turned on, the  icon is displayed on the top-right corner of the screen.

Inserting the MicroSD Card

1. Remove the battery cover and remove the battery and SIM card.
2. Unlock the memory card slot by sliding it toward the bottom of H-27.

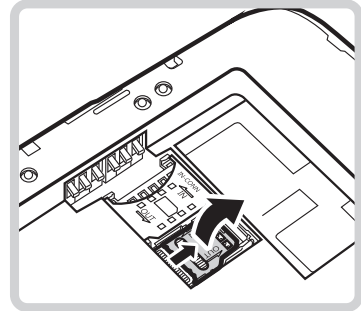

3. Insert a micro SD card into the memory card slot.

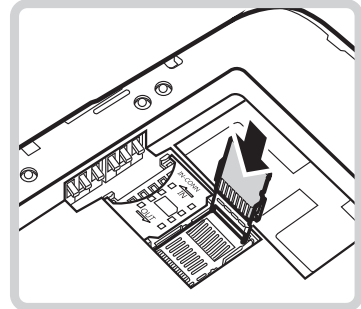

4. Gently place down the memory card slot. Lock the memory card slot by sliding it toward the top of H-27.
5. Replace the SIM card and the battery.
6. Replace the battery cover.

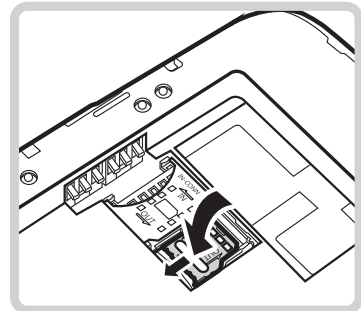

Inserting the SIM Card

1. Remove the battery cover and battery.
2. Insert the SIM card into the SIM card slot as shown in the illustration.
3. Replace the battery and the battery cover.

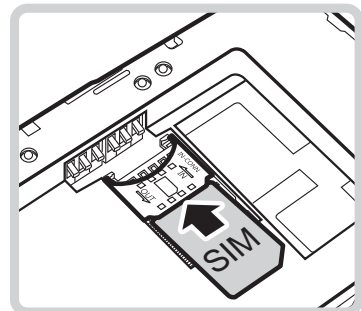

Powering the Device On/Off

To turn on the device:

Press and hold the **Power** button for 3 seconds to turn on the device.

To turn off the device:

1. Press and hold the **Power** button for at least 3 seconds.
2. Touch **Power off**.
3. A confirmation message appears on the screen. Touch **OK** to turn the device off.

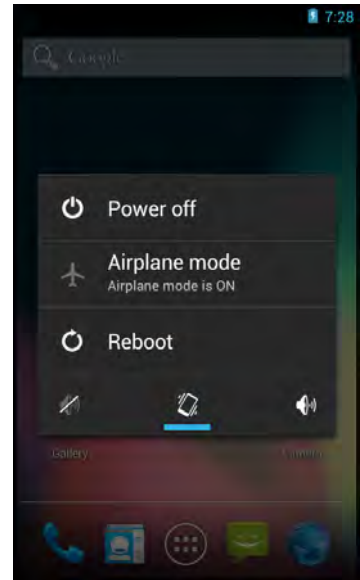

Suspend Mode



To save power, put the device to **Suspend** mode when not in use. In **Suspend** mode, the device is in **Power On** mode but the screen backlight is turned off.

- To put the device to **Suspend** mode, press the **Power** button once. The screen backlight turns off.
- To turn the backlight on, press the **Power** button again.

Unlocking the Screen

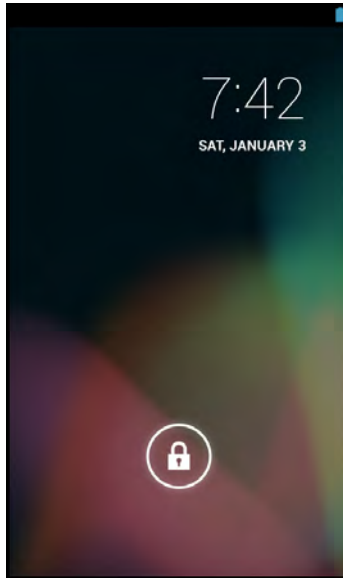
By default, the screen is locked after turning the device on, when leaving suspend mode or after a period of inactivity. The screen lock time can be set in Settings menu (see “Configuring Display Settings” on page 16).



To unlock the screen, drag  towards .



NOTE: When the  icon is touched, it automatically changes to .

Using the Android Industrial Smartphone

Understanding the Interface

Home Screen Overview



No.	Item	Description
1	Status Bar	Displays pending notifications on the left and status, such as time, battery level, or signal strength, on the right. Swipe down from the status bar to show notification details.
2	Home screen	Home is a customizable space that houses application shortcuts, folders and widgets. Navigate between different home screen panels by swiping left and right.
3	Search Bar	Touch to do a search on the internet, application, and contacts.
4	Favorites Tray	Always keeps your most important shortcuts and folders in view regardless of which Home panel is currently showing.
5	All Apps Button	The All Apps screen lets you browse the entire set of applications and widgets that are installed on your device.

Status and Notifications

The Status Bar always appears on top of the screen and indicates different types of information.



No.	Item	Description
1	Barcode reader	Indicates that the barcode reader is enabled.
2	Bluetooth icon	Indicates that Bluetooth is enabled. To enable this function, see “Connecting to Bluetooth Devices” on page 18.
3	Wi-Fi icon	Indicates the Wi-Fi signal strength. To enable this function, see “Connecting to Wireless Networks” on page 18.
4	Cellular network icon	Indicates the cellular network signal strength.
5	Battery icon	Indicates the battery status.
6	Time	Displays the system time. To correct the time, see “Setting the Date and Time” on page 15.

Drag the status bar downwards to display more information.

NOTE: Depending on the current application and available features for the device, the icons displayed on the status bar may vary.

Using the Touch Screen

The device is equipped with a 4.3-inch touch screen.

The following describes some tips on how to use the touch screen.

Touching

- Touch an icon displayed on the screen to select it.
- A pop-out menu may appear (depending on the function in use) by touching and holding on the screen.

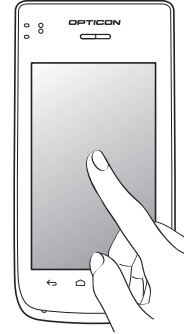

Scrolling

- **Scroll up/down:** slide the finger up/down on the screen.
- **Scroll right/left:** slide the finger right/left on the screen.

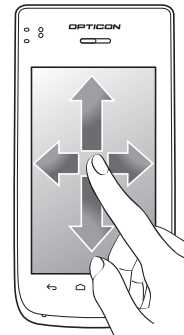

Dragging

Touch and hold an icon to move its position.

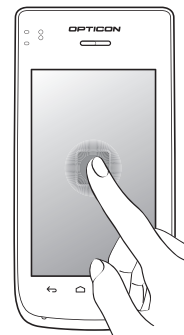

Pinching

- **Zoom in:** move the two fingers apart from each other at the specific area on the screen to zoom in.
- **Zoom out:** move the two fingers closer together at the specific area on the screen to zoom out.

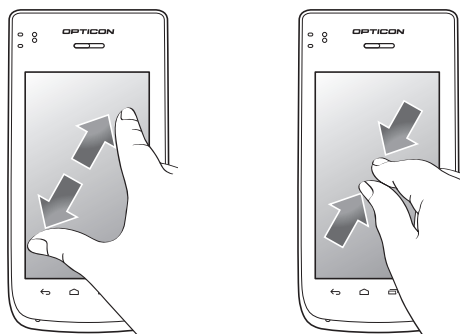

Managing the Home Screen

Add shortcut icons, widgets, and folders on the **Home** screen and change the wallpaper.

To change the wallpaper:

1. Touch and hold a blank space on the **Home** screen.
2. A pop up window appears. Touch one of the following:
 - **Gallery:** To use pictures saved on the device.
 - **Live Wallpapers:** To use pre-installed interactive wallpapers that came with the device.
 - **Wallpapers:** To use preset wallpapers that came with the device.

NOTE: Live wallpapers increase the power consumption and might reduce the user time.

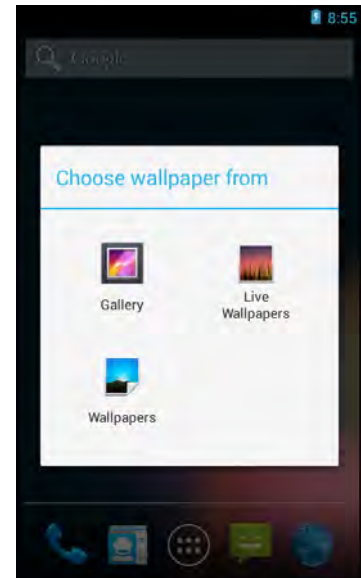

To add shortcut icons or widgets:

1. On the **Home** screen, touch  > **APPS** or **WIDGETS** tab to display the applications/widgets.
2. To add an item, touch and hold the application icon, then drag it to the specific **Home** screen.

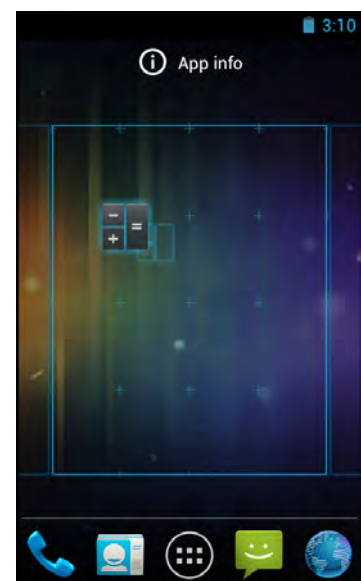

To move items:

Move items from one screen panel to another or rearrange the icons.

1. Touch and hold the desired item until the item is enlarged.
2. Drag and drop the item to the desired location.

To remove items:

1. Touch and hold the desired item to remove.
2. Drag and drop the item to the *Remove* icon until the item turns red.

The application icon is removed from the **Home** screen.

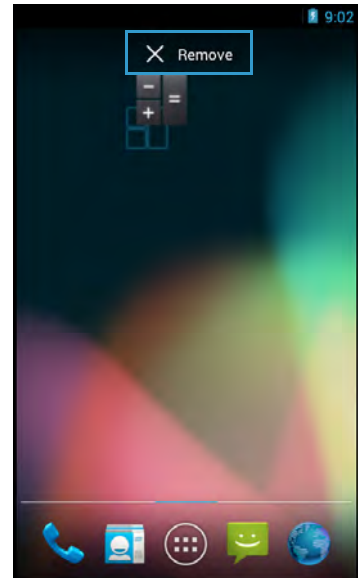

Opening Applications

Touch  > **APPS** tab to access the pre-installed applications and device settings.

- Touch an icon to open the application.
- Swipe the finger left or right to view more applications.

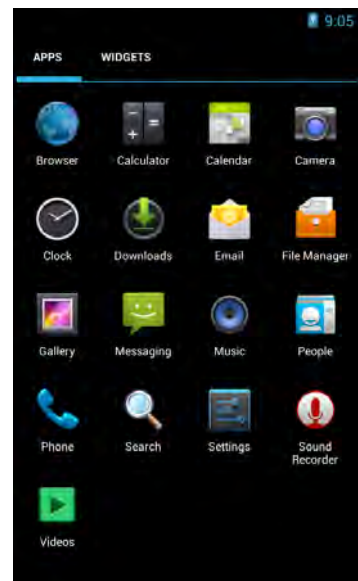

Changing Basic Settings

Setting the Date and Time

Adjust the date and time of the industrial smartphone to provide accurate operation. The time zone can also be set accordingly.

To automatically adjust date and time, perform the following:

1. On the **Home** screen, touch  > **Settings**.
2. In SYSTEM, touch **Date & time**.
3. Touch **Automatic date & time** checkbox to automatically set the date and time according to the network.

To manually adjust date and time, perform the following:

1. On the **Home** screen, touch  > **Settings**.
2. In SYSTEM, touch **Date & time**.
3. Uncheck **Automatic date & time** checkbox.
4. Touch **Set date** to set the date.
 - Swipe the screen up and down on the related field item to adjust the value. Touch **Done** to apply the values.
 - To change the date time format, touch **Choose date format**, and select the date format from the list
5. Touch **Select time zone** to select the time zone from the list.
6. Touch **Set time** to set the time.
 - Swipe the screen up and down on the related field item to adjust the time and touch **Done** to apply the values.
 - To use a 24-hour format, touch **Use 24-hour format** checkbox.

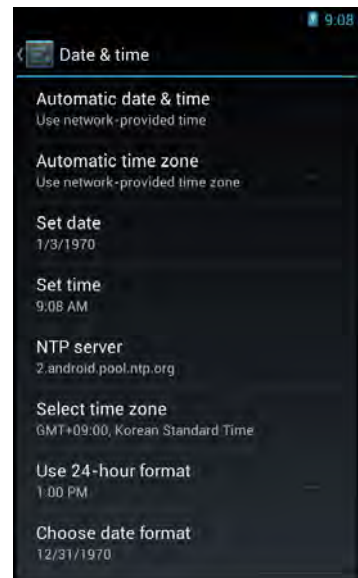

Configuring Display Settings

The industrial smartphone display can be configured in many ways to better suit the working environment.

To adjust the brightness, perform the following:

1. On the **Home** screen, touch  > **Settings**.
2. In DEVICE, touch **Display** > **Brightness**.
3. Drag the slider to adjust the brightness setting.
4. Touch **OK** to confirm.

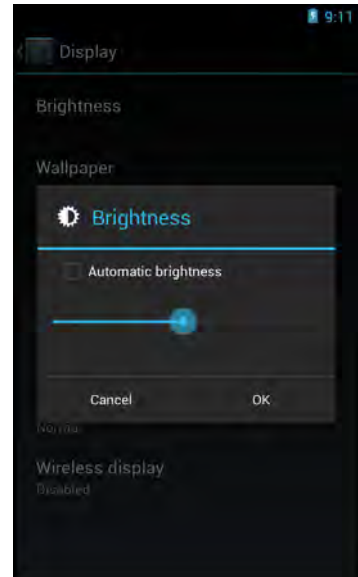

NOTE: To enable the device to automatically adjust the brightness of the screen depending on the surrounding light, touch **Automatic brightness** checkbox. Touch **OK** to confirm.

To specify the idle time before the device automatically enters **Suspend** mode, perform the following:

1. On the **Home** screen, touch  > **Settings**.
2. In DEVICE, touch **Display** > **Sleep**.
3. Select the desired setting.

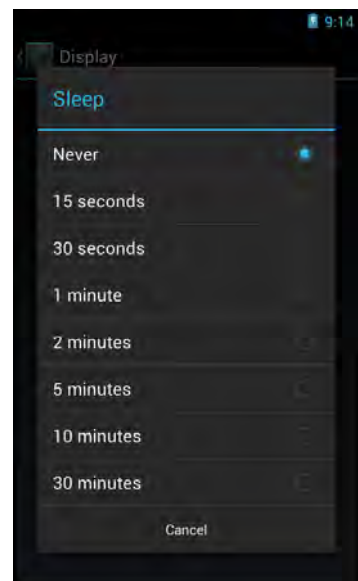

Configuring Sound Settings

The industrial smartphone has several sound settings such as general sound, ringtones, notifications, and alarms.

To adjust the volume, perform the following:

1. On the **Home** screen, touch  > **Settings**.
2. In **DEVICE**, touch **Sound** > **Volumes**.
3. Drag the respective volume slide to adjust the volume.
4. Touch **OK** to confirm the settings.

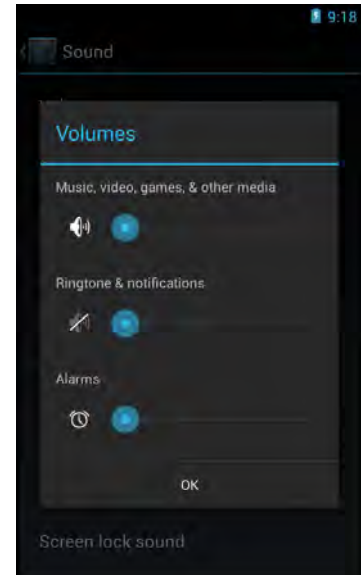

To customize the device ringtones and notifications, perform the following:

1. On the **Home** screen, touch  > **Settings**.
2. In **DEVICE**, touch **Sound** > **Phone ringtone** or **Sound** > **Default notification sound**.
3. Select the desired setting from the available ringtone options.
4. Touch **OK** to confirm the settings.

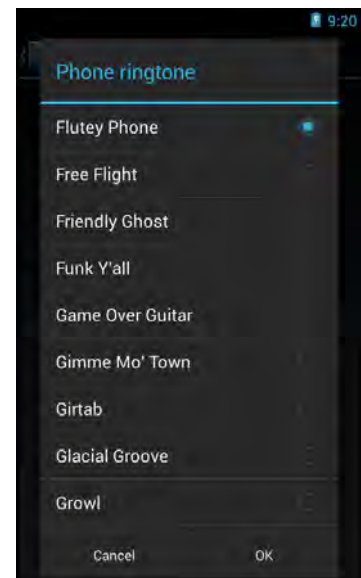

NOTE: To enable the device to vibrate for incoming call or notifications, touch **Vibrate when ringing** checkbox.

Managing Wireless and Network Settings

Connecting to Wireless Networks

To connect to an available wireless network, perform the following:

1. On the **Home** screen, touch  > **Settings**.
2. In **WIRELESS & NETWORKS**, touch **Wi-Fi** and set it to **ON** to enable the Wi-Fi function.
The device searches for available networks within range.
3. Touch an available network connection.
4. If prompted, enter the password to connect to the Wi-Fi network, then touch **Connect**.



NOTE: Password entry is required only for first time connection. Once the device is connected to a network and Wi-Fi is enabled on the device, the device will automatically connect to that network.

Connecting to Bluetooth Devices

To connect to a Bluetooth-enabled device, perform the following:

1. On the **Home** screen, touch  > **Settings**.
2. In **WIRELESS & NETWORKS**, touch **Bluetooth** and set it to **ON** to enable the Bluetooth function.
3. Touch **SEARCH FOR DEVICES** for device to search for compatible Bluetooth devices in range.
4. To connect to a device, touch the device name.
5. Enter the passkey to connect. The passkey must be the same passkey on the other device.

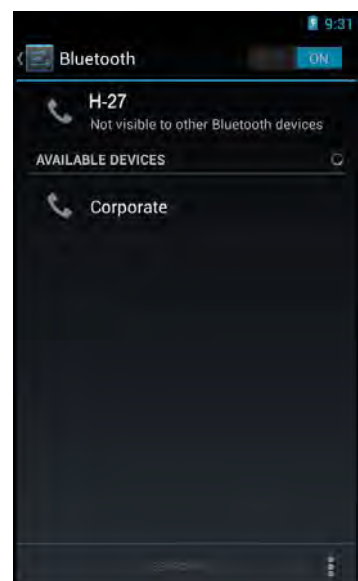



NOTE: Touch “H-27” to make the device visible to other devices.

Configuring Language and Keyboard Settings

Changing the System Language

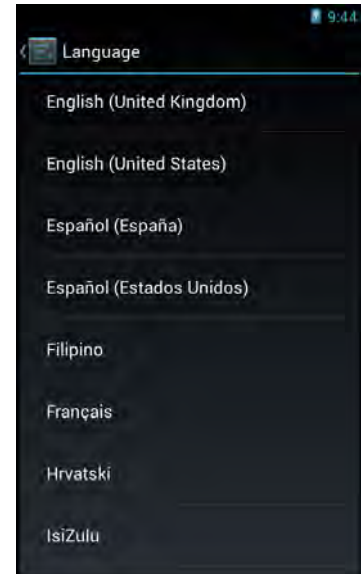

To change the system language, perform the following:

1. On the **Home** screen, touch  > **Settings**.
2. In PERSONAL, touch **Language & input**.
3. Touch **Language**.
4. Touch the desired language.
5. Touch  to return to the previous screen.



Changing the Input Settings

By default, the device uses the Android keyboard. To manage the keyboard settings, perform the following:



1. On the **Home** screen, touch  > **Settings** > **Language & input**.
2. In KEYBOARD & INPUT METHODS, touch **Default** > **Set up input method**.
3. To configure the input method, touch  on the desired keyboard option and change the necessary settings.
4. Touch  to return to the previous screen.



Using the User Dictionary



The device has a built-in user dictionary, allowing users to add words to it.

To add words to the dictionary, perform the following:

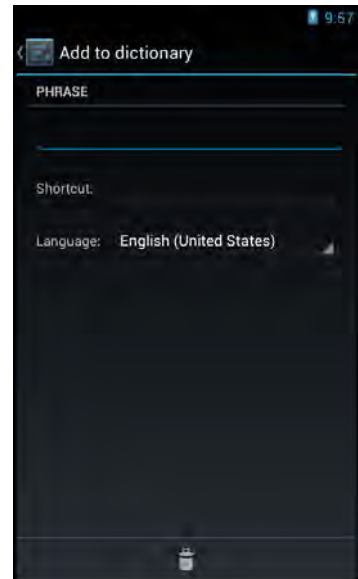

1. On the **Home** screen, touch  > **Settings**.
2. In PERSONAL, touch **Language & input** > **Personal dictionary**.
3. To add words to the dictionary, touch .
4. Type the word to add to the dictionary.
5. Type the shortcut (optional).
6. Repeat steps 3 to 5 to add more words.
7. Touch  to return to the previous screen.



To modify a word in the dictionary, perform the following:

1. On the **Home** screen, touch  > **Settings**.
2. In PERSONAL, touch **Language & input** > **Personal dictionary**.
3. Touch the word to edit.
4. Modify the word and the shortcut (optional).
5. Repeat steps 3 to 4 to modify more words.
6. Touch  to return to the previous screen.

To delete a word from the dictionary, perform the following:



1. On the **Home** screen, touch  > **Settings**.
2. In PERSONAL, touch **Language & input** > **Personal dictionary**.
3. Touch  to delete the word.
The word is removed from the dictionary.
4. Repeat steps 3 to delete more words.
5. Touch  to return to the previous screen.



Advanced Settings

Configuring Location Services

Based on the location, the Location Services settings menu allows interactive options with Google.

1. On the **Home** screen, touch  > **Settings**.
2. In PERSONAL, touch **Location access**.
3. Touch one of the following options:
 - **Access to my location:** Let applications that have asked your permission use your location information.
 - **GPS satellites:** Let applications use GPS on your phone to pinpoint your location.
 - **Wi-Fi & mobile network location:** Let applications use Google's location service to estimate your location faster. Anonymous location data will be collected and sent to Google.
4. Touch  to return to the previous screen.

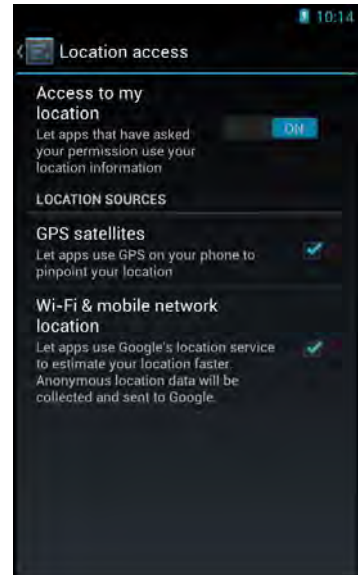

Configuring Security Settings

Use the Security settings menu to configure the device security options.

1. On the **Home** screen, touch  > **Settings**.
2. In PERSONAL, touch **Security**.
3. Touch one of the following options:
 - **Screen lock:** Use slide or set up a pattern, PIN, or password to lock or unlock the screen.
 - **Owner info:** Select to show owner info on the Lock screen.
 - **Set up SIM/RUM card lock:** Set up SIM card to lock or change the SIM pin codes.
 - **Make passwords visible:** Check the box to show the password when the data is entered.
 - **Device administrators:** View or deactivate device administrators.

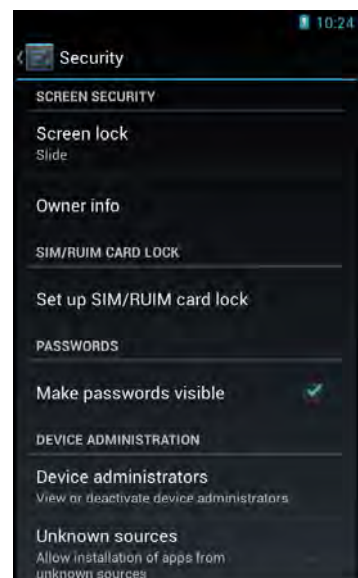

- **Unknown sources:** Check the box to allow installation of applications from unknown sources.
- **Verify apps:** Disallow or warn before installation of apps that may cause harm.
- **Trusted credentials:** Allow applications to display trusted CA certificates.
- **Install from storage:** Install encrypted certificates from memory card.
- **Clear credentials:** Clear credential storage of all contents and reset its password.

4. Touch  to return to the previous screen.

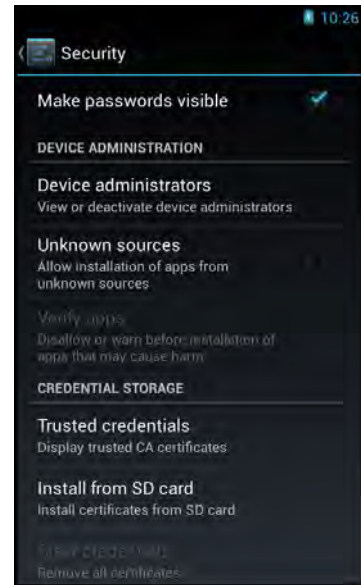



Adding an Account

Synchronize the data, email, calendar and other information of an account with the device.

To add an Exchange account, perform the following:

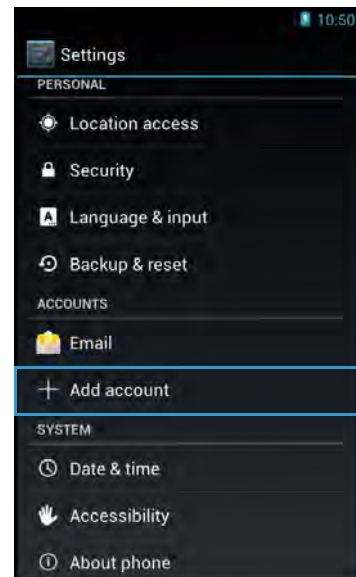
1. On the **Home** screen, touch  > **Settings**.
2. In ACCOUNTS, touch **Add account**.



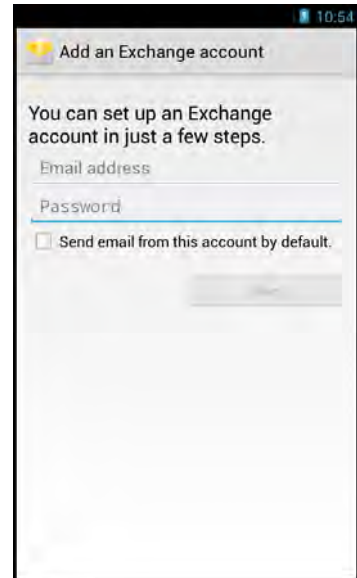

3. Touch **Corporate**.
4. Enter the **Email address** and **Password**.
NOTE: If there are more than one accounts, check the **Send email from this account by default** box to set the current account as the default account.
5. Touch **Next** to continue.
6. Enter the required information such as **Domain** or **Username**, **Password**, **Server** (for Exchange account), etc.
NOTE: Obtain these information from the network administrator or service provider.
7. Touch **Next** to continue and complete the wizard.
8. Touch  to return to the previous screen.





To add an Email account, please refer to “Email” on page 33.

To synchronize accounts, perform the following:

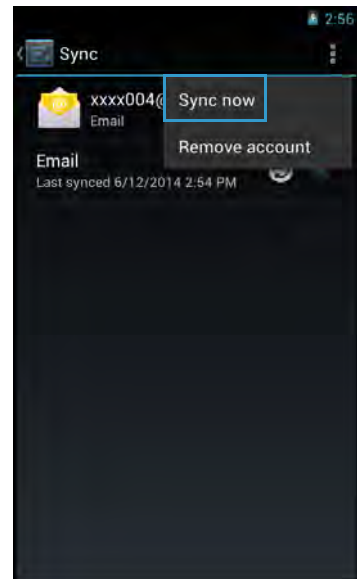
1. On the **Home** screen, touch  > **Settings**.
2. In ACCOUNTS, touch **Email**.
3. Touch the desired account to synchronize.
4. Check the boxes of the desired data to sync, such as **Email**.
5. Touch  > **Sync now**.
6. Touch  to return to the previous screen.



To remove an account, perform the following:

1. On the **Home** screen, touch  > **Settings**.
2. In ACCOUNTS, touch **Email**
3. Touch the desired account to remove.
4. Touch  > **Remove account**.
5. A confirmation message appears. Touch **Remove account** to confirm.
6. Touch  to return to the previous screen.

Managing Storage Space



Use the Storage settings menu to view the total and available space on the device. The device has two storage sources:

- **USB STORAGE:** The internal storage
- **SD CARD:** The micro SD card

To view the total and available storage space, do the following:

1. On the **Home** screen, touch  > **Settings**.
2. In DEVICE, touch **Storage**.

To unmount the memory card for safe removal, perform the following:

1. On the **Home** screen, touch  > **Settings**.
2. In DEVICE, touch **Storage**.
3. Touch **Unmount SD card**.
4. A confirmation message appears on the status bar. Touch **OK** to confirm.
5. Touch  to return to the previous screen.
6. Turn off the device and remove the memory card.

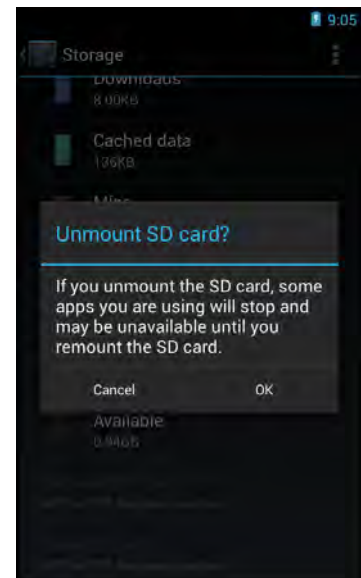

Application and Operation

This chapter covers information on how to use pre-installed applications and customize related settings.

Browser

Use **Browser** to view web pages.

Launching a Web Page

1. On the **Home** screen, touch  > **Browser**.
2. Touch the address bar.
NOTE: If the address bar is not visible, swipe down the screen.
3. Enter the URL on the address bar
4. Touch **Go** on the on-screen keyboard.

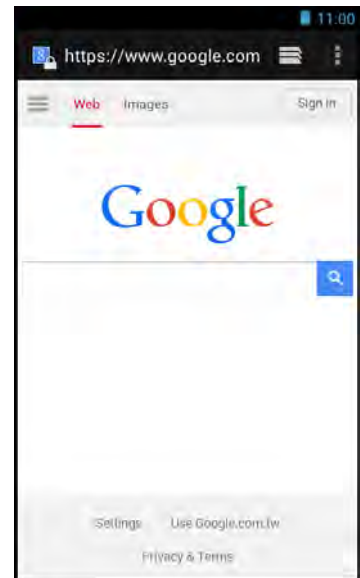

NOTE: Be sure that the device is properly connected to Internet either via Wi-Fi connection or mobile data network.

Viewing the Current Web Page

To zoom in on the current page, move the two fingers apart from each other at the location of the screen to zoom in.

In **zoom** mode, swipe the finger up/down and left/right to scroll on the page.

To zoom out on the current page, move the two fingers closer together at the location of the screen to zoom out.

Managing Web Pages

Touch  to change the view current setting or configure other functions.

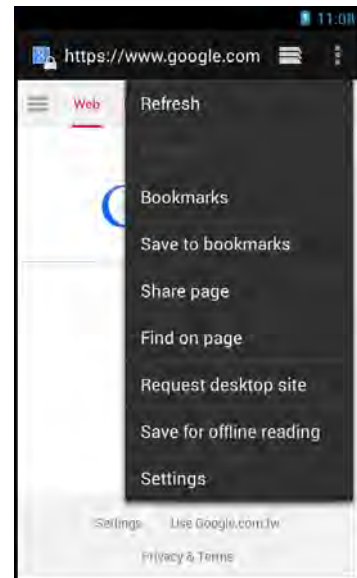

- **Refresh:** Select to reload current web page.
- **Forward:** Select to go to the next page.
- **Bookmarks:** Select to view bookmarks, history, or saved pages.
- **Save to bookmarks:** Select to save favorite web pages as bookmarks.
- **Share page:** Select to share the current page via Bluetooth, Email, or Messaging.
- **Find on page:** Select to find texts on the current web page.
- **Request desktop site:** Select to open the current web page in desktop display mode.
- **Save for offline reading:** Select to save the current web page to be available even when the internet service is not available.
- **Settings:** Select to configure other advanced settings.



NOTE: The availability of options varies depending on the current web page.

Additional Web Page Features

Touch  to add or close tabs, view bookmarks, browsing history, saved pages, and configur browser settings. Do any of the following:

- Touch  to add new tabs.
- Touch  to view **BOOKMARKS** tab, browsing **HISTORY** tab, or **SAVED PAGES** tab.
- Touch  to open **New incognito tab**, **Close other tabs**, view **History tab**, **Saved pages**, or configure **Settings**.





Camera

Use **Camera** to capture photos and panorama shots and record videos.

Capturing Photos

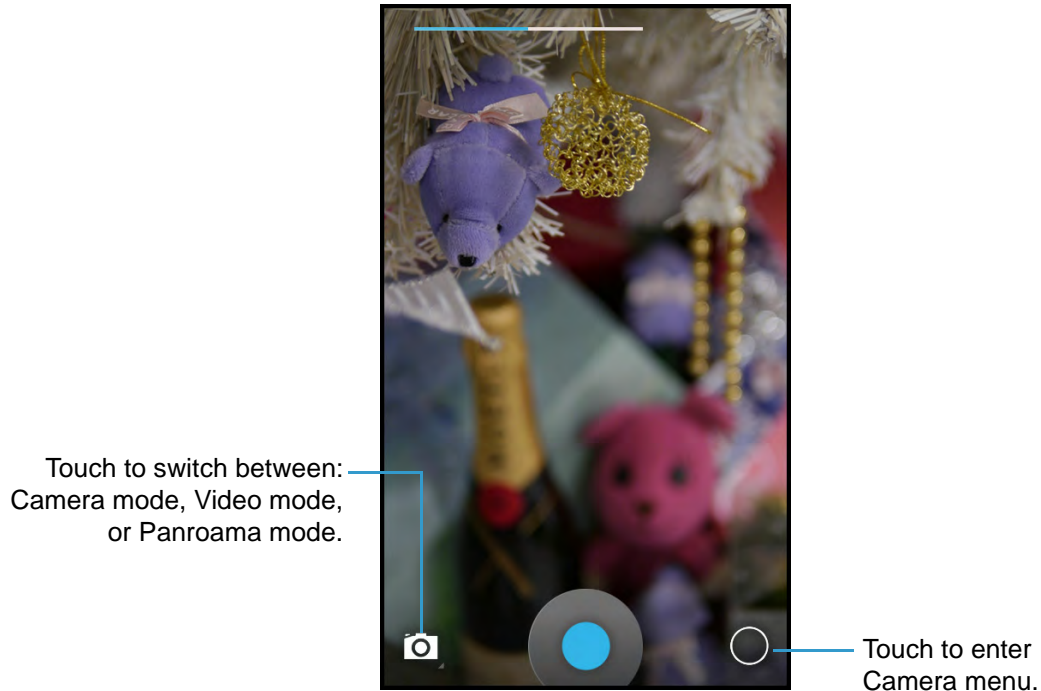



1. On the **Home** screen, touch  > **Camera**.



2. Aim the device at the subject.
 - To zoom in on the subject, move your fingers apart from each other at the location of the screen where you want to zoom in.
 - To zoom out on the subject, move your fingers closer together at the location of the screen where you want to zoom out.
3. Touch  to capture the shot.

Reviewing Photos

Slide the screen to the right to view the latest captured photos.

- Touch  to **Delete** the photo, switch to **Slideshow**, **Edit**, **Rotate left/right**, **Crop**, **Set picture as**, or view **Details** of the photo.
- Touch  to choose a sharing application (i.e. Bluetooth, Messaging, Email) to share the current photo.
- Touch  to view photos or videos in a **Filmstrip** or **Grid**.
- Touch  to view other recorded photos or videos in Gallery.

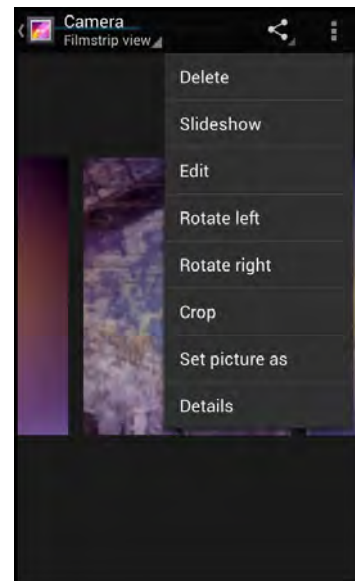

Configuring Camera Settings









Touch  to open the camera menu.

NOTE: You can open the camera menu also by touching and holding the Camera screen.



Perform the following:

- Touch  to configure the basic camera settings.
Available options: Color effect (None/Mono/Sepia/Negative/Solarize/Posterize/Aqua/Emboss/Sketch/Neon), Face Detection (OFF/ON), Saturation (Level 1 ~ Level 10), Contrast (Level 1 ~ Level 10), Sharpness (Level 0 ~ Level 6), Select Auto Exposure (Frame Average/Center Weighted/Spot Metering), Scene mode (Auto/Action/Night/Sunset/Party/ASD/Portrait/Landscape/Night Portrait/Theatre/Beach/Snow/Steady Photo/Fireworks/Sports/Candlelight/Backlight/Flowers/AR, Store location (OFF/ON), Picture size (VGA/CIF/QVGA/QCIF), Histogram (Disable/Enable), Select Picture Format (Jpeg/Raw), Picture quality (Jpeg 55%/Jpeg 65%/Jpeg 75%/Jpeg 85%/Jpeg 95%/Jpeg 100%/Super fine/Fine/Normal), ZSL (OFF/ON), Anti Banding (Off/50Hz/60Hz/Auto), Select ISO (Auto/ISO Auto(HJR)/ISO100/ISO200/ISO400/ISO800/ISO1600), Wavelet Denoise Mode (OFF/ON), Redeye Reduction (Disable/Enable), AE-Bracket (OFF/ON).





- Touch  (High Dynamic Range) to turn the mode on or off. This mode adds more ratio of light to dark in your photographs. If this mode is turned on, use the following options:
 - Touch  to change the white balance settings. The available options are:
 (Cloudy),  (Daylight),  (Auto),  (Fluorescent), or  (Incandescent).
- Touch  to adjust the image exposure, saturation, contrast, and sharpness.
Available options: -2 ~ 2.

Recording Videos

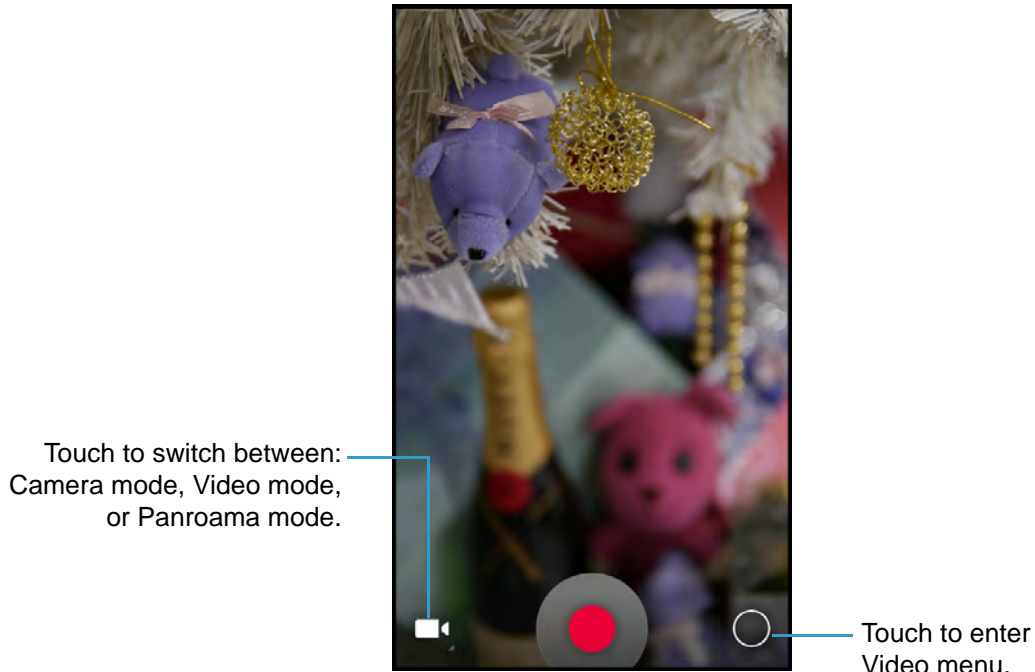



1. On the **Home** screen, touch  > **Camera**.
2. Touch  and select  to switch to **Video** mode.



3. Aim the device at the subject.
4. Touch  to start recording the video.
 - To zoom in on the subject, move your fingers apart from each other at the location of the screen where you want to zoom in.
 - To zoom out on the subject, move your fingers closer together at the location of the screen where you want to zoom out.
5. Touch  to stop recording.

Reviewing Videos

Slide the screen to the right to view the latest captured photos.

- Touch  to **Delete** the video, **Rotate**, or view **Details** of the video.
- Touch  to choose a sharing application (i.e. Bluetooth, Email) to share the current video.
- Touch  to view photos or videos in a **Filmstrip** or **Grid**.
- Touch  to view other recorded photos or videos in Gallery.

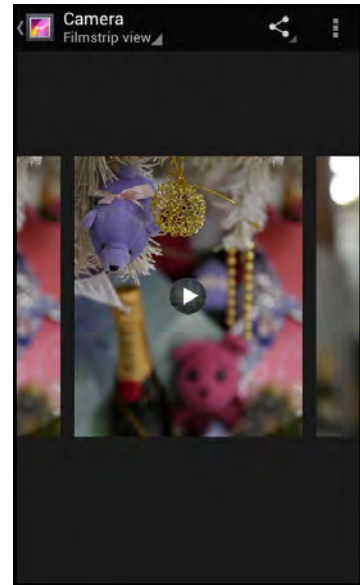







Configuring Video Settings

Touch  to open the video menu.



NOTE: You can open the video menu also by touching and holding the Camera screen.

Perform the following:

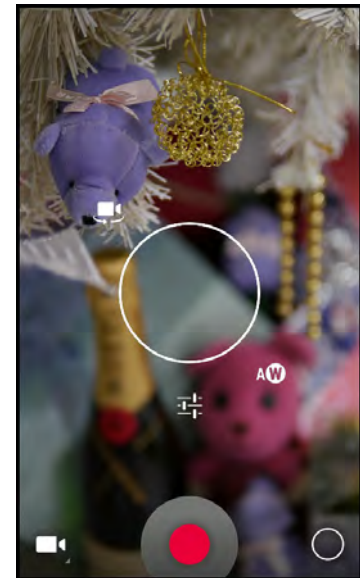
- Touch  to configure the basic video settings.
Available options: Time lapse (Off/On), Video quality (VGA/CIF/QVGA/QCIF), Store location (ON/OFF), Video Encoder (MPEG4/H263/H264), Audi Encoder (AMRNB/AAC), Video duration (30 seconds (MMS)/10 minutes/30 minutes), Color effect (None/Mono/Sepia/Negative/Solarize/Posterize/Aqua/Emboss/Sketch/Neon/), Video High FrameRate (Off/On), Power Mode (Low_Power/Normal_Power).
- Touch  to change the white balance settings.
Available options:  (Cloudy),  (Daylight),  (Auto),  (Fluorescent), or  (Incandescent).



Capturing Panorama Shots

1. On the **Home** screen, touch  > **Camera**.
2. Touch  and select  to switch to **Panorama** mode.



3. Aim the device at the subject.
4. Touch  to start capturing the shot.
5. Pan the device horizontally and follow the shooting guideline as shown on the screen.

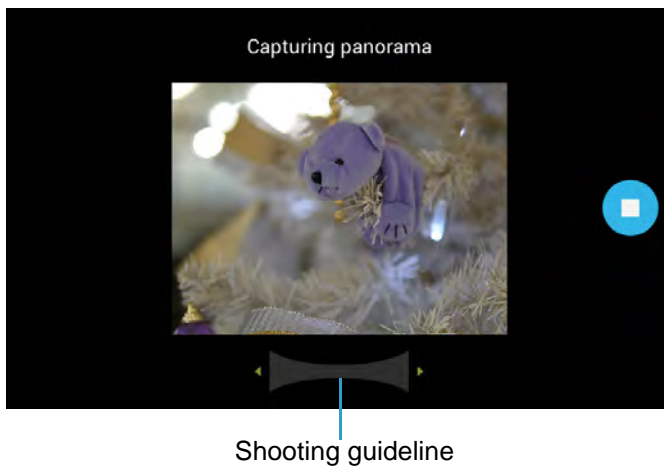

6. Touch  to stop shooting.

Email

Use the device to send and receive emails using Internet email accounts.

Setting up an Email Account

1. On the **Home** screen, touch  > **Email**.
2. Enter the email address and password.
3. Touch **Next**.

NOTE: Touch **Manual setup** to manually configure the email.

NOTE: To setup an Exchange email account, refer to “Adding an Account” on page 22.

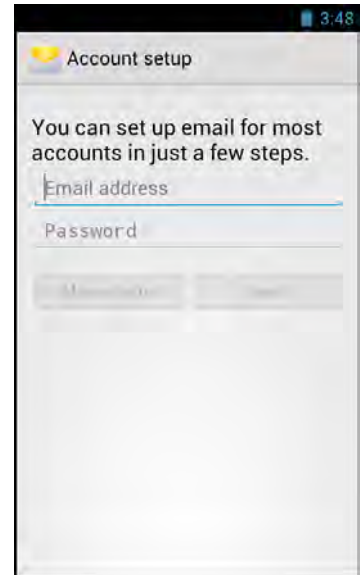

4. Set the *Inbox checking frequency* setting and touch other options box to enable the necessary settings.
5. Touch **Next** to continue.

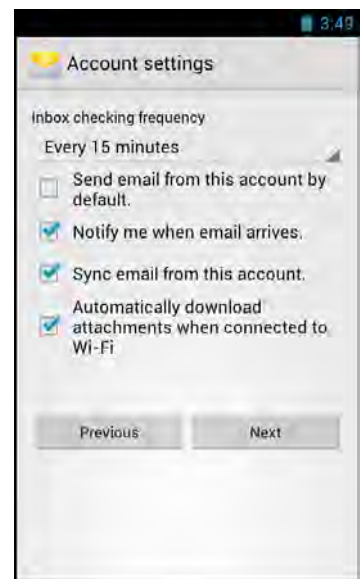

6. Enter the account and display names and touch **Next**.



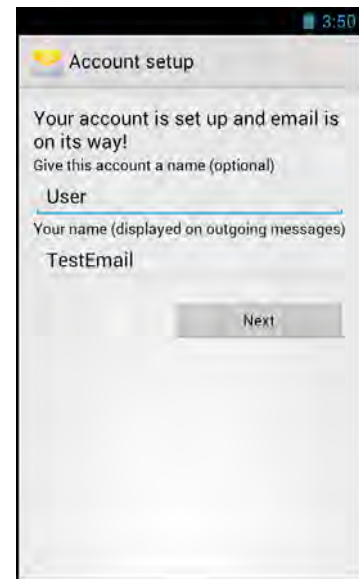

Once the account setup is complete, the device will automatically retrieve the emails.



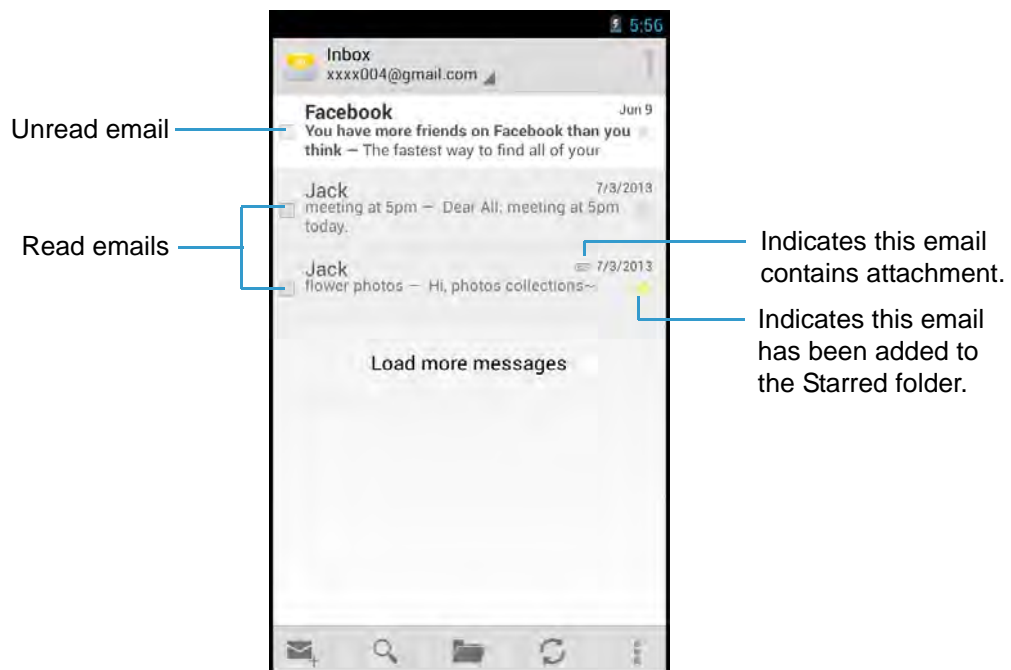

Viewing Emails

By default, emails are automatically saved in the *Inbox* folder.



- Touch  to manually receive emails.
- Touch  to view other folders.
- Touch  to search email that contains specific text in the current folder.
- Touch  to compose a new email.
- Touch  to configure email account settings.

Composing and Sending an Email





1. On the **Home** screen, touch  > **Email**.
2. Touch .
3. Enter the recipient's email address in the *To* field.
4. Enter a subject in the *Subject* field (if necessary).
5. Compose the email.

NOTE: To add attachments to emails, touch  > **Attach file**. Then select the file to attach.

6. Touch  to send the email.



Reading and Replying an Email

1. On the **Home** screen, touch  > **Email**.
2. Touch an email to open it.
3. Perform any of the following:
 - To reply the email, touch  or touch  > **Reply all**.
 - To forward the email, touch  > **Forward**. Then enter the recipient email in the *To* field.
 - To view the attachment, touch the **Attachments** tab. To save the file into the device, touch **SAVE**.

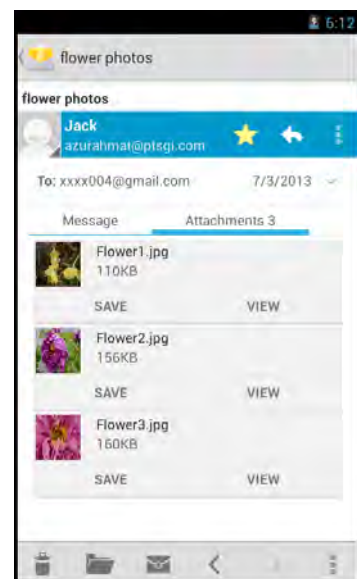

NOTE: To view the attached photo in full screen, touch **VIEW**.

4. Compose the email.
5. Touch  to send the email.





Deleting Emails

To delete an email at a time, perform the following:

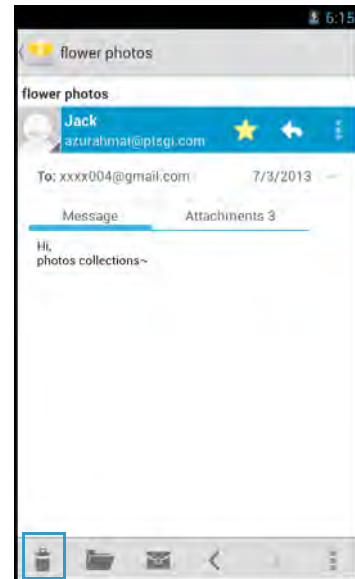
1. On the **Home** screen, touch  > **Email**.
2. Touch an email to open it.
3. Touch  to delete the current email.



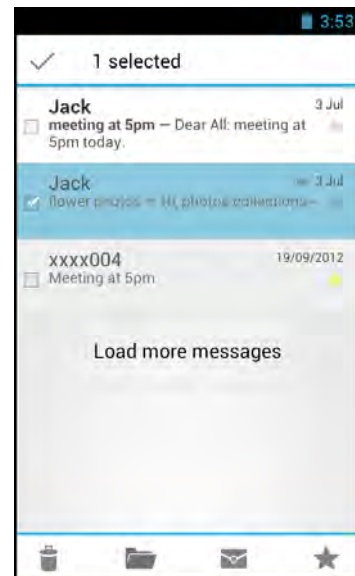

To delete selected emails in the same folder, perform the following:

1. On the **Home** screen, touch  > **Email**.
2. Touch and hold the desired email to delete. Select other email(s) if necessary.
3. Touch  to delete the selected email(s).





Adding Other Email Accounts

1. On the **Home** screen, touch  > **Email**.
2. Touch  > **Settings**.
3. Touch **ADD ACCOUNT**.
4. Repeat Steps 2~6 in “Setting up an Email Account” on page 33.

NOTE: Check the **Send email from this account by default** box to set this new account as the default email account.



Customizing Email Settings

1. On the **Home** screen, touch  > **Email**.
2. Touch  > **Settings**.
3. Touch **General** or an **email account**.
4. Touch an option and change the necessary settings.

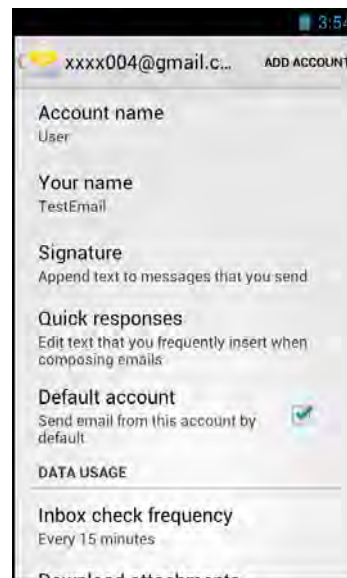

File Manager

Use **File Manager** to browse and manage files/folders stored in the internal memory (the device) or the memory card installed in the device.



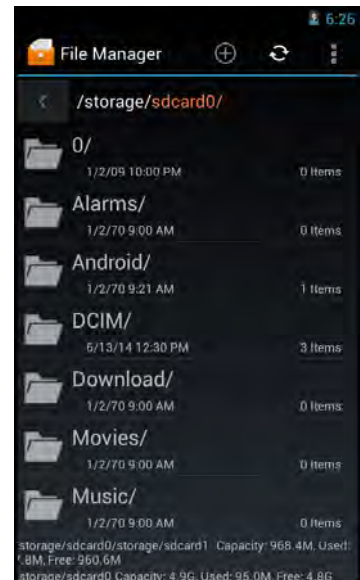

Browsing Files

1. On the **Home** screen, touch  > **File Manager**.
2. Browse the folder list and touch the folder to explore.



Managing Files and Folders

Perform one of the following:

- To create a new folder, touch . Enter the folder name and touch **OK**.
- To rename the folder or file, touch and hold the item and touch **Rename**. Enter the new name and touch **OK**.
- To sort item by name, touch  > **Sorting by Name**.
- To copy file or folder, touch and hold the item to copy and touch **Copy**. To paste the file or folder, select the destination path and touch  > **Paste**.
- To delete a file or folder, touch and hold the item to delete and touch **Delete**. Touch **OK** to confirm the deletion.
- To move a file or folder, touch and hold the item to move and touch **Cut**. To paste the file or folder, select the destination path and touch  > **Paste**.

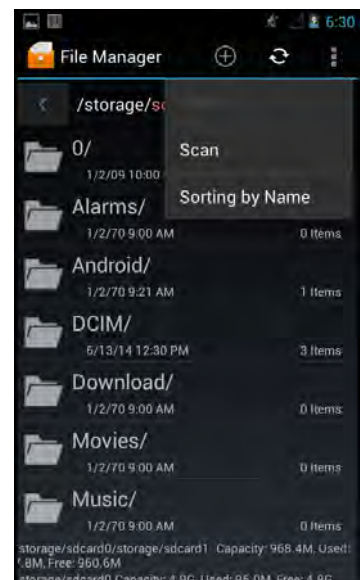





Gallery

Use **Gallery** to view captured photos, recorded videos, or downloaded photos stored in the internal memory (the device) or the memory card installed in the device.

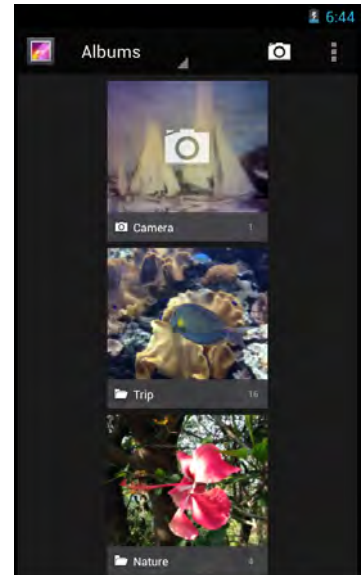
Viewing Photos





1. On the **Home** screen, touch  > **Gallery**.
2. Touch the desired album/folder.
The recorded files are displayed in thumbnails.

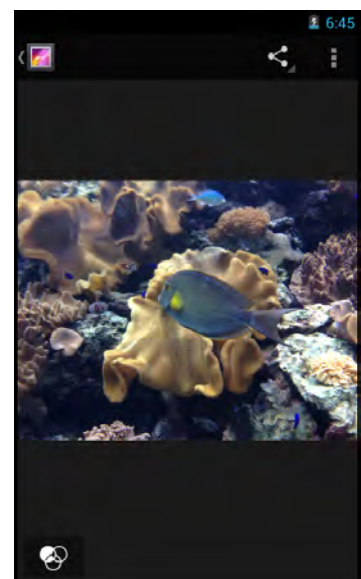

3. Touch the desired image to view it in full screen.
4. Perform the following:
 - To view other files, swipe the finger to the left or right.
 - To share this photo, touch  and select the desired sharing application.
 - To delete or edit this photo, play the slideshow, or show more options, touch .
 - To apply effect or edit the photo, touch .



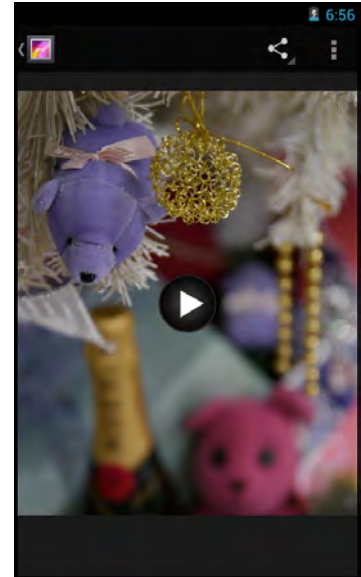

Playing Videos

1. On the **Home** screen, touch  > **Gallery**.
2. Touch the desired album/folder.
The recorded files are displayed in thumbnails.
3. Touch the desired video to playback.
4. Perform one of the following:
 - To play the video, touch .
 - To view other files, swipe the finger to the left or right.
 - To share this video, touch  and select the desired sharing application.
 - To delete this video or show more options, touch .



Playing Slideshow

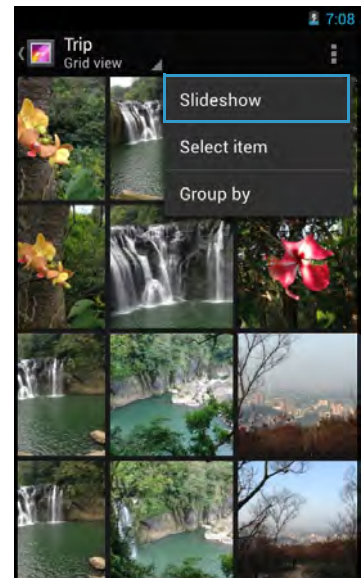

1. On the **Home** screen, touch  > **Gallery**.
2. Touch the desired album/folder.
The recorded files are displayed in thumbnails.
3. Touch  > **Slideshow** to start the slideshow.
4. To stop the slideshow at anytime, touch the screen.



Messaging

Use **Messaging** to send and receive text and MMS messages.





Creating and Sending a Text Message

1. On the **Home** screen, touch  > **Messaging**.
2. Touch .
3. Enter the recipient's phone number in the *To* field.
4. Compose the message.
5. Touch  to send the message.

NOTE: By exiting *Messaging* before sending the message, the unsent message will be automatically saved as a draft.



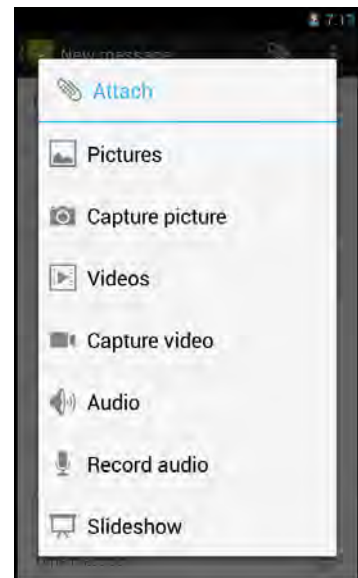

Adding an Attachment to a Message

1. On the **Home** screen, touch  > **Messaging**.
2. Touch .
3. Enter the recipient's phone number in the *To* field.
4. Compose the message.
5. Touch  to add an attachment and select one of the following options:
 - **Pictures:** Select to attach a photo from Gallery.
 - **Capture picture:** Select to take a picture to attach.
 - **Videos:** Select to attach a video clip.
 - **Capture video:** Select to record a video to attach.
 - **Audio:** Select to attach an audio file.
 - **Record audio:** Select to record the voice to attach.
 - **Slide show:** Select to attach a slideshow.
6. Touch  to send the message.



Configuring Messaging Settings

1. On the **Home** screen, touch  > **Messaging**.
2. Touch  > **Settings**.
3. Touch an option and change the necessary settings:
 - **Delete old messages:** Select this option to delete old messages as limits are reached.
 - **Text message limit:** Select to specify the maximum limit of text message per conversation.
 - **Multimedia message limit:** Select to specify the maximum limit of multimedia message per conversation.
 - **Delivery reports:** Select to request a delivery report for each sent text message.
 - **Manage SIM card messages:** Select to manage messages stored on the SIM card.
 - **Delivery reports (MMS):** Select to request a delivery report for each sent multimedia message.
 - **Read reports:** Select to request a read report for each sent multimedia message.
 - **Auto-retrieve:** Select to automatically retrieve new messages.
 - **Roaming auto-retrieve:** Select to automatically retrieve new messages while roaming.
 - **Notifications:** Select to display message notifications in status bar.
 - **Sound:** Select to choose a ringtone of new messages.
 - **Vibrate:** Select to disable/enable vibration when new message is received.
 - Touch  to **Restore default settings**.

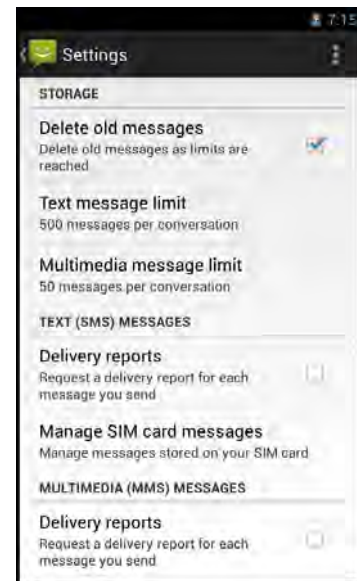

Music

Use **Music** to listen to the favorite songs using the device.

Playing a Song

1. On the **Home** screen, touch  > **Music**.
2. Touch the **Songs** tab.
All songs are displayed on the screen.

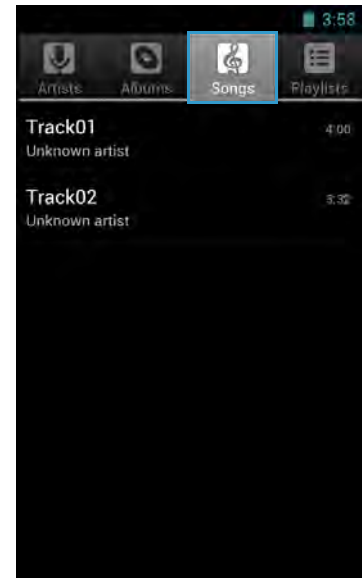

3. Touch a song to play.

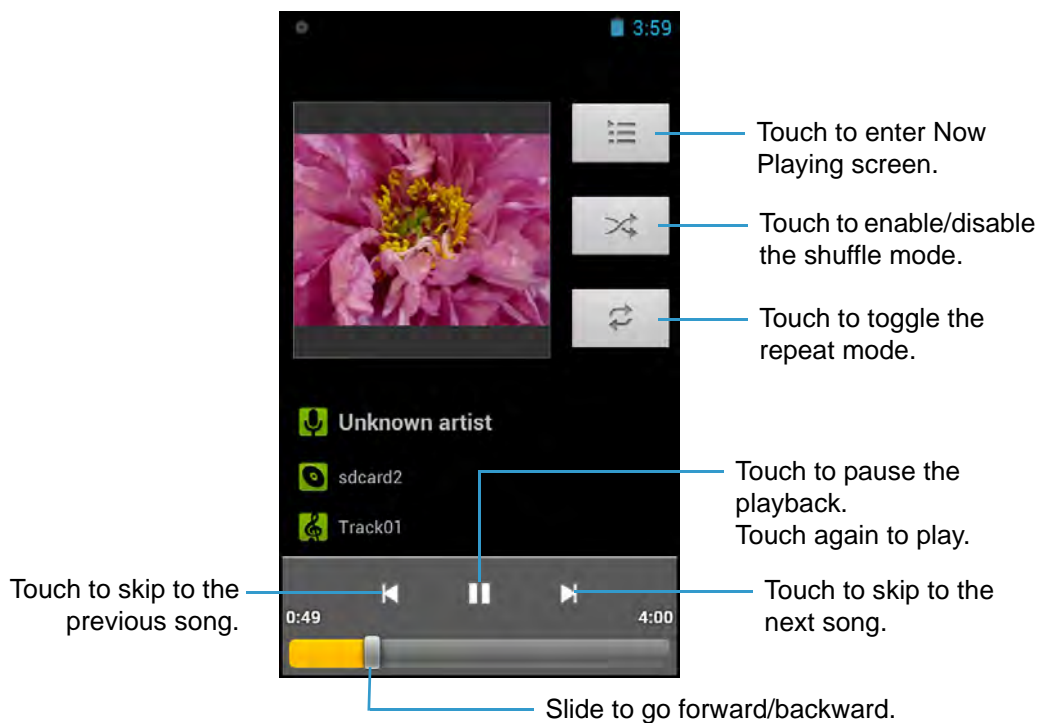

Creating a Playlist

1. On the **Home** screen, touch  > **Music**.
2. Touch and hold the desired song to add.
3. Touch **Add to playlist**.
4. Select a playlist.
To create a new playlist, touch **New**. Enter the new playlist name and touch **Save**.

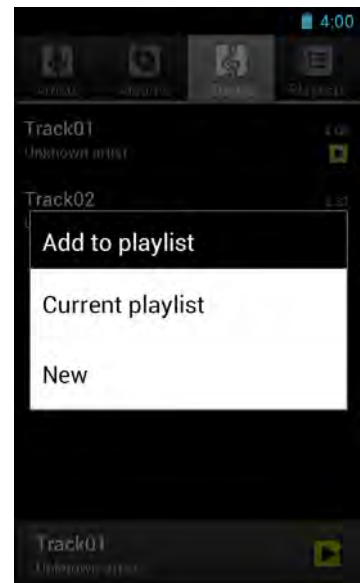

Assigning a Song as Ringtone

1. On the **Home** screen, touch  > **Music**.
2. Touch and hold the desired song to be the device ringtone.
3. Touch **Use as phone ringtone**.

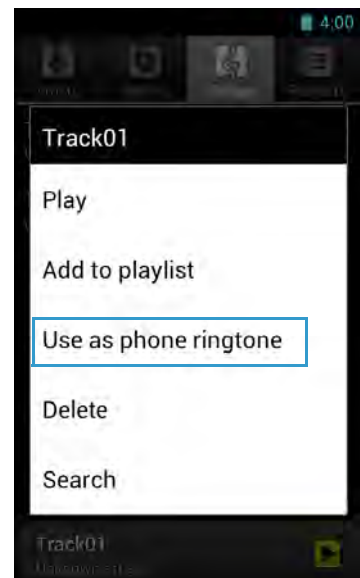

Deleting a Song

1. On the **Home** screen, touch  > **Music**.
2. Touch and hold the desired song to delete.
3. Touch **Delete**.
4. Touch **OK** to delete the selected song.

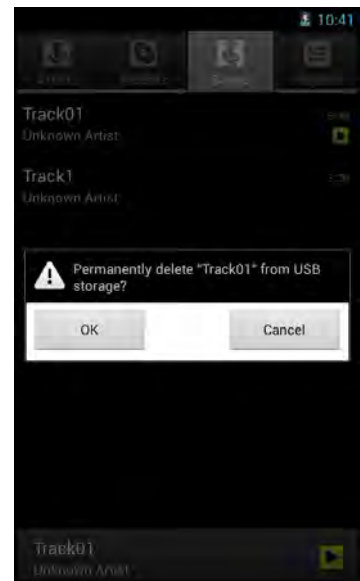

People

Use **People** to view and manage the contact list.

Adding a New Contact

1. On the **Home** screen, touch  > **People**.
2. Touch **Create a new contact**.
3. Touch one of the following:
 - **New Contact in Device:** To save the new contact to the phone memory.
 - **New Contact in Card:** To save the new contact to the memory card.

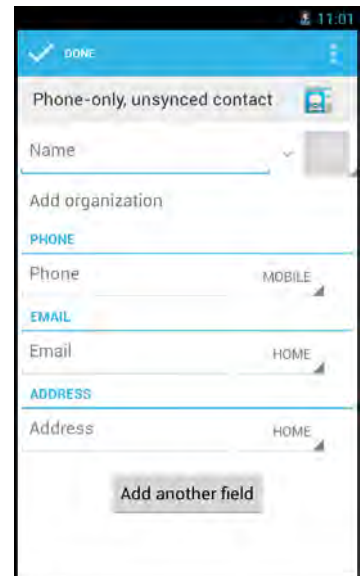
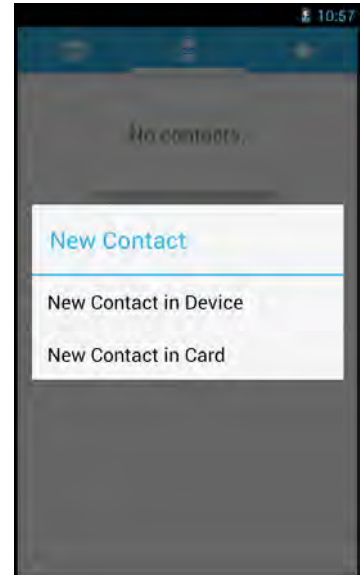

NOTE: By default your new contact information will not be backed up. If you want to back up the contact online, touch **Add account** and fill in the account information. If you do not want to back up your contact information, touch **Keep local**.

4. Enter the contact information such as name, phone number, email address, home address, and other related data.
5. Touch **DONE** to save the contact.



Importing/Exporting Contacts

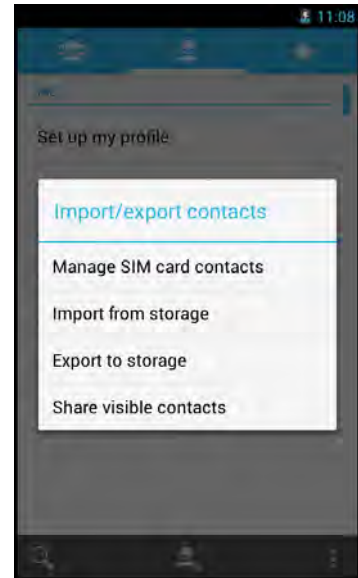

To import/export contacts from/to the SIM card or storage, perform the following:

1. On the **Home** screen, touch  > **People**.
2. Touch  > **Import/export** and choose one of the following options:
 - **Manage SIM card contacts.**
 - **Imports from storage.**
 - **Export to storage.**
3. If you choose to export contacts, you are prompted to confirm the destination file. Touch **OK** to confirm.





Managing Contacts

To edit a contact information, perform the following:

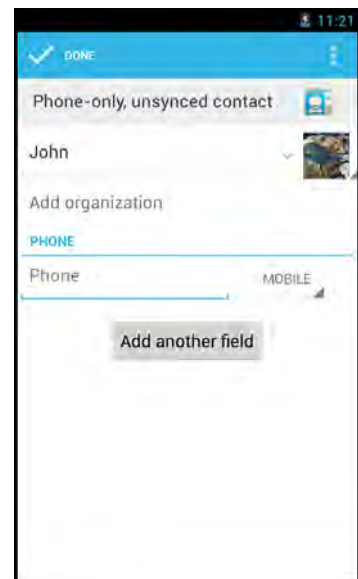

1. On the **Home** screen, touch  > **People**.
2. Touch the desired contact to modify.
3. Touch  > **Edit**.
4. Modify the necessary information and/or touch **Add another field** to add additional information.
5. Touch **DONE** to save the changes.





To share a contact information, perform the following:

1. On the **Home** screen, touch  > **People**.
2. Touch the desired contact to share.
3. Touch  > **Share**.
4. Select the desired sharing application to send the contact information.



To assign a contact ringtone, perform the following:

1. On the **Home** screen, touch  > **People**.
2. Touch the desired contact to assign a ringtone to.
3. Touch  > **Set ringtone**.
4. Select the desired ringtone and touch **OK** to confirm.





To delete a contact, perform the following:

1. On the **Home** screen, touch  > **People**.
2. Touch the desired contact to delete.
3. Touch  > **Delete**.
4. Touch **OK** to confirm the deletion.

To send all calls from specific contact to voicemail, perform the following:



1. On the **Home** screen, touch  > **People**.
2. Touch the desired contact to revert all calls directly to voicemail.
3. Touch  > **All calls to voicemail**.

To add a contact to Favorite list, perform the following:

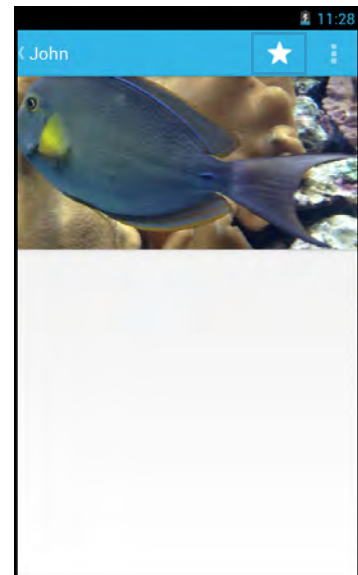
1. On the **Home** screen, touch  > **People**.
2. Touch the desired contact to add to the Favorite list.
3. Touch  and it turns , indicating the current contact has been added to the Favorite list.
4. Touch Favorite tab () to view the favorite contact(s).



To remove a specific contact from Favorite list, perform the following:



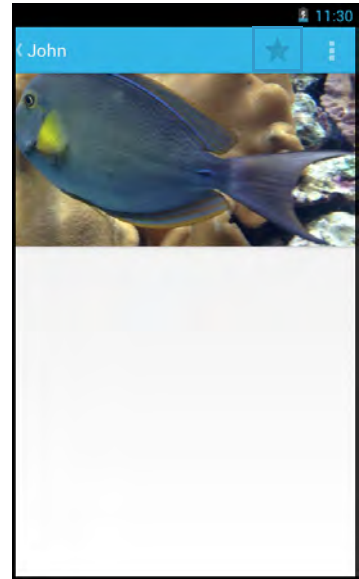

1. On the **Home** screen, touch  > **People**.
2. Touch the desired contact to remove from the Favorite list.
3. Touch  and it turns , indicating the current contact has been removed from the Favorite list.





Phone

Use **Phone** to make or receive a phone call using the device.

Making a Call

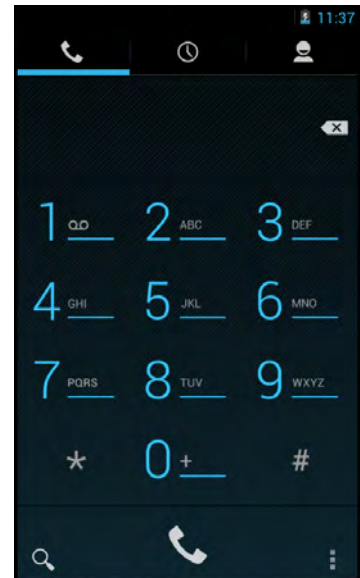



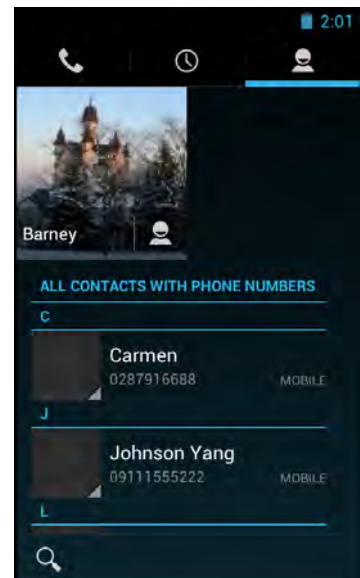

1. On the **Home** screen, touch  > **Phone**.
2. Enter the phone number using the on-screen keypad.
 - To delete a wrong number, touch .
 - To delete the entire number, touch and hold .
3. Touch  to make a call after the user finishes entering the phone number.
4. To end the call after dialing, touch .





NOTE: As an alternative, calls can be made directly from the contact lists. Touch **People** () tab and touch the desired contact's phone number.



Answering a Call

- To answer a call, touch  and drag it to the  icon.
- To reject the call, touch  and drag it to the  icon.
- To reject and send a message directly to the caller, touch  and drag it to the  icon.

NOTE: When the  icon is touched, it automatically changes to .

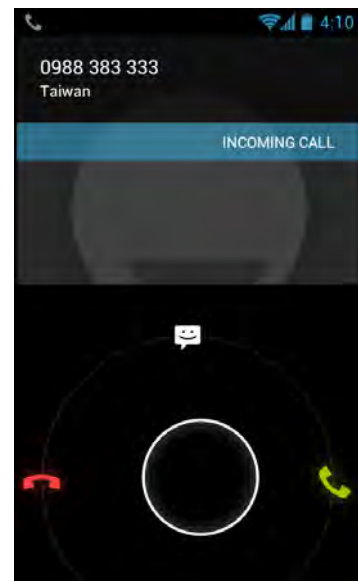



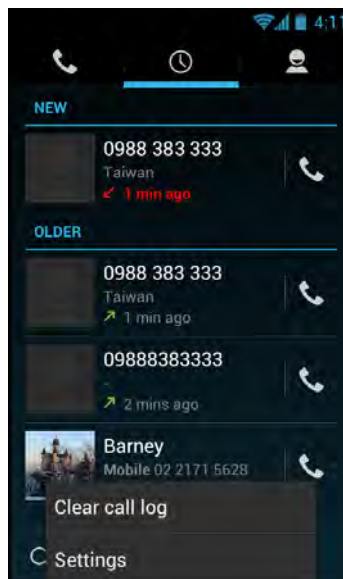

Viewing Call Log

The Call Log screen displays the recent outgoing, received, or missed calls.

To view the Call Log screen, touch the Call Log () tab.



- To remove an entry from the list, select the desired entry and touch  > **Remove from call log**.
- To edit the phone number before making a call, touch  > **Edit number before call**. Edit the phone number and touch  to make a call.
- To clear all call log, touch  > **Clear call log**. Touch **OK** to confirm.
- To configure the call settings, touch  > **Settings**. Tap the desired option and change the necessary settings.

Barcode Scanner Module

This device is equipped with a barcode scanner module which supports many of the popular barcode formats currently used worldwide.

NOTE: During the system initialization (after powering on the device for the first time or resetting the device to factory default), the scanner will take approximately 30 seconds to be activated. It is highly recommended not to press the barcode scan trigger key within 30 seconds.

Configuring Barcode Reader Settings

Before scanning a barcode, configure the scanner settings.

1. On the **Home** screen, touch  > **Settings** > **Barcode Reader**.
2. Touch one of the following options:
 - **Barcode reader:** Check the box to enable barcode module function.
 - **Prefix Suffix settings:** Configure the prefix and suffix characters.
 - **Code readable settings:** Configure the code readable settings.
 - **Code options:** Configure the code options.
 - **Read options:** Configure the read options including read mode, read time, margin, redundancy, positive and negative, and scan angle settings.
 - **Output mode:** Select the output mode.
 - **Intent mode settings:** Set the intent action and category.
 - **Trigger button:** Specify which button(s) to be used as trigger key(s).
 - **Handle barcodes with URI content:** Enable URI content support.
 - **Restore factory default settings:** Return all barcode reader settings to the factory default settings.
 - **Backup current settings:** Back up the current barcode reader settings.
 - **Restore settings:** Restore the current barcode reader settings.

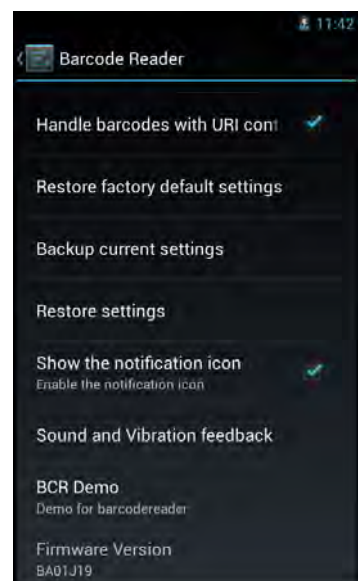
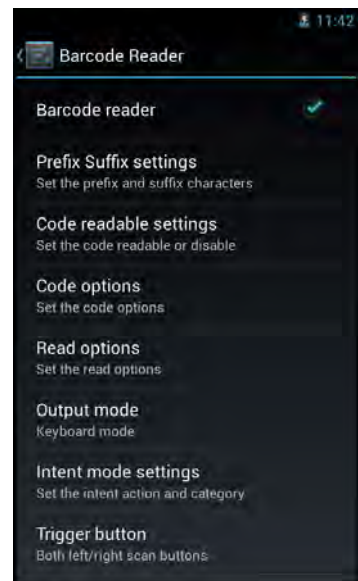

- **Show the notification icon:** Check the box to enable notification icon to be displayed on the status bar.
- **Sound and Vibration feedback:** Configure the feedback type and sound.
- **BCR Demo:** Demo for barcodereader.
- **Firmware Version:** View the module firmware version.

3. Touch  to return to the **Home** screen.

Scanning a Barcode

To scan a 1D barcode, perform the following:

1. Point the H-27 scan window at the barcode to be scanned and press the left or right **Scan** key.
2. The scanned data appears on the screen.
3. Release the trigger key.

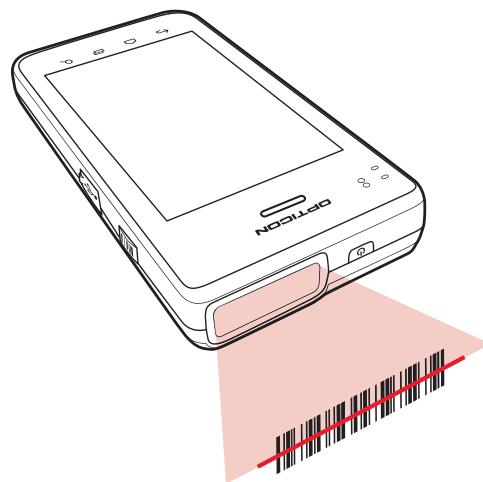

To scan a 2D barcode, perform the following:

1. Point the H-27 scan window at the barcode to be scanned and press the left or right **Scan** key.
2. The scanned data appears on the screen.
3. Release the trigger key.

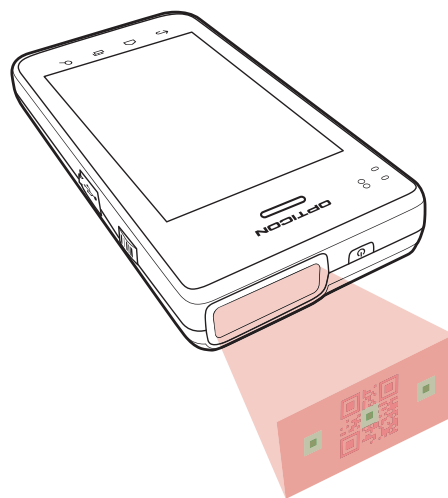

Appendix

Specifications

H-27 Specifications	
Processor	Qualcomm MSM8960 Dual Core Krait– 1.5GHz
OS	Android 4.2
Memory	Standard: 1GB
Storage	Standard: 8GB
Display	<ul style="list-style-type: none"> • 4.3" TFT, 800*480 • Brightness 350nits
Capacitive Touch	<ul style="list-style-type: none"> • 2 finger touch • Gorilla glass+ AR solution
WWAN	<ol style="list-style-type: none"> 1. (RF WCDMA+GSM)GWTR-1605 support <ul style="list-style-type: none"> • GSM850/900/1800/1900 • EDGE850/900/1800/1900 • GPRS850/900/1800/1900 • WCDMA850/1700(AWS)/1900/2100 2. Voice 3. HSPA+ Modem
Bluetooth	V4.0 + LE
WiFi	802.11a/b/g/n ; 13 channels; need roaming function WCN3660
GPS	<ul style="list-style-type: none"> • Gen 8 GPSONe with GPS and GLONASS. • Strong Signal/Open Sky (-130 dBm) Cold start 32s • Weak signal/Mild indoor (-161 dBm) 60s
NFC (Optional)	NFC standards according to Android 4.2 CDD + ISO15693 and MIFARE
Back Camera (Internal)	CMOS, 5.0 Mega Pixels, auto focus, Flash Light, mipi interface
Battery pack	3.7V, capacity 2860mAh
Charging time	2.5~3 hours
Backup Battery	<ul style="list-style-type: none"> • Li-ion Polymer 3.7V,80-100mA • hot swap time of 3-5 min. • battery cover detection
Hotswap functionality	Battery cover sensor and backup battery voltage detection for securing hotswap functionality
Working time	Video timeGaround 8 hours@film with speaker, 50%, Brightness 50%,WIFI Turn ON
Standby time	150 hours @ WIFI of & 3G Power on, 20mA

H-27 Specifications	
Speaker	Internal, 1 (0.5W) more than 80 dB SPL at 1m
Receiver	Internal, 1, add HAC compliant receiver
Microphone	Internal, 1
I/O	<ul style="list-style-type: none"> • 1 x SIM • 1 x Micro SD • 1 x Micro USB Female type, OTG & Charging function • 1 x Earphone Jack (pin defined as Apple) • 6 x Function Key (2 function key) • 1 x Power button, 2 x Volume button (Power button for 7-10 seconds for reset function) • 1 x POGO Pins (for Cradle), include charging function, OTG USB function • 1 x Internal Host usb for MSR or IC Card reader
Power Adaptor	<ul style="list-style-type: none"> • Input: 100V to 240V AC 50/60Hz 0.8A • Output: 5V DC 3A(DC-plug) (Micro USB male Type only support 1.5A) • AC Cable • Certification: UL, FCC, CE, PSE & BSMI, +/-2KV surge test
Dimension	77mm(W) x 147mm(L) x 19.9 mm(T)
Operating temperature	-10°C to +50°C
Storage temperature	-20°C to +70°C (without battery)
Charging temperature	0°C to +40°C
Humidity	5% to 95% RH (no condensation)
Sealing	IP65 per applicable IEC sealing specifications
Drop specification	Multiple 1.5 meters(4 feet) drop to concrete, 6 faces, 6 times per face, at 25 degree C operating temperature
Electrostatic Discharge (ESD)	<ul style="list-style-type: none"> • +/- 15kVdc air discharge @ could be reboot • +/- 8kVdc direct discharge @ could be re boot

*Design and specifications are subject to change without prior notice.

Preface

Copyright

Copyright © 2014. All rights reserved.

No part of this user manual may be reproduced, transmitted, stored in a retrieval system, or translated into any language, in any form or by any means, without permission from the manufacturer.

Google, the Google logo, Android, the Android logo and Tags are trademarks of Google Inc.

Wi-Fi is a registered trademark of the Wireless Fidelity Alliance.

microSD is a trademark of SD Card Association.

Bluetooth and the Bluetooth logo are trademarks owned by Bluetooth SIG, Inc.

Java, JME and all other Java-based marks are trademarks or registered trademarks of Sun Microsystems, Inc. in the United States and other countries.

All other products use in this device and trademarks mentioned herein are trademarks or registered trademarks of their respective owners.

Safety Information

Read the following safety information before using the device.

- Use only the power adaptor provided by the manufacturer. Use of unauthorized accessories may void the warranty.
- Avoid using the device near electromagnetic sources such as TVs, radios, and microwave ovens.
- Unplug the power adaptor from the wall outlet during lightning storms to avoid electric shock or fire.
- Do not expose the device to direct sunlight over a long period of time.
- Do not use harsh chemicals or detergents to clean the device.
- Do not handle the device with wet hands while it is being charged. This may cause an electric shock or serious damage to the device.
- Do not operate the device while it is being charged. This may cause unforeseen damage.
- Do not store the device in temperatures lower than -20°C or higher than 60°C.
- The operating temperature for this device is from -5°C to 50°C.
- Do not use the device on board an aircraft.

Regulatory Statement

RF Exposure Information (SAR)

This phone is designed and manufactured not to exceed the emission limits for exposure to radio frequency (RF) energy set by the Federal Communications Commission of the United States.

During SAR testing, this device was set to transmit at its highest certified power level in all tested frequency bands, and placed in positions that simulate RF exposure in usage against the head with no separation, and near the body with the separation of 10 mm. Although the SAR is determined at the highest certified power level, the actual SAR level of the device while operating can be well below the maximum value. This is because the phone is designed to operate at multiple power levels so as to use only the power required to reach the network. In general, the closer you are to a wireless base station antenna, the lower the power output.

The exposure standard for wireless devices employing a unit of measurement is known as the Specific Absorption Rate, or SAR.

The SAR limit set by the FCC is 1.6W/kg.

This device is complied with SAR for general population /uncontrolled exposure limits in ANSI/IEEE C95.1-1992 and had been tested in accordance with the measurement methods and procedures specified in IEEE1528. This device has been tested and meets the FCC RF exposure guidelines when tested with the device directly contacted to the body.

The FCC has granted an Equipment Authorization for this model phone with all reported SAR levels evaluated as in compliance with the FCC RF exposure guidelines. SAR information on this model phone is on file with the FCC and can be found under the Display Grant section of www.fcc.gov/oet/ea/fccid after searching on FCC ID: Q2QH-27.

While there may be differences between the SAR levels of various phones and at various positions, they all meet the government requirements.

SAR compliance for body-worn operation is based on a separation distance of 10 mm between the unit and the human body. Carry this device at least 10 mm away from your body to ensure RF exposure level compliant or lower to the reported level. To support body-worn operation, choose the belt clips or holsters, which do not contain metallic components, to maintain a separation of 10 mm between this device and your body.

RF exposure compliance with any body-worn accessory, which contains metal, was not tested and certified, and use such body-worn accessory should be avoided.

WEEE Notice

The WEEE logo on the product or on its box indicates that this product must not be disposed of or dumped with your other household waste. You are liable to dispose of all your electronic or electrical waste equipment by relocating over to the specified collection point for recycling of such hazardous waste. Isolated collection and proper recovery of your electronic and electrical waste equipment at the time of disposal will allow us to help conserve natural resources. Moreover, proper recycling of the electronic and electrical waste equipment will ensure safety of human health and environment. For more information about electronic and electrical waste equipment disposal, recovery, and collection points, please contact your local city center, household waste disposal service, shop from where you purchased the equipment, or manufacturer of the equipment.



FCC Regulations

15.19(a)(3):

This device complies with part 15 of the FCC Rules. Operation is subject to the following two conditions: (1) This device may not cause harmful interference, and (2) this device must accept any interference received, including interference that may cause undesired operation.

15.105(b):

NOTE: This equipment has been tested and found to comply with the limits for a Class B digital device, pursuant to part 15 of the FCC Rules. These limits are designed to provide reasonable protection against harmful interference in a residential installation.

This equipment generates, uses and can radiate radio frequency energy and, if not installed and used in accordance with the instructions, may cause harmful interference to radio communications. However, there is no guarantee that interference will not occur in a particular installation. If this equipment does cause harmful interference to radio or television reception, which can be determined by turning the equipment off and on, the user is encouraged to try to correct the interference by one or more of the following measures:

- Reorient or relocate the receiving antenna.
- Increase the separation between the equipment and receiver.
- Connect the equipment into an outlet on a circuit different from that to which the receiver is connected.
- Consult the dealer or an experienced radio/ TV technician for help

Changes or modifications not expressly approved by the party responsible for compliance could void the user's authority to operate the equipment.

About this Manual

The content in this manual is as accurate as possible. However, due to continuous product improvements, some contents and specifications may have been changed since this manual was written. In this case, take the actual device as basis.

No part of this user manual may be reproduced, transmitted, stored in a retrieval system, or translated into any language, in any form or by any means, without a written permission from the manufacturer.

Information is subject to change without prior notice.



OPTICON

www.opticon.com