

User's Manual



LPN5627, LPR5627 (Raster)
**Miniature High Speed Laser
Fixed Position Scanner**
Manual No. 25-ULPNR101-03
February, 2003



8 Olympic Drive
Orangeburg, NY 10962
Tel 845.365.0090
Fax 845.365.1251
www.OpticonUSA.com

Contents

Section 1 Introduction and Getting Started	1
Product Overview	1
Quick Start-Up Procedure	1
Section 2 Technical Specifications	2
Physical Specifications	2
Symbologies Supported	2
Optical Specification	2
Pitch	3
Skew	3
Tilt (rotation)	3
Curvature	4
LPR5627 Raster Pattern	4
Electrical Specification	5
RS232 Communications Specifications	5
Connector Pin Outs	5
Environmental Specifications	6
Ordering Information	6
Section 3 Positioning the Scanner	7
Achieving Optimum Performance	7
Measuring Scanner Performance	9
The Read Rate Test	9
Tips for Achieving High Throughput	11
Tips for Insuring Highest Data Integrity	11
Tips for Verifying the Presence of a Bar Code	12
Section 4 Configuring the Scanner	13
Configuring the Scanner	13
Default Setting	13
Section 5 Application Engineering Support	14
Common Causes of Poor Performance	14
Section 6 Laser Labeling	15
Section 7 Service and Maintenance	15
Appendix A How to Program the Scanner	17
Appendix B Computer Programming Commands	19
Appendix C Bar Code Programming Commands	24
Appendix D Dimensional Drawings	61
Appendix E Optical Performance	62

Organization of this Manual

This manual provides the necessary instructions for installing and using the Opticon LPN5627 and LPR5627 Fixed Position Scanners. The manual is organized as follows:

Section 1 Introduction and Getting Started

Describes the general operation of the LPN5627 and LPR5627 scanners. Also provides a Quick Start-Up Procedure that allows you to begin using the scanner immediately.

Section 2 Technical Specifications

Provides complete specifications, including mechanical details, optical performance, RS232 communications and other technical data.

Section 3 Positioning the Scanner for Optimum Performance

Provides detailed instructions and tips for mounting and positioning the scanning to obtain the best scanning performance. Application Notes describe guidelines for maximizing specific characteristics.

Section 4 Configuring the Scanner

Describes how various parameters can be programmed to customize the scanner for your specific application.

Section 5 Application Engineering Support

Discusses the most common questions and concerns when adapting the LPN5627 and LPR5627 scanners in your application.

Section 6 Scanner Labels

Discusses the various labels on the product required by CDRH.

Section 7 Scanner Servicing and Maintenance

Discusses maintenance and cleaning procedures.

Appendix A How to Program the Scanner

Appendix B Computer Programming Commands

Appendix C Bar Code Programming Commands

Appendix D Dimensional Drawing

Appendix E Optical Performance

Section 1

Introduction and Getting Started

Product Overview

The LPN5627 and LPR5627 (Raster) Fixed Position Scanners are miniature, 500 scan per second, laser bar code readers designed to be easily incorporated into host equipment. The high scan speed and small physical size make the scanner easy to integrate into any hardware design. Durability and reliability are assured.

Advanced microprocessor technology coupled with Opticon's proven decoding algorithms result in high speed operation with superior accuracy. The scanners are fully programmable allowing the user to customize parameters including changing communication settings, selecting symbologies, adding prefixes and appending suffixes. Programmable settings can be downloaded from the host CPU or computer directly to the scanner.

The scanners are encased in compact, rugged metal enclosures. The compact size permits installation in the tightest areas allowing great flexibility in mounting and positioning the scanner for optimum performance.

Quick Start-Up Procedure

This section is for those who wish to start using the scanner before reading the complete manual. Only a few steps are needed to make the scanner operable.

- ❑ A Developers Evaluation and Test board is available to allow rapid installation of the scanner
- ❑ Connect the scanner min-DIN connector to the board
- ❑ Using the DB9 extension cable, connect the board to a DB9 serial port, such as COM 1 on you PC.
- ❑ Be sure your PC or host device is running an application such as HyperTerminal that will accept serial input.
- ❑ The default communications parameters of the scanner are 9600 baud, 1 Start/Stop Bit, 8 Data bits, No Parity, No Handshaking, No Flow Control) See Users Manual for details on establishing or changing communications parameters.
- ❑ Plug the 5V DC power supply into the jack on the board
- ❑ There is a trigger test button on the scanner. There is a trigger button on the Evaluation and Test board as well.

That's it. Your PC and the scanner should now communicate.

To verify that the scanner and the PC are communicating properly, send the following command from your PC keyboard to activate the scanner's buzzer.

Send the command: <Escape> V5 <Carriage Return>

Note: Be sure to use capital letters, e.g. "V5", not "v5".

The buzzer should sound, indicating that good communications have been established

To test the scanner, press the trigger test button on the scanner itself or on the evaluation board. A red laser light will be visible. Do not stare into the laser light.

This Quick Start-Up procedure will get you started. However, to best understand the full capabilities of this scanner, you should read the complete manual.

Section 2 Technical Specifications

Physical Specifications

Case Material	Zinc-die cast
Dimensions	1.9 x 1.5 x 0.9 in (WxDxH) (47.4 x 37.2 x 23 mm)
Weight	2.9 oz (80 grams) w/o cable
Cable Length	6.5 Feet (2000 mm)
Connector	9-pin Male MiniDIN connector
Mounting	2 threaded (M-3) mounting holes (not to extend more than 3 mm into the case)

Symbologies Supported

- ◆ Codabar (NW-7)
- ◆ Code 39
- ◆ Code 93
- ◆ Code 128
- ◆ Industrial 2 of 5 Interleaved 2 of 5
- ◆ MSI / Plessey
- ◆ WPC (UPC / EAN / JAN)
- ◆ IATA

Optical Specifications

Scan Rate	500 scans per second $\pm 10\%$
Light source	650 ± 10 nm visible laser diode
Narrow Bar Resolution	6 mil (0.15mm) at 0.9 PCS
Minimum PCS	0.45 (min. background reflectance of 70%)

Reading Distances LPN5627 (Specification) *

Bar Code Density	Near Distance	Far Distance
40 mil (1.00 mm)	2.3"	12.6"
20 mil (0.50 mm)	2.3"	10.8"
10 mil (0.25 mm)	2.3"	7.5"
6 mil (0.15 mm)	3.5"	4.7"

* measured from front edge of scanner

Reading Distances LPR5627 (Raster – Specification) *

Bar Code Density	Near Distance	Far Distance
40 mil (1.00 mm)	2.3"	10.6"
20 mil (0.50 mm)	2.3"	9.1"
10 mil (0.25 mm)	2.3"	6.7"
6 mil (0.15 mm)	3.5"	4.3"

* measured from front edge of scanner

Pitch

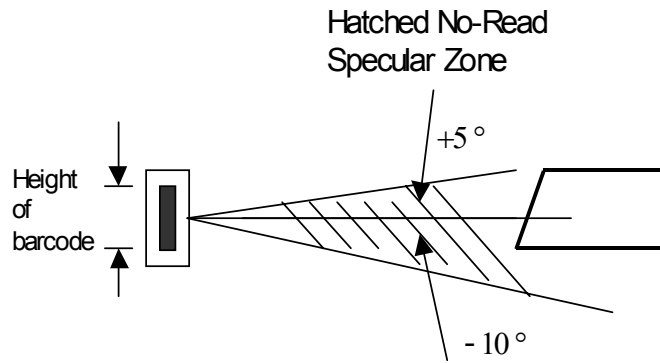

Recommended operation (α) at ± 60 degrees or less

Avoid specular reflection in the dead zone (hatched).

Skew

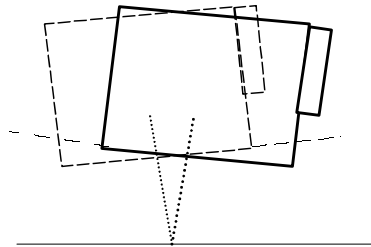

Recommended operation (β) ± 25 degrees

Tilt (Rotation)

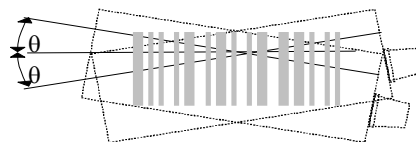

Recommended operation (θ) ± 25 degrees (Barcode aspect ratio allowing laser to cover all bars).

Curvature

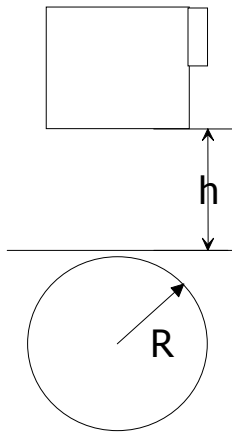

Jan 13: $R = 20 \text{ mm (0.8")}$ or

Jan 8: $R = 15 \text{ mm (0.6")}$.

Where: PCS 0.9, $h = 100 \text{ mm}$,

Pitch=15°, Skew=0°, Tilt=0°

LPR5627 Raster Pattern

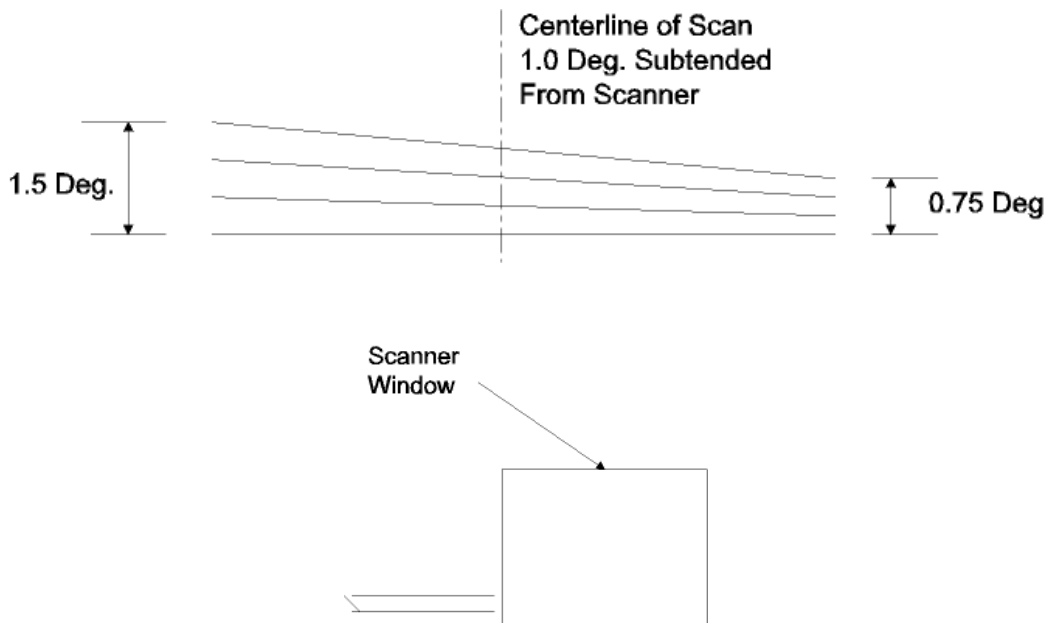

Raster sweep pattern as seen from front of scanner

Subtends a 1° angle from top to bottom of raster (at the centerline) as measured from the scanner.

Electrical Specifications

Operating Voltage	+5VDC \pm 10%
Current	
Operating	150mA idle; 350 mA max. (Laser ON)
Surge	2.5 A max.

RS232 Communications Specifications

RS232 Data Transmission Format

<u>Parameter</u>	<u>Default</u>	<u>Optional Settings</u>
Timing	Asynchronous	
No. of Start Bits	1 bit	
No. of Stop Bits	1 bit	1 or 2 bits
No of Data Bits	8 bit	7 or 8 bits
Parity	None	Odd / Even / None
Baud Rate	9600 baud	300 to 38,400 baud
Handshaking	None	Hardware / Software/ None

RS232 Transmit / Receive Character Format

TXD/ RXD	Start Bit	LSB	7 or 8 Data Bits	MSB	Parity Bit	Stop Bit
-------------	--------------	-----	---------------------	-----	---------------	-------------

RS232 Data Format

Transmit	Decoded Data		CR
Receive	ESC	Command	CR
	STX	Command	ETX

RS232 Signal Level

Signal Name	In / Out	Mark/Off	Space/On
TXD	Out	-5 to -15	+5 to +15
RXD	In	-3 to -15	+3 to +15

Connector Pin-outs

9 pin Male Mini-Din Connector

Pin No.	Signal	Color	Direction
1	Trigger	Brown	Input
2*	Good Read	Yellow	Output
3*	Bad Read	Orange	Output
4	CTS	Blue	Input
5	RTS	Gray	Output
6	RD	White	-
7	SD	Green	
8	+5V	Red	-
9	Signal Ground	Black	

* NPN open collector, rated at 24 VDC, 30 mA maximum

Environmental Specifications

Temperature

Operating	+32 to +113° F (0° to +45° C)
Storage	+14 to +140° F (-10° to +60° C)

Humidity (non- condensing)

Operating	20 to 85%
Storage	20 to 90%

Dust/Water Designed to meet IP54

Ambient Light Fluorescent or incandescent: below 5 kilolux

Ordering Information

<u>Part No.</u>	<u>Model</u>
LPN5627RR1S-048*	Front View (Linear)
LPR5627RR1S-048*	Front View (Raster)

* Where "-048" is standard configuration. Other configurations are available as required.

Developer's Test and Evaluation Kits (LPN-5627R101-SK1 and for the raster configuration LPR-5627R101-SK1) are available that contain all the items needed to install and evaluate the scanners. These kits include:

- Scanner
- Engineering Test & Evaluation Board
- 5V Power Supply
- Extension Cable
- User Manual

Section 3 Positioning the Scanner

Achieving Optimum Performance

Three items greatly impact performance:

- 1) Distance (from the scan window) to the bar code
- 2) Specular Reflection
- 3) Quality of Bar Code Labels

1) Distance to the Bar Code

The operation of the scanner is similar to a camera. If you photograph an object that is out of focus, the resulting picture will be blurry. The same is true with the scanner. If the bar code label is out of focus, the scanner may have difficulty decoding what appears to be fuzzy bars and spaces.

Focal Distance

Ideally, the distance from the window of the scanner to the bar code label should be equal to the focal distance of the scanner. For the LPN5627 / LPR5627 fixed position scanners, the nominal focal distance is approximately 4.0" from the front edge of the scanner

Depth-of-Field

Just as with a camera, the scanner has a depth-of-field. It can read bar codes that are not precisely at the focal distance - maybe a little closer, or a little farther away. However, if the bar code label is positioned too far from the focal distance, the scanner may not be able to successfully decode it.

The depth-of-field varies based on the density of the bar code, i.e., the thickness of the bars. Very high density bar codes (which have very narrow bars) are readable over a much shorter distance range than low density bar codes with larger bars.

The following table shows the depth-of-field specifications (closest to farthest reading distances) for the LPN5627 / LPR5627 scanners. The actual performance may differ slightly from unit to unit. Also, it is important to note that this data was measured under ideal conditions using high quality bar code labels. In a "real world" environment the conditions will not be as ideal. Therefore, the best practice is to position the scanner at the center of the depth-of-field rather than at the extremes of its depth-of-field.

Depth-of Field LPN5627 (Specification)*

Bar Code Density	Near Distance	Far Distance
40 mil (1.00 mm)	2.3"	12.6"
20 mil (0.50 mm)	2.3"	10.8"
10 mil (0.25 mm)	2.3"	7.0"
6 mil (0.15 mm)	3.5"	4.7"

* measured from front edge of scanner

**Readable Bar Code Width LPN5627/LPR5627
(Field-of-View Specification Based Upon 40 Degree Sweep)**

Distance from Window	Max. Width
2.0"	2.0"
4.0"	3.5"
8.0"	6.4"
12.0"	9.3"

The table above shows the field-of-view at various distances from the window. The field-of-view is the maximum width that the scanner is capable of reading. It is the distance from the left edge of the view to the right edge. A bar code label positioned anywhere within this field-of-view can be decoded. The field-of-view is also a measure of the widest bar code label that can be read. *Remember:* The width of a bar code label includes not only the bars and spaces but also the required white space (quiet zone) on each end.

Good design policy is to position the barcode at the midpoint of the scanner's depth-of-field and at the center of the field-of-view. Do not position it near the extremes of the reading range.

Comparable depth-of-field parameters for the LPR5627 are the following:

Depth-of-Field LPR5627 (Raster - Specification) *

Bar Code Density	Near Distance	Far Distance
40 mil (1.00 mm)	2.3"	10.6"
20 mil (0.50 mm)	2.3"	9.1"
10 mil (0.25 mm)	2.3"	6.7"
6 mil (0.15 mm)	3.5"	4.3"

* measured from front edge of scanner

2) Avoiding Specular Reflection

Do not position the scanner at an angle that causes the laser light to be reflected directly back into the scanner. This is called specular reflection. Too much reflected light can "blind" the scanner preventing a good decode.

If the bar code label is located on a flat surface, specular reflectivity occurs between 0 to 10 degrees off perpendicular. (See diagram) If the bar code label is located on a cylindrical surface, such as a test tube, the angle of specular reflection is measured tangent to the curve. If the curved surface is also moving, there may be more than one position causing specular reflection. The following diagram indicates the area to avoid:

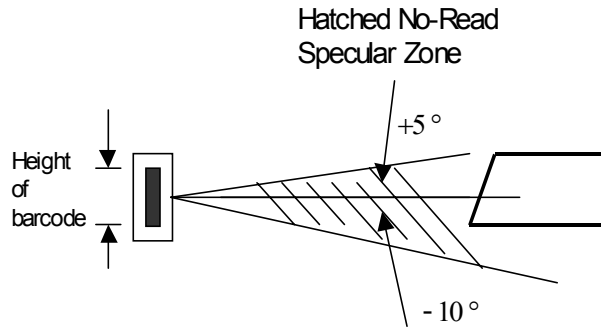

3) Quality Bar Code Labels

The quality of the bar code label can affect the scanning performance. Poor quality labels are more difficult to decode and may result in non-reads or potential misreads. The bar code label should be printed to specifications. This means that the bars are printed within spec, with the correct widths, no ink spread, crisps edges and no voids. There should be a sufficient quiet zone on both end of the bar code label. For best results, the paper or label stock should have a matte finish to diffuse light. The print contrast signal (which is a comparison of the reflectance of the bars and the background stock) should be as high as practical.

Measuring Scanner Performance

Two methods are helpful in determining the optimum position of the scanner. The first method is to program the scanner for Trigger Disable and Continuous Read modes. The scanner will be always on and will continuously read the same bar code. Since the buzzer sounds each time the bar code is read, the sound of the buzzer can be used like a "Geiger counter". As the position of the scanner changes the sound of the buzzer will change. The buzzer sound will be loudest and most continuous at the best reading positions.

The Read Rate Test

The second method, the Read Rate Test, provides a mathematical calculation of scanning performance. In this test the scanner scans a bar code 700 times and then calculates the number of those scans that resulted in a good decode. That number, expressed as a percentage, will be transmitted to the host. For example, 93% means that the scanner decoded the bar code symbol 93 times out of the 650 scan attempts. By performing the Read Rate Test with the scanner mounted in various positions you can determine which of those locations results in the best performance.

How to perform the Read Rate Test

Perform the following steps after you have correctly configured communications to the computer via your RS232C port and power is made available to the scanner:

Send the command: **<Escape> U8 <Carriage Return>** Note: Be sure to use capital letters, e.g. "U8", not "u8".

The scanner will read the barcode continuously and will display the ratio of the number of successful reads to the total number of attempts.

The printout on the screen will appear as follows:

(Example)

700d OK 93.5%
CODE-39 TEST

The number in the upper left indicates the number of times the decoder ran while scanning at 700 scans per second. The number can be lower than 700 when reading noisy barcodes. The upper right percentage indicates the ratio of the number of successful reads to the total number of attempts. By positioning the scanner at the optimal distance from the barcode with the correct orientation and with a grade-A quality barcode readings of 95% or higher are expected. Reset the scanner after testing.

Application Notes

Tips for Achieving High Throughput

In some applications your primary objective may be to achieve the highest possible throughput rate. The following list identifies the parameters and scanner settings that can maximize scanning and decode throughput speed. Note, by emphasizing maximum throughput, other areas of performance may be affected. For example, the number of non-reads could increase.

If high throughput is critical, consider some or all of these settings:

- ◆ Operate in the Trigger Disabled mode. Operation of the trigger can require as much as 200 msec before decoding begins, slowing down throughput rate.
- ◆ Only enable those symbologies that you will be decoding.
- ◆ Eliminate all suffixes and prefixes.
- ◆ Minimize the number of redundant reads required before transmitting data.
- ◆ Transmit the decoded data at the highest baud rate, 38,400 baud.
- ◆ Disable buzzer functions.

Tips for Insuring Highest Data Integrity

There are several parameters that can enhance your confidence that the correct bar code data is transmitted. Note that by emphasizing the accuracy and security of the data other areas of the scanner operation may be affected, for example, you may not achieve the highest throughput.

If accuracy and data integrity are critical, consider some or all of these settings:

- ◆ Program the scanner to require a high number of redundant decodes prior to transmitting. For example, program the scanner to decode a bar code exactly the same way three consecutive times before transmitting the data. Then decoding the bar code the same way 2 out of 3 times or any 3 out of 4 times is not sufficient. It must obtain three consecutive and identical decodes.
- ◆ Utilize a predetermined, fixed-length of bar code. Program the scanner to only decode a bar code of that length. Bar codes of any other length will be ignored.
- ◆ The quality of the printed bar code must be excellent.
- ◆ Use a bar code symbology that contains an internal check digit and program the scanner to calculate that check digit for validity prior to transmitting.
- ◆ Do not use a symbology with poor internal verification, or subject to partial decodes, such as 2 of 5 or MSI/Plessey.
- ◆ Only enable those symbologies that you will be decoding.
- ◆ Transmit data at low baud rates to minimize communication errors.

Enable the "Number of Characters Transmitted". The scanner will calculate and transmit a number indicating the total number of characters it is transmitting. Your host application program can compare this number with the actual number of characters received to verify that the correct amount of data is received.

Tips for Verifying the Presence of a Bar Code

If the scanner is operated in the "trigger enabled" mode and the trigger is activated, one of three conditions may occur:

A bar code is scanned and decoded.	Decoded data is transmitted
A bar code is scanned but is not decoded (e.g., print quality was poor)	No data is transmitted
No bar code is present	No data is transmitted

In some applications, when no data is transmitted, it may be important to know why. Was there a bar code present that could not be decoded, or was no bar code present at all?

This requirement is common in applications such as automated blood analysis equipment. Test tubes containing blood samples from many different people are loaded into a rack for automatic analysis. The bar code on each tube ties that sample and the results back to a specific individual. If no bar code data is transmitted it is critical to understand the reason.

Your Opticon scanner, when operated in the Trigger Enabled mode, can be programmed to transmit an error message indicating whether or not a bar code was present. The following table shows the message that will be transmitted for each condition.

Presence/Absence of bar code	Scanner Transmits
Bar code was present and correctly decoded	Decoded Data
No bar code was present	<STX> "?" <ETX>
Bar code was present but could not be decoded	<STX> ">" <ETX>

Section 4 Configuring the Scanner

Since the operation of the LPN5627 / LPR5627 scanners are microprocessor controlled, it is possible to modify or program its operation to match your specific application. Changes in parameter settings can be accomplished two ways.

1. The scanner can be programmed by sending software instructions from the host PC to the scanner via the RS232 connection.
2. The second method employs specially designed programming bar codes. Scanning these bar codes instructs the scanner to modify specific parameters.

Programming Menus & Commands

Appendix A contains full instructions on how to configure the scanner as well as a complete listing of the computer commands and programming bar codes that are available to customize the scanner for your application.

Default Settings

When you modify or change any parameters, the scanner can be programmed to retain the new parameter in memory, even if power interrupted or terminated. If for any reason the scanner is instructed to return all parameters to default settings (U1), it will return to the default settings shown in the following table.

Default settings are indicated by a pointing hand symbol () throughout the bar codes menus.

Parameter	Factory Default Setting
RS 232 Communications	9600 baud 8 data bits 1 stop bit No parity No handshaking
Trigger Function	Enabled
Read Mode	Multiple Read Mode
No. of Redundant Decodes	Read twice before transmitting
UPC-A (13 digits)	Add leading zero Enable check digit
UPC-E (7 digits)	Add leading zero No check digit
Code 39	Do not calculate check digit/Transmit check digit Enable start/stop characters (*.....*) Disable character length of one
Codabar	Enable start/stop characters as abcd/abcd Do not calculate check digit/Transmit check digit Disable character length of one
2 of 5	Do not calculate check digit Disable characters length of two
Fixed length of bar code only	Disabled
Buzzer	Enabled
Positive bar codes only	Disabled (Both positive and negative barcodes)
Error indications	Do not transmit error code
Print quality adjustment	Output from Low or High analog gain 1 MHz sampling rate

Section 5

Application Engineering Support

Technical Assistance and Support

Opticon is eager to help you integrate the LPN5627 / LPR5627 scanner into your application. Our technical support staff is available to answer any questions or work with you to adapt the scanner to your specific situation. We are happy to answer your questions, assist in configuring and positioning the scanner for optimum operation, and help resolve any problems you encounter. Call us at 1 (800) 636-0090.

Common Causes of Poor Performance

The most common reasons for poor scanning performance are listed below:

- ◆ Bar codes are not positioned at the focal distance of the scanner.
- ◆ Specular reflection is impacting the scanner. Change the angle/position of the scanner or the bar code.
- ◆ Poor quality of printed bar codes. Bar codes are out of specification.
- ◆ The paper on which the bar code is printed is highly reflective or has a glossy finish causing light to be reflected into the scanner.
- ◆ The distance from the scanner to the bar code is not suitable for the density of the bar code. Or the density of the bar code beyond the scanners capability. If the red illuminating light of the scanner is not on, the scanner may be in the "Trigger Enable" mode expecting a trigger signal.

Modified and/or Customized Scanners

Opticon will work with you to modify or customize scanners to match your requirements. Scanners can be modified in terms of connectors type, pin-outs, cable length, default settings, custom software and many other areas.

Opticon will modify scanners in our factory and ship you scanners that match your specific requirements. By incorporating your modifications directly into production scanners, you receive scanners tailored for your need. They can be used immediately without the need for further modification or rework.

Section 6 Scanner Labeling

CDRH Class II Laser Device

LPN5627 / LPR5627 scanners comply with Center for Devices and Radiological Health (CDRH) regulations 21, CFR Subchapter J. It is classified as a Class II Laser Device

The LPN5627 / LPR5627 scanners use a low-power visible laser. As with any very bright light source, such as the sun, you should avoid staring into the light beam. Momentary exposure to a CDRH Class II laser is not known to be harmful.

A laser safety label, manufacturers label and product label are affixed to the scanner as shown



If the LPN5627 or LPR5627 scanner is incorporated into or interfaced to other equipment, that equipment should include a laser safety label and a visible indicator that is illuminated whenever laser energy is being emitted from the scanner. This indicator may remain illuminated when the scanner is powered but the laser is not emitting energy

Section 7 Scanner Servicing and Maintenance

⚠ CAUTION: Use of controls or adjustments or performance of procedures other than those specified herein may result in hazardous laser light exposure.

The LPN5627 / LPR5627 scanners contain no user adjustable or serviceable parts in the interior of the scanner. All product service must be performed by the Opticon Service Department in Orangeburg, NY. Opening the scanner will void the warranty and could expose the operator to laser light.

The LPN5627 / LPR5627 are warranted for 1 year including parts and workmanship. If you need warranty or out-of-warranty repair, first **call 1-800-636-0090** to obtain a **Returned Material Authorization (RMA)** number. You will be provided a number and shipping instructions.

There is no scheduled maintenance required for the LPN5627 / LPR5627. The scanner can be cleaned using a water dampened, lint free or lens cloth. Be careful to avoid excessive moisture that would penetrate the housing or obscure the window. While use of cleaning fluids other than water are not recommended, a neutral detergent or ethanol would be preferred if necessary. Do not use bleach at full or diluted strength as damage to the painted case and/or window may result.

Appendencies

Appendix A How to Program the Scanner

Appendix B Computer Programming Commands

Appendix C Bar Code Programming Commands

Appendix D Dimensional Drawing

Appendix E Optical Performance

Appendix A

Programming the Scanner

Two different methods can be used to program parameters to configure the scanner:

- a. Programming via Computer Commands
- b. Programming via special Bar Codes from a menu page

Most parameters can be programmed using either of these two methods. However, there are certain parameters that are only programmable via the bar code menu.

a. Programming via Computer Commands

Parameters can be programmed by sending software commands or keyboard strokes from the host computer to the scanner in the following format:

<ESC> Computer Command <CR>

Note:

Only upper case letters are recognized, e.g., "AB" not "ab"
Each command normally consists of two characters
Downloading of software commands cannot be "grouped" together. Each command must be preceded by <ESC> and followed by a <CR>

Parameters programmed by downloaded commands can be stored permanently by transmitting a "<ESC> Z2 <CR>" command. It is not necessary to send a "Z2" command after each parameter is changed. One Z2 command will save all changes

Appendix B lists all of the Computer Commands. In Appendix C, Bar Code Programming Menus, the left-hand column in all menus contains the Computer Command associated with that bar code.

b. Programming via Bar Codes

Use the following steps to program parameters via the bar code menus:

1. Scan the "Start/End" bar code. This instructs the scanner to enter the Programming Mode. While in this mode the scanner will beep intermittently.
2. Scan the bar code(s) associated with the desired parameter(s). The scanner will beep when the bar code is read. Note: because of the close proximity of bar codes on the page, it is important to aim carefully to ensure that only the desired bar code is scanned.
3. Scan the "Start/End" bar code. This instructs the scanner to exit the Programming Mode.

All the parameters that were scanned are retained in memory and are stored permanently (even if the scanner is power down) or until they are changed again.

When the scanner is in the Programming Mode, you can change more than one parameter at a time. However, this may become confusing. Until you become proficient at programming you may prefer to

change only a few parameters at one time. We recommend that you keep a record of the changes you have made to the scanner.

What if you make a mistake?







Don't worry. If you are programming the scanner but are unsure of which parameters have been changed, scan the **Reset All Defaults** bar code. This bar code returns the scanner to the default settings that were installed in the factory at the time the product was manufactured. Scanning this bar code erases any change you have made, including any changes that were made during previous programming.

Reset All Defaults U1 Command (U1)

This command will return all setting to the factory default setting that were installed in the factory

We recommend that after you have reset all defaults you also set the commands for No Handshaking (P0), All Symbologies (A0), and Do Not Transmit Start/Stop Characters (D0) for Code 39.

Reset All Defaults

Computer Command	Function / Description	Bar Code Command
Z7	START/END Programming Mode	
U1	Reset All Defaults	
A0	Decodes all Symbologies	
P0	No Handshaking	
D0	For Code 39: do not transmit start/stop characters *...*	
Z2	Save settings in memory	
Z7	START/END Programming Mode	

Appendix C contains all the Bar Code Programming menus and commands

Appendix B

Computer Programming Commands

All commands must be preceded by an 'ESC' character and be followed by a 'Carriage Return' character. Shaded areas indicate factory default settings.

Enable	Disable	Global Defaults
U1		Enable Factory Default Settings
1Y		Clear all prefixes
1Z		Clear all suffixes
P9		Transmit Barcode Pattern Data
U8		Read Rate Test Mode
Z1		Clear all values set by command
Z2		Save all values set by command
Z3		Display software settings & version no.
Z4		Display prefix/suffix

J3	R3	4D	UPC (A/E)+5
J4	R4	4E	EAN
J5	R5	4F	EAN+2
J6	R6	4G	EAN+5
		4Z	Disable all Symbologies

Only	Add	Rmv	Symbology Selection
A0			Enable all symbologies
A1	B1	4A	WPC (including add-ons)
A2	B2	4H	Code 39
A3	B3	4I	Codabar (NW-7)
A4	B4	4J	2 or 5 Industrial or Interleaved
J7	R7	4K	2 or 5 Industrial
J8	R8	4L	2 or 5 Interleaved
A5	B5	4M	Code 93
A6	B6	4N	Code 128
A7	B7	4O	MSI/Plessey
A8	B8	4P	IATA
J1	R1	4B	UPC (A/E)
J2	R2	4C	UPC (A/E)+2

Enable	Disable	Options for UPC
E2		UPC-A (13 Digits) Leading zero & CD
E3		UPC-A (12 Digits) No leading 0 & CD
E4		UPC-A (12 Digits) Leading zero & No CD
E5		UPC-A (11 Digits) No leading 0 & no CD
E6		UPC-E (8 Digits) Leading 0 & CD
E7		UPC-E (7 Digits) No leading zero & CD
E8		UPC-E (7 Digits) Leading zero; no CD
E9		UPC-E (6 Digits) No leading 0 & no CD
Enable	Disable	Options for Code 39
7C	7D	Enable 1 character read
C1	C0	Enable Check Digit calculation
C2	C3*	Transmit Check Digit
D1	D0	Transmit start/stop characters (*.....*)

- Only disable if C1 enabled, otherwise truncate last digit.

Enable	Disable	Options for Codabar (NW-7)
7K	7L	Enable 1 character read
F0		Do not transmit start/stop characters
F1		Transmit start/stop as ABCD/TN*E
F2		Transmit start/stop as abcd/tn*e
F3		Transmit start/stop as ABCD/ABCD
F4		Transmit start/stop as abcd/abcd
F5	F6	Transmit check digit
F7		Do not calculate check digit
F8		Calculate check digit (modulo 10)
F9		Calculate CD (modulo 16) AIM spec.
FB		Calculate check digit (modulo 7)

Enable	Disable	Options for Interleaved 2 of 5
G1	G0	Calculate check digit
G2	G3	Transmit check digit
7M	7N	Enable 2 characters

Enable	Disable	Options for IATA
D2		Do not calculate check digit
D3		Calculate CD (CPN + Form + Serial)
D4		Calculate CD (Form + Serial)
D5		Calculate check digit (all data)
D6	D7	Transmit check digit

Prefix	Suffix	Creating a Prefix and/or Suffix
1Y	1Z	Clear all
Z4	Z4	Display Prefix/suffix values & length
		Select Symbology for Prefix/Suffix

N1	N6	UPC-A
M0	O0	UPC-A +2 or +5
N2	N7	UPC-E
M1	O1	UPC-E +2 or +5
N3	N8	EAN13
M2	O2	EAN-13 +2 or +5
N4	N9	EAN-8
M3	O3	EAN-8 +2or +5
M4	O4	Code 39
M5	O5	Codabar (NW-7)
M6	O6	Industrial 2 of 5
M7	O7	Interleaved 2 of 5
M8	O8	Code 93
M9	O9	Code 128
D8	D9	IATA
N0	N5	MSI/Plessey

Prefix/Suffix of Numeric Characters	
Q0	0
thru	thru
Q9	9
Prefix/Suffix of Alpha Characters	
0A	A
thru	thru
0Z	Z
Prefix/Suffix of Control Characters	
1A	STX
1B	ETX
1C	Carriage Return (Default Suffix Character)
1D	Line Feed

Communications Parameters	
K1	300 baud
K2	600 baud
K3	1,200 baud
K4	2,400 baud
K5	4,800 baud
K6	9,600 baud
K7	19,200 baud
K8	38,400 baud
L0	7 Data Bits
L1	8 Data Bits
L2	Parity = None
L3	Parity = Even
L4	Parity = Odd
L5	1 Stop bit
L6	2 Stop bits

Handshaking	
I0	Unlimited wait for CTS from terminal
I1	100 mS wait for CTS from terminal
I2	200 ms wait for CTS from terminal
I3	400 mS wait for CTS from terminal
I4	Unlimited ACK/NAK Timeout delay
I5	100 mS ACK/NAK Timeout delay
I6	500 mS ACK/NAK Timeout delay
I7	1000 mS ACK/NAK Timeout delay
P0	No Handshaking
P1	Busy/Ready
P2	Modem
P3	ACK/NAK
P4	ACK/NAK No buzzer on timeout

P5	No ACK/NAK
----	------------

Enable	Disable	Enable character length transmission
3A	2A	UPC-A
3B	2B	UPC-A +2 or +5
3C	2C	UPC-E
3D	2D	UPC-E +2 or +5
3E	2E	EAN13
3F	2F	EAN-13 +2 or +5
3G	2G	EAN-8
3H	2H	EAN-8 +2or +5
3I	2I	Code 39
3J	2J	Codabar (NW-7)
3K	2K	Industrial 2 of 5
3L	2L	Interleaved 2 of 5
3M	2M	Code 93
3N	2N	Code 128
3O	2O	MSI/Plessey
3P	2P	IATA
3Z	2Z	Transmit data length of all symbologies

Enable	Disable	Fixed Number of Digits
7V		Enable fixation (1 st Length)
7W		Enable fixation (2 nd Length)
H0		Disable fixation
H3	H2	Enable 1 digit Code 39 and Codabar (NW-7) and enable 2 digit 2 of 5

Buzzer Operation	
T0	Volume = Maximum
T1	Volume = Upper mid-range
T2	Volume = Lower mid-range

T3	Volume = Minimum
V5	Ring buzzer once at 3kHz for 200 mS
V6	Ring buzzer at 3kHz & 2kHz for 200 mS
V7	Ring buzzer at 2kHz & 3kHz for 200 mS
W0	Disable Buzzer
W1	Enable buzzer at 3kHz
W2	Enable buzzer at 3kHz with 2.5kHz interval
W3	Enable buzzer at 2kHz with 3kHz interval
W4	Buzzer duration 0.10 sec
W5	Buzzer duration 0.20 sec
W6	Buzzer duration 0.40 sec
W7	Buzzer duration 0.05 sec
W8	Buzzer duration 0.01 sec

	Positive & Negative Bar Codes
V4	Positive bar codes only
V2	Both positive and negative bar codes

	Setting the Trigger Function
S7	Disable the trigger function (Laser On)
S8	Enable the trigger function (Laser OFF until the trigger is activated)
Z	Activate the trigger; turns the laser ON

	Selecting the Read Mode
S0	Single Read Mode (Trigger must be Enabled, S8)
S1	Multiple Read Mode
S2	Continuous Read Mode
7H	Does not allow first bar distortion
7I	Allow first bar distortion
7O	Normal scan

	Scanner Timeout (Trigger Enabled Mode)
Y0	Laser remains ON as long as trigger is pulled (hardware trigger only)
Y1	1 second after triggering
Y2	2 second after triggering
Y3	3 second after triggering
Y4	4 second after triggering
Y5	6 second after triggering
Y6	8 second after triggering
Y7	10 second after triggering
	Redundant Decoding
X0	Read bar code once
X1	Read bar code twice before transmitting
X2	Read bar code three times before transmitting
X3	Read bar code four times before transmitting
7R	Read bar code five times before transmitting
7S	Read bar code six times before transmitting

	Xmit Error (Trigger Enabled Mode only)
5E	Do not Xmit error code
5F	Xmit "BR" <CR> for bad read or no read
5G	Xmit <STX> ">" <ETX> for bad read; <STX> "?" <ETX> for no read
5H	Xmit ">" <CR> for bad read, "?" <CR> or no read
5I	Transmit "<CAN>" <CR> for bad read or no read
5J	Xmit "<CAN>"<ETX> for bad read or no read

	Print Quality Adjustment
X4	For lower density, poor print (low gain)
X5	For high density, good print quality bar code without voids (high gain)
X6	Xmit data from Low or High gain

X7	Xmit data from Low <u>and</u> High gain
----	---

Good Read LED Operation	
T4	Disable good read LED (GRL)
T8	GRL ON for 0.10 seconds after decode
T5	GRL ON for 0.20 seconds after decode
T6	GRL ON for 0.40 seconds after decode
T7	GRL ON for 0.80 seconds after decode
V0	LED ON Red for 0.40 seconds
V1	LED ON Red for 0.80 seconds
V8	LED ON Green for .40 seconds
V9	LED ON Green for .80 seconds

Trigger Input, OK & NG Output Controls	
8A	Trigger Input (positive logic) High active
8B	Trigger Input (negative logic) Low active
8C	Output synchronous transmission (negative – true logic)
8D	Output synchronous transmission (positive – true logic)
8E	Output one-shot transmission (negative – true logic)
8F	Output one-shot Xmit (positive – true logic)
8G	Output one-shot duration 10 mS
8H	Output one-shot duration 20 mS
8I	Output one-shot duration 30 mS
8J	Output one-shot duration 40 mS
8K	Output one-shot duration 50 mS
8L	Output one-shot duration 60 mS
8M	Output one-shot duration 70 mS
8N	Output one-shot duration 80 mS
8O	Output one-shot duration 90 mS
8P	Output one-shot duration 100 mS
8Q	Enable outputs
8R	Disable outputs

Motor Control	
S6	Motor always ON
S5	Motor OFF until trigger

Appendix C:

Bar Code Programming Menus & Commands

Index

1. Global Default & Scanner Configurations.....	25
2. Symbology Selection	28
3. Add/Activate Specific Bar Code Symbologies	29
4. Delete/Deactivate Specific Bar Code Symbologies.....	31
5. Options for UPC.....	32
6. Options for Code 39.....	33
7. Options for Codabar (NW-7).....	34
8. Options for 2 of 5	35
9. Options for IATA	36
10. Fixing the Number of Digits	37
11. Creating a Prefix and/or Suffix	38
12. Setting Prefixes (Identifying the Symbology).....	39
13. Setting Suffixes (Identifying the Symbology).....	40
14. Direct Input of Numeric Characters	42
15. Direct Input of Alpha Characters	43
16. Direct Input of Control Characters.....	44
17. Enable Number of Characters/Digits Transmitted.....	44
18. Disable Number of Characters/Digits Transmitted	46
19. Communication Parameters	47
20. Handshaking	49
21. Buzzer Operation	50
22. Positive & Negative Bar Codes	52
23. Setting the Trigger Function	52
24. Selecting the Read Mode	53
25. Scanner Timeout (Trigger Enabled Mode only)	55
26. Redundant Decoding.....	56
27. Transmitting Error Indications (Trigger Enabled only)	57
28. Print Quality Adjustments	57
29 Good Read Indicator Operation.....	586
30. Sequencer Controls.....	59
31. Motor Control	60

1. Global Default & Scanner Configurations

Computer Command	Function /Description	Bar Code Command
(Z7)	START/END Programming Menu	
U1	Return all parameters to Default settings	
1Y	Clear all prefixes	
1Z	Clear all suffixes	
P6	Disable Graph Mode	
U0	Scanner Test Mode	
U8	Read Rate Mode	
U9	Graph Mode (TBD)	



CONTINUED ON NEXT PAGE...

1. Global Default & Scanner Configurations (continued)

Computer Command	Function /Description	Bar Code Command
(Z7)	START/END Programming Menu	
Z1	Reset all values set by command	
Z2	Save all values set by command (not lost upon power off)	
Z3	Display software settings and version number	
Z4	Display prefix/suffix value length (expressed in hexadecimal format)	

Note: Where computer commands appear in parenthesis, bar code commands must be used to program the scanner.

Note: Scanner default settings are indicated by a pointing hand () symbol throughout the menus to follow.

* Use Z2 (Save all values set by command) after computer command to store settings in memory prior to power off.

Scanner Test Mode (U0) - This mode resets all unit parameters to a predefined set of defaults for the purpose of putting the scanner into a test mode which reads barcodes continuously. The predefined defaults are the following:

- ◆ Reads all barcodes by symbology
- ◆ No fixed number of digits defined (32 digits minimum).
- ◆ Normal scan, continuous scan.
- ◆ Large only.
- ◆ No verification, no "Bad Read (BR)".
- ◆ Buzzer 3KHz, volume maximum.
- ◆ Buzzer after decoding (10 ms).
- ◆ Good LED after decoding (green, 100 ms).
- ◆ RS232C (9600 baud, 8, 1, no parity, no handshaking).

Straight Across Scan Mode (U3) - This mode resets all unit parameters to predefined defaults for the purpose of allowing straight across scanning of up to 3 labels. The predefined defaults are the following:

- ◆ Reads all barcodes by symbology.
- ◆ No fixed number of digits defined (32 digits max.)
- ◆ Normal scan, multiple scan.
- ◆ Trigger disable.
- ◆ Small and large.
- ◆ No verification, no "Bad Read (BR)".
- ◆ Buzzer 3KHz and 2KHz, volume max.
- ◆ Buzzer after decoding (200 ms).

- ◆ Good LED after decoding (green, 200 ms).
- ◆ RS232C (9600 baud, 8, 1, no parity, no handshaking).

Read Rate Mode (U8) - This mode resets all unit parameters to a predefined set of defaults for the purpose of checking the scanner read rate. When activated, the test result is sent via RS232C and indicates the ration of the number of successful read to the total number of attempts. The test result is reported in the following format:

700 d OK: 93.5%
CODE-39 TEST

Where:

- ◆ 700d indicates the number of times the decoder ran while scanning at 700 scans per second (the number can be lower than 700 with poor quality barcodes).
- ◆ 93.5% indicates the percentage of good reads to total attempts. T
- ◆ The control character to be output is CR (ODE carriage return line fed), "ESC[3A" (cursor 3 line UP).

The predefined defaults are the following:

- ◆ Reads all barcodes by symbology.
- ◆ No fixed number of digits defined (32 digits max.).
- ◆ Normal scan, multiple scan.
- ◆ Trigger disabled.
- ◆ Small and large.
- ◆ Buzzer 3 KHz, volume max.)
- ◆ Buzzer after decoding (10 ms).
- ◆ Good LED after decoding (green 100 ms)
- ◆ RS232C (9600 bps, 8, 1, np, no handshaking).

2. Symbology Selection

Computer Command	Function /Description	Bar Code Command
(Z7)	START/END Programming Menu	
A0	Enable all bar code symbologies	
A1	Only WPC (including Addon)	
A2	Only Code 39	
A3	Only Codabar (NW-7)	
A4	Only 2 of 5 (Industrial or Interleaved)	
A5	Only Code 93	
A6	Only Code 128	
A7	Only MSI/Plessey	
A8	Only IATA	
J1	Only UPC (A/E)	
J2	Only UPC (A/E)+2	
J3	Only UPC (A/E)+5	
J4	Only EAN	
J5	Only EAN +2	

CONTINUED ON NEXT PAGE...

2. Symbology Selection (continued)

Computer Command	Function /Description	Bar Code Command
(Z7)	START/END Programming Menu	
J6	Only EAN +5	
J7	Only Industrial 2 of 5	
J8	Only Interleaved 2 of 5	
Z9	Remote Menu	











3. Add/Activate Specific Bar Code Symbologies

Computer Command	Function /Description	Bar Code Command
(Z7)	START/END Programming Menu	
B1	Enable all WPC (including Addon)	
B2	Enable Code 39	
B3	Enable Codabar (NW-7)	
B4	Enable 2 of 5 (Industrial/Interleaved)	
B5	Enable Code 93 (Factory Set)	
B6	Enable Code 128 (Factory Set)	

















CONTINUED ON NEXT PAGE...

3. Add/Activate Specific Bar Code Symbologies (continued)

Computer Command	Function /Description	Bar Code Command
(Z7)	START/END Programming Menu	
B7	Enable MSI/Plessey	
B8	Enable IATA	
R1	Enable UPC (A/E)	
R2	Enable UPC (A/E) +2	
R3	Enable UPC (A/E) +5	
R4	Enable EAN (13/8)	
R5	Enable EAN (13/8) +2	
R6	Enable EAN (13/8) +5	
R7	Enable Industrial 2 of 5	
R8	Enable Interleaved 2 of 5	

4. Delete/Deactivate Specific Bar Code Symbologies

Computer Command	Function /Description	Bar Code Command
(Z7)	START/END Programming Menu	
4A	Disable all WPC (including Addon)	
4B	Disable UPC (A/E)	
4C	Disable UPC (A/E) +2	
4D	Disable UPC (A/E) +5	
4E	Disable EAN (13/8)	
4F	Disable EAN (13/8) +2	
4G	Disable EAN (13/8) +5	
4H	Disable Code 39	
4I	Disable Codabar (NW-7)	
4J	Disable 2 of 5 (Industrial/Interleaved)	
4K	Disable Industrial 2 of 5	
4L	Disable Interleaved 2 of 5	
4M	Disable Code 93	

CONTINUED ON NEXT PAGE...

4. Delete/Deactivate Specific Bar Code Symbolologies (continued)

Computer Command	Function /Description	Bar Code Command
(Z7)	START/END Programming Menu	
4N	Disable Code 128	
4O	Disable MSI/Plessey	
4P	Disable IATA	
4Z	Disable all symbolologies	

5. Options for UPC

Computer Command	Function /Description	Bar Code Command
(Z7)	START/END Programming Menu	
E2	UPC-A (13 Digits) Add leading zero; Enable check digit	
E3	UPC-A (12 Digits) Do not add leading zero; Enable check digit	
E4	UPC-A (12 Digits) Add leading zero; Disable check digit	
E5	UPC-A (11 Digits) Do not add leading zero; Disable check digit	
E6	UPC-E (8 Digits) Add leading zero; Enable check digit	
E7	UPC-E (7 Digits) Do not add leading zero; Enable check digit	
E8	UPC-E (7 Digits) Add leading zero; Disable check digit	
E9	UPC-A (6 Digits) Do not add leading zero; Disable check digit	



6. Options for Code 39

Computer Command	Function /Description	Bar Code Command
(Z7)	START/END Programming Menu	
7C	Enable 1 character (3 characters including start/stop characters)	
7D	Disable 1 character	
C0	Disable check digit calculation	
C1	Enable check digit calculation	
C2	Transmit check digit	
C3	Do not transmit check digit	
D0	Do not transmit start/stop characters (*.....*)	
D1	Transmit start/stop characters (*.....*)	

- 43 Data digits are available: 0 to 9, A to Z (caps only) plus . - \$ / + % and space. If a check digit is present, it will appear as part of the data.
- If the scanner is programmed to calculate the check digit, and the bar code is not printed with a check digit, the bar code will not read.
- Another option available for Code 39 is to enable the reading of a single character bar code. See the section on Fixing the Digit for this option.

7. Options for Codabar (NW-7)

Computer Command	Function / Description	Bar Code Command
(Z7)	START/END Programming Menu	
7K	Enable 1 character (3 characters including start/stop characters)	
7L	Disable 1 character	
F0	Do not transmit start/stop characters	
F1	Transmit start/stop characters as ABCD/TN*E	
F2	Transmit start/stop characters as abcd/tn*e	
F3	Transmit start/stop characters as ABCD/ABCD	
F4	Transmit start/stop characters as abcd/abcd	
F5	Transmit check digit	
F6	Do not transmit check digit	
F7	Do not calculate check digit	
F8	Calculate check digit (Modulo 10)	
F9	Calculate check digit (Modulo 16) (AIM specifications)	
FB	Calculate check digit (Modulo 7)	



CONTINUED ON NEXT PAGE...

Codabar (NW-7) Format

Start Character	1 to 42 data digits	Check digit	Stop Character
A T
a t
A A
a a

- Codabar (NW-7) has four different start/stop character schemes as shown above. The check digit is optional and, if present, would be the last character.
- If the scanner is programmed to calculate the check digit and the bar code is not printed with a check digit, the bar code will not be read.

8. Options for Interleaved 2 of 5

Computer Command	Function /Description	Bar Code Command
(Z7)	START/END Programming Menu	
G0	Do not calculate check digit	
G1	Calculate check digit	
G2	Transmit Check digit	
G3	Do not transmit check digit	
7M	Enable 2 characters	
7N	Disable 2 characters	

2 of 5 Format (Standard and Interleaved)

1 to 44 data digits	CD
numeric only (0 to 9)	Check Digit

Opticon strongly recommends that the "Fixing the Number of Digits" featured on page 32 be employed whenever 2 of 5 bar codes are used.

9. Options for IATA

Computer Command	Function /Description	Bar Code Command
(Z7)	START/END Programming Menu	
D2	Do not calculate check digit	
D3	Calculate check digit (CPN + Form + Serial)	
D4	Calculate check digit (Form + Serial)	
D5	Calculate check digit (All data)	
D6	Transmit check digit	
D7	Do not transmit check digit	



The IATA code is a variable length symbology with an optional check digit and non-printable start/stop characters. The following characters are supported: Digits 0 up to 9.

The checksum is calculated as the modulo seven of the data string. IATA is an acronym for International Air Transport Association.

String format	CPN	AC	FC	SN	CD
Meaning of Acronym	Coupon	Airline Code	Form Code	Serial Number	Check Digit
Number of digits (15 total)	1	3	2	8	1

- ◆ Enable check digit check
- ◆ Selection of the check digit calculation
- ◆ Disable transmission of the check digit

Check digit calculation: If the check digit calculation is required, then the appropriate calculation method must be selected.

10. Fixing the Number of Digits

Computer Command	Function /Description	Bar Code Command
(Z7)	START/END Programming Menu	
7V	Enable fixation (1 Length)	
7W	Enable fixation (2 Lengths)	
(H0)	Disable fixation	
(H1)	Enable fixation (1 length)	
(H4)	Enable fixation (t lengths)	
H2	Disable 1 character Code 39 and Codabar (NW-7); Disable 2 characters 2 of 5	
H3	Enable 1 character Code 39 and Codabar (NW-7); Enable 2 characters 2 of 5	



To avoid truncation errors, the scanner can be programmed to only decode bar codes of one specific length, i.e., containing a specific number of digits. It is also possible to program the scanner to only decode bar codes of either of two specific lengths.

To fix one (1) length (or number of digits) of bar code:

1. Scan "START" to enter the programming mode
2. Scan "Enable fixation(H1)" bar code
3. Scan a sample bar code of the desired length
4. Repeat Step #3, re-scanning the sample bar code
5. Scan "STOP" to exit the programming mode

To fix two (2) different lengths of bar codes:

1. Scan "START" to enter the programming mode
2. Scan "Enable fixation(H4)" bar code
3. Scan a sample bar code of the desired length #1
4. Scan a sample bar code of the desired length #2
5. Scan "STOP" to exit the programming mode

NOTE: Fixation can also be programmed using computer commands through your RS232 by typing <ESC>7V<CR> followed by <+>2 digit length 1<CR>. 7W would be appropriate for length 2. Type<+>00<CR> to define either length as no fixed number.

"Fixing the Number of Digits" can only be applied to Code 39, Codabar (NW-7), 2 or 5 and MSI/Plessey. WPC, Code 93, IATA and Code 128 are not affected.

11. Creating a Prefix and/or Suffix

Computer Command	Function /Description	Bar Code Command
(Z7)	START/END Programming Menu	
1Y	Clear all Prefixes	
Z4	Display Prefix/Suffix value and length (expressed in hexadecimal format)	



The scanner can be programmed to transmit a prefix and/or suffix with the decoded data. A Prefix (or a Suffix) is composed of up to 4 characters. The following steps are used to establish a Prefix that will be transmitted with the bar code data:

1. Scan Start
2. Scan the bar code representing the symbology to which you wish to add a Prefix
3. Scan the character(s) that will comprise the Prefix. Up to four numeric, alpha or control character(s) may be used.
4. Scan "STOP" to exit the Programming Mode.

Example: To add the alpha character "A" as a Prefix and "B" as a Suffix to UPC-A bar code data:

1. Scan "START/END Programming Mode"
2. Scan N1, representing a Prefix for UPC-A
3. Scan 0A, representing the alpha character "A"
4. Scan N6, representing a Suffix for UPC-A
5. Scan 0B, representing the alpha character "B"
6. Scan "START/END Programming Mode"

The same steps are used to establish a Suffix.

12. Setting Prefixes (Identifying the Symbology)

Computer Command	Function /Description	Bar Code Command
(Z7)	START/END Programming Menu	
1Y	Clear all Prefixes	
N1	UPC-A	
M0	UPC-A +2 or +5	
N2	UPC-E	
M1	UPC-E +2 or +5	
N3	EAN-13	
M2	EAN -13 +2 or +5	
N4	EAN-8	
M3	EAN-8 +2 or +5	
M4	Code 39	
M5	Codabar (NW-7)	
M6	Industrial 2 of 5	
M7	Interleaved 2 of 5	



CONTINUED ON NEXT PAGE...

12. Setting Prefixes (Identifying the Symbology) (continued)













Computer Command	Function /Description	Bar Code Command
(Z7)	START/END Programming Menu	
M8	Code 93	
M9	Code 128	
D8	IATA	
N0	MSI/Plessey	
Z4	Display Prefix/Suffix value and length (expressed in hexadecimal format)	

13. Setting Suffixes (Identifying the Symbology)

Computer Command	Function /Description	Bar Code Command
(Z7)	START/END Programming Menu	
1Z	Clear all Suffixes	
N6	UPC-A	
O0	UPC-A +2 or +5	
N7	UPC-E	
O1	UPC-E +2 or +5	
N8	EAN-13	











COINTINUED ON NEXT PAGE...

13. Setting Suffixes (Identifying the Symbology) (continued)

Computer Command	Function /Description	Bar Code Command
(Z7)	START/END Programming Menu	
O2	EAN-13 +2 or +5	
N9	EAN-8	
O3	EAN-8 +2 or +5	
O4	Code 39	
O5	Codabar (NW-7)	
O6	Industrial 2 of 5	
O7	Interleaved 2 of 5	
O8	Code 93	
O9	Code 128	
D9	IATA	
N5	MSI/Plessey	
Z4	Display Suffix value and length	

NOTE: The global default, also clears all suffixes.

14. Direct Input of Numeric Characters

Computer Command	Function /Description	Bar Code Command
(Z7)	START/END Programming Menu	
Q0	0	
Q1	1	
Q2	2	
Q3	3	
Q4	4	
Q5	5	
Q6	6	
Q7	7	
Q8	8	
Q9	9	

15. Direct Input of Alpha Characters

(Z7)	START/END Program Menu	
0A	A	
0B	B	
0C	C	
0D	D	
0E	E	
0F	F	
0G	G	
0H	H	
0I	I	
0J	J	
0K	K	
0L	L	
0M	M	

0N	N	
0O	O	
0P	P	
0Q	Q	
0R	R	
0S	S	
0T	T	
0U	U	
0V	V	
0W	W	
0X	X	
0Y	Y	
0Z	Z	
(Z7)	START/END Program Menu	

16. Direct Input of Control Characters

Computer Command	Function /Description	Bar Code Command
(Z7)	START/END Programming Menu	
1A	STX	
1B	ETX	
1C	CR	
1D	LF	













17. Enable Number of Characters/Digits Transmitted

This feature instructs the scanner to calculate and transmit a number indicating the total number of characters that are being transmitted to the host. This feature allows the host to verify that the correct amount of data was received.

Computer Command	Function /Description	Bar Code Command
(Z7)	START/END Programming Menu	
3A	UPC-A	
3B	UPC-A +2 or +5	
3C	UPC-E	
3D	UPC-E +2 or +5	
3E	EAN-13	
3F	EAN-13 +2 or +5	

CONTINUED ON NEXT PAGE...

17. Enable Number of Characters/Digits Transmitted (continued)

(Z7)	START/END Programming Menu	
3G	EAN-8	
3H	EAN-8 +2 or +5	
3I	Code 39	
3J	Codabar (NW-7)	
3K	Industrial 2 of 5	
3L	Interleaved 2 of 5	
3M	Code 93	
3N	Code 128	
3O	MSI/Plessey	
3P	IATA	
3Z	Transmit data length (all symbologies)	

18. Disable Number of Characters/Digits Transmitted

Computer Command	Function /Description	Bar Code Command
(Z7)	START/END Programming Menu	
2A	UPC-A	
2B	UPC-A +2 or +5	
2C	UPC-E	
2D	UPC-E +2 or +5	
2E	EAN-13	
2F	EAN-13 +2 or +5	
2G	EAN-8	
2H	EAN-8 +2 or +5	
2I	Code 39	
2J	Codabar (NW-7)	
2K	Industrial 2 of 5	
2L	Interleaved 2 of 5	
2M	Code 93	

CONTINUED ON NEXT PAGE...

18. Disable Number of Characters/Digits Transmitted (continued)

Computer Command	Function /Description	Bar Code Command
(Z7)	START/END Programming Menu	
2N	Code 128	
2O	MSI/Plessey	
2P	IATA	
2Z	Do not transmit data length (all symbologies)	

19. Communication Parameters

Computer Command	Function /Description	Bar Code Command
(Z7)	START/END Programming Menu	
K1	300 Baud *	
K2	600 Baud *	
K3	1,200 Baud *	
K4	2,400 Baud *	
K5	4,800 Baud *	
K6	9,600 Baud	



* Use Z2 Command after computer command to store settings in memory prior to power off.

CONTINUED ON NEXT PAGE...

19. Communication Parameters (continued)

Computer Command	Function /Description	Bar Code Command
(Z7)	START/END Programming Menu	
K7	19,200 Baud *	
K8	38,400 Baud *	
L0	7 Data Bits *	
L1	8 Data bits *	
L2	Parity = None	
L3	Parity = Even *	
L4	Parity = Odd *	
L5	1 Stop Bit *	
L6	2 Stop Bits *	



* Use Z2 Command after computer command to store settings in memory prior to power off.

20. Handshaking

Computer Command	Function /Description	Bar Code Command
(Z7)	START/END Programming Menu	
I0	Wait for CTS from terminal = Unlimited	
I1	Wait for CTS from terminal = 100 mS	
I2	Wait for CTS from terminal = 200 mS	
I3	Wait for CTS from terminal = 400 mS	
I4	ACK/NAK Delay Time Unlimited	
I5	ACK/NAK Delay Time = 100 mS	
I6	ACK/NAK Delay Time = 500 mS	
I7	ACK/NAK Delay Time = 1000 mS	
P0	No Handshaking * (Factory Set)	
P1	Busy/Ready *	
P2	Modem *	
P3	ACK/NAK *	
P4	ACK / NAK no buzzer response on timeout*	
P5	No ACK/NAK *	



* Use Z2 Computer Command to store in memory prior to power off.





21. Buzzer Operation

Computer Command	Function /Description	Bar Code Command
(Z7)	START/END Programming Menu	
T0	Volume = Maximum	
T1	Volume = Upper Mid-range	
T2	Volume = Lower Mid-range	
T3	Volume = Minimum	
V5	Ring buzzer once at 3kHz for 200 mS	
V6	Ring buzzer once at 3kHz, 2kHz interval for 200 mS	
V7	Ring buzzer once at 2kHz, 3kHz interval for 200 mS	
W0	Disable buzzer	
W1	Enable buzzer at 3kHz	
W2	Enable buzzer at 3kHz with 2.5kHz interval	
W3	Enable buzzer at 2kHz with 3kHz interval	
W4	Buzzer duration 0.10 sec	



CONTINUED ON NEXT PAGE...

21. Buzzer Operation (continued)

Computer Command	Function /Description	Bar Code Command
(Z7)	START/END Programming Menu	
W5	Buzzer duration 0.20 sec	
W6	Buzzer duration 0.40 sec	
W7	Buzzer duration 0.05 sec	
W8	Buzzer duration 0.01 sec	



22. Positive & Negative Bar Codes

Computer Command	Function /Description	Bar Code Command
(Z7)	START/END Programming Menu	
V4	Positive bar code only (black bars/white spaces)	
V2	Both positive & negative bar code	



23. Setting the Trigger Function

Computer Command	Function /Description	Bar Code Command
(Z7)	START/END Programming Menu	
S7	Disable the trigger function / Red scanning light is ON continuously (Factory Set)	
S8	Enable the trigger function /Red scanning light is OFF until trigger is activated or "pulled"	
Z	Activate the trigger; turns on the red scanning light	Use Computer Command



The Trigger function is disabled in the default setting. This means that the red scanning light is "ON" continuously and the scanner is always ready to read. For some applications, you may wish to activate the scanner only at a specific time. This can be done by enabling the Trigger function. Once in the "Trigger Enabled" mode, the red scanning light is OFF until the trigger is activated or "pulled." Either a hardware trigger or a software trigger pulse may be used to activate the scanner.

The hardware trigger is actuated by pulling Pin #1 (on the standard 9-pin mini-DIN connector) LOW. The software trigger is actuated by downloading and <ESC> Z <CR> computer command from the host. (See Scanner Timeout to establish the length of time the scanning light remains ON after the trigger is activated.)

24. Selecting the Read Mode

Computer Command	Function /Description	Bar Code Command
(Z7)	START/END Programming Menu	
S0	Single Read Mode (Trigger enabled mode only)	
S1	Multiple Read Mode	
S2	Continuous Read Mode	
7H	Does not allow first bar distortion	
7I	Allow first bar distortion *	
7O	Normal Scan	
7P	Slanted Scan	
7Y	Regular expression up to 5 labels	

* Relaxes tolerance on first bar, increasing to 8x narrow bar width on first bar. Decoding time may be increased.

CONTINUED ON NEXT PAGE...

24. Selecting the Read Mode (continued)

The operation of the scanner in the various read modes is described in the table below. The "Continuous Read" mode is helpful in positioning the scanner for optimum reading. In "Continuous Read," the scanner's buzzer functions like a Geiger counter, sounding the most active at the position achieving the greatest number of good reads.

Mode	Trigger Function Enabled	Trigger Function Disabled
Multiple Read	After receiving a trigger pulse, scanner will read multiple, different bar codes in succession until it times out.	Scanner will read different bar codes in succession if they are presented to the read window.
	Scanner will not read the same bar code twice if they are consecutive.	Scanner will not read the same bar code twice if they are consecutive.
Continuous Read	Scanner will read the same bar code continuously after receiving a trigger pulse until scanner times out.	Scanner will read the same bar code continuously.
Single Read	Scanner will read only one bar code after receiving a trigger pulse.	Same as Multiple Read mode, above.

25. Scanner Timeout (Trigger Enabled Mode only)







These commands, which are only applicable in the Trigger Enabled mode, establish the time-out period after the trigger pulse is received. The Time-out period is the same whether the scanner is operating in Single, Multiple or Continuous Read mode.

Computer Command	Function /Description	Bar Code Command
(Z7)	START/END Programming Menu	
Y0	Trigger remains ON as long as trigger is pulled (hardware trigger only)	
Y1	1 Second after triggering	
Y2	2 Seconds after triggering	
Y3	3 Seconds after triggering	
Y4	4 Seconds after triggering	
Y5	6 Seconds after triggering	
Y6	8 Seconds after triggering	
Y7	10 Seconds after triggering	



26. Redundant Decoding

The Number of Redundant Decodes determines how many times the scanner must decode a bar code and obtain the same value before it will transmit the data. For example, if the redundancy is set at three times, the scanner will not transmit data until it has decoded the bar code and obtained the same values three times in succession. If it obtains the same value twice in a row, but a different value on the third read attempt, it will not transmit. If it gets the same value three out of four times, it will not transmit. It must receive three consecutive, identical reads.

Computer Command	Function /Description	Bar Code Command
(Z7)	START/END Programming Menu	
X0	Read bar code once	
X1	Read bar code twice	
X2	Read bar code three times	
X3	Read bar code four times	
7R	Read bar code five times	
7S	Read bar code six times	



27. Transmitting Error Indications (Trigger Enabled only)

Computer Command	Function /Description	Bar Code Command
(Z7)	START/END Programming Menu	
5E	Do not transmit error code	
5F	Transmit "BR" <CR> for bad read or no read	
5G	Transmit <STX>">"<ETX> for bad read; <STX>"?"<ETX> for no read	
5H	Transmit ">"<CR> for bad read Transmit "?"<CR> for no read	
5I	Transmit "CAN"<CR> for bad read or no read	
5J	Transmit <STX>"CAN"<ETX> for bad read or no read	



28. Print Quality Adjustments

Computer Command	Function /Description	Bar Code Command
(Z7)	START/END Programming Menu	
X4	For lower density, poor print quality bar code, e.g., dot matrix with voids (low analog gain)	
X5	For high density, good print quality bar code without voids (high analog gain)	
X6	Output data obtained from Low or High analog gain	
X7	Output data obtained from Low and High analog gain	



29. Good Read LED Operation

Computer Command	Function /Description	Bar Code Command
(Z7)	START/END Programming Menu	
T4	Good read LED disabled after decode	
T8	Good read LED ON after decode for .10 seconds	
T5	Good read LED ON after decode for .20 seconds	
T6	Good read LED ON after decode for .40 seconds	
T7	Good read LED ON after decode for .80 seconds	
V0	LED ON Red for .40 seconds	
V1	LED ON Red for .80 seconds	
V8	LED ON Green for .40 seconds	
V9	LED ON Green for .80 seconds	



30. Sequencer Controls

Computer Command	Function /Description	Bar Code Command
(Z7)	START/END Programming Menu	
8A	Trigger Input (sync signal positive logic) High active	
8B	Trigger Input (sync signal negative logic) Low Active	
8C	Sequencer output synchronous transmission (negative true logic)*	
8D	Sequencer output synchronous transmission * (positive – true logic)	
8E	Sequencer output one-shot transmission *	
8F	Sequencer output one-shot transmission * (negative – true logic)	
8G	Sequencer output one-shot duration 10 mS	
8H	Sequencer output one-shot duration 20 mS	
8I	Sequencer output one-shot duration 30 mS	
8J	Sequencer output one-shot duration 40 mS	
8K	Sequencer output one-shot duration 50 mS	
8L	Sequencer output one-shot duration 60 mS	



* Use Z2 computer command to store in memory prior to power off.

CONTINUED ON NEXT PAGE...

30. Sequencer Controls

Computer Command	Function /Description	Bar Code Command
(Z7)	START/END Programming Menu	
8M	Sequencer output one-shot duration 70 mS	
8N	Sequencer output one-shot duration 80 mS	
8O	Sequencer output one-shot duration 90 mS	
8P	Sequencer output one-shot duration 100 mS	
8Q	Outputs sequencer *	
8R	Does not output sequencer *	



* Use Z2 computer command to store in memory prior to power off.

31. Motor Controls

Computer Command	Function /Description	Bar Code Command
(Z7)	START/END Programming Menu	
S6	Motor always ON	
S5	Motor OFF until trigger	



Appendix D Dimensional Drawings

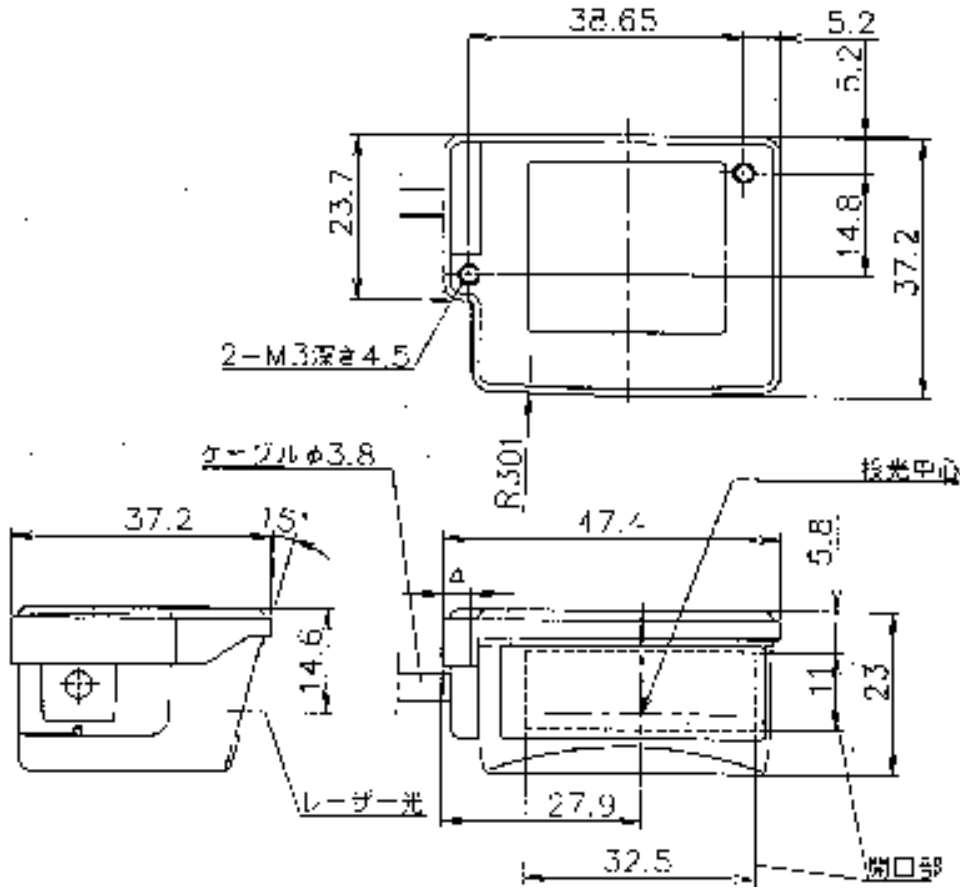

All dimensions in millimeters

Appendix E
LPN5627 - Optical Performance (typical unit)

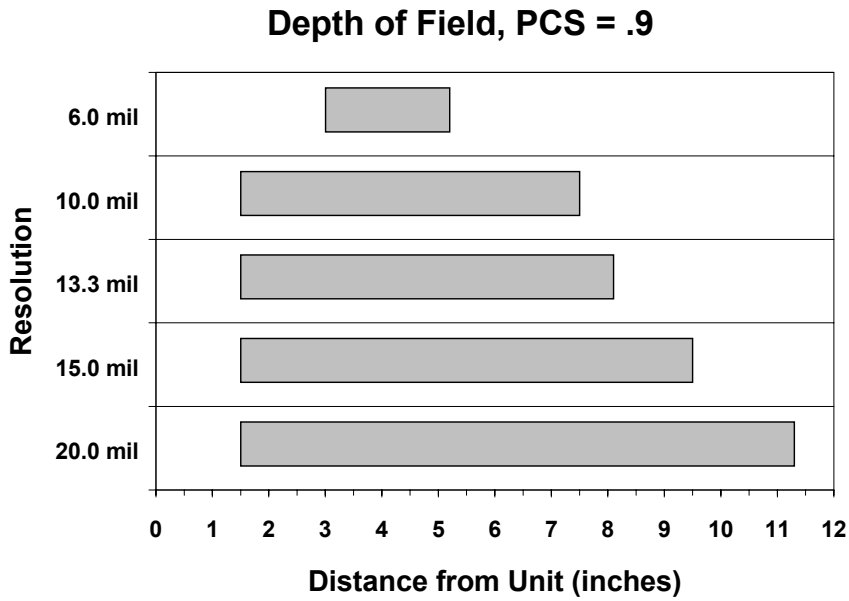

LPR5627 (Raster) - Optical Performance (typical unit)

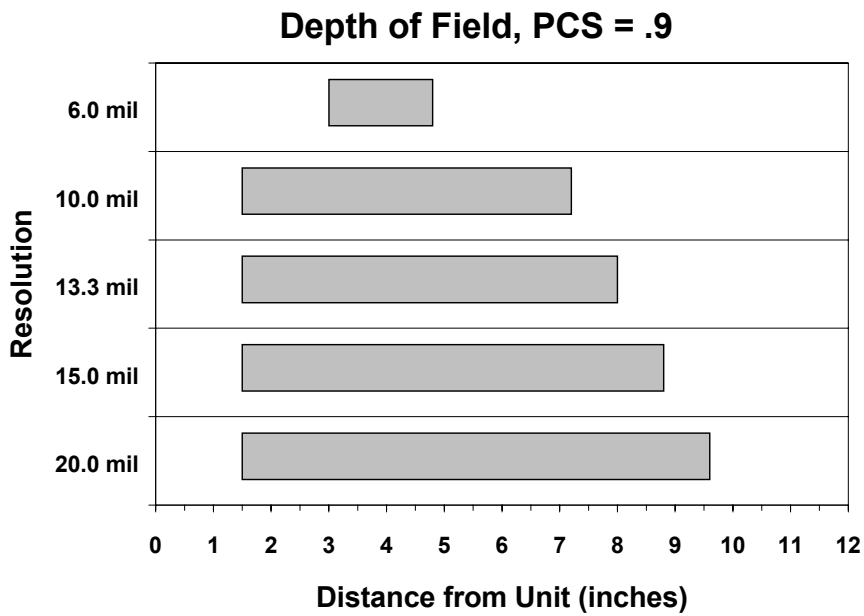

Notes