

OPTICON

2D Scan Engine

MDI-2350

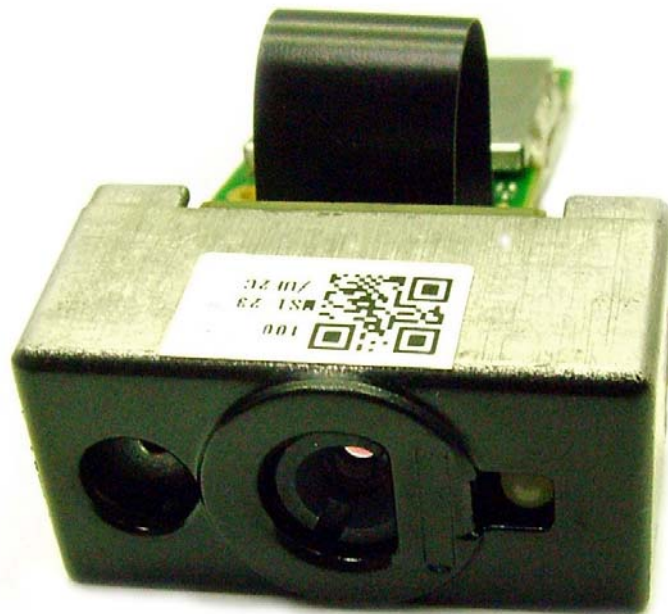

This document provides the configuration specifications for the fixed-focus imager scan engine, MDI-2350.

Serial Interface Specifications Manual

All information subject to change without notice.

Document History

Model Number:	MDI-2350	Specification Number:	SI12002
Edition:	First	Original Spec Number:	-
Date:	2012-01-10		

Copyright 2010 Opticon. All rights reserved.

This manual may not, in whole or in part, be copied, photocopied, reproduced, translated or converted to any electronic or machine readable form without prior written consent of Opticon.

Limited Warranty and Disclaimers

PLEASE READ THIS MANUAL CAREFULLY BEFORE INSTALLING OR USING THE PRODUCT.

Serial Number

A serial number appears on all Opticon products. This official registration number is directly related to the device purchased. Do not remove the serial number from your Opticon device. Removing the serial number voids the warranty.

Warranty

Unless otherwise agreed in a written contract, all Opticon products are warranted against defects in materials and workmanship for two years after purchase. Opticon will repair or, at its option, replace products that are defective in materials or workmanship with proper use during the warranty period. Opticon is not liable for damages caused by modifications made by a customer. In such cases, standard repair charges will apply. If a product is returned under warranty and no defect is found, standard repair charges will apply. Opticon assumes no liability for any direct, indirect, consequential or incidental damages arising out of use or inability to use both the hardware and software, even if Opticon has been informed about the possibility of such damages.

Packaging

The packing materials are recyclable. We recommend that you save all packing material to use should you need to transport your scanner or send it for service. Damage caused by improper packaging during shipment is not covered by the warranty.

Trademarks

Trademarks used are the property of their respective owners.

Opticon Inc. and Opticon Sensors Europe B.V. are wholly owned subsidiaries of OPTOELECTRONICS Co., Ltd., 12-17, Tsukagoshi 4-chome, Warabi-shi, Saitama, Japan 335-0002. TEL +81-(0) 48-446-1183; FAX +81-(0) 48-446-1184

SUPPORT

USA

Phone: 800-636-0090

Email: support@opticonusa.com

Web: www.opticonusa.com

Europe

Email: support@opticon.com

Web: www.opticon.com

Revision History

Specification No. : SI12002
Product name : MDI-2350

Edition	Date	Page	Section	Description of Changes
First	2012/01/10	-	-	Initial release

Contents

1. Abstract	1
2. Configuration	1
2.1. Configuring with Menu Bar Codes.....	2
2.2. Configuring with 2D Menu Codes.....	3
2.3. Configuring with Commands	4
2.4. Basic Commands	5
2.4.1. Default Settings	5
2.4.2. Saving Settings.....	5
2.4.3. Trigger	5
2.4.4. Diagnostics	5
2.4.5. ACK/NAK for Serial Commands.....	6
2.4.6. Buzzer and Indicator.....	6
3. Interface Specifications	7
3.1. Serial Interface	7
3.1.1. Default Setting	7
3.1.2. Input/Output Signals.....	7
3.1.3. Character Format	8
3.1.4. Communication Format	8
3.1.5. Handshaking.....	8
3.1.6. Communication Settings.....	12
3.1.7. Interface Commands List.....	12
4. Timing Characteristics	13
4.1. Code Read Timing.....	14
4.2. Power On / Off Timing	15
4.2.1. Power-On	15
4.2.2. Power-Off	15
4.3. Power Down Mode	16
4.3.1. Transition from Power On to Power Down Mode.....	16
4.3.2. Transition from Standby Mode to Power Down Mode.....	16
4.3.3. Recovery from Power Down Mode.....	17
5. Module Settings	18
5.1. Setting of Readable Codes.....	19

5.1.1.	1D Codes.....	19
5.1.2.	2D Codes.....	20
5.1.3.	Other Options	20
5.2.	Setting of Number of Characters	21
5.2.1.	Fixed Length OFF All Codes	21
5.2.2.	Fixed Length ON All Codes	21
5.2.3.	Fixed Length ON, Minimum / Maximum Length for Selected Codes	22
5.2.4.	Command List: Setting of Number of Characters	23
5.2.5.	Command List: Fixed Length ON / Minimum / Maximum Length for Selected Codes.....	23
5.3.	Setting Code Specific Options.....	24
5.3.1.	Code Options.....	24
5.3.2.	Options for Specific Code Setting	25
5.3.3.	Options for Composite Codes Setting	28
5.3.4.	Outputs for Composite Code Setting.....	28
5.4.	String Options	29
5.4.1.	Case Conversion	32
5.4.2.	Set Prefix / Suffix	32
5.4.3.	Prefix / Suffix Values	33
5.4.4.	Set Code ID and Code Length	34
5.4.5.	OPTICON Code ID Prefix / Suffix Values.....	34
5.4.6.	AIM/ISO15424 Code ID Prefix / Suffix Values	35
5.4.7.	Code Options AIM/ISO15424 Code ID Prefix / Suffix Values	35
5.5.	Read Mode Settings (Basic Settings).....	38
5.5.1.	Read Mode Options.....	38
5.5.2.	Trigger Switch Options (S7, S8).....	38
5.5.3.	Add-on Delay Timer (XA to XD)	38
5.5.4.	Multiple Read Reset Time (AG to AN)	39
5.5.5.	Quiet Zone	39
5.5.6.	Auto Trigger.....	40
5.5.7.	Read Time	40
5.5.8.	Redundancy	41
5.5.9.	Positive and Negative Codes	41
5.6.	Read Mode Settings (Imager Settings)	42
5.6.1.	Illumination and Aiming	42

5.6.2.	Central Reading.....	42
5.6.3.	1D Code Decode Mode.....	43
5.6.4.	Snapshot and Decoding Parallelism	43
5.6.5.	Collective Reading.....	43
5.6.6.	Structured Append Options	44
5.6.7.	Scanning on LCD Display.....	44
5.6.8.	Mirror Image Capture Mode	45
5.6.9.	External Illumination	45
5.7.	Indicator Settings.....	46
5.7.1.	Good Read Buzzer.....	46
5.7.2.	Read Timeout Buzzer.....	46
5.7.3.	Good Read LED	46
6.	Appendix.....	47
6.1.	Setting Output Table.....	47
6.1.1.	Setting Table (Z3 Command).....	47
6.1.2.	Differential Setting Output Table (EAR Command).....	48
6.2.	Sample Codes	49

1. Abstract

This document provides the configuration specifications for the MDI-2350 fixed-focus imager scan engine (hereafter called “scan engine”).

2. Configuration

The following methods are provided for configuring the scan engine:

[2.1. Configuring with Menu Bar Codes](#)

[2.2. Configuring with 2D Menu Codes](#)

[2.3. Configuring with Commands](#)

2.1. Configuring with Menu Bar Codes

By scan the menu bar code labels specially designed to configure the required functions, you can set up the scan engine to optimize its performance for your particular application.

The basic procedure is as follows:

1. Scan **SET** menu label (ZZ). The scan engine now enters menu mode.
2. Select and scan the desired option (s). Multiple menu labels can be read when you want to configure more than one options.
3. Read **END** menu label (ZZ). All the settings are saved in nonvolatile memory.

Menu bar codes can be identified by an ID consisting of two to five alphanumeric characters. Menu bar codes have unique encoding specifications developed by OPTOELECTRONICS. Therefore, the scan engine will not acknowledge a menu bar code as a normal bar code.

Examples of Menu Bar Codes

When enabling Transmit Code 39 Start/Stop (D0)

Start Menu mode



Transmit Start/Stop (D0)



End Menu mode



2.2. Configuring with 2D Menu Codes

A 2D menu code contains multiple menu strings and they are processed all at once. Therefore, you can configure the scan engine with multiple settings by reading only one 2D menu code.

Note: The option “5.2.4. Setting of number of characters” is not supported by 2D menu codes since it needs to be followed by scanning normal, non menu type, bar codes with the correct length to set the required number of characters. There are also some other special menus that cannot be configured by 2D menu codes. In that case, menu bar codes need be used (see 2.1.).

For 2D menu code, use 2D codes (PDF417, QR code, etc.) typically used as they are.

Data format:

@MENU_OPTO	(Start key)
@	(Separator)
ZZ	(Start menu)
@	(Separator)
Any menu command	(U2 etc)
ZZ	(End menu)
@	(Separator)
OTPO_UNEM@	(Stop Key)

← It is ok to contain multiple sets of them.

Example of 2D Menu Code

To return to factory default (U2)



@MENU_OPTO@ZZ@U2@ZZ@OTPO_UNEM@

Example of 2D Multiple Menu Code

To return to default and transmit Code 39 start/stop code (U2) (D0)



@MENU_OPTO@ZZ@U2@D0@ZZ@OTPO_UNEM@

To enable/disable the processing of 2D multi menu codes, use the settings below.

Item	Command	Description	Default
Enable/Disable 2D multi menu bar code	D1Y	Enable 2D multi menu bar code	○
	D1Z	Disable 2D multi menu bar code	

2.3. Configuring with Commands

Settings can be configured by sending commands via the serial interface. The default command format is as shown below:

(1) Command Format

Command Header	Command ID ^{*1}		Command Terminator
ESC (1BH) or STX (02H)	1 ~ 2 digits (ASCII)		CR (ODH) or ETX (03H)
	[(5BH)	3 digits (ASCII)	
](5DH)	4 digits (ASCII)	

*1: It is possible to send multiple command IDs between a single header and terminator, except for a single command (1-digit) IDs.

Input examples:

- 1-digit command : <Esc>△<CR>
- 2-digit command : <Esc>△△<CR>
- 3-digit command : <Esc>[△△△<CR>
- 4-digit command : <Esc>]△△△△<CR>
- 2 and 3 digits command : <Esc>△△[△△△△<CR>

(2) Command Usage Precautions

- When sending multiple commands in a sequence, the subsequent command is not received while the previous command is still being executed. Since the RTS output will be in busy state while a command is executed when the Handshake is set to BUSY/READY or MODEM, it is recommended to refer to this signal for the right timing.
- Any settings configured by commands are not retained in the nonvolatile memory. Therefore, these will be lost when the scan engine power is turned off. When the power comes back on, the scan engine will be in the configuration state saved in the nonvolatile memory. In order to save the settings with commands, send "Z2" to save all the parameters in nonvolatile memory.
- Since there is a possibility to go out of control when the following interface-related settings are configured with commands, it will not be reflected until they are written in the nonvolatile memory using Z2.
 - Baud rate, Data length, Parity and Stop bit

NOTE: Settings made by reading 1D or 2D menu labels (see [2.1](#) and [2.2](#)) will be saved in non volatile memory. Any settings made prior via commands will be saved as well.

2.4. Basic Commands

2.4.1. Default Settings

This option allows you to undo all previously configured settings and bring the scan engine to factory default. The default setting is marked with a circle in the default column.

Item	Command	Description	Default	Remark
Default	U2	RS232C	○	

2.4.2. Saving Settings

The Z2 command is used to save the settings in nonvolatile memory. Some options, such as baud rate setting, will be enabled after this command is transmitted. Most options will be enabled after the commands are transmitted, but the scan engine will return to default when the power is switched off. To retain the setting configured, this command needs to be sent.

Item	Command	Description	Default	Remark
Save Setting	Z2	Save parameters		

2.4.3. Trigger

The trigger command can trigger the MID-2x00 just as if the trigger button is pressed. Send the Y command to stop reading.

Item	Command	Description	Default	Remark
Trigger	Z	Trigger the scanner		
	Y	Stop reading		

2.4.4. Diagnostics

These commands can be used to get diagnostics information from the scan engine.

Item	Command	Description	Default	Remark
Diagnostics	Z1	Transmit software version		
	Z3	Transmit settings		See 6.1.1.
	EAR	Transmit only changes from default		See 6.1.2.
	ZA	Transmit ASCII printable string		
	YV	Transmit ASCII control string		

Note: The Z3 output result is subject to change when the firmware version is changed.

2.4.5. ACK/NAK for Serial Commands

When "ACK/NAK for serial commands" is enabled, the scan engine will send an ACK (06H) in case a command is received and accepted. A NAK (15H) will then be send when a command is rejected.

Item	Command	Description	Default	Remark
ACK/NAK	WC	Enable ACK/NAK for serial command		
	WD	Disable ACK/NAK for serial command	○	

2.4.6. Buzzer and Indicator

These commands reflect "5.8. Indicator Settings".

Item	Command	Description	Default	Remark
Buzzer	B	Issue the good read beep		
	E	Issue the error beep		
Indicator	L	Signal the good read LED		

3. Interface Specifications

3.1. Serial Interface

3.1.1. Default Setting

Read the following menu labels to set the scan engine to default:

[ZZ]+[U2]+[ZZ] or send <ESC>U2<CR> followed by <ESC>Z2<CR>

3.1.2. Input/Output Signals

No	Signal			Control State	Minimum Pulse Width
	Name	Function	I/O		
1 ^(*)	DWNLDn	Download control signal	In	L: Download mode H: Normal state	2s
2	Vcc	Power input	In	3.3V±5%	
3	GND	System ground	-		
4	RxD	Received data signal	In	L: On H: Off	1/115200bps = 8.6µs
5	TxD	Transmitted data signal	Out	L: On H: Off	1/115200bps = 8.6µs
6	CTS	Communication control signal from host system	In	L: On H: Off	8.6×10 = 86µs
7	RTS	Communication control signal to host system	Out	L: On H: Off	8.6×10 = 86µs
8	POWERDWN	Shows Power Down state	Out	L: Normal state H: Power Down	
9	USB+		In/Out		12 Mbps (when communicating)
10	USB-		In/Out		12 Mbps (when communicating)
11	AIM/WUPn	In Power Down state: Recovery from Power Down state	In	L: Recover from Power Down H: No action	10ms
		Not in Power Down state: Aiming control	In	L: Aiming laser on H: Aiming laser off	10ms
12	TRIGn	Trigger on	In	L: Start operation H: No action	10ms
13	Vcc	Power input	In	3.3V±5%	
14	GND	System ground	-		
15	BUZZER	Activate external buzzer			PWM signals allow to control tones and sound pressure
16	GR LEDn	Good Read		L: LED on H: LED off	
17 ^(*)	EX_LEDn	External Illumination control signal	Out	L: External illumination on H: External illumination off	Control of an external illumination light source

*1 : It is used when software (firmware) is downloaded. Sampling is done right after power reset.

*2 : When using the external illumination control signal, the external illumination should be enabled (see "5.6.9. External Illumination").

3.1.3. Character Format

(same for both sending and receiving)

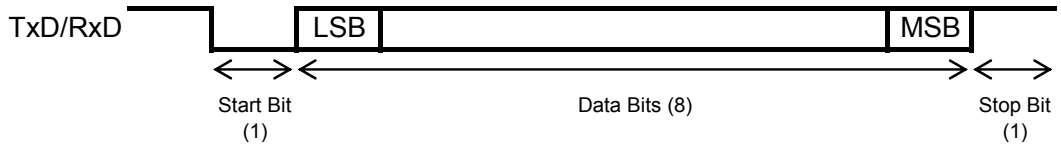

3.1.4. Communication Format

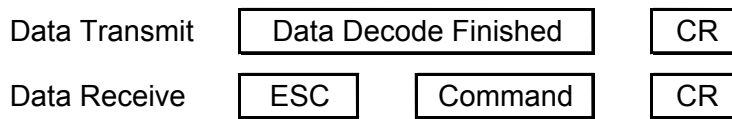

Note: CR of received data is configurable (See "5.4. String Options").

3.1.5. Handshaking

The communication control method can be set using menu labels / commands. Since there is a possibility to go out of control when the configuration is done by commands, the following items will not be reflected until they are written in the nonvolatile memory using Z2.

Item	Command	Description	Default	Remark
Handshaking	P0	No handshake	○	Enabled only with "Z2"
	P1	Busy/ready		Enabled only with "Z2"
	P2	Modem		Enabled only with "Z2"
ACK/NAK	P3	ACK/NAK		Enabled only with "Z2"
	P4	ACK/NAK NO RESPONSE		Enabled only with "Z2"

a) No Handshaking

The scan engine makes communication regardless of the state of the host system.

* In this setting, the commands from the host system may not be received correctly.

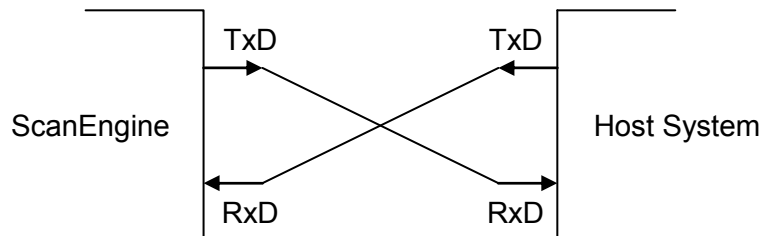

b) BUSY/READY

The scan engine and the host system notify each other if they are able to receive data (BUSY/READY) via their RTS line. When they are connected as shown in the figure below, the CTS line can be used to check if the other side is busy (off) or ready to receive data (on).

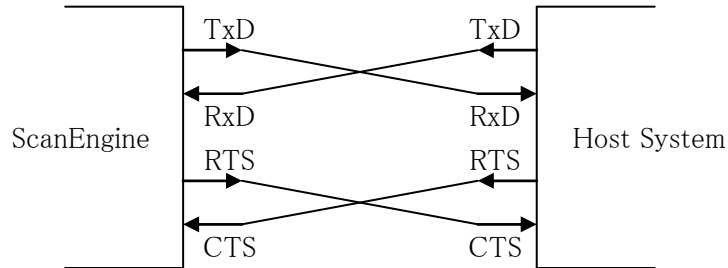

The scan engine's RTS is normally on (so ready to receive data) except during the processing of received data, while transmitting data, and while it is busy processing menu labels. When the scan engine wants to send data, it first has to check if its CTS line is on (to be sure that the host is ready to receive data) When the CTS line is off, the scan engine does not send the data but waits for a specific timeout period until the CTS line is turned on. When the CTS line is not turned on within the time specified, the data transmission will be aborted.

The following options are provided for the CTS line timeout setting using menu bar code / commands.

Item	Command	Description	Default	Remark
CTS time out	I0	Flow Control time out Indefinitely	○	Enabled only with "Z2"
	I1	Flow Control time out 100 ms		Enabled only with "Z2"
	I2	Flow Control time out 200 ms		Enabled only with "Z2"
	I3	Flow Control time out 400 ms		Enabled only with "Z2"

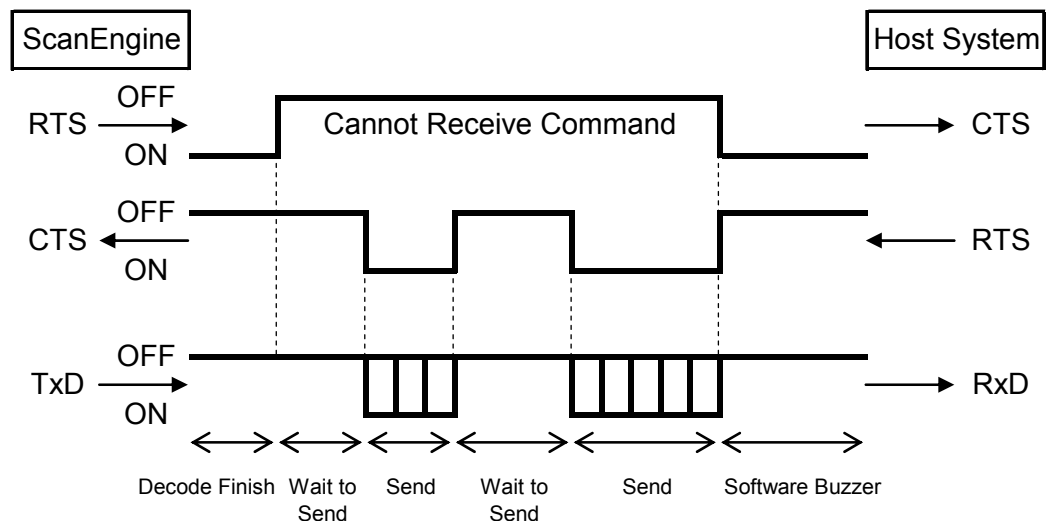

<CTS, TXD signal timing>

When the CTS line (RTS signal on the host side) is turned off during a TXD signal transmission, the scan engine transmits one or two characters and waits. When the CTS signal is turned on during a character transmission, the character will be transmitted.

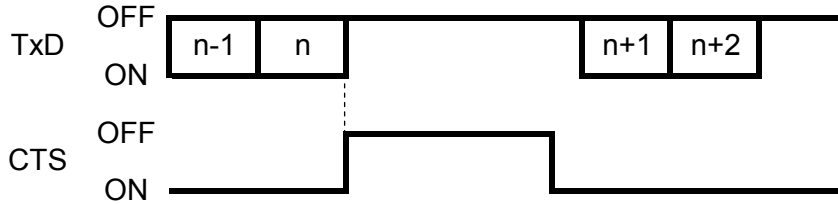

c) MODEM

The scan engine's RTS is OFF as soon as power is supplied to the scan engine. The scan engine will turn RTS ON when it wants to transmit data to the host. The host should respond by putting CTS ON when it is ready to receive data. While CTS is ON the scan engine is allowed to transmit data. When all data has been transmitted, the scan engine will turn RTS OFF. In response, the host should turn OFF the scan engine's CTS. If, while RTS is ON, the CTS line is not ON for a certain configurable period, the scan engine will terminate the transmission with an error indication of the buzzer.

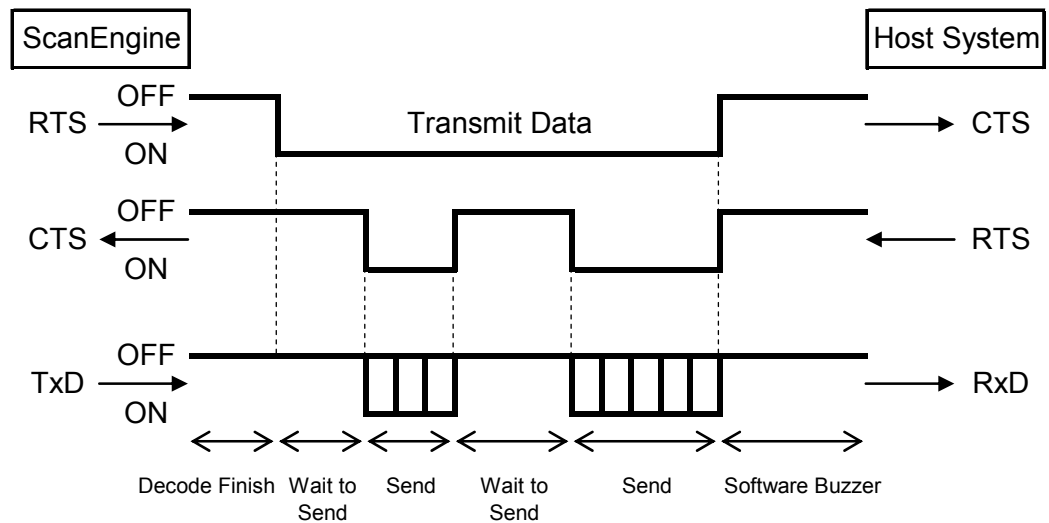

d) ACK/NAK

After data has been transmitted, the scan engine expects to receive one of the following responses from the host:

- ACK* response The scan engine completes transmission successfully and returns to the initial state.
- NAK* response The scan engine sends the data again and waits for the response from the host.
- DC1* response The scan engine returns to waiting for the trigger when it has a trigger (the initial state).
- None* response The scan engine returns to the initial state.

The following options are provided for the ACK/NAK timeout setting using menu bar code / commands.

Item	Command	Description	Default
ACK/NAK time out	XI4	ACK/NAK time out Indefinitely	○
	XI5	ACK/NAK time out 100 ms	
	XI6	ACK/NAK time out 500 ms	
	XI7	ACK/NAK time out 1000 ms	

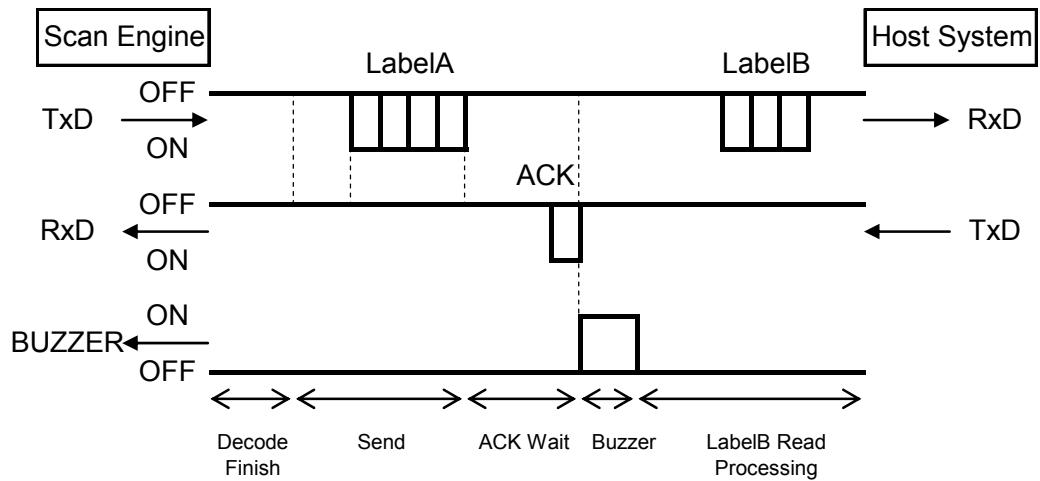

e) ACK/NAK NO RESPONSE

When no response from the host is received within 100ms, the scan engine assumes that the host properly received the data. The other actions are the same as ACK/NAK.

3.1.6. Communication Settings

Baud rate : 300 ~ 921600 bps
 Data length : 7/8 bits
 Parity bits : None, Even/Odd
 Stop bits : 1/2 bit

3.1.7. Interface Commands List

Item	Command	Description	Default	Remark
Baud rate	K1	300bps		Enabled only with "Z2"
	K2	600bps		Enabled only with "Z2"
	K3	1200bps		Enabled only with "Z2"
	K4	2400bps		Enabled only with "Z2"
	K5	4800bps		Enabled only with "Z2"
	K6	9600bps	○	Enabled only with "Z2"
	K7	19200bps		Enabled only with "Z2"
	K8	38400bps		Enabled only with "Z2"
	K9	57600bps		Enabled only with "Z2"
	SZ	115200bps		Enabled only with "Z2"
	D90	230400bps		Enabled only with "Z2"
	D91	460800bps		Enabled only with "Z2"
D92	921600bps		Enabled only with "Z2"	
Handshaking	P0	No handshaking	○	Enabled only with "Z2"
	P1	Busy/ready		Enabled only with "Z2"
	P2	Modem		Enabled only with "Z2"
ACK/NAK	P3	ACK/NAK		Enabled only with "Z2"
	P4	ACK/NAK no response		Enabled only with "Z2"
CTS time out	I0	Flow Control time out Indefinitely	○	Enabled only with "Z2"
	I1	Flow Control time out 100 ms		Enabled only with "Z2"
	I2	Flow Control time out 200 ms		Enabled only with "Z2"
	I3	Flow Control time out 400 ms		Enabled only with "Z2"
ACK/NAK time out	XI4	ACK/NAK time out Indefinitely	○	
	XI5	ACK/NAK time out 100 ms		
	XI6	ACK/NAK time out 500 ms		
	XI7	ACK/NAK time out 1000 ms		
Data bit	L0	7 data bits		Enabled only with "Z2"
	L1	8 data bits	○	Enabled only with "Z2"
Parity bit	L2	No parity	○	Enabled only with "Z2"
	L3	Even parity		Enabled only with "Z2"
	L4	Odd parity		Enabled only with "Z2"
Stop bit	L5	1 stop bit	○	Enabled only with "Z2"
	L6	2 stop bits		Enabled only with "Z2"
Intercharacter delay	KA	No delay	○	Enabled only with "Z2"
	KB	Delay 20 ms		Enabled only with "Z2"
	KC	Delay 50 ms		Enabled only with "Z2"
	KD	Delay 100 ms		Enabled only with "Z2"

4. Timing Characteristics

This chapter describes the following timings of the scan engine.

[4.1. Code Read Timing](#)

[4.2. Power On / Off Timing](#)

[4.3. Power Down Mode](#)

4.1. Code Read Timing

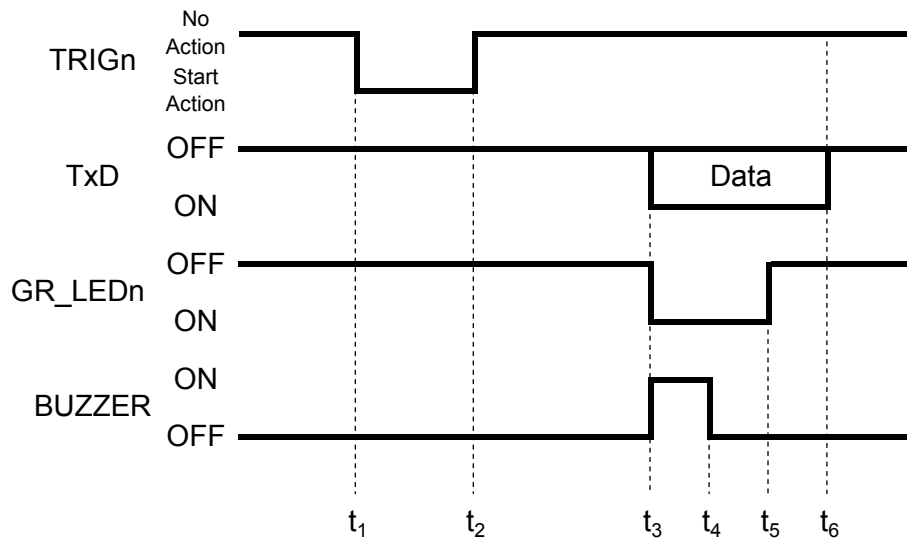

	Description	Min	Typ	Max	Unit
$t_2 - t_1$	TRIGn signal duration	50	-	-	ms
$t_6 - t_1$	Read time	-	-	2 (*1)	s
$t_4 - t_3$	External buzzer duration	-	50 (*2)	-	ms
$t_5 - t_3$	GR_LED duration	-	200 (*3)	-	ms

*1: Read time is configurable (see [5.5.7.](#))

*2: External buzzer duration is configurable (see [5.8.1.](#))

*3: GR_LED duration is configurable (see [5.8.3.](#))

4.2. Power On / Off Timing

4.2.1. Power-On

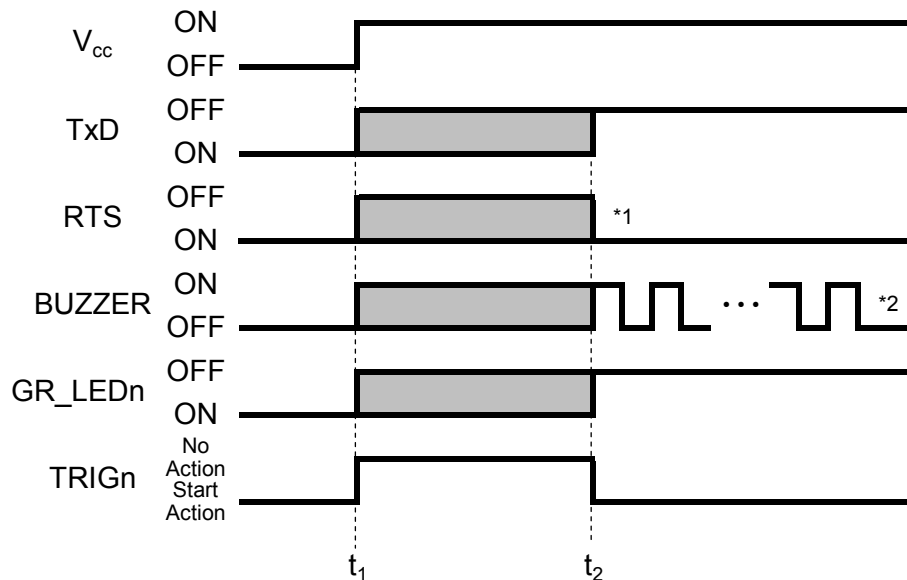

	Description	Min	Typ	Max	Unit
$t_2 - t_1$	Time taken to be accessible after supplying the power	-	1880	2000	ms

*1: The signal level will be "High: not ready to receive" when the communication control is set to "MODEM".

*2: The signal level will be "Low" when the software buzzer is set to disabled.

4.2.2. Power-Off

When the power is turned off while an input signal of the scan engine is High, leakage current will be drawn from that signal. Therefore, all input signals of the scan engine should be set to "High impedance" or "Low".

Note: Power off at the time of saving configurations

The settings are stored in the scan engine when

1) The Z2 command is sent to save the parameters. .

2) The configuration is made by reading menu bar codes and/or 2D codes.

At this time, the settings are written in the flash ROM and that takes 300ms to 10s to complete. Make sure the power is not turned off during this period - otherwise the settings may be destroyed.

* For 1), if the option "ACK/NAK for serial command" is enabled (see [2.4.5](#)) in advance, the scan engine will send an ACK when writing the configuration data is done. This allows you to get the timing right.

4.3. Power Down Mode

4.3.1. Transition from Power On to Power Down Mode

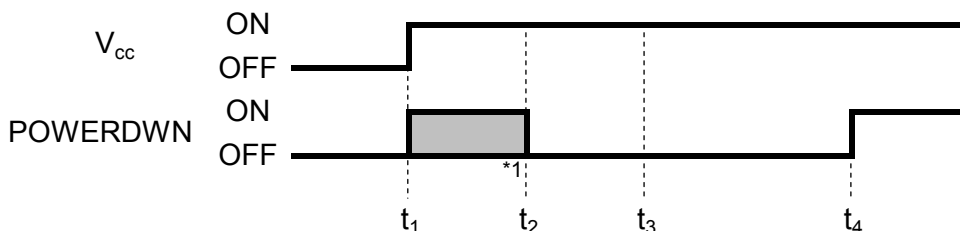

	Description	Min	Typ	Max	Unit
$t_2 - t_1$	(Initial process)	-	1200	-	ms
$t_3 - t_1$	Time needed for a transition from power-on to power down mode	-	2600	-	ms
$t_4 - t_3$		-	As configured	-	ms

*1: Although POWERDWN signal is active between t_1 and t_2 , it is after t_4 . that actually enters into the electric power saving mode.

4.3.2. Transition from Standby Mode to Power Down Mode

When scanning succeeds in the “Single Read” setting

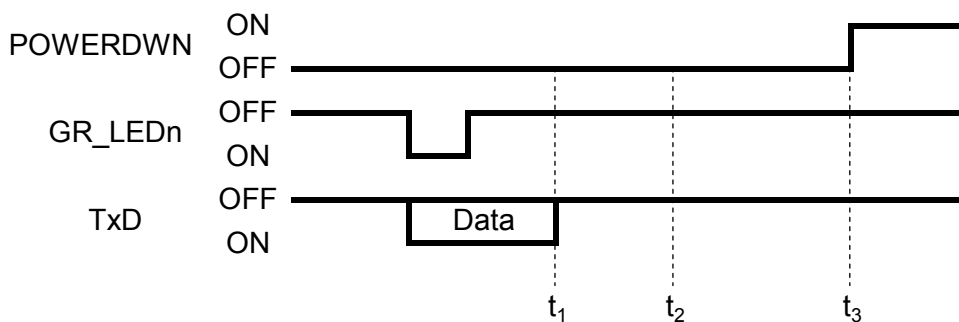

	Description	Min	Typ	Max	Unit
$t_2 - t_1$	Time needed for a transition from standby mode to power-down mode	-	250	-	ms
$t_3 - t_2$		-	As configured	-	

Standby state means Idle state in which no operation performs such as signal input /output, data transmission or illumination LED/aiming emission. In the above figure, the last operation was ‘data transmission’, so the time to complete the data transmission is defined as t_1 .

The following options are provided to set the transition time to power down mode using menu bar code / commands.

Item	Command	Description	Default
Power saving	XSC	Disable power saving	○
	E64	Power saving 0 second	
	XSH	Power saving 1 seconds	
	EB0	Power saving 2 seconds	
	EB1	Power saving 5 seconds	
	EB2	Power saving 10 seconds	
	E9E	Power saving 15 seconds	
	XSD	Power saving 30 seconds	
	XSE	Power saving 10 minutes	
	XSF	Power saving 30 minutes	
	XSG	Power saving 60 minutes	

4.3.3. Recovery from Power Down Mode

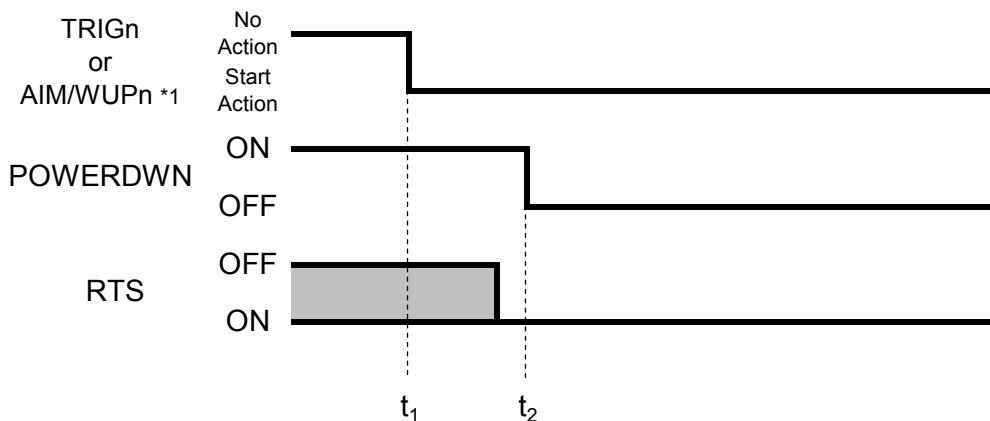

	Description	Min	Typ	Max	Unit
$t_2 - t_1$	Time to recover	-	150	300	μ s

1: In the "No handshaking" setting (see [3.1.7.](#)), it is possible to recover from Power Down mode by CTS signal.

5. Module Settings

The options in this chapter allow you to configure the required bar code types, code options, and read modes. The settings do not affect the reading of the menu labels.

It is strongly recommended to select only the required codes and options. Advantages of selecting only the required codes and options are:

- Faster reading
- No accidental scanning of unwanted barcode
- Reduced probability of reading errors

In this chapter, the following options are included:

[5.1. Setting of Readable Codes](#)

[5.2. Setting of Number of Characters](#)

[5.3. Setting Code Specific Options](#)

[5.4. String Options](#)

[5.5. Read Mode Settings \(Basic Settings\)](#)

[5.6. Read Mode Settings \(Imager Settings\)](#)

[5.7. Indicator Settings](#)

5.1. Setting of Readable Codes

The following tables show the supported symbologies and the setting command IDs.

- Single : Only the specified symbology will be enabled and all other symbologies will be disabled.
- Multiple : The specified symbology will be enabled on top of the already enabled symbologies.
- Disable : The specified symbology will be disabled, but all other configured symbologies stay enabled.

5.1.1. 1D Codes

Symbologies	Single	Multiple	Disable	Default	Notes
UPC UPC Add-on 2 UPC Add-on 5	J1 J2 J3	R1 R2 R3	X4B X4C X4D	○	
EAN EAN Add-on 2 EAN Add-on 5	J4 J5 J6	R4 R5 R6	X4E X4F X4G	○	EAN/JAN
EAN-13 EAN-13 Add-on 2 EAN-13 Add-on 5	JG JH JI	JU JV JW	—	○	
EAN-8 EAN-8 Add-on 2 EAN-8 Add-on 5	JA JB JC	JO JP JQ	—	○	
Code 39	A2	B2	VB	○	
Tri-Optic	JD	JZ	-	○	
Codabar	A3	B3	VC	○	
Industrial 2 of 5	J7	R7	X4K	○	
Interleaved 2 of 5	J8	R8	X4L	○	
S-Code	RA	R9	-	○	
Matrix 2 of 5	AB	BB	-		
Chinese Post Matrix 2 of 5	JE	JS	JT		
Korean Postal Authority	JL	WH	WI		
Intelligent Mail Bar Code	D5H	D5F	D5G		
POSTNET	D6C	D6A	D6B		
JPN (Customer Bar Code)	D5R	D5P	D5Q		
IATA	A4	B4	VH	○	
MSI/Plessey	A7	B7	VF	○	
Telepen	A9	B9	VG	○	
UK/Plessey	A1	B1	VA	○	
Code 128	A6	B6	VE	○	
Code 93	A5	B5	VD	○	
Code 11	BLB	BLC	BLA		

Symbologies	Single	Multiple	Disable	Default	Notes
GS1 DataBar Omnidirectional GS1 DataBar Truncated GS1 DataBar Stacked GS1 DataBar Stacked Omnidirectional	J9	JX	SJ	○	
		BC6	BCI	BCU	
GS1 DataBar Limited	JJ	JY	SK	○	
GS1 DataBar Expanded GS1 DataBar Expanded Stacked	JK	DR	SL	○	

5.1.2. 2D Codes

Symbologies	Single	Multiple	Disable	Default	Notes
Codablock F	D4R	D4P	D4Q		
Data Matrix (ECC 000-140)	BG2	BG0	BG1		
Data Matrix (ECC 200)	BC0	BCC	BCO	○	
Aztec Code	BC5	BCH	BCT	○	
Aztec Runes	BF4	BF2	BF3		
Chinese-sensible code	D4K	D4L	D4M		
QR Code	BC1	BCD	BCP	○	
Micro QR	D38	D2U	D2V	○	
Maxi Code	BC2	BCE	BCQ	○	
PDF417	BC3	BCF	BCR	○	
Micro PDF417	BC4	BCG	BCS	○	

5.1.3. Other Options

Symbologies	Single	Multiple	Disable	Default	Notes
All codes (1D, 2D)	A0		B0		Excluding add-on
All 1D codes	BCA	BCM	BCY		Including add-on
All 2D codes	BCB	BCN	BCZ		*1)*2)

*1: PDF417, QR Code, Datamatrix (ECC 200), MaxiCode, MicroPDF417, Aztec Code, EAN.UCC Composite bar code, Aztec Runes, DataMatrix (ECC 000-140), and MicroQR.

*2: The settings such as extra link flags are needed for GS1 Composite bar code. These settings are not influenced by all 2D codes.

5.2. Setting of Number of Characters

If you are going to read bar codes of known length, it is recommended to set the scan engine for a fixed number of characters. The scan engine uses this to verify that labels read are of the correct length and reject labels that do not have the specified length. The advantage of setting a fixed length is that it provides protection against short scans of labels, such as Interleaved 2of5, which do not provide sufficient security against partial scan. The length checking is done on the label data and is not affected by options such as (not) transmit start/stop character or check digit. Setting the number of characters does not affect fixed length codes, such as EAN-13. By sending "Z3" command (see [6.6.1.](#)), the setting status of minimum and maximum lengths can be confirmed.

The following options are available:

5.2.1. Fixed Length OFF All Codes

This option cancels the fixed length checking.

5.2.2. Fixed Length ON All Codes

This option enables the fixed length checking. The fixed length is programmed which will affect all variable length codes.

Configuring with menu bar codes

- 1) Scan ZZ menu label
- 2) Scan H1 menu label (Fixed length on for all codes)
- 3) Scan a bar code with the required length
- 4) Scan a 2nd bar code with the required length (up to two types of lengths)
- 5) Scan the ZZ menu label.

Configuring with commands

Input method:

- | | |
|-----------------------|--------------------|
| 1 or 2 decimal digits | : <Esc>H1△△<CR> |
| 3 decimal digits | : <Esc>H1[△△△<CR> |
| 4 decimal digits | : <Esc>H1]△△△△<CR> |
- Up to 8000 digits are configurable.

Example:

- | | |
|----------------------------|------------------------|
| Set to 5 digits | : <Esc>H105<CR> |
| Set to 10 digits | : <Esc>H110<CR> |
| Set to 300 digits | : <Esc>H1]300<CR> |
| Set to 20 and 512 digits | : <Esc>H120]512<CR> |
| Set to 200 and 5000 digits | : <Esc>H1]200]5000<CR> |

5.2.3. Fixed Length ON, Minimum / Maximum Length for Selected Codes

This option enables fixed length and minimum / maximum length checking for different bar code types and will only affects the specified bar code types.

Configuring with menu bar codes

- 1) Scan ZZ menu label
- 2) Scan HK, HL, or HM menu label (Fixed length on, Minimum/Maximum length for selected codes. See [5.2.4.](#))
- 3) Scan a bar code with the required length
- 4) Scan a 2nd bar code with the required length (fixed length only)
- 5) Scan the ZZ menu label.

Configuring with commands

<Esc>[XYZQaQbQcQd<CR>

XYZ (see [5.2.5.](#)) : Input command ID for each code
abcd : Up to 8000 decimal

Example of fixed length:

Fix Code39 length to 6 digits : <Esc>[DC1Q0Q0Q0Q6<CR>
Fix Interleaved 2of5 to 12 digits : <Esc>[DC4Q0Q0Q1Q2<CR>

Example of minimum length:

Set mini length for Code39 to 2 digits : <Esc>[DB1Q0Q0Q0Q2<CR>
Set mini length for Interleaved 2of5 to 4 digits : <Esc>[DB4Q0Q0Q0Q4<CR>

Example of maximum length:

Set max length for Code39 to 12 digits : <Esc>[DA1Q0Q0Q1Q2<CR>
Set max length for Interleaved 2of5 to 14 digits : <Esc>[DA4Q0Q0Q1Q4<CR>

Note:

- With 'HK' menu label (Fixed length on for selected codes), fixed lengths for up to two types of codes are configurable.
- If you want to configure the fixed length for more than two types of codes with the HK menu label, repeat the same procedure with the required codes.
- With "HL / HM" menu labels (Minimum / Maximum length for selected codes), only one length is configurable.
- There is the following order of priorities: Fixed length ON for selected codes, Fixed length ON all codes, Minimum / Maximum length for selected codes. When trying to set a lower priority setting after a higher priority setting was once made, the prior setting should be cleared to enable the lower priority setting.
- If a label is checked for fixed length, it will not be checked for minimum or maximum length.
- The maximum number of characters is 8000.
- When only digit is omitted from 4 numerical values of QaQbQcQd, the change will be invalid and the default value will be set.

5.2.4. Command List: Setting of Number of Characters

Item	Command	Description	Default	Remark
Setting of number of characters	H0	Fixed length OFF all codes	○	
	H1	Fixed length ON all codes		
	HK	Fixed length ON for selected codes		Menu only
	HL	Minimum length for selected codes		Menu only
	HM	Maximum length for selected codes		Menu only

5.2.5. Command List: Fixed Length ON / Minimum / Maximum Length for Selected Codes

Code type	Fixed length	Mini length	Max length
Reset settings	DC0	XQG	XNG
Code-39	DC1	DB1	DA1
Codabar	DC2	DB2	DA2
Industrial 2of5	DC3	DB3	DA3
Interleaved 2of5	DC4	DB4	DA4
Code-93	DCD	DBD	DAD
Code-128	DCB	DBB	DAB
MSI/Plessey	DC8	DB8	DA8
IATA	DC7	DB7	DA7
PDF417	DCL	DBL	DAL
QR code	DCJ	DBJ	DAJ
DataMatrix	DCH	DBH	DAH
Maxi code	DCK	DBK	DAK
Aztec code	DCI	DBI	DAI
microPDF417	DCM	DBM	DAM
RSS-Expanded(GS1 Databar)	DCF	DBF	DAF
Composite	DCG	DBG	DAG
EAN-128(GS1-128)	DCC	DBC	DAC
S-code	DC5	DB5	DA5
UK/Plessey	DCA	DBA	DAA
Matrix 2of5/Chinese Post	DC6	DB6	DA6
Telepen	DC9	DB9	DA9
Codablock-F	DCO	DBO	DAO
Code-11	DCE	DBE	DAE
Chinese Sensible Code	DCN	DBN	DAN

5.3. Setting Code Specific Options

5.3.1. Code Options

(1) Specifying Output Format

Select output format for each code.

- Start/Stop code (ST/SP)
- Transmit Start/Stop digits
- Transmit character for Start/Stop code
- Transmit check digits
- Full ASCII conversion
- GS1-128 data output (See EAN-128 specifications for details)

(2) Check Digits Calculation

Specify whether the check digit calculation is enabled or disabled.

5.3.2. Options for Specific Code Setting

Code	Item	Command	Description	Default
UPC-A	UPC-A Leading zero CD transmission	E3	UPC-A, No leading zero, transmit CD	○
		E5	UPC-A, No leading zero, not transmit CD	
		E2	UPC-A, Leading zero, transmit CD	
		E4	UPC-A, Leading zero, not transmit CD	
UPC-E	UPC-E Leading zero CD transmission	E7	UPC-E , No leading zero, transmit CD	○
		E9	UPC-E , No leading zero, not transmit CD	
		E6	UPC-E , Leading zero, transmit CD	
		E8	UPC-E , Leading zero, not transmit CD	
	UPC-A, E conversion	6Q	Transmit UPC-E	○
		6P	Transmit as UPC-A	
UPC-E1 conversion	KP	Disable UPC-E1	○	
	KQ	Enable UPC-E1		
EAN-13 and EAN-8	CD transmission	6J	Not transmit EAN-13 CD	
		6K	Transmit EAN-13 CD	○
	CD transmission	6H	Not transmit EAN-8 CD	
		6I	Transmit EAN-8 CD	○
	ISBN conversion	IB	Disable ISBN conversion	○
		IA	Enable ISBN conversion	
		IK	Enable ISBN if possible	
	ISSN conversion	HN	Disable ISSN conversion	○
		HO	Enable ISSN conversion	
		4V	Enable ISSN if possible	
	ISMN conversion	IO	Disable ISMN conversion	○
		IP	Enable ISMN conversion	
		IQ	Enable ISMN if possible	
	EAN13 forced add-on 1	-G	Enable EAN forced add-on when EAN13 starts with 378/ 379 / 529	
		-H	Disable EAN forced add-on when EAN13 starts with 378/ 379 / 529	○
	EAN13 forced add-on 2	-C	Enable EAN forced add-on when EAN13 starts with 434 / 439 / 414 / 419 / 977 / 978	
-D		Disable EAN forced add-on when EAN13 starts with 434 / 439 / 414 / 419 / 977 / 978	○	
Code 39 and It.Pharm.	Full ASCII conversion	D5	Normal Code 39	○
		D4	Full ASCII Code 39	
		+K	Full ASCII Code 39 if possible	
	It. Pharmaceutica conversion	D6	It. Pharmaceutica only	D5
		D7	It. Pharmaceutical if possible	D5
	CD check	C1	Not check CD	○
		C0	Check CD	
	CD transmission	D8	Not transmit CD	
		D9	Transmit CD	○
	ST/SP transmission	D1	Not transmit ST/SP	○
		D0	Transmit ST/SP	
	Leading A transmission	DA	Not transmit leading A for It. Pharm	○
		DB	Transmit leading A for It. Pharm	
	Minimum digit	8D	Minimum data: three characters	
		8E	Minimum data: one character	○
	Concatenation	+M	Disable concatenation	○
+L		Enable concatenation		

Code	Item	Command	Description	Default
Codabar	ABC, CX conversion	HA	Enable only Codabar normal mode	○
		H4	Enable only ABC code	
		H5	Enable only CX code	
		H3	Enable codabar / ABC and CX	
	CD check	H7	Not check CD	○
		H6	Check CD	
	CD transmission	H9	Not transmit CD	
		H8	Transmit CD	○
	Space insertion	HE	Disable space insertion	○
		HD	Enable space insertion	
	ST/SP transmission	F0	Not transmit ST/SP	○
		F3	ST/SP: ABCD/ABCD	
		F4	ST/SP: abcd/abcd	
		F1	ST/SP: ABCD/TN*E	
		F2	ST/SP: abcd/tn*e	
		HJ	ST/SP: <DC1><DC2><DC3><DC4> /<DC1><DC2><DC3><DC4>	
	Minimum digit	HC	Minimum data: one character	
		HB	Minimum data: three characters	
HF		Minimum data: five characters	○	
Intercharacter gap check	HI	Disable intercharacter gap check		
	HH	Enable intercharacter gap check	○	
2 of 5 and S-code	CD transmission	E1	Not transmit CD	
		E0	Transmit CD	○
	CD check	G0	Not check CD	○
		G1	Check CD	
	Minimum digit	GE	Minimum data: one character	
		GF	Minimum data: three characters	
		GI	Minimum data: five characters	○
	Space check	GK	Disable space check for Industrial 2of5	
GJ		Enable space check for Industrial 2of5	○	
S-Code conversion	GH	Not transmit S-Code as Interleaved 2of5	○	
	GG	Transmit S-Code as Interleaved 2of5		
IATA	CD check	4H	Not check CD	○
		4I	Check FC / SN only	
		4J	Check FC / CPN / SN	
		4K	Check FC / CPN / AC / SN	
	CD transmission	4M	Not transmit CD	
		4L	Transmit CD	○
MSI/ Plessey	CD check	4A	Not check CD	
		4B	Check 1 CD = MOD 10	○
		4C	Check 2 CD = MOD 10/MOD 10	
		4D	Check 2 CD = MOD 10/MOD 11	a
		4R	Check 2 CD = MOD 11/MOD 10	
		4S	Check 2 CD = MOD 11/MOD 11	
	CD transmission	4G	Not transmit CD	
		4E	Transmit CD 1	○
4F	Transmit CD 1 and CD 2			

Code	Item	Command	Description	Default
Telepen	Conversion output mode	D2	Numeric mode	○
		D3	ASCII mode	
UK/ Plessey	CD transmission	4O	Not transmit CD	
		4N	Transmit CD	○
	Space insertion	DO	Disable space insertion	○
		DN	Enable space insertion	
	X conversion	DP	Conversion A -> X disable	○
		DQ	Conversion A -> X enable	
Code 128 and GS1-128 (EAN-128)	EAN128 conversion	OF	Disable GS1-128	○
		JF	Enable GS1-128 only	
		OG	Enable EAN-128 if possible	
	Concatenation	MP	Disable concatenation (FNC2 message append)	○
		MO	Enable concatenation (FNC2 message append)	
	Code 93	CD transmission	DZ	Not transmit CD
DY			CD transmit	
Code 11	CD check	BLF	Not check CD	
		BLG	Check 1CD	
		BLH	Check 2CD	
		BLI	Check auto 1 or 2 CD	○
	CD transmission	BLJ	Not transmit CD	○
		BLK	CD transmit	
Korean Postal Authority code	CD transmission	*+	CD transmit	
		*-	Not transmit CD	○
	Transmit dash	*.	Transmit dash	○
		*/	Not transmit dash	
	Upside down reading	*9	Upside down reading enabled	
		*8	Upside down reading disabled	○
GS1- DataBar	CD transmission	DM	Not transmit CD	
		DL	CD transmit	○
	AI transmission	DT	Not transmit Application Identifier	
		DS	Transmit Application Identifier	○

*1: For UCC/EAN-128, various options other than those listed above are prepared. Refer to "Users Menu Book for UCC/EAN-128" for details.

5.3.3. Options for Composite Codes Setting

Code	Item	Command	Description	Default
Composite	Link flag	RQ	Not ignore link flag for RSS / EAN-128 and EAN/UPC	○
		RP	Ignore link flag for RSS / EAN-128 and EAN/UPC	
	RSS / EAN-128 composite	BHF	Disable RSS / EAN-128 composite	○
		BHE	Enable RSS / EAN-128 composite	
	EAN/UPC composite	D1V	Enable EAN / UPC composite	
		D1W	Disable EAN / UPC composite	○
	Composite component	BL0	Enable 1 D composite only	
		BL1	Enable 2 D composite only	
BL2		Enable 1 D and 2 D composites	○	

5.3.4. Outputs for Composite Code Setting

Composite Setting			Output		
Enable/Disable	Link Flag	Composite Component	1D+2D	1D	2D
Enable (BHE) (D1V)	Not ignore (RQ)	—	○	×	×
	Ignore (RP)	1 D composite only (BL0)	○	△	×
		2 D composite only (BL1)	○	×	△
		1 D and 2 D composite (BL2)	○	△	△
Disable (BHF) (D1W)	—	1 D composite only (BL0)	×	○	×
		2 D composite only (BL1)	×	×	○
		1 D and 2 D composite (BL2)	×	○	○

- : Priority output
- △ : Output when the data cannot be output with ○.
- × : Not output

5.4. String Options

1) Case Conversion

The bar code data may be converted to either lower or upper case or the case may be exchanged. These options may be used if the host requires upper case characters only. See “5.4.1. Case conversion”.

Example of case conversion:

Test String	AbCd	Default
No case conversion	AbCd	○
Convert to upper case	ABCD	
Convert to lower case	abcd	
Exchange case	aBcD	

2) Output Format

The following additional characters can be included in each code data to be scanned.

(1) Preamble / Postamble (up to 8 digits):

Specified strings can be added in front and at the end of the data for all codes. By default, they are empty.

(2) Prefix / suffix (up to 4 digits):

Specified strings can be added in front and at the end of the data for a specific symbology. By default, the prefix is empty and the suffix is a CR character.

(3) Code identification / Code length:

'Code identification' and Code length' can be included in a prefix and/or a suffix. The code length will be the number of characters that is configured with options in “5.3.1. Code Option”. The code identification and the code length can be put at any position in the prefix/suffix string.

Output Format

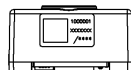

Note: ‘CR’ is attached as a suffix for each code by default.

3) How to set prefix / suffix

Configuring with Menu Bar Code:

- (1) Scan the SET menu label.
- (2) Scan the "[5.4.2](#). Set Prefix / Suffix " menu label for the symbology for which you want to set the prefix or suffix.
- (3) Scan one or more menu labels for "[5.4.3](#). Prefix / Suffix Value"
- (4) Scan the END menu label.

Example: To set "C39:" as the prefix and "CR" and "LF" as the suffix for Code 39.

1. Scan "ZZ" to start.
2. Scan "M4" to set Code 39 prefix.
3. Scan "0C" to set C.
4. Scan "Q3" to set 3.
5. Scan "Q9" to set 9.
6. Scan "6A" to set :.
7. Scan "O4" to set Code 39 suffix.
8. Scan "1M" to set CR.
9. Scan "1J" to set LF.
10. Scan "ZZ" to end.

Configuring with Command:

```
<Esc>aa11223344bb11223344<CR>
```

Where:

- # aa the code for the symbology for which you want to configure the prefix (See [5.4.2](#)).
- # bb the code for the symbology for which you want to configure the suffix (See [5.4.2](#)).
- # 11 the first prefix/suffix value (See [5.4.3](#)).
- # 22 the 2nd prefix/suffix value etc. (See [5.4.3](#)).

Example: To set a prefix "C39" and remove previously configured suffixes (default "CR") for Code 39.

```
<Esc>M40CQ3Q96AO41M1J<CR>
```

Note:

1. The prefix and suffix setting commands clear the current values and configure new ones. The default suffix CR is also cleared.
2. If you want to clear the default suffix CR, it is possible by scanning RZ menu label (Set suffix for all codes) only or PR menu label (Clear suffix).
3. When the number of prefix / suffix characters exceeds the maximum limit (4 digits), the configuration will be ignored, so unnecessary characters should be deleted then.

4) Code identification / length settings

The procedure is the same as that for configuring prefix and suffix settings. The “Direct input code id/length” menu labels should be read instead of menu labels for the “Direct input characters” (see [5.4.4.](#)).

(1) Code identification Opticon (see [5.4.5.](#))

The direct input ‘code identifier’ provides a quick method of programming in addition to programming a separate prefix or suffix for each bar code type.

Code identification AIM/ISO (see [5.4.6.](#))

The code identifier is transmitted to ISO 15424 format.]cm

-] is ASCII value, decimal 93
- c is code character
- M is modifier character

(2) Code length

The code length is transmitted as 2 digits, excluding prefix and suffix characters. For 2D codes the code length is transmitted as 6 digits. It is also possible to send the length as 6 digits for both 1D and 2D codes. These direct input characters count as 1 entry of the 4 permissible entries for a prefix and suffix.

Example: To set the prefix <code identifier>:<code length>:.

Configuring with Menu Bar Code:

1. Scan “ZZ” to start.
2. Scan “RY” to set Prefix All Codes.
3. Scan “\$2” to set Code identification using OPTICON ID.
4. Scan “6A” to set :.
5. Scan “\$3” to set Code length (1D/2D : 2/6 digits).
6. Scan “6A” to set :.
7. Scan “ZZ” to end.

Configuring with Command:

<Esc>RY\$26A\$36A<CR>

5.4.1. Case Conversion

Item	Command	Description	Default
Case conversion	YZ	No case conversion	o
	YW	Convert to upper case	
	YX	Convert to lower case	
	YY	Exchange case	

5.4.2. Set Prefix / Suffix

Code	Prefix Command	Suffix Command
All code	RY	RZ
UPC-A	N1	N6
UPC-A add-on	M0	O0
UPC-E	N2	N7
UPC-E add-on	M1	O1
EAN-13	N3	N8
EAN-13 add-on	M2	O2
EAN-8	N4	N9
EAN-8 add-on	M3	O3
Code 39	M4	O4
Tri-optic	MC	PN
Codabar	M5	O5
Industrial 2 of 5	M6	O6
Interleaved 2 of 5	M7	O7
S-code	MB	OB
Matrix 2 of 5	GL	GM
IATA	I8	I9
MSI/Plessey	N0	N5
Telepen	L8	L9
UK/Plessey	MA	OA
Code 128	M9	O9
GS1-128	XMx	XOX
Code 11	BLD	BLE
Intelligent Mail Bar Code	D5I	D5J
POSTNET	D6D	D6E
GS1 DataBar	OE	PQ
Composite code	RR	RS
Codablock-F	D4S	D4T
Data Matrix	MD	PO
Aztec	BF0	BF1
Chinese Sensible Code	D4N	D4O
QR Code	MK	PW
Maxicode	ML	PX
PDF417	OC	PY
MicroPDF417	OD	PZ
Clear prefix / suffix	MG	PR
Preamble / Postamble	MZ	PS

5.4.3. Prefix / Suffix Values

ASCII	Command	ASCII	Command	ASCII	Command	ASCII	Command
<SPACE>	5A	A	0A	a	\$A	^@ (NULL)	9G
!	5B	B	0B	b	\$B	^A (SOH)	1A
"	5C	C	0C	c	\$C	^B (STX)	1B
#	5D	D	0D	d	\$D	^C (ETX)	1C
\$	5E	E	0E	e	\$E	^D (EOT)	1D
%	5F	F	0F	f	\$F	^E (ENQ)	1E
&	5G	G	0G	g	\$G	^F (ACK)	1F
'	5H	H	0H	h	\$H	^G (BEL)	1G
(5I	I	0I	i	\$I	^H (BS)	1H
)	5J	J	0J	j	\$J	^I (HT)	1I
*	5K	K	0K	k	\$K	^J (LF)	1J
+	5L	L	0L	l	\$L	^K (VT)	1K
,	5M	M	0M	m	\$M	^L (FF)	1L
-	5N	N	0N	n	\$N	^M (CR)	1M
.	5O	O	0O	o	\$O	^N (SO)	1N
/	5P	P	0P	p	\$P	^O (SI)	1O
:	6A	Q	0Q	q	\$Q	^P (DLE)	1P
;	6B	R	0R	r	\$R	^Q (DC1)	1Q
<	6C	S	0S	s	\$S	^R (DC2)	1R
=	6D	T	0T	t	\$T	^S (DC3)	1S
>	6E	U	0U	u	\$U	^T (DC4)	1T
?	6F	V	0V	v	\$V	^U (NAK)	1U
@	6G	W	0W	w	\$W	^V (SYN)	1V
[7A	X	0X	x	\$X	^W (ETB)	1W
\	7B	Y	0Y	y	\$Y	^X (CAN)	1X
]	7C	Z	0Z	z	\$Z	^Y (EM)	1Y
^	7D	0	Q0			^Z (SUB)	1Z
_	7E	1	Q1			^[(ESC)	9A
`	7F	2	Q2			^\ (FS)	9B
{	9T	3	Q3			^] (GS)	9C
	9U	4	Q4			^^ (RS)	9D
}	9V	5	Q5			^_ (US)	9E
~	9W	6	Q6			DEL (ASCII127)	9F
		7	Q7				
		8	Q8				
		9	Q9				

5.4.4. Set Code ID and Code Length

Item	Command	Description	Default
Code identification	\$2	Code identification using OPTICON ID	
	\$1	Code identification using AIM ID	
Code length	\$3	Code length (1D/2D : 2/6 digit)	
	\$6	Code length (1D/2D : 6/6 digit)	

5.4.5. OPTICON Code ID Prefix / Suffix Values

Code	Code ID	Code	Code ID
UPC-A	C	MSI/Plessey	Z
UPC-A +2	F	Telepen	d
UPC-A +5	G	UK/Plessey	a
UPC-E	D	Code 128	T
UPC-E +2	H	GS1-128	
UPC-E +5	I	Code 93	U
EAN-13	B	Code 11	b
EAN-13 +2	L	Korean Postal Authority	c
EAN-13 +5	M	Intelligent Mail Bar Code	0
EAN-8	A	POSTNET	3
EAN-8 +2	J	GS1 Databar	y
EAN-8 +5	K	CC-A	m
Code 39	V	CC-B	n
Code 39 Full ASCII	W	CC-C	l
Italian Pharmaceutical	Y	Codablock F	E
Codabar	R	DataMatrix	t
Codabar ABC	S	Aztec	o
Codabar CX	f	Aztec Runes	
Industrial 2of5	O	Chinese Sensible Code	e
Interleaved 2of5	N	QR Code	u
S-Code	g	Micro QR Code	j
Matrix 2of5	Q	Maxi Code	v
Chinese Post	w	PDF417	r
IATA	P	Micro PDF417	s

5.4.6. AIM/ISO15424 Code ID Prefix / Suffix Values

AIM/ISO15424 Code ID			
Code	JAIM-ID	Code	JAIM-ID
UPC-A]E0	Telepen]B*
UPC-A +2]E3	UK/Plessey]X0
UPC-A +5]E3	Code 128]C0
UPC-E]E0	GS1-128]C1
UPC-E +2]E3	Code 93]G0
UPC-E +5]E3	Code 11]H*
EAN-13]E0]X0
EAN-13 +2]E3	Korean Postal Authority]X0
EAN-13 +5]E3	Intelligent Mail Bar Code]X0
EAN-8]E4	POSTNET]X0
EAN-8 +2]E7	GS1 Databar]e0
EAN-8 +5]E7	CC-A]e1
Code 39]A*	CC-B]e1
Code 39 Full ASCII]A*	CC-C]e1
Tri-Optic]X0	GS1 Databar with CC-A]e0
Code 39 It. Pharmaceutical]X0	GS1 Databar with CC-B]e0
Codabar]F*	GS1 Databar with CC-C]e0
Codabar ABC]F*	Codablock F]0*
Codabar CX]X0	DataMatrix]d*
Industrial 2of5]S0	Aztec]z*
Interleaved 2of5]I*]X0
S-Code]X0	QR Code]Q*
Matrix 2of5]X0	Micro QR Code]Q*
Chinese Post]X0	Maxi Code]U*
IATA]R*	PDF417]L0
MSI/Plessey]M*	Micro PDF417]L0
]X0		

5.4.7. Code Options AIM/ISO15424 Code ID Prefix / Suffix Values

Code option	JAIM-ID	Code option	JAIM-ID
Code 39 option AIM/ISO15424 Code ID : A*			
Normal Code 39 (D5) Not check CD (C1) Transmit CD (D9)]A0	Full ASCII Code 39 (D4) or Full ASCII Code 39 if pos. (+K) Not check CD (C1) Transmit CD (D9)]A4
Normal Code 39 (D5) Check CD (C0) Transmit CD (D9)]A1	Full ASCII Code 39(D4) or Full ASCII Code 39 if pos. (+K) Check CD (C0) Transmit CD (D9)]A5
Normal Code 39 (D5) Not check CD (C1) Not transmit CD (D8)]A2	Full ASCII Code 39(D4) or Full ASCII Code 39 if pos. (+K) Not check CD (C1) Not transmit CD (D8)]A6
Normal Code 39 (D5) Check CD (C0) Not transmit CD (D8)]A3	Full ASCII Code 39(D4) or Full ASCII Code 39 if pos. (+K) Check CD (C0) Not transmit CD (D8)]A7

Code option	JAIM-ID	Code option	JAIM-ID
Codabar option AIM/ISO15424 Code ID : I*			
Codabar normal mode (HA) Not check CD (H7) Transmit CD (H8)	JF0	Codabar normal mode(HA) Not check CD (H7) Not transmit CD (H9)	JF4
Codabar ABC (H4) or (H3) Not check CD (H7) Transmit CD (H8)	JF1	Codabar ABC (H4) or (H3) Not check CD (H7) Not transmit CD (H9)	JF5
Codabar normal mode (HA) Check CD (H6) Transmit CD (H8)	JF2	Codabar normal mode (HA) Check CD (H6) Not transmit CD (H9)	JF6
Codabar ABC (H4) or (H3) Check CD (H6) Transmit CD (H8)	JF3	Codabar ABC (H4) or (H3) Check CD (H6) Not transmit CD (H9)	JF7
Interleaved 2of5 option AIM/ISO15424 Code ID : F*			
Not check CD (G0) Transmit CD (E0)	JI0	Not check CD (G0) Transmit CD (E1)	JI3
Check CD (G1) Transmit CD (E0)	JI1	Check CD (G1) Transmit CD (E1)	JI4
IATA option AIM/ISO15424 Code ID : R*			
Not check CD (4H) Transmit CD (4L)	JR0	Not check CD (4H) Not transmit CD (4M)	JR3
Check FC and SN only (4I) or Check CPN, FC and SN (4J) or Check CPN, AC, FC and SN (4K) Transmit CD (4L)	JR1	Check FC and SN only (4I) or Check CPN, FC and SN (4J) or Check CPN, AC, FC and SN (4K) Not transmit CD (4M)	JR4
MSI/Plessey option AIM/ISO15424 Code ID : M*/X0			
Check 1CD = MOD 10 (4B): (4B) + Transmit CD1 (4E) or (4B) + Not transmit CD (4G) or (4B) + Transmit CD1 and CD2 (4F)	JM0 JM1 JX0	Check 2CD's = MOD 10/MOD 11 (4D): (4D) + Transmit CD1 (4E) or (4D) + Not transmit CD (4G) or (4D) + Transmit CD1 and CD2 (4F)	JX0
Check 2CD's = MOD 10/MOD 10 (4C): (4C) + Transmit CD1 (4E) or (4C) + Not transmit CD (4G) or (4C) + Transmit CD1 and CD2 (4F)	JX0	Check 2CD's = MOD 11/MOD 10 (4R): (4D) + Transmit CD1 (4E) or (4D) + Not transmit CD (4G) or (4D) + Transmit CD1 and CD2 (4F)	JX0
Telepen option AIM/ISO15424 Code ID : B*			
Telepen (numeric or ASCII only): ASCII mode (D3) Numeric mode (D2)	JB0 JB1	Telepen (numeric followed by ASCII): ASCII mode (D3) Numeric mode (D2)	JB0 JB2
Telepen (ASCII followed by numeric) (not supported): ASCII mode (D3) Numeric mode (D2)	JB0 JB2		

Code option	JAIM-ID	Code option	JAIM-ID
Code 11 option AIM/ISO15424 Code ID : H*/X0			
Check 1 CD (BLG) or Check auto 1 or 2 CDs (BLI) (length > 12) Transmit CD _(s) (BLK)	JH0	Check 1 CD (BLG) or Check 2 CDs (BLH) or Check auto 1 or 2 CDs (BLI) (length > 12) Transmit CD _(s) (BLK)	JH0
Check 2 CDs (BLH) or Check auto 1 or 2 CDs (BLI) (length > 12) Transmit CD _(s) (BLK)	JH1	Not check CD (BLF) Not transmit CD (BLJ)	JH0
Codablock F option AIM/ISO15424 Code ID : O*			
FNC1 not used	JO4	FNC1 in 1st position	JO5
DataMatrix option AIM/ISO15424 Code ID : d*			
ECC000 - ECC140	jd0	ECC200, supporting ECI protocol	jd4
ECC200	jd1	ECC200, FNC1 in 1st or 5th position and supporting ECI protocol	jd5
ECC200, FNC1 IN 1st or 5th position	jd2	ECC200, FNC1 in 2nd or 6th position and supporting ECI protocol	jd6
ECC200, FNC1 IN 2nd or 6th position	jd3		
Aztec option AIM/ISO15424 Code ID : z*			
No structure/other	z0	Structured append header included, FNC1 following an initial letter or pair of digits	z8
FNC1 preceding 1st message character	z1		
FNC1 following an initial letter or pair of digits	z2	Structured append header included and ECI protocol implemented	z9
ECI protocol implemented	z3		
FNC1 preceding 1st message character and ECI protocol implemented	z4	Structured append header included, FNC1 preceding 1st message character, ECI protocol implemented	zA
FNC1 following an initial letter or pair of digits, ECI protocol implemented			
Structured append header included	z6	Structured append header included, FNC1 following an initial letter or pair of digits, ECI protocol implemented	zB
Structured append header included and FNC1 preceding 1st message character	z7		
		Aztec runes	zC
Maxicode option AIM/ISO15424 Code ID : U*			
Symbol in mode 4 of 5	JU0	Symbol in mode 4 of 5 , ECI protocol implemented	JU2
Symbol in mode 2 of 3	JU1	Symbol in mode 2 of 3 , ECI protocol implemented	JU3

5.5. Read Mode Settings (Basic Settings)

5.5.1. Read Mode Options

1) Single Read (S0)

When a bar code has been decoded, the scan engine will stop reading and output the decoded data. The scan engine must be triggered again to read another bar code.

2) Multiple Read (S1)

When a bar code has been decoded, the decoded data will be output and the scan engine will keep on reading. When the bar code that has just been output is read in a row, it will not be output. However, when the scan engine cannot decode any labels for some configurable time, it will forget the history and then the same label can be read (see [5.5.4.](#)).

3) Continuous Read (S2)

The scan engine keeps on outputting as much data as it can decode regardless of whether it is the same or not. This mode is mainly used for demonstration and diagnosis and not suitable for normal operations.

5.5.2. Trigger Switch Options (S7, S8)

Enable or disable trigger is configurable.

When the trigger switch is disabled, the scan engine will stay ON all the time.

5.5.3. Add-on Delay Timer (XA to XD)

Since WPC-type codes with add-on have a high probability of unsuccessful decoding, the scan engine repeats decoding the add-on codes during the specified period of time. It is effective to read the add-on parts, but it will also cause a reduced response when a code without add-on is read.

Item	Command	Description	Default
Read mode	S0	Single read	○
	S1	Multiple read	
	S2	Continuous read	
Enable / Disable trigger	S7	Disable trigger (Continuous read)	
	S8	Enable trigger	○
Add-on delay timer	XA	Disable Add-on wait mode	○
	XB	Add-on wait mode 0.25 s.	
	XC	Add-on wait mode 0.50 s.	
	XD	Add-on wait mode 0.75 s.	

5.5.4. Multiple Read Reset Time (AG to AN)

When the scan engine keeps on reading the same label while in Multiple Read mode, the data will not be output. However, when the scan engine is pointed away from the label for the number of frames specified by this option, it can decode and output the same label again.

Item	Command	Description	Default
Multiple Read Reset Time	AH	Multiple read reset time = 1 frame	
	AI	Multiple read reset time = 2 frames	
	AJ	Multiple read reset time = 3 frames	
	AK	Multiple read reset time = 4 frames	
	AL	Multiple read reset time = 5 frames	
	AM	Multiple read reset time = 6 frames	○
	AN	Multiple read reset time = 7 frames	
	AG	Multiple read reset time = indefinitely	

5.5.5. Quiet Zone

This option allows the scan engine to decode bar codes that have smaller start and/or end margins than specified for the symbologies. Note that this option may increase the possibility of partial and ghost reads, so do not use smaller margin checks than necessary.

Item	Command	Description	Default
Margin check	YN	No margin check	
	YO	Margin check 1/7 nominal	
	YP	Margin check 2/7 nominal	
	YQ	Margin check 3/7 nominal	
	YR	Margin check 4/7 nominal	
	YS	Margin check 5/7 nominal	
	YT	Margin check 6/7 nominal	
	YU	Margin check nominal	○

5.5.6. Auto Trigger

With these options, you can configure the scan engine to continuously capture images, without having its illumination LED switched on. When the scan engine detects changes in the captured images, it is triggered and will then try to decode the image. When the auto trigger is synchronized with the trigger switch, the read time configured for normal reading the settings in "5.5.7. will be used for auto trigger read time.

Item	Command	Description	Default
Auto trigger	+F	Disable auto trigger	○
	+I	Enable auto trigger	
Auto trigger read time (Enable when auto trigger is not synchronized with trigger switch)	%F	Read time 1 second	○
	%G	Read time 2 seconds	
	%H	Read time 3 seconds	
	%I	Read time 4 seconds	
	%J	Read time 5 seconds	
	%K	Read time 6 seconds	
	%L	Read time 7 seconds	
	%M	Read time 8 seconds	
	%N	Read time 9 seconds	
	%O	Read time * 10	
	%P	Read time indefinitely	
Auto trigger Synchronization	%Q	Disable auto trigger synchronization with trigger switch	
	%R	Enable synchronization auto trigger synchronization with trigger switch	○
Auto trigger conditions	XMF	Auto trigger setting (sensitive)	○
	XMH	Auto trigger setting (normal)	
	XMJ	Auto trigger setting (insensitive)	

5.5.7. Read Time

This option can be used to configure the read time, counting from the moment the reading has started (either by pressing the trigger switch or by sending the trigger command.) When no data has been output for the selected time, a timeout occurs and the reading stops. When the scan engine is able to decode successfully and output data in Continuous Read mode, or Multiple Read mode, the elapsed time will be cancelled and the read time will be reset. Therefore, the scan engine does not stop reading while codes are decoded successfully and the data is output.

Item	Command	Description	Default
Read Time	Y0	0 second	
	Y1	1 second	
	Y2	2 seconds	○
	Y3	3 seconds	
	Y4	4 seconds	
	Y5	5 seconds	
	Y6	6 seconds	
	Y7	7 seconds	
	Y8	8 seconds	
	Y9	9 seconds	
	YM	Read time indefinitely	
	YL	Read time * 10	

5.5.8. Redundancy

When redundancy is enabled, a label has to be scanned and decoded multiple times and the results should be the same, before it is considered correctly decoded. The redundancy count is the number of times that the label has to be scanned additional to the first scan. Selecting a higher redundancy count reduces the probability of reading errors, but it makes the output response slower. With high quality printed labels, the default setting is enough to ensure the reliability.

Item	Command	Description	Default
Redundancy	X0	Read 1 time, redundancy = 0	
	X1	Read 2 time, redundancy = 1	○
	X2	Read 3 time, redundancy = 2	
	X3	Read 4 time, redundancy = 3	
	BS	Read 5 time, redundancy = 4	
	BT	Read 6 time, redundancy = 5	
	BU	Read 7 time, redundancy = 6	
	BV	Read 8 time, redundancy = 7	
	BW	Read 9 time, redundancy = 8	

5.5.9. Positive and Negative Codes

Usually bar codes are printed black on white, but sometimes white on black. These labels are called positive and negative respectively. In case the 'negative bar codes' option has been selected, positive labels may not be decoded anymore or with difficulty. This also applies to menu labels. In case the 'positive and 'negative bar codes' option has been selected, the reading speed may be decreased

Item	Command	Description	Default
Positive and Negative codes	V2	Positive bar codes	○
	V3	Negative bar codes	
	V4	Positive and Negative bar codes	

5.6. Read Mode Settings (Imager Settings)

5.6.1. Illumination and Aiming

When "LED illumination alternating" option is selected, the illumination is alternating between on and off, and the scan engine memorizes the condition where barcodes were able to read. Then it preferentially reads bar codes in that illumination condition. When laser aiming is disabled, the scan engine cannot use the laser for ranging. It will then use the image contrast method, but that might have a negative effect on the reading performance.

Item	Command	Description	Default
Illumination mode	D3A	Disable LED illumination	
	D39	Enable LED illumination	○
	D3B	LED illumination alternating	
Aiming ON / OFF	D3C	Disable laser aiming and LED illumination	
	D3D	Enable laser aiming	○
	D3E	Disable laser aiming	

5.6.2. Central Reading

This function is used to read a target code when multiple codes are closely positioned. Reading can be activated only when the laser aiming point is on a code as shown below.

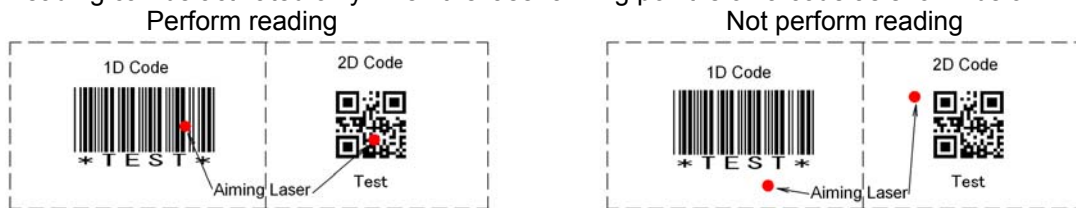

Item	Command	Description	Default
Central reading	D00	Enable central reading; read only a code that laser aims at.	
	D0Z	Disable central reading; read an entire image	○

5.6.3. 1D Code Decode Mode

These options allow you to configure prudence to decode linear bar codes.

In Careful mode, it can be easier to read bar codes which are difficult to read, while the reading response degrades. On the contrary, in Quick mode, the reading response improves but it may be difficult to read bar codes which are curved or dirty.

Item	Command	Description	Default
1D code decode mode	DM3	Careful mode	
	DM2	Standard mode	○
	DM1	Semi-quick mode	
	DM0	Quick mode ^{*1}	

5.6.4. Snapshot and Decoding Parallelism

The image capturing process and the decoding process can run concurrent, which will increase the performance, but will also increase the power consumption. To lower the power consumption, at the expense of lower performance, select "Snapshot and decoding parallelism OFF"

Item	Command	Description	Default
Parallelism	E6W	Snapshot and decoding parallelism OFF	
	E6X	Snapshot and decoding parallelism ON	○

5.6.5. Collective Reading

It is possible not to output data unless the specified number of codes is read. That means that the scan engine does not read codes other than the specified number.

Item	Command	Description	Default
Multiple label read	D01	Multiple label 1	○
	D02	Multiple labels 2	
	D03	Multiple labels 3	
	D04	Multiple labels 4	
	D05	Multiple labels 5	
	D06	Multiple labels 6	
	D07	Multiple labels 7	
	D08	Multiple labels 8	
	D09	Multiple labels 9	
	D0A	Multiple labels 10	
Multiple label read (right and left)	D0N	Left to right	○
	D0O	Right to left	
Multiple label read (top and bottom)	D0P	Top to bottom	○
	D0Q	Bottom to top	
Multiple label read (output priority)	D0R	Output priority horizontal	
	D0S	Output priority vertical	○
Same label read	D0T	Disable same label during multiple label read	○
	D0U	Enable same label during multiple label read	
Sorting labels	D0V	Enable sorting decoded labels	○
	D0W	Disable sorting decoded labels	
Buffered mode	D0X	Buffered mode (one image)	○
	D0L	Buffered mode (n images)	
	D0Y	Unbuffered mode	

5.6.6. Structured Append Options

When multiple 2D codes contain single data, the following advanced settings are available. The structured append codes can be read by default.

Item	Command	Description	Default
Flush structured append buffer / Multiple label buffer	D1H	Flush structured append buffer / Multiple label buffer	
Clear structured append / Multiple label read entries	D1I	Clear structured append / Multiple label read entries	
Structured append time out	D1R	Clear entries in structured append / multi label time out	○
	D1S	Clear buffers in structured append / multi label time out	
Structured mode	BE0	Buffered mode	○
	BE1	Unbuffered mode (Transmit only the structured append blocks)	
	BE3	Unbuffered mode (Transmit all labels)	
Control header transmission	D1D	Transmit control header	
	D1E	Not transmit control header	○
ECI/GLI protocol	D1F	Use ECI/GLI protocol	
	D1G	Do not use ECI/GLI protocol	○
Control header position	D1J	Send the control header before the data	○
	D1K	Send the control header after the data	
Control header file ID	D1L	Do not put file ID in control header.	
	D1M	Put file ID in control header.	○
Control header option field	D1N	Disable option field on control header	○
	D1O	Enable option field on control header	
Structured append (decoder type)	D1T	Only the same decoder works during structured append	○
	D1U	All decoder works during structured append	

5.6.7. Scanning on LCD Display

When codes displayed on cellular phones are scanned, the reading performance may be improved by enabling this option

Item	Command	Description	Default
LCD display scanning	D3I	Disable scanning from LCD display	○
	D3J	Enable scanning LCD display	
	E6X	Snapshot and decoding parallelism ON	○

5.6.8. Mirror Image Capture Mode

If an external mirror is installed to read codes, this option should be enabled.

Item	Command	Description	Default
Mirror image capture	E8J	Disable mirror image capture	○
	E8I	Enable mirror image capture	

5.6.9. External Illumination

When external illumination is used, this option should be enabled.

Item	Command	Description	Default
External illumination	D26	Internal illumination	○
	D27	External illumination	
	D28	Internal and External illumination	

5.7. Indicator Settings

5.7.1. Good Read Buzzer

The good read buzzer is activated after a bar code was successfully decoded and the data was output. 3 types of tone, 4 types of duration and 4 types of loudness are configurable. Buzzer also can be disabled.

Item	Command	Description	Default	Remark
Software buzzer	W0	Disable buzzer		
	W8	Enable buzzer	○	
Buzzer tone	W1	Single tone buzzer	○	
	W2	High - low buzzer		
	W3	Low - high buzzer		
Buzzer duration	W7	Buzzer duration: 50 ms	○	
	W4	Buzzer duration: 100 ms		
	W5	Buzzer duration: 200 ms		
	W6	Buzzer duration: 400 ms		
Buzzer loudness	T0	Buzzer loudness : Maximum	○	
	T2	Buzzer loudness : Loud		
	T3	Buzzer loudness : Normal		
	T4	Buzzer loudness : Minimum		
Buzzer transmission	VY	Buzzer before transmission	○	
	VZ	Buzzer after transmission		
Startup buzzer	GD	Disable startup buzzer		Enabled only with "Z2"
	GC	Enable startup buzzer	○	Enabled only with "Z2"

5.7.2. Read Timeout Buzzer

In case decoding cannot be done within the timeout period, an error buzzer sounds when the read operation ends. The buzzer loudness setting (T0 ~ T3) is reflected as the loudness.

Item	Command	Description	Default	Remark
Read timeout buzzer	EAP	Disable read timeout buzzer	○	
	EAQ	Enable read timeout buzzer		

5.7.3. Good Read LED

The good read LED lights up after a bar code was successfully decoded and the data was output. Three types of indicator duration are configurable.

Item	Command	Description	Default
Good read LED	T4	Disable indicator	
	T5	Indicator duration: 0.2 s	○
	T6	Indicator duration: 0.4 s	
	T7	Indicator duration: 0.8 s	

6. Appendix

6.1. Setting Output Table

6.1.1. Setting Table (Z3 Command)

XSW No.	Setting Data
XSW No. 1	5FC9 173F 0000 8200 1003 5C00 0411 2A24 0000 6005
XSW No. 11	0002 4060 3004 729A 0015 0C9A 0327 000A 0003 C84C
	4408 005C 3255 1080 CC60 0100 1E00 0000 01E0 9280
	3402 FFFF FFFF FFFF FFFF FFFF FFFF FFFF FFFF
	FFFF FFFF FFFF FFFF FFFF FFFF FFFF FFFF
	FFFF FFFF FFFF FFFF FFFF FFFF FFFF FFFF
	FFFF FFFF FFFF FFFF FFFF FFFF FFFF FFFF
	FFFF FFFF FFFF FFFF FFFF FFFF FFFF FFFF
	FFFF FFFF FFFF FFFF FFFF FFFF FFFF FFFF
	3030 3030 0000 0000 3030 3030 0000 0000 0000 0000
	0000 0000 0000 FFFF FFFF 0214 0000 0000 0383 01FF
	0246 003C 0078 00D2 00D2 066C 0000 0000 0000 0000
	0000 2061 1893 2EA1 1AC0 0000 04FF 0000 03FF 2841
	0700 0030 9291 0A10 0000 0000 E610 0000 000A 0000
	0000 0000 0000 0000 0000 0000 0000 0000 0000 0000
	0000 0000 0000 0000 0000 0000 0000 0000 0000 0000
	0000 0000 0000 0000 0000 0000 0000 0000 0000 0000
	0000 0000 0000 0000 0000 0000 0000 0000 0026 019A
	0000 0096 000F 0008 0002 0003 0000 0000 0000 0000
	0000

10 settings of the scan engine (setting data in RAM) are output in 2-byte size from left in order of XSW numbers.

ENABLING: Reading enabled / disabled
 MIN : Minimum length (in hex)
 MAX : Maximum length (in hex)
 FIXED : Fixed length (in hex)
 "----" : Setting disable (Fixed length)
 PREFIX : Max 4 characters (in ASCII / hex)
 SUFFIX : Max 4 characters (in ASCII / hex)
 FF : Not configured

CODE	ENABLING	PREFIX	SUFFIX	MIN	MAX	FIXED
1 UPC-A	1	FF FF FF FF	0D FF FF FF	----	----	----
2 UPC-A Addon	0	FF FF FF FF	0D FF FF FF	----	----	----
3 UPC-E	1	FF FF FF FF	0D FF FF FF	----	----	----
4 UPC-E Addon	0	FF FF FF FF	0D FF FF FF	----	----	----
5 UPC-E1	0	FF FF FF FF	0D FF FF FF	----	----	----
6 UPC-E1 Addon	0	FF FF FF FF	0D FF FF FF	----	----	----
7 EAN-13	1	FF FF FF FF	0D FF FF FF	----	----	----
8 EAN-13 Addon	0	FF FF FF FF	0D FF FF FF	----	----	----
9 EAN-8	1	FF FF FF FF	0D FF FF FF	----	----	----
10 EAN-8 Addon	0	FF FF FF FF	0D FF FF FF	----	----	----
11 Code 39	1	FF FF FF FF	0D FF FF FF	0001	0000	FFFF FFFF
12 Tri-Optic	1	FF FF FF FF	0D FF FF FF	----	----	----
13 Codabar	1	FF FF FF FF	0D FF FF FF	0005	0000	FFFF FFFF
14 Industrial 2of5	1	FF FF FF FF	0D FF FF FF	0005	0000	FFFF FFFF
15 Interleaved 2of5	1	FF FF FF FF	0D FF FF FF	0006	0000	FFFF FFFF
16 S-Code	1	FF FF FF FF	0D FF FF FF	0005	0000	FFFF FFFF
17 Matrix 2of5	0	FF FF FF FF	0D FF FF FF	0005	0000	FFFF FFFF
18 Chinese Post Matrix 2of5	0	FF FF FF FF	0D FF FF FF	0005	0000	FFFF FFFF
19 Korean Postal Authority	0	FF FF FF FF	0D FF FF FF	----	----	----
20 Intelligent Mail	0	FF FF FF FF	0D FF FF FF	----	----	----
21 POSTNET	0	FF FF FF FF	0D FF FF FF	----	----	----
22 Japanese Postal	0	FF FF FF FF	0D FF FF FF	----	----	----
23 IATA	1	FF FF FF FF	0D FF FF FF	0005	0000	FFFF FFFF
24 MSI/Plessey	1	FF FF FF FF	0D FF FF FF	0003	0000	FFFF FFFF
25 Telepen	1	FF FF FF FF	0D FF FF FF	0001	0000	FFFF FFFF
26 UK/Plessey	1	FF FF FF FF	0D FF FF FF	0002	0000	FFFF FFFF
27 Code 128	1	FF FF FF FF	0D FF FF FF	0001	0000	FFFF FFFF
28 Code 93	1	FF FF FF FF	0D FF FF FF	0001	0000	FFFF FFFF
29 Code 11	0	FF FF FF FF	0D FF FF FF	0001	0000	FFFF FFFF
30 GS1 DataBar	1	FF FF FF FF	0D FF FF FF	----	----	----
31 GS1 DataBar Limited	1	FF FF FF FF	0D FF FF FF	----	----	----
32 GS1 DataBar Expanded	1	FF FF FF FF	0D FF FF FF	0001	0000	FFFF FFFF
33 Codablock F	0	FF FF FF FF	0D FF FF FF	0001	0000	FFFF FFFF
34 DataMatrix ECC200	1	FF FF FF FF	0D FF FF FF	0001	0000	FFFF FFFF
35 DataMatrix ECC000-140	0	FF FF FF FF	0D FF FF FF	0001	0000	FFFF FFFF
36 Aztec Code	1	FF FF FF FF	0D FF FF FF	0001	0000	FFFF FFFF
37 Aztec Runes	0	FF FF FF FF	0D FF FF FF	0001	0000	FFFF FFFF
38 Chinese Sensible Code	0	FF FF FF FF	0D FF FF FF	0001	0000	FFFF FFFF
39 QR Code	1	FF FF FF FF	0D FF FF FF	0001	0000	FFFF FFFF
40 Micro QR Code	1	FF FF FF FF	0D FF FF FF	0001	0000	FFFF FFFF
41 Maxi Code	1	FF FF FF FF	0D FF FF FF	0001	0000	FFFF FFFF
42 PDF417	1	FF FF FF FF	0D FF FF FF	0001	0000	FFFF FFFF
43 Micro PDF417	1	FF FF FF FF	0D FF FF FF	0001	0000	FFFF FFFF
44 GS1-128	0	FF FF FF FF	0D FF FF FF	0001	0000	FFFF FFFF
45 GS1-128 Composite	0	FF FF FF FF	0D FF FF FF	0004	0000	FFFF FFFF
46 GS1 DataBar Composite	0	FF FF FF FF	0D FF FF FF	0004	0000	FFFF FFFF
47 OCR	0	FF FF FF FF	0D FF FF FF	----	----	----
48 NL / ND		FF FF FF FF	FF FF FF FF			
49 COMMON-PREFIX		FF FF FF FF	FF FF FF FF			
50 COMMON-SUFFIX		FF FF FF FF	FF FF FF FF			
51 ISBN JAN-INFIX		FF FF FF FF	FF FF FF FF			

END

6.1.2. Differential Setting Output Table (EAR Command)

Example 1: "EAR" differential output table by default

```
SAME DATA
END
```

Example 2: "EAR" differential output table after sending <Esc>T3Z2[D3A<CR>

```
XSW RAM : FLASH : DEFAULT
7 041D : 041D : 0411
27 1E04 : 1E00 : 1E00
END
```

It shows the setting was stored in flash ROM by "Z2".

It shows the setting data in RAM was changed but it has not been stored in flash ROM.

Example 3: "EAR" differential output table after sending <Esc>T3[D3AVB[BCOZ2[BLC<CR>

```
XSW RAM : FLASH : DEFAULT
1 7F89 : 5F89 : 5FC9
2 173B : 173B : 173F
7 041D : 041D : 0411
27 1E04 : 1E04 : 1E00

CODE ENABLING PREFIX / SUFFIX MIN MAX FIXED
11 Code 39
RAM 0 FF FF FF FF 0D FF FF FF 0001 0000 FFFF FFFF
FLASH 0 FF FF FF FF 0D FF FF FF 0001 0000 FFFF FFFF
DEFAULT 1 FF FF FF FF 0D FF FF FF 0001 0000 FFFF FFFF
29 Code 11
RAM 1 FF FF FF FF 0D FF FF FF 0001 0000 FFFF FFFF
FLASH 0 FF FF FF FF 0D FF FF FF 0001 0000 FFFF FFFF
DEFAULT 0 FF FF FF FF 0D FF FF FF 0001 0000 FFFF FFFF
34 DataMatrix ECC200
RAM 0 FF FF FF FF 0D FF FF FF 0001 0000 FFFF FFFF
FLASH 0 FF FF FF FF 0D FF FF FF 0001 0000 FFFF FFFF
DEFAULT 1 FF FF FF FF 0D FF FF FF 0001 0000 FFFF FFFF

END
```

For each code information, only differences are also output

The menu IDs sent for the above settings:
T3 : Buzzer loudness : Minimum
D3A : Disable illumination LED
VB : Disable Code 39
BCO : Disable Data Matrix ECC200
BLC : Enable Code 11
Z2 : Save parameters in flash ROM

6.2. Sample Codes

Example C.01
UPC-A

UPC-A



0 71589 81230 8

UPC-A +2



0 23569 27002 8 34

UPC-A +5



7 49659 02209 3 98765

Example C.02
UPC-E

UPC-E



0 123456 5

default data: 1234565

UPC-E +2



0 213224 0 22

default data: 213224022

UPC-E +5



0 654321 7 56789

default data: 654321756789

UPC-E1



1 234567 0

default data: 2345670

UPC-E1 +2



1 657832 6 90

default data: 657832690

UPC-E1 +5



1 098765 0 32418

default data: 098765032418

**Example C.03.
EAN-13 and EAN-8**

<p>EAN-13 (ISBN)</p>  <p>9 780131 103627 ISBN data: 0131103628</p>	<p>EAN-8</p>  <p>6537 8823</p>
<p>EAN-13 +2</p>  <p>8 710841 090246 12</p>	<p>EAN-8 +2</p>  <p>5638 2662 23</p>
<p>EAN-13 +5</p>  <p>8 710841 030181 02904</p>	<p>EAN-8 +5</p>  <p>1055 7778 06331</p>

**Example C.04.
Code 39 and It.Pharm.**

<p>Code 39</p>  <p>CODE39</p>	<p>Code 39 Italian Pharmaceutical (Full Italian Pharmaceutical)</p>  <p>908557705 encoded data: *V2GZD9* Full Italian Pharmaceutical data: A908557705</p>
<p>Code 39 Full ASCII</p>  <p>Code 39 encoded data: *C+O+D+E 39*</p>	<p>Tri-Optic</p>  <p>R01260 encoded data: \$260R01\$</p>

**Example C.05.
Codabar**

Codabar			
 0 1 2 3 5 encoded data: C01235D			
Codabar ABC		Codabar CX	
 0 1 2 3 4 encoded data: C01234D		 5 6 7 8 9 encoded data: D56789A	
Codabar ABC data: 0123456789		 1 2 3 4 4 encoded data: A12344C	
		 5 6 7 8 4 encoded data: B56784B	
		Codabar CX data: 1234456784	

**Example C.06.
2of5 and S-Code**

Industrial 2of5	Matrix 2of5
 1 2 3 4 5 6 7 8 9 5	 9 8 7 6 5 4 3 0
Interleaved 2of5 with bearer bars	Chinese Post
 0 1 2 3 4 5 6 7 8 4	 0464 100050 encoded data: 04641000501
S-Code	
 9 8 7 6 5 4 3 2 6	

<p>Example C.07. IATA</p> <hr/>  <p>1234567890</p>	<p>Example C.08. MSI/Plessey (with MOD 10 Checksum)</p> <hr/>  <p>02468 encoded data: 024687</p>
<p>Example C.09. Telepen</p> <div style="border: 1px solid black; padding: 2px; width: fit-content; margin: 0 auto;">Telepen numeric (Telepen ASCII)</div> <hr/>  <p>57748174857483 Telepen ASCII data: Telepen</p>	<p>Example C.10. UK/Plessey</p> <hr/>  <p>02468 encoded data: 02468F8</p>
<p>Example C.11. Code 128 and GS1-128</p> <div style="border: 1px solid black; padding: 2px; width: fit-content; margin: 0 auto;">Code 128</div> <hr/>  <p>0135792468</p>	<p>Example C.11. EAN-128</p> <div style="border: 1px solid black; padding: 2px; width: fit-content; margin: 0 auto;">EAN-128</div> <hr/>  <p>]C12143658709 encoded data: <FNC1>2143658709</p>
<p>Example C.12. Code 93</p> <hr/>  <p>Code 93</p>	<p>Example C.13. Code 11</p> <hr/>  <p>1234-5678 encoded data: 1234-56784</p>
<p>Example C.14. Korean Postal Authority code</p> <hr/>  <p>305-601</p>	

**Example C.15.
Intelligent Mail Barcode**



**Example C.16.
POSTNET**



**Example C.17.
GS1 Databar**

GS1 Databar



0165473728281919
encoded data: 65473728281919

GS1 Databar stacked



0198321456098768
encoded data: 98321456098768

GS1 Databar truncated



0100012345678905
encoded data: 00012345678905

GS1 Databar Limited



0117834783468340
encoded data: 17834783468340

GS1 Databar Expanded



012345ABCDE
encoded data: 012345ABCDE

**Example C.18.
Composite Codes**

Composite
Component A



encoded RSS-14 data: 01234567891231
encoded CC-A data: CC-A : up to 56 characters
default data:
0101234567891231CC-A : up to 56 characters

Composite
Component B









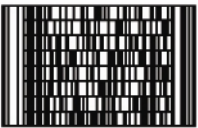

encoded RSS-14 data: 56128923901255
encoded CC-B data: CC-B:encodes up
to 338 alphanumeric characters
default data:
0156128923901255CC-B:encodes up
to 338 alphanumeric characters

Composite
Component C

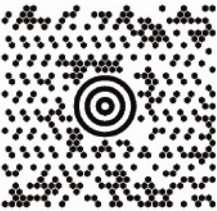

encoded EAN-128 data: <FNC1>503012345678
encoded CC-C data: 021301234567893724<GS>
101234567ABCDEFG
default data:
503012345678021301234567893724<GS>
101234567ABCDEFG

<p>Example C.25. PDF417</p> <hr/>  <p>PDF417 sample bar code.</p>	<p>Example C.26. MicroPDF417</p> <hr/>  <p>MicroPDF417 sample bar code.</p>
<p>Example C.19. Codablock F</p> <hr/>  <p>Codablock F sample bar code</p>	<p>Example C.20. DataMatrix (ECC200)</p> <hr/>  <p>DataMatrix sample bar code.</p>
<p>Example C.21. Aztec (Aztec)</p> <hr/>  <p>Aztec sample bar code.</p>	<p>(Aztec Runes)</p> <hr/>  <p>025 encoded data: 25</p>
<p>Example C.22. Chinese Sensible code</p> <hr/> 	<p>Example C.23. QR Code (Model 2)</p> <hr/>  <p>QR Code sample bar code.</p>
<p>Example C.24. Micro QR Code (Model 4)</p> <hr/>  <p>1415926535897</p>	<p>Example C.25. Maxicode (Mode 4)</p> <hr/>  <p>MaxiCode sample bar code.</p>