

onn.TM

Wireless FM
transmitter with Headset
With Bluetooth[®] Wireless Technology

Model: 100014268

User Manual

We 'd love to hear from you. Scan with your Walmart
app and let us know what you think.

December 31, 2019_V1



FCC NOTICE

This equipment has been tested and found to comply with the limits for a Class B digital device, pursuant to Part 15 of the FCC Rules. These limits are designed to provide reasonable protection against harmful interference in a residential installation. This equipment generates, uses and can radiate radio frequency energy and, if not installed and used in accordance with the instructions, may cause harmful interference to radio communications. However, there is no guarantee that interference will not occur in a particular installation. If this equipment does cause harmful interference to radio or television reception, which can be determined by turning the equipment off and on, the user is encouraged to try to correct the interference by one or more of the following measures:

- Reorient or relocate the receiving antenna.
- Increase the separation between the equipment and receiver.
- Connect the equipment into an outlet on a circuit different from that to which the receiver is connected.
- Consult the dealer or an experienced radio/TV technician for help.

FCC WARNING

This equipment may generate or use radio frequency energy. Changes or modifications to this equipment may cause harmful interference unless the modifications are expressly approved in the instruction manual. Modifications not authorized by the manufacturer may void user's authority to operate this device.

This device complies with part 15 of the FCC Rules. Operation is subject to the condition that this device does not cause harmful interference.

LOCATION OF CONTROLS

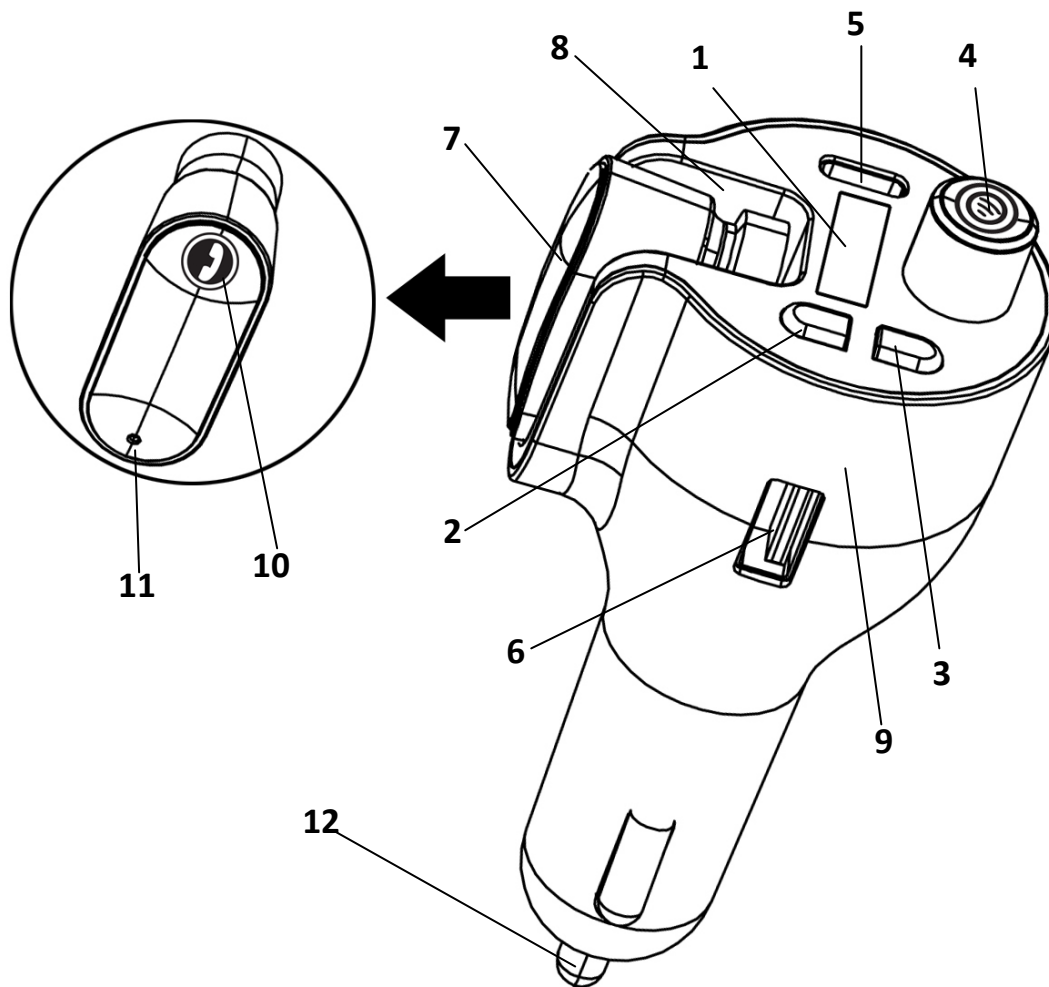

1. LED Display
2. ◀ Button
3. ▶ Button
4. Volume Control/🔊 Knob
5. USB Type-C Port
6. USB QC3.0 Port
7. Headset
8. Headset Base
9. FM Transmitter
10. 🔄 Button
11. Indicator
12. Car Cigarette Plug

OPERATION

For listening to music from your BT Device through the unit and your Car Radio, follow the steps below:

PAIRING:

Step1:

Pairing the unit to your Car Radio:

1. Connect the unit to the car cigarette lighter socket as illustrated below:

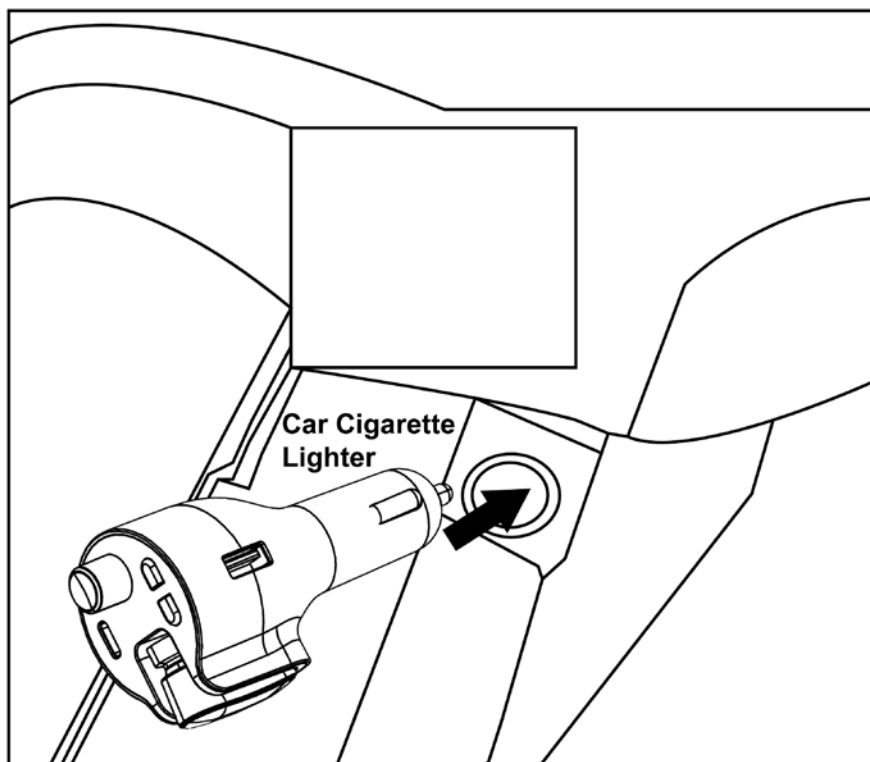





2. The unit will automatically power on and the LED Display on the Unit will illuminate & blink. The voltage of the car battery will appear on the LED Display at first.



3. Then a default FM Channel will appear on the unit as illustrated below (For example: 88.1MHz)..



4. The Headset on the Unit will start to charging and the Red Indicator on it will illuminate (When charging is complete, the Red Indicator will turn off).
5. Turn on your Car Radio and enter the radio FM mode as usual. Search for a blank FM channel without any radio signal received (For example: 107.0 MHz).
6. Press and hold the Volume Control/  Knob on the unit until the LED Display on the unit start to blink. Then, press the  /  Button on the unit repeatedly (or turn around the Volume Control/  Knob on the unit) until the same channel frequency appear on the LED Display as illustrated below (For example: 107.0 MHz):

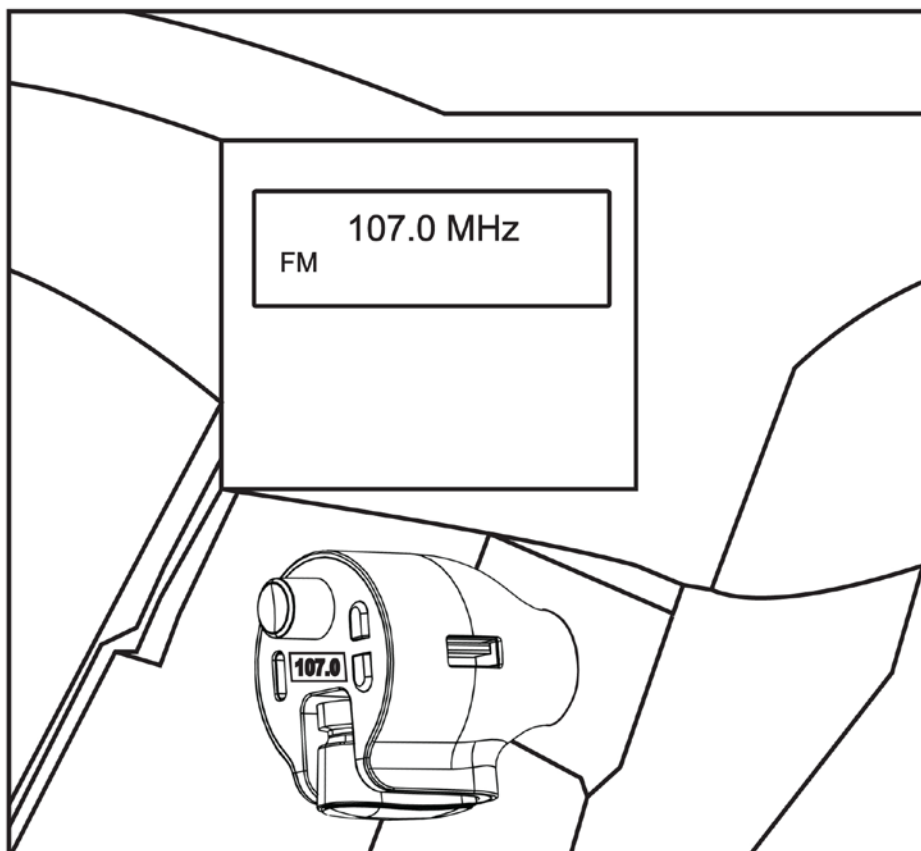

Step 2:

Pair your BT (Bluetooth) Device to the FM Transmitter on the unit:

In first time use or re-pairing the FM Transmitter on the unit to a new BT Device, pairing it as below:

1. Power on and pair the unit to Car Radio as step 1 above.
2. Power on the external BT Device and enter to BT mode. Start pairing the FM Transmitter on the unit following the screen instruction from the external BT Device.

Note:

- When the external BT Device searches for the FM Transmitter on the unit, the BT Device name "Onn BT/FM" will appear on the BT Device Name List on your external BT Device. Pair your BT Device with it.
3. After the FM Transmitter on the unit paired, you will hear an audible prompt from Car Radio to say "Paired"

Step 3:

Pair your BT (Bluetooth) Device to the Headset on the unit:

In first time use or re-pairing the Headset on the unit to a new BT Device, pairing it as below:







1. Power on and pair the unit to Car Radio as step 1 above.
2. Pair your BT (Bluetooth) Device to the FM Transmitter on the unit as step 2 above.
3. Pick up the Headset from the unit, the Blue & Red LED indicator on the Headset will illuminate and blink.
4. Power on the external BT Device and enter to BT mode. Start pairing the Headset on unit following the screen instruction from the external BT Device.

Note:

- When the external BT Device searches for the Headset, the BT Device name "Onn BT/Headset" will appear on the BT Device Name List on your external BT Device. Pair your BT Device with it.
5. After the Headset paired, you will hear an audible prompt from headset to say "Connected", then the Red LED indicator will turn off, and the Blue LED indicator will turn to slow blink.

*** Above step 2 and 3 can be reversed.**

LISTENING TO MUSIC THROUGH PAIRED BT DEVICE

1. After step 1 & 2 & 3, now you can play the music or answer the incoming call with the paired BT Device as usual.
2. During playback:
 - Turn the Volume Control /  Knob on the unit to adjust volume level as desire. (Or, use the Volume Controls on the Car Radio or paired BT Device to adjust volume level).
 - Press the Volume Control /  Knob to pause; press again to resume normal playback.
 - Press the  or  Buttons repeatedly to skip tracks.
3. If the unit is paired to a Cell Phone and a call is incoming during an active music session:
 - Pick up the Headset from unit and hang to your ear, then you can answer the call as normal. When your call is complete, press the  Button on Headset or put the Headset back to Headset Base directly to disconnect or end the call. Then Press the Volume Control /  Knob to resume to music playback.
 - Or, pick up the Headset from the unit and put it back to the Headset base after 2-3 seconds to decline the incoming call, then resume to music playback.
 - Quick press the  Button twice to redial the last telephone number your cell phone called.
4. To shut off the unit, unplug the unit from car cigarette lighter socket.

Notes:

- *When the external BT Device searches the FM Transmitter & Headset on the unit, our model number "Onn BT/FM" & "Onn BT/Headset" will appear on the display of external BT Device.*
- *If while pairing you are asked for a code please try "0000" or "1234".*
- *During playback, If keep the Headset on the unit, music can be listened from your car radio. If take the Headset apart from the unit, music can be listened from your Headset.*

- *The Headset can be used as a independent BT Headset, once paired with the external BT Device, you can play the music or answer the incoming call with the paired BT Device as usual.*

NORMAL OPERATION AFTER PAIRED

1. Power on the external BT Device and enter to BT mode.
2. Power on the Car Radio and previously receiving the preset FM frequency same as the preset of unit (For example: 107.0 MHz).
3. Connect the unit to the car cigarette lighter socket. The LED Display on the Unit will start to illuminate and blink until the preset FM frequency appeared.
4. Wait a few seconds, the unit will automatically pair to the external BT Device. After paired, you will hear an audible prompt from Car Radio to say "Paired".
5. If pairing is complete you may now play music and answer the incoming call with your external BT Device.

BUILT-IN USB QC3.0 FAST CHARGER

The unit has a built-in USB QC3.0 Fast Charger. Use it to charge the external Device as below:

1. Connect the unit to the car cigarette lighter socket to power on the unit.
2. Connect the full size USB Plug of the charging cable (not included, to realize fast charging, the USB charging cable must be a fast charging cable) from the USB QC 3.0 Port to the external Device.
3. Fast charging will automatically start. Monitoring the charging status by the Charging Indicators on the external Device as usual.
4. When finished charging, disconnect the external Device from the USB QC3.0 Fast Charger Port.

BUILT-IN USB TYPE-C CHARGER

The unit has a built-in USB Type-C Charger. Use it to charge the external Device as below:



1. Connect the unit to the car cigarette lighter socket to power on the unit.
2. Connect the USB Type-C Plug of the charging cable (not included) from the USB Type-C Port to the external Device
3. Charging will automatically start. Monitoring the charging status by the Charging Indicators on the external Device as usual.
4. When finished charging, disconnect the external Device from the USB Type-C Charging Port.

Note:

The unit has a built-in overload/overheats protector. If the output of the unit is overload (or short circuit). The charger will auto shut off. Unplug the external Device from the USB QC3.0 or Type-C Port. The charger will auto reset.

TROUBLESHOOTING

Check the following before requesting service:

SYMPTOM	POSSIBLE CAUSE	POSSIBLE SOLUTION
Car Radio no sound	The radio frequency between the unit and Car Radio mismatch	Found and set the radio frequency of the Car Radio and unit in the same frequency
No sound or sound weak	Volume of the unit was set to minimum position	Increase the volume by turn the Volume Control/  Knob on the unit clockwise.
	Volume level of paired device is in low level	Rise the volume level of the paired device
Sound distortion	Volume level too high	Reduce the volume level by turn the Volume Control/  Knob on the unit counterclockwise
	Volume level of the paired device too high	Reduce the volume level of the paired device
BT not functioning	The external BT Device had NOT paired to the unit	Pair the external BT device to the unit as page 5
	The external BT device too far from the unit	Place the external BT device close to the unit

SPECIFICATIONS

Power Source	FM Transmitter: DC --- 12 or 24 V, 1300 mAh (Max.) from car cigarette lighter socket
	Headset: DC --- 3.7V, 30mAh (0.111 WH) Built-in rechargeable Li-ion Battery; Recharge by the FM Transmitter
Output	Built-in USB QC3.0 Fast Charger: DC --- 5 V, 3A or 9V / 2A or 12V / 1.5A
	Built-in USB Type-C Charger: DC --- 5 V, 3A
FM Transmitting Frequency:	88.1-107.9 MHz
FM Transmitting Power	87 dBuv/107 dBuv
BT Version:	5.0
BT Operation Distance:	32 Feet in open area

PACKAGE INCLUDES

1. Wireless FM Transmitter with Headset
2. User Manual
3. Quick Start Guide

SPECIFICATIONS AND ACCESSORIES ARE SUBJECT TO CHANGE WITHOUT NOTICE

**For customer service on this product,
Please call 1-888-516-2630**