

ORECK[®] XL[®]

SIMPLY AMAZING[®]

USER'S GUIDE

TRAVEL IRON/STEAMER

MODEL JP777

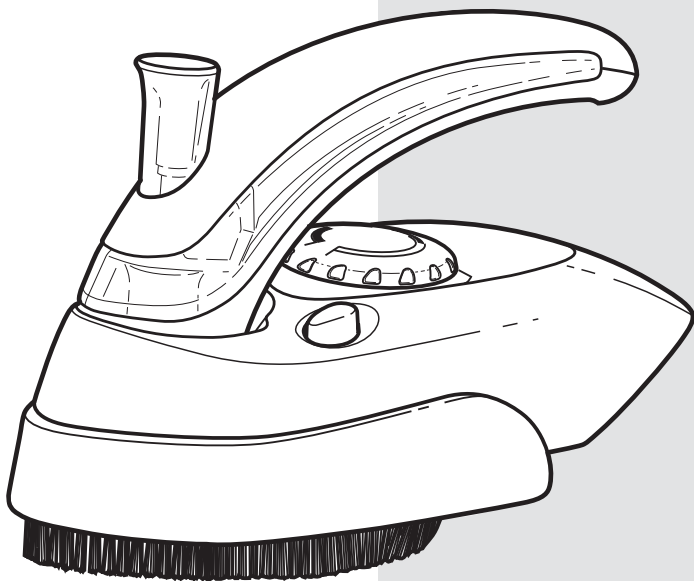

•IMPORTANT•

SAVE THIS BOOKLET!

Includes:

Important Safety Instructions

Warranty

Operating Instructions

REGISTER YOUR PRODUCT

ON THE WEB:

WWW.ORECK.COM



USA: 1-800-989-3535
CANADA: 1-888-676-7325



WWW.ORECK.COM



VISIT ONE OF OUR
OVER 750 LOCATIONS

IMPORTANT SAFETY INSTRUCTIONS

When using an electrical appliance, basic precautions should always be followed, including the following:

READ ALL INSTRUCTIONS BEFORE USING THIS APPLIANCE



WARNING

**To reduce the risk of fire,
electric shock, or injury:**

- Use the Travel Iron/Steamer only for its intended use.
- This appliance is provided with a voltage selector, it can be used on 120 V/230 V main power. This appliance will be set at the factory at 120 volts. Be sure dual voltage selector is in correct position before operating (refer to the General Information Section).
- To protect against a risk of electric shock, do not immerse the iron in water or other liquids.
- The iron should always be turned OFF before plugging or unplugging from outlet. Never pull cord to disconnect from outlet; instead, grasp plug and pull to disconnect.
- Do not allow cord to touch hot surfaces. Let iron cool completely before storing. Loop cord loosely around iron when storing.
- Always disconnect appliance from electrical outlet when filling with water or emptying and when not in use.
- To reduce the risk of contact with hot water emitting from steam vents, test the steamer before each use by holding it away from the body and pressing the steam button.
- Close supervision is necessary for any appliance being used by or near children. Do not leave appliance unattended while plugged in.
- To avoid a circuit overload, do not operate another high wattage appliance on the same circuit.
- Do not operate Travel Iron/Steamer with a damaged cord or if the appliance has been dropped or damaged. To avoid the risk of electric shock, do not disassemble. All repair work should be done by an authorized Oreck Service Center.
- This appliance has a polarized plug (one blade is wider than the other). As a safety feature, this plug will fit in a polarized outlet only one way. If the plug does not fit fully in the outlet, reverse the plug. If it still does not fit, contact a qualified electrician. Do not attempt to defeat this safety feature.
- Do not use attachments not intended or recommended for this appliance.
- Burns can occur from touching hot metal parts, hot water, or steam. Use caution when you turn a steam iron upside down – there may be hot water in the water tank.
- Before removing or attaching any accessories, unplug the appliance from the electrical outlet and let it cool.
- Never iron or steam clothes while they are being worn.

IMPORTANT SAFETY INSTRUCTIONS CONTINUED

When using an electrical appliance, basic precautions should always be followed, including the following:

READ ALL INSTRUCTIONS BEFORE USING THIS APPLIANCE



WARNING

**To reduce the risk of fire,
electric shock, or injury:**

- Never switch the dual voltage selector while the appliance is in use.
- This appliance was set at the factory to operate at 120 volts. Refer to the General Information section of this manual for conversion to 230 volt operation.
- Empty water from the iron before storing it. Point the unit downward over a sink and turn upside down to drain. Push steam button a few times and lightly shake iron after use to ensure all water is drained. The remaining moisture will evaporate if the unit is plugged in and heated for a few moments.
- If an extension cord is absolutely necessary, a 15-ampere cord should be used. Cords rated for less amperage may overheat. Care should be taken to arrange the cord so that it can not be pulled or tripped over.

SAVE THESE INSTRUCTIONS

Household Use Only

**ALL SERVICING SHOULD BE DONE BY AN
AUTHORIZED ORECK SERVICE CENTER.**

CUSTOMER SERVICE HOT LINE

US: 1-800-989-3535 Canada: 1-888-676-7325

Warranty

Oreck Corporation warrants the Travel Iron/Steamer (Model JP777) free from defects in material and workmanship under normal, non-commercial use and service. Oreck will remedy any such defects if they appear within one (1) year from date of purchase. This warranty gives you specific legal rights, and you may have other rights, which vary, from state to state.

Assembly

To assist you in identifying components of your Travel Iron/Steamer, the parts have been numbered as follows:

1. Steam Burst Button
2. Cord Protector/Power Cord
3. Water Tank Release Button
4. Water Tank Lid
5. Detachable Handle Cover/Water Tank
6. Handle Base
7. Temperature Indication Point
8. LED Light
9. Temperature Control Knob
10. Voltage Selector
11. Housing
12. Handle Release Button
13. Base Plate
14. Soleplate
15. Detachable Lint Remover
16. Detachable Clothes Brush
17. Measuring Cup

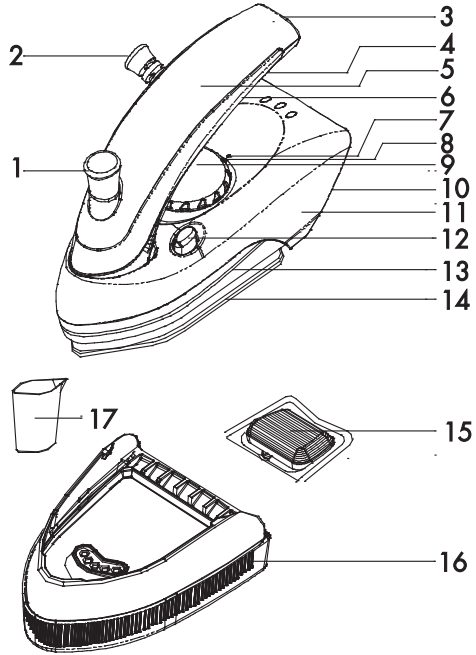

General Information

Before Initial Use

1. Before each use, always remove the detachable lint remover and verify the voltage rating on the appliance corresponds to the voltage in your home or hotel. Replace the Lint Remover.
2. Some parts of the appliance have been slightly greased and as a result the unit may smoke slightly when switched on for the first time. After a short while, however, this will cease.
3. Normal tap water can be used, but if you live in a hard water area, using distilled water is recommended to insure optimum performance of the unit.

Voltage Selection

This appliance is provided with a voltage selector. It can be used on 120VAC or 230VAC main power. This appliance will be set to the 120VAC setting at the factory. Before operating this appliance, be sure the dual voltage selector corresponds to the voltage in your home or hotel. To change the voltage, turn the dual voltage selector located under the detachable lint remover with a coin (**Fig. A**).

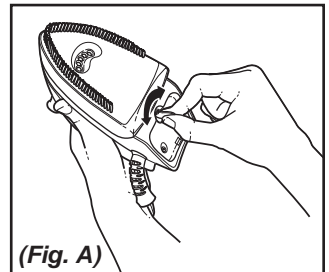

General Information Continued

Filling with Water

1. Lift handle into position. Gently press the water tank release button located at the end of the water tank and remove the detachable handle cover/water tank (**Fig. B**).
2. Lift up the water tank plug and fill with water. Do not overfill. To close the water tank plug, press it down firmly then replace the water tank back in the original position (press firmly until you hear a “click” sound).

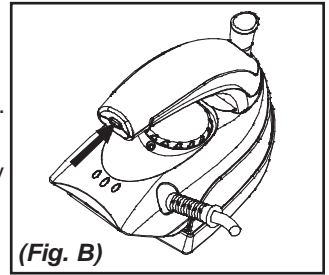

Controlling the Temperature

Set the temperature control knob according to the following fabric settings:

- Synthetics
- Silk/Wool
- Linen/Cotton

Note: Steam can only be produced when the temperature control knob is set on the max (••• linen/cotton) setting.

Ironing Tips

1. Sort the articles to be ironed according to the fabric. Ironing instructions are usually stitched onto an inside seam of the garment and these should be followed at all times. Start by ironing the fabrics requiring the lowest heat setting.
2. If you are unsure of the fiber content of a garment, test a small area (a seam or inside hem) before ironing.
3. When in doubt, start with low heat. If wrinkles remain, gradually increase heat to find the setting that provides the best results without damaging the fabric.
4. Avoid ironing over zippers and rivets on jeans as they will scratch the soleplate.

Operating Instructions for use as an Iron



WARNING: Never iron or steam clothes while they are being worn.

Using as a Steam Burst Iron

1. Unwrap the cord and fill the iron with water. (*Reference Filling with Water*)
2. Plug the unit into a wall outlet. Set the temperature control knob to the max setting. The LED light will illuminate.
3. When the LED light goes out, it means the iron reached the working temperature. The LED light will come on and go out regularly during ironing to indicate that the temperature control is working properly.
4. This setting can be used as a Steam Iron by pressing the steam burst button. (During the first use or if there has been an elapsed period of time since the last use, you may have to press the steam burst button a few times to initiate steam.)
5. Stand the iron in the heat rest position when rearranging clothing and while not in use (**Fig C**).

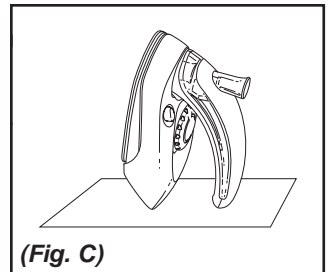

Using as a Dry Iron

This iron can also be used without steam as a Dry Iron even if there is water inside the water tank.

1. Unwrap the cord and plug the unit into a wall outlet. Set the temperature control knob to the desired setting.
2. The LED light will illuminate. When the LED light goes out, it means the iron reached the working temperature and it can be used as a Dry Iron. **Make sure the steam button is not pressed!**

Operating Instructions for use as a Steamer



WARNING: Before removing or attaching any accessories, unplug the steamer from the electrical outlet and let it cool. Never iron or steam clothes while they are being worn.

Attachments

Detachable Lint Remover (Fig. D)

1. Press down the tab to detach the lint remover.
2. Insert the tabs of the lint remover into the slots on the backside of the appliance, then press down until lint remover clicks into position.

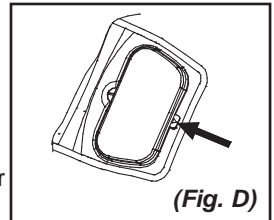

Detachable Clothes Brush (Fig. E)

1. Unpack the detachable clothes brush package. Attach the brush by sliding it down into place from the top, locking it into position.
2. Remove the brush by pushing it up from the bottom.

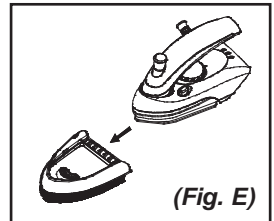

Directions

1. Unwrap the cord and fill the unit with water. (Reference *Filling with Water*)
Attach the Clothes Brush.
2. Plug the unit into a wall outlet. Set the temperature control knob to the max (••• linen/cotton) setting. The LED light will illuminate.
3. When the LED light goes out, it means the steamer reached the working temperature. The LED light will come on and go out regularly during steaming to indicate that the temperature control is working properly.
4. Once the working temperature has been reached the steam burst button can be used. Press the button firmly to deeply penetrate the fabric removing stubborn wrinkles and creases. **Note: There must be an interval of at least four (4) seconds between each press of the steam burst button.** (During the first use or if there has been an elapsed period of time since the last use, you may have to press the steam burst button a few times to initiate steam.)
5. Stand the iron in the heat rest position when rearranging clothing and while not in use (Fig F).
6. **The Steamer can operate vertically or horizontally.**
7. Except nylon, acrylics and similar material, all kinds of clothing and fabrics even hanging curtains and upholstery can be steamed.

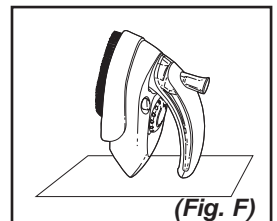

Cleaning & Storing Instructions

TO CARE, CLEAN AND STORE

1. After use, unplug the Iron/Steamer and allow it to cool down.
2. Once the appliance has cooled, press the water tank release button and remove the detachable handle/water tank.
3. Lift up the water tank plug and empty the water in the water tank. Replace all parts to their original positions.
4. Allow the appliance to cool down completely before cleaning.
5. After each use, clean the appliance with a damp cloth and wipe dry.
6. Press the handle lock button to storage position (**Fig. G**). Loop cord loosely around Iron/Steamer when storing.
7. Do not disassemble or repair your Travel Iron/Steamer yourself, call Customer Service at: **US: 1-800-989-3535 Canada: 1-888-676-7325.**

