

# User's Guide

# ORECK®

## Quest Pro Canister

### FC1000

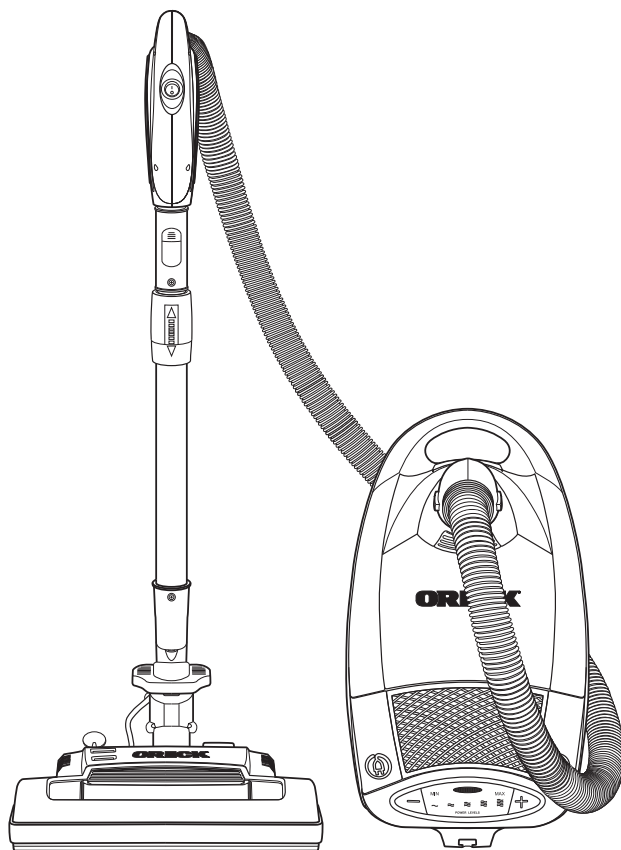

### Important!

Read this manual carefully, and keep for future reference.

## clean home

HEALTHIER. EASIER. SMARTER.®

# Enjoy

**Thank You** for purchasing an Oreck Quest™ Pro Canister! This state of the art vacuum cleaner will help you have a healthier clean home.



**ORECK**

At Oreck we understand that our customers are unique and expect superior service. To meet your needs, we offer different customer service options to work with your lifestyle and preferences.

**Welcome** to our **Call. Click. Visit.** customer service program. To speak with an Oreck representative call:

## Call



USA: **1•800•989•3535**  
Canada: **1•888•676•7325**

## Click



On the web, point and click at: **www.oreck.com** and click on “Locate A Store” in the top banner.

## Visit



Visit any of our Oreck Clean Home Centers. To find the nearest location, please call **888•oreck store (1•888•673•2578)**.

# Contents

<b>Safety</b> .....	<b>1</b>
General Warnings .....	1
Operation Warnings .....	1
Environment Warnings .....	2
Thermal Protector .....	3
<b>Parts</b> .....	<b>4</b>
<b>Assembly</b> .....	<b>5</b>
<b>Use</b> .....	<b>6</b>
ON/OFF Switch .....	6
Check Bag Indicator .....	6
Variable Suction Control .....	6
Connect Hose, Wand & Nozzle .....	7
Dirt Sensor .....	8
Power Nozzle Handle Positions .....	8
Floor Surface Selector .....	8
Brushroll .....	9
Carpet Height Adjustment & Indicator .....	9
Cleaning Tools .....	10
Attaching Tools .....	10
Cleaning Stairs .....	11
<b>Maintenance</b> .....	<b>12</b>
Check Bag Indicator .....	12
Filter Bag .....	13
Motor & Exhaust Filters .....	14
Replace Brushroll Belt .....	15
Replace Brushroll .....	18
Replace Headlight .....	19
Clearing Blockage .....	19
<b>Troubleshooting</b> .....	<b>21</b>
<b>Warranty</b> .....	<b>22</b>

## General Warnings

Read all instructions before using this vacuum cleaner



# IMPORTANT SAFETY INSTRUCTIONS

When using an electrical appliance, basic precautions should always be followed, including the following:

**WARNING!** To reduce the risk of fire, electric shock, or injury:

- The vacuum is intended for household use only.
- Use the vacuum only as described in this manual.
- Use only manufacturer's recommended attachments.

## Operation

# CAUTION!

- This appliance has powerful suction capability. Do not allow it to be used as a toy and always maintain close attention when used near children.
- Loose clothing, jewelry and long hair may become entangled in the suction of the vacuum and cause personal injury. Always keep loose clothing, jewelry, fingers and all parts of body away from openings.
- Use of the vacuum with an opening blocked may reduce air-flow. Keep all openings free of dust, lint, hair etc. Ensure the filter bag assembly is in place before use.
- Improper handling of the power cord may result in wiring, connection damage and potential sparking or shock. Always follow these instructions when handling the power cord:
  - Do not pull or carry the vacuum by the cord
  - Do not use the cord as a handle
  - Do not unplug the vacuum by pulling on the cord
  - Do not close a door on the cord
  - Do not pull the cord around sharp edges or corners
  - Keep the cord away from heated surfaces
  - Do not run the vacuum or other appliance over the cord

**Note:** A polarized plug has one rounded prong and one straight prong. The rounded end goes into the longest socket slot.

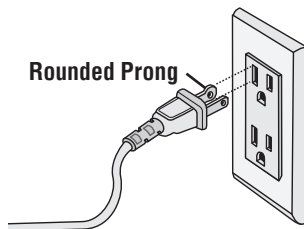

- A damaged cord or plug may cause a spark, shock and fire. Always grasp the plug, not the cord, when unplugging the vacuum. If the supply cord is damaged, it must be replaced by the manufacturer or its service agent or similarly qualified person in order to avoid a hazard.
- Always check the cord and plug before use. If appliance is not working as it should, has been dropped, damaged, left outdoors, or dropped into water, return it to a service center or call customer service at: **U.S.: 1-800-989-3535 Canada: 1-888-676-7325.**
- Do not use the vacuum without a motor protection filter installed.
- If abnormal noise, smell, smoke, breakage or other failure occurs during operation, you should turn off the switch and unplug it. Then contact customer service for repair. Do not attempt to repair it yourself.
- Unplugging the vacuum while the controls are ON may cause sparking and fire. Turn OFF all controls before unplugging. Do not leave appliance unattended when plugged in. Unplug from outlet when not in use and before servicing.

## Environment

### **WARNING!**

- Use of the vacuum outdoors or on wet surfaces may result in damage to the appliance and void the warranty. Do not use outdoors or on wet surfaces.
- Using the vacuum with wet hands and on wet surfaces may result in unexpected shock, slippage and personal injury. Do not handle the plug or appliance with wet hands or on wet surfaces.
- Use of the vacuum in an enclosed space containing flammable, explosive materials or toxic vapors may result in an unexpected spark or fire. Do not use the vacuum in such

an enclosed space. Always check exposed wiring and wire connections before use.

- Vacuuming burning or smoking objects, flammable or combustible liquids and toxic material may result in a fire and personal injury. Do not vacuum burning or smoking objects, flammable or combustible liquids.
- Use of the vacuum on stairs may cause imbalance, slippage or tumbling. Always check your balance and ensure your footing when cleaning on stairs.

## IMPORTANT

An internal thermal protector has been used in your vacuum to prevent overheating if a large item or clog gets caught in the nozzle or at the opening of the bag.

**When the blockage is not removed, the thermal protector will trip and vacuum will stop running.**

If this happens, turn the vacuum OFF and **disconnect vacuum from electrical outlet**. Then disconnect nozzle and remove obstruction. Within 30 minutes the thermal protector will cool and automatically reset. If vacuum does not operate, allow additional time for thermal protector to reset.

**Note:** The canister must remain unplugged during the 30 minute cooling period.

# SAVE THESE INSTRUCTIONS

# Parts

## Product Components & Accessories

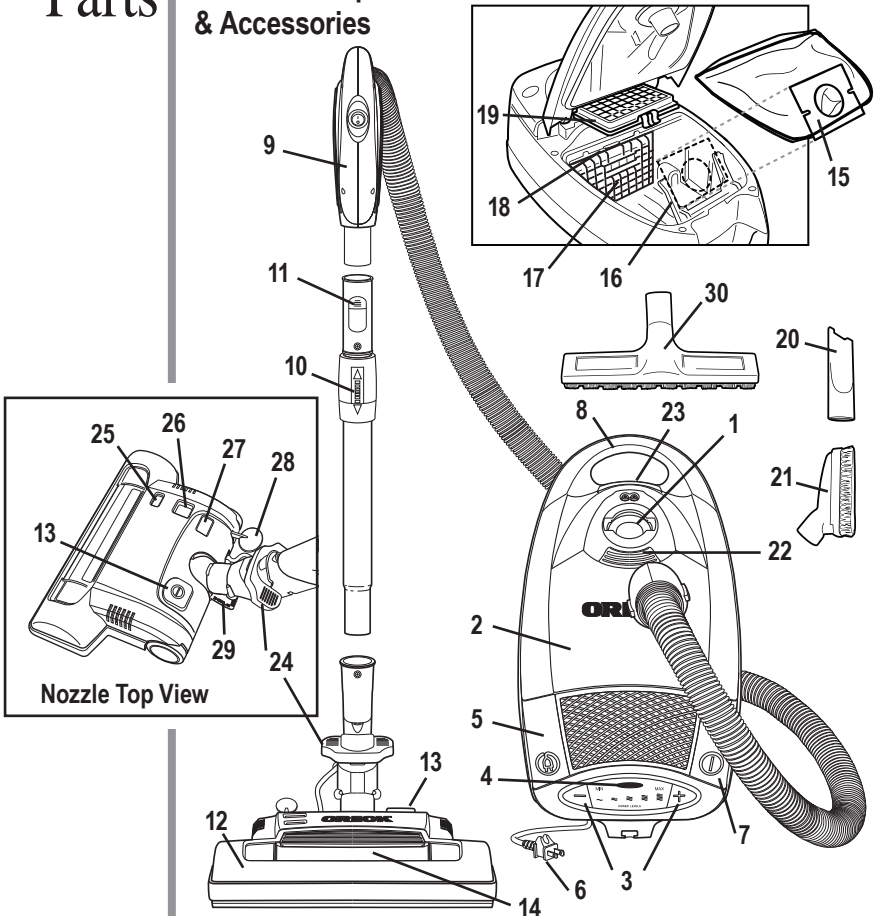

- |                                 |                              |
|---------------------------------|------------------------------|
| 1. Intake                       | 16. Bag Dock                 |
| 2. Top Cover                    | 17. Motor Filter Grill       |
| 3. Variable Suction Control     | 18. Motor Filter             |
| 4. Bag Full Indicator           | 19. Hepa Media Filter        |
| 5. Cordwinder Pedal             | 20. Crevice Tool             |
| 6. Power Cord                   | 21. Combination Tool         |
| 7. Power ON/OFF Pedal           | 22. Tool Lid Latch           |
| 8. Carrying Handle              | 23. Bag Lid Latch            |
| 9. Handle with Hose             | 24. Nozzle Release Latch     |
| 10. Telescopic Wand             | 25. Overload Protector Reset |
| 11. Wand Release Latch          | 26. Carpet Height Indicator  |
| 12. Carpet & Floor Power Nozzle | 27. Dirt Sensor              |
| 13. Brushroll ON/OFF switch     | 28. Carpet Height Adjustment |
| 14. Headlight                   | 29. Handle Position Release  |
| 15. Disposable Filter Bag       | 30. Hard Floor Tool          |

# Assembly

## Assembling the Oreck Quest™ Pro Canister

1. Connect hose by firmly inserting end of hose into canister intake opening.
2. Firmly press handle nozzle into telescopic wand until it locks in place.
3. Insert telescopic wand into power nozzle until button locks.
4. Extend telescopic wand by holding telescopic wand length adjustment and pulling power handle.

Note: Accessory tools can be used with the telescopic wand or handle alone.

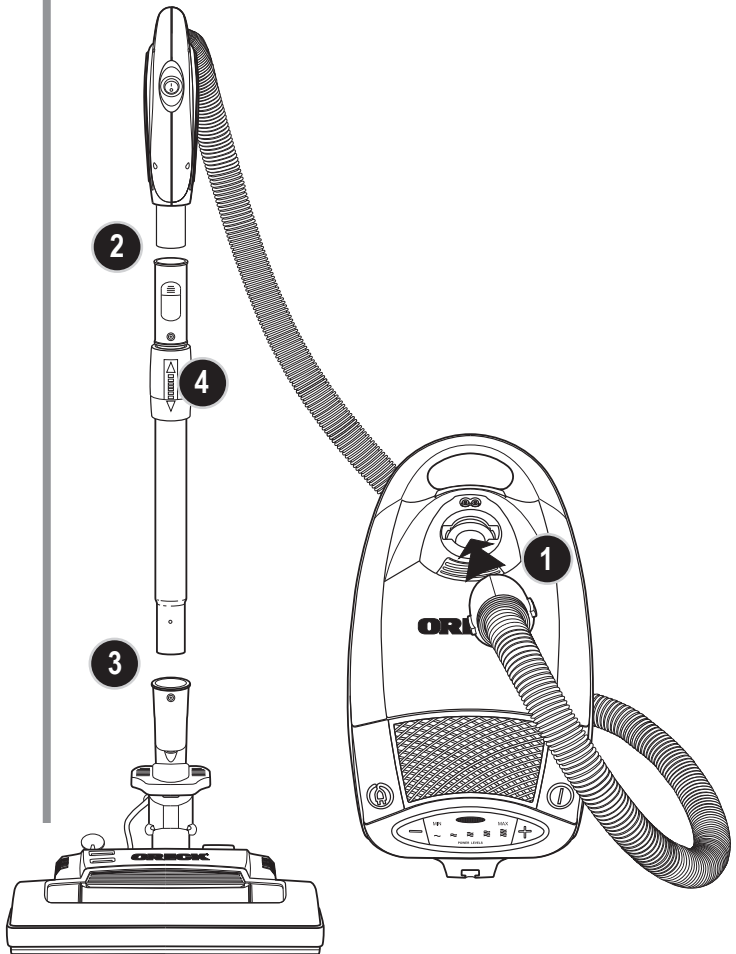



# Use

## ON/OFF Switch

- After assembling vacuum, plug the cord into an electrical outlet. Turn the vacuum ON by pressing the ON/OFF pedal (A). To turn vacuum OFF press the pedal again.

**NOTE:** The Cord Winder Pedal (B) is on the other side.

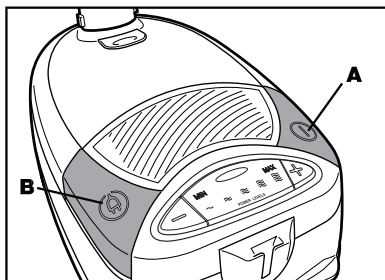

## Check Bag Indicator

- When the indicator light comes on, open the canister and check the filter bag. See page 13 for details and instructions on how to replace a filter bag.

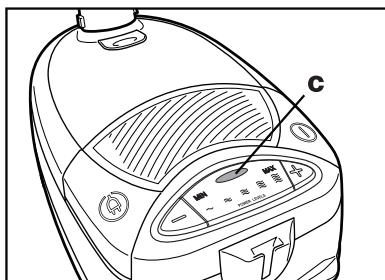

## Variable Suction Control

- The variable suction control (D) is located on the top rear of the canister.
- Push the (-) button to reduce suction and to clean lightly soiled areas or delicate fabrics. Push the (+) button for maximum cleaning power in heavily soiled areas.

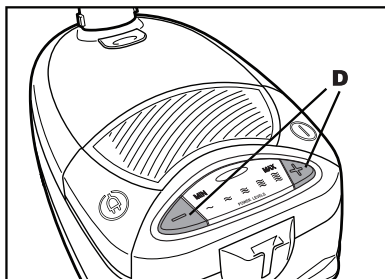

## Connect Hose

- With hose toward rear of the vacuum, push hose connector into opening in the bag lid.

**Note:** The flexible hose contains electrical wires for connection to the power nozzle and should not be used if damaged. The wires should not be visible through the outer skin.

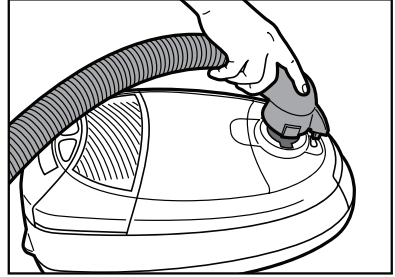

## Connect Hose Handle to Wand

- Attach the hose to the telescopic wand by pushing the handle (E) down into wand until the Handle Release button (F) locks the handle into place.

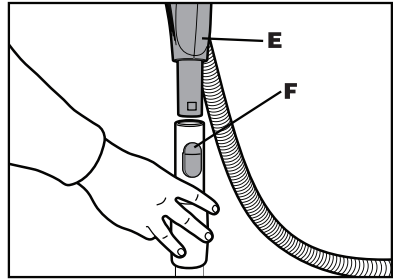

## Connect Wand to Nozzle

- Attach the wand to power nozzle by fitting the button on the wand (G) into nozzle connector opening (H). Be sure nozzle is locked in place.
- To release, press down on the wand release pedal (I) and remove the wand.

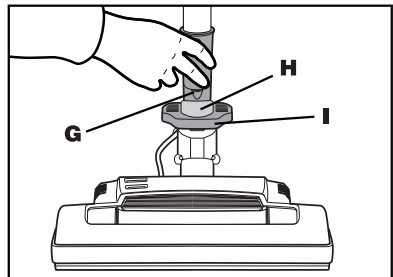

## Dirt Sensor

- The Dirt Sensor will turn red (J) when the power nozzle is detecting and picking up dirt. The light will turn green when no dirt is detected.

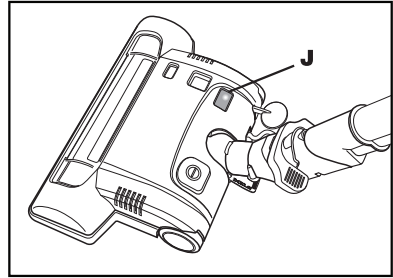

## Power Nozzle Handle Positions

- The handle has two positions when used with the power nozzle: upright and operating.
- The handle is locked when in the upright position.
- To lower handle to operating position, press the Handle Release pedal (K) on the back of the power nozzle and pull the handle back.

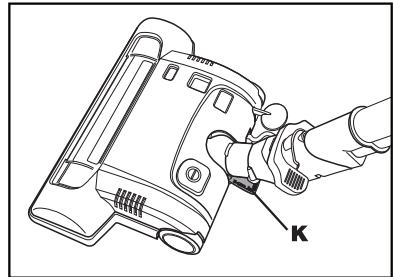

## Floor Surface Selector

### • Carpet and Rug

- When using the power nozzle for carpet and rug cleaning, push the floor surface selector switch to “ON” (L). This setting provides the suction and brushroll action necessary to deep clean carpets.

**NOTE:** The surface selector switch must be in the “OFF” position before turning the vacuum on.

### • Hard Surfaces

- The power nozzle can be used for cleaning hard surfaces such as wood, linoleum, vinyl, rubber, tile, sealed cork, and terrazzo.

**IMPORTANT:** Follow flooring manufacturer’s recommendations for cleaning.

- To set the power nozzle for hard surfaces, push the floor surface selector switch to “OFF” (L). This setting provides suction and no brushroll action.

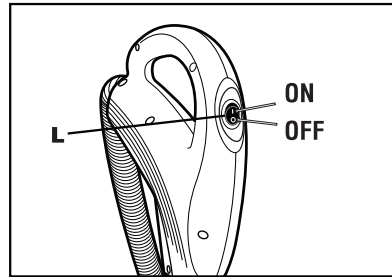

## Brushroll

- The Brushroll Foot Switch is located on top of the Power Nozzle (M). Both switches must be turned on to activate the agitator brushroll.
  - Floor Surface Selector Switch (L)
  - plus -
  - The Brushroll Foot Switch (M)

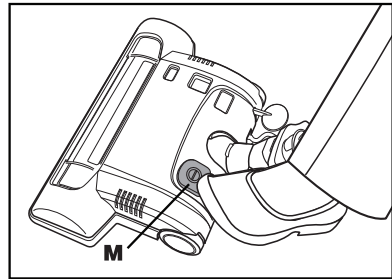

## Carpet Height Adjustment & Indicator

- The power nozzle has a carpet height adjustment. The indicator (O) shows what the nozzle is set on. There are 6 levels. Number 1 is used for short pile carpet and 6 is for deep pile. Press the pedal to adjust nozzle height up or down. (N)

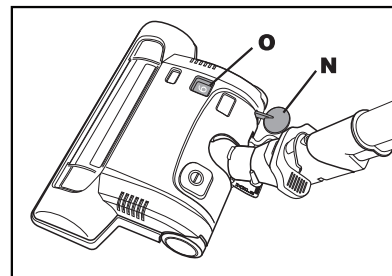

## Cleaning Tools

- The cleaning tools are conveniently stored in the vacuum underneath the tool lid (P). Push the tool lid release latch to open (Q).

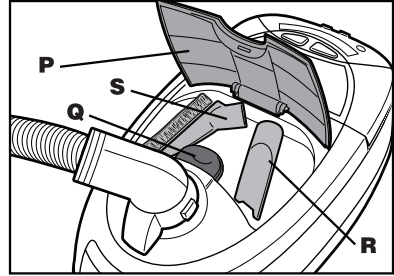

- The cleaning tools have many uses. Select the tool best suited for the cleaning task from the following descriptions.
- Crevice tool (R)** may be used in tight spaces, corners and along edges in such places as dresser drawers, upholstered furniture, stairs and baseboards.
- Combination Tool (S)** may be used for books, lamps, lighting fixtures, venetian blinds, baseboards, shutters and registers. It may also be used for upholstered furniture, draperies, tapestries, and mattresses. Slide the Combination tool apart to remove the brush. (U) With the brush removed, the Combination tool may be used for small smooth surfaces.
- Hard Floor Tool (T)** may be used for hard floors or other large smooth surfaces.

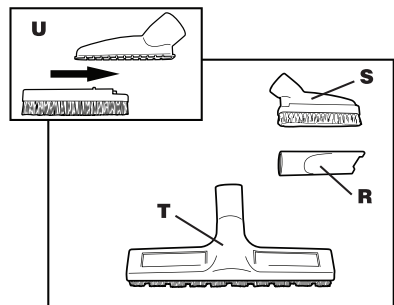

## Attaching Tools

- Tools may be attached directly to the handle or to the wand. Firmly push tool onto the handle or wand. Twist tool slightly to tighten or loosen connection.

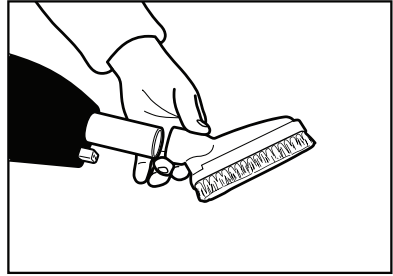

## Cleaning Stairs

- Clean stairs by placing vacuum on end. Clean stairs from bottom to top.

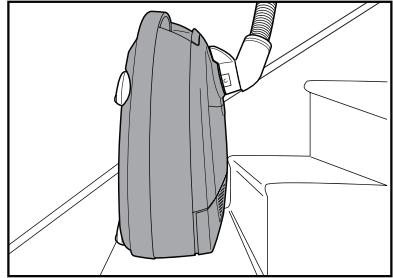

# Maintenance



## ⚠ WARNING!

- Performing maintenance on the vacuum while it is plugged into a wall outlet may result in unexpected vacuum operation, shock and personal injury. Always turn the vacuum OFF and unplug before performing inspection and maintenance.
- If the power cord is damaged, it should only be replaced by the factory or maintenance center or similarly qualified person.

### Bag Full Indicator

- The Bag Full Indicator light (C) will turn red when the bag fills with dirt. There are three conditions that will cause the indicator light to come on:
  1. The bag is full; change the bag.
  2. Very fine material (such as powder) have been picked up, clogging the bag pores; change the bag, even if it is not full.
  3. There is a blockage in the nozzle, hose, tools or at the bag opening; remove the blockage.

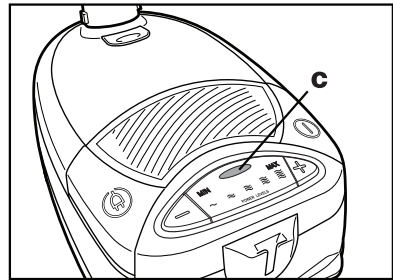

**NOTE:** The bag full indicator is designed to notify the user when the filter bag is full. If the filter bag is full of pet hair, carpet fibers, etc., the bag full indicator may not light up due to sufficient air flow of the filter bag. Discard the used filter bag and replace with a new one.

**CAUTION:** The bag full indicator may come on when picking up fine materials, such as powder, flour or cornstarch. These materials may seal the pores of the filter bag and cause the filter bag to burst even though the filter bag is only partially full of dirt. It is recommended to change the filter bag more often when removing this type of material.

# Maintenance

- continued

## Filter Bag

- Check the filter bag when the bag full indicator light turns red.
- When the filter bag is filled with dirt, the vacuum will not operate efficiently.
- Discard the used filter bag and replace it with a new one.

## Replacing the Filter Bag

To keep your vacuum operating at maximum efficiency, change the filter bag frequently or when the bag full indicator comes on.

### Open the Vacuum

- Rotate hose to the side, lift bag lid latch and open the lid.

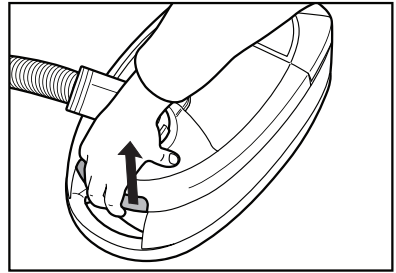

### Remove Bag

- Before removing the filter bag, pull the tab on the bag collar (A). This will seal the bag.
- Remove the filter bag by raising up on the bag dock and carefully pulling the bag upward and out of the bag dock (B).

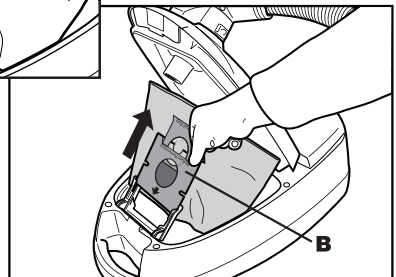
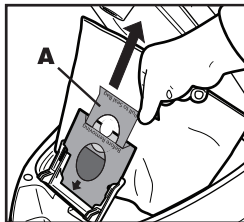



### Install New Bag

- Slide the bag collar firmly into bag dock.

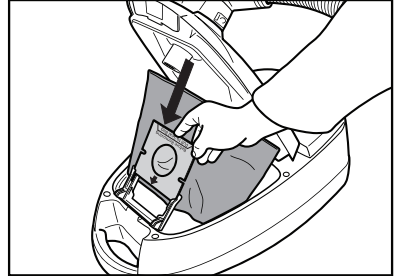

### Complete the Installation

- Push rear edge of bag into the bag cavity. Make sure it is all the way down in the bag cavity (C).
- Close bag lid.

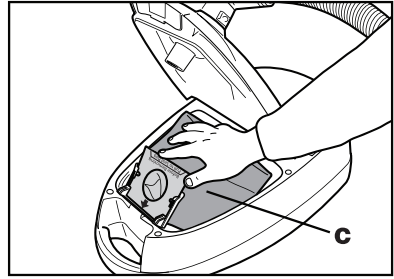

**NOTE:** The canister bag lid will not close without a filter bag in place.

### MOTOR AND EXHAUST FILTERS

#### Removing and Cleaning the Motor Filter

- The motor filter is located behind the grill in the bag compartment. It protects the motor from dirt particles. If the filter become dirty, pull off grill and lift out filter.



**ALWAYS DISCONNECT  
VACUUM FROM  
ELECTRICAL OUTLET  
BEFORE STARTING  
THIS PROCEDURE!**

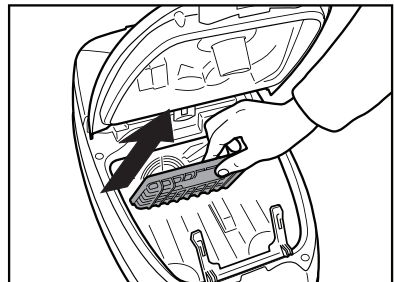

## Maintenance - continued

- Wash filter in warm water or replace it with a new one. The filter must be completely dry before it is put back into the vacuum.

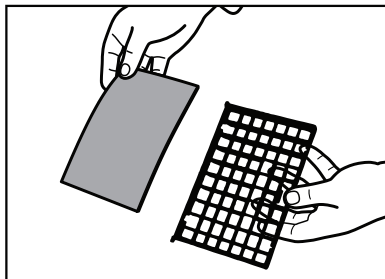

**DO NOT** operate without a motor filter in place.

### Replace the Hepa Media Filter

- The Hepa Media Filter aids in the filtration process to return clean air to the room.
- To remove this filter, open bag lid, unsnap the filter latch and pull the filter out. Replace with a new filter.

**NOTE:** The filter should be replaced annually.

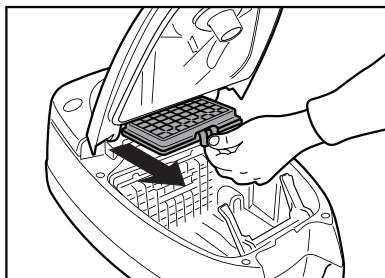

### REPLACING THE POWER NOZZLE BELT

- The belt in your power nozzle drives the brushroll. It has been designed specifically for use in this vacuum and is important for effective operation.
- The belt should be checked on a regular basis to ensure it is in good condition. Replace the belt if it is stretched, cut or broken.
- Use the following procedure to check or replace the belt.

### Remove Nozzle Hood Screws

- Disconnect power nozzle from extension wand.
- To remove hood, turn nozzle over and unscrew the 7 recessed phillips head screws (A).

# Maintenance - continued



Step 1

**ALWAYS DISCONNECT  
VACUUM FROM  
ELECTRICAL OUTLET  
BEFORE STARTING  
THIS PROCEDURE!**

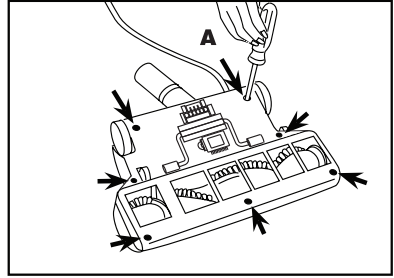

## Remove Nozzle Hood

- Turn the nozzle upright and lift the hood off (B).

Step 2

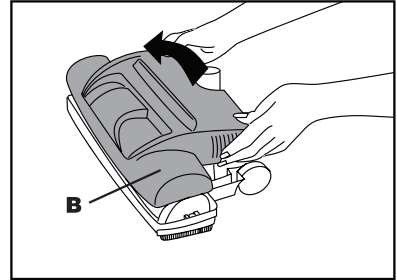

## Remove Brushroll Cover

- Remove brushroll cover (C) by removing the 2 phillips head screws.

Step 3

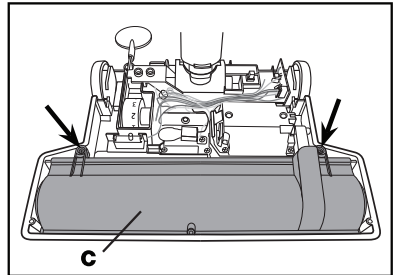

- Lift brushroll cover off (C).

Step 4

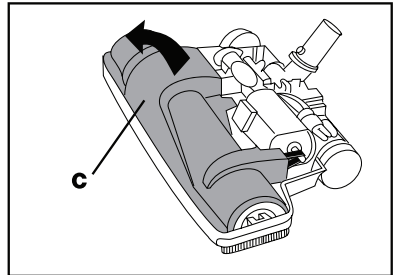

# Maintenance

- continued

## Check/Remove Belt

- If belt is not broken but is stretched or cut, pull it off the motor pulley (D).

### Step 5

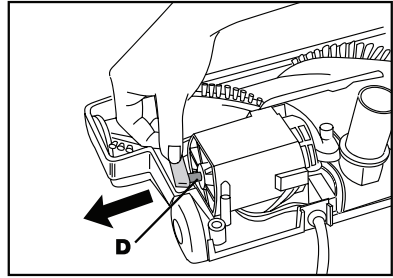

## Remove/Replace Belt

- Lift up the end of the brushroll. Remove the old belt from the brushroll pulley (E) and replace with a new belt. The lettering on the belt must be visible. (Lettering should be facing out.)
- Stretch the belt and attach to the motor pulley.

### Step 6

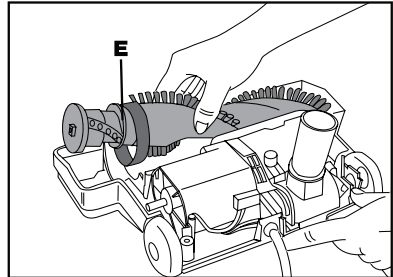

## Replace Brushroll

- Hold the opposite end of brushroll in place. Push the belt end forward and down while rotating the end plate (F) until it slides into place. Turn the brushroll, making sure it rotates freely.

### Step 7

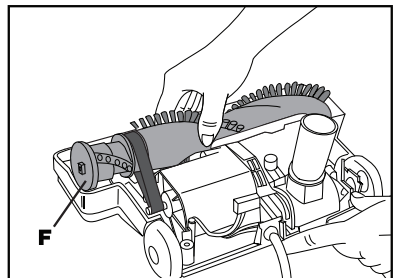

# Maintenance - continued

## Replace Brushroll Cover

- Place brushroll cover back over the brushroll.
- Replace the two cover screws.

### Step 8

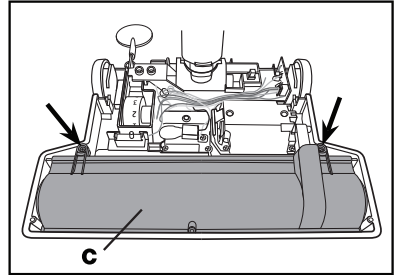

## Replace Nozzle Hood

- The wand must be in the upright locked position.
- Position the hood on top of nozzle base. Make sure wires and buttons are aligned. Do not force the hood on.
- Turn the nozzle over.
- Replace the seven screws for the hood. *See Step 1.*

### Step 9

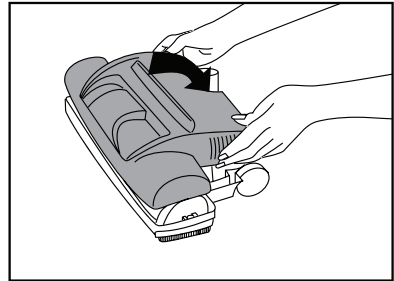

## When to Replace the Brushroll

- When brushroll bristles are worn, the brushroll should be replaced.
- To check condition of the bristles, hold a card on the bottom plate while turning the brushroll. Replace the brushroll if bristles do not touch the card.



**ALWAYS DISCONNECT  
VACUUM FROM  
ELECTRICAL OUTLET  
BEFORE STARTING  
THIS PROCEDURE!**

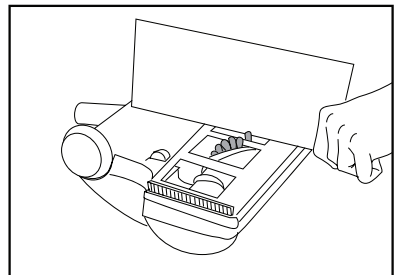

# Maintenance - continued

## How to Replace the Brushroll

### DISCONNECT VACUUM FROM ELECTRICAL OUTLET!

1. Remove hood, brushroll cover, belt and brushroll. *See Steps 1-6.*
2. Discard the old brushroll.
3. Install the new brushroll and belt. *See Steps 7-9.*

## How to Replacing the Headlight

- The headlight is located inside of the power nozzle. The light is on whenever the vacuum is turned on.
1. Disconnect power nozzle from the extension wand.
  2. Remove the hood. *See Steps 1-2.*
  3. Pull the old bulb from the socket to remove. Push the new bulb into socket.
  4. Replace the hood. *See Steps 9 & 1.*



**ALWAYS DISCONNECT  
VACUUM FROM  
ELECTRICAL OUTLET  
BEFORE STARTING  
THIS PROCEDURE!**

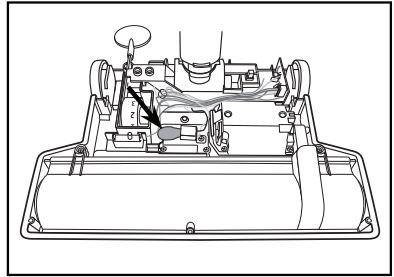

## How to Clear Blockages

- Low suction or pick up may be due to a blockage in the system. Refer to the following steps to check for blockages, continuing with each step until the blockage is found.

## Hose/Wand Blockage

- Disconnect power nozzle and wand from handle.
- Plug vacuum in and turn it on. Check the hose end for suction. Remove any obstructions.

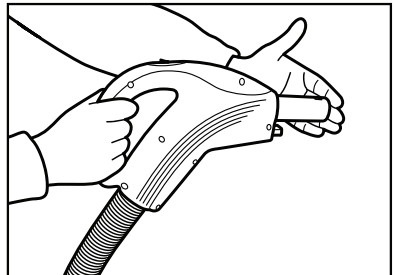

# Maintenance

- continued

- If there is no blockage in the hose. Remove the power nozzle from wand and attach wand to hose. Check for suction and remove any blockages.

## Nozzle Blockage

- If the nozzle becomes clogged, use the following procedures to check for and clear the blockage.
- If blockage is severe enough the nozzle will shut off. After the blockage is cleared you must push the **Overload Protection Reset** button (A) before the nozzle will operate again.

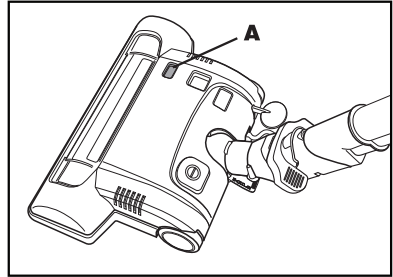

- Make sure power nozzle is disconnected from wand. Then check for blockage in nozzle connection (B).

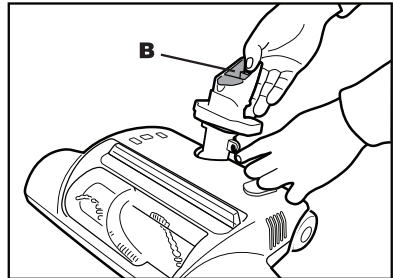

- There is an additional panel on the bottom of the nozzle (C). This opening provides a secondary place to check and clear blockage.

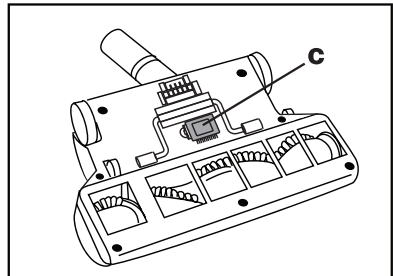

# Trouble-shooting

Service problems that appear to be major can often be solved easily. You can be your own troubleshooter by reviewing this guide.

**All other servicing should be done by an Oreck authorized service center.**

## ***SAVE SERVICE CALLS...CHECK THESE FIRST:***

- Is the filter bag full?
- Are the pores of filter bag clogged with powder or dust?
- Is the hose, wand, power nozzle or accessories clogged?

<b>Problem</b>	<b>Check</b>	<b>Solution</b>
Vacuum does not turn ON.	<ul style="list-style-type: none"> <li>• Power Cord</li> <li>• Power Source</li> <li>• Hose Connection</li> <li>• Thermal Protector</li> </ul>	<ul style="list-style-type: none"> <li>• Plug in Power Cord. Make sure it is firmly into the wall outlet.</li> <li>• If no power to outlet, check power source, fuse or circuit breaker.</li> <li>• Make sure the hose is securely connected.</li> <li>• Allow vacuum to cool per instructions. <i>See Page 3.</i></li> </ul>
Vacuum has little or no suction.	<ul style="list-style-type: none"> <li>• Filter Bag</li> <li>• Motor Filter</li> <li>• Hose, wand or accessories may be clogged.</li> <li>• Hose Connection</li> </ul>	<ul style="list-style-type: none"> <li>• Filter bag may be clogged or full. Check and replace if necessary. <i>See Page 13.</i></li> <li>• May be dirty or clogged. Clean or replace if necessary. <i>See Page 14.</i></li> <li>• Clear obstruction. <i>See Page 19.</i></li> <li>• Make sure hose is properly connected.</li> </ul>
Power nozzle won't turn ON.	<ul style="list-style-type: none"> <li>• Hose Power Cord</li> <li>• Belt</li> <li>• Switches</li> <li>• Thermal Protector</li> </ul>	<ul style="list-style-type: none"> <li>• May not be properly connected. Plug hose firmly into receptacle on nozzle.</li> <li>• Belt may be worn or broken. Check and replace if necessary. <i>See Page 15.</i></li> <li>• Make sure surface selector switch and/or brushroll switch are both on. <i>See Page 3.</i></li> <li>• Allow vacuum to cool per instructions. <i>See Page 3.</i></li> </ul>
Vacuum still does not operate properly.	Review all the above	Contact Oreck for service.



# Warranty

**ORECK MANUFACTURING COMPANY:** (Oreck Manufacturing Company gives you the following limited warranty for this product only if it was originally purchased for residential use, not for resale, from Oreck or an Oreck Authorized Retail Dealer.)

Oreck will repair or replace, free of charge, to the original purchaser, any part that is found to be defective in material or workmanship within three (3) years following the date of purchase for all residential models.

This limited warranty does not cover the replacement of expendable or consumable parts such as filters, cartridges, and other parts subject to normal wear unless they are defective in material or workmanship.

This limited warranty does not apply to any part subjected to accident, abuse, commercial use, alteration, misuse, damage caused by an act of God, the use of voltages other than on the data plate of this product or service of this product by other than Oreck or a participating Factory Authorized Service Center.

Oreck does not authorize any person or representative to assume or grant any other warranty obligation with the sale of this product.

Oreck's limited warranty is valid only if you retain proof of purchase from Oreck or an Oreck Authorized Retail Dealer for this product. If you purchase this product from any other source, your purchase is "AS IS," which means Oreck grants you no warranty, and that you, not Oreck, assume the entire risk of the quality and performance of this product, including the entire cost of any necessary servicing or repairs of any defects.

Oreck's liability for damages to you for any costs whatsoever arising out of this statement of limited warranty shall be limited to the amount paid for this product at the time of original purchase, and Oreck shall not be liable for any direct, indirect, consequential or incidental damages arising out of the use or inability to use this product. Some states do not allow the exclusion or limitation of incidental or consequential damages, so the above limitation or exclusion may not apply to you.

**ALL EXPRESS AND IMPLIED WARRANTIES OTHER THAN THE LIMITED WARRANTY SET FORTH ABOVE, FOR THIS PRODUCT, INCLUDING IMPLIED WARRANTIES OF MERCHANTABILITY AND FITNESS FOR A PARTICULAR PURPOSE ARE EXPRESSLY DENIED.**

This warranty gives you specific legal rights, and you may also have other rights which vary from state to state.







**ORECK®**

©2010 Oreck Holdings, LLC.

All rights reserved. All marks, text, logo's, product configurations and registered trademarks are owned and used under the authority of Oreck Holdings, LLC.

**82329-02 REV A 09/10 ECN R-10179**