

ORION

17" PERFECT PURE FLAT MONITOR

USER'S GUIDE
MODEL NO.: 7V764

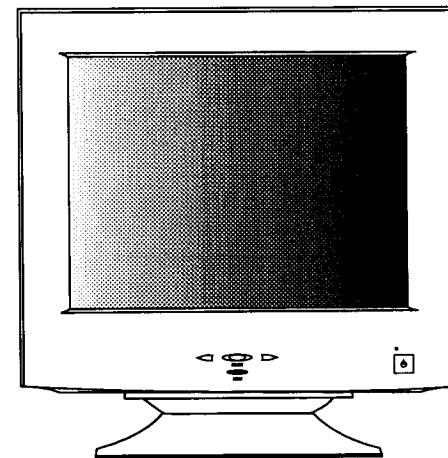

Printed in Korea

BEFORE USING THIS COLOR MONITOR,
READ AND OBSERVE ALL OF THIS USER'S GUIDE.

P/N: M39M0000

CONTENTS

SAFETY INSTRUCTION	2
CAUTIONS	4
FCC RF INTERFERENCE STATEMENT	5
INSTALLATION	6
RESOLUTION	7
CONTROLS AND FUNCTIONS	8
REAR VIEW	14
SPECIFICATIONS	15
TROUBLE SHOOTING GUIDE	16
WICHTIGE HINWEISE (GERMAN)	17



This Monitor was
Manufactured by ISO 9001
Certified Factory

SAFETY INSTRUCTION

1. Read all of these instructions.
2. Save these instructions for later use.
3. Follow all warnings and instructions marked on the product.
4. Unplug this product from the wall outlet before cleaning.
Do not use liquid cleaners or aerosol cleaners. Use a dry cloth for cleaning.
5. Do not use this product near water.
6. Do not place this product on an unstable cart, stand or table.
The product may fall, causing serious damage to the product.
7. Slots and openings in the cabinet and the back or bottom are provided for ventilation: to ensure reliable operation of the product and to protect it from overheating these openings must not be blocked by placing the product on a bed, sofa, rug or other similar surface. This product should never be placed near or over a heat register.
This product should not be placed in a built-in installation unless proper ventilation is provided.
8. This product should be operated from the type of power source indicated on the marking label. If you are not sure of the type of power available, consult your dealer or local power company.
9. This product is equipped with a 3 wire grounding type plug having a third(grounding) pin. This is a safety feature. If you are unable to insert the plug into the outlet, contact your electrician to replace your obsolete outlet. Do not defeat the purpose of the grounding-type plug.
10. Do not allow anything to rest on the power cord.
Do not locate this product where persons will walk on the cord.
11. If an extension cord is used with this product, make sure that the total of the ampere ratings on the products plugged into the extension cord do not exceed the extension cord ampere rating. Also, make sure that the total of all products plugged into the wall outlet does not exceed 15 amperes.
12. Never push objects of any kind into this product through cabinet slots as they may touch dangerous voltage points or short out parts that could result in a risk of fire or electric shock. Never spill any kind of liquid on the product.
13. Do not attempt to service this product yourself, as opening or removing covers may expose you to dangerous voltage points or other risks.
Refer all servicing to service personnel.

SAFETY INSTRUCTION

14. Unplug this product from the wall outlet and refer servicing to qualified service personnel under the following conditions.
- A. When the power cord or plug is damaged or frayed.
 - B. If liquid has been spilled into the product.
 - C. If the product has been exposed to rain or water.
 - D. If the Product does not operate normally when the operating instructions are followed. Adjust only those controls that are covered by the operating instructions since improper adjustment of other controls may result in damage and will often require extensive work by a qualified technician to restore normal operation.
 - E. If the product has been dropped or the cabinet has been damaged.
 - F. If the product exhibits a distinct change in performance, indicating a need for service.

▶▶ CAUTION

The power supply cord is used as the main disconnect device, ensure that the socket-outlet is located/installed near the equipment and is easily accessible.

▶▶ ATTENTION

Le cordon d'alimentation est utilisé comme interrupteur général. La prise de courant doit être située ou installée à proximité du matériel et être facile d'accès

CAUTION TO SERVICE PERSONNEL

POWER SUPPLY CORD IS USED AS MAIN POWER DISCONNECT DEVICE IN THIS PRODUCT. UNPLUG THIS PRODUCT FROM THE WALL OUTLET BEFORE REMOVING THE BACK COVER AND SERVICING

EMISSION CHARACTERISTICS TESTED BY SEMKO

THIS PRODUCT HAS BEEN TESTED AND HAS SHOWN COMPLIANCE WITH THE NATIONAL SPECIFICATIONS SUCH AS SWEDISH MPR 1990.10.(MPR I)

CAUTIONS

▶ NEVER REMOVE THE BACK COVER

Removal of the back cover should be carried out only by qualified personnel. This display monitor contains high voltage inside.

▶ DO NOT USE IN HOSTILE ENVIRONMENTS

To prevent shock or fire hazard. Do not expose the unit to rain or moisture. This unit is designed to be used in the office or home. Do not subject the unit to vibrations, dust or corrosive gases.

▶ KEEP IN A WELL VENTILATED PLACE

Ventilation holes are provided on the cabinet to prevent the temperature from rising. Do not cover the unit or place anything on the top of unit. Ventilation holes are provided also on the bottom of the cabinet.

▶ AVOID HEAT

Avoid placing the unit in direct sunshine or near a heating appliance.

▶ BE CAREFUL OF MAGNETIC FIELDS

Do not place a magnet, speaker system, floppy disc drive or anything which will generate magnetism near the unit. A magnetic field may cause blurred colors or distortion of the displayed pattern.

▶ TO ELIMINATE EYE FATIGUE

Do not use the unit against a bright back ground and where sunlight or other light sources will shine directly on the monitor.

▶ BE CAREFUL OF HEAVY OBJECT

Neither the monitor itself nor any other heavy object should rest on the power cord. Damage to a power cord can cause fire or electrical shock.

FCC RF INTERFERENCE STATEMENT

▶▶ NOTE :

This equipment has been tested and found to comply with the limits for a Class B digital device, pursuant to Part 15 of the FCC Rules. These limits are designed to provide reasonable protection against harmful interference in a residential installation.

This equipment generates, uses and can radiate radio frequency energy and, if not installed and used in accordance with the instructions, may cause harmful interference to radio communications. However, there is no guarantee that interference will not occur in a particular installation.

If this equipment does cause harmful interference to radio or television reception which can be determined by turning the equipment off and on, the user is encouraged to try to correct the interference by one or more of the following measures.

- Reorient or relocate the receiving antenna.
- Increase the separation between the equipment and receiver.
- Connect the equipment into an outlet on a circuit different from that to which the receiver is connected.
- Consult the dealer or an experienced radio, TV technician for help.
- Only shielded interface cable should be used.

Finally, any changes or modifications to the equipment by the user not expressly approved by the grantee or manufacturer could void the users authority to operate such equipment.

▶ DOC COMPLIANCE NOTICE

This digital apparatus does not exceed the Class B limits for radio noise emissions from digital apparatus set out in the radio interference regulation of Canadian Department of Communications.

▶ AVIS DE CONFORMATION AU MDC(DOC)

Le présent appareil numérique n'émet pas de bruits radio-électriques dépassant les limites appliqués aux appareils numériques de Class B d'après les règlements sur le brouillage radio-électrique conçu par le ministère des communications du Canada.

INSTALLATION

NO TOOLS ARE REQUIRED TO INSTALL THE MONITOR. SIMPLY FOLLOW THE INSTRUCTIONS OUTLINED IN THE FOLLOWING PAGE.

1. INSTALLING THE TILT/SWIVEL STAND

- A. Align the stand with the front slots in the bottom of the monitor and insert the Tilt/Swivel Stand into the slots.
- B. Push the Tilt/Swivel Stand firmly toward the front of the monitor until the latches click into the locked position.

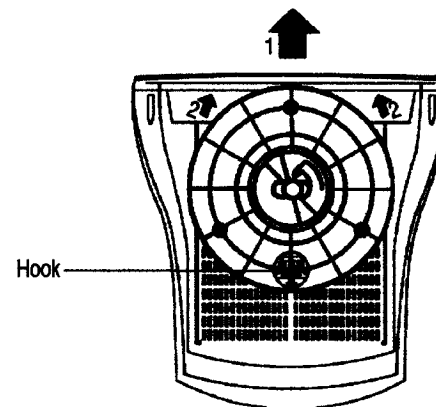

2. CONNECT THE SIGNAL CABLE

- A. Connect the end into the graphic card on back of the computer.
- B. Secure the connection with the screws on the plug.

3. CONNECT THE POWER CORD

- Connect the female end of the power cord to the power input receptacle on the back panel of the monitor.
Then, plug the male end of the power cord to an AC outlet or computer.

4. TURN THIS MONITOR ON AND START YOUR SYSTEM

RESOLUTION

1. RECOMMENDED SIGNAL TIMING CHART

Resolution	Horizontal Frequency(KHz)	Vertical Frequency(Hz)	Clock Frequency(MHz)	Poles (H / V)
IBM(640×350)	31.469	70.087	28.322	(+ / -)
IBM(720×400)	31.469	70.087	28.322	(- / +)
IBM(640×480)	31.469	59.941	25.175	(- / -)
VESA(640×480)	43.269	85.008	36.000	(- / -)
VESA(800×600)	37.789	60.317	40.000	(+ / +)
VESA(800×600)	46.875	75.000	49.500	(+ / +)
VESA(800×600)	53.674	85.061	56.250	(+ / +)
VESA(1024×768)	48.363	60.004	65.000	(- / -)
VESA(1024×768)	68.677	84.997	94.500	(+ / +)
VESA(1280×1024)	63.981	60.020	108.000	(+ / +)

It has 10 user setting modes which you can store except for factory setting mode. Displaying user mode except for factory setting modes, please adjust the monitor screen for yourself. After that, the screen data is stored to the memory with in micro processor.

2. THE WAY OF ADJUSTMENT

When you want to adjust the screen, please refer to function of controls. Those screen data are automatically stored to the memory with in micro processor.

CONTROLS AND FUNCTIONS

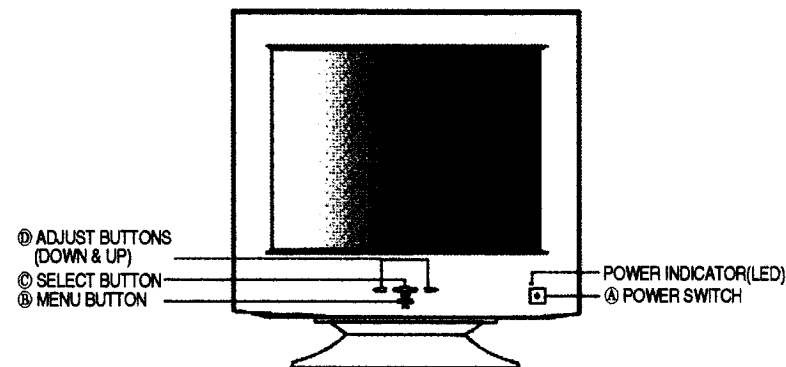

A. POWER ON/OFF (Ⓞ)

Turns the power ON or OFF. There will be a few seconds delay before the display appears. The power LED(next to the power switch) lights when the power is turned ON. The power is turned off by pressing the power switch again and the power LED goes out.

B. MENU

Activates and exits the On Screen Display (OSD).

The button can also be used to move previous menu or status.

There are three OSD menus or status.

They are USER CONTROL(H-POSITION, V-POSITION, H-SIZE, V-SIZE, PINCUSHION, BRIGHTNESS, CONTRAST, COLOR TEMPERATURE, COLOR CONTROL, VIDEO LEVEL, ZOOM, DEGAUSS, INFORMATION, LANGUAGE, RECALL, EXIT),
 SUB MENU 1 (TRAPEZOID, PARALLELOGRAM, PINBALANCE, TOP CORNER CORRECTION, BOTTOM CORNER CORRECTION, EXIT) and
 SUB MENU 2 (H-MOIRE, V-MOIRE, OSD H-POSI, OSD V-POSI, ROTATE, EXIT).

CONTROLS AND FUNCTIONS

USER CONTROL (activates when you press the Menu button)

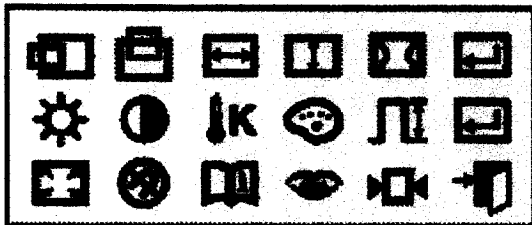

SUB MENU1 (activates when you press the select button after choosing "SUB MENU1" via the adjust (▼/▲) button)

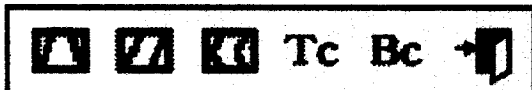

SUB MENU2 (activates when you press the select button after choosing "SUB MENU2" via the adjust (▼/▲) button)



C. SELECT

The select button allows user to activate the desired adjustment with changing icon-color.

D. ADJUST (▼ ▲)

The Adjust button allows user to choose the icons(controls)in the menu. Pressing the adjust button "▼" or "▲" will step through all available adjustment icons(controls).

In addition this adjust button can be used to adjust the icons(controls) that is selected and activated via the select button.

Press the Adjust button.

After completing all the desired adjustments, the On Screen Display will disappear with pressing the menu button.

CONTROLS AND FUNCTIONS

1. SELF-TEST DISPLAY

When there is no signal input(No connection), the On Screen Display will show.

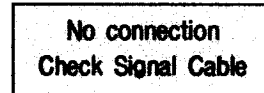

2. AUTO REGISTRATION

This monitor has 10 preset modes. If the current video is one of the preset modes, the monitor will automatically store any custom display settings into the permanent memory.

There are also 10 user modes that allow you to save the custom display settings made to any video mode that is not one of the preset video modes.

Adjustments are automatically registered without pressing any buttons.

Up to 10 user modes are stored automatically on a "First-In-First-Out" basis.

3. OSD MENU DESCRIPTION

USER CONTROL

 **H. POSITION(Horizontal position)**
Moves images horizontally on-screen left(▼) or right(▲).

 **V. POSITION(Vertical position)**
Moves images vertically on-screen up(▲) or down(▼).









 **H. SIZE(Horizontal Size)**
Increase(▲) or decrease(▼) Size of image horizontally.

 **V. SIZE(Vertical Size)**
Increase(▲) or decrease(▼) Size of image Vertically.







 **PINCUSHION**
Adjust the side Pin-cushion or barrelling.

 **SUB MENU 1**
Display Sub Menu 1.

CONTROLS AND FUNCTIONS

-  **BRIGHTNESS**
Increase or decrease the intensity(illumination) of the image.
-  **CONTRAST**
Increase or decreases the strength(lightness or dimness) of the image.
-  **COLOR TEMPERATURE**
Adjust the color-temperature.
If select the icon of color-temperature, the control menu panel of color-temperature is displayed.
Select the 9300K or 6500K by "DOWN" "UP" button.
-  **COLOR CONTROL**
Adjust the color of Red, Green and Blue.
To change the color of R.G.B screen, select "RED" "GREEN" or "BLUE" and adjust the "UP" "DOWN" button.
-  **VIDEO LEVEL**
Selects the video level of the video graphic card.
If the intensity of image is high select 1.0V & if low select 0.7V
-  **SUB MENU 2**
Display Sub Menu 2.
-  **ZOOM**
Uses the ▲▼ button to zoom in or out.
-  **DEGAUSS**
Manually demag netizes the CRT. This can be used if the display becomes discolored.
Allow a minimum of 20 minutes to elapse between each degauss.
The monitor also will automatically degauss when power is applied.
-  **INFORMATION**
Displays the current mode, user modes and factory preset modes.

CONTROLS AND FUNCTIONS

-  **LANGUAGE**
Select a language among English, Deutsch, Français, Español, Portuguese.
 -  **RECALL**
Resets the control functions back to the original factory preset values.
In order for the Recall function to work, the timing must fall under one of the factory preset timing modes.
 -  **EXIT**
Returns to previous menu or status.
- SUB MENU 1**
-  **TRAPEZOID**
Adjusts the display sides to be parallel.
 -  **PARALLELOGRAM**
Adjusts the tilt of the display sides.
 -  **PIN-BALANCE**
Adjust the curvature of the left and right sides of the screen image.
 - Tc TOP CORNER CORRECTION**
Corrects the top corner image shape to a rectangle.
 - Bc BOTTOM CORNER CORRECTION**
Corrects the bottom corner image shape to a rectangle.
 -  **EXIT**
Returns to previous menu or status.

CONTROLS AND FUNCTIONS

SUB MENU 2

H-MOIRE

Reduces the optical effect of horizontal wavy lines on the display image. These effects are usually more noticeable on large gray areas or on black & white check board patterns.

V-MOIRE

Reduces the optical effect of vertical wavy lines on the display image. These effects are usually more noticeable on large gray areas or on black & white check board patterns.

OSD H-POSI.

Moves the OSD position to left or right.

OSD V-POSI.

Moves the OSD position to up or down.

ROTATION

Adjusts the tilt of image.

EXIT

Returns to previous menu or status.

REAR VIEW

E. AC INLET

Power cord connection.

▶ NOTE:

Power cord is used as main power disconnect device in this product.

F. D-SUB CONNECTOR OF SIGNAL CABLE

Connect to the analog RGB signal output connector of IBM PS/2, or compatible computer.

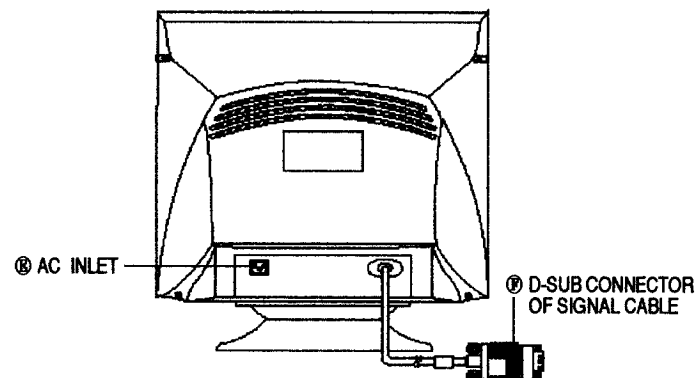

▶ ACCESSORY

1. POWER CORD
2. INSTRUCTION MANUAL

SPECIFICATIONS

- ▶ **CDT Size / Type**
17" (16V) Dynamic focus, Invar shadow mask and ARAS(Anti-Reflection Anti-Static) Coating.
0.24mm(Stripe type)
- ▶ **INPUT SIGNAL**
D-SUB INPUT
Analog RGB Video: 0.7Vpp / 75 Ω
Sync.: TTL Level
- ▶ **SWEEP FREQUENCY**
Horizontal: 30-70KHz(Automatically)
Vertical: 50-150Hz(Automatically)
- ▶ **VIDEO BANDWIDTH**
110MHz Max.
- ▶ **DISPLAY AREA**
Full Size: 324 x 244mm
Preset Size: 305 x 225mm
- ▶ **MAX. RESOLUTION**
1280 dots x 1024 lines
- ▶ **POWER INPUT**
AC 100-240V, 50/60Hz(FREE VOLTAGE)
- ▶ **POWER CONSUMPTION**
105 Watts(Max.)
Power Saving: Less than 5W
- ▶ **Dimensions (W x D x H)**
560mm X 520mm X 495mm (Carton Box)
- ▶ **WEIGHT**
Net Weight : 17.0Kg
Gross Weight : 20.0Kg
- ▶ **DDC 1/2B**
- ▶ **OSD(On Screen Display)**
- ▶ **NOTE :**
Technical specifications are subject to change without notice.

TROUBLE SHOOTING GUIDE

PROBLEM	CHECK THESE ITEMS
No Picture (Not in power saving mode)	<p>The video card should be completely seated in its slot.</p> <p>Power switch and computer power switch should be in the ON position.</p> <p>The signal cable should be completely connected to the video card/computer.</p> <p>Check connector for bent or pushed-in pins.</p>
LED on the monitor is not lit	<p>Power switch should be in the ON position and the power cord should be connected.</p>
Display image is not centered, too small or too large	<p>Adjust size and position controls to adjust the image.</p>
Display size and position were not saved	<p>Wait approximately ten seconds after making adjustments before changing or disconnection the signal or powering OFF the monitor.</p>
Image is scrolling or unstable	<p>Signal cable should be completely attached to the computer.</p> <p>Check the pin assignments and signal timings of the monitor and your video card.</p>
Picture bounces or a wave pattern is present in the picture	<p>Move electrical that may be causing electrical interference away from the monitor.</p>
Edges of the display image are curved either inward or outward	<p>Adjust the side pin-cushion control.</p>

FOR GERMAN

WICHTIGE HINWEISE

- ▶ Achten Sie darauf, daß das Gerät nur in eine 240V(220V) Schuko-Steckdose eingesteckt wird.
- ▶ Die Steckdose sollte jederzeit frei zugänglich sein, um bei einem evtl. auftretenden Notfall das Gerät schnell von der Stromversorgung zu trennen.
- ▶ Achten Sie desweiteren darauf, daß die Netzanschlußleitung nicht mechanisch beansprucht noch sonstwie beschädigt wird.
- ▶ Öffnen Sie niemals das Gerät! Im Inneren befinden sich Teile mit gefährlicher Spannung.
- ▶ Bevor Sie das Gerät reinigen, ziehen Sie bitte den Netzstecker aus der Steckdose. Säubern Sie das Gerät dann mit einem feuchten (keinesfalls tropfnassen) Lappen.
- ▶ Das Gerät ist funkentstört nach EN55022
- ▶ Bauartzulassung:
Die in diesem Gerät entstehende Röntgenstrahlung ist ausreichend abgeschirmt (Ortsdosis in 0.1m Abstand weniger als $1.0\mu\text{sv/h}$).
Die Beschleunigungsspannung beträgt maximal 28KV.
- ▶ Stellen Sie das Gerät an einem ergonomisch günstigen Ort auf und sorgen Sie dafür, daß der Betrieb des Monitors mit nach ISO9241-3.7.8 geprüfter Peripherie sichergestellt ist.
- ▶ Maschinenlärminformationsverordnung 3. GSGV, 18.01.91 : Der arbeitsplatzbezogene Schalldruckpegel beträgt 70dB(A) oder weniger gemäß ISO 7779.

Falls Sie dennoch Fragen haben, auf die Bedienungsanleitung keine Antwort geben kann, so kontaktieren Sie bitte den nächsten Fachhändler.