

## **ATTACHMENT J – USER’S MANUAL**

---

# ORION

## 19" HIGH RESOLUTION MONITOR

### USER'S GUIDE MODEL NO.: 9G926

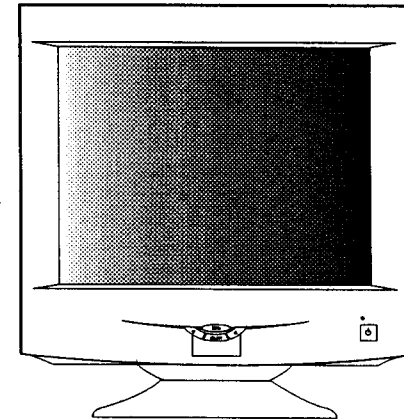

BEFORE USING THIS COLOR MONITOR,  
READ AND OBSERVE ALL OF THIS USER'S GUIDE.

Printed in Korea

P/N: M39M0057

# CONTENTS

SAFETY INSTRUCTION	2
CAUTIONS	4
FCC RF INTERFERENCE STATEMENT	5
INSTALLATION	6
RESOLUTION	7
CONTROLS AND FUNCTIONS	8
REAR VIEW	13
POWER MANAGEMENT	14
SPECIFICATIONS	15
TROUBLE SHOOTING GUIDE	16
WICHTIGE HINWEISE (GERMAN)	17



This Monitor was  
Manufactured by ISO 9001  
Certified Factory

# SAFETY INSTRUCTION

1. Read all of these instructions.
2. Save these instructions for later use.
3. Follow all warnings and instructions marked on the product.
4. Unplug this product from the wall outlet before cleaning.  
Do not use liquid cleaners or aerosol cleaners. Use a dry cloth for cleaning.
5. Do not use this product near water.
6. Do not place this product on an unstable cart, stand or table.  
The product may fall, causing serious damage to the product.
7. Slots and openings in the cabinet and the back or bottom are provided for ventilation: to ensure reliable operation of the product and to protect it from overheating these openings must not be blocked by placing the product on a bed, sofa, rug or other similar surface. This product should never be placed near or over a heat register.  
This product should not be placed in a built-in installation unless proper ventilation is provided.
8. This product should be operated from the type of power source indicated on the marking label. If you are not sure of the type of power available consult your dealer or local power company.
9. This product is equipped with a 3 wire grounding type plug having a third(grounding) pin. This is a safety feature. If you are unable to insert the plug into the outlet, contact your electrician to replace your obsolete outlet. Do not defeat the purpose of the grounding-type plug.
10. Do not allow anything to rest on the power cord.  
Do not locate this product where persons will walk on the cord.
11. If an extension cord is used with this product, make sure that the total of the ampere ratings on the products plugged into the extension cord do not exceed the extension cord ampere rating. Also, make sure that the total of all products plugged into the wall outlet does not exceed 15 amperes.
12. Never push objects of any kind into this product through cabinet slots as they may touch dangerous voltage points or short out parts that could result in a risk of fire or electric shock. Never spill any kind of liquid on the product.

## SAFETY INSTRUCTION

13. Do not attempt to service this product yourself, as opening or removing covers may expose you to dangerous voltage points or other risks.  
Refer all servicing to service personnel.
14. Unplug this product from the wall outlet and refer servicing to qualified service personnel under the following conditions.
  - A. When the power cord or plug is damaged or frayed.
  - B. If liquid has been spilled into the product.
  - C. If the product has been exposed to rain or water.
  - D. If the Product does not operate normally when the operating instructions are followed. Adjust only those controls that are covered by the operating instructions since improper adjustment of other controls may result in damage and will often require extensive work by a qualified technician to restore normal operation.
  - E. If the product has been dropped or the cabinet has been damaged.
  - F. If the product exhibits a distinct change in performance, indicating a need for service.

### ▶▶CAUTION

*The power supply cord is used as the main disconnect device, ensure that the socket-outlet is located/installed near the equipment and is easily accessible.*

### ▶▶ATTENTION

*Le cordon d'alimentation est utilisé comme interrupteur général. La prise de courant doit être située ou installée à proximité du matériel et être facile d'accès*

#### CAUTION TO SERVICE PERSONNEL

POWER SUPPLY CORD IS USED AS MAIN POWER DISCONNECT DEVICE IN THIS PRODUCT. UNPLUG THIS PRODUCT FROM THE WALL OUTLET BEFORE REMOVING THE BACK COVER AND SERVICING

#### EMISSION CHARACTERISTICS TESTED BY SEMKO

THIS PRODUCT HAS BEEN TESTED AND HAS SHOWN COMPLIANCE WITH THE NATIONAL SPECIFICATIONS SUCH AS SWEDISH MPR 1990:10 (MPR 1)

## CAUTIONS

### ▶ NEVER REMOVE THE BACK COVER

Removal of the back cover should be carried out only by qualified personnel.  
This display monitor contains high voltage inside.

### ▶ DO NOT USE IN HOSTILE ENVIRONMENTS

To prevent shock or fire hazard. Do not expose the unit to rain or moisture.  
This unit is designed to be used in the office or home. Do not subject the unit to vibrations, dust of corrosive gases.

### ▶ KEEP IN A WELL VENTILATED PLACE

Ventilation holes are provided on the cabinet to prevent the temperature from rising.  
Do not cover the unit or place anything on the top of unit. Ventilation holes are provided also on the bottom of the cabinet.

### ▶ AVOID HEAT

Avoid placing the unit in direct sunshine or near a heating appliance.

### ▶ BE CAREFUL OF MAGNETIC FIELDS

Do not place a magnet, speaker system, floppy disc drive or anything which will generate magnetism near the unit. A magnetic field may cause blurred colors or distortion of the displayed pattern.

### ▶ TO ELIMINATE EYE FATIGUE

Do not use the unit against a bright back ground and where sunlight or other light sources will shine directly on the monitor.

### ▶ BE CAREFUL OF HEAVY OBJECT

Neither the monitor itself nor any other heavy object should rest on the power cord.  
Damage to a power cord can cause fire or electrical shock.

## FCC RF INTERFERENCE STATEMENT

### ▶▶ NOTE :

*This equipment has been tested and found to comply with the limits for a Class B digital device, pursuant to Part 15 of the FCC Rules. These limits are designed to provide reasonable protection against harmful interference in a residential installation.*

*This equipment generates, uses and can radiate radio frequency energy and, if not installed and used in accordance with the instructions, may cause harmful interference to radio communications. However, there is no guarantee that interference will not occur in a particular installation.*

*If this equipment does cause harmful interference to radio or television reception which can be determined by turning the equipment off and on, the user is encouraged to try to correct the interference by one or more of the following measures.*

- Reorient or relocate the receiving antenna.
- Increase the separation between the equipment and receiver.
- Connect the equipment into an outlet on a circuit different from that to which the receiver is connected.
- Consult the dealer or an experienced radio, TV technician for help.
- Only shielded interface cable should be used.

*Finally, any changes or modifications to the equipment by the user not expressly approved by the grantee or manufacturer could void the users authority to operate such equipment.*

### ▶ DOC COMPLIANCE NOTICE

This digital apparatus does not exceed the Class B limits for radio noise emissions from digital apparatus set out in the radio interference regulation of Canadian Department of Communications.

### ▶ AVIS DE CONFORMATION AU MDC(DOC)

Le présent appareil numérique n'émet pas de bruits radio-électriques dépassant les limites appliqués aux appareils numériques de Class B d'après les règlements sur le brouillage radio-électrique conçu par le ministère des communications du Canada.

## INSTALLATION

**NO TOOLS ARE REQUIRED TO INSTALL THE MONITOR. SIMPLY FOLLOW THE INSTRUCTIONS OUTLINED IN THE NEXT FEW PAGES.**

### 1. CONNECT THE SIGNAL CABLE

#### A. ATTACHED SIGNAL CABLE

- 1) If the signal cable is attached on the monitor, connect the other end into the graphic card on back of the computer.
- 2) Secure the connection with the screws on the plug.

#### B. DETACHED SIGNAL CABLE

- 1) Connect one end of the signal cable to the back panel of the monitor and connect the other end to the graphic card on back of the computer.
- 2) Secure the connection with the screws on the plug.

### 2. CONNECT THE POWER CORD

Connect the female end of the power cord to the power input receptacle on the back panel of the monitor.  
Then, plug the male end of the power cord to an AC outlet or computer.

### 3. TILT/SWIVEL STAND

The Tilt/Swivel Stand is installed already, when this monitor set manufactured.

### 4. MAKING THE RIGHT CONNECTIONS

- 1) Make sure the power to this monitor and the computer system is turned OFF.
- 2) Connect the D-SUB connector of signal cable to system.
- 3) Connect one end of the power cord to this monitor and the other end to the wall or P/C outlet.
- 4) Turn this monitor ON.
- 5) Start your system.

## RESOLUTION

This monitor is a digitally-controlled multi-frequency monitor. It operates at horizontal frequencies of 30 to 96KHz and vertical frequencies of 50 to 160Hz.

Because of its micro processor-based designs it offers auto-synchronization and auto-sizing capabilities. This monitor offers 12 programmed settings as listed in the table below.

These 12 preset modes cover most of the common video modes supported by popular graphic adaptors. However, each adaptors implementation of these video modes may vary slightly in timings. You may find it necessary to make minor adjustments to the display settings (i.e., horizontal position) using the On Screen Display. For further information and instructions on using the On Screen Display, please refer to Section 5. "Controls and Functions."

You can also program any signal within its frequency range of 30-96KHz horizontal and 50-160Hz vertical as user Programmed modes.

PRESET MODES	RESOLUTION		FREQUENCY	
	H(Pixel/s)	V(Lines)	H(KHz)	V(Hz)
VGA	640	350	31.5	70
	720	400	31.5	70
	640	480	31.5	60
VESA	640	480	43.2	85
	800	600	46.9	75
	800	600	53.6	85
	1024	768	68.7	85
	1152	864	67.5	75
	1280	1024	64.0	60
	1280	1024	80.0	75
	1600	1200	81.3	65
	1600	1200	93.7	75

## CONTROLS AND FUNCTIONS

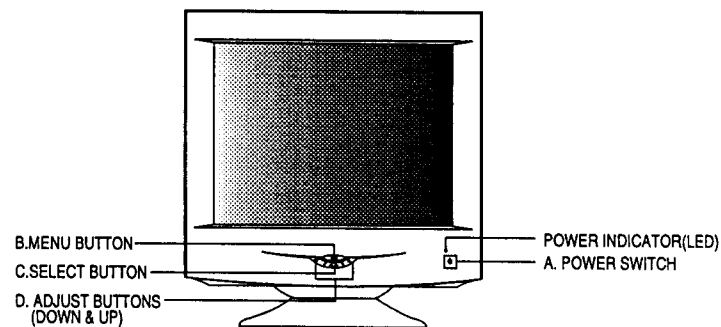

### A. POWER ON/OFF ( )

Turns the power ON or OFF. There will be a few seconds delay before the display appears.

The power LED(next to the power switch) lights when the power is turned ON.

The power is turned off by pressing the power switch again and the power LED goes out.

### B. MENU

Activates and exits the On Screen Display. This button can also be used to move previous menu or status.

There are two OSD menu or status.

They are **USER MENU 1** (H POSITION, H SIZE, V POSITION, V SIZE, PIN CUSHION, TRAPEZOID, CORNER CORECTION, PARALLELOGRAM, PIN BALANCE, TILT, RECALL, COLOR TEMP, BRIGHTNESS, CONTRAST) & **USER MENU 2** (INFORMATION, LANGUAGE, MOIRE, DEGAUSS, OSD HORIZONTAL, OSD VERTICAL, OSD ON TIME).

# CONTROLS AND FUNCTIONS

USER MENU 1 activates when you press the Menu button.

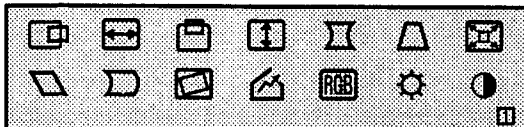

USER MENU 2 activates via the adjust (▼ / ▲) button.

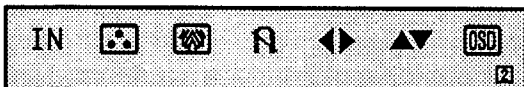

## C. SELECT

The select button allows user to activate the desired adjustment with blinking icon.

## D. ADJUST (▼ ▲)

The Adjust button allows user to choose the icons (controls) in the menu. Pressing the adjust button ▼ or ▲ will step through all available adjustment icons (controls).

In addition this adjust button can be used to adjust the icons (controls) that is selected and activated (blinking) via the select button.

Press the Adjust button.

A window containing an adjustment bar will increase or decrease.

After completing all the desired adjustments, the On Screen Display will disappear with pressing the menu button.

## 1. SELF-TEST DISPLAY

When there is no signal input (No connection), the On Screen Display will show.

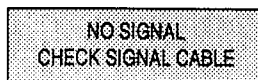









# CONTROLS AND FUNCTIONS

## 2. AUTO REGISTRATION







This monitor has 12 preset modes. If the current video is one of the preset modes, the monitor keeps storing the custom display settings into the permanent memory. There are also 10 user modes that allow you to save the custom display settings made to any video mode that is not one of the preset modes. Adjustments are automatically registered without pressing any buttons. Up to 10 user modes are stored automatically on a "First-In-First-Out" basis.

## 3. OSD MENU DESCRIPTION



### USER MENU 1

-  **H POSITION (Horizontal Position)**  
Moves images horizontally on screen left(▼) or right(▲).
-  **H SIZE (Horizontal Size)**  
Increases(▲) or decreases(▼) Size of image horizontally.
-  **V POSITION (Vertical position)**  
Moves images vertically on screen up(▲) or down(▼).
-  **V SIZE (Vertical Size)**  
Increases(▲) or decreases(▼) Size of image vertically.
-  **PINCUSHION**  
Adjusts the side Pin-cushion or barrelling.
-  **TRAPEZOID**  
Adjusts the display sides to be parallel.
-  **CORNER CORRECTION**  
User can select Top or Bottom Corner correction by pressing the Select button and also can activate with select button.
  - ☞ TOP CORNER CORRECTION  
Corrects the top corner image shape to a rectangle.
  - ☞ BOTTOM CORNER CORRECTION  
Corrects the bottom corner image shape to a rectangle.
-  **PARALLELOGRAM**  
Adjusts the tilt of the display sides.





## CONTROLS AND FUNCTIONS

-  **PIN BALANCE**  
Adjusts the curvature of the left and right sides of the screen image.
-  **TILT**  
Adjusts the tilt of image.
-  **RECALL**  
Resets the control functions back to the original factory preset values.  
In order for the Recall function working, the timing must fall under one of the factory preset timing modes.
-  **COLOR TEMPERATURE**  
Adjusts color temperature to 9300K, 6500K(notes : 9300K is factory default).  
Or, for a custom color mode, select "USER" and push the select button to activate the RGB Sub-menu.  
This adjust the intensity of the RGB video output. Using the select button activate the RG(Red Gain), GG(Green Gain) or BG(Blue Gain) and change color strength for a customized color mode.
-  **BRIGHTNESS**  
Increases(▲) or decreases(▼) the intensity(illumination) of the image.
-  **CONTRAST**  
Increases(▲) or decreases(▼) the strength(lightness or dimness) of the image.

### USER MENU 2

-  **INFORMATION**  
Displays horizontal frequency(on violet) and vertical frequency(on violet) and "PRESET MODE" means the factory preset mode(on violet).
-  **LANGUAGE**  
Selects a language among ENGLISH, DEUTSCH, FRANÇAIS, ESPAÑOL, ITALIANO.

## CONTROLS AND FUNCTIONS

-  **MOIRE**  
Adjusts the moire level of the screen.  
Activate MOIRE icon & keep pressing select button approximately 2 seconds after select "ON".
  - ⇨ **H. MOIRE ADJUST**  
Reduces the optical effect of horizontal wavy lines on the display image.  
These effects are usually more noticeable on large gray areas or on black & white check board patterns.
  - ⇨ **V. MOIRE ADJUST**  
Reduces the optical effect of vertical wavy lines on the display image.  
These effects are usually more noticeable on large gray areas or on black & white check board patterns.
-  **DEGAUSS**  
Manually demagnetizes the CDT. This can be used if the display becomes discolored.  
Allow a minimum of 20 minutes to elapse between each degauss.  
The monitor also will automatically degauss when power is applied.
-  **OSD HORIZONTAL**  
Moves the OSD position to left or right.
-  **OSD VERTICAL**  
Moves the OSD position to up or down
-  **OSD ON TIME**  
Adjusts on screen OSD running time.



## REAR VIEW

### E. AC INLET

Power cord connection.

### ▶▶ NOTES

*Power cord is used as main power disconnect device in this product.*

### F. D-SUB CONNECTOR OF SIGNAL CABLE

Connect to the analog RGB signal output connector of video card.

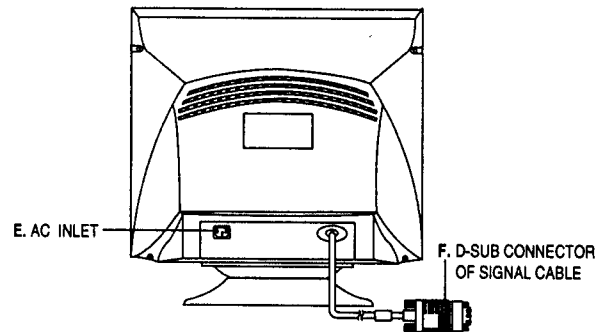

### ▶ ACCESSORY

1. POWER CORD
2. INSTRUCTION MANUAL
3. SIGNAL CABLE(if detachable type)

## POWER MANAGEMENT

This monitor features a power management system to "power down" upon receipt of the VESA DPMS(The display power management signaling) from a VESA DPMS video card.

The VESA DPMS-compliant video card performs this signaling system through not sending horizontal, vertical, or sync signal.

This monitor enters an appropriate mode through identifying each of the three modes of the signaling system.

### POWER CONSUMPTION

MODE	POWER CONSUMPTION
ON	< 100W
STANDBY	< 15W
SUSPEND	< 15W
ACTIVE OFF	< 5W

### 1 LED INDICATOR

The power management feature of the monitor is comprised of four stages : On(Green), Standby, Suspend(Amber blinking) and Active off(Amber).

MODE	LED COLOR	MONITOR OPERATION
ON	GREEN	Normal Operation
STANDBY	AMBER BLINKING	Screen blanks after preset idle time and Some electronic circuits go off.
SUSPEND		
ACTIVE OFF	AMBER	All circuitry in the monitor is shut down except for a low power detection circuit.

## SPECIFICATIONS

### ■ CDT

19" (18" Viewable) Dynamic focus, Invar shadow mask and ARAS(Anti-Reflection Anti-Static) Coating.  
0.26mm Dot Pitch

### ■ RESOLUTION(H x V)

1600x1200 Non Interlaced

### ■ FREQUENCY

HORIZONTAL : 30-96KHz

VERTICAL : 50-160Hz

### ■ VIDEO DOT RATE

202MHz

### ■ INPUT SIGNAL

VIDEO(Analog 0.7Vp-p/75 $\Omega$ )

SYNC(Separate and Composite TTL Level)

### ■ ACTIVE DISPLAY AREA (W x H)

Preset : 346mm X 255mm

Full : 366mm X 275mm

### ■ DIMENSIONS (W x D x H)

570mm X 565mm X 570mm (Carton Box)

### ■ WEIGHT

Net Weight : 21.0Kg

Gross Weight : 24.0Kg

### ■ POWER SUPPLY

AC100 - 240Vac, 50/60Hz (auto switching)

### ▶▶ NOTE :

*Technical specifications are subject to change without notice.*

## TROUBLE SHOOTING GUIDE

TROUBLE	TROUBLE SHOOTING TIP
No image on display screen	<ol style="list-style-type: none"> <li>1. Check that power cord of the Monitor have been connected securely into wall outlet or grounded extension cable or strip.</li> <li>2. Power switch should be in the ON position and LED is lit.</li> <li>3. Check that the Brightness and/or the Contrast adjustments of the Display have not been turned down to minimum levels.</li> </ol>
"No signal, Check signal Cable" message on screen	<ol style="list-style-type: none"> <li>1. The signal cable should be completely connected to the video card/computer.</li> <li>2. The video card should be completely seated in its slot and the computer is switched ON.</li> </ol>
Display image is not centered, too small or too large	Adjust size and position in the OSD, your settings will be memorized automatically in microprocessor of the monitor.
"Humming" sound when switch on the monitor	<p>The sound you hear indicates that the demagnetizing circuit is activated.</p> <p>Every time the monitor is powered on, it will go through the degaussing process which helps eliminate any purity problems.</p>
Picture bounces or a wave pattern is present in the picture	Remove electric equipments that may be causing electric interference to the monitor.
There appears to be a second image or "ghost" on the screen	This usually occurs if an extension signal cable is installed or the signal cable is not fastened to the back of the video card.