

# CONTENTS

SAFETY INSTRUCTION	2
CAUTIONS	4
FCC RF INTERFERENCE STATEMENT	5
INSTALLATION	6
RESOLUTION	7
CONTROLS AND FUNCTIONS	8
REAR VIEW	13
SPECIFICATIONS	14
TROUBLE SHOOTING GUIDE	15
WICHTIGE HINWEISE (GERMAN)	16

This Monitor was  
Manufactured by ISO 9001  
Certified Factory



# SAFETY INSTRUCTION

1. Read all of these instructions.
2. Save these instructions for later use.
3. Follow all warnings and instructions marked on the product.
4. Unplug this product from the wall outlet before cleaning. Do not use liquid cleaners or aerosol cleaners. Use a dry cloth for cleaning.
5. Do not use this product near water.
6. Do not place this product on an unstable cart, stand or table. The product may fall, causing serious damage to the product.
7. Slots and openings in the cabinet and the back or bottom are provided for ventilation: to ensure reliable operation of the product and to protect it from overheating these openings must not be blocked by placing the product on a bed, sofa, rug or other similar surface. This product should not be placed near or over a heat register.  
This product should not be placed in a built-in installation unless proper ventilation is provided.
8. This product should be operated from the type of power source indicated on the marking label. If you are not sure of the type of power available, consult your dealer or local power company.
9. This product is equipped with a 3 wire grounding type plug (having a third grounding) pin. This is a safety feature. If you are unable to insert the plug into the outlet, contact your electrician to replace your obsolete outlet. Do not defeat the purpose of the grounding-type plug.
10. Do not allow anything to rest on the power cord.  
Do not locate this product where persons will walk on the cord.
11. If an extension cord is used with this product, make sure that the total of the ampere ratings on the products plugged into the extension cord do not exceed the extension cord ampere rating. Also, make sure that the total of all products plugged into the wall outlet does not exceed 10 amperes.
12. Never push objects of any kind into this product through cabinet slots as they may touch dangerous voltage points or short out parts that could result in a risk of fire or electric shock. Never spill any kind of liquid on the product.

## SAFETY INSTRUCTION

13. Do not attempt to service this product yourself, as opening or removing covers may expose you to dangerous voltage points or other risks.  
Refer all servicing to service personnel.
14. Unplug this product from the wall outlet and refer servicing to qualified service personnel under the following conditions:
- A. When the power cord or plug is damaged or frayed.
  - B. If liquid has been spilled into the product.
  - C. If the product has been exposed to rain or water.
  - D. If the Product does not operate normally when the operating instructions are followed. Adjust only those controls that are covered by the operating instructions since improper adjustment of other controls may result in damage and will often require extensive work by a qualified technician to restore normal operation.
  - E. If the product has been dropped or the cabinet has been damaged.
  - F. If the product exhibits a distinct change in performance, indicating a need for service.

### ▶▶ CAUTION

The power supply cord is used as the main disconnect device, ensure that the socket-outlet is located/installed near the equipment and is easily accessible.

### ▶▶ ATTENTION

Le cordon d'alimentation est utilisé comme interrupteur général. La prise de courant doit être située ou installée à proximité du matériel et être facile d'accès.

### CAUTION TO SERVICE PERSONNEL

POWER SUPPLY CORD IS USED AS MAIN POWER DISCONNECT DEVICE IN THIS PRODUCT. UNPLUG THIS PRODUCT FROM THE WALL OUTLET BEFORE REMOVING THE BACK COVER AND SERVICING

### EMISSION CHARACTERISTICS TESTED BY SEMKO

THIS PRODUCT HAS BEEN TESTED AND HAS SHOWN COMPLIANCE WITH THE NATIONAL SPECIFICATIONS SUCH AS SWEDISH MPR 1990:10.(MPR 11)

## CAUTIONS

### ▶ NEVER REMOVE THE BACK COVER

Removal of the back cover should be carried out only by qualified personnel. This display monitor contains high voltage inside.

### ▶ DO NOT USE IN HOSTILE ENVIRONMENTS

To prevent shock or fire hazard. Do not expose the unit to rain or moisture. This unit is designed to be used in the office or home. Do not subject the unit to vibrations, dust or corrosive gases.

### ▶ KEEP IN A WELL VENTILATED PLACE

Ventilation holes are provided on the cabinet to prevent the temperature from rising.

Do not cover the unit or place anything on the top of unit. Ventilation holes are provided also on the bottom of the cabinet.

### ▶ AVOID HEAT

Avoid placing the unit in direct sunshine or near a heating appliance.

### ▶ BE CAREFUL OF MAGNETIC FIELDS

Do not place a magnet, speaker system, floppy disc drive or anything which will generate magnetism near the unit. A magnetic field may cause blurred colours or distortion of the displayed pattern.

### ▶ TO ELIMINATE EYE FATIGUE

Do not use the unit against a bright back ground and where sunlight or other light sources will shine directly on the monitor.

### ▶ BE CAREFUL OF HEAVY OBJECT

Neither the monitor itself nor any other heavy object should rest on the power cord. Damage to a power cord can cause fire or electrical shock.

## FCC RF INTERFERENCE STATEMENT

### ►► NOTE :

This equipment has been tested and found to comply with the limits for a Class B digital device, pursuant to Part 15 of the FCC Rules. These limits are designed to provide reasonable protection against harmful interference in a residential installation.

This equipment generates, uses and can radiate radio frequency energy and, if not installed and used in accordance with the instructions, may cause harmful interference to radio communications. However, there is no guarantee that interference will not occur in a particular installation.

If this equipment does cause harmful interference to radio or television reception which can be determined by turning the equipment off and on, the user is encouraged to try to correct the interference by one or more of the following measures.

- Reorient or relocate the receiving antenna.
  - Increase the separation between the equipment and receiver.
  - Connect the equipment into an outlet on a circuit different from that to which the receiver is connected.
  - Consult the dealer or an experienced radio, TV technician for help.
  - Only shielded interface cable should be used.
- Finally, any changes or modifications to the equipment by the user not expressly approved by the grantee or manufacturer could void the users authority to operate such equipment.

### ► DOC COMPLIANCE NOTICE

This digital apparatus does not exceed the Class B limits for radio noise emissions from digital apparatus set out in the radio interference regulation of Canadian Department of Communications.

### ► AVIS DE CONFORMANCE AU MBO(DOC)

Le présent appareil numérique n'émet pas de bruits radio-électriques dépassant les limites applicables aux appareils numériques de Class B d'après les règlements sur le brouillage radio-électrique émis par le ministère des communications du Canada.

## INSTALLATION

**NO TOOLS ARE REQUIRED TO INSTALL THE MONITOR. SIMPLY FOLLOW THE INSTRUCTIONS OUTLINED IN THE FOLLOWING PAGE.**

### 1. INSTALLING THE TILT/SWIVEL STAND

- 1) Align the stand with the front slots in the bottom of the monitor and insert the Tilt/Swivel Stand into the slots.
- 2) Push the Tilt/Swivel Stand firmly toward the front of the monitor until the latches click into the locked position.

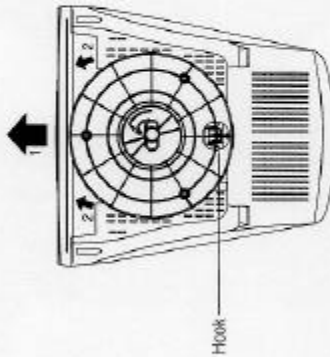

### 2. CONNECT THE SIGNAL CABLE

- 1) Connect the end into the graphic card on back of the computer.
- 2) Secure the connection with the screws on the plug.

### 3. CONNECT THE POWER CORD

Connect the female end of the power cord to the power input receptacle on the back panel of the monitor. Then, plug the male end of the power cord to an AC outlet or computer.

### 4. TURN THIS MONITOR ON AND START YOUR SYSTEM

## RESOLUTION

### 1. RECOMMENDED SIGNAL TIMING CHART

Resolution	Horizontal Frequency (Hz)	Vertical Frequency (Hz)	Polos (H / V)
IBM/340 x 350	31.469	70.027	(+ / -)
IBM/720 x 400	31.469	70.027	(- / +)
IBM/340 x 480	31.469	59.941	(- / -)
VES/616(40 x 480)	43.269	85.008	(- / -)
VES/618(00 x 600)	37.789	60.317	(+ / +)
VES/618(00 x 600)	46.875	75.000	(+ / +)
VES/618(00 x 600)	53.674	85.001	(+ / +)
VES/611(024 x 768)	48.363	60.004	(- / -)
VES/611(024 x 768)	68.677	84.997	(+ / +)
VES/611(280 x 1024)	63.981	80.020	(+ / +)

It has 10 user setting modes which you can store except for factory setting mode. To display user mode except for factory setting modes, please adjust the monitor screen for yourself.

After that, the screen data is stored to the memory.

### 2. THE WAY OF ADJUSTMENT

When you want to adjust the screen, please refer to function of controls. Those screen data are automatically stored to the memory.

## CONTROLS AND FUNCTIONS

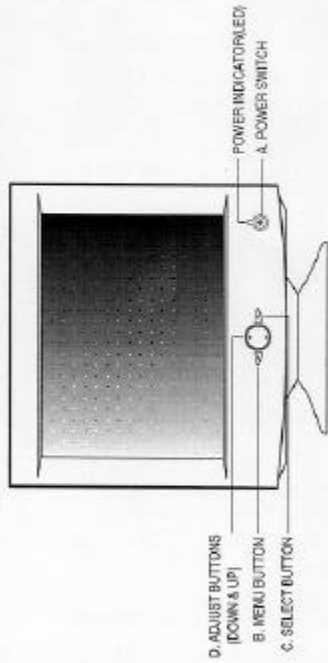

#### A. POWER ON/OFF (⏻)

Turns the power ON or OFF. There will be a few seconds delay before the display appears.

The power LED (next to the power switch) lights when the power is turned ON.

The power is turned off by pressing the power switch again and the power LED goes out.

#### B. MENU

Activates and exits the On Screen Display. This button can also be used to move previous menu or status.

There are two OSD menu or status.

They are MAIN MENU1 (H.POSITION, H.SIZE, V.POSITION, V.SIZE, PINDUSHION, TRAPEZOID, PARALLELOGRAM, PINBALANCE, CORNER CORRECTION, COLOR-TEMP, BRIGHTNESS, CONTRAST)

MAIN MENU2 (RECALL, ROTATION, LANGUAGE, DEGAUSS, OSD H.POSITION, OSD V.POSITION, OSD ON TIME, VIDEO LEVEL, MOIRE, INFORMATION, EXIT)

## CONTROLS AND FUNCTIONS

MAIN MENU 1 activates when you press the Menu button.

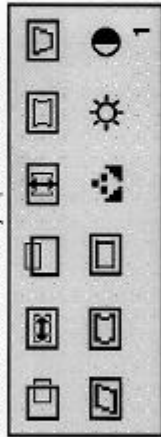

MAIN MENU 2 activates when you press  $\blacktriangledown$  (▲) at the CONTRAST(EXIT) icon in the menu.

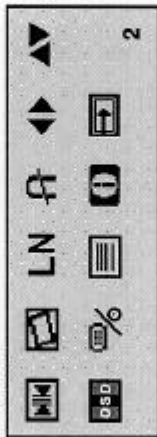

### C. SELECT

The select button allows user to activate the desired adjustment with blinking icon.

### D. ADJUST (▼, ▲)

The Adjust button allows user to choose the icons (controls) in the menu. Pressing the adjust button ▼ or ▲ will step through all available adjustment icons (controls).

In addition this adjust button can be used to adjust the icons (dot controls) that is selected and activated (blinking) via the select button. When the adjust button is pressed, The adjustment bar in the window will be increased or decreased. After completing all the desired adjustments, the On Screen Display will disappear with pressing the menu button.

### 1. SELF-TEST DISPLAY

When there is no connection, the On Screen Display will show.

NO SIGNAL  
CHECK SIGNAL CABLE

## CONTROLS AND FUNCTIONS









### 2. AUTO REGISTRATION

This monitor has 10 preset modes. If the current video is one of the preset modes, the monitor keeps storing the custom display settings into the permanent memory.







There are also 10 user modes that allow you to save the custom display settings made to any video mode that is not one of the preset modes. Adjustments are automatically registered without pressing any buttons. Up to 10 user modes are stored automatically on a "First-In-First-Out" basis.

### 3. OSD MENU DESCRIPTION







#### MAIN MENU 1

-  **H. POSITION (Horizontal Position)**  
Moves images horizontally on screen left (▼) or right (▲).
-  **H. SIZE (Horizontal Size)**  
Increases (▲) or decreases (▼) Size of image horizontally.
-  **V. POSITION (Vertical Position)**  
Moves images vertically on screen up (▲) or down (▼).
-  **V. SIZE (Vertical Size)**  
Increases (▲) or decreases (▼) Size of image vertically.
-  **PINCUSHION**  
Adjusts the side Pincushion or barrelling.
-  **TRAPEZOID**  
Adjusts the display sides to be parallel.
-  **PARALLELOGRAM**  
Adjusts the fit of the display sides.
-  **PINBALANCE**  
Adjusts the curvature of the left and right sides of the screen image.

## CONTROLS AND FUNCTIONS

-  **CORNER CORRECTION**  
User can select Top or Bottom Corner correction by pressing the Select button.  
⇒ **TOP CORNER CORRECTION**  
Corrects the top corner image shape to a rectangle.  
⇒ **BOTTOM CORNER CORRECTION**  
Corrects the bottom corner image shape to a rectangle.
-  **COLOR-TEMP**  
Adjusts color temperature to 9300K, 6500K (notes : 9300K is factory default). Or, for a custom color mode, select "USER" and keep pressing select key approximately 2 seconds to activate the RGB Sub-menu.  
This adjust the intensity of the RGB video output. Using the select button activate (blinking) the R-GAIN (Red Gain), G-GAIN (Green Gain) or B-GAIN (Blue Gain) and change color strength for a customized color mode.
-  **BRIGHTNESS**  
Increases (▲) or decreases (▼) the intensity (illumination) of the image.
-  **CONTRAST**  
Increases (▲) or decreases (▼) the strength (lightness or dimness) of the image.
- MAIN MENU 2**
-  **RECALL**  
Resets the control functions back to the original factory preset values. In order for the Recall function working, the timing must fall under one of the factory preset timing modes.
-  **ROTATION**  
Adjusts the tilt of image.
- LN LANGUAGE**  
Selects a language among ENGLISH, DEUTSCH, FRANÇAIS, ESPANOL, ITALIANO.
-  **DEGAUSS**  
Manually demagnetizes the CDT. This can be used if the display becomes discolored.  
Allow a minimum of 20 minutes to elapse between each degauss. The monitor also will automatically degauss when power is applied, and power saving mode is changed to normal mode.

## CONTROLS AND FUNCTIONS

-  **OSD H.POSITION**  
Moves the OSD position to left or right.
-  **OSD V.POSITION**  
Moves the OSD position to up or down.
-  **OSD ON TIME**  
If there isn't key pressure OSD will be disappeared automatically the setted seconds later.
-  **VIDEO LEVEL**  
Selects the video level of the Video Graphic Card.  
If the intensity of image is high select 1.0V & if low select 0.7V.
-  **MOIRE**  
Adjusts the moire level of the screen.  
Activate MOIRE icon & keep pressing select button approximately 2 seconds after select "ON".  
⇒ **H. MOIRE ADJUST**  
Reduces the optical effect of horizontal wavy lines on the display image. These effects are usually more noticeable on large gray areas or on black & white check board patterns.  
⇒ **V. MOIRE ADJUST**  
Reduces the optical effect of vertical wavy lines on the display image. These effects are usually more noticeable on large gray areas or on black & white check board patterns.
-  **INFORMATION**  
Displays the current mode, horizontal frequency, vertical frequency, the factory preset mode and user preset mode.
-  **EXIT**  
Exit user menu.