

# ORION®

## **TV/DVD-1432**

### **COMBINED 14" TV AND DVD PLAYER**

---

### **OWNER'S MANUAL**



Please read this manual carefully before using this TV set and keep it for future reference.

# CONTENTS

<b>Before Operation</b> .....	
<b>Warning and cautions</b> .....	2
<b>Installation</b> .....	3
Aerial connection.....	3
Preparation of the remote control.....	3
<b>Function buttons and external sockets</b> .....	4
Front panel of the TV set.....	4
Rear panel of the TV set.....	4
<b>Using the remote control</b> .....	5
<b>Basic operation</b> .....	
<b>Switching on/off the TV set</b> .....	6
<b>Watching TV</b> .....	7
Watching TV program.....	7
Program swap and auto scan functions.....	8
<b>Searching channel</b> .....	9
Full automatic mode.....	9
Semi-automatic search.....	10
Manual fine tune.....	11
Program skip .....	12
<b>Convenient picture and sound control functions</b> .....	13
Multiple picture modes .....	13
Black stretch and noise reduce.....	14
Mute , Select the language and Fade function.....	15
<b>Time functions</b> .....	16
Clock setting and timer on/off functions.....	16
Sleep timer and program preset .....	17
<b>Setup function</b> .....	18
Screen saver and childlock functions.....	18
AVL and calendar functions .....	19
<b>Position exchange function</b> .....	20
<b>Teletext</b> .....	21
<b>DVD Operation</b> .....	
<b>Basic Playback</b> .....	23
<b>Advanced Playback</b> .....	24
<b>Special Function Playback</b> .....	25
<b>DVD System Setup</b> .....	26
<b>Playable Discs</b> .....	30
<b>Disc Protection and DVD Characteristics</b> .....	31
<b>Others</b> .....	
<b>Connection to the external audio and video equipment</b> .....	32
<b>Troubleshooting guide</b> .....	33
<b>Specifications</b> .....	34

## Warning and cautions

1. When you clean the TV set, please pull out the power plug from AC outlet. Don't clean the cabinet and the screen with benzene, petrol and other chemicals.



4. Do not place the TV set near rain or moisture as it may cause an electric shock, or the TV set to catch fire. The TV set must only be used in dry in door locations.

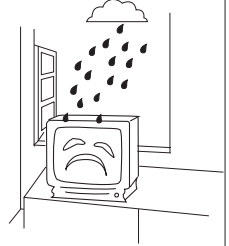

2. In order to prolong the live of the product, please use in a well ventilated location.

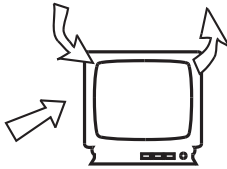

5. The back cover must only be removed by a registered electrical service person. Removing the back cover may result in electric shock, fire or damage to the TV set.

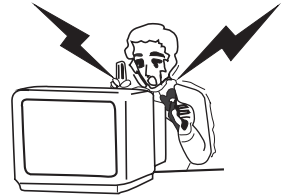

3. Don't place the TV set in direct sunlight or near a heat source.

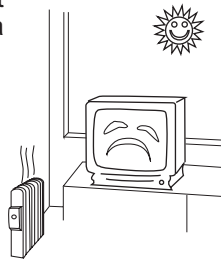

6. If the TV set is not going to be used for a long time, or there is a severe thunder & Lighting storm, it is recommended that the TV set be disconnected from the AC power outlet and the aerial plug removed.

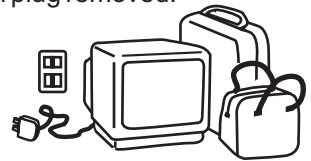

## Cleaning the tube

If the picture tube require cleaning, disconnect the power and use a dry soft cotton cloth. Do not use any cleaner or abrasive cloths.

# Installation

## Antenna connection

If the picture is not clear or is snowy, it is recommended that an External Aerial is used, this is usually mounted outside.

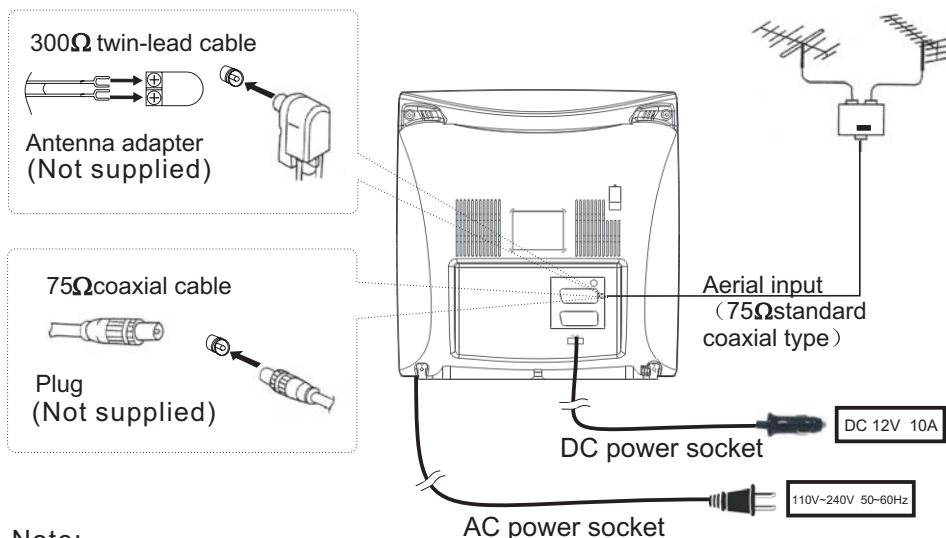

Note:

- \* It is recommended that a 75 ohm coaxial antenna is used to avoid interference.
- \*To avoid interference from electrical signals, do not bind the antenna cable together with any mains lead.
- \*The DC input AC input is separately. Do not use them together.

## Preparation for the remote control

### Battery installation

Remove the battery cover.

Insert two size AA batteries matching the +/- polarities of the battery to the +/- marks inside the battery compartment.

### Tips for remote operation

When the remote control will not be used for a long period of time or when the batteries are worn out, remove the batteries to prevent leakage.

Do not throw the batteries into fire. Dispose of used batteries in the specified manner.

Do not drop, dampen or disassemble the remote control.

# Function Buttons and External Sockets

## Front panel the TV set

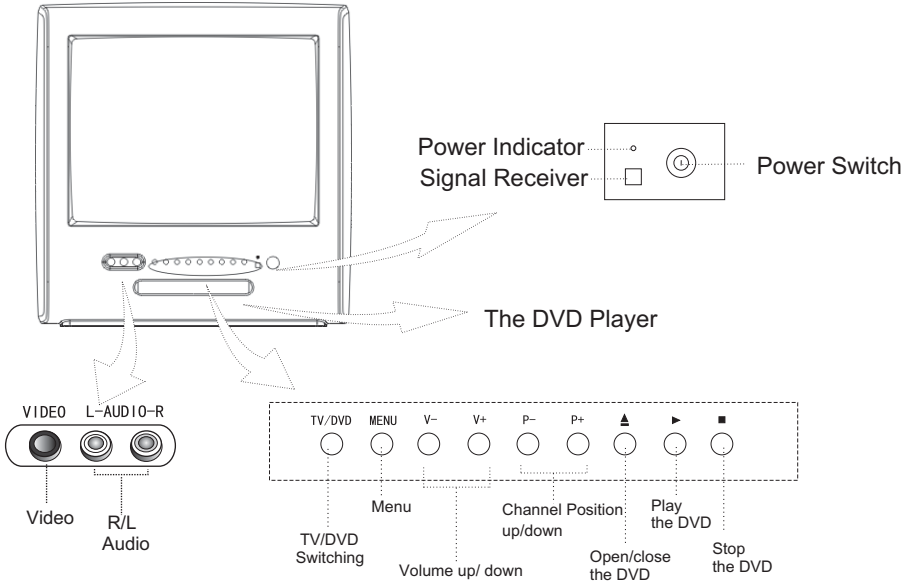

## Rear panel of the TV set

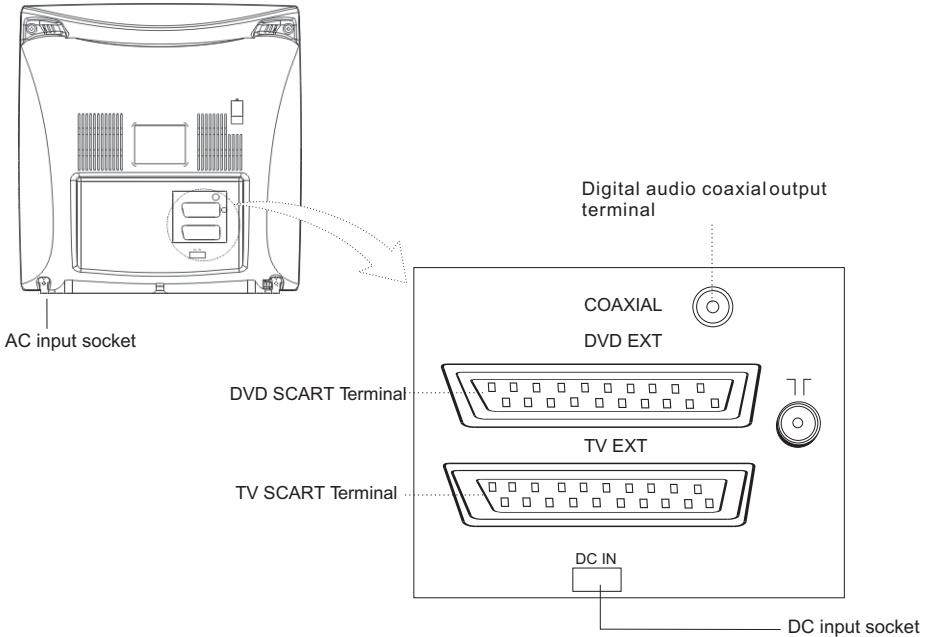

# Using the Remote Control

## Buttons on the remote control

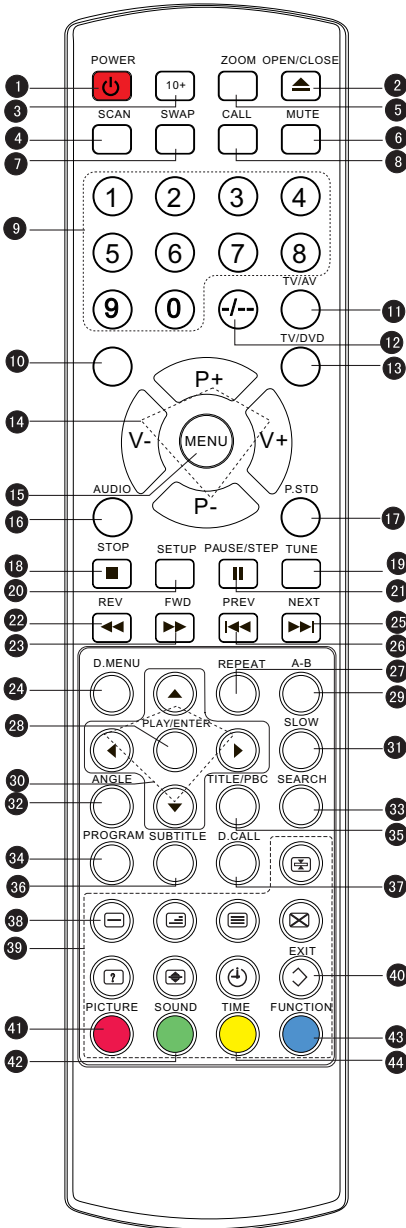

- 1 Stand By
- 2 DVD Open/close
- 3 DVD 10+
- 4 Scan
- 5 Zoom
- 6 Mute
- 7 Former Program
- 8 Call Screen Display
- 9 Program Number
- 10 (No available)
- 11 TV/AV Exchange
- 12 Digital Selector
- 13 TV/DVD
- 14 Volume/Channel Selection
- 15 MENU
- 16 DVD Audio
- 17 Picture Mode
- 18 DVD STOP
- 19 Tune Menu Button
- 20 DVD SETUP
- 21 DVD PAUSE/STEP
- 22 DVD FAST REVERSE
- 23 DVD FAST FORWARD
- 24 DVD MENU
- 25 DVD NEXT
- 26 DVD PREVIOUS
- 27 DVD REPEAT
- 28 DVD PLAY/ENTER
- 29 DVD A-B REPEAT
- 30 DVD Cursor Move button
- 31 DVD SLOW
- 32 DVD ANGLE
- 33 DVD SEARCH
- 34 DVD PROGRAM
- 35 DVD TITLE
- 36 DVD SUBTITLE
- 37 DVD CALL
- 38 (No available)
- 39 TELETEXT BUTTONS
- 40 Exit Screen Display
- 41 PICTURE MENU BUTTON (Red)
- 42 Green Button
- 43 FUNCTION MENU BUTTON (Blue)
- 44 TIME MENU BUTTON (Yellow)

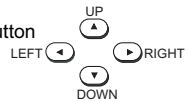

## Switching on/ off the TV set

- This section explains the use of the power button and remote handset to turn your unit on and off.

### Switching on/ off the TV set

#### Switching on/ off the TV set

1 Please press the power switch to switch on AC power supply and the power indicator will light.

2 If the indicator is lighting in red, press the button  on the remote control again.

Note:

1 When you don't operate the TV set with a remote control, you can turn on it directly through pressing the channel buttons on the TV set (Child Lock must be turned off).

4  
AUTO  
BG

2 If you want to exchange to standby status, please press down the button  on the remote control.

3 If you want to fully switch off the power supply for the TV set, please press the power switch button on the TV set.

#### Auto switch-off function

If transmissions are finished for the day, the Automatic Power Off feature will put the TV to standby automatically. The Automatic Power Off feature will not operate in AV mode or when the background is set to off (see page 18).

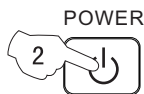

# Watching TV

- You can watch TV program in a preset channel.

## Watching TV program

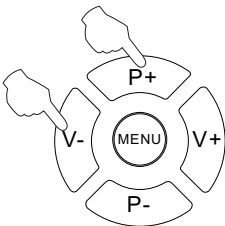
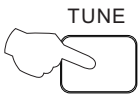
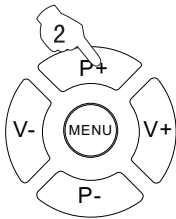
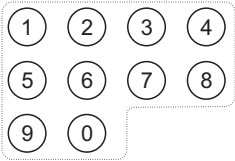

## How to select TV program

### Select the desired program

#### 1 Using "Program number" buttons

- Directly enter the channel number with the numeric keypad on the remote control.
- To select channel numbers from 10 ~ 99 press [-/-] button and enter the two digit channel number
- To select channel numbers from 100 ~ 218 press [-/-] button twice and enter the 3 digit channel number

#### 2 Using the P+/- buttons

- Press the P+ button to increase channel number.
- Press the P- button to decrease channel number.

### Select the desired sound

Press the V-/+ buttons on the remote or the front of the TV set to adjust the volume level. The range is 0~100. When the volume buttons are pressed the volume level is displayed automatically on the TV screen.

Press the TUNE button, the TUNE menu shown on the right display on the screen.

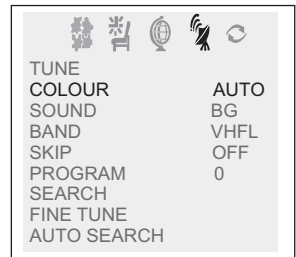

- If the picture colour is incorrect  
This may be due to the TV being set to the incorrect standard. Use P+ or P- to select Colour then the V+ /V- buttons to change between Auto, PAL, NTSC and NTSC443. Press the EXIT button to save the setting.
- If the picture sound is abnormal  
Use the CH+/- buttons to select Sound then press the VOL-/+ buttons to select the sound system.  
(In general, DK, BG will display in turn.)



## Watching TV (continued)

- Swap function enables quick swap to the last watched program.
- Auto scan function enables automatic successive scanning of all the programs in memory with "OFF" skip status (each channel will last about 2 seconds).

### Program swap and auto scan functions

#### Program swap

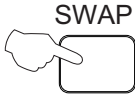

1 Suppose the channel number you used just now is 8 and the channel number you are using is 18 (as shown in the figure).

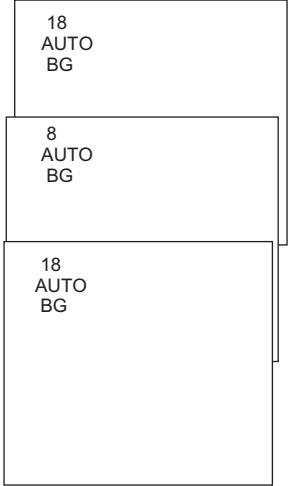

2 If you want to return to the last watched program channel 8, you can simply press the SWAP button.

3 If you want to return to channel 18, press the button again. Through this function, you can easily change between the channel you are using and the channel you used last time.

#### Auto program scan



1 Press the SCAN button to scan through all the memorized TV channels. The scan will pause for about 2 seconds on each channel.

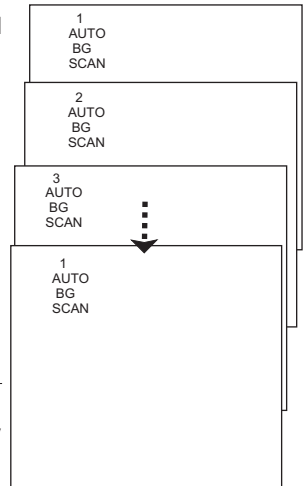

2 If you want to stop the function during auto scanning, simply press the SCAN button again.

# Searching channel

- This TV set has three methods to set the channels, which are respectively full automatic, semi-automatic and manual fine tune.
- In this section, how to use the remote control to set the channel is explained. You can also use the buttons on the TV set to set channel.

## Full automatic mode

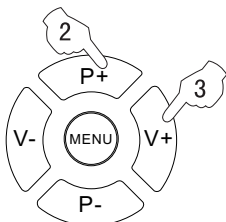

### Automatic search

1 Press the TUNE button, the TUNE menu shown on the right display on the screen.

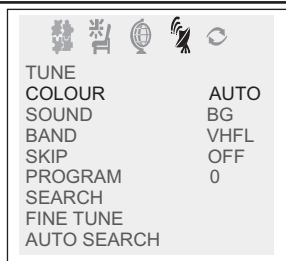

2 Press the P+/- buttons to select "AUTO SEARCH".

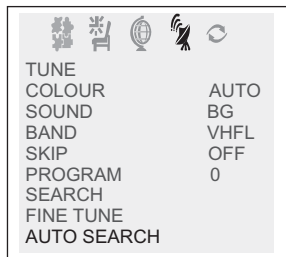

3 Press the V+ button to ensure automatic search function operates. All channels now playing program will be automatically preset in order. After the search has finished, the first program number will display on the screen.

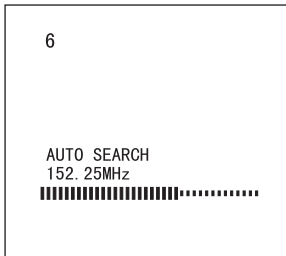

### Display function

Press the CALL button, then the channel number and the systems will be displayed on the screen.

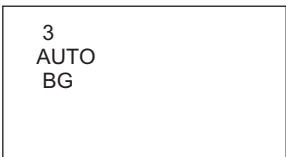

# Searching channel

(Continued)

## Semi-automatic search

### Semi-automatic search

1 Press the P+/- buttons or PROGRAM NUMBER (0-9) buttons to choose desired channels (I.E. channel 1) .

1  
AUTO  
BG

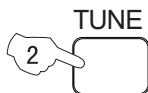

2 Press the TUNE button, the TUNE menu shown on the right display on the screen.

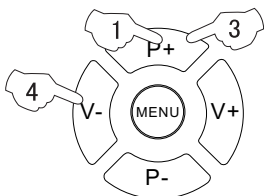

3 Press the P+/- buttons to select "SEARCH".

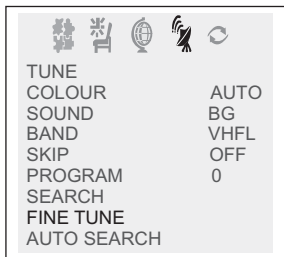

4 Press the V-/+ buttons to start searching.

The V- (down) button is used for lower side program search.

The V+ (up) button is used for higher side program search.

Repeat this step, till find the desired channel.

6

SEARCH  
152.25MHz



### To turn off the on-screen menu

In general, after you press the MENU button, the menu item display (PICTURE, TIME, FUNCTION, TUNE, EXCHANGE, ETC.) will automatically disappear within 15 seconds. If you want to eliminate these contents immediately, please press the EXIT button.

# Searching channel

(Continued)

## Manual fine tune

### Manual fine tune

If the picture and/or sound are poor, try using the FINE TUNE feature. Do not use this feature unless reception is poor.

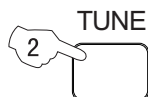
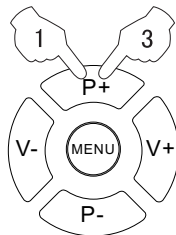

1 Press the P+/- buttons or PROGRAM NUMBER (0-9) button to choose desired channels (I.E. channel 1).

1  
AUTO  
BG

2 Press the TUNE button, the TUNE menu shown on the right display on the screen.

3 Press the P+/- buttons to select "FINE TUNE".

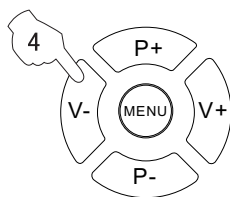
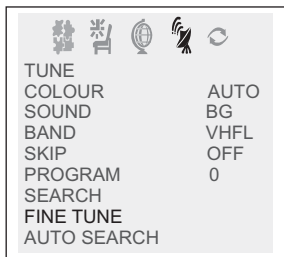

4 Press the V-/+ buttons all through to carry out fine tune, till the best picture and sound are obtained.

5

FINE TUNE  
152.25MHz



# Searching channel

(Continued)

## Program skip

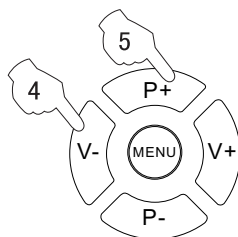
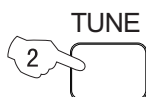
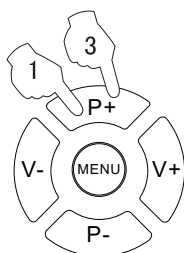







## Program skip

Channels can be set so that they are skipped during program selection.

1 Press the P+/- buttons or PROGRAM NUMBER (0-9) button to choose desired channels (I.E. channel 1).







1  
AUTO  
BG

2 Press the TUNE button, the TUNE menu shown on the right display on the screen.

					
TUNE	COLOUR	SOUND	BAND	SKIP	PROGRAM
					SEARCH
					FINE TUNE
					AUTO SEARCH
					AUTO
					BG
					VHFL
					OFF
					0

3 Press the P+/- buttons to select "SKIP".

4 Press the V-/+ buttons to turn the SKIP function "ON".

					
TUNE	COLOUR	SOUND	BAND	SKIP	PROGRAM
					SEARCH
					FINE TUNE
					AUTO SEARCH
					AUTO
					BG
					VHFL
					ON
					0

5 Press the TUNE button to close the menu. When you use the P+/- buttons to select channel, this channel will be skipped. However, you can still use the PROGRAM NUMBER buttons to select the skipped channel numbers.

## If you want to recover the skipped channel

- 1 Use the PROGRAM NUMBER buttons to select the channel number to be recovered.
- 2 Repeat those steps just now.
- 3 Press the V-/+ buttons to turn the SKIP function "OFF".

# Convenient picture and sound control functions

## Multiple picture modes



### How to select picture modes

You can quickly select the desired picture mode from four preset modes and one customized mode.

Press the P.STD button to select the desired picture quality. Five kinds of picture modes (i.e., "STANDARD", "RICH", "USER", "LISTEN", "SOFT" ) can be selected in turn.

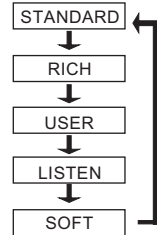

The 5 modes are

- Listen-This is a new feature that blacks out the TV screen when listening to music only channels;
- Soft-Designed for night time low light viewing;
- Standard -Designed for rooms that have good all round lighting;
- Rich-Designed for rooms with high ambient lighting such as daytime sport;
- User-A spare setting that can be adjusted to personal tastes.

### PICTURE

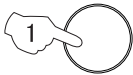

### How to customize your own picture status

1 Press the PICTURE button, the PICTURE menu shown on the right display on the screen.

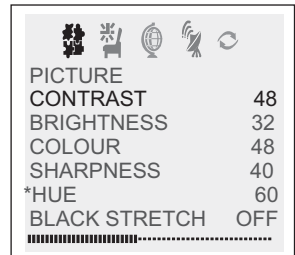

2 Press the P+/- buttons to select the item to adjusted, then press the V-/+ buttons to obtain the desired effect.

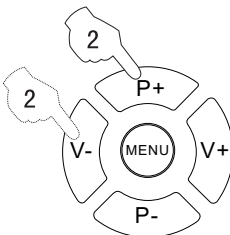

ITEM	Press V -	Press V +
CONTRAST	Weak	Strong
BRIGHTNESS	Dark	Bright
COLOUR	Shallow	Deep
SHARPNESS	Soft	Sharp
*Hue	lean to purple	lean to green

Note:

The "Hue" item only appears when the colour system is NTSC.

# Convenient picture and sound control functions

(Continued)

- Black Stretch Automatically increases the contrast range
- Noise Reduce Picture Noise & Grain Reduction Circuit. (Use only on poor reception)

## Black stretch and noise reduce

### PICTURE

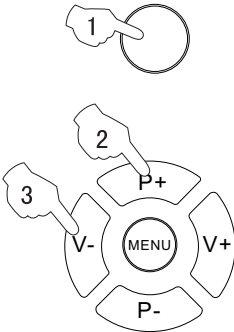

### How to select BLACK STRETCH

1 Press the PICTURE button, the PICTURE menu shown on the right display on the screen.

PICTURE	
CONTRAST	48
BRIGHTNESS	32
COLOUR	48
SHARPNESS	40
*HUE	60
BLACK STRETCH	OFF

2 Press the P+/- buttons to select "BLACK STRETCH".

3 Press the V-/+ buttons to turn the BLACK STRETCH function "ON" or "OFF".

PICTURE	
CONTRAST	48
BRIGHTNESS	32
COLOUR	48
SHARPNESS	40
*HUE	60
BLACK STRETCH	ON

### FUNCTION

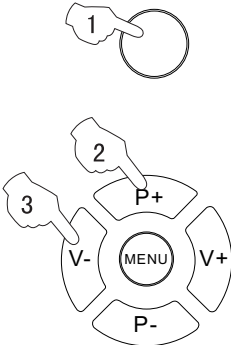

1 Press the FUNCTION button, the FUNCTION menu shown on the right display on the screen.

FUNCTION	
ENGLISH	
BACKGROUND	ON
NOISE REDUCE	ON
FADE	ON
CHILD LOCK	OFF
AVL	ON
CALENDAR	

2 Press the P+/- buttons to select "NOISE REDUCE".

3 Press the V-/+ buttons to turn the NOISE REDUCE function "ON" or "OFF".

FUNCTION	
ENGLISH	
BACKGROUND	ON
NOISE REDUCE	ON
FADE	ON
CHILD LOCK	OFF
AVL	ON
CALENDAR	

# Convenient picture and sound control functions

(Continued)

## Mute, Select Language and Fade function

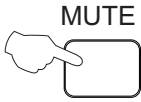

### Sound mute

1 Press the MUTE button on the remote control to turn off the sound. MUTE will appear on the top left of the display.

MUTE

2 Press MUTE again to turn the sound back on.

### FUNCTION



1 Press the FUNCTION menu button, till the FUNCTION menu shown on the right display on the screen.

	FUNCTION	
	ENGLISH	
	BACKGROUND	ON
	NOISE REDUCE	OFF
	FADE	ON
	CHILD LOCK	OFF
	AVL	ON
	CALENDAR	ON

2 Press the P+/- button to select " ENGLISH ".

3 Press the V-/V+ buttons to select the OSD language.

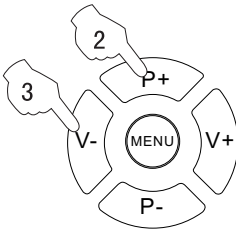

### FADE FUNCTION

Using on/off fade function, the TV turn on or turn off mild.

1 Press the FUNCTION button, the FUNCTION menu shown on the right display on the screen.

	FUNCTION	
	ENGLISH	
	BACKGROUND	ON
	NOISE REDUCE	OFF
	FADE	ON
	CHILD LOCK	OFF
	AVL	ON
	CALENDAR	ON

2 Press the P+/- button to select FADE.

3 Press V-/V+ buttons to turn the FADE function ON or OFF.

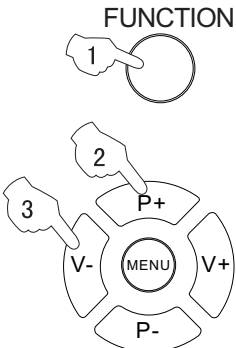



# Time functions

## Clock setting and timer on/off functions

### Clock setting

The clock will only work if the TV set is left turned on or in standby. When the set is disconnected from the power supply or is turned off by the main power on the front panel, the clock loses power and will need to be reset when the power is reconnected.

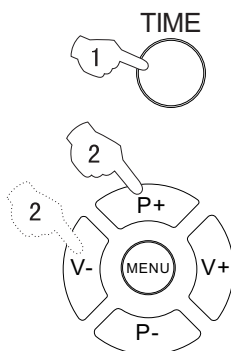

1 Press the TIME button, and the TIME menu display on the screen.

TIME		
CLOCK		17:18
ON TIME		18:00
ON PROG		1
OFF TIME		--:--
SLEEP TIMER		0
REMIN TIME		--:--
REMIN PROG		1

2 Press the P+/- buttons select "CLOCK", then press the V-/+ buttons to adjust the time in hour position; press again the P+/- buttons to select the time in minute position, then press the V-/+ buttons to adjust the value of minutes.

### On/off timer

Using on/off timer function, the TV set can automatically turn on to a preset program or shut down in a preset time.

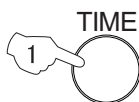

1 Press the TIME button to call up the TIME menu on the screen.

TIME		
CLOCK		17:18
ON TIME		18:00
ON PROG		1
OFF TIME		--:--
SLEEP TIMER		0
REMIN TIME		--:--
REMIN PROG		1

2 Press the P+/- buttons to select "ON TIME", then press the V-/+ buttons to set the value in hour position; press again the P+/- buttons to select the minute position and set the value of the minute. (take 18:00 as an example)

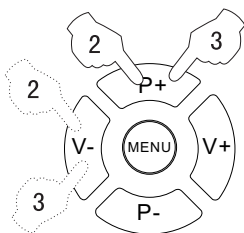

3 Press the P+/- buttons to select "ON PROG", then press the V-/+ or program direct number buttons to select your desired channel (take 8 as an example).

TIME		
CLOCK		17:18
ON TIME		18:00
ON PROG		8
OFF TIME		23:00
SLEEP TIMER		0
REMIN TIME		--:--
REMIN PROG		1

4 Repeat step 1-2 to set OFF TIME. (take 23:00 as an example)

# Time functions

(Continued)

## Sleep timer and program preset

### Sleep timer

The TV set have 18 sections option for sleep timer function (each section has a time interval of 10 minutes) (See right chart):

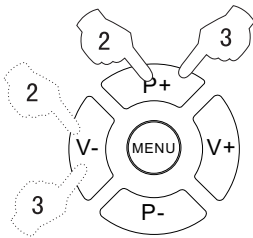
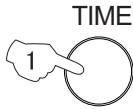
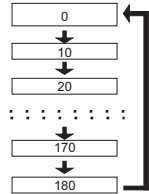

1 Press the TIME button, and the TIME menu display on the screen.

2 Press the P+/- buttons to select "SLEEP TIMER".

3 press the V -/+ buttons to set the value of the SLEEP TIMER.

TIME				
CLOCK				17:18
ON TIME				18:00
ON PROG				8
OFF TIME				23:00
SLEEP TIMER				120
REMIN TIME				--
REMIN PROG				1

### REMIND PROG function

Program remind timer, that displays an on-screen reminder prompt, when a program on a different channel is due to start.

1 Press the TIME button to call up the TIME menu on the screen.

2 Press the P+/- buttons to select "REMIND TIME", then press the V-/+ buttons to set the value in hour position; press again the P+/- buttons to select the minute position, and then set the value of the minute. (take 19:00 as an example)

3. Press the P+/- buttons to select "REMIND PROG", then press the V -/+ buttons or the program direct number buttons to set the desired channel (take 18 as an example).

TIME				
CLOCK				17:18
ON TIME				18:00
ON PROG				8
OFF TIME				23:00
SLEEP TIMER				120
REMIN TIME				19:00
REMIN PROG				1

TIME				
CLOCK				17:18
ON TIME				18:00
ON PROG				8
OFF TIME				23:00
SLEEP TIMER				120
REMIN TIME				19:00
REMIN PROG				18

NOTE: For REMIND PROG to operate CHILD LOCK must be turned off.

# Set up function

## Screen saver and childlock functions

### How to start screen saver function

When the background function is ON a bouncing 'NO SIGNAL' will be displayed on a blue background.

NO SIGNAL

FUNCTION

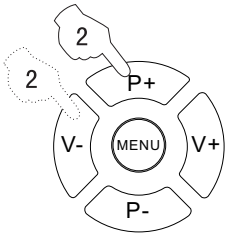
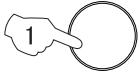

1 Press the FUNCTION button, the FUNCTION menu shown on the right display on the screen.

2 Press the P+/- buttons to select "BACKGROUND" and press the V-/+ buttons to turn the BACKGROUND function "ON".

FUNCTION	
LANGUAGE	
BACKGROUND	ON
NOISE REDUCE	ON
FADE	ON
CHILD LOCK	OFF
AVL	ON
CALENDAR	ON

### Child lock function

Enables the TV front control buttons to be locked.

FUNCTION

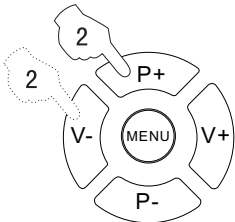

1 Press the FUNCTION button, the FUNCTION menu shown on the right display on the screen.

2 Press the P+/- buttons to select "CHILD LOCK" and press the V-/+ buttons to turn CHILD LOCK function "ON".

FUNCTION	
LANGUAGE	
BACKGROUND	ON
NOISE REDUCE	ON
FADE	ON
CHILD LOCK	ON
AVL	ON
CALENDAR	ON

#### NOTE:

All the control panel buttons on the front of the TV are disabled when CHILD LOCK is turned on. The power switch will still turn the TV set off.

# Set up function

## (Continued)

### AVL and calendar functions

#### FUNCTION

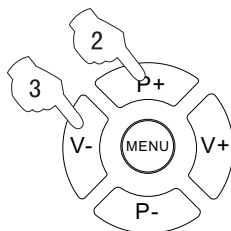

#### FUNCTION

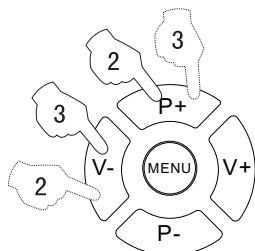

### AVL function

Automatic Volume Limit Control reduces the effect of large volume changes. For instance, when advertisements come on.

1 Press the FUNCTION button, the FUNCTION menu shown on the right display on the screen.

FUNCTION	
LANGUAGE	
BACKGROUND	ON
NOISE REDUCE	ON
FADE	ON
CHILD LOCK	OFF
AVL	ON
CALENDAR	

2 Press the P+/- buttons to select "AVL" .

3 Press V-/+ buttons to turn the AVL function "ON" or "OFF".

FUNCTION	
LANGUAGE	
BACKGROUND	ON
NOISE REDUCE	ON
FADE	ON
CHILD LOCK	OFF
AVL	ON
CALENDAR	

### Calendar function

Enables the TV sets internal calendar to be set.

1 Press the FUNCTION button, the FUNCTION menu shown on the right display on the screen.

FUNCTION	
LANGUAGE	
BACKGROUND	ON
NOISE REDUCE	ON
FADE	ON
CHILD LOCK	OFF
AVL	ON
CALENDAR	

2 Press the P+/- buttons to select "CALENDAR", then press the V-/+ buttons to the CALENDAR display on the screen.

3 Press the P+/- buttons to turn the YEAR/MONTH/DAY, press V-/+ buttons to set or adjust the YEAR/MONTH/DAY.

Y: 2001	M: 11	D: 14				
S	M	T	W	T	F	S
				1	2	3
4	5	6	7	8	9	10
11	12	13	14	15	16	17
18	19	20	21	22	23	24
25	26	27	28	29	30	

# Position exchange function

## Exchange

### Exchange

This feature enables TV programs that may be on a wrong TV channel number to be swapped/exchanged. This feature is very useful when Automatic Search Tuning has been used, to reallocate the found programs to the correct channel numbers.

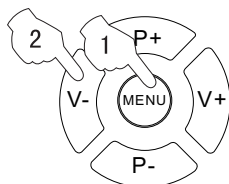

1 Press the MENU button , till the EXCHANGE menu display on the screen.

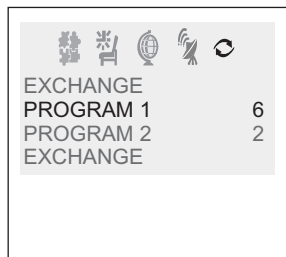

2 Press the V-/V+ buttons or the PROGRAM NUMBER (0-9) buttons to set PROGRAM 1 TO 6.

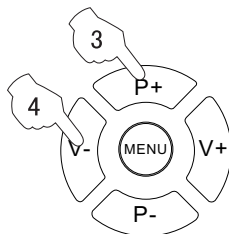

3 Press the P+/- buttons to select "PROGRAM 2".

4 Press the V-/V+ buttons or the PROGRAM NUMBER (0-9) buttons to set PROGRAM 2 TO 9.

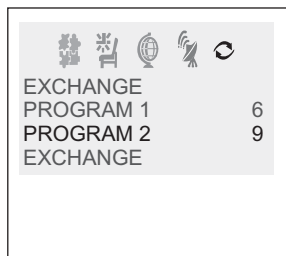

5 Press the P+/- buttons to select "EXCHANGE".

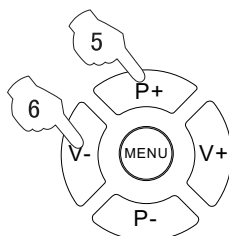

6 Press the V-/V+ buttons to set "EXCHANGE".

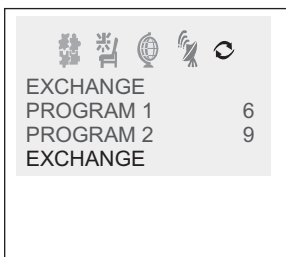

# Teletext

- Teletext is an information system, broadcast by certain channels, which can be read like a newspaper . It also provides subtitles for people with hearing difficulties or those who are unfamiliar with the language in which a particular program is being broadcast (cable networks, satellite channels, etc.).

## Teletext

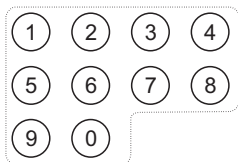
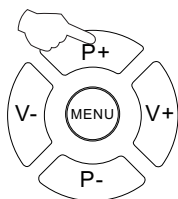

TUNE

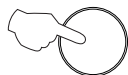

## Teletext functions

To select "Teletext" press the Teletext button on the handset. To switch off Teletext, press the button again. "Note all menufunctions are not available in Teletext mode". Only a few direct button control functions are available in TELETEXT mode, they are:

- Volume adjustment, but without OSD display.
- Mute function, but without OSD display.

### Page up/down

Use the P+/- buttons to browse next or previous page.

### Page number entering

To select a Teletext page, enter the page number using the numeric key pad on the remote control, or use the P+ or P- buttons, or the coloured Fast text buttons.

### Mix mode

To view the TV picture while in Text mode press the  button, this will superimpose the Teletext data on top of the Tv picture. Press this button again to return to Full text.

### INDEX

Press the tune button to go to the index page of teletext.

# Teletext

(Continued)

## Teletext

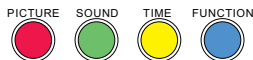

### Cancel mode

This feature allows the TV picture to be displayed while next page to be searched is entered and found. Only the top teletext line is displayed until the page is found. Press the button to hide the teletext information. Either press the  button or the Text button to exit the cancel display mode.

### Language change

Pressing the  button will change the Teletext characters between Eastern and Western.

### Hold

Pressing the  button will stop the teletext page automatically updating. This feature is very useful where there are several teletext pages or data on the same page number.

### Size

Pressing the  button changes between full screen top half bottom half full screen. This feature is very useful as it magnifies the image making the characters easier to read.

### Reveal

Pressing the  button will reveal hidden text. This feature is used to reveal information such as answers to Teletext on-line interactive puzzles.

### Subcode / Time

By entering its 4-digit number to enter a secondary page; While in normal TV mode only, pressing the  button will display the teletext time in the top right hand corner for a few seconds.

### Switch teletext on/off

Press the  button on the remote control to turn teletext On/Off.

### Fast text coloured buttons

Fast text automatically displays the four most commonly used pages that the broadcaster thinks that you may want to choose next. Press the same coloured button on the remote control as the coloured link at the bottom of the teletext page to go directly to that page.

# Basic Playback

## Basic Playback

### Preparations

- Press the TV/DVD button on the remote control or the TV to enter the DVD status.

### Basic playback

1. Press OPEN/CLOSE to open the disc tray, place a disc on the disc tray.  
There are two different disc sizes. Place the disc in the correct guide on the disc tray. If the disc is out of the guide, it may damage the disc and cause the DVD player to malfunction.
  - Do not place a disc which is unplayable in this DVD player.
2. Press OPEN/CLOSE to close the disc tray, the playback will automatically start.
  - Some discs do not start automatically. Press PLAY/ENTER to start playback.
3. Some discs may start playback with a menu. Use the cursor buttons on the remote control to select menu options and press PLAY/ENTER to start. You may also press the digit buttons to select a menu option directly. Many DVDs will not allow this during start-up.

### Pause playback

1. Press PAUSE/STEP to pause playback (still mode).  
The sound will be muted during still mode.
2. Press PLAY/ENTER to resume normal playback.

### Stop playback

1. Press STOP ■ button to go to stop mode, the TV screen will show the start logo. For some discs the player can recall the location where stopped, such as DVDs and audio CDs.
2. Press PLAY/ENTER to resume playback from the location where playback was stopped.
3. Press STOP twice to stop completely.  
Play must then resume from the title beginning.

### Previous and Next

During Playing, pressing the PREV ◀ key will restart the current chapter and skip chapters backwards with each subsequent press until the start of the disc is reached.  
Each press of NEXT ▶ key during playing will skip the current chapter and play the next one.  
In the case of CD audio and photo discs the next track, song or photo is selected.

### Fast forward and Fast reverse

1. Press FWD ►► to fast forward through the disc.  
Each time the FWD ►► button is pressed, the fast forward motion speed changes.
2. Press PLAY/ENTER to resume normal playback.
3. Press REV ◀◀ to fast reverse through the disc.  
Each time the REV ◀◀ button is pressed, the fast reverse motion speed changes.
4. Press PLAY/ENTER to resume normal playback.

### Single step playback

1. When paused, press PAUSE/STEP repeatedly to single step forward frame by frame in the video.
2. Press PLAY/ENTER to resume normal playback.



# Advanced Playback

## Advanced Playback

### IMPORTANT NOTE:

ALL DESCRIBING FUNCTION IS FOR DVD DISCS. IF YOU PLAY OTHER FORMAT DISC, THE OPERATION AND DISPLAY ON SCREEN WILL BE SOME DIFFERENCE.

#### SUBTITLE

Press "SUBTITLE", the screen will display "SUBTITLE 01/XX XXXXX", "01" indicates the ordinal number of this language; "XX" indicates total number of language; "XXXXXX" indicates the language of country. (the number of language depends on disc). This function can select up to 32 languages displayed on screen.

#### REPEAT

Press "REPEAT" and Chapter repeat will be displayed on screen, the second press will display Title repeat, the third press will display All repeat, the fourth press will cancel this function.

#### A-B

Press "A-B" to begin start-point, press again to set an end point and complete setting. The selected section A-B will be repeated. The third press will cancel this function.

#### ANGLE

When enjoying sports, concert or theatre, press this key to watch same actions in different angles. (Valid for discs possessing this function. Using a disc recorded in multi-angle you can view the scene from different angles, for example, front, side, whole view and exterior scene).

#### D.MENU

Press this key to display root menu, select item according to your preference. (This function will work with a DVD having a multi-layer menu.)

#### D.CALL

Pressing this key will cycle through "title elapsed", "title remain", "chapter elapsed", "chapter remain" and "display off". Each displays the appropriate time information.

#### PROGRAM

When playing discs, press "PROGRAM" to enter program mode. Starting with program number "01" highlighted, press the digit buttons to select the title and chapter number that you want. When finished move the cursor to select "START". This will start the program playback.

#### SEARCH

Press "SEARCH" once to display Disc Go To --:--, use numeric key to enter the desired time of Disc. Press "SEARCH" twice to display Track Go To --:--, use numeric keys to enter the desired time of track. Press "SEARCH" 3 times to display Select Track --/03, use numeric keys to enter the desired track.

#### SLOW

Press SLOW to play a disc in slow forward. Each time the SLOW button is pressed, the slow motion speed changes. Press PLAY/ENTER to resume normal playback;

**Note:** This function is invalid for CD and MP3.

#### TITLE/PBC

With some DVD discs pressing this key will display the title menu. You can then use the digit buttons to select the item you prefer.

#### AUDIO

Press this key can change the audio mode. such as: Audio 1/2: AC 3 2 CH English  
Audio 2/2: AC 3 5.1 CH English

For CD audio, press this button to cycle between Mono Left, Mono Right, Mix-Mono and Stereo.

**Note:** When press this button continuously, you must above 3 seconds interval.

## Special Function Playback

### JPEG DISC PLAYBACK

When a disc containing standard JPEG picture files is inserted into the player, a navigation menu will be displayed automatically. Use the UP and DOWN cursor buttons to select a file then press PLAY/ENTER. The slide show will commence. Press PREVIOUS or NEXT to move between pictures. Press pause to stop on the current picture. Press PLAY/ENTER to resume normal playing.

**NOTE:** The actual content will be different as per disc.

### MP3 PLAYBACK

When playing an MP3 disc, a navigation menu will be displayed automatically. In the menu, use UP or DOWN cursor buttons to choose the folder, then press PLAY/ENTER to enter the folder. Use the UP and DOWN cursor buttons to select the file and press PLAY/ENTER. Pressing the LEFT cursor button will take you to the previous screen/menu.

### SCREEN SAVER FUNCTION

This unit employs a screen saver mode to help protect the tube during static video pictures. This can be turned off on the GENERAL SETUP PAGE (see Pg. 27)

### MPEG4 DISC FUNCTION INTRODUCTION

MPEG-4 is the fourth video and audio encoding standard released by MPEG (The abbreviation of "Moving Pictures Experts Group"). VCD is based on MPEG-1 technology and DVD is based on MPEG-2. MPEG-4 takes advantage of narrow bandwidth, pursue the best picture quality by compress and transmit the data in frame reconstruct technology. The audio data is compressed by WMA or MP3 standard. MPEG-4 is the most advanced compression technology standard in AV field. It has the highest compression rate. By MPEG-4 technology, we can encode and compress a DVD film into one or two CD-R disc with pretty good picture quality, or can burn several films that has same quality as VCD into one CD-R disc, or can burn several films that has similar quality to DVD into DVD-ROM disc.

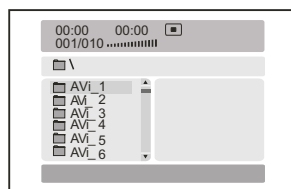

Note:

1. The MPEG-4 discs in market now have many different formats, such as XVID, AVI, DIVX, RM etc. But some discs with "MPEG4" logo in market are not encoded by MPEG technology. It is normal that some of the discs can't be played well in this player because of the incorrect encoding standard.
2. The MPEG-4 disc in market now have many different type of subtitle, it is normal that some of the subtitle cannot be read.
3. WMA format will be supported as a single audio file or associated with a DivX5 or Xvid video file.
4. GMC supported with DivX5 files, but not with Xvid files

# DVD System Setup

## DVD System Setup

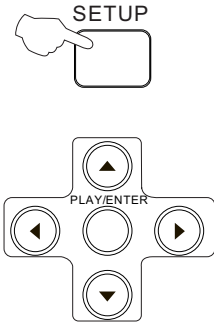

### General Setup Process

1. Press the SETUP button, the General Setup Page, Preference Page will be displayed in turn.
2. Press ▲ or ▼ to select, the item, then press ► to enter the submenu.
3. Press ▲ or ▼ to select then press PLAY/ENTER to confirm.
4. Press SETUP repeatedly to exit the set-up menus.

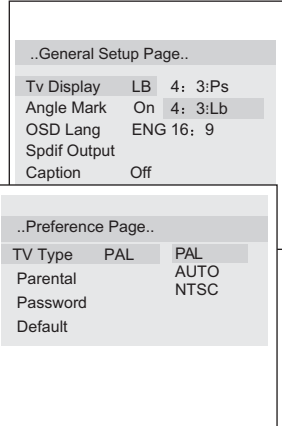

### General Setup Page

#### ASPECT RATIO DESCRIPTION

When using the DVD with the internal TV, select 4: 3/LB.

*The following information applies only when the DVD output is connected to an external TV.*

- 4: 3/PS (PS = Pan and Scan)

You may select if you have a normal aspect ratio (4:3) TV, although the NORMAL/LB (letter box) is a more common choice. In PS

mode, widescreen material will fill the screen, but at the expense of chopping off extreme left and right edges of the original film picture. For this feature to work, the disc must be specially coded. Such discs are uncommon.

- 4: 3/LB (LB = Letter Box)

You may select this if you have a normal aspect ratio (4:3) TV. Widescreen material will be shown in pure unaltered form, allowing the entire picture area of the original film to be viewed without any side cropping. Black bars will appear above and below the picture.

- 16: 9

You may select this if you have a widescreen (16:9) TV. Black bars may still appear above and below the picture even if using a widescreen TV. This is because some film directors prefer to use ultra widescreen aspect ratios e.g. 2.35:1. This will normally be indicated on the DVD packaging.

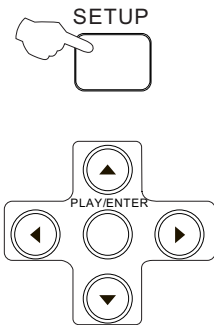
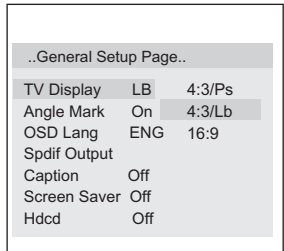

# DVD System Setup(Continued)

## DVD System Setup

### General Setup Page

**ANGLE MARK:** Users can select a particular camera angle when playing a DVD which offers multiple angles.

This item allows you to set Angle Mark ON or OFF.

**On Screen Display (OSD) Language:** Users can select on-screen display language.

**SPDIF OUTPUT MODE:** Sets the audio outputs.

This DVD player includes three kinds of audio output:

1. **SPDIF OFF:** An analog surround sound format is output through the back-panel connections for 2-CH audio out or 5.1 CH audio out.
2. **SPDIF/RAW or SPDIF/PCM:** This surround sound format is output to a Dolby Digital/DTS decoder through the coaxial connector on the back panel of the product.

**CAPTIONS:** This function allows you to display or hide the caption.

**SCREEN SAVER:** If the screen saver is on, then there will be an animated picture of DVD on the screen whenever the DVD player is idle for more than 3 minutes .

**HDCD:** When default setting is off, it will display "CD" by reading HDCD, for HDCD playback, please choose 44.1K or 88.2K.

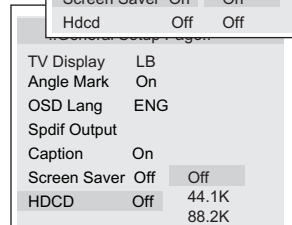
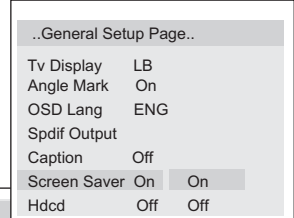
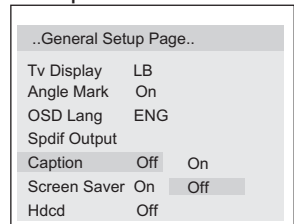
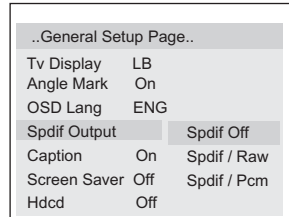
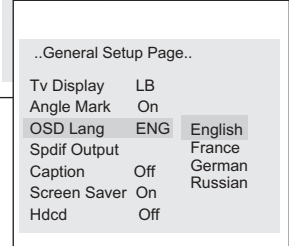
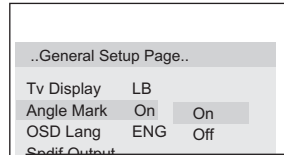

# DVD System Setup(Continued)

## DVD System Setup

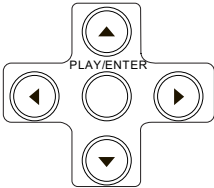

### Preference Page

The Preference Page is only available when there is no disc in the player. These settings are applied consistently to all discs which are inserted and played.

**TV TYPE:** This player supports different TV output, including MULTI(Auto), NTSC, and PAL systems. Usually please set to MULTI.

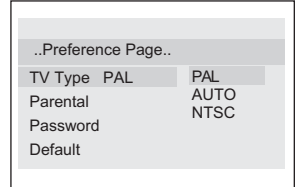

**PARENTAL:** The parental control function works in conjunction with the different censorship classes assigned to DVDs. These classes help to control the types of DVDs that the family watches, There are up to 8 censorship classes for DVDs.

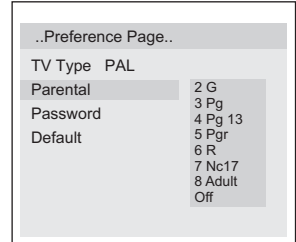

#### Note:

- 1 To change this setting you must enter your password. (Initial password is 1234)
- 2 When set to OFF, all discs may be viewed.

### PASSWORD CHANGE:

You can change your password by entering 4 digits. You must confirm the 4 digits before the new password can be accepted.

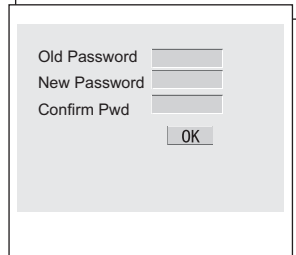
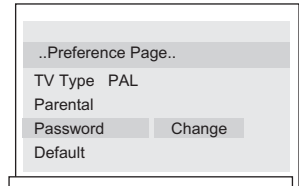

NOTE:If you forget your password or a password is accidentally set enter 1369 as the password. This will enable you to regain control.

# DVD System Setup(Continued)

## DVD System Setup

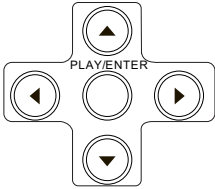
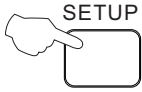

**DEFAULT:** Resets all settings (except password and parental lock status) for this DVD player back to the manufacturers original settings. Press ENTER to perform the reset.

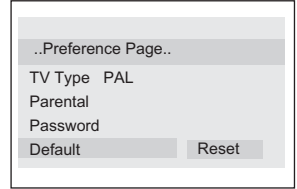









**Note:**

Some functions may not be available depending on the type of disc.

## Playable Discs

The following discs can be played:

DISCS	LABEL	CONTENTS	DIMENSION
DVD VIDEO		Audio +Video (moving picture)	12cm
			8cm
AUDIO CD		Audio	12cm
			8cm
HDCD		Audio	12cm
			8cm
MP3		Audio	12cm
			8cm
JPEG		Video(picture)	12cm
			8cm
KODAK CD		Video(picture)	12cm
			8cm
CD-R		Audio or Video (moving picture)	12cm
			8cm
CD-RW		Audio or Video (moving picture)	12cm
			8cm
CD+G		Audio(picture)	12cm
			8cm
DIVX		Audio +Video (moving picture)	12cm
			8cm

Support discs: DVD, VCD, CD-R, CD-RW, SVCD, DVCD, HDCD, JPEG, CD+G, DIVX, Kodak CD, WMA.

- You cannot play discs other than those listed above.
- You cannot play discs of non-standardized discs, even if they may be labelled as above.
- The performance of CD-R or CD-RW disc is depend on the way of disc-burning. In a few cases, their performance may be not very well or even no performance.

# Disc Protection and DVD Characteristics

## ON HANDLING DISCS

- Do not touch the playback side of the disc.
- Do not attach paper or tape to disc.

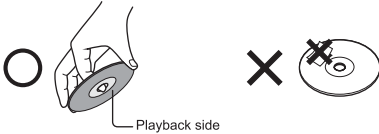

## ON CLEANING DISCS

- Fingerprints and dust on the disc cause picture and sound deterioration. Wipe the disc from the centre outwards with a soft cloth. Always keep the disc clean.



- If you can not wipe off the dust with a soft cloth, wipe the disc lightly with a slightly moistened soft cloth and finish with a dry cloth.
- Do not use any type of solvent such as thinner, benzene, commercially available cleaners or anti-static spray for vinyl Lps. It may damage the disc.

## ON STORING DISCS

- Do not store discs in a place subject to direct sunlight or near heat source.
- Do not store discs in place subject to moisture and dust such as a bathroom or near a humidifier.
- Store discs vertically in a case. Stacking or placing object on discs outside of their case may cause warping.

## STRUCTURE OF DISC CONTENTS

Normally, DVD discs are divided into titles, and the titles are sub-divided into chapters. Audio CD are divided into tracks.

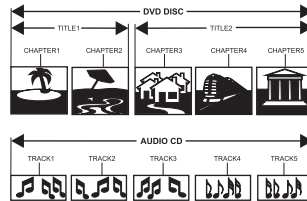

Each title, chapter, or track is assigned a number, which is called title number, chapter number or track number respectively.

There may be discs that do not have these number.

## Compare DVD disc with other discs:

	DVD				LD	SVCD	VCD	CD
Encode method	Digital/MPEG II				Analog	Digital	Digital/MPEG I	Digital
Capacity	Single-side single-layer 4.7G	Double-side single-layer 8.5G	Single-side double-layer 9.4G	Double-side double-layer 17G	/	650MB	650MB	650MB
Playing Time	133 minutes	242 minutes	266 minutes	484 minutes		Single-side 60 minutes double-side 120 minutes	45 minutes	74 minutes
Disc diameter	12cm/8cm				30cm/20cm	12cm	12cm	12cm/8cm
Horizontal resolution	More than 500 line				No more than 430 line	No more than 350 line	No more than 250 line	/
Picture proportion	Multiple kinds				One kind	One kind	One kind	/
Subtitle	32 kinds				16 kinds at most	4 kinds	/	/
Language	8 kinds				4 kinds at most	4 kinds at most	2 kinds	2 kinds
Sound quality	48KHz, 96KHz/ 6, 20, 24bit				44.1KHz/ 16bit	44.1KHz/ 16bit	44.1KHz/ 16bit	44.1KHz/ 16bit



# Connecting the TV set to the other video and audio equipment

## Connecting to the other video and audio equipment

- You can attach optional equipment such as another TV or other audio amplification equipment to the scart/digital coaxial sockets at the rear of the set to enjoy higher quality sound and picture.

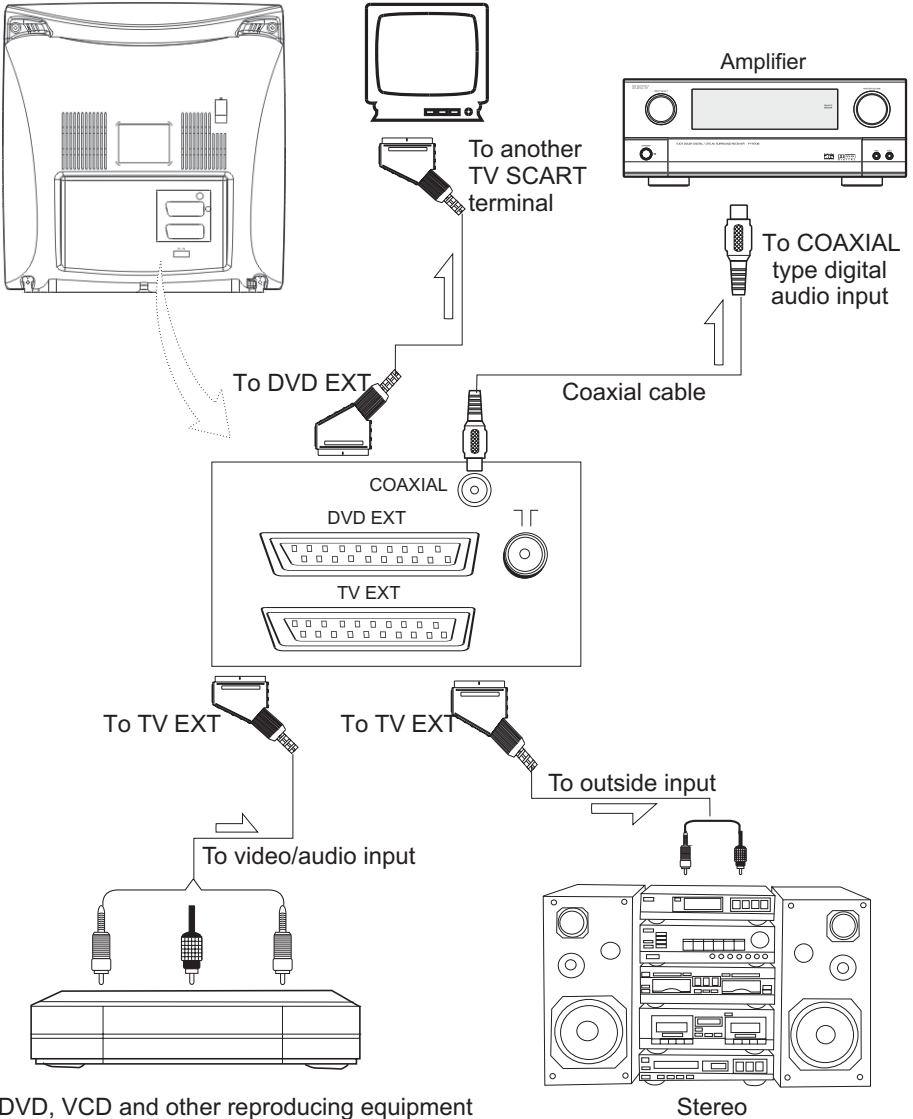















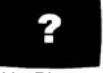

DVD, VCD and other reproducing equipment

Stereo

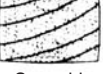
## Troubleshooting guide

- To assist in location possible faults use help guide below.

BREAKDOWN PHENOMENON		CHECKING
PICTURE	SOUND	
 Picture with snow	 Noise	The aerial direction and connection
 Double or Triple Image	 Normal	This is called ghosting which can be minimized with an outside aerial, and good quality cable and terminations. Altering the aerial direction can also minimize this effect.
 Disturb	 Noise	Electrical interference which can be caused by cars, motorbikes etc, Fluorescent lamps and dirty insulators on overhead power cables.
 Normal	 No sound	Volume Sound mute
 No Picture	 No sound	Ensure that the power supply is connected to the TV set and turned on. Also ensure that the TV set is not in "Listen Mode" or that the brightness and contrast are not turned down.
 No colour	 Normal volume	Adjust colour control
 Scramble	 Normal or Weak Volume	Adjust channel again
 Colour Spot	 Normal volume	Colour Purity fault which can be caused by moving the TV set, placing magnets near the TV screen or turning on/off house hold appliances such as vacuum cleaners near the TV set. Turn the TV off with the mains power switch for 15 minutes. When the power is turned on again the TV set will automatically degauss the picture. In some cases leave the TV set turned off overnight.

Note:

1. If the fault can not be repaired using the above guide consult with your local authorized service center.
2. The TV set must only be repaired by a qualified registered service person. Never attempt to remove the back cover as the TV set has dangerous voltages inside that may cause a fatality or fire.
3. The cabinet may produce the occasional "snapping sound" This is normal and caused by the materials in the cabinet expanding with room temperature changes.

## Specifications

- The specifications offered you here are only for reference and, with the improvement of the products ,there may be some different between the description and the practicality.

### Specifications

Colour system	PAL, SECAM, NTSC PLAYBACK
Sound system	BG,DK
Picture tube	14"colour picture tube (33.5 cm viewable)
Sound output power	2X2W (10% THD)
Power requirements	110V~240V 50~60Hz ,DC 12V 10A
Power consumption	≤ 70W
Dimension	368 (Width) x378 (Depth) x371 (Height) (mm)
Accessories	Remote control X1 Owner's manual X1 Battery(AA) X2 Antenna X1 warranty card X1

### NOTE

Design and specifications are subject to change without notice.  
Dimensions quoted in this manual are approximate.

**ORION®**