

# i View Touch User Manual



UnRegistered

# Index

<b>Safety and Warning</b>	<b>4</b>	<b>Main Supply</b>
	<b>4</b>	<b>Main Adaptor</b>
	<b>5</b>	<b>FCC Radiation Exposure Statement</b>
	<b>5</b>	<b>Warning</b>
<b>Overview</b>	<b>7</b>	<b>Components</b>
	<b>7</b>	<b>Front View</b>
	<b>8</b>	<b>Side A</b>
	<b>8</b>	<b>Side B</b>
	<b>9</b>	<b>Back</b>
<b>Operating Instructions</b>	12	Quick Start
	12	Flash
	13	Video
	13	Picture
	14	Buttons and Remote Control
	16	Screen Status Indicators
	17	Menu Features
	17	Playlist
	18	Wi-Fi
	24	Calendar
	25	Settings
	26	Power Supply Unit Electrical Data
	26	LCD Screen Specification

# Safety and Warnings

## Main Supply

This equipment is designed to operate from a 100-240 Volt, 50/60Hz AC main supply. The use of other power sources may damage this equipment. Check that the voltage marked on the rating plate located at the rear of the power adaptor states 100-240V. The manufacturer will NOT accept responsibility for damage or injury caused by connecting to the wrong voltage.

## Main Unit

This device complies with CE/FCC regulations. The device has been evaluated to meet general RF exposure requirement. The device can be used in portable exposure condition without restriction. CE in which countries where the product may be used freely: Germany, UK, Italy, Spain, Belgium, Netherlands, Portugal, Greece, Ireland, Denmark, Luxembourg, Austria, Finland, Sweden, Norway and Iceland. France except the channel 10 through 13, law prohibits the use of other channels.

## FC

### Main Adaptor

The power adaptor supplied is compatible with a standard main socket. NB. If the power adaptor or lead gets damaged, it must be replaced by a qualified service agent with an approved adaptor of the same type and rating.

Operation is subject to the following two conditions: (1) this device may not cause harmful interference, and (2) This device must accept any interference received, including interference which may cause undesired operation. This equipment has been tested and found to comply with the limits for a Class B digital device, pursuant to Part 15 of the FCC Rules. These limits are designed to provide reasonable protection against harmful interference in a residential installation. This equipment generates uses and can radiate radio frequency energy and, if not installed and used in accordance with the instructions, may cause harmful interference to radio communications. However, there is no guarantee that interference will not occur in a particular installation. If this equipment does cause harmful interference to radio or television reception, which can be determined by turning the equipment off and on, the user is encouraged to try to correct the interference by one or more of the following measures:

- Reorient or relocate the receiving antenna.
- Increase the separation between the equipment and receiver.

- Connect the equipment into an outlet on a circuit different from that to which the receiver is connected.

Consult the dealer or an experienced radio / TV technician for help. In accordance with FCC requirements, changes or modifications not expressly approved by manufacturer could void the user's authority to operate this product.

## FCC Radiation Exposure Statement

This equipment complies with FCC radiation exposure limits set forth for an uncontrolled environment. This equipment should be leave 20cm outside as well as leave within 20cm between the radiator & your body.

 Dangerous voltage constituting a risk of electric shock is present inside this equipment.

 This mark is applied to show the equipment conforms to European safety and electro-magnetic compatibility standards.

 There are important operating and maintenance instructions in the literature accompanying this equipment.

## Warning

- The main plug shall be the main disconnect device and shall remain operable at all times.
- Never let anyone push objects into holes and ventilation slots. Do not expose this product to dripping or splashing or place any objects filled with liquids on or near the product.
- Do not place a naked flame source such as lighted candles on or near this product. Do not attempt to repair this product yourself; always get a qualified service agent to carry out adjustments or repairs.

WLAN of units is been restriction in the horizontal. AML8626-H supports WiFi connection via external WiFi module or dongle. The AML8626-H interfaces to the network controller via the SDIO interface or the second USB OTG interface. The AVOS operating system provides the complete networking environment and applications.

UnRegistered

# Overview

## Components

1. i View Touch unit
2. Power Supply Unit - US, EU, UK Plugs
3. available Remote Control
4. 4 Cell Rechargeable Battery - Not included in the package. (Must be purchased separately) Desk Mount
5. Clip (not seen in picture) - Not included in the package.. (Must be purchased separately) Securing Cable (not
6. seen in picture) - Not included in the package.. (Must be purchased separately) Landscape/Portrait positioning
- 7.
8. screwdriver Landscape/Portrait
9. positioning screw User Manual

## Front View









Front View of the Product – Portrait style



Front View of the Product – Landscape style

Side A  
Setting buttons

-  **Left** In menu mode, this function is used for moving left through the various options. In playback mode you can go to the previous content in the playlist. (Note: it is only operational for content copied from USB or SD Card, not for content downloaded from i-Display Content Management System).
-  **Right** In menu mode, this function is used for moving right through the various options. In playback mode you can go to the next content in the playlist. (Note: it is only operational for content copied from USB or SD Card, not for content downloaded from i-Display Content Management System).
-  **Up** In menu mode, this button is used for moving left. In playback mode, it is used to increase the volume if current content being played is a movie.
-  **Down** In menu mode, this button is used for moving right. In playback mode, it is used to decrease the volume if current content being played is a movie.
-  **Misc** In menu mode, this function is used for the same function as the OSD button on the remote control (as explained in Remote Control section). In playback mode, it is not operational.
-  **OK** In playback mode:  
Short press - Used for making changes between  
(i) Repeat selected movie (repeats the chosen file in endless loop).  
(ii) Repeat all (repeats the entire playlist in endless loop).  
Long Press (3 seconds) - Used to return to the menu page. In menu mode:  
Short press - Used for selecting various options  
Long press (3 seconds) - Used to return to the main menu (first menu page).

Side B  
Silicon cover for slots

This reduces access to slots or prevents stealing of SD Card (if used). To insert or remove an SD Card the Silicon cover needs to be positioned as shown and can be easily opened by gently lifting up and turning clockwise. A screw can be added for extra security.

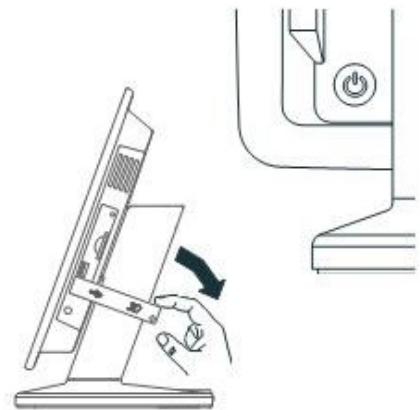



### USB slot

This is used for connecting flash drives. Once the flash drive is connected, all its content is automatically copied to the internal memory. To delete old content see Playlist section.

### SD card slot

Once an SD Card is inserted into the unit, the content on the SD Card will start to play. In menu mode, the user will be able to either play content directly from the unit's internal memory.

Important: SD Card is not included, it must be purchased separately.

### Back

#### DC connector

Located at the back of the unit's leg. Used to connect the power.

**On/Off button** Located on the back bottom section of the unit. Red button indicates the unit is

switched off. Green button indicates the unit is switched

on. Important: It takes approx 10 seconds for the first image to appear once the unit is

o

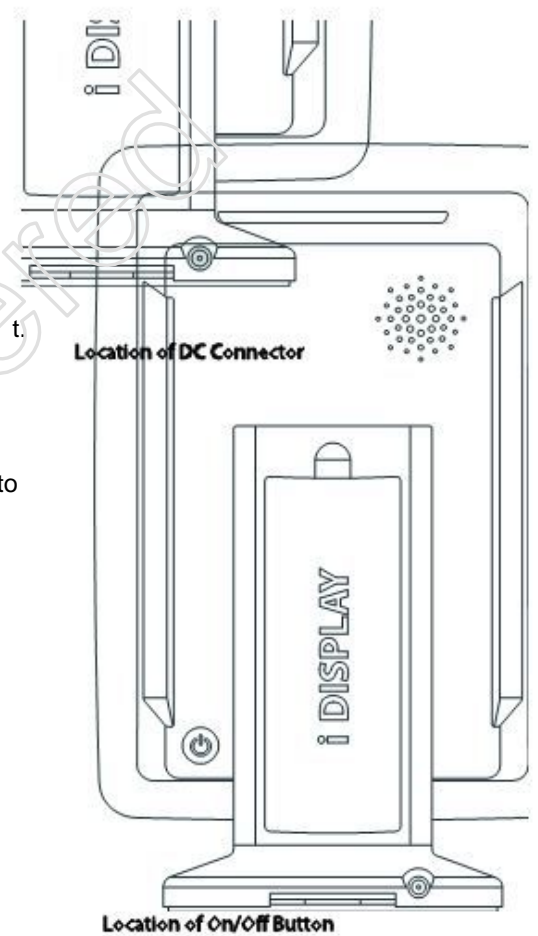

Back

Rechargeable battery slot  
Used to house the rechargeable battery.

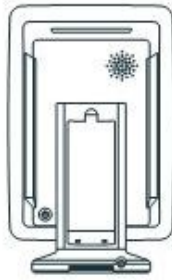

The rechargeable battery needs to be placed as shown in these images.

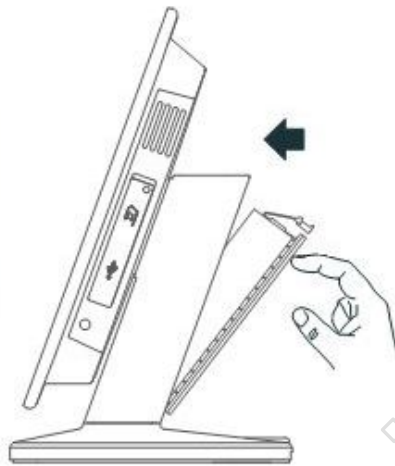

Placing the Rechargeable Battery

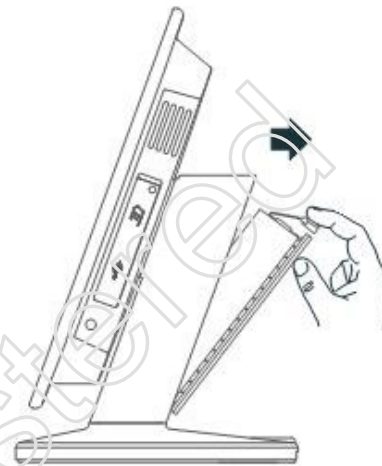

Removing the Rechargeable Battery

Rotating screen to horizontal position

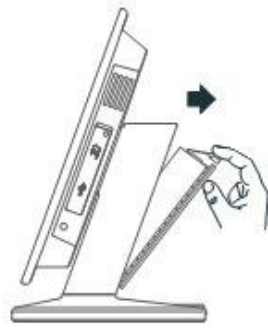

**1. Remove battery**

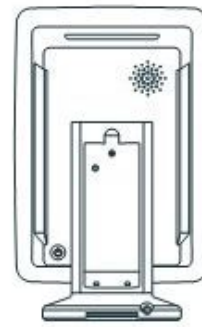

**2. Locate Positioning Screw inside battery slot**

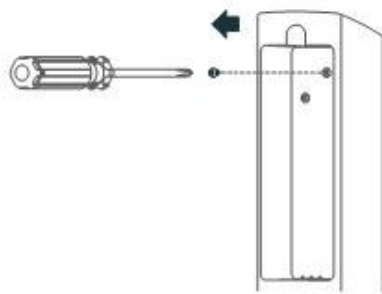

**3. Unscrew Positioning Screw**

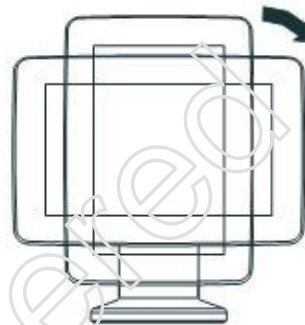

**4. Rotate screen 90 degrees clockwise**

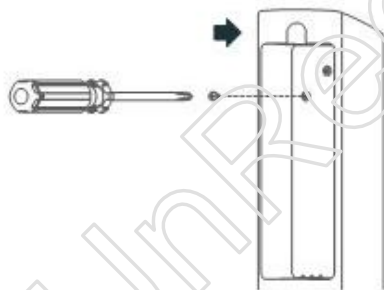

**5. Screw back Positioning Screw into drill hole**



**6. Place back battery**

# Operating Instructions

## Quick Start

### Turning On

1. Plug into electricity or insert fully charged battery.
2. Display will automatically load movie and play. (If the unit does not play a movie automatically, press the power button at the back of the display. RED light indicates standby mode and GREEN light indicates the unit is switched ON.)

### Playing other movies / change content

Connect a USB stick to the unit.

1. Content from the USB stick will automatically be copied to the unit's
2. internal memory.  
Once the content has copied successfully, the new content will start
3. playing automatically.  
Remove the USB from the unit.
4. Important: If you no longer require the old content to be played, you will need to delete the old content (to explain how this is done see Playlist section).

### Playing content from SD Card

1. Insert an SD Card to the unit.
2. The unit will play the content of the SD Card automatically.

## Flash

Activated by touch screen.

Recommended Flash

andscape

- Format: SWF (Flash lite 3.1 - mainly supports vector animation) Resolution: 716x420

Portrait

- Format: SWF (Flash lite 3.1 - mainly supports vector animation) Resolution: 420x716

## Video

Recommended Video Resolution:

### Landscape

- Format:
- AVI Codec:
  - dio code: MP3: layer 2/3; PCM:
- LPCM/IMA-ADPCM/MS-ADPCM/U-LAW Resolution: 1920x1080

### Portrait

- Format:
- AVI Codec:
  - dio code: MP3: layer 2/3; PCM:
- LPCM/IMA-ADPCM/MS-ADPCM/U-LAW Resolution: 1080x1920 Video needs to be rotated anti-clockwise by 90 degrees for portrait movie playing

## Picture

Recommended Picture Resolution:

### Landscape

- Format: JPG
- Resolution: 600x1024

### Portrait

- Format: JPG
- Resolution: 1024x600

UnRegistered

## Buttons and Remote Control



### Remote Control

**On/Off** Turns the unit on/off.

**Volume (- / +)** Increase/decrease volume when movies

are played. **Menu** Returns the unit to setup mode.

**Left** In menu mode, this function is used for moving left through the various options. In playback mode, this function allows you to go to the previous content in the playlist.

(Please note: This is only operational for content that is copied from USB or SD Card, not for content downloaded from i-Display Content Management System.)

**Right** In menu mode, this function is used for moving right through the various options. In playback mode, this function allows you to go to the next content in the playlist.

(Please note: This is only operational for content that is copied from USB or SD Card and not for content downloaded from i-Display Content Management System.)

**Up** In menu mode, this is used for moving up. It is not operational in playback mode.

**Down** In menu mode, this is used for moving down. It is not operational in playback mode.

**Enter** In menu mode, it is used to select an option. It is not operational in playback mode.

**OSD** While playlist is being viewed in menu mode and the OSD function is pressed, a table with Copy/Delete/Sort will appear, enabling the use of these functions on the playlist content.

(Please note: Playlist refers to only the content that is copied from USB or SD Card or a playlist viewed from an SD Card and not for content downloaded from i-Display Content Management System.)

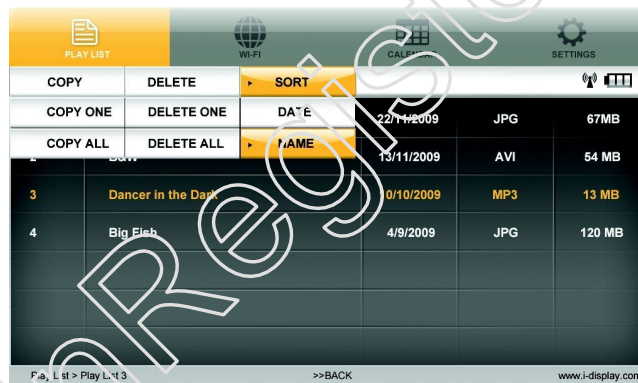

**Play/Pause** In playback mode, this function is used to pause or play a specific JPG or movie. (This function is only operational on content copied from a USB or SD Card or a playlist viewed from an SD Card and not for content downloaded from i-Display Content Management System.)

**Stop** In playback mode, pressing this function once will stop the current content playing and will make the screen return to the menu mode. In menu mode, it is used to go back to main menu.

**Slide show** In playback mode, it is used to change between “repeat one” (repeats the chosen file in endless loop) and “repeat all” (repeats the entire playlist in endless loop).  
(This function is only operational on content copied from a USB or SD Card or a playlist viewed from an SD Card and not for content downloaded from i-Display Content Management System.)

**Rotate** In playback mode, this is used to rotate JPG pictures. It cannot be used for movies being played. (This function is only operational on content copied from a USB or SD Card or a playlist viewed from an SD Card and not for content downloaded from i-Display Content Management System.)

**Zoom** In playback mode, this is used to zoom on JPG pictures. It cannot be used for movies being played. (This function is only operational on content copied from a USB or SD Card or a playlist viewed from an SD Card and not for content downloaded from i-Display Content Management System.)

**Mute** In Playback mode, this is used to mute sound. Another click on the Mute button restores the sound.

## Screen Status Indicators



**Wi-Fi Signal** Indicates the unit is connected to a Wi-Fi network. Wi-Fi Signal changing colour (to orange) indicates content being downloaded.



**Battery Icon** Indicates the unit is working on battery power and shows the amount of power left in the battery.



**Empty Battery Icon** Indicates the battery has 30 minutes of power remaining to keep the unit activated.



## Menu Features

The Menu includes 4 main features:

Playlist / Wi-Fi & Activation to Remote Content Management / Calendar / Settings. Each can be accessed and activated by either the remote control or buttons on the side of the unit.

## Playlist

The playlist holds a list of content, which can be played on the unit. To view the playlist:

1. Select internal memory or SD Card.

Please note: The playlist only shows content copied to internal memory by USB or SD Card. It does not show content downloaded from the i-Display Content Management System.

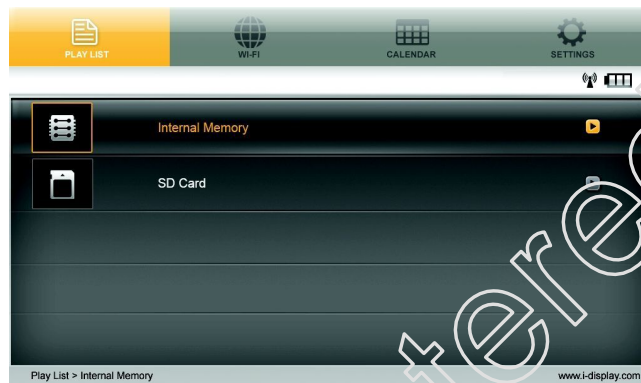

2. Choose any of the selected files that appear on the playlist by moving the up and down arrows on the remote. Then Click "Enter" to play the relevant content. (Please note: These files can be either JPEG or various movie formats e.g. MPEG 1, 2 and 4. Recommended format is XVID.)



- Click OSD to copy / delete / sort content.  
 (Please note: This function is only operational on content copied from a USB or SD Card or a playlist viewed from an SD Card and not for content downloaded from i-Display Content Management System) Use the arrows to move between these options and Click “Enter” in order to see the drop down menu of each of these options as shown below:

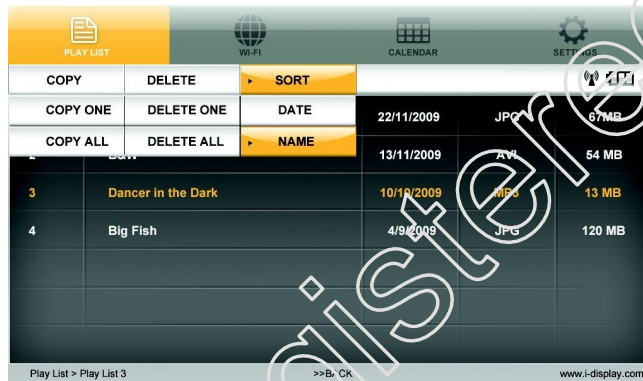

## Wi-Fi

For best performance unit should be up to 17 meters from router. Holds 3 main features: Wi-Fi list / Wi-Fi Setup / Account Config

Step One: Connect to the internet

- Click MENU to see Setting page. Go to the Wi-Fi tab using your remote control (or the setting buttons on your Player).
- Choose the Wi-Fi tab then click ENTER, select Wi-Fi Setup and click ENTER.

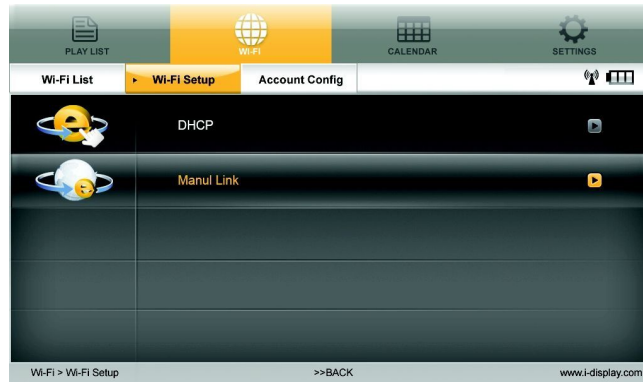

3. Click OK on DHCP, the player will automatically locate available Wi-Fi networks.



4. Click ENTER on your selected wireless network. (If your Wi-Fi connection does not require a password the Player will connect to the wireless network automatically. However, if the wireless network requires a password, click ENTER, you will need to fill-in the Username and Password.)

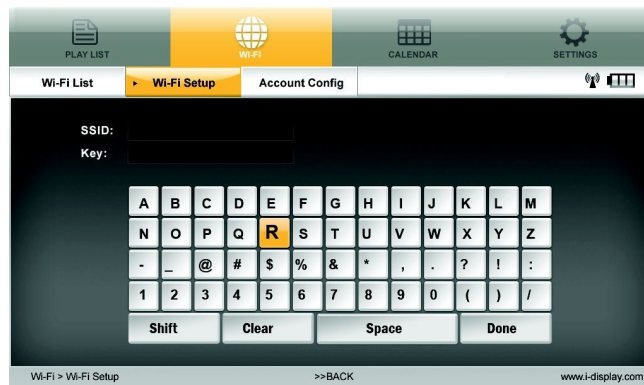

On secure Wi-Fi networks, insert relevant network code using the remote control, then click Done.

5. Once the unit is connected, a Wi-Fi signal will appear. If an error message appears, retype your username and password (please ensure you are using the right information and capital letters if applicable, otherwise the Player will not be able to connect to the wireless network). If the connection is still not successful, a problem may have occurred - try rebooting the unit and connect again.
6. Should you need more support, please go to:  
[www.i-display.com/config/player\\_wireless](http://www.i-display.com/config/player_wireless) - to download configuration file.

#### Manual link

1. Click MENU to see Setting page. Go to the Wi-Fi tab using your remote control (or the setting buttons on your player).
2. Choose the Wi-Fi tab and click ENTER, select Wi-Fi Setup and click ENTER (see screenshot above).
3. From Wi-Fi Setup, go to Manual Link. You will need to insert the relevant information (see next screenshot). Once this information has been entered click Done.

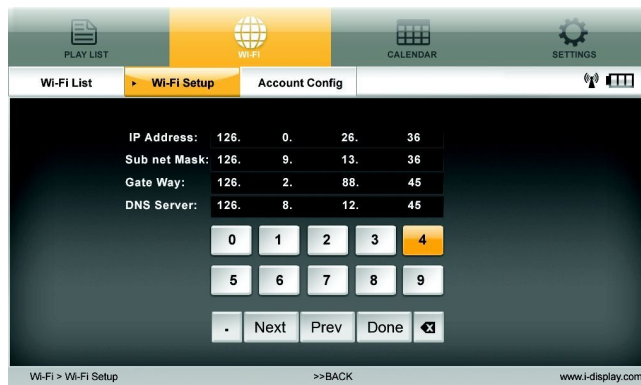

Step Two: Getting an activation code

1. Make sure the unit is connected to Wi-Fi (Wi-Fi connection via DHCP or Manual Link explained in Wi-Fi section).
2. Use the remote control or Player buttons and go to Wi-Fi List in Wi-Fi tab, then click ENTER.

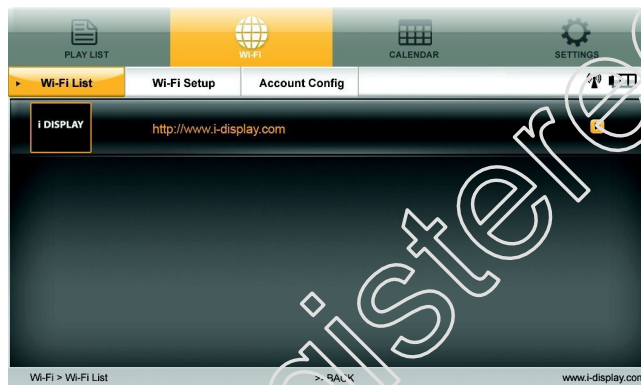

3. Click ENTER on the i-Display Logo (as shown in screenshot above) and wait for approximately 3 minutes (the Player will indicate it is connected to Wi-Fi by showing the Wi-Fi icon) as the Player downloads an “activation slide”. The activation slide downloaded should appear on the Player screen.

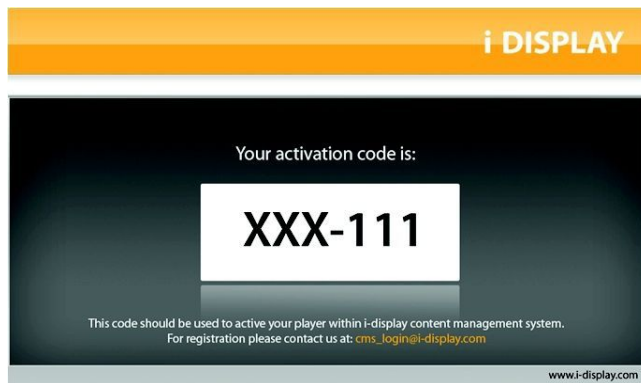

4. Write down the activation code, as it is needed to activate this specific Player on the i-Display Content Management System.

Step Three: Activate your Player within i-Display Content Management System

1. Log on to i-Display Content Management System at [www.i-display.com](http://www.i-display.com) (<http://www.i-display.com>) and click on the LOGIN link in the home page.
2. Within the LOGIN page, please fill-in your Username and Password. (if you do not have a Username and Password, please click CREATE AN ACCOUNT and follow the instructions. At the end of the registration process you will get a LOGIN access to i-Display Content Management System.)
3. Once you are connected to i-Display Content Management System, click on the + sign button in the Players column to add a Player. Click ENTER when you see the "Activate Player" alert.



4. Enter a Player name (it is highly recommended that the Player name will include a unique number which you will then be able to use to identify it from other players) and the unique Activation code shown on the Player screen, as shown in Step Two: Getting an activation code.

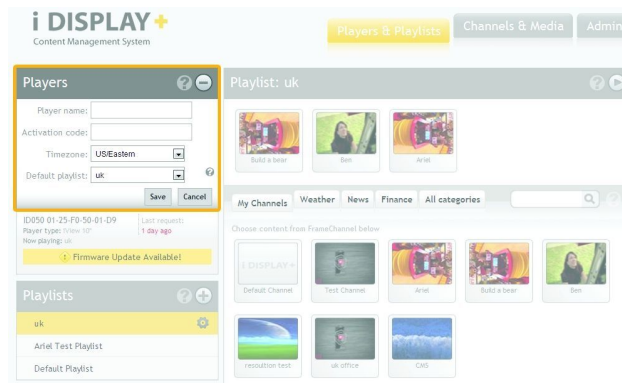

5. Set up any applicable Player setting: (i) Time zone (ii) Playlist
6. Then click SAVE to finish.
7. Now your Player is connected to i-Display Content Management System.

#### Step Four: Confirm Player is connected

1. Click MENU to see Setting page. Go to the Wi-Fi tab using your remote control (or the setting buttons on your Player).
2. Choose the Wi-Fi tab then click ENTER. Select Account Config and click ENTER (Make sure the Player is connected to Wi-Fi).

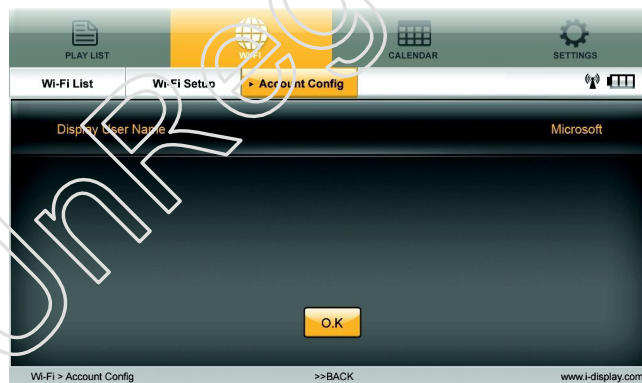

3. The name that appears on the Account Config should be the same as your account name in i-Display Content Management System (the same account name you gave when you registered). If the name matches your registered account name, your Player is now connected to the i-Display Content Management System.
4. For an introduction on how to use the Content Management System, please select the Demo tab to get more information.

## Calendar

- This shows time and date set in unit. If content in internal memory (copied from USB or SD Card) has a JPG it will appear in a slide show below the digital clock. To change the date and time on the unit:
1. Go to the Settings tab by using the arrows to move across the top menu.
  2. (Please note: You must be in the main menu to select the Settings tab). Use the "Down" arrow to select "Date and Time Setting". Press "Enter" to see another sub-menu appear. Use the "Down" and "Up" arrows to select which options you would like to change, i.e. year, month, day, hour, etc.
  3. Once option is selected, use the "Left" or "Right" arrows to increase/decrease the number until reaching the number you desire. When you have finished selecting the date and time you want, press the "Stop" button to save your options. This will make the sub-menu disappear. Then you may return to the previous menu to select another option in "Settings" or return to another page on the Main Menu.





## Settings

Holds a list of functions as shown in the screenshots below e.g. Slideshow Frequency, Transition effect, etc.:

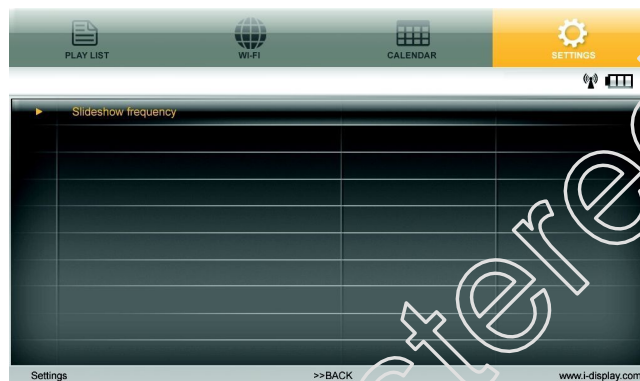

1. Slide Show Frequency: Controls the amount of time each JPG will be shown when played. This only affects content copied from USB or SD Card to internal memory or content played from SD Card and not content downloaded from i-Display Content Management System.
2. Transition Effect: Controls the way each JPG will appear on the screen. This function does not work for movies. This only affects content copied from USB or SD Card to internal memory or content played from SD Card and not content downloaded from i-Display Content Management System.
3. Date & Time Setting: Controls the time and date which appear in the calendar.
4. On/Off Schedule: Controls when the unit will turn off and turn on automatically. Display: Controls brightness and contrast of the unit.

Display: Allows changing Brightness, Contrast, Saturation and Hue of unit.

Photo View Options: Allows JPGs to be shown in their original size or fill in the screen.

Copy Option: Allows reduction of the size of the files copied from USB or SD Card to internal memory.

Power On Mode: Allows choosing from which location the content will play automatically when unit is turned on - content on internal memory copied from USB/SD Card or content downloaded from i-Display Content Management System. Current default is content on internal memory copied from USB/SD Card.

Default Settings: Return unit to default settings.

Clear Internal Memory: Erases all content copied from USB or SD Card to internal memory. It does not erase content downloaded from the i-Display Content Management System.

Firmware Upgrade: Allows upgrading the unit's current firmware. Upgrading can be done via SD Card: First step is to insert the SD Card with the new firmware file. Then choose the firmware upgrade function in setting. The unit will start upgrading the firmware.

Important: i-Display Content Management System automatically updates the Player's firmware as newer versions become available. When you see the following warning on screen, DO NOT UNPLUG THE POWER, be advised the unit is updating its firmware. The update process will complete in less than 1 minute and the Player will automatically reboot and resume normal operation. Do not turn off the unit while it is upgrading or the unit may malfunction.

#### Troubleshooting

Please contact: [support\\_iView@i-display.com](mailto:support_iView@i-display.com)

### Power Supply Unit Electrical Data

Display: Input: 12 V, 3000mA

Power Adaptor: Input 100-240V, 50/60 Hz, 0.8A; Output 12V, 3000mA

Produced by: HONOR ELECTRONIC CO.LTD

### LCD Screen Specification

Resolution: 1024x600

Viewing angle: 70° left, 70° right, 60° top side, 50° under side

## WLAN RADIO

<b>Standards</b>	IEEE802.11b, 802.11g and , 802.11n Draft
<b>Operating Frequency</b>	USA (FCC): 2.412GHz ~ 2.462GHz ISM band (channel 1 – 11) Europe (CE): 2.412GHz ~ 2.472GHz ISM band (channel 1 – 13)
<b>Channel Bandwidth</b>	20/40MHz
<b>Protocols</b>	802.11b: CCK, QPSK, BPSK 802.11g: OFDM Draft-11n: BPSK, QPSK, 16-QAM, 64-QAM
<b>Antenna</b>	PCB Antenna or IPEX socket for External Antenna. For details, please refer to ordering information.
<b>Security</b>	WPA/WPA2, 64/128/152-bit WEP, WPS
<b>Transmit Output Power</b>	11b: 16±1.5dBm @ 11Mbps 11g: 13±1.5dBm @ 54Mbps 11n: 12.5±1.5dBm
<b>Receive Sensitivity</b>	11b: -82dBm @ 11Mbps (Typical) 11g: -68dBm @ 54Mbps (Typical) 11n: -68dBm (Typical)
<b>Operating Voltage</b>	5.0V DC ± 5%
<b>Bus Interface</b>	USB 2.0 signaling.
<b>Antenna Port Impedance</b>	50 ohm

**i DISPLAY**  
Interactive Digital Displays

UnRegistered

For further information or support, please contact: [support\\_iView@i-display.com](mailto:support_iView@i-display.com)

Outform ©All Rights Reserved