

*Thank you for choosing*

# Panasonic Omnivision **S** VHS

MODEL PV-S4670

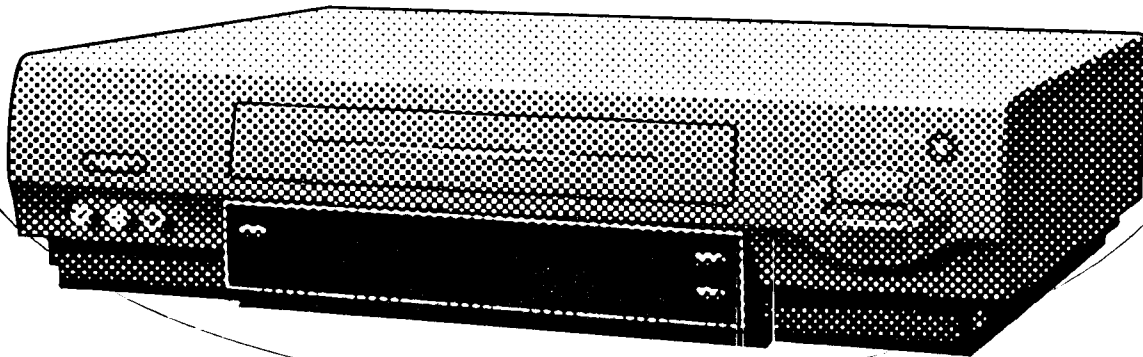

Video Cassette Recorder

**VCR** *Plus+*<sup>®</sup>  
w/Cable Channel  
Changer

## Operating Instructions

Please read these instructions carefully before attempting to connect, operate or adjust this product and save this manual.  
Spanish Quick Use Guide is included. Guía para rápida consulta en español está incluido.

P6 ~ P9  
Connections

P10 ~ P16  
Getting Started

P17 ~ P19  
Basic Operation

P20 ~ P29  
More You Can Do

P30 ~ Back Cover  
Other Information

# Things You Should Know

## ***Congratulations***

on your purchase of one of the most sophisticated and reliable products on the market today. Used properly, we're sure it will bring you and your family years of enjoyment. Please take time to fill in the information at right. The serial number is on the tag located on the back of your VCR. You'll want to keep this manual handy as your convenient VCR information source.

Date of Purchase \_\_\_\_\_  
Dealer Purchased From \_\_\_\_\_  
Dealer Address \_\_\_\_\_  
Dealer Phone No. \_\_\_\_\_  
Model No. **PV-S4670** \_\_\_\_\_  
Serial No. \_\_\_\_\_

## ***Safety Precautions***

**Warning: To prevent fire or shock hazard, do not expose this equipment to rain or moisture.** This video recorder, equipped with the HQ System, is compatible with existing VHS equipment. Only use those tapes with the **VHS** or **SVHS** mark. It is recommended that only cassette tapes that have been tested and inspected for use in 2, 4, 6, and 8 hour VCR machines be used. This video recorder is equipped with recording functions for both conventional **VHS** and **SVHS** systems to enable users to select either mode. An **SVHS** cassette recorded in the **SVHS** mode cannot be played back with conventional **VHS** VCRs.

FCC Warning: Any unauthorized changes or modifications to this equipment would void the user's authority to operate.

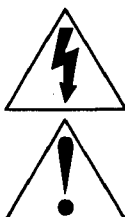
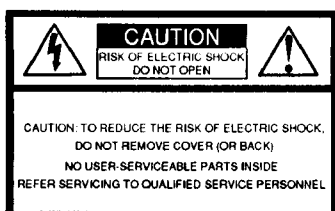

This symbol warns the user that uninsulated voltage within the unit may have sufficient magnitude to cause electric shock. Therefore, it is dangerous to make any kind of contact with any inside part of this unit.

This symbol alerts the user that important literature concerning the operation and maintenance of this unit has been included. Therefore, it should be read carefully in order to avoid any problems.

## **Table of Contents**

Important Safeguards and Precautions .....	3
Unpacking Your VCR and Features .....	4
VCR and Cassette Information (Record Tab, Tape Speeds, Tape Cleaning, Specifications) .....	5

### **Connections**

Basic Connection (Antenna and VCR, VCR and TV) .....	6, 7
Additional Connections (CATV, Audio/Video) .....	8, 9

### **Getting Started**

One Time VCR Setup (On-screen Language, Cable Box/ DSS Receiver Setup, Channel Memory, Auto Clock Set) .....	10 ~ 15
On Screen Displays (OSD) (Function, Channel, Menu, VCR Status & Clock, Warning, Instruction) .....	16

### **Basic Operation**

Playback a Tape (Main Operation, Special Effects, Quality Picture Features) .....	17
Tape Operation (Repeat Play, One Minute Skip, Zero Search, Auto Functions) .....	18
Record On a Tape (Main Operation, One Touch Record, Channel Selection) .....	19

### **More You Can Do**

Timer Recording (Main Operation, Cancel-Clear or Replace, Program Contents) .....	20, 21
Timer Recording Using VCR Buttons .....	21
Copying Your Tapes (Dubbing) (Connection, Main Operation, Monitoring, Select Input Mode) .....	22
Super (S) VHS System .....	23
MTS Broadcast/ VHS Hi-Fi Stereo System (Stereo/SAP/Mono Broadcast, Select Audio Mode, Spatializer) ...	24, 25
VCR Plus+ Set Up (VCR Plus+ Channel Set Up) .....	26
VCR Plus+ Programming (Main Operation, Make Corrections) .....	27
Special VCR Features (VCR Lock, Warning Beeper) .....	28
Multi-Brand Control Feature .....	29

### **Other Information**

Before Requesting Service (Self-check items) .....	30
Spanish Quick Use Guide/Guía para rápida consulta .....	31, 32, 33, 34
Index of Controls (Remote Control, VCR) .....	35, Back Cover

# Important Safeguards and Precautions

## INTRODUCTION

Careful attention has been given to this Video product to assure a quality standard devoted to your safety and enjoyment. This quality standard together with your personal responsibility for the safety of yourself and others, will contribute to your enjoyment. This Video product uses electrical energy and requires proper handling at all times.

## CAUTION

READ AND RETAIN THE SAFETY AND OPERATING INSTRUCTIONS. To make full use of the safeguards incorporated in this unit, read and follow this basic guide, adopted in part from Underwriter's Laboratories Standard 1409, Second Edition, before operating this Video product.

FOLLOW THE INSTRUCTIONS AND BE SURE TO HEED ALL WARNINGS on unit and in the manual, for easy maintenance, proper and trouble free operation of this Video product.

## INSTALLATION

1. OPERATE FROM A POWER SOURCE INDICATED on this Video product, or in this Manual. Your Electric Utility Service Company or Video Products Dealer will be happy to verify the power source in your home.
2. THE GROUNDED OR POLARIZED PLUG IS A SAFETY FEATURE. This Video product may be equipped with either a polarized 2-wire AC line plug or a 3-wire grounding type plug. The two wire polarized plug (having one blade wider than the other) will fit into the power outlet only one way. If it is a three wire grounding type plug (having a third pin), it will fit into a grounding type outlet.  
DO NOT DEFEAT THE SAFETY PURPOSE OF THE GROUNDED OR POLARIZED PLUG by tampering with it. If the plug does not fit fully into the socket, try reversing it. If you should still be unable to fully insert the plug into the socket, you may find that a proper outlet is needed to meet today's Electrical Standards. An electrician will replace your outlet safely.
3. POWER SUPPLY CORDS SHOULD BE PROTECTED and routed so that they are not likely to have anything rest on them, roll over them, or be subject to walking traffic or abuse: particularly at plug-ins, convenience receptacles, or cord exit points from the unit. Where an extension is needed, use a grounded or polarized cord. HAZARDOUS FRAYED CORDS OR DAMAGED PLUGS SHOULD BE REPLACED BY A QUALIFIED SERVICE TECHNICIAN. OVERLOADED WALL OUTLETS AND EXTENSION CORDS PRESENT DANGEROUS RISKS OF FIRE OR ELECTRICAL SHOCK.
4. AVOID BLOCKING VENTILATION HOLES. Your video unit has ventilation openings in its cabinet to release heat generated during operation. Blocking these opening can cause heat build-up inside the unit, causing failure that may result in a fire hazard or heat damage to cassettes. For protection:
  - a. Never cover the bottom ventilation slots or the unit with soft material, or operate the unit placed on a bed, sofa, rug, or soft accessory.
  - b. Avoid built-in installations, such as a bookcase or rack, unless proper ventilation is provided.
5. AVOID EXTREMELY HOT LOCATIONS OR SUDDEN CHANGES IN TEMPERATURE such as placing the unit near or over a radiator, in direct sunlight, closed vehicles, or transporting it suddenly between areas of extreme temperature variation. If the unit is suddenly moved from a cold place to a warm place, moisture may form on the tape and inside the unit.
6. TO AVOID INJURY TO A CHILD, ADULT; OR COSTLY DAMAGE:
  - a. Do not place unsecured equipment on a sloping surface or any heavy object or unit. (Use the unit in a horizontal position and do not place anything heavy on it.)
  - b. Support for the unit should be adequately firm, level, and strong. Replace any unstable cart, table or support. An appliance and cart combination should be moved with care. Quick stops, excessive force, and uneven surfaces may cause the appliance and cart combination to overturn.
  - c. Carefully follow all operating instructions and use the manufacturer's recommended accessories when operating this unit or connecting it to any other equipment.



## OUTSIDE ANTENNA, EQUIPMENT, AND POWERLINE EXPOSURE

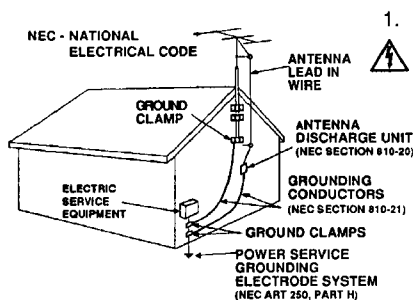

1. INSURE SAFE ANTENNA AND CABLE CONNECTIONS. If an outside antenna or cable system is connected to the equipment, be sure the antenna or cable system is grounded so as to provide some protection against built up static charges and voltage surges. Part 1 of the Canadian Electrical Code, in USA Section 810 of the National Electrical Code, ANSI/NFPA

70, provides information with respect to proper grounding of the mast and supporting structure, grounding of the lead-in wire to an antenna discharge unit, size of grounding conductors, location of antenna discharge unit, connection to grounding electrodes and requirements for the grounding electrode.

2. ELIMINATE ANTENNA PROXIMITY TO HIGH VOLTAGE POWER SOURCES, OR CHANCE OF ACCIDENTAL CONTACT BY INSTALLER. An outside antenna system should be located where it will never be reached by power lines, electric light or power circuits and where it will never contact these power sources if it falls. Installer should use extreme care to avoid possible fatal contact by touching power lines, circuits or other power sources when installing an outside antenna.

## USE

AFTER STORING OR WHEN MOVING THE UNIT, REFER TO THE INSTALLATION SECTION OF THE SAFEGUARDS.

1. DO NOT USE THIS VIDEO UNIT NEAR WATER: around bathtubs, sinks, laundry, wet basement, swimming pool or any water source.
2. USE ACCESSORIES RECOMMENDED ONLY BY THE MANUFACTURER to avoid risk of fire, shock or other hazards.
3. UNPLUG ALL EQUIPMENT EXPOSED TO RAIN, MOISTURE, OR STRONG IMPACT AND GET A QUALIFIED INSPECTION. If your unit has been exposed to rain, water, excessive moisture, or subjected to strong impact, unplug it and have it inspected by a service technician before use.
4. UNPLUG UNUSED UNIT, AND ALL EQUIPMENT DURING A STORM. During a lightning storm, when indoors or outdoors, or before leaving unit unused for extended periods of time, disconnect all equipment from power source, antenna and cable system.
5. UNPLUG ALL EQUIPMENT BEFORE CLEANING. After unit has been unplugged use a dry, clean, chemically untreated cloth. Use no cleaning fluids, aerosols, or forced air that could over-spray, or soak into the unit, and cause electrical shock. Any substance such as wax, adhesive tape, etc. may affect the cabinet surface. Exposure to greasy, humid, or dusty areas may affect internal parts.
6. WHEN PLUGGED-IN: KEEP WATER AWAY; NO FINGERS INSIDE NOR ANY OBJECTS INSIDE; AND NO MAGNETS OR ELECTRICAL INTERFERENCE NEARBY.
  - a. Never operate the unit if liquid has been spilled into it. Immediately unplug the unit, and have it inspected by a service technician. Fire and shock hazards can result from electrical shorts caused by liquid contact inside.
  - b. Caution the children about dropping or pushing objects into the unit. Some parts inside carry hazardous voltages and contact can cause electric shock. Objects dropped in electrical equipment can cause fire hazards.
  - c. Separate the unit from any interference causing appliances. Placing the unit directly above or below your TV set may cause electrical interference. Keep all magnets away from electronic equipment.

## SERVICE

1. DO NOT ATTEMPT TO SERVICE THIS PRODUCT YOURSELF. If this Video product does not operate as described, when the detailed Operating Instructions are followed, do not attempt to open or remove covers, or make any adjustments not described in the manual. Attempting to service this unit yourself may expose you to dangerous voltage or other hazards. Refer all servicing to qualified service personnel.
2. CHECK ON REPLACEMENT PARTS REQUIRED. Be sure the service technician has used replacement parts specified by the manufacturer or having the same characteristics as the original part. Unauthorized substitutes may result in fire, electric shock or other hazards.
3. HAVE TECHNICIAN PERFORM SAFETY CHECK described in the manufacturer's service literature, after any service or repairs, to determine that the Video unit is in safe operating order.

# Unpacking Your VCR and Features

## Unpacking Your VCR

The accessories shown below are provided to help you use or set up your VCR. Optional accessories are also listed.

### Accessories

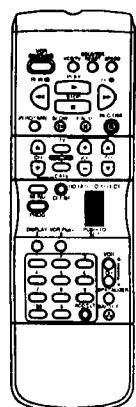

Remote Control  
VSQS1447

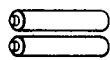

2 "AA"  
Batteries



RF Coaxial  
Cable  
VJAS0183

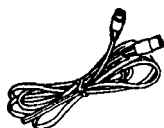

S-VHS  
Connecting  
Cable  
VJAS0148

### Optional Accessories

- 1/2" Video Cassette Tape

### Load the batteries in the Remote Control

**1** Lift off the lid after pressing in and up on the latch with your thumb nail or other narrow object.

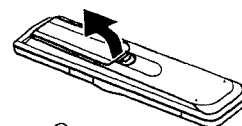

**2** Install two batteries as indicated inside the Battery Compartment.

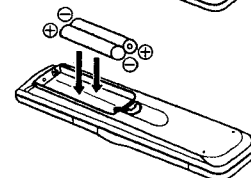

**3** Fit the lid's hinge piece into the indent on the case, and snap lid into place.

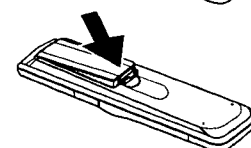

### Battery replacement caution

- Do not mix old and new batteries.  
(Also, never mix alkaline with manganese batteries.)

## Product Features

All Channel Auto Set/ 181-CH TV/CATV Tuner .....	12
Advanced Noise Reduction .....	17
Auto Clock Set .....	12, 13, 14
Auto Daylight Saving Time .....	5
Auto Operation Functions (Auto Playback, Rewind, Tape Eject, Power off) .....	18
Auto Repeat Function .....	18
Cable Box Channel Control .....	11
Color Noise Reduction .....	17
Digital Auto Picture .....	17
DynAmorphous™ Metal Head .....	17
Easy-to-Read English/Spanish/French On Screen Displays .....	12~14, 20, 21
MTS Broadcast System (Multi-channel Television Sound-Stereo, SAP, Mono) .....	24
Multi Brand TV/Cable Box Remote Control .....	29
One Minute Skip .....	18
One Month, 8 Program Timer Recording .....	20, 21
One Touch Recording (OTR) .....	19
Program Director Remote Control .....	20, 21
Quick Play Mechanism .....	30
Spatializer .....	25
Special Effects Playback .....	17
Special VCR Features (VCR Lock, Warning Beeper) .....	28
Super (S) VHS System .....	23
VCR Plus+ Recording .....	26, 27
VHS Hi-Fi Stereo System .....	25
Zero Search .....	18

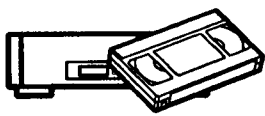

# VCR and Cassette Information

## Erase Protection (Record Tab)

Cassettes have a record tab to ensure that recordings are not accidentally erased.

To prevent accidental erasure, break off the tab with a screwdriver.



To record again, cover the hole with cellophane tape.



## Maximum Record/Playback Time

Only use tapes with the **VHS** or **SVHS** mark in this unit.

Tape Speed Position	Type of Video Cassette		
	T60	T120	T160
SP (Standard Play)	1 Hour	2 Hours	2 Hours 40 Minutes
LP (Long Play)	2 Hours	4 Hours	5 Hours 20 Minutes
SLP (Super Long Play)	3 Hours	6 Hours	8 Hours

## Cleaning Care for Video Heads



Clogged Video Head Picture

or

**Blue Back**  
(During playback of pre-recorded tape)

Blue Back Screen

## Clogged Video Heads

While your VCR will not normally require head cleaning, however the heads may become clogged when playing an old or damaged tape. If the image on your screen resembles the illustration on the left or the screen becomes solid blue when playing back a pre-recorded signal on the tape, the heads probably require cleaning.

## Cleaning the Heads

It is recommended that head cleaning be performed by a qualified service technician. Please contact your nearest Panasonic Service Center. An alternate solution is to obtain a head cleaning cassette. Be sure to follow the cleaning instructions carefully. Excessive use of a cleaning cassette could shorten head life. Use this cassette only when symptoms occur.

## Reset all VCR Memory Functions

This operation is convenient when moving the VCR to a new location, or if a mistake was made in the One Time VCR Setup section. Make sure a tape is not inserted in the VCR.

- 1) Turn VCR Power on.
- 2) Press and hold both Play and Rewind buttons on the VCR for more than 5 seconds.
  - The power will shut off.
- 3) Perform the One Time VCR Setup section on page 12.

## D.S.T. (Daylight Saving Time)

### Spring:

First Sunday in April (DAYLIGHT SAVING TIME: AUTO) Automatically adds one hour and adjusts the clock.

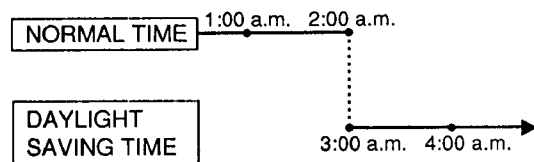

### Autumn:

Last Sunday in October (DAYLIGHT SAVING TIME: AUTO) Automatically turns back one hour and adjusts the clock.

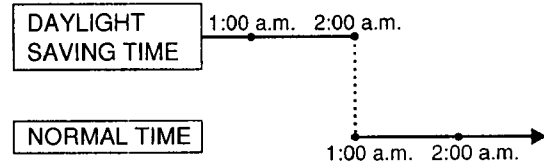

## Product Specifications

- Power Source:** 120V AC, 60 Hz
- Power Consumption:** Approx. 28 watts (Power on)  
Approx. 8 watts (Power off)
- Video Signal:** EIA Standard NTSC color
- Video Recording System:** 4 rotary heads helical scanning system
- Audio Track:** 1 track (Normal)  
2 channel (Hi-Fi Audio Sound)
- Tuner:**
  - Broadcast Channels:** VHF 2~13, UHF 14~69
  - CATV Channels:** Midband A through I (14~22)  
Superband J through W (23~36)  
Hyperband AA~EEE (37~64)  
Lowband A-5~A-1 (95~99)  
Special CATV channel 5A (01)  
Ultraband 65~94, 100~125
- S-VIDEO Input/Output Level:** S-VIDEO CONNECTOR (SEPARATED YC CONNECTOR):  
Y CONNECTOR 1.0 Vp-p, 75 ohm unbalanced  
C CONNECTOR 0.286 Vp-p, 75 ohm unbalanced
- Operating Temperature:** 41°F~104°F (5°C~40°C)
- Operating Humidity:** 10%~75%
- Weight:** 8.8 lbs. (4.0 Kg)
- Dimensions:** 14-15/16" (W) X 3-1/2" (H) X 11-1/4" (D)  
380 (W) X 89 (H) X 285 (D) mm

Note: Designs and specifications are subject to change without notice.



# Basic Connection

## ANTENNA

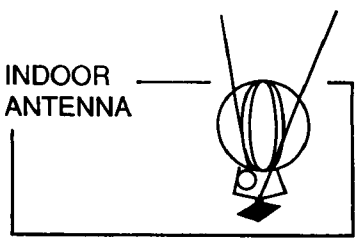

or

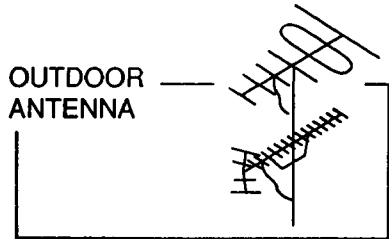

or

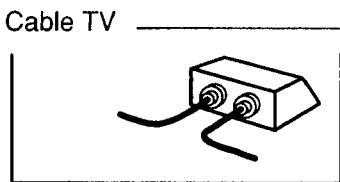

**Disconnect the antenna or cable from your TV and connect it to the VCR (IN FROM ANT.)**

Antenna Cable

TV

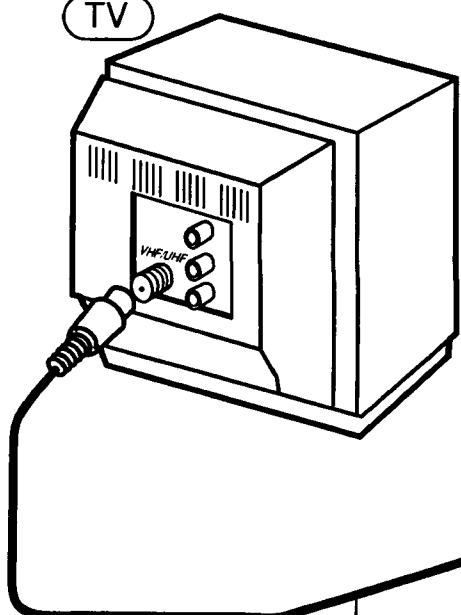

VCR

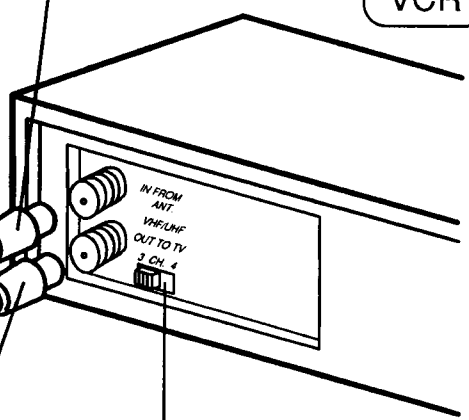

RF Coaxial Cable (VCR-TV Connection Cable) (supplied)

**Set the Output Channel of your VCR to channel 3 or 4 (whichever is not being transmitted on by a Local TV broadcast).**

**Connect the VCR to your TV with the RF Coaxial Cable (OUT TO TV).**

## Between Antenna and VCR

### Case 1: Twin Lead Cable Only

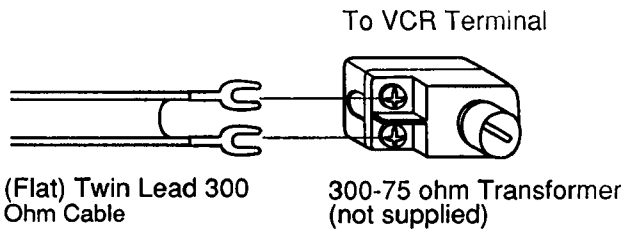

### Case 2: Twin Lead & Coaxial Cables

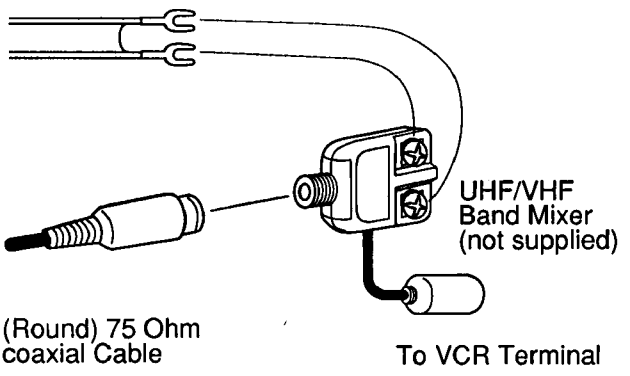

### Case 3: Two Twin Lead Cables

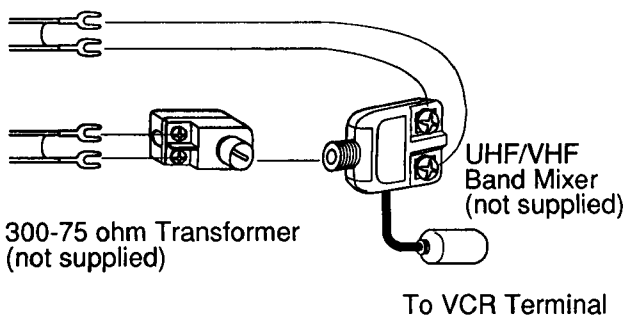

- If your TV has both post and screw-type VHF terminals, using the post connection is recommended to minimize signal loss.

## Between VCR and TV

### Case 1: Screw & Plug Type Terminal

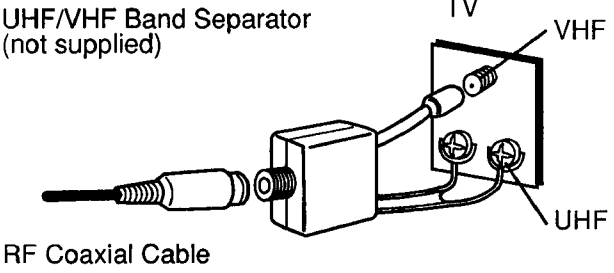

### Case 2: Screw Type Terminal

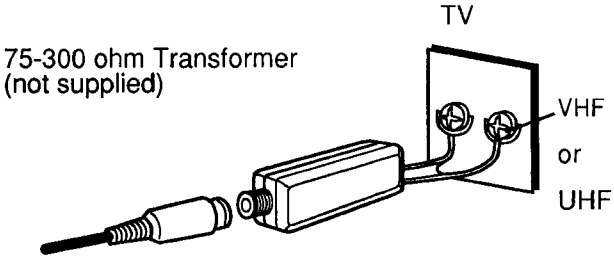

### Case 3: Double Screw Type Terminal

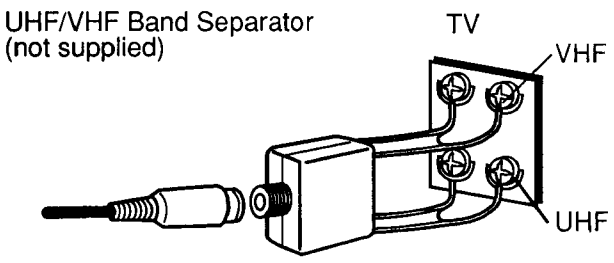

### Case 4: Complex TV Terminal

TERMINALS ON BACK OF TV SET

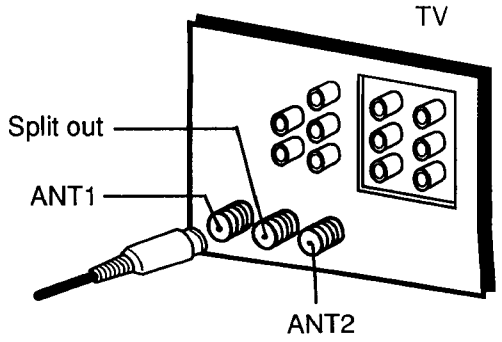

- Connect to one of the ANT terminals and select the same antenna number on the TV.



# Additional Connections

## CATV(Cable) Connections

All connections on this page are made with 75 Ohm coaxial cables.

### Without a Converter/Descrambler Box

You can:

- 1) Use your VCR Remote Control to select channels.
- 2) Program one or more unscrambled channels for unattended recording.

**NOTE:** You cannot record or view scrambled channels with this connection.

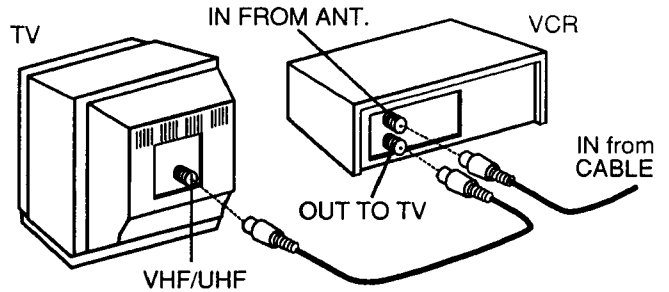

### With a (CABLE to VCR) Converter/Descrambler Box

You can:

- 1) Record and view any channel including scrambled channels; channel selection must be made at the Cable TV Converter Box.
- 2) Program one channel for unattended recording.

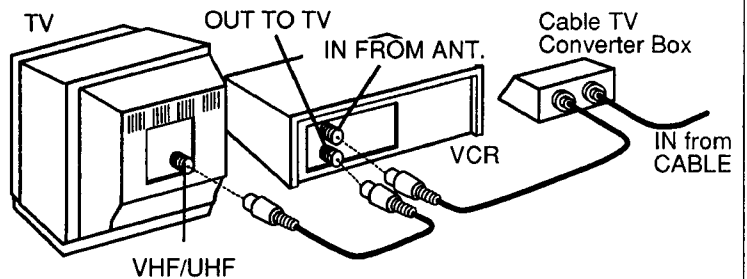

### With a (VCR to TV) Converter/Descrambler Box

You can:

- 1) Use your VCR Remote Control to select channels.
- 2) Program unattended recordings of more than one unscrambled channel.

**NOTE:** You cannot record scrambled channels with this connection.

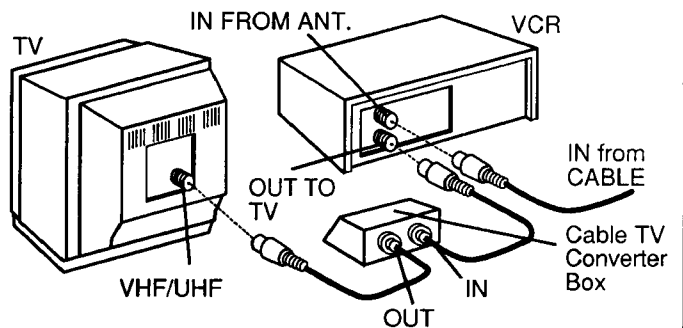

### With Two Converter/Descrambler Boxes

If you want to record and view a combination of scrambled and unscrambled channels, you will need additional equipment.

This connection requires two converter boxes, an A/B switch, and a 2-way splitter as shown here.

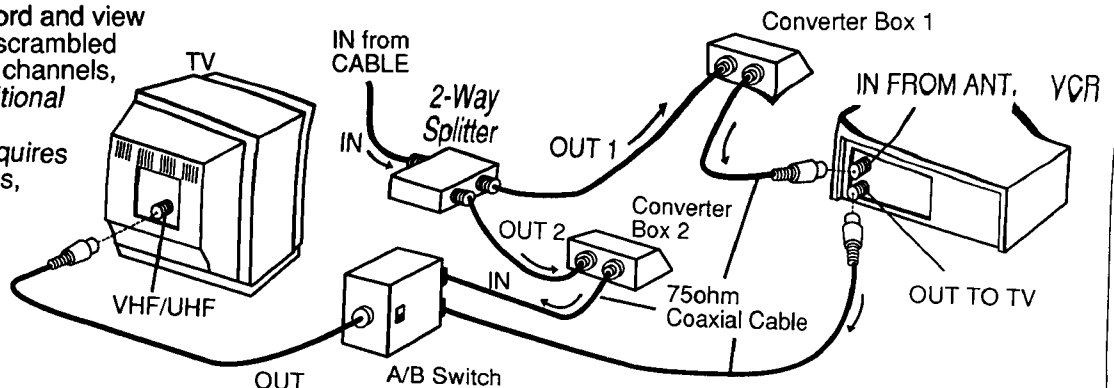



### With a DSS Receiver

You can:

- 1) Record and view any channel including scrambled channels; channel selection must be made at the DSS Receiver.
- 2) Program one channel for unattended recording.

**NOTE:** The DSS receiver must be turned off to view programs from a cable box or antenna. See the DSS manual for details.

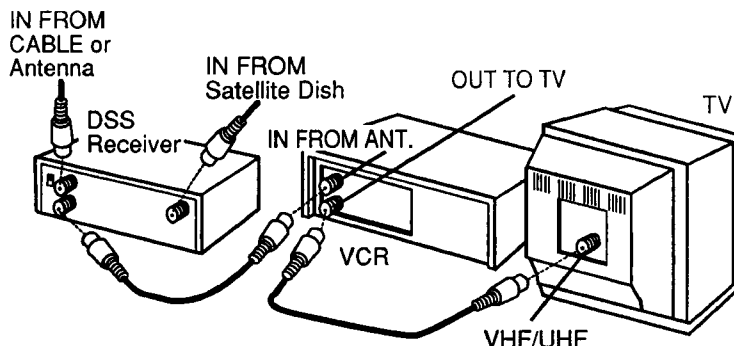

### Audio/Video Connections

If your TV has AUDIO IN and VIDEO IN terminals, you can connect your VCR to them to receive a higher quality picture and sound. The antenna-VCR and VCR-TV connection is as shown.

#### Audio/Video Connections

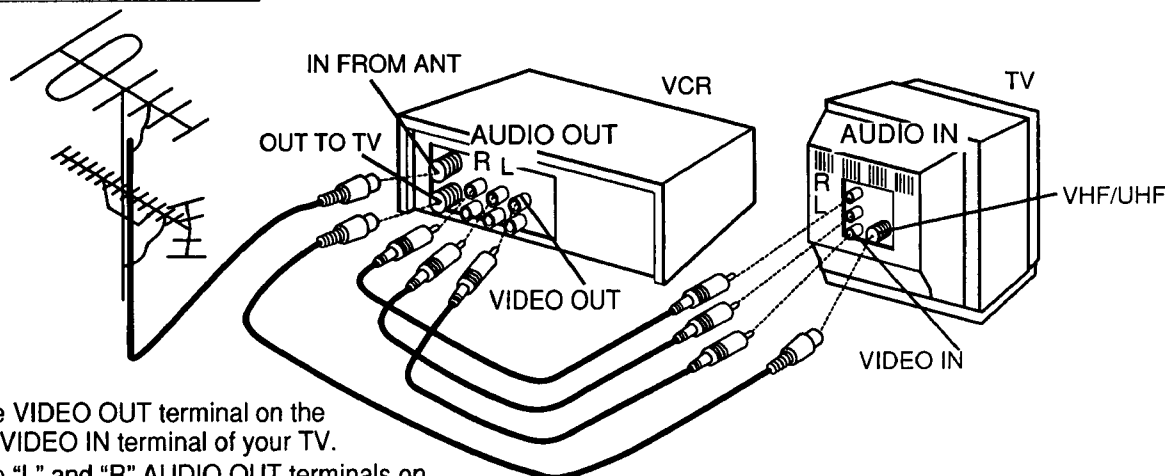

- 1 Connect the VIDEO OUT terminal on the VCR to the VIDEO IN terminal of your TV.
- 2 Connect the "L" and "R" AUDIO OUT terminals on the VCR to the "L" and "R" AUDIO IN terminals of your TV.
- 3 Set the VIDEO/TV selector of your TV (Monitor/Receiver) to "VIDEO."

**NOTE:** To use your TV as a VCR monitor, set the VIDEO/TV selector on the TV (Monitor/Receiver) to "VIDEO."

#### Stereo Amplifier Connections

When you connect your VCR to a Stereo Component System, you can view the picture from the VCR while enjoying stereo from your audio system.

Connect the "L" and "R" AUDIO OUT terminals on the VCR to the "L" and "R" AUDIO IN terminals of your stereo.

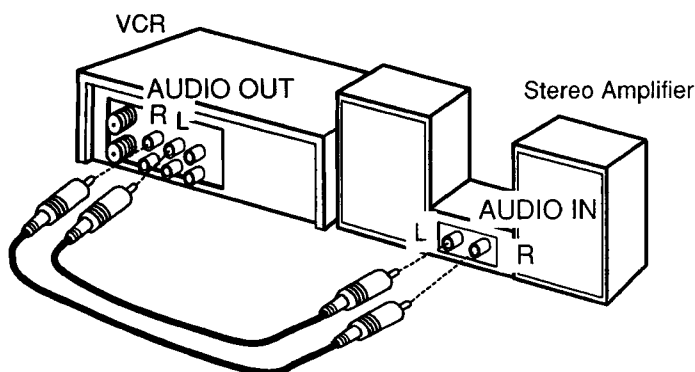

\*\*DSS® is a registered trademark of DIRECTV, INC., a unit of GM HUGHES ELECTRONICS.

**Note to CATV system installer:**

This reminder is provided to call the CATV system installer's attention to Article 820-40 of the NEC in USA (and to the Canadian Electrical code in Canada) that provides guidelines for proper grounding and, in particular, specifies that the cable ground shall be connected to the grounding system of the building, as close to the point of cable entry as practical.



# One Time VCR Setup

The setup on pages 12 through 14 is vital for proper VCR operation. Please read the instructions carefully and in the order presented.

NOTE: These first two pages contain reference material needed for setup on pages 12 ~14. Please look over the information before you begin setup procedure.

## Setup Overview

You will be performing the following tasks:

- Setting the language you want on-screen displays to appear in (English, Spanish, French).
- Telling the VCR what kind of equipment you are using to receive channels and how it is connected.
- Entering pertinent cable box or DSS receiver information if used.
- Entering a local PBS channel so that the VCR can receive auto clock set data. (Not available in all areas.)
- Placing channels in memory and setting the clock.

## Please Note Which Connection Method You are Using.

Make sure all equipment is hooked up as described on pages 6~9.

The diagrams below illustrate some of the basic connection types. Confirm which method you used for later reference.

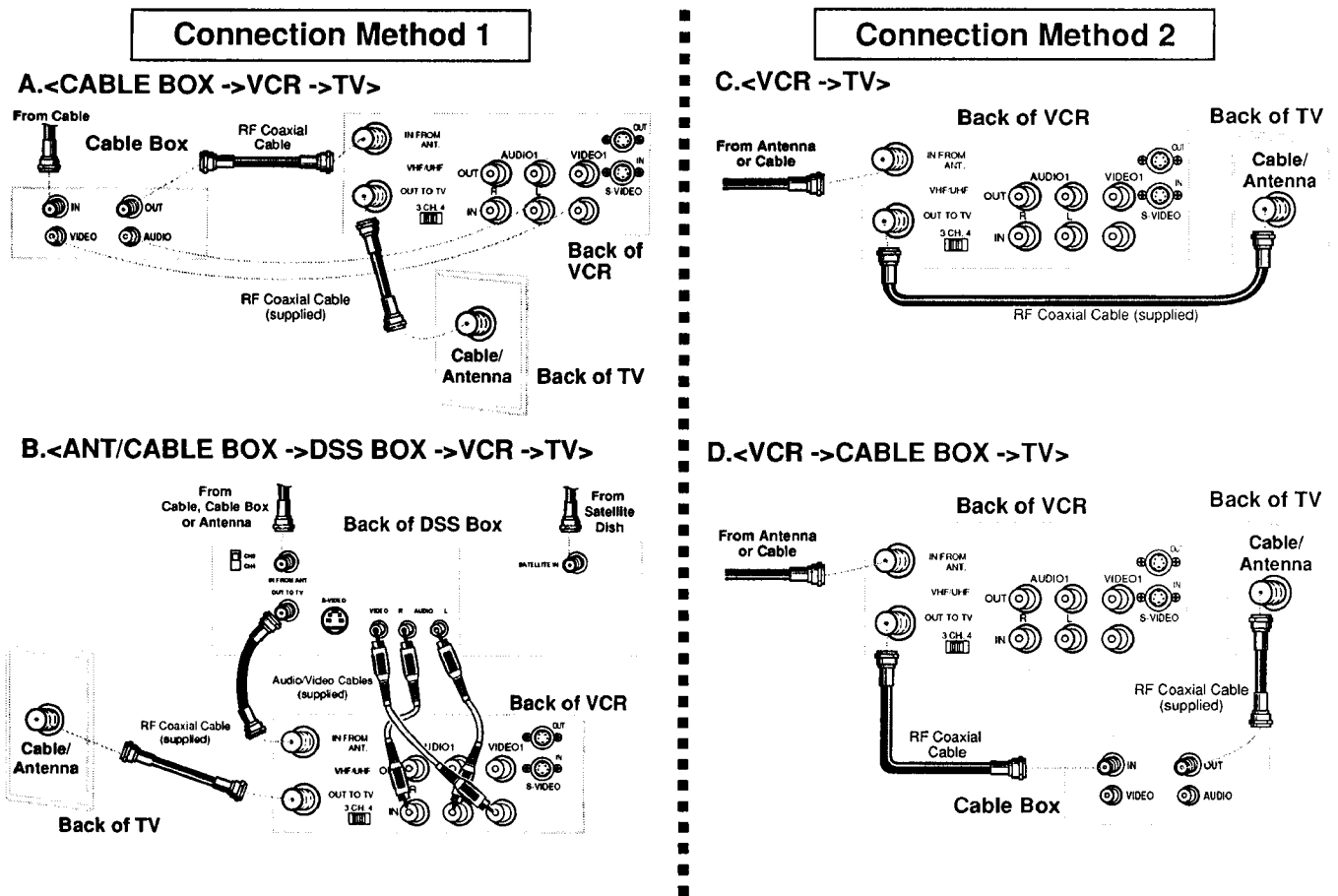

## ONE TIME SETUP IMPORTANT NOTES:

- For detailed DSS receiver connection instruction, please see your DSS operating manual.
- The DSS receiver must be turned off to view programs from the cable box or antenna.
- If you use a DSS receiver, it must be turned off for auto clock set.
- If your cable box is not remote controllable, it must be tuned to your PBS channel.
- If you use Audio/Video Jack connection between the VCR and cable box or DSS receiver, you must also connect the RF coaxial cable in order to use the auto clock set and channel auto set features.

# Cable Box/ DSS Receiver Code Number List

If your cable box or DSS receiver is remote controllable, refer to this list during setup on page 13.

## Cable Box

Brand	Code Numbers
Archer	29, 44, 88, 91
Cableview	30, 42, 44, 52, 63, 88
Citizen	30, 42, 44, 52, 63, 88
Curtis	8, 09, 56, 61, 87, 90
Diamond	1, 29, 44, 88, 91
Drake	37, 67, 71
Eagle	13, 20, 22, 26, 40, 58, 62
Eastern	28
GC Brand	30, 42, 44, 52, 63, 88
Gemini	4, 85
General Electric	57
General Instruments	1, 2, 3, 4, 34, 55, 83, 85, 91, 93, 95
Hamlin	14, 15, 28, 41
Jerrold	1, 2, 3, 4, 34, 55, 83, 85, 91, 93, 95
Macom, Hitachi	31, 79
Magnavox	25, 26
Movietime	32, 38, 40
Movietime	29, 32, 39, 42, 44, 88
NSC	32, 38, 40
Oak	11, 46
Panasonic	16, 17
Philips	13, 20, 23, 24, 96
Pioneer	05, 06, 78
Pulser	30, 42, 44, 52, 63, 88
RCA	16, 17
Realistic	44, 51, 88
Regal	14, 41

Brand	Code Numbers
Regency	28
Rembran	29, 32, 39, 42, 44, 88
Salora	68, 72
Samsung	32, 40, 42, 78, 94
Scientific Atlantic	8, 09, 56, 61, 87, 90
Sheritech	27
SL Marx	32, 40, 42, 78, 94
Sprucer	16, 17
Stargate	32, 40, 42, 78, 94
Stargate	30, 42, 44, 52, 63, 88
Sylvania	19
Telecaption	77, 92
Teknika	74
Televue	32, 40, 42, 78, 94
Texscan	18, 19
Tocom	1, 33, 34, 42, 48, 49, 91
Toshiba	36
Uniden Satellite	65, 69
Unika	01, 29, 44, 88, 91
Universal	42, 43, 44, 52, 63, 88
Viewstar	13, 20, 22, 26, 40, 58, 62
Vid Tech	64
Vidter	64
Videoway	7, 23, 50
Zenith	7, 23, 50

## DSS (Digital Satellite System Receiver)

Sony	98
RCA	99
Panasonic	100

Note: During setup you will be instructed to enter your brand code number. As some brands have multiple codes, it may be necessary to try different codes to attain the proper results. These codes are for Cable box or DSS Box setup for Auto Clock and VCR Plus+ recording only. For TV/Cable Box Universal Remote Control operation, please see page 29.

## Positioning Your Cable Box or DSS Receiver

If your cable box or DSS receiver is remote controllable, place it on or near the VCR as shown in the example below. The VCR transmits an infrared signal from two locations. Be sure not to cover the transmitter windows.

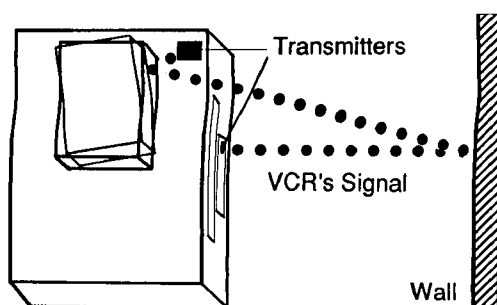



# One Time VCR Setup

When the VCR power is first turned on, the language select screen automatically appears. Follow along in the manual as you are guided through the setup procedure on the screen.



## Check list before you begin.

- All TV and VCR connections are made. (See pages 6-9.)

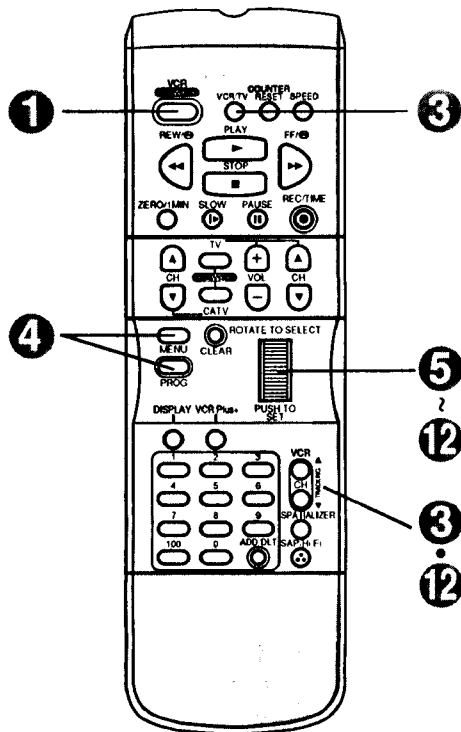
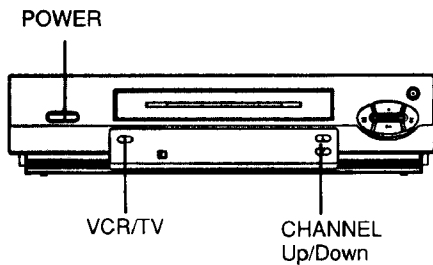

## Using the Select/Set Wheel

There are basically two types of Wheel operation.

- Selecting items from an on-screen display.
- Entering information, such as setting the clock.

### OPERATION

- 1 Rotate** (up or down) **2 Push** (like a button)
- ROTATE TO SELECT      ROTATE TO SELECT
- PUSH TO SET      PUSH TO SET
- to make selection      to enter selection

## On-Screen Language, Cable box/ DSS receiver Setup, Channel Memory, and Auto Clock

- 1** Turn the TV and VCR power on.

- 2** Tune your TV to the VCR channel (the same channel you set on the back of the VCR, CH3 or CH4). (See page 6.)

- 3** Push VCR CH ▲ for English on-screen displays.
- or Push VCR CH ▼ for Spanish on-screen displays.
- or Push VCR/TV for French on-screen displays.

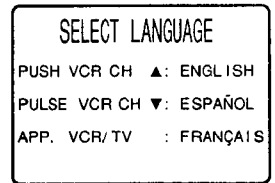

If you set the wrong language, see the "Reset all VCR Memory Functions" section on page 5.

- You can also set by using the same buttons on the VCR.

This screen appears a few seconds later.

- 4** or Push MENU for YES or PROG for NO. If YES, continue with next step. If NO, go to Alternate Instructions on page 14.

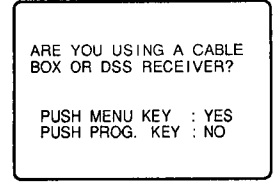

- 5** Rotate and push the WHEEL to select your equipment connection method. (Refer to page 10.) If "CABLE/DSS BOX- VCR- TV," go to step 6. If not, go to Alternate Instructions on page 14.

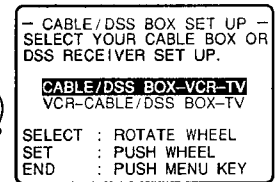

- 6** Rotate and push the WHEEL to set your Cable box or DSS receiver output channel. (the channel you tune the TV to in order to watch cable or DSS stations).

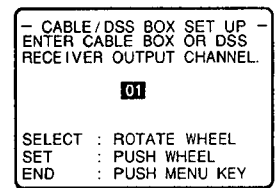

- If both a cable box and DSS receiver is used, set the output channel of the DSS receiver.
- If you are using Audio/Video jack connections, set VIDEO OUT as the output channel.

- 7** Rotate and push the WHEEL to select YES or NO. If YES continue with next step. If NO, go to Alternate Instructions on page 14.

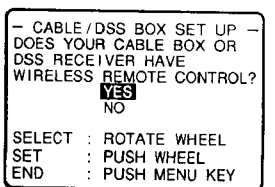

Continued on the next page.

**8**



Rotate and push the WHEEL to set the Cable box or DSS receiver code number that matches your brand from the list on page 11.

- This determines whether the VCR will control your cable box or DSS receiver.

```

- CABLE/DSS BOX SET UP -
CHOOSE A CODE NUMBER FOR
CABLE BOX/DSS RECEIVER
FROM THE LIST IN OWNER'S
MANUAL AND ENTER NUMBER.
02
SELECT : ROTATE WHEEL
SET : PUSH WHEEL
END : PUSH MENU KEY
    
```

**9**

If you use a cable box, tune it to channel 02.  
If you use a DSS receiver, tune it to any channel other than 200.



Push WHEEL to continue.

```

If Cable Box
- CABLE/DSS BOX SET UP -
PLEASE TUNE YOUR CABLE
BOX TO CH02.

If DSS Receiver
PLEASE TUNE YOUR DSS
RECEIVER TO CH 270.

PROCEED : PUSH WHEEL
END : PUSH MENU KEY
    
```

**10**



Rotate and push the WHEEL to select YES or NO.  
If you use a cable box and selected YES, go to step 11.  
If you use a DSS receiver and selected YES, go to the Alternate Instructions on page 14.  
If NO, the screen in step 8 will reappear. Try entering a different code assigned to your brand and/ or repositioning the equipment (see page 11).  
If the answer is still NO, cable box or DSS receiver control is not available. Push MENU and go to the Alternate Instructions on page 14.

```

If Cable Box
- CABLE/DSS BOX SET UP -
IS YOUR CABLE BOX
RECEIVING CH 09 ?
YES
NO

If DSS Receiver
IS YOUR DSS RECEIVER
RECEIVING CH 200?
YES
NO
SELECT : ROTATE WHEEL
SET : PUSH WHEEL
END : PUSH MENU KEY
    
```

**11**



Rotate and push the WHEEL to select and set the local PBS channel number you receive on your cable box.

- If you live near a different time zone, enter the channel in your time zone.

```

----- SET CLOCK -----
PLEASE ENTER YOUR LOCAL
PBS CHANNEL ON CABLE BOX
CH 12
SELECT : ROTATE WHEEL
SET : PUSH WHEEL
END : PUSH MENU KEY
    
```

**12**



Confirm that your cable box is on and that your DSS Box is off. Push WHEEL to start CHANNEL AUTO SET and AUTO CLOCK SET.

The following displays appear in sequence:  
"CH AUTO SET PROCEEDING"  
"CH AUTO SET COMPLETED"  
"AUTO CLOCK SET PROCEEDING"



This display appears when auto clock set is completed. Confirm that the time is correct and push CH to exit.

```

10/05/1996 WED 12:00PM
12/25/1996 WED 12:00PM
DST: ON
SETTING : CH02
AUTO CLOCK SET
COMPLETED
END : PUSH CH UP KEY
    
```

**If the Auto Clock Set displayed time is incorrect**

If you use a cable box and receive more than one PBS station, try auto clock set again. Follow the Set or Reset Auto Clock Set steps and when the instructions call for you to enter a PBS station, make sure to enter the one you have not tried yet.

**If AUTO CLOCK SET INCOMPLETE appears**

The screen below will appear on-screen if auto clock set data is not available in your area.

```

AUTO CLOCK SET
IS INCOMPLETE
PUSH MENU TO SET CLOCK
    
```

Push MENU to display the manual clock set screen. (See the "Manual Clock Set" section on page 14.)

**Note:**

If you use a cable box and receive more than one PBS station, you may exit the manual clock set screen and try auto clock set again. Follow the Set or Reset Auto Clock Set steps and when the instructions call for you to enter a PBS station, make sure to enter the one you have not tried yet.

- Auto clock set will be performed when the VCR is turned off for the first time each day. If you use a cable box and you want auto clock set to be performed, the cable box must be left on at the time the VCR power is turned off.



# One Time VCR Setup

## Alternative Instructions

Complete the following steps if, during one time setup, any of the following applies:

- A You selected NO in step 4 on page 12 (you do not use a cable box or DSS receiver).
- B You selected connection method 2 (VCR-CABLE DSS BOX- TV) in step 5 on page 12.
- C You selected NO in step 7 on page 12 (your cable box or DSS receiver is not remote controllable).
- D You use a DSS receiver and selected YES in step 10 on page 13.
- E Cable Box or DSS receiver can not be controlled in step 10 on page 13.

**1** Turn on the cable box and set it to the local PBS channel.

- If you live near a different time zone, make sure to set the channel in your time zone.
- If you use a DSS receiver, it must be turned off.

### CHANNEL/CLOCK AUTO SET

CONNECT ANTENNA CABLE AND IF YOU USE A CABLE BOX, TUNE IT TO YOUR LOCAL PBS CH THEN...

PLEASE PUSH CH UP KEY



Push CH ▲ to start CHANNEL AUTO SET and AUTO CLOCK SET.

The following displays will appear in sequence.  
"CH AUTO SET PROCEEDING"  
"CH AUTO SET COMPLETED"  
"AUTO CLOCK SET PROCEEDING"

This screen appears to confirm that auto clock set is completed.



Confirm that the time is correct and push CH ▲ to exit this screen.

If this screen appears, auto clock set is not available in your area. Please set the clock manually as described at right.

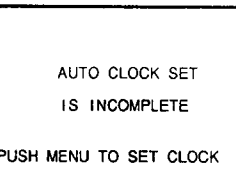
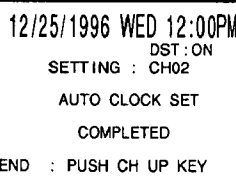

## If the displayed auto clock set time and D.S.T. are not correct

If you live close to two different time zones, the VCR may recognize the wrong PBS station as the setting channel. If this happens, please complete the following steps.

- 1 Make a note of the SETTING: CH number on screen and push CH ▲ to exit.
- 2 Delete the setting channel from channel memory. (See the Add or Delete a Channel section on page 15.)
- 3 Push MENU button to display the menu.
- 4 Use the Wheel to select "SET CLOCK" and then to select "AUTO SET."
  - If you use a cable box and have multiple PBS stations, tune the cable box to a different PBS station and try auto clock set again using the menu.

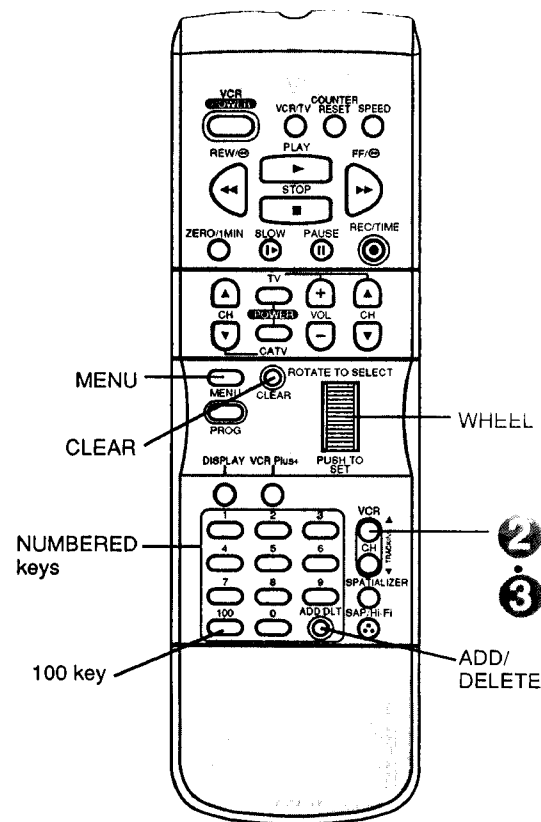

## Manual Clock Set

(In case Auto Clock Set could not be performed)

- 1 Push MENU to display the set clock screen.
- 2 Rotate and push the Wheel to select and enter the month, date, year, time and D.S.T. (Daylight Saving Time).

• "DST:ON" automatically adjusts for daylight saving time. (See page 5.)

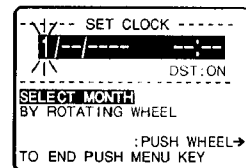

To Make Corrections, push the Wheel or CLEAR button repeatedly to move back or forward to the desired item.

- 3 Push MENU twice to start the clock and exit this mode.

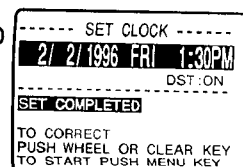

## To Change On Screen Display Language

- 1 Push MENU to display the menu.
- 2 Rotate the Wheel to select the language selection item.  
(English: LANGUAGE, Spanish: IDIOMA, French: LANGUE).
- 3 Push the Wheel to change the language.
  - Each Push will change the language in the order shown.
- 4 Push MENU to exit this mode.

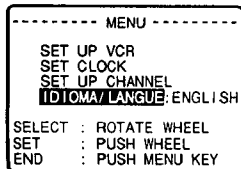

## To Set or Reset the Clock

In case the clock is wrong, or a power failure occurred.

- 1 Push MENU to display the menu.
- 2 Rotate and push the Wheel to:
  - (A) Select SET CLOCK
  - (B) Select MANUAL SET
  - (C) Set the date, time, and D.S.T. (Daylight Saving Time).
- 3 Push MENU twice to start the clock and exit this mode.

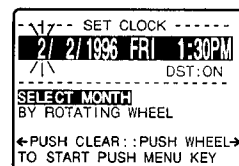
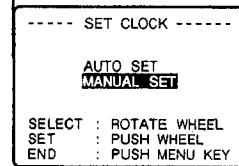
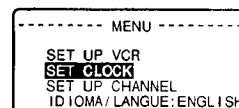

## To Add or Delete a Channel

- 1 Select a channel using the NUMBERED keys .
- 2 Push ADD/DLT to add or delete the channel.
  - To select a deleted channel, use the NUMBERED keys on the remote control. Deleted channels will flash in the Multi Function Display when selected.

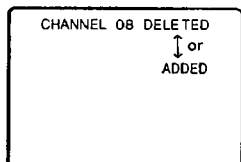

## To Set or Reset Auto Clock Set

Complete the following steps if:

- Auto clock set displayed time was incorrect.
- Auto clock set was not available at the time one time setup was done, but is available now.
- The PBS channel over which clock data is sent was changed by the broadcast company.

- 1 Push MENU to display the menu.
- 2 Rotate and push the Wheel to select SET CLOCK and then select AUTO SET.
- 3 Follow the one time setup instructions on page 12~14.

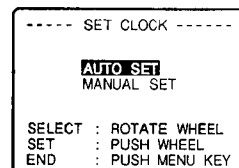

## When Using the 100 key

When selecting CATV channels 100 to 125 with the NUMBERED keys, first push the 100 key and then enter the remaining two digits.  
For example, to select channel 125: Push NUMBERED keys 100, then 2, then 5.

## To Replace Channels in Memory

Example, if you have cable installed, etc.

- 1 Push MENU to display the menu.
- 2 Rotate and push the Wheel to select SET UP CHANNEL from menu, and then push to set your antenna system (TV or CATV).
- 3 Rotate and push the Wheel to select AUTO SET.
  - To exit this mode, push MENU twice.
- 4 Follow the one time setup instructions on page 12~14.
  - Whenever channels are replaced in memory, auto clock set is also reprogrammed.

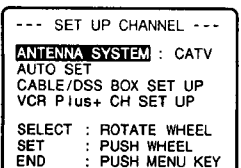
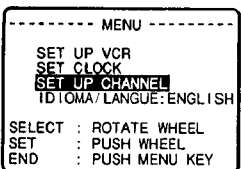

## To setup the VCR in case a cable box or DSS receiver was installed or replaced

- 1 Push MENU to display the menu.
- 2 Rotate and push the Wheel to select SET UP CHANNEL from menu.
- 3 Rotate and push the Wheel to select CABLE/DSS BOX SET UP.
  - To exit this mode, push MENU twice.
- 4 Rotate and push the Wheel to select YES and continue with steps 5~10 on pages 12 and 13.

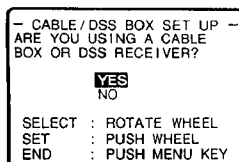
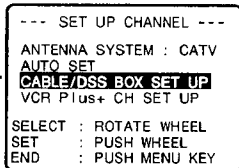
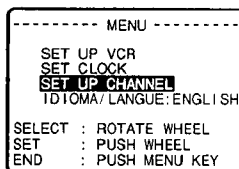

- This VCR will accurately maintain its calendar up to Dec. 31, 2014, 11:59PM.
- Normal TV or Cable channels are automatically selected and placed in memory depending on how your VCR is hooked up.
- By pushing the Wheel or CLEAR button repeatedly, you can skip forward or backward over correct entries and go directly to a specific item.

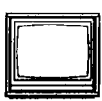

# On Screen Displays (OSD)

## Channel & Function Display

Whenever the channel is changed, the Channel number will appear for a few seconds on-screen. (Some station names may also appear.)

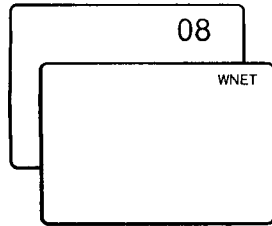

When a function button is pushed (PLAY, FF, etc.) the VCR mode will be displayed.

## Warning and Instruction Displays

These displays will alert you to a missed operation or provide further instructions.

If no active channels are found for CHANNEL MEMORY...

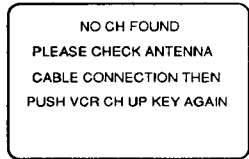

If you attempt to set or review a Timer Recording and the Clock is not set...

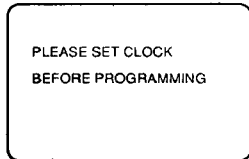

If a Timer Program was not completed before exiting the Program mode...

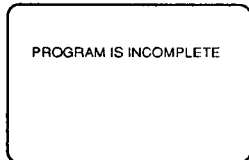

After a Timer Program has been set...

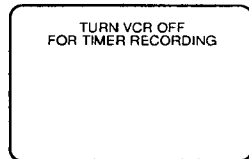

If you push REC on the remote control or REC and PLAY on the VCR, and a cassette is inserted with no record tab...

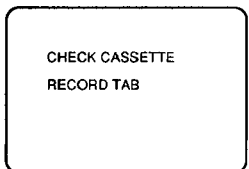

If you push PLAY, FF, REW, or REC on the remote control or if you push REC and PLAY, PLAY, FF, REW, or REC on the VCR without a cassette inserted...

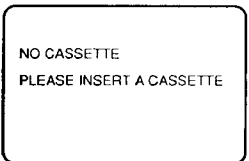

If you push POWER or STOP during a Timer Recording... (visible in VCR mode only)

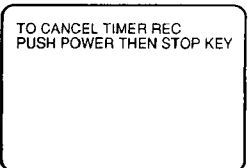

## Menu Screen

1 Push MENU to display the menu.

2 Rotate and push the wheel to make your selection (see page 12).

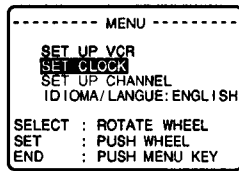

- To get the most from each feature, it is recommended that you read the Operation Manual before attempting any operation.

## VCR Status & Clock Display

Push DISPLAY to display and remove the overlay shown below.

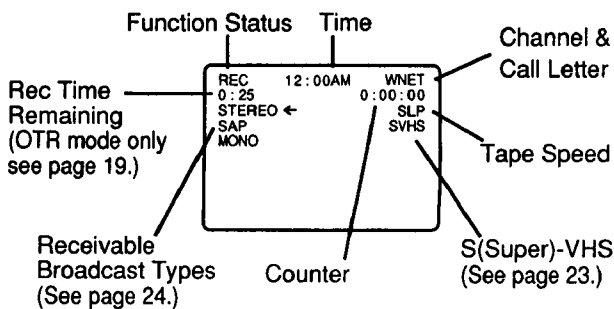

## Blank Tape and will be Blue Screen

If a blank section of tape is encountered in the Play mode or the channel you select has no broadcast, the TV screen will change to a solid blue field. The screen will remain blue until a recorded signal is again detected or an active channel is selected.



# ▶ Playback a Tape

## ✓ Check list before you begin

- All connections are made. (See pages 6-9.)
- TV and VCR are plugged in.
- TV is turned on and set to the VCR channel (CH 3 or 4).

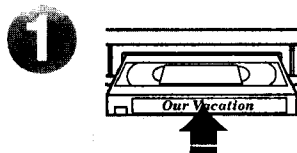
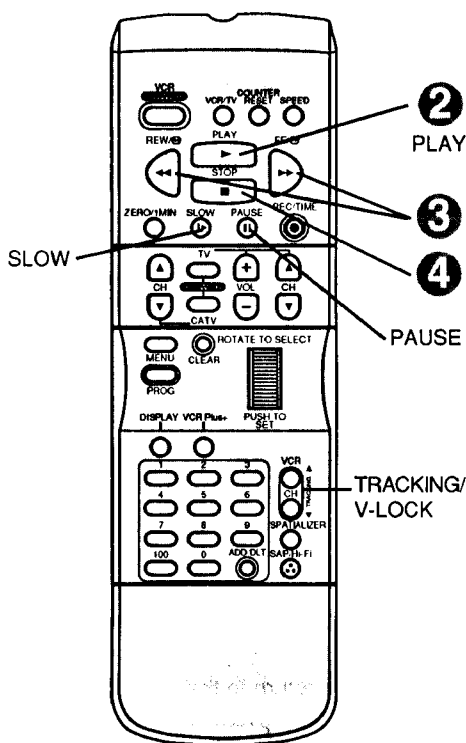
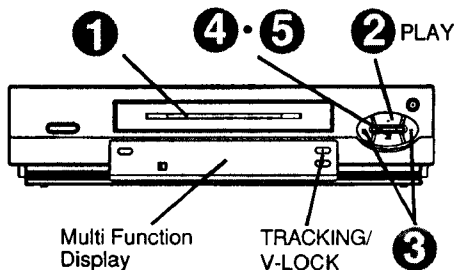

Insert a cassette.  
• VCR power comes on automatically.

This indicator lights in the Multi Function Display.

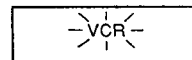

Push PLAY to start playback.

- Playback begins automatically if cassette has no record tab.

(VCR or Remote Control)

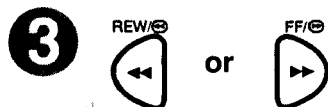

Push REW or FF to quickly locate a scene.

- SP mode tapes have a search speed of 9 times and SLP mode tapes 27 times the normal speed.
- Some noise bars will appear during search.

(VCR or Remote Control)



Push STOP to stop playback.

(VCR or Remote Control)



Push STOP/EJECT to eject the cassette.

- This button only on VCR.

## Special Effects During Playback

These features work best in SP or SLP mode. The sound will be muted. (After the VCR is in the Still or Slow mode for 3 minutes, it will go into the Stop mode automatically to protect the tape and video head.)

### Slow Motion Playback

Push SLOW to start and PLAY or SLOW to release the Slow mode.

### Still (Freeze) Frame Picture

Push PAUSE to freeze and release the picture.

- To reduce picture noise:  
Place the VCR in Slow motion mode. Use TRACKING ▲/▼ to clear up the picture, then Push PAUSE.

### Frame by Frame Advance

While in Still mode, hold down SLOW to advance the still picture one frame at a time. Push PAUSE to release.

## Feature for a Quality picture

### Digital Auto Picture

This feature automatically controls the video output signal for less noise depending on the tape condition.

### Digital Auto Tracking

This feature continuously analyzes the signal and adjusts for optimum picture quality.

### Manual Tracking Control

Use during Playback and Slow Motion mode to reduce picture noise. Push VCR CH (TRACKING) ▲/▼ buttons until the picture clears up. To return to Auto Tracking mode, push VCR POWER off and then on again.

### V-Lock Control

In Still mode, the VCR CH (TRACKING) ▲/▼ buttons operate as a V-Lock control to reduce jitter. Push ▲/▼ until the picture is stabilized.

### DynAmorphous™ Metal Head/ CNR (Color Noise Reduction)/ ANR (Advanced Noise Reduction)

DynAmorphous™ Metal Head increases playback and record picture quality. Color Noise Reduction reduces the color noise. Advanced Noise Reduction reduces the luminance noise.

## Caution:

Please inspect your cassette tape for any loose or peeling labels as it may become jammed in your unit.

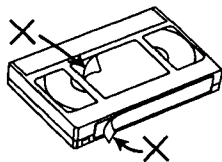



# Tape Operation

Your VCR is equipped with several time saving features as well as convenient automatic functions which make tape operation easier than ever.

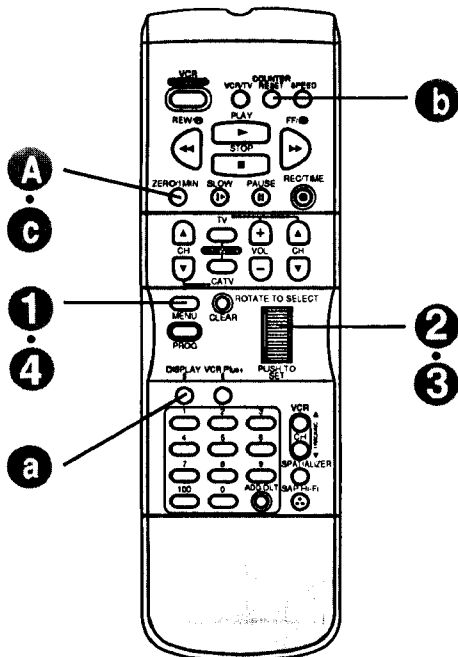

## Repeat Play

You can set your VCR up to play a recording over and over.



1 Push MENU to display the menu.

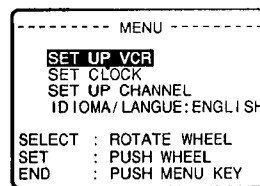

2 Rotate and push the WHEEL to select SET UP VCR.



3 Rotate the WHEEL to select "REPEAT PLAY", then push to select "ON" or "OFF."

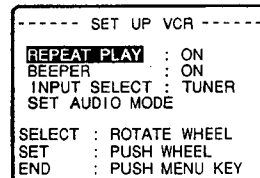

- The VCR plays to the end of a tape, or until a blank portion of 30 seconds or more is reached. (Erased portions of tape are not considered blank.) The tape is then automatically rewound and played again and again until Repeat Play is cancelled. All function buttons (REW, FF, etc.) are operational during Repeat Play.



4 Push MENU twice to leave this screen.

## One Minute Skip

With this feature, you can skip over commercials recorded on a tape.



A Push ZERO/1MIN in Play mode.

- The VCR will go into FF search mode and skip over 60 seconds of recorded time. Then, normal playback will resume.

## Auto Operation Functions

### Auto Playback

When a tape is inserted, the power comes on (Auto). If the record tab\* is removed, playback begins (Auto).

### Auto Rewind

After a tape reaches its end during playback, fast forward or manual record, the VCR will rewind and go into Stop mode.

### Playback Auto Eject

After a tape without a record tab\* is played to its end, the VCR will rewind and then eject the tape.

### Memory Rewind Off

When the POWER button is pushed during rewind, the VCR will turn off after rewind is complete.

### Eject Cassette

A cassette may be ejected with power on or off.

\* For record tab information, see page 5.

## Zero Search

You can reset the Time Counter to zero and then return to that point.



a Push DISPLAY to display the Time Counter overlay.

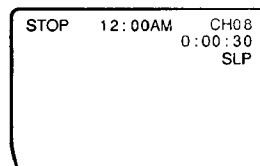

b Push COUNTER RESET to reset the Time Counter.

- This may be done at as many places as you wish on the tape.

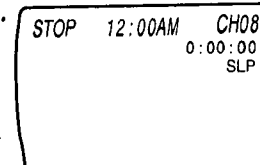

c Push ZERO/1MIN in Stop mode.

- The VCR will go into FF or REW mode and stop at the last point the Time Counter was set to 0:00:00.

# Record On a Tape



## Check list before you begin.

- All connections are made. (See pages 6~9.)
- VCR is Plugged in.
- TV is turned on and set to the VCR channel (CH3 or CH4).

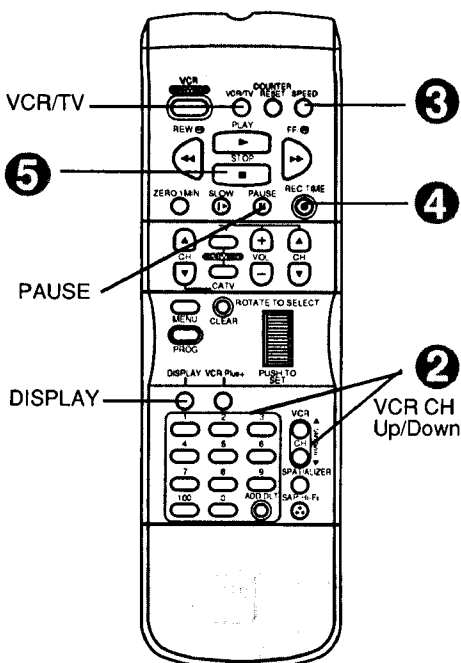
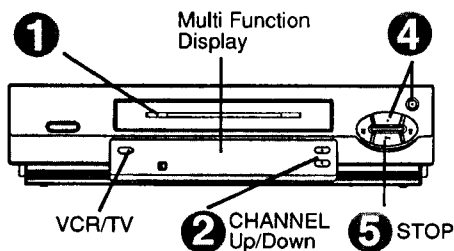

**1**

Insert a cassette with record tab.

- VCR power comes on automatically.

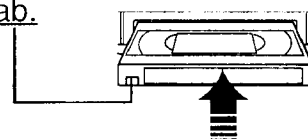

**2**



Push VCR CH ▲/▼ or **NUMBERED** keys to select a channel.

- Or, push CH ▲/▼ on the VCR.
- To record from an outside source, push VCR CH ▲/▼ to select "LINE" (see page 22).

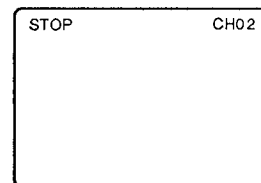

**3**



Push **SPEED** to change current recording speed.

- SP = Standard Play, LP = Long Play, SLP = Super Long Play.

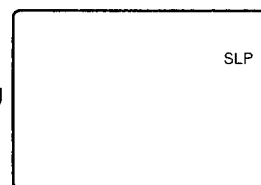

**4**



Push **REC/TIME** to start recording.

- Or, push **PLAY** and **REC/TIME** on VCR.

### One Touch Timer Recording (OTR)

The VCR starts recording and turns itself off at a preset time.

Continue to push **REC/TIME** to set the recording length. Each Push will change the stop time as shown.

- "TIMER" lights in the Multi Function Display.

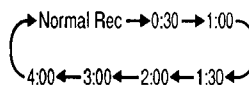

**5**

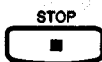

Push **STOP** to stop recording.

- Or, push **STOP** on VCR.

## Watching Another TV Program

- 1** Push **VCR/TV** while recording is in progress to turn off the VCR indicator in the Multi Function Display.
- 2** Use the TV channel controls to select a program. The VCR will continue to record your program while you watch any channel you choose.
  - Switch back and forth between the recording and viewing channel with the **VCR/TV** selector.

## Selecting Channels at the VCR

- 1** Turn TV on.



If indicator doesn't light, push **VCR/TV** to turn it on.

- 2** Use **VCR CH ▲/▼** buttons to select channels for viewing or recording.
  - To resume TV control channel selection, push **VCR/TV** to turn VCR indicator off, or simply turn VCR off.



- Holding down the **VCR CH ▲/▼** buttons will increase the channel search speed.
- Push **PAUSE** to pause a recording in progress. (After the VCR has been in Pause mode for 5 minutes, it will stop automatically to protect the tape and video head.)
- The recording time remaining appears if the **DISPLAY** button is pushed during OTR mode (See page 16).



# Timer Recording

Your VCR can be set up to do a recording while you are away or otherwise occupied. Up to 8 programs can be placed in memory. You can choose to record one time, daily, or weekly.



## Check list before you begin.

- All connections are made. (See pages 6~9.)
- TV and VCR are plugged in and turned on.
- VCR/TV selector is set to "VCR."
- Clock is set to correct time.
- Record tab in place. (See page 5.)

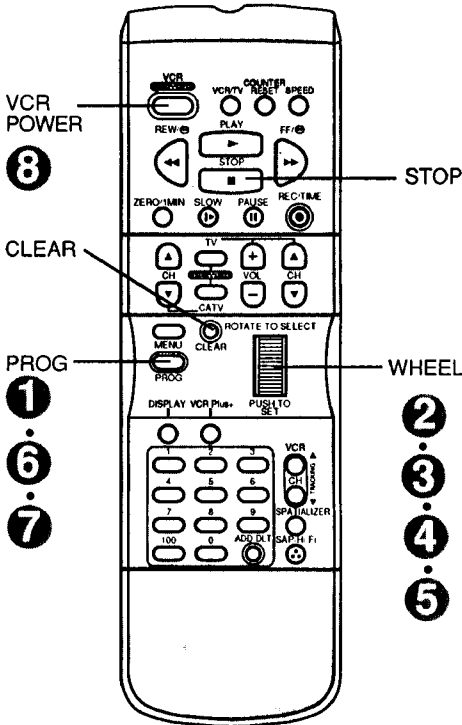
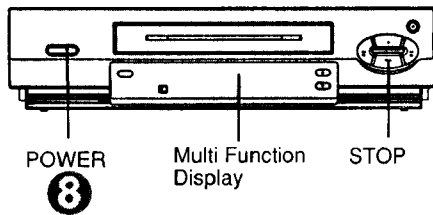

## Important notes when using a DSS receiver.

- When recording programs via a DSS receiver the DSS receiver must be left on.
- When recording programs via an antenna or cable, the DSS receiver must be turned off.



- If a DSS channel is selected, the channel will appear as blue numbers on white background.
- If the cassette record tab is missing at the time the VCR power is turned OFF, the tape ejects and the TIMER indicator flashes in the Multi Function Display.
- If the start times of two programs overlap, the lower numbered program will have priority.
- If the start time for a timer recording comes up during a normal recording or One Touch Recording (page 19), the timer recording will not be performed.
- If "PROGRAM IS INCOMPLETE" appears on-screen in step 4, check all entries and make necessary corrections.



Push PROG to display the program screen.

- If a program is already in memory, use the Wheel to select an unused program number.

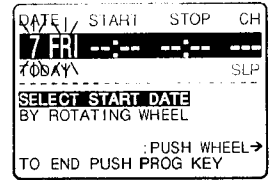

Rotate and push the WHEEL to select and set the DATE.

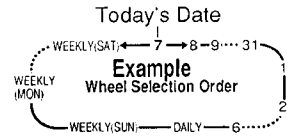

## Daily and Weekly Timer Recording

If you want the program to be recorded daily (Mon thru Fri), enter DAILY in place of the DATE in step 2. If you want the recording to be on a weekly basis, enter WEEKLY MON, TUE, etc..

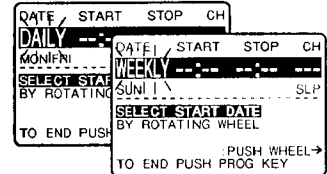

Rotate and push the WHEEL to select and set remaining items at right.

## Remaining Items to be set:

- START time
- STOP time
- CH(annel) number, or LINE for outside source recording.
- Speed (SP, LP, SLP).

## To Make Corrections

Repeatedly push the Wheel to move forward, or the CLEAR button to move back to the desired item.



Push the WHEEL when program is completed. "PROGRAM COMPLETED" will appear on-screen.

- If "PROGRAM IS COMPLETE" appears on-screen, check all entries and make necessary corrections.
- If you enter a channel number of 100~125, the screen at right appears a few seconds later.

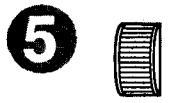
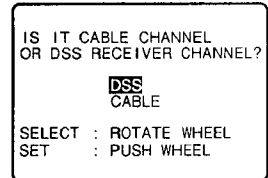

Rotate and push the WHEEL to select "DSS" or "CABLE."



Push PROG to end the program.

- If you want to enter more programs, select a blank program number with Wheel and repeat steps 2 and 3.

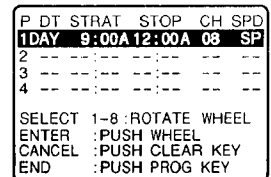

Push PROG to exit this mode.



Push VCR POWER off to set the timer.



Multi Function Display

- When recording programs via a cable box, make sure the cable box is left on. If the cable box cannot be controlled with the VCR, you must manually select the desired channel.

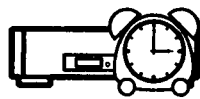

# Timer Recording Using VCR Buttons

## Cancel a Timer Recording: Recording is in progress

- 1 Push the VCR POWER button to release the VCR from timer mode.
- 2 Push the STOP button within 10 seconds of pushing the VCR Power button to cancel the recording. The TIMER indicator goes out in the Multi Function Display.

A timer recording can be set up using the buttons on the VCR. If necessary, the clock can also be set.

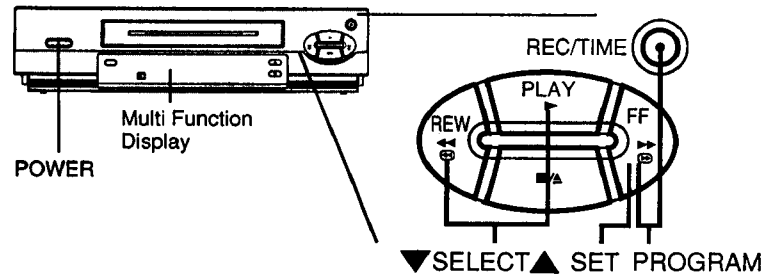

## Replace Program Contents: Recording is not in progress

- 1 Push the PROG button to display all currently set programs.
- 2 Rotate and push the Wheel to select and enter the desired timer recording. (See page 20.)
- 3 Rotate and push the Wheel to select and enter replacement information.
- 4 Push the PROG button to exit this mode and return to the normal TV screen.

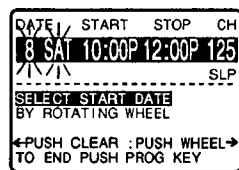
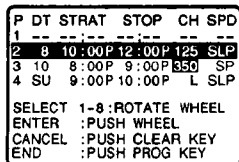

- 1 Hold down REC/TIME.

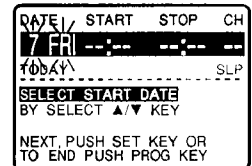

- and
- Push FF to enter the program mode.

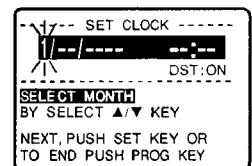

- If the clock is not set, pushing these buttons will display the SET CLOCK screen. In this case, proceed with steps 2 and 3 to set the clock and then steps 2-6 to set a timer recording.
- Once the VCR is in the Program mode, the PLAY, REC, FF, and REW buttons on the VCR operate only as specified above.

- 2 Push REW or PLAY to make your selection.
- (for down)      or      (for up)

- 3 Push FF to set and move on to the next item.
- Items to be Set:
- recording DATE
  - START time
  - STOP time
  - CH(annel), or LINE
  - SPEED (SP, LP, SLP)

## Review or Clear Program Contents: Recording is not in progress

- 1 Push the PROG button to display all currently set programs.
- 2 Rotate the Wheel to select the desired program number.
- 3 Push the CLEAR button to clear the program.
- 4 Push the PROG button to exit this mode and return to the normal TV screen.

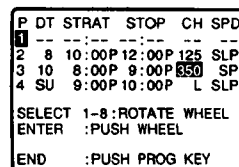
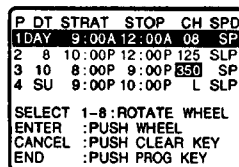

When the program is completed...

- 4 Push REC/TIME and FF to display program contents.
- (at the same time)

To set the next program, repeat steps 2, 3, and 4 before continuing with step 5.

- 5 Push REC/TIME and FF to exit this mode.
- (at the same time)

- 6 Push POWER off to set the timer.

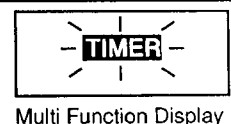

- It is not possible to clear a timer program using the VCR buttons. Please use the Remote Control.
- When recording programs via a cable box, make sure the cable box is left on. If the Cable box cannot be controlled with the VCR, you must manually select the desired channel.

More You Can Do



# Copying Your Tapes (Dubbing)

## Connections you'll need to make.

- on the editing S-VHS VCR, set the S-VHS selector to on.

TV for Monitoring

Recording (Editing) VCR

Playing (Source) VCR

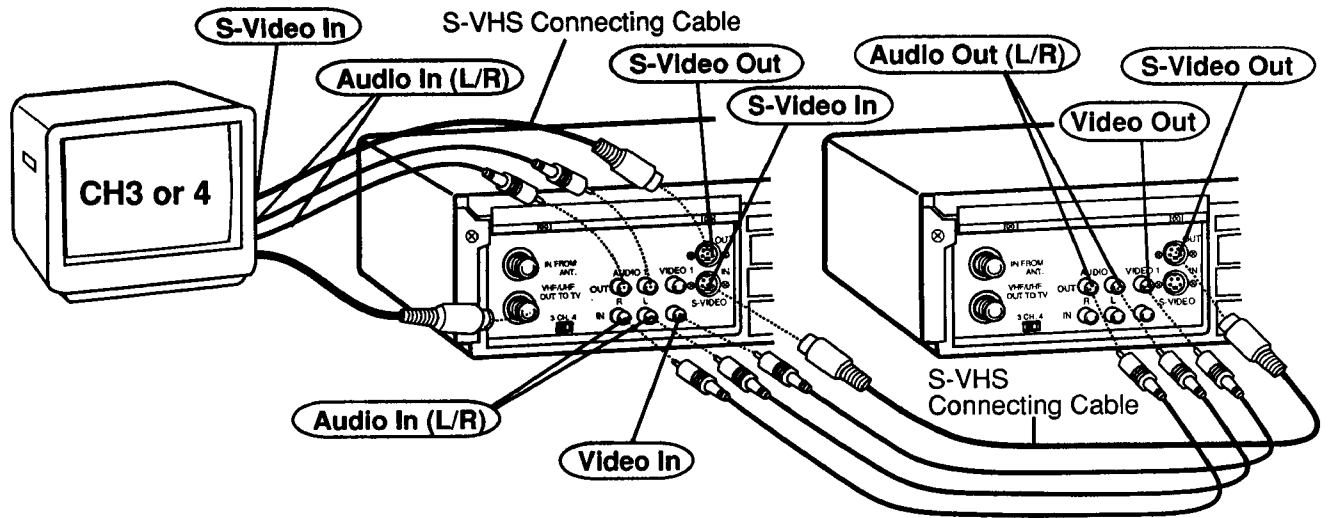

- 1 Insert a pre-recorded tape into the Playing (Source) VCR.

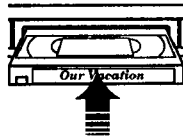

- 2 Insert a blank tape with record tab into the Recording (Editing) VCR.

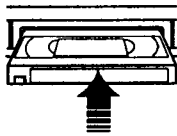

- 3 Select Input "LINE" on the Recording (Editing) VCR. (See "Selecting the Input Mode" at right.)

- 4 Push PLAY on Playing VCR. Push PAUSE at the point you want to start copying.

- 5 Push REC and PLAY at the same time on Recording VCR. Push PAUSE immediately.

- 6 Push PAUSE on both VCRs (at the same time), to begin copying.

### Edit Out Unwanted Parts

of the original recording by using the PAUSE button (on the Recording unit) while copying is in progress.

- 7 Push STOP on both VCRs to stop copying.

### Caution:

Unauthorized exchanging and/or copying of copyrighted recordings may be copyright infringement.

## To Monitor the Re-Recording

- 1 Turn the TV on and select its VCR channel (CH3 or CH4) on the Recording VCR.
- 2 Set the VCR/TV selector on the Recording VCR to the "VCR" position.

## Selecting the Input Mode

- 1 Push MENU to display the menu.
- 2 Rotate and push the Wheel to select SET UP VCR.
- 3 Rotate the Wheel to select "INPUT SELECT", and then push to choose TUNER or LINE.
  - You can also select "LINE" using the VCR CH ▲/▼ buttons. The numbers will change in the order shown.

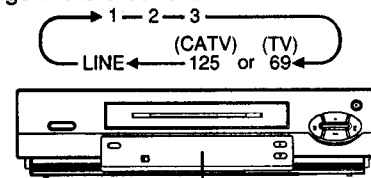
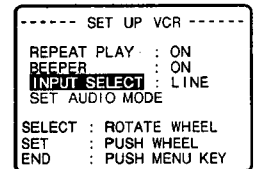
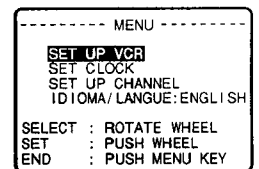

- When LINE is selected, "L" is displayed in the Multi Function Display for about 4 seconds.



- If one of the VCRs you are using is a conventional VHS VCR, connect the VIDEO OUT terminal of the Source VCR and the VIDEO IN terminal of the Editing VCR using the Video Cable, instead of the S-VHS Connecting Cable. Refer to the TV Operating Instructions for connection of the TV.

# S-VHS Super (S) VHS System

S-VHS tape playback is superior to VHS, even when using a conventional TV. And, your S-VHS VCR can also play back VHS format tapes.

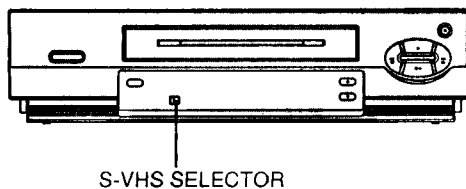
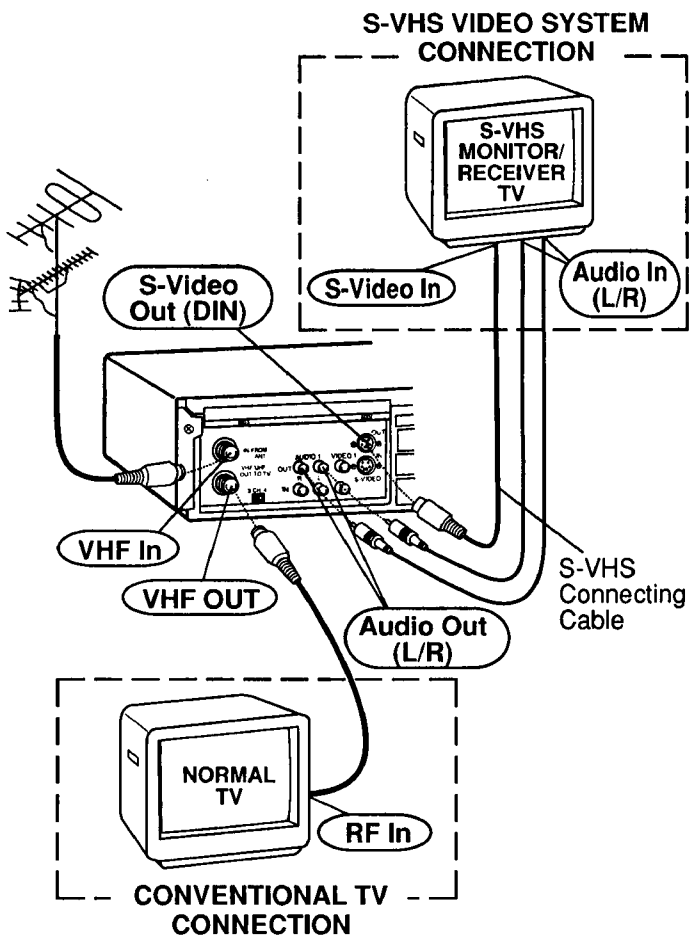

## S-VHS and VHS Tapes

Both Super-VHS and VHS recordings can be made on an S-VHS tape. Tapes recorded in VHS may be played back on either an S-VHS or VHS type VCR. Tapes recorded in S-VHS cannot be played back on a conventional VHS VCR.

- When a VHS recorded tape is played back on your S-VHS VCR, the VHS mode is automatically selected. Playback and Recording operations are described on pages 17 and 19.

## Compatibility

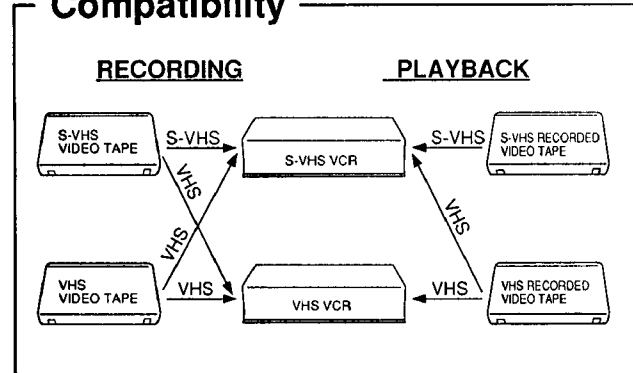

## S-VHS/VHS System Selections

When the S-VHS Selector switch is set on, the recording mode is automatically set according to the type of cassette tape used, S-VHS or VHS. When the S-VHS Selector switch is set to off, recording is done in the normal VHS mode, regardless of the type of cassette tape inserted. Use the off position when recording on an S-VHS tape in VHS mode to be played back on a VHS VCR.

S-VHS SELECTOR S-VHS AUTO OFF <input type="checkbox"/> ON <input type="checkbox"/>	Cassette Tape	
	SUPER VHS	VHS
ON	S-VHS RECORDING	VHS RECORDING
OFF	VHS RECORDING	VHS RECORDING



- A conventional VCR will not be able to play back your S-VHS recordings. To make recordings that are compatible with conventional VHS VCR's, use your S-VHS VCR with the S-VHS Selector switch set to "OFF".
- The "S-VHS" indicator appears on screen when the power comes on, when using an S-VHS tape to make an S-VHS recording and during S-VHS tape playback.

More You Can Do

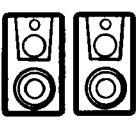

# MTS Broadcast/ VHS Hi-Fi Stereo System



## Check list before you begin

- The VCR is connected to a stereo TV, or a mono TV and stereo amp or receiver with speakers.
- The VCR and other components are plugged in and turned on.

## Connections to Make

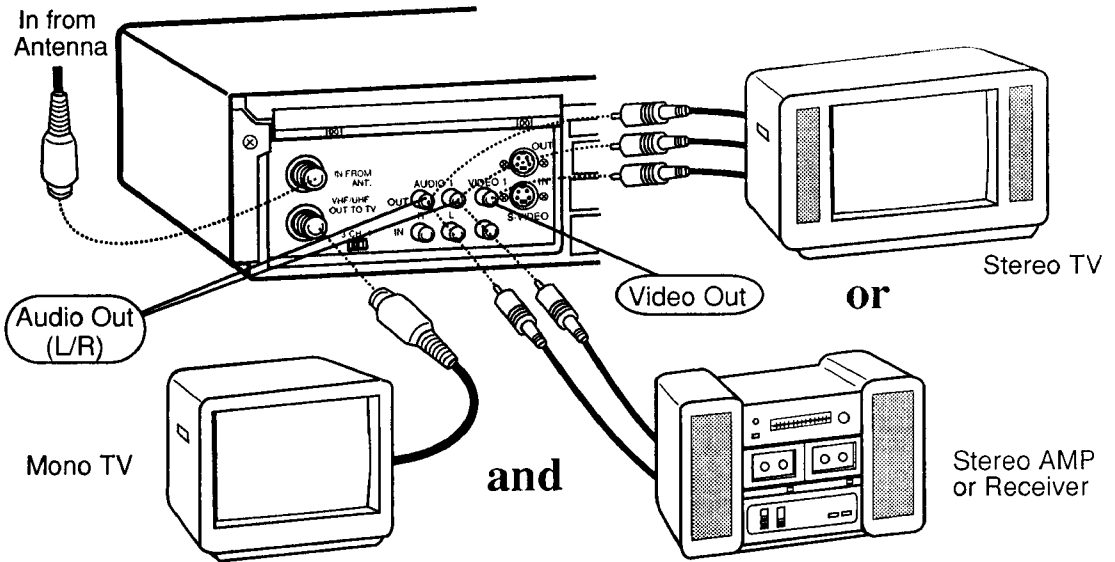

When recording, you may monitor in stereo, by connecting the VCR to either a stereo TV, or a mono sound TV with stereo amp and speakers.

## Receivable Broadcast Types

The following are possible broadcast types with their accompanying on-screen displays. The signal(s) not being received is enclosed in parenthesis. The currently selected audio mode is indicated with an arrow. To change the audio mode for listening to, or recording these broadcasts, follow the steps on page 25.



Push DISPLAY to display the broadcast signal currently being received on-screen.

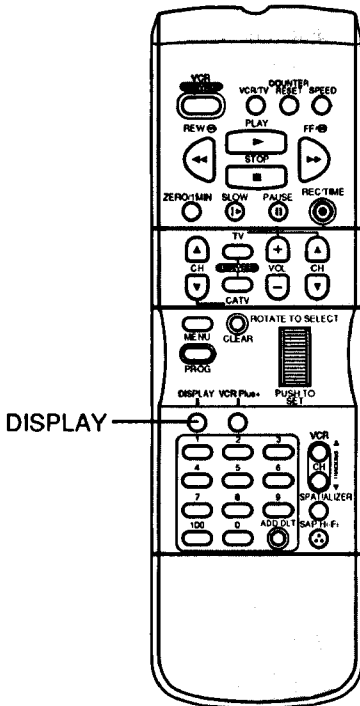

### MTS Stereo and SAP broadcast

Multi-channel Television Sound Stereo (main language) and Second Audio Program (second language) broadcasts are being received simultaneously. Select the STEREO or SAP audio mode as desired.

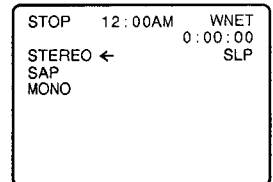

### MTS Stereo broadcast

Multi-channel Television Sound Stereo broadcast is being received.

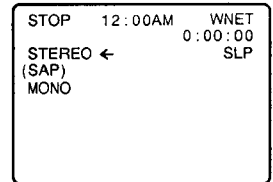

### SAP broadcast

Second Audio Program (second language) broadcast is being received. Select SAP audio mode for the second language.

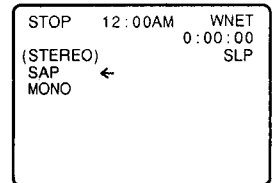

### MONO broadcast

Normal monaural sound broadcast is being received.

- If a stereo broadcast is weak and the display flickers, you may want to select the MONO audio mode for better results.

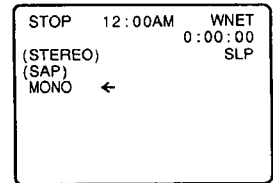

Equipped with **dbx**<sup>®</sup> -TV Noise Reduction for true MTS reproduction. **dbx**<sup>®</sup> -TV Noise Reduction is required for good stereo separation and audio fidelity. **dbx**<sup>®</sup> is a registered trademark, and is licensed by **dbx**<sup>®</sup> Technology Licensing.

- When recording, the currently selected broadcast sound is always recorded on the left and right Hi-Fi tracks as well as the normal monaural track. This means your tapes can be played back on Hi-Fi as well as non-Hi-Fi VCRs.



**With the proper audio mode setting, your VCR can:**

- 1) record and playback an MTS stereo broadcast (main language) in stereo Hi-Fi.
- 2) record and playback a monaural broadcast (main language) or Second Audio Program (second language) on the Hi-Fi tracks for better quality monaural sound.
- 3) playback non Hi-Fi tapes in monaural.

## Selecting the Audio Mode for Recording

Select the type of broadcast and sound track you wish to record.



Push SAP/Hi-Fi repeatedly (each press within 5 seconds) to select the desired audio mode (STEREO/SAP/MONO).

- Please refer to "Receivable Broadcast Types" section on previous page.

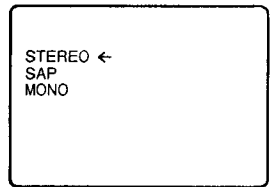

- The currently selected audio mode is indicated with an arrow.

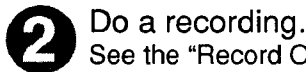

Do a recording.  
See the "Record On a Tape" section on page 19.

## Selecting the Audio Mode for Playback

Select the type of sound track you desire for playback.



Push SAP/Hi-Fi repeatedly (each press within 5 seconds) to select the desired audio mode (HIFI/NORMAL).

- Please select HIFI to listen to your stereo recordings with stereo sound or MONO for monaural sound.

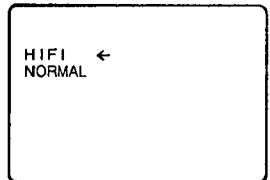

- The currently selected audio mode is indicated with an arrow.

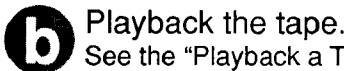

Playback the tape.  
See the "Playback a Tape" section on page 17.

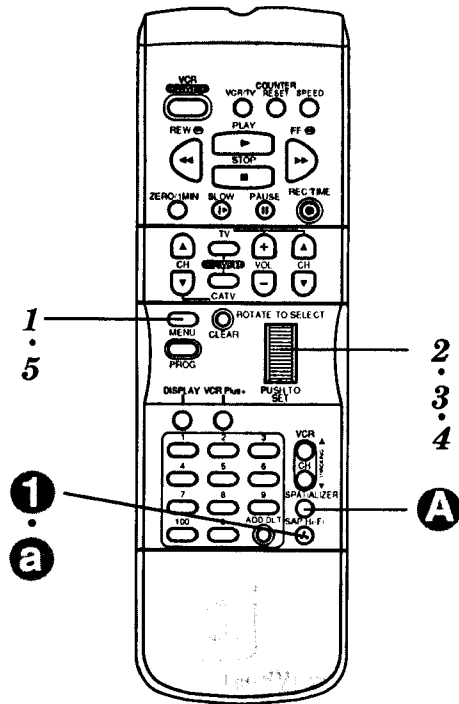

## Spatializer Feature

This feature allows you to enhance the stereo sound so that it seems to completely surround you.

**Note:** Your VCR needs to be hooked up to a stereo TV or stereo amp/receiver with speakers (see page 24). For playback, tapes must be recorded in Hi-Fi stereo. For TV viewing, programs must be broadcast in stereo.



Push SPATIALIZER repeatedly to choose the desired setting.

- Each push will change the display in the order shown.

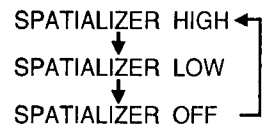

Portions of this product manufactured under a licence from Desper Products, Inc. SPATIALIZER, and the circle-in-square device are trademarks owned by Desper Products, Inc.



• When purchasing or renting prerecorded tapes, remember that only those recorded in Hi-Fi stereo will play back with true stereo sound. Standard stereo tapes will play back with monaural sound.

- In order to listen to Hi-Fi stereo playback, the VCR AUDIO (L/R) jacks must be connected to a stereo TV or stereo amp and speakers. (See previous page.)
- When adjusting the tracking during playback, the Hi-Fi audio sound may revert to normal audio sound. This is normal.
- There may be a difference in audio level between Hi-Fi and normal audio playback.

## To Select Audio Mode From Menu

- 1 Push MENU to display the menu.
- 2 Rotate and push Wheel to select SET UP VCR from menu.
- 3 Rotate and push the Wheel to select SET AUDIO MODE.
- 4 Push the Wheel to set the desired audio for listening or recording.
  - For recording, set to "STEREO", "SAP", or "MONO".
  - For playback, set PLAY AUDIO to "Hi-Fi", or "MONO".
- 5 Push MENU three times to exit this mode.

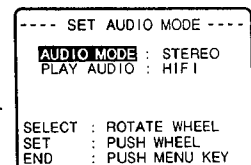
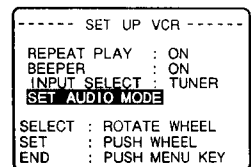

More You Can Do



# VCR Plus+ Set Up

This setup is for VCR Plus+ and timer programming only.

VCR Plus+ programming allows you to set most items of a timer recording by simply entering a special code found in *TV GUIDE* magazine as well as the TV listings in selected newspapers. In order for the VCR to read this special code, some set up is required. A Guide (VCR Plus+) channel number is assigned to each local broadcast and cable station. Because this number sometimes differs from the channel your TV receives the station on, it is necessary to program the VCR with local channel information.

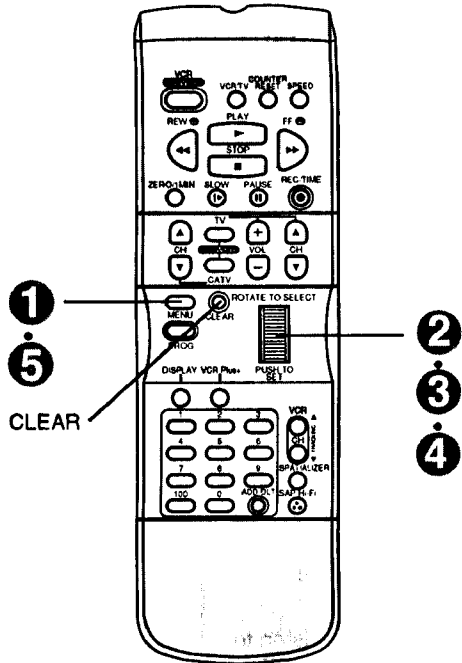

## VCR Plus+ Channel Set Up (Connection Method 2 on page 10)

**1** Push **MENU** to display the menu.

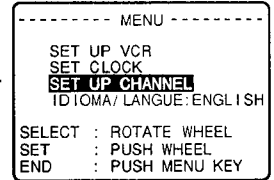

**2** Rotate and push the **WHEEL** to select **SET UP CHANNEL**.

**3** Rotate and push the **WHEEL** to select **VCR Plus+ CH SET UP**.

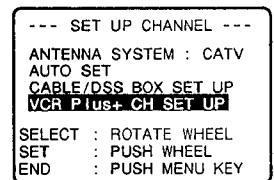

### IMPORTANT NOTE:

For this step, use the list you prepared. You may leave lines blank if, you don't receive that station, or the **GUIDE CH** number and the **CATV (or TV) CH** numbers are the same.

**4** Push **WHEEL** to move the shaded area on the right side.

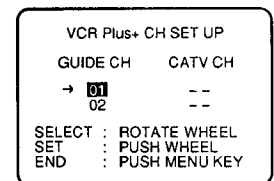

Then, rotate the **Wheel** to change **CATV** or **TV CH** number.

Next, push the **Wheel** to enter **CATV** or **TV CH** number.

Now, rotate the **Wheel** to continue. Repeat this operation until the list is complete.

### To Make Corrections

Rotate and push the **Wheel** to select the incorrect **CATV** or **TV CH** number. Then, Push **CLEAR** to delete the numbers. Now, use the **Wheel** to re-enter the channel.

**5** Push **MENU** twice to exit the **VCR Plus+ CH SET UP** mode.



- Make your entries within 60 seconds or the VCR will leave this mode.
- Once local channels have been programmed, they will stay in memory, even in the case of a power failure.

## Channel Set Up Preparations

**NOTE:** Complete the steps on this page if you are using Connection Method 2 on page 10 for VCR hookup.

Prepare a list like the example below.

This list will help you smoothly enter the information needed in step 4 at right.

You will need the following to complete the list:

- A line up of normal and/or cable stations you receive along with the channel numbers your TV receives them on. A cable channel line-up chart is supplied by your cable company.
- A list of Guide (VCR Plus+) channel numbers assigned to the stations you receive. This list is available in *TV Guide* and the TV listings found in selected newspapers.

- 1 Make a chart with 3 columns like the example below. In the left column, fill in the name or call letters of the stations you receive.
- 2 In the middle column, fill in each station's assigned Guide (VCR Plus+) number found in *TV Guide*, newspapers, etc.
- 3 In the right column, fill in the channel number that your TV receives the station on from your channel line-up.

EXAMPLE ONLY

Broadcast or Cable Station Name	Assigned Guide (VCR Plus+) channel no.	Channel no. your TV receives the station on
HBO	33	15
Nickelodeon	38	20
CBS	04	04
FOX	11	

VCR Plus+C<sup>3</sup> and PlusCode are trademarks of Gemstar Development Corporation. The VCR Plus+ system is manufactured under license from Gemstar Development Corporation.



# VCR Plus+ Programming

## ✓ Check list before you begin.

- The clock is set.
- One Time VCR Setup is complete. (See pages 10~14.)
- VCR Plus+ Set Up is complete. (See page 26.)

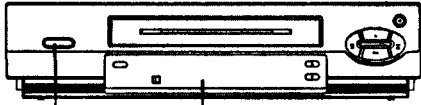

6 Multi Function Display

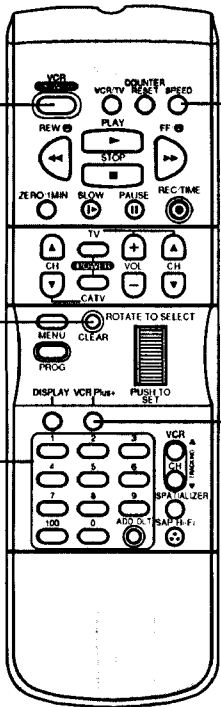

- 6 SPEED
- 1
- 3
- 5
- 2
- 4
- CLEAR



Push VCR Plus+ to display the VCR Plus+ screen.

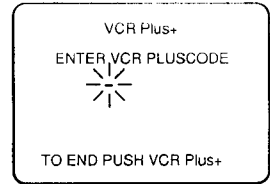

Push the Numbered Keys to enter the PlusCode number.

- Refer to your local TV listings.

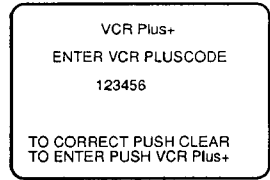

### To make corrections

Push the CLEAR button repeatedly to delete the PlusCode number. Then, enter the correct number.



Push VCR Plus+ to lock in your program.

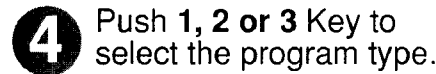

Push 1, 2 or 3 Key to select the program type.

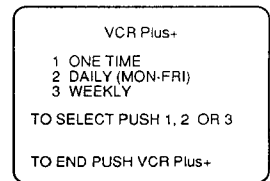

To change the recording speed: Push the SPEED button for SP, LP or SLP.

To cancel program contents: Push the CLEAR button.

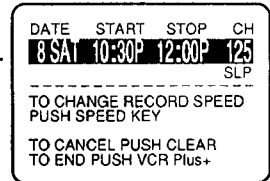

- If you use Connection Method 1 on page 10, the channel shown in the on-screen display in this step will always be the cable box output channel number.



Push VCR Plus+ to complete the program.

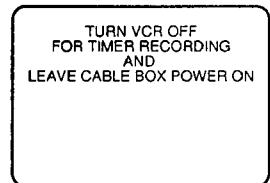

- When recording programs via a cable box, make sure the cable box is left on. If the cable box can not be controlled with the VCR, you must manually select the desired channel.

- This display may differ depending on your cable box hook-up.



Push VCR POWER off to set the timer.

Multi Function Display



### Use normal Timer Recording steps if:

- the PlusCode for a program is not listed.
- you anticipate the program, such as a sporting event, to run over the scheduled stop time.

### See page 21 to:

- Cancel a timer recording in progress
- Replace program contents
- Review or Clear program contents once set

### Important notes when using a DSS receiver.

- When recording programs via a DSS receiver the DSS receiver must be left on.
- When recording programs via an antenna or cable, the DSS receiver must be turned off.



- For a list of publications that carry the PlusCode numbers in your area, call 1 - 800 - 258 - 4827.
- You can obtain unlisted PlusCode numbers by calling 1 - 900 - 454 - 7587. Call costs approximately \$.95 per minute.
- VCR PlusCodes can not be used to program the VCR to record DSS channels.
- Avoid overlapping program times.
- An on-screen display will indicate if an invalid PlusCode number has been entered.
- An on-screen display will indicate when all timer programs are full.

More You Can Do



# Special VCR Features



## Check list before you begin.

- All connections are made. (See pages 6~9.)
- VCR is Plugged in.
- TV is turned on and set to the VCR channel (CH3 or CH4).

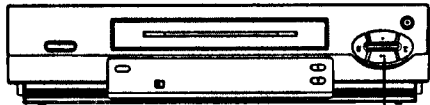

STOP/EJECT

## VCR Lock Feature

When activated, this feature prohibits all operations except for timer recording, and tape eject. This is useful to prevent misoperation and protect your VCR from curious children.



Hold down STOP/EJECT on the VCR for 7 seconds during Stop, or Power OFF mode.

VCR LOCK ACTIVATED

### To Cancel the VCR Lock feature,



Hold down STOP/EJECT on the VCR for 7 seconds again during Stop, or Power OFF mode.

VCR LOCK OFF

- VCR Lock mode is cancelled automatically after 24 hours when the clock is set.

## Warning Beeper Feature

When you select BEEPER ON as described below, a short warning will sound each time an invalid entry or operation is made and a timer program is set.

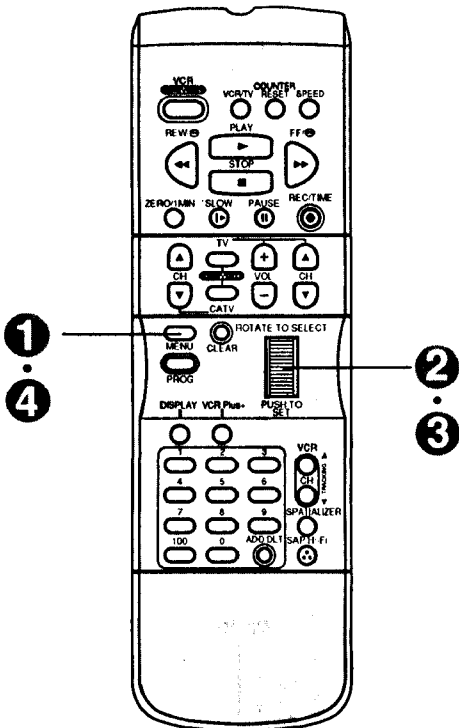

1



Push MENU to display the menu.

2



Rotate and push the WHEEL to select "SET UP VCR".

3



Rotate the WHEEL to select "BEEPER", then push to select "ON" or "OFF."

4



Push MENU twice to exit this screen.

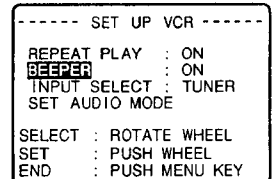
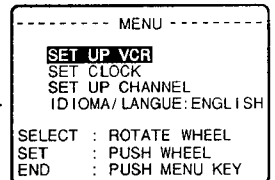

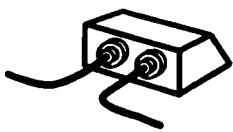

# Multi-Brand Control Feature

The Remote Control may be set up to control some of the functions on your TV or Cable Box.

## TV Brand Code Numbers

Panasonic	01, 02
Quasar	01, 02
RCA	03
GE	03
Zenith	04
Magnavox	05
Sylvania	05
Sharp	06, 07
Sony	08
Toshiba	09
Sanyo	10
Fisher	10
JVC	11
Hitachi	12
Mitsubishi	13
Samsung	14
Gold Star	15, 16, 17

## Cable Box Brand Code Numbers

Archer	01, 29, 44, 88, 91
Cableview	4, 30, 42, 44, 52, 63, 85, 88
Citizen	4, 30, 42, 44, 52, 63, 85, 88
Curtis	08, 09, 56, 61, 87, 90
Diamond	01, 29, 44, 88, 91
Drake	37
Eagle	13, 20, 22, 26, 40, 58, 62, 98
Eastern	28
GC Brand	4, 30, 42, 44, 52, 63, 85, 88
Gemini	04, 85
General Electric	57
General Instruments	01, 02, 03, 04, 34, 55, 83, 85, 91, 93, 95
Hamlin	14, 15, 28, 41, 97
Hitachi	31, 79
Jerrold	01, 02, 03, 04, 34, 55, 83, 85, 91, 93, 95
Macom	31, 79
Magnavox	25, 26
Matsushita	16, 17
Movietime	32, 38, 40
Movietime	29, 32, 39, 42, 44, 88
NSC	32, 38, 40
Oak	46
Panasonic	16, 17
Philips	13, 20, 23, 24, 96
Pioneer	05, 06, 78
Pulser	4, 30, 42, 44, 52, 63, 85, 88
RCA	16, 17
Realistic	44, 88
Regal	14, 41
Regency	28
Rembrandt	29, 32, 39, 42, 44, 88
Samsung	32, 40, 42, 78, 94
Scientific Atlanta	08, 09, 56, 61, 87, 90
Sheritech	27
SL Marx	32, 40, 42, 78, 94
Sprucer	16, 17
Stargate	32, 40, 42, 78, 94
Stargate	4, 30, 42, 44, 52, 63, 85, 88
Sylvania	19
Telecaption	77, 92
Televue	32, 40, 42, 78, 94
Texscan	18, 19
Tocom	01, 33, 34, 42, 48, 49, 91
Toshiba	36
Unika	01, 29, 44, 88, 91
Universal	42, 43, 44, 52, 63, 88
Viewstar	13, 20, 22, 26, 40, 58, 62, 98
Videoway	07, 23, 50
Zenith	07, 23, 50

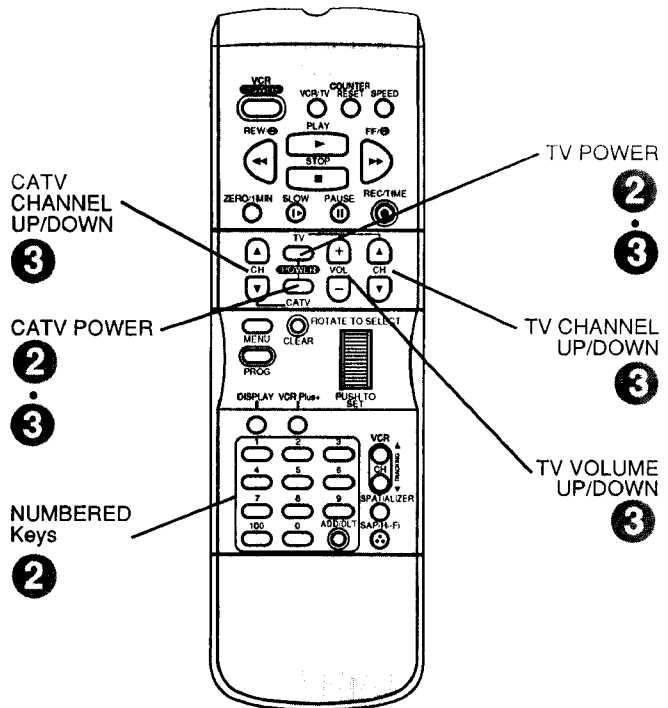

### 1 Find your TV or Cable Box Brand Code Numbers.

- See left chart for TV or Cable Box Brand Code Numbers.

### 2 Hold Down TV POWER or CATV POWER.

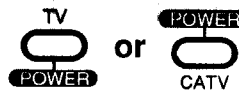

and

Use the **NUMBERED** keys to enter code number.

- Enter your TV or Cable Box brand code number.
- Due to changes in infra-red commands used by some manufacturers, some TV or Cable Box brands are listed more than once. If your TV or Cable Box does not respond in step 3 with the first code, please try entering the next code.

### 3 Try each of the following functions.

- Some TV and Cable Box brands require you to turn on the power manually.

(TV)	(Cable Box)
POWER ON/OFF	POWER ON/OFF
CHANNEL UP/DOWN	CHANNEL UP/DOWN
VOLUME UP/DOWN	

- Depending on your TV or Cable Box model, not all functions listed may be controlled by this remote.



- Please repeat the TV/ Cable Box Set Up procedure when you replace the remote's batteries.
- The remote control is designed to control the brands listed. However, it will not operate all TVs or Cable Boxes made by these manufacturers. If you get no results, your particular product brand cannot be controlled by this remote.

More You Can Do



# Before Requesting Service

Check the following points once again if you are having some trouble with your VCR.

Power	Correction
No power...	<ul style="list-style-type: none"><li>• Check that the Power Plug is completely inserted to an AC outlet.</li><li>• Check that the POWER button is set to on.</li></ul>
Recording & Playback	Correction
TV program can't be recorded...	<ul style="list-style-type: none"><li>• Check the connections between the VCR, the external antenna, and your TV.</li><li>• Check that the band selected matches your antenna or cable TV system. (P.15)</li><li>• Make sure that the record tab on the back of the cassette is still intact. (P.5)</li></ul>
Timer recording can't be performed...	<ul style="list-style-type: none"><li>• Set the recording start/stop times correctly. (P.20)</li><li>• Make sure that the POWER button is set to off. (P.20)</li><li>• Timer recording may not be performed or continued if a power interruption of more than 1 minute occurs before, or during, Timer Recording, even if power resumes thereafter.</li></ul>
There is no playback picture, or the playback picture is noisy or contains streaks..	<ul style="list-style-type: none"><li>• Select the same channel on your TV as that of the Channel 3/4 switch located on the rear panel of the VCR. (P.6)</li><li>• Set the VCR/TV selector to "VCR". (P.17)</li><li>• Check that channel 3 or 4 of the TV is properly adjusted.</li><li>• Adjust the TRACKING control slowly in either direction. (P.17)</li></ul>
During special effects playback, the picture may contain some vertical jitter when using a TV which has an Automatic Vertical Hold Control...	<ul style="list-style-type: none"><li>• Set the TV's Vertical Hold Control to "MANUAL" and then adjust it.</li></ul>
If the top of your playback picture waves back and forth excessively...	<ul style="list-style-type: none"><li>• Because the VCR playback signal is not as stable as an off-the-air TV signal, the top of your TV screen may be bent or unstable during playback. To solve this problem, slowly turn the horizontal hold control on your TV to correct the wavy picture. If your TV does not have a horizontal hold control or adjusting the control does not help, please contact your local TV service center.</li></ul>
VCR can't be controlled...	<ul style="list-style-type: none"><li>• Make sure that VCR LOCK is set to off. (P. 28)</li></ul>
Remote Control	Correction
VCR can't be remote controlled...	<ul style="list-style-type: none"><li>• Aim the Remote Control directly at the remote sensor on the VCR. (Refer to Back Cover.)</li><li>• Avoid all obstacles which may interfere with the signal path.</li><li>• Inspect or replace the batteries (P.4).</li><li>• Make sure that VCR LOCK is set to off. (P. 28)</li><li>• Exposing the VCR remote sensor to direct fluorescent or outdoor light may cause signal interference.</li></ul>
Miscellaneous	Correction
You can't view programs normally on TV...	<ul style="list-style-type: none"><li>• Set the VCR/TV selector to "TV". (P.19)</li></ul>
Video cassette can't be inserted...	<ul style="list-style-type: none"><li>• Insert the cassette with the window side up and the record tab facing you.</li></ul>
Video cassette can't be removed...	<ul style="list-style-type: none"><li>• Check that the power plug is completely connected to an AC outlet.</li></ul>
<i>Video cassette ejects when the REC and PLAY buttons are pushed or when the POWER button is pushed off to set the Timer...</i>	<ul style="list-style-type: none"><li>• <i>Make sure the record tab on the back of the cassette is still intact.</i> (P.5)</li></ul>
In the stop mode, the motor (CYLINDER) continues to rotate...	<ul style="list-style-type: none"><li>• To enable the quick play mechanism, the cylinder will rotate for about 5 minutes.</li><li>• The quick play mechanism reduces response time from stop to PLAY mode from PLAY to REWIND search mode.</li></ul>
VCR can't be controlled...	<ul style="list-style-type: none"><li>• Make sure that VCR LOCK is set to off. (P. 28)</li></ul>

# Spanish Quick Use Guide/Guía para rápida consulta

## Fijación del Idioma de la pantalla, fijaciones para la conexión con la caja de TV por cable y receptor DSS, memorizar los canales y fijación automática de la hora.

**1**  Encienda el televisor y la videograbadora.

**2** El televisor debe estar fijado al mismo canal que ha seleccionado en la parte trasera de la videograbadora (canal 3 o 4).

**3**  Oprimir VCR CH ▲ para elegir el idioma de la pantalla en inglés.

 Oprimir VCR CH ▼ para elegir el idioma de la pantalla en español.

 Oprimir VCR/TV para elegir el idioma de la pantalla en francés.

SELECT LANGUAGE  
 PUSH VCR CH ▲: ENGLISH  
 PULSE VCR CH ▼: ESPAÑOL  
 APP. VCR/TV : FRANÇAIS

Esta pantalla aparecerá en unos segundos. →

ESTA USANDO UNA CAJA DE TV POR CABLE O UN RECEPTOR DSS?  
 PULSE MENU : SI  
 PULSE PROG. : NO

**4**  Oprimir MENU para elegir "SI" o PROG para "NO."

 **• Si ha elegido "SI", continúe al paso siguiente. Si ha elegido NO, siga las instrucciones alternativas de la página 32.**

**5**  Girar y oprimir la RUEDA para elegir la conexión de su equipo.

**• Si es "CABLE/DSS-VCR-TV", continúe pase al paso 8. Si ha elegido NO, siga las instrucciones alternativas de la página 32.**

-FIJAR TV POR CABLE/DSS-  
 ELEGIR E INTRODUCIR UN CÓDIGO DE NÚMERO LISTADO EN SU MANUAL DE INSTRUCC.  
**01**  
 ELEGIR : GIRE LA RUEDA  
 FIJAR : PULSE LA RUEDA  
 TERMINAR : PULSE MENU

**6**  Girar y oprimir la RUEDA para fijar el canal de salida de la caja de TV por cable o el receptor DSS (el canal sintonizado en el televisor para ver la emisión de la caja de TV por cable o receptor DSS).

**• Si está usando los dos, fije el canal de salida del receptor DSS.**

**• Si ud. está usando los terminales de audio/video, elija y fije a "SALIDA DE VIDEO" para el canal de salida.**

-FIJAR TV POR CABLE/DSS-  
 INTRODUCIR EL CANAL DE SALIDA DE SU CAJA DE TV POR CABLE O RECEPTOR DSS  
**01**  
 ELEGIR : GIRE LA RUEDA  
 FIJAR : PULSE LA RUEDA  
 TERMINAR : PULSE MENU

**7**  Girar y oprimir la rueda para elegir SI o NO.

**• Si ha elegido "SI", continúe al paso siguiente. Si ha elegido NO, siga las instrucciones alternativas de la página 32.**

-FIJAR TV POR CABLE/DSS-  
 TIENE UN CONTROL REMOTO SU CAJA DE TV POR CABLE O SU RECEPTOR DSS?  
**SI**  
**NO**  
 ELEGIR : GIRE LA RUEDA  
 FIJAR : PULSE LA RUEDA  
 TERMINAR : PULSE MENU

**8**  Girar y oprimir la rueda para fijar el número de código de la caja de TV por cable o receptor DSS que coincide con su marca desde la lista de la página 11.

**• Este determinará si la videograbadora controlará la caja de TV por cable o el receptor DSS.**

-FIJAR TV POR CABLE/DSS-  
 ELEGIR E INTRODUCIR UN CÓDIGO DE NÚMERO LISTADO EN SU MANUAL DE INSTRUCC.  
**01**  
 ELEGIR : GIRE LA RUEDA  
 FIJAR : PULSE LA RUEDA  
 TERMINAR : PULSE MENU

**9** Si ud. usa una caja de TV por cable, sintonice al canal 2. Si usa un receptor DSS, sintonice a cualquier canal fuera de 200.

 Oprimir la rueda para continuar.

Caja de TV  
 -FIJAR TV POR CABLE/DSS-  
 POR FAVOR SINTONICE SU CAJA DE TV POR CABLE AL CANAL 02.  
 Receptor DSS  
 F T -FIJAR TV POR CABLE/DSS-  
 POR FAVOR SINTONICE SU RECEPTOR DSS AL CANAL270  
 PROCEDER : PULSE LA RUEDA  
 TERMINAR : PULSE MENU

**10**  Girar y oprimir la rueda para elegir SI o NO.

Caja de TV  
 -FIJAR TV POR CABLE/DSS-  
 ESTA RECEBIENDO SU CAJA DE TV POR CABLE EL CANAL 09 ?  
**SI**  
**NO**  
 Receptor DSS  
 F T  
 ESTA RECEBIENDO SU RECEPTOR DSS EL CA. 200?  
**SI**  
**NO**  
 ELEGIR : GIRE LA RUEDA  
 FIJAR : PULSE LA RUEDA  
 TERMINAR : PULSE MENU

Si ud. usa una caja de TV por cable y ha elegido SI, siga al paso 11.  
 Si ud. usa un receptor DSS y ha elegido SI, siga las instrucciones alternativas de la página 32.  
 Si ha elegido NO, aparecerá de nuevo la pantalla del paso 8. Intente fijar un código diferente para su marca y/o cambie la *conexión de su equipo*.  
 Si su respuesta es todavía NO, el control de la caja de TV por cable o el receptor DSS no es disponible. Oprimir MENU y pase a las instrucciones alternativas de la página 32.

# Spanish Quick Use Guide/Guía para rápida consulta

11



Girar y oprimir la rueda para elegir y fijar el canal PBS de su local que está recibiendo en su caja de TV por cable.

- Si ud. vive cerca de una zona con diferente hora, fije el canal de su zona.



12



Verifique que su caja de TV por cable esté encendido y su receptor DSS esté apagado.

Oprimir la RUEDA para iniciar la fijación automática de los canales.

- Las siguientes informaciones aparecerán seguidamente: "AUTOPROGRAMACION EN PROCESO" "AUTOPROGRAMACION COMPLETO" "FIJACION AUTOMATICA DEL RELOJ EN PROCESO"

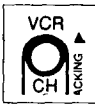

Esta pantalla aparece cuando la fijación automática del reloj es incompleto. Comprobar si la hora está fijada correctamente y luego oprimir CH ▲ para terminar la fijación.

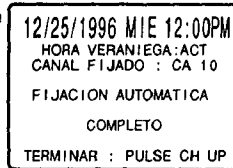

## Instrucciones alternativas

Complete los siguientes pasos si ha efectuado una de las siguientes explicaciones durante su fijación.

- Ud. ha elegido NO en el paso 4 de la página 31 (ud. no está usando una caja de TV por cable o un receptor DSS).
- Ud. ha elegido la segunda conexión (VCR-CABLE/DSS-TV) en el paso 5 de la página 31.
- Ud. ha elegido NO en el paso 7 de la página 31 (su caja de TV por cable o receptor DSS no tiene un control remoto).
- Ud. está usando un receptor DSS y ha elegido SI en el paso 10 de la página 31.
- No se puede controlar la caja de TV por cable o receptor DSS en el paso 10 de la página 31.

1

Encienda la caja de TV por cable y fije la caja de TV por cable al canal PBS de su zona.

- Si ud. vive cerca de una zona con diferente hora, asegúrese de fijar el canal de su zona.
- Si ud. usa un receptor DSS, éste debe estar apagado.

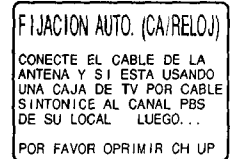

2

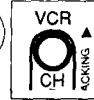

Oprimir CH ▲ para iniciar la fijación automática de los canales.

- Las siguientes informaciones aparecerán seguidamente: "AUTOPROGRAMACION EN PROCESO" "AUTOPROGRAMACION COMPLETO" "FIJACION AUTOMATICA DEL RELOJ EN PROCESO"

Esta pantalla aparece para informarle que la fijación automática de la hora es incompleto.

3

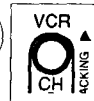

Comprobar si la hora está fijada correctamente y luego oprimir CH ▲ para terminar la fijación.

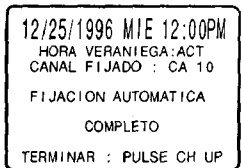

Si aparece esta pantalla, la fijación automática no es disponible en su zona. Por favor fije la hora manualmente como describe al siguiente.

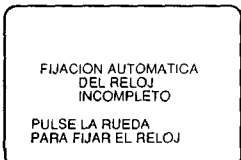

### Si la hora fijada automáticamente es incorrecto

Si ud. usa una caja de TV por cable y recibe emisiones de más de un canal PBS, ud. debe salir desde la pantalla de la fijación del reloj manual e intente fijar automáticamente otravez.

Siga los pasos de la fijación o anulación de la hora y cuando las instrucciones de la pantalla requiere la fijación del canal PBS, fije un canal que no ha intentado anteriormente.

### Si aparece en la pantalla FIJACION DEL RELOJ INCOMPLETO

La pantalla a la derecha aparecerá si no es disponible en zona la fijación automática de la hora.

Oprimir MENU para ver la pantalla de la fijación manual del reloj. (Consulte la "Fijacion Manual del reloj" en la página 33).

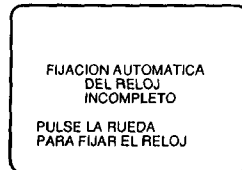

#### Notas:

Si ud. usa una caja de TV por cable y recibe emisiones de más de un canal PBS, ud. debe salir desde la pantalla de la fijación del reloj manual e intente fijar automáticamente otravez.

Siga los pasos de la fijación o anulación de la hora y cuando las instrucciones de la pantalla requiere la fijación del canal PBS, fije un canal que no ha intentado anteriormente.

- La fijación automática de la hora se efectuará cada día al apagar la videograbadora por primera vez. Si ud. usa una caja de TV por cable y desea efectuar la fijación automática de la hora, la caja de TV por cable debe permanecer encendido cuando la videograbadora se apaga.



## Si la hora y la hora veraniega es incorrecta, por favor siga los siguientes pasos:

Raras veces, en caso de que ud. vive cerca de dos zonas con hora diferente, el aparato puede elegir un canal PBS con diferente hora de su zona. En este caso, haga los siguientes pasos:

- 1 Tome nota del canal que está fijado en la pantalla y salga desde este modo oprimiendo el botón CH ▲.
- 2 Anule este canal desde los canales memorizados en la combinación de VCR/TV.
- 3 Oprima el botón MENU para que aparezca la pantalla del MENU.
- 4 Use la rueda para elegir "FIJAR RELOJ" y luego para elegir "AUTO MATICO."
  - Si ud. esta usando una caja de TV por cable y tiene muchos canales PBS, sintonize la caja de TV por cable a un canal PBS diferente e intente la fijación automática otravez.

## Fijación manual del reloj

- 1 Oprimir MENU para que aparezca la pantalla de la fijación del reloj.
- 2 Girar y oprimir la RUEDA para elegir y fijar el mes, la fecha, el año, la hora y la hora veraniega.

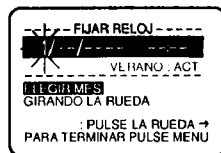

### Para hacer correcciones

Oprimir la rueda o el botón CLEAR repetidamente para retroceder o avanzar hasta el paso que desea corregir.

- 3 Oprimir MENU dos veces para iniciar a funcionar el reloj y salir desde este modo.

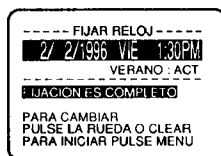

## Fijación o cambio de la hora

En caso de que el reloj está incorrecto o ha ocurrido un corte eléctrico.

- 1 Oprimir MENU para que aparezca la pantalla del menú.
- 2 Girar y oprimir la RUEDA para elegir la pantalla de la fijación del reloj y luego fijar la hora y la fecha.
- 3 Oprimir MENU dos veces para iniciar a funcionar el reloj y salir desde este modo.

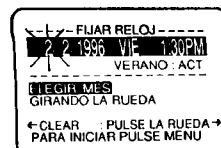
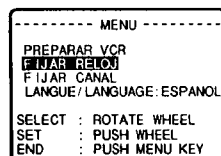

## Operaciones básicas para la reproducción

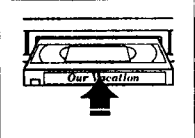
- 1  Introducir una cinta
  - La videograbadora se enciende automáticamente.

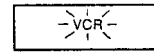

Esta indicación aparece en la pantalla multifuncional.

- 2  Oprimir PLAY para comenzar a reproducir.
  - Si la cinta no tiene la lengüeta para evitar borrado la videograbadora comienza a reproducir automáticamente.

(Videograbadora o Control Remoto)

- 3   Oprimir REW o FF para localizar rápidamente una escena.

(Videograbadora o Control Remoto)

- La velocidad de búsqueda en el modo SP es a 9 veces más rápida que la velocidad normal y en el modo SLP es a 27 veces más rápida.
- Durante la búsqueda aparece alguna barras de ruido.

- 4  Oprimir STOP para parar la reproducción.

(Videograbadora o Control Remoto)

- 5  Oprimir STOP/EJECT para expulsar la cinta.

- Este botón se encuentra solamente en la videograbadora.

## Operaciones básicas para la grabación

**1** Introducir una cinta con la lengüeta.

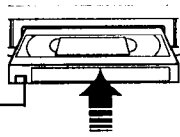

- La videograbadora se enciende automáticamente.

**2** Oprimir VCR CH ▲/▼ para elegir el canal.

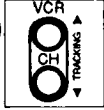

Oprimir VCR CH ▲/▼ para elegir el canal.

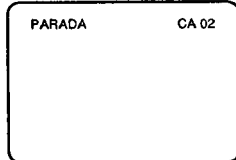

- U oprimir CH ▲/▼ en la videograbadora.
- Para grabar desde una fuente externa, oprimir VCR CH ▲/▼ para elegir "LINEA"

**3** Oprimir SPEED para cambiar la velocidad de la cinta.



Oprimir SPEED para cambiar la velocidad de la cinta.

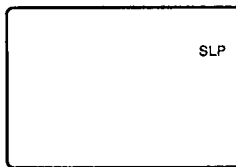

- SP = Reproducción estándar,
- LP = Larga duración,
- SLP = Superlarga duración.

**4** Oprimir REC/TIME con el control remoto para empezar a grabar.



Oprimir REC/TIME con el control remoto para empezar a grabar.

- U oprimir PLAY y REC/TIME en la videograbadora.

### Grabación de un toque (OTR)

La videograbadora termina la grabación a una hora programada.

Oprima sucesivamente REC/TIME para fijar el tiempo de la grabación.

Cada presión cambiará la hora de parada como demuestra al siguiente.

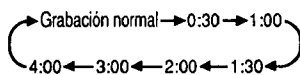

- La indicación TIMER aparece en la pantalla multifuncional.

**5** Oprimir STOP para parar la grabación.

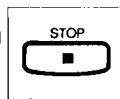

Oprimir STOP para parar la grabación.

- U oprimir STOP en la videograbadora.

- Si mantiene oprimiendo el botón de VCR CH ▲/▼ aumentará la velocidad del cambio del canal.
- Oprimir PAUSE para hacer una pausa en la grabación en progreso.

## Programación fácil para la grabación con temporizador

**1** Oprimir PROG para que aparezca la pantalla de la programación.



Oprimir PROG para que aparezca la pantalla de la programación.

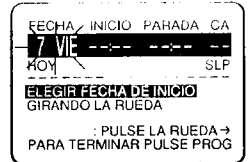

- Si ya existe una programación, elija usando la rueda un número sin programación.

**2** Girar y oprimir la RUEDA para elegir y fijar la fecha.

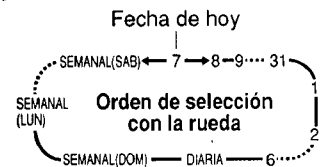
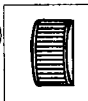

### Grabación diaria y semanal

Si ud. desea programar una grabación diaria (lunes a viernes), elija DIARIO en vez de la fecha en el paso 2. Si desea una grabación semanal, elija SEMANAL LUN, MAR, etc.

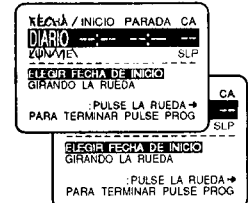

**3** Girar y oprimir la RUEDA para elegir y fijar las fijaciones que sobran.

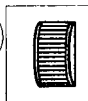

Girar y oprimir la RUEDA para elegir y fijar las fijaciones que sobran.

#### Fijaciones:

- Hora de inicio
- Hora de parada
- Canal o LINEA para una fuente externa.
- Velocidad de la cinta (SP, LP, SLP).

### Para hacer correcciones

Oprimir la rueda sucesivamente para avanzar u oprimir CLEAR para retroceder hasta el paso que desea corregir.

**4** Oprimir PROG para terminar la programación.



Oprimir PROG para terminar la programación.



- Si desea hacer más programaciones, elija un número de programa en blanco con la rueda y repita los paso 2 y 3.

**5** Oprimir PROG para salir desde este modo.



Oprimir PROG para salir desde este modo.

**6** Oprimir POWER y apague el aparato para la grabación con temporizador.



Oprimir POWER y apague el aparato para la grabación con temporizador.

Pantalla multifuncional



- Si la fuente de la grabación es una caja de TV por cable, asegúrese de que la caja de TV por cable esté encendido y esté sintonizado al canal que desea grabar.

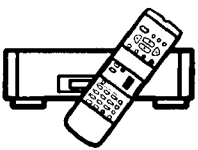

# Index of Controls

## Multi Function Display

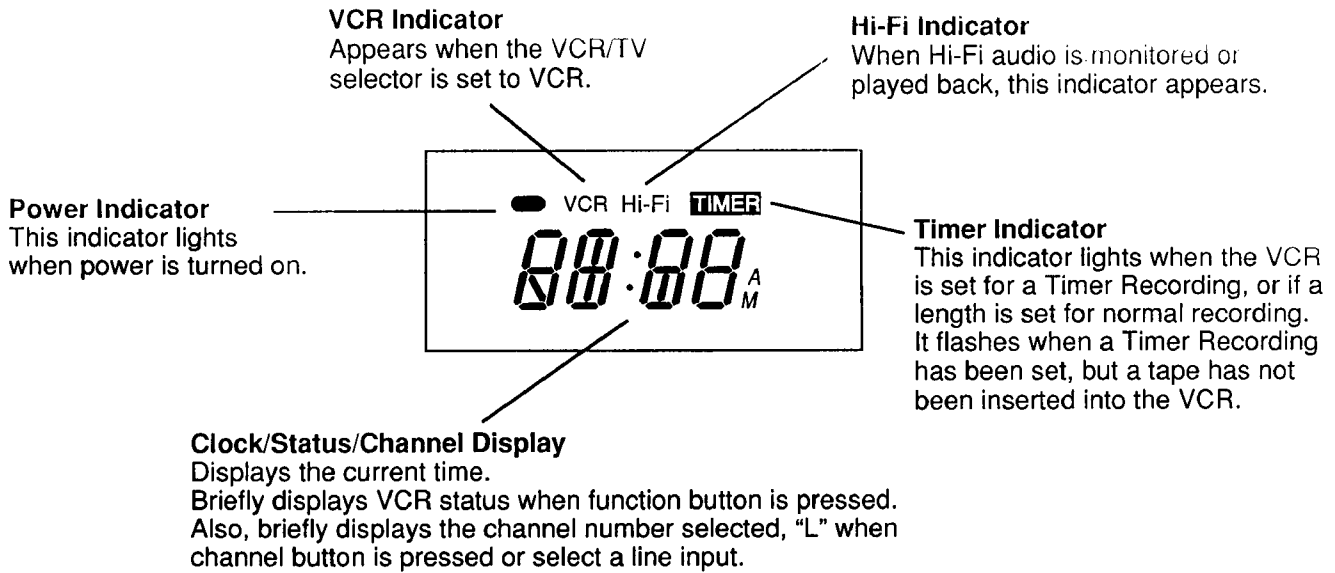

## Rear View of the VCR

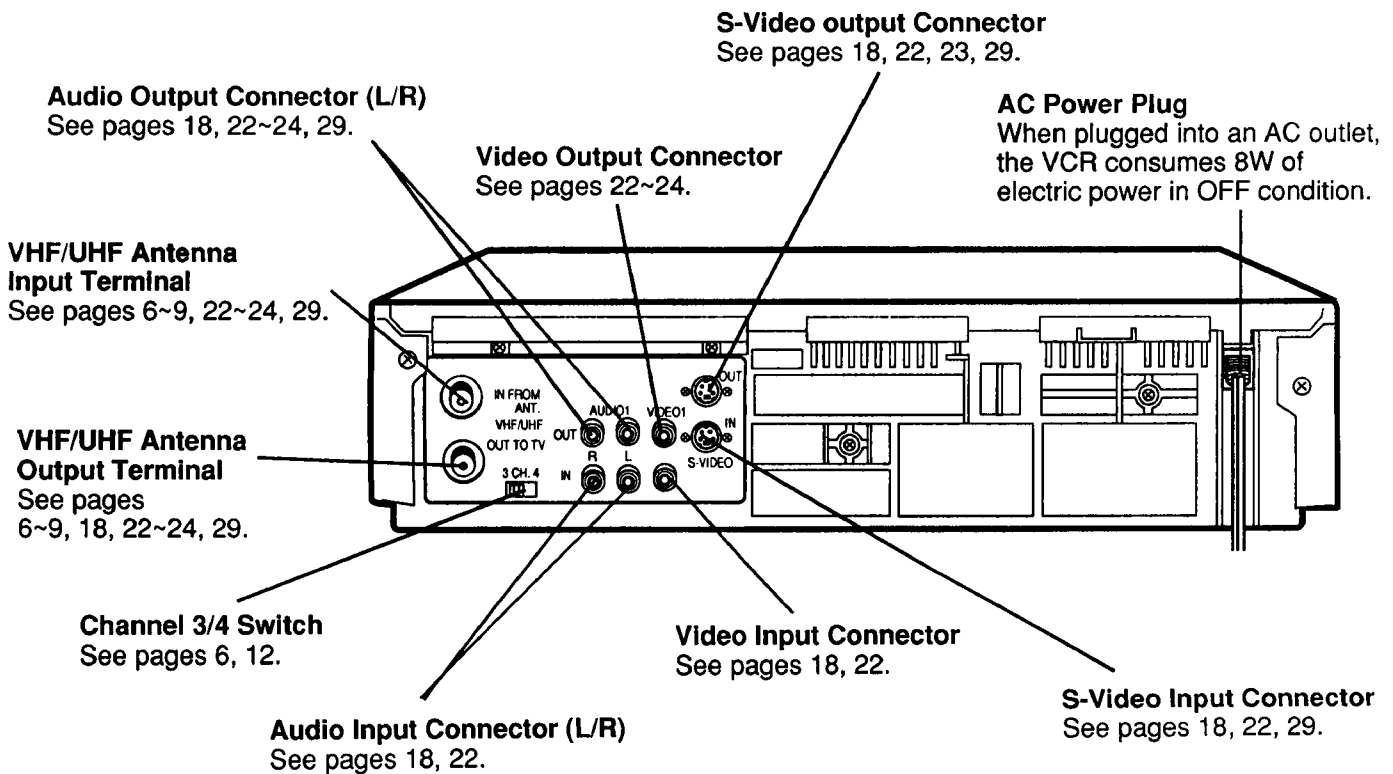

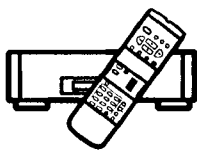

# Index of Controls

## Remote Control Button

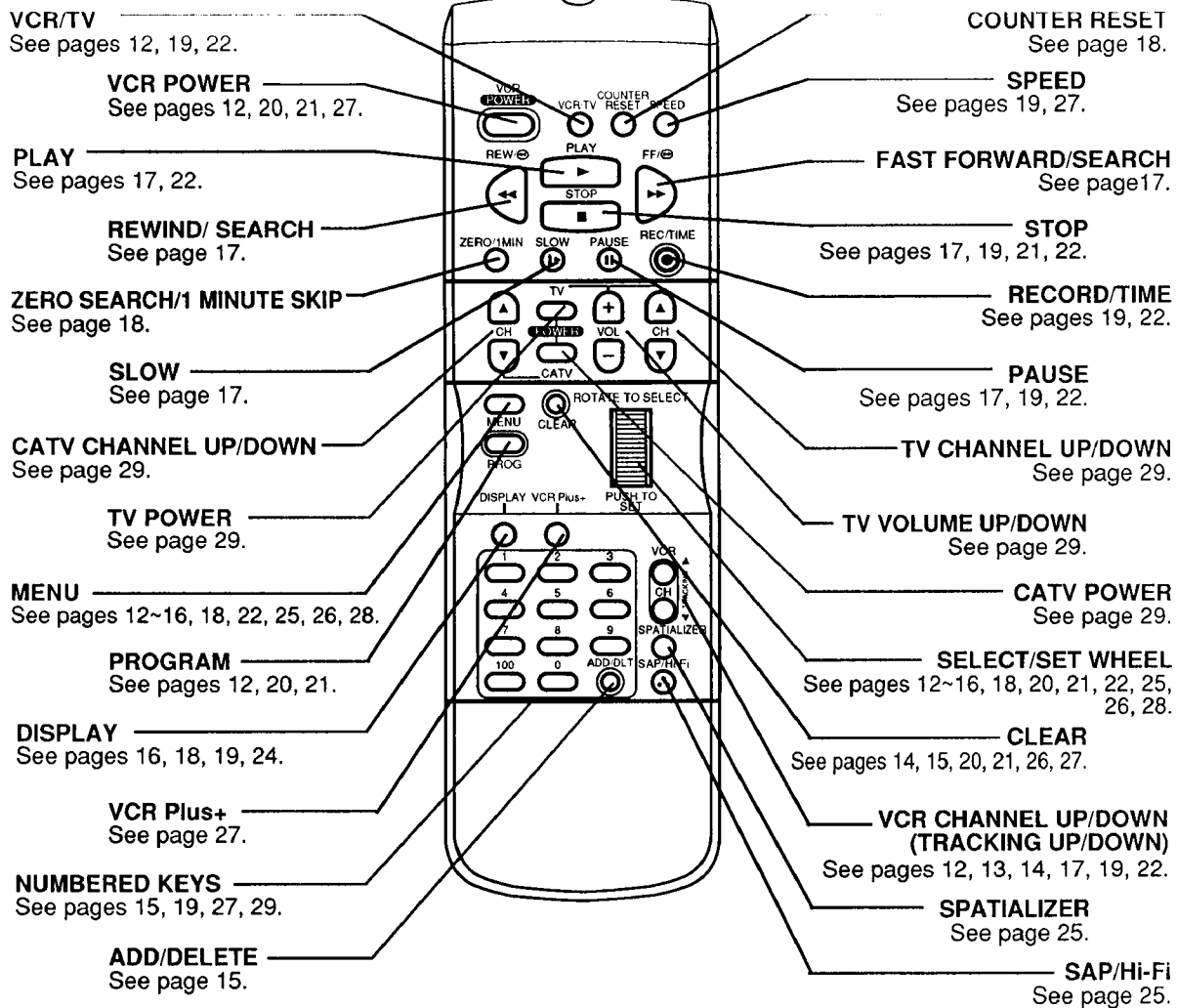

## Front View of the VCR

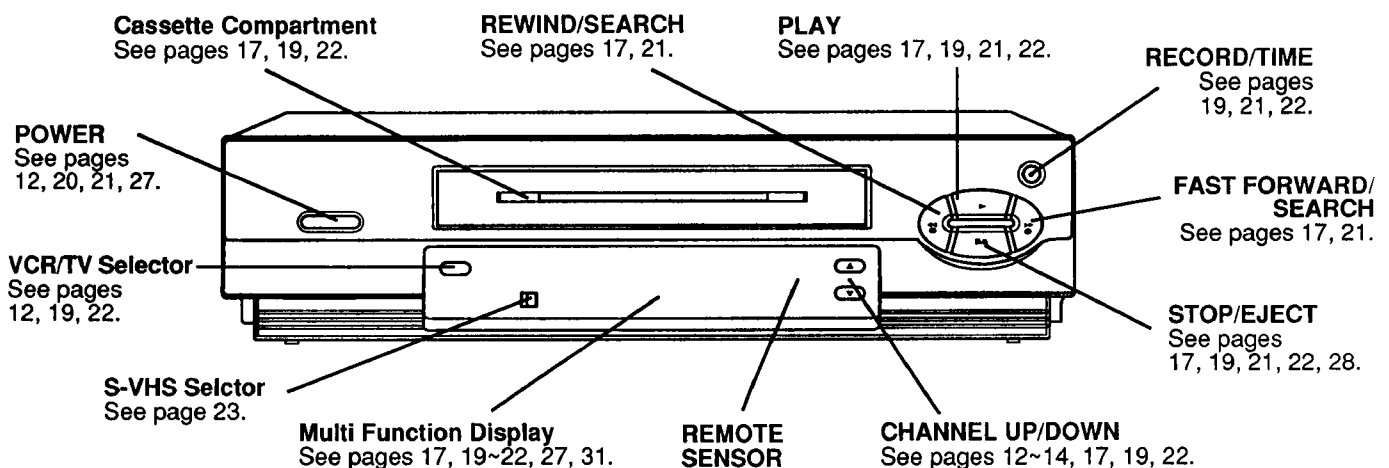

Matsushita Consumer Electronics Company, Division of Matsushita Electric Corporation of America  
One Panasonic Way Secaucus, New Jersey 07094

Panasonic Sales Company, Division of Matsushita Electric of Puerto Rico, Inc. ("PSC")  
Ave. 65 de Infanteria. Km. 9.5  
San Gabriel Industrial Park, Carolina, Puerto Rico 00985

Printed in Japan  
VQTS3214 (A)



# Quick Use Guide

After you have hooked your antenna or cable system up to the VCR and TV, this convenient guide will assist you with some of the basic operations of the VCR. If you need further information, please read the manual.

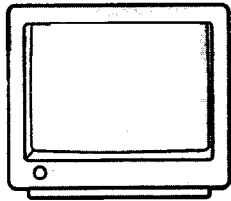

TV and VCR are plugged in and turned on.

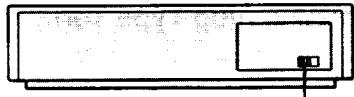

(Rear View of the VCR) 3 CH. 4

Tune your TV to the VCR channel (3 or 4) to see the picture from the VCR.

The VCR channel is changed with the 3/4 switch located on the back of the VCR.

- If you used the audio/ video jacks to connect the TV and VCR, switch your TV to LINE or VIDEO.

## Playback a Tape

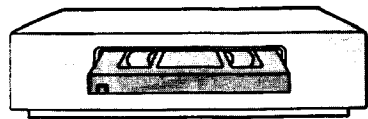

- 1 Insert a cassette.



POWER

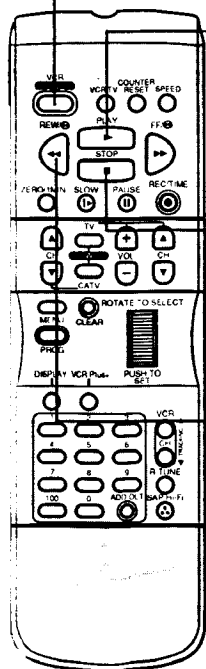

- 2 Push PLAY to start playback.
- 3 Push STOP to stop playback.
- 4 Push REWIND to rewind the tape.

## Record on a Tape

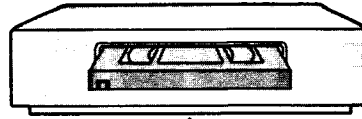

- 1 Insert cassette with record tab.



POWER

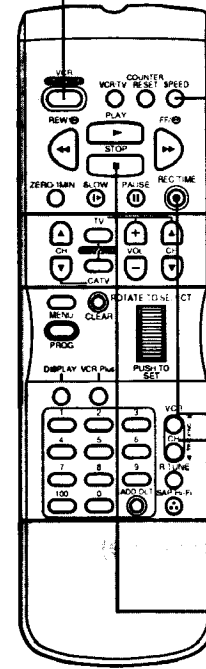

- 2 Push CH ▲ / ▼ to select channel.
- 3 Push SPEED to select tape speed.
- 4 Push RECORD/TIME to start recording.
- 5 Push STOP to stop recording.

## VCR/TV Mode Selection

Watch TV stations or the VCR picture through the VCR.

Push the TV/VCR button to change from TV to VCR mode.

VCR mode is automatically selected whenever the VCR power is turned on.

Watch TV only.

Push the TV/VCR button on the remote control so that VCR does not appear in the multi-function display. Or, simply turn off the VCR power. Now, use the TV channel buttons to change TV channels.

NOTE: The remote control pictured in this Quick Use Guide is an example only. Your remote control may be slightly different.



# Basic Connection

## Between Antenna and VCR

Disconnect the antenna or cable from your TV and connect it to the VCR (IN FROM ANT.)

### Case 1: Twin Lead Cable Only

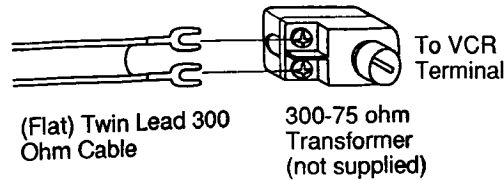

### Case 2: Twin Lead & Coaxial Cables

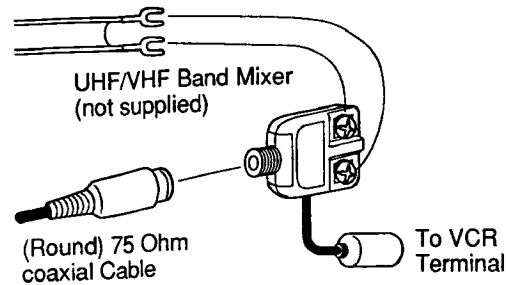

### Case 3: Two Twin Lead Cables

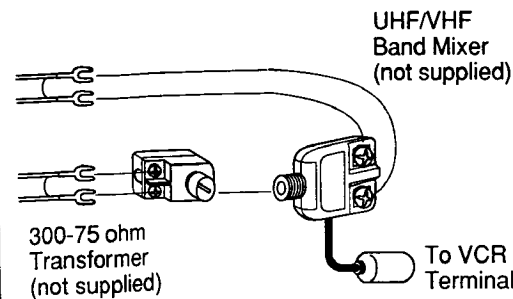

• If your TV has both post and screw-type VHF terminals, using the post connection is recommended to minimize signal loss.

## ANTENNA

INDOOR ANTENNA  
Antena interior

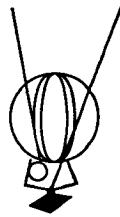

or

OUTDOOR ANTENNA  
Antena exterior

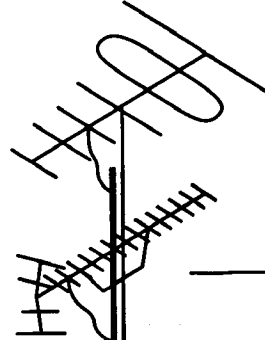

or

Cable TV  
TV por cable

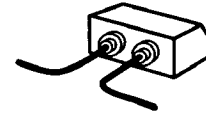

Antenna Cable

VCR

TV

RF Coaxial Cable  
(VCR-TV Connector Cable)  
(supplied)

## Between VCR and TV

Connect the VCR to your TV with the RF Coaxial Cable (OUT TO TV).

### Case 1: Screw & Plug Type Terminal

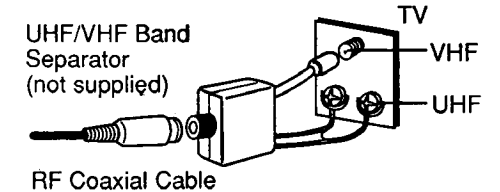

### Case 2: Screw Type Terminal

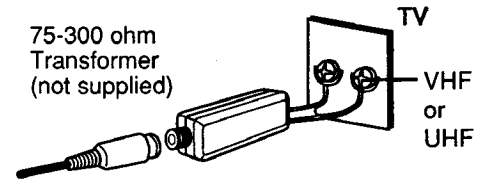

### Case 3: Double Screw Type Terminal

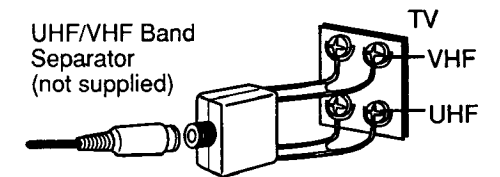

### Case 4: Complex TV Terminal

TERMINALS ON BACK OF TV SET

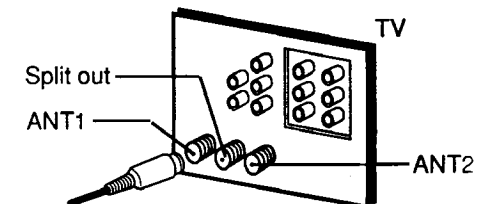

• Connect to one of the ANT terminals and select the same channel number at the TV.

• Additional connection methods may be found in the operating instructions.

Customer Service Center 2F-3, One Panasonic Way, Secaucus, NJ 07094 (Headquarters)  
201-348-9090 (9:00am-8:00pm Monday-Friday, EST)

**AUTHORIZED SERVICENTERS • PARTS DISTRIBUTOR LOCATIONS**

To locate an independent authorized servicer or parts distributor in your area, within the USA dial toll free 1-800-545-2672, 24 hours a day, 7 days a week.

**PRODUCT REPAIRS**

**Factory Servicers**

**CALIFORNIA**

6550 Katella Avenue  
Cypress, CA 90630  
Phone (714) 373-7425  
Fax (714) 894-8534  
  
800 Dubuque Avenue  
S. San Francisco, CA 94080  
Phone (415) 871-6373  
Fax (415) 871-6840  
  
20201 Sherman Way  
Suite 102  
Canoga Park, CA 91306  
Phone (818) 709-1775  
Fax (818) 709-2165  
  
3878 Ruffin Road  
Suite A  
San Diego, CA 92123  
Phone (619) 560-9200  
Fax (619) 560-1831

**COLORADO**

1640 South Abilene Suite D  
Aurora, CO 80012  
Phone (303) 752-2024  
Fax (303) 752-0610

**FLORIDA**

3700 North 29th Avenue  
Suite 102  
Hollywood, FL 33020  
Phone (305) 925-2680  
Fax (305) 925-5224  
  
4710 Eisenhower Boulevard  
Suite A1  
Tampa, FL 33634  
Phone (813) 884-4746  
Fax (813) 886-4564

**GEORGIA**

8655 Roswell Road  
Suite 100  
Atlanta, GA 30350  
Phone (404) 518-6301  
Fax (404) 518-6306

**HAWAII**

99-859 Iwaiwa Street  
Aiea, Hawaii 96701  
Phone (808) 488-4369  
Fax (808) 486-4369

**ILLINOIS**

1703 North Randall Road \*  
Elgin, IL 60123  
\*12:30 to 4:30, Mon-Fri\*  
Phone (708) 468-5466  
Fax (708) 468-5465

9060 Golf Road  
Niles, IL 60714  
Phone (708) 299-1700  
Fax (708) 299-1710

**MARYLAND**

Sulphur Springs  
Business Park  
1638 Sulphur Springs Road  
Baltimore, MD 21227  
Phone (410) 242-2607  
Fax (410) 247-3047

**MASSACHUSETTS**

60 Glacier Drive, Suite G  
Westwood, MA 02090  
Phone (617) 329-4280  
Fax (617) 329-0586

\*pick-up/drop-off only

**MICHIGAN**

37048 Van Dyke Avenue  
Sterling Heights, MI 48312  
Phone (810) 939-2060  
Fax (810) 939-2638

**MINNESOTA**

7850-12th Avenue South  
Airport Business Center  
Bloomington, MN 55425  
Phone (612) 854-8624  
Fax (612) 854-2089

**MISSOURI**

11982 Dorsett Road  
Maryland Heights, MO 63043  
Phone (314) 739-5301  
Fax (314) 739-3631

**OHIO**

2236 Waycross Road  
Cincinnati, OH 45240  
Phone (513) 851-4180  
Fax (513) 851-8443

**PENNSYLVANIA**

2221 Cabot Boulevard West  
Suite B  
Langhorne, Pa 19047  
Phone (215) 741-0661  
Fax (215) 741-0521  
  
Campbell's Run  
Business Center  
500 Business Center Drive  
Pittsburgh, PA 15205  
Phone (412) 788-2174  
Fax (412) 788-2176

**TENNESSEE**

919-8th Avenue South  
Nashville, TN 37203  
Phone (615) 244-4434  
Fax (615) 244-6713

**TEXAS**

7482 Harwin Drive  
Houston, TX 77036  
Phone (713) 781-1528  
Fax (713) 781-0643  
  
13615 Welch Road  
Suite 101  
Farmers Branch, TX 75244  
Phone (214) 385-1975  
Fax (214) 960-7626

**WASHINGTON**

20425-84th Avenue South  
Kent, WA 98032  
Phone (206) 872-7922  
Fax (206) 872-0918

**Service in Puerto Rico**

**Matsushita Electric  
of Puerto Rico, Inc.  
Panasonic Sales Company/  
Factory Servicer**  
Ave. 65 de Infanteria, Km. 9.5  
San Gabriel Industrial Park  
Carolina, Puerto Rico 00985  
Phone (809) 750-4300  
Fax (809) 768-2910

**REPAIR INQUIRIES**

**Regional Customer Care Department**

**EAST (PCE)**

2221 Cabot Boulevard West  
Suite A  
Langhorne, PA 19047  
Phone (215) 741-0676  
Fax (215) 750-6492

Covers:  
CT, DE, ME, MD, MA, NH, NJ,  
NY, PA, RI, VT, VA, DC, WV

**EAST (PCE)**

1225 Northbrook Parkway  
Suite 2-390  
Suwanee, GA 30174  
Phone (404) 338-6860  
Fax (404) 338-6548

Covers:  
AL, FL, GA, MS, NC, SC, TN

**CENTRAL (PCC)**

1703 North Randall Road  
Elgin, IL 60123  
Phone (708) 468-5530  
Fax (708) 468-5528

Covers:  
AR, IL, IN, IA, KS, KY, LA, MI,  
MN, MO, NE, ND, OK, SD, TX,  
WI, OH

**WEST (PCW)**

6550 Katella Avenue  
Cypress, CA 90630  
Phone (714) 373-7440  
Fax (714) 373-7447

Covers:  
AK, AZ, CA, CO, ID, MT, NV,  
NM, OR, UT, WA, WY, HI

**ACCESSORY PURCHASES**

1-800-332-5368 (Consumer Orders Only)  
**Matsushita Services Company** Box 01, 545 Tollgate Road Suite C, Elgin, IL 60123  
(8:00am-7:30pm Monday-Thursday; 8:00am-5:00pm Friday; 9:00am-12:30pm Saturday; CST)  
(Visa, Mastercard, Discover card, Check or Money Order)

# Warranty

**Matsushita Consumer Electronics Company, Division of Matsushita Electric Corporation of America**  
One Panasonic Way Secaucus,  
New Jersey 07094

**Panasonic Sales Company, Division of Matsushita Electric of Puerto Rico, Inc. ("PSC")**  
Ave. 65 de Infanteria, Km. 9.5  
San Gabriel Industrial Park, Carolina,  
Puerto Rico 00985  
Tel. (809) 750-4300  
Fax. (809) 768-2910

## PANASONIC/QUASAR Video Equipment Limited Warranty

Matsushita Consumer Electronics Company or Panasonic Sales Company (collectively referred to as "The warrantor") will repair this product with new or refurbished parts, free of charge, in the U.S.A. or Puerto Rico from the date of original purchase in the event of a defect in materials or workmanship as follows:

**Parts (Except LCD; camera pick-up tube/CCD Image Sensor)**

New or rebuilt parts in exchange for defective parts for one (1) year from the date of original purchase.

**LCD (If included)**

New or rebuilt LCD Display in exchange for defective LCD display for one (1) year from the date of original purchase.

**Camera Pick-Up Tube/CCD Image Sensor (If included)**

New pick-up tube/CCD Image Sensor in exchange for defective pick-up tube/CCD Image Sensor for six (6) months from the date of original purchase.

**One Year Extended Warranty on Picture Tube (If Included)**

New or rebuilt picture tube in exchange for a defective picture tube during the second (2nd) year after original purchase. Purchaser pays for all labor charges for removal and installation of picture tube.

**Batteries (If included)**

New rechargeable batteries in exchange for defective rechargeable batteries for ten (10) days from the date of original purchase. Non-rechargeable batteries are not warranted.

**Tape (If included)**

New video cassette tape in exchange for a defective video cassette tape for five (5) days from the date of original purchase.

**Labor**

**Products that do not include a Picture Tube/LCD Display**

Carry-in or mail-in service for ninety (90) days from the date of original purchase. After the ninety (90) day labor warranty period is over, purchaser pays for all labor charges.

**Products that include a Picture Tube/LCD Display of 18" and below**

Carry-in or mail-in service for ninety (90) days from the date of original purchase. After the ninety (90) day labor warranty period is over, purchaser pays for all labor charges for removal and installation of parts and picture tube.

**Products that include a Picture Tube/LCD Display of 19" and above**

In-home or carry-in service for ninety (90) days from the date of original purchase. After the ninety (90) day labor warranty period is over, purchaser pays for all labor charges for removal and installation of parts and picture tube.

In-home, carry-in or mail-in service, as applicable, in the continental U.S.A. can be obtained during the warranty period by contacting a Matsushita Services Company (MSC) Factory Servicenter listed in the Servicenter Directory. Or call 800-545-2672, toll free, to locate an authorized MSC Servicenter. Carry-in or mail-in service in Puerto Rico can be obtained during the warranty period by calling the telephone numbers listed in the Servicenter Directory.

This warranty is extended only to the original purchaser. A purchase receipt or other proof of date of original purchase will be required before warranty service is rendered.

This warranty only covers failures due to defects in materials or workmanship which occur during normal use and does not cover normal maintenance, including, but not limited to, video and audio head cleaning. It does not cover damage which occurs during shipment or failures which are caused by products not supplied by the warrantor or failures which result from accident, misuse, abuse, neglect, mishandling, misapplication, alteration, faulty installation, set-up adjustments, improper antenna, inadequate signal pick-up, maladjustment of consumer controls, line power surge, modification or commercial use, such as hotel, office, restaurant, or other business or rental use of the product or service by anyone other than an MSC Factory Servicenter or authorized MSC Servicenter or damage that is attributable to acts of God.

**LIMITS AND EXCLUSIONS**

There are no express warranties except as listed above.

THE WARRANTOR SHALL NOT BE LIABLE FOR INCIDENTAL OR CONSEQUENTIAL DAMAGES (INCLUDING, WITHOUT LIMITATION, DAMAGE TO TAPES) RESULTING FROM THE USE OF THIS PRODUCT, OR ARISING OUT OF ANY BREACH OF THIS WARRANTY. ALL EXPRESS AND IMPLIED WARRANTIES, INCLUDING THE WARRANTIES OF MERCHANTABILITY AND FITNESS FOR A PARTICULAR PURPOSE, ARE LIMITED TO THE APPLICABLE WARRANTY PERIOD SET FORTH ABOVE. Some states do not allow the exclusion or limitation of incidental or consequential damages, or limitations on how long an implied warranty lasts, so the above exclusions or limitations may not apply to you.

This warranty gives you specific legal rights and you may also have other right which vary from state to state.

If a problem with this product develops during or after the warranty period, you may contact your dealer or Servicenter. If the problem is not handled to your satisfaction, then write to the Consumer Affairs Division at the company address indicated above. SERVICE CALLS WHICH DO NOT INVOLVE DEFECTIVE MATERIALS OR WORKMANSHIP ARE NOT COVERED. COSTS OF SUCH SERVICE CALLS ARE THE RESPONSIBILITY OF THE PURCHASER.