

Panasonic®

LCD TV Operating Instructions

Model No. **TC-26LX20**
TC-32LX20



For assistance, please call : 1-800-211-PANA (7262)
or send e-mail to : consumerproducts@panasonic.com
or visit us at www.panasonic.com (U.S.A.)

For assistance, please call : 787-750-4300
or visit us at www.panasonic.com (Puerto Rico)

For assistance, please call : 1-800-561-5505
or visit us at www.panasonic.ca (Canada)

Before connecting, operating or adjusting this product, please read these instructions completely.
Please keep this manual for future reference.

English

Español [Resumen]

TOBC0781

Important Safety Instructions

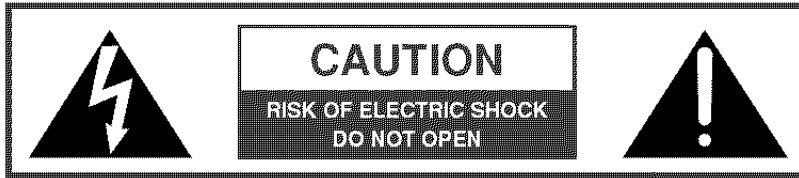

The lightning flash with arrow head within a triangle is intended to tell the user that parts inside the product are a risk of electric shock to persons.



The exclamation point within a triangle is intended to tell the user that important operating and servicing instructions are in the papers with the appliance.

■ **Note to CATV System Installer:** This reminder is provided to direct the CATV system installer's attention to Article 820–40 of the NEC that provides guidelines for proper grounding and, in particular, specifies that the cable ground shall be connected to the grounding system of the building, as close to the point of cable entry as practical.

■ Important Safety Instructions for LCD TV

- 1) Read these instructions.
All the safety and operating instructions should be read before the appliance is operated.
- 2) Keep these instructions.
The safety and operating instructions should be retained for future reference.
- 3) Heed all warnings.
All warnings on the appliance and in the operating instructions should be adhered to.
- 4) Follow all instructions.
All operating and use instructions should be followed.
- 5) Do not use this apparatus near water.
For example, near a bathtub, wash bowl, kitchen sink, or laundry tub, in a wet basement, or near a swimming pool, and the like.
- 6) Clean only with dry cloth.
Do not use liquid cleaners or aerosol cleaners. Use a dry cloth for cleaning.
- 7) Do not block any ventilation openings. Install in accordance with the manufacturer's instructions.
Slots and Openings in the cabinet are provided for ventilation and to ensure reliable operation of the product and to protect it from overheating. The openings should never be blocked by placing the product on a bed, sofa, rug, or other similar surface.
- 8) Do not install near any heat sources such as radiators, heat registers, stoves, or other apparatus (including amplifiers) that produce heat.
This product should not be placed in a built-in installation such as a bookcase or rack unless proper ventilation is provided or the manufacturer's instructions have been adhered to.
- 9) Do not defeat the safety purpose of the polarized or grounding-type plug. A polarized plug has two blades with one wider than the other. A grounding type plug has two blades and a third grounding prong. The wide blade or the third prong are provided for your safety. If the provided plug does not fit into your outlet, consult an electrician for replacement of the obsolete outlet.
- 10) Protect the power cord from being walked on or pinched particularly at plugs, convenience receptacles, and the point where they exit from the apparatus.
- 11) Only use attachments / accessories specified by the manufacturer.
- 12) Use only with the cart, stand, tripod, bracket, or table specified by the manufacturer, or sold with the apparatus. When a cart is used, use caution when moving the cart / apparatus combination to avoid injury from tip-over.
Quick stops, excessive force, and uneven surfaces may cause the appliance and cart combination to overturn.
- 13) Unplug this apparatus during lightning storms or when unused for long periods of time.
This will prevent damage to the product due to lightning and power-line surges.
- 14) Refer all servicing to qualified service personnel. Servicing is required when the apparatus has been damaged in any way, such as power-supply cord or plug is damaged, liquid has been spilled or objects have fallen into the apparatus, the apparatus has been exposed to rain or moisture, does not operate normally, or has been dropped.
- 15) To prevent electric shock, ensure the grounding pin on the AC cord power plug is securely connected.



Important Safety Instructions

16) If an outside antenna is connected to the television equipment, be sure the antenna system is grounded so as to provide some protection against voltage surges and built up static charges. In the U.S. Selection 810-21 of the National Electrical Code provides information with respect to proper grounding of the mast and supporting structure, grounding of the lead-in wire to an antenna discharge unit, size of grounding conductors, location of antenna discharge unit, connection to grounding electrodes, and requirements for the grounding electrode.

EXAMPLE OF ANTENNA
GROUNDING AS PER (NEC)
NATIONAL ELECTRICAL
CODE

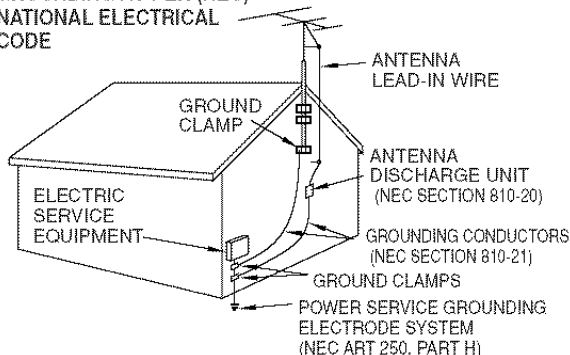

17) An outside antenna system should not be located in the vicinity of overhead power lines or other electric light or power circuits, or where it can fall into such power lines or circuits. When installing an outside antenna system extreme care should be taken to keep from touching such power lines or circuits as contact with them might be fatal.

18) Unplug this LCD TV from the wall outlet, and refer servicing to qualified service personnel under the following conditions:

- When the power cord or plug is damaged or frayed.
- If liquid has been spilled into the LCD TV.
- If the LCD TV has been exposed to rain or water.

d. If the LCD TV does not operate normally by following the operating instructions.

Adjust only those controls that are covered by the operating instructions as improper adjustment of other controls may result in damage and will often require extensive work by a qualified technician to restore the LCD TV to normal operation.

e. If the LCD TV has been dropped or the cabinet has been damaged.

f. When the LCD TV exhibits a distinct change in performance - this indicates a need for service.

19) When replacement parts are required, be sure the service technician uses replacement parts specified by the manufacturer that have the same characteristics as the original part. Unauthorized substitutions may result in fire, electric shock, or other hazards.

20) **WARNING: TO REDUCE THE RISK OF FIRE OR ELECTRIC SHOCK, DO NOT EXPOSE THIS APPARATUS TO RAIN OR MOISTURE.**

DO NOT PLACE LIQUID CONTAINERS (FLOWER VASES, CUPS, COSMETICS, ETC.) ABOVE THE SET. (INCLUDING ON SHELVES ABOVE, ETC.)

21) **CAUTION: TO PREVENT ELECTRIC SHOCK DO NOT USE THIS PLUG WITH A RECEPTACLE OR OTHER OUTLET UNLESS THE BLADES CAN BE FULLY INSERTED TO PREVENT BLADE EXPOSURE.**

NOTE: ● This equipment is designed to operate in the U.S.A. and other countries where the broadcasting system and AC house current is exactly the same as in the U.S.A.

- The marking or retained image on the LCD panel resulting from fixed image use is not an operating defect and as such is not covered by Warranty. This product is not designed to display fixed image patterns for extended periods of time.

■ Important Information Regarding Use of Video Games, Computers, Captions or Other Fixed Image Displays.

The extended use of fixed image program material can cause a permanent "shadow image" on the LCD panel.

This background image is viewable on normal programs in the form of a stationary fixed image. This type of irreversible LCD panel deterioration can be limited by observing the following steps:

- Reduce the brightness / contrast setting to a minimum viewing level.
- Do not display the fixed image for extended periods of time.
- Turn the power off when not in actual use.

■ This product utilizes tin-lead solder, and has a fluorescent lamp containing a small amount of mercury. Disposal of these materials may be regulated in your community due to environmental considerations. For disposal or recycling information please contact your local authorities, or the Electronics Industries Alliance: www.eiae.org.

Dear Panasonic Customer

Welcome to the Panasonic family of customers.

We hope that you will have many years of enjoyment from your new LCD TV. To obtain maximum benefit from your set, please read these instructions before making any adjustments, and retain them for future reference.

Retain your purchase receipt, and record the model number and serial number of your set in the space provided on the rear cover of these instructions.

For assistance, please call : 1-800-211-PANA (7262) or send e-mail to : consumerproducts@panasonic.com or visit us at www.panasonic.com (U.S.A.)
For assistance, please call : 787-750-4300 or visit us at www.panasonic.com (Puerto Rico)
For assistance, please call : 1-800-561-5505 or visit us at www.panasonic.ca (Canada)

Federal Communication Commission Information

This equipment has been tested and found to comply with the limits for a TV Broadcast Receiver, pursuant to Part 15 of the FCC Rules. These limits are designed to provide reasonable protection against harmful interference in a residential installation. This equipment generates, uses and can radiate radio frequency energy and, if not installed and used in accordance with the instructions, may cause harmful interference to radio communications. However, there is no guarantee that interference will not occur in a particular installation. If this equipment does cause or receive interference, which can be determined by turning equipment off and on, the user is encouraged to try to correct the interference by one or more of the following measures:

- Reorient or relocate the TV antenna.
- Increase the separation between TV and other equipment.
- Connect TV into separate outlet from other equipment.
- Consult the dealer or an experienced radio / TV technician for help.

FCC Caution: Pursuant to 47CFR, Part 15.21 of the FCC rules, any changes or modifications not expressly approved by Matsushita Electric Corporation of America could result in harmful interference and would void the user's authority to operate this equipment.



The Energy Star label, a symbol for energy efficiency, was created by the U.S. Environmental Protection Agency (EPA) and the U.S. Department of Energy (DOE) to help customers identify products that can save them money and protect the environment by saving energy. Energy Star compliant products generally consume less energy than similar standard products.



HDMI, the HDMI logo and High-Definition Multimedia Interface are trademarks or registered trademarks of HDMI Licensing LLC.

Table of Contents

Important Safety Instructions	2	Operating peripheral equipment using the remote control	33
SUPPLIED ACCESSORIES	5	Programming the remote control code	33
Installation	6	Infrared Code Index	34
Connections	7	Mode Operational Key Chart	37
Antenna Connection	7	Manual de instrucciones [Resumen]	
Cable Box Connection	8	Instalación de las pilas del mando a distancia	39
Connecting Other Equipment	9	Conexión	40
Connecting Headphones / Earphones	10	Conexión de antena	40
HDMI Connection	11	Conexión del receptor de TV por cable	41
Basic Controls	12	Controles básicos	42
Remote Control	12	Control remoto iluminado	42
Main Unit	14	Aparato principal	44
Power ON / OFF	14	Conexión / desconexión de la alimentación ...	44
ASPECT Controls	15	Photo Viewer™	45
Photo Viewer™	16	Modo de imagen miniatura	45
Thumbnail Mode	17	Operaciones con menús	46
Photo Viewer™ Setup Menu	18	Sintonización de canales	48
Menu Operations	20	Troubleshooting	50
Tuning Channels	22	Specifications	51
LOCK	24	Maintenance	51
CLOSED CAPTION	27		
INPUT LABEL	28		
OTHER ADJUST	28		
PICTURE ADJUST	29		
POSITION/SIZE	31		
AUDIO ADJUST	32		

SUPPLIED ACCESSORIES

Check the accessories before installations.

- Operating Instruction book
- Remote Control Transmitter (EUR7603ZG0)
- Batteries for the Remote Control Transmitter (2 × AA size)

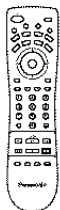
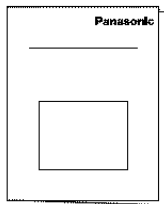

- Warranty Card
- Service Center List (For U.S.A.)
- Customer Card (For U.S.A.)
- F-Type Antenna Connector (for 4C-2V) (× 1)
- Ferrite core (for HDMI cable) (× 1)

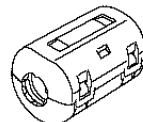
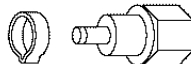

SUPPLIED ACCESSORIES / Installation

Remote control battery installation

Requires two AA batteries.

1. Open the battery cover.
2. Install the batteries.
Note the correct polarity (+ and -).
3. Replace the cover.

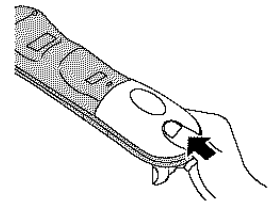
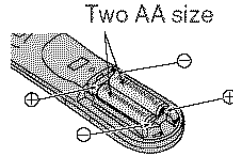
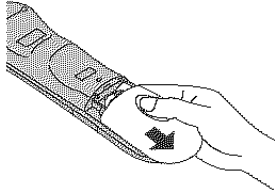

⚠ Precaution on battery use

Incorrect installation can cause battery leakage and corrosion that will damage the remote control transmitter.

1. Always use new batteries when replacing the old set.
2. Do not attempt to charge, short-circuit, disassemble, heat or burn used batteries.
3. Battery replacement is necessary when remote control acts sporadically or fails to operate this unit.

Notes:

- Do not drop, apply shock to or step on the remote control.
- Do not spill water on the remote control.
- Do not place objects between the remote control and remote control receiver.
- Do not use remote controls for other equipment at the same time.
- If the TV does not operate even when using the remote control from a close range, it is time to replace the batteries.

Installation

Receiver Location

Locate for comfortable viewing. Avoid placing where sunlight or other bright light (including reflections) will fall on the screen. Use of some types of fluorescent lighting can reduce remote control transmitter range. Adequate ventilation is essential to prevent internal component failure. Keep away from areas of excessive heat or moisture.

Optional External Equipment

The Video / Audio connection between components can be made with shielded video and audio cables. For best performance, antenna cables should utilize 75 ohm coaxial shielded wire. Cables are available from your dealer or electronic supply store. Before you purchase any cables, be sure you know what type of output and input connectors your various components require. Also determine the length of cable you'll need.

For optimum quality picture

When the LCD is exposed to light from outdoors or lighting fixtures, high-contrast pictures may not be displayed clearly. Turn off florescent lamps near the LCD and place in a location not exposed to outdoor light.

How to hang the LCD TV on the wall

This LCD TV is for use only with the following optional accessory. Use with any other type of optional accessories may cause instability which could result in the possibility of injury.

- Wall-hanging bracket TY-WK32LX20W

Always be sure to ask a qualified technician to carry out set-up.

How to use the LCD stand

Adjust the stand to your desired angle. The stand angle can be adjusted between 20 ° left to 20 ° right.

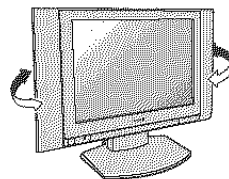
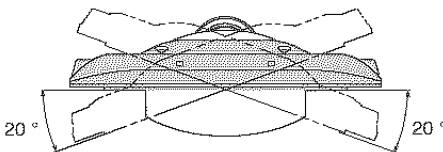

Connections

Cover removal and fitting

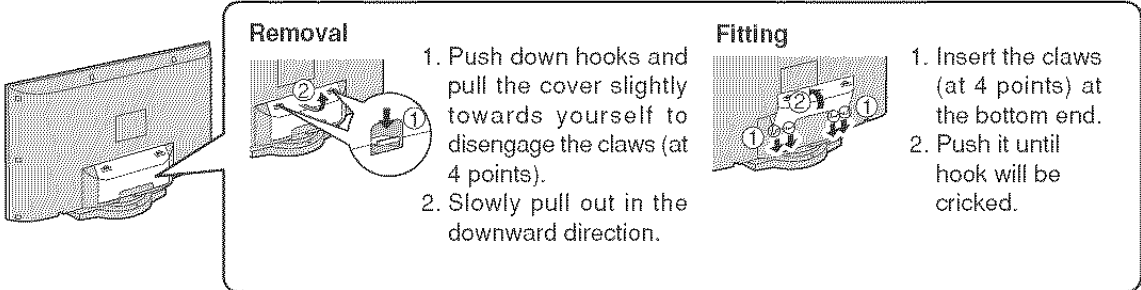

Removal

1. Push down hooks and pull the cover slightly towards yourself to disengage the claws (at 4 points).
2. Slowly pull out in the downward direction.

Fitting

1. Insert the claws (at 4 points) at the bottom end.
2. Push it until hook will be cricked.

Note:

Separate the RF cable and the power cord to avoid interference appearing on the screen.

Antenna Connection

For proper reception of VHF / UHF channels, an external antenna is required. For best reception an outdoor antenna is recommended. The antenna mode must be set to TV (see page 22, MODE).

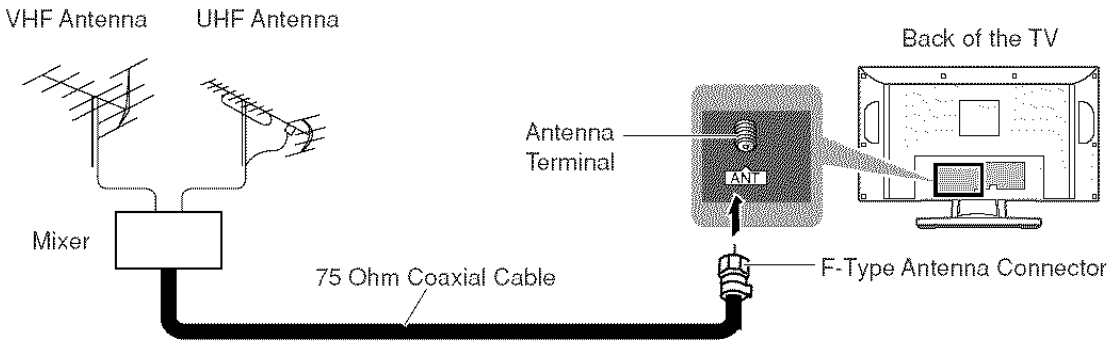

■ Cable / Antenna Connection

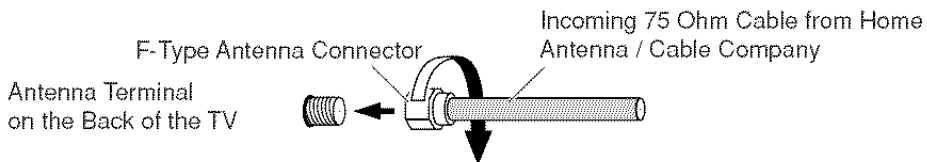

Cable Box Connection

- For reception of cable channels (01 - 125), connect the cable supplied by your local cable company. The antenna mode must be set to CABLE (see page 22, MODE).
- Certain cable systems offset some channels to reduce interference or have Premium (scrambled) channels. A cable converter box is required for proper reception. Check with your local cable company for its compatibility requirements.
- Set the TV channel to CH3 or CH4, cable when using this connection.

Cable Box

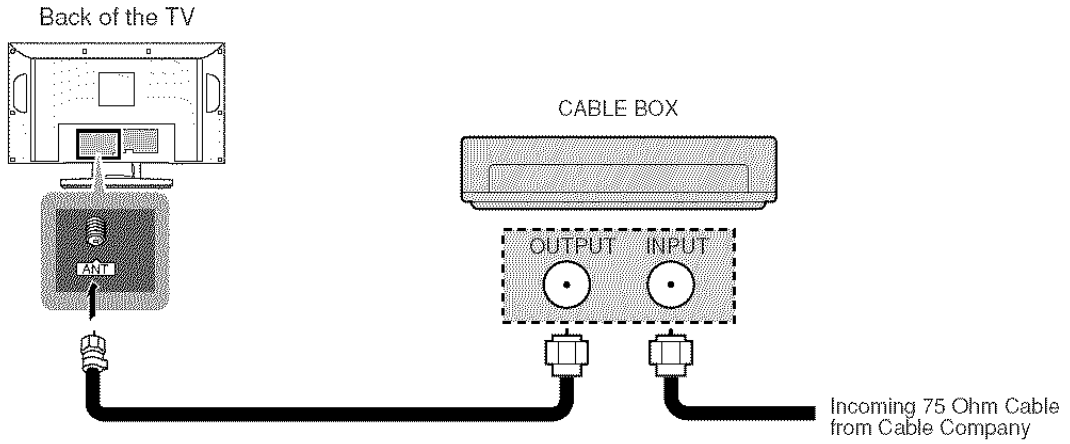

Cable Box and VCR

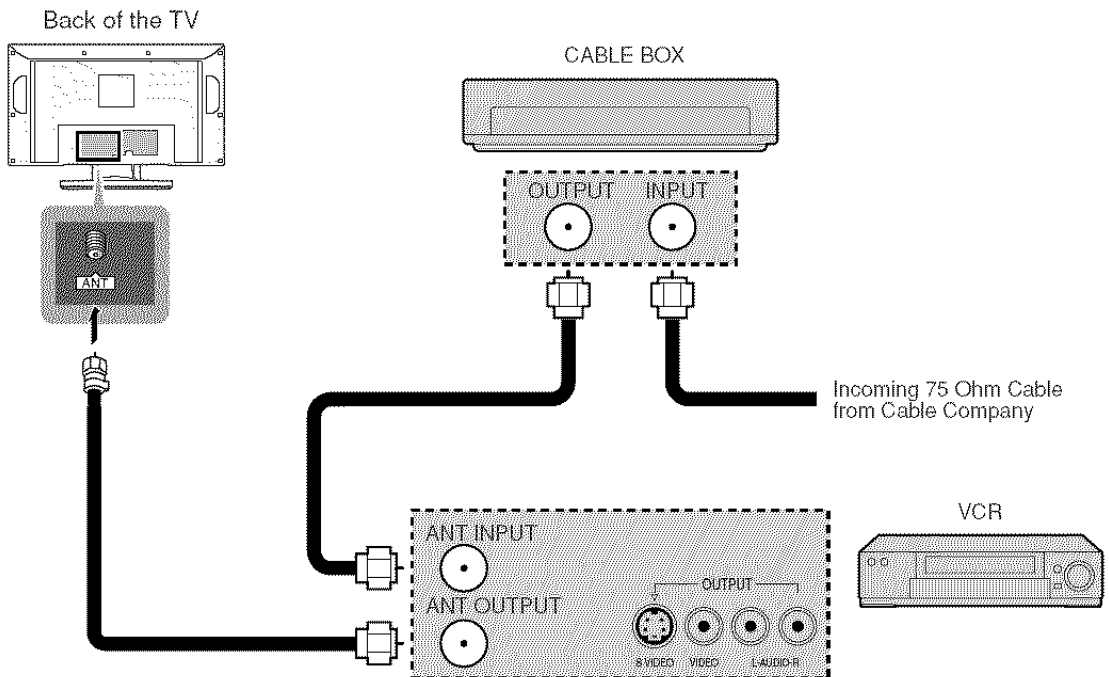

Connecting Other Equipment

Rear Input Terminals

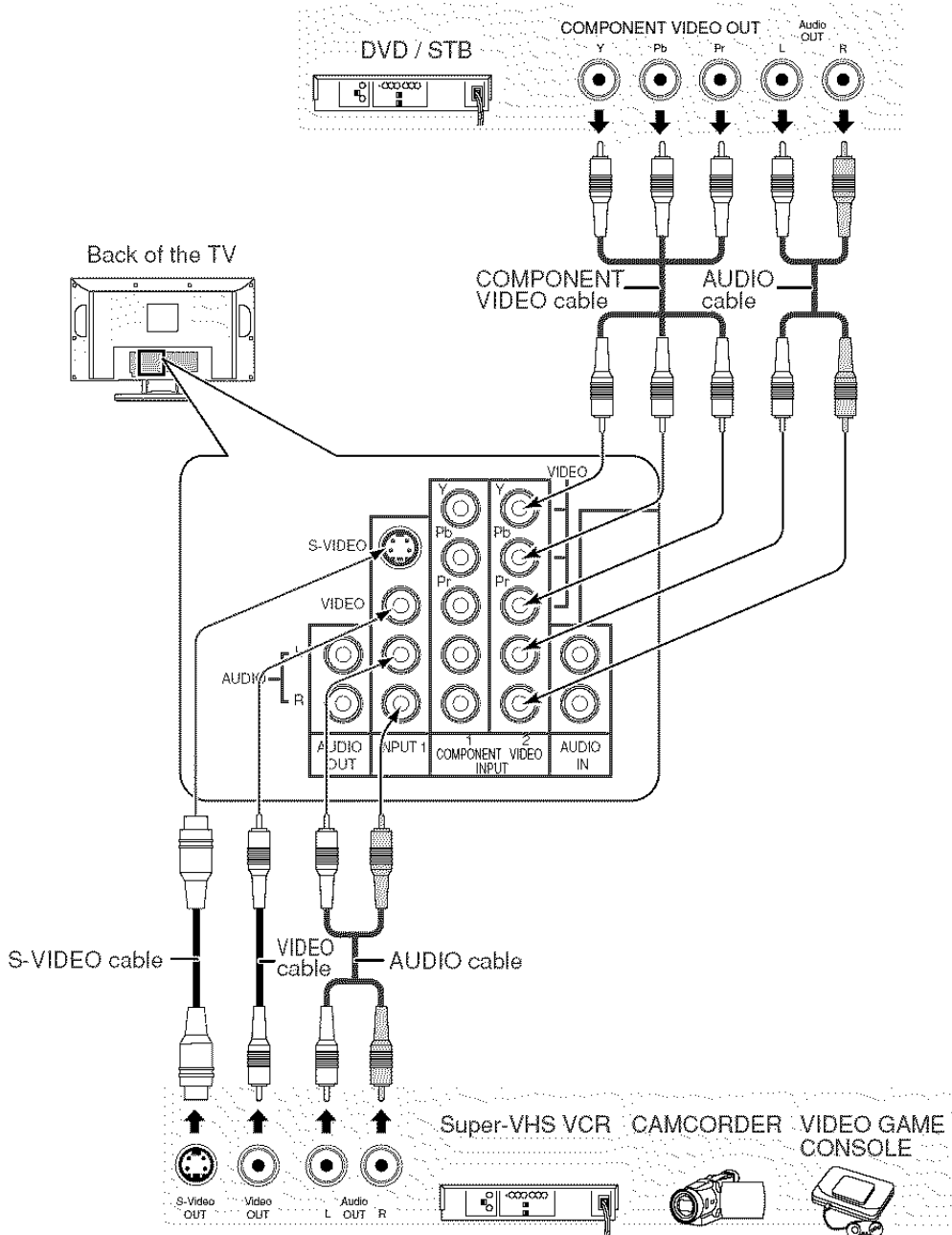

Notes:

- When connecting video cables, priority is given to the S-Video cable when both the S-VIDEO input terminal and the VIDEO input terminal are connected.
- Please make inquiries to video game manufacturers concerning component cables to connect with video game console.

Connections

Rear Output Terminals

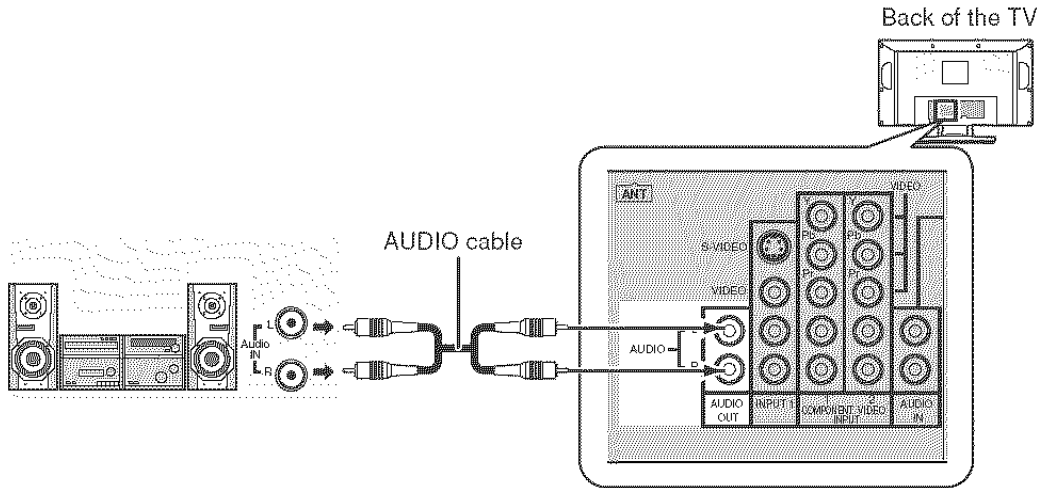

Front Input Terminals

Front of the TV

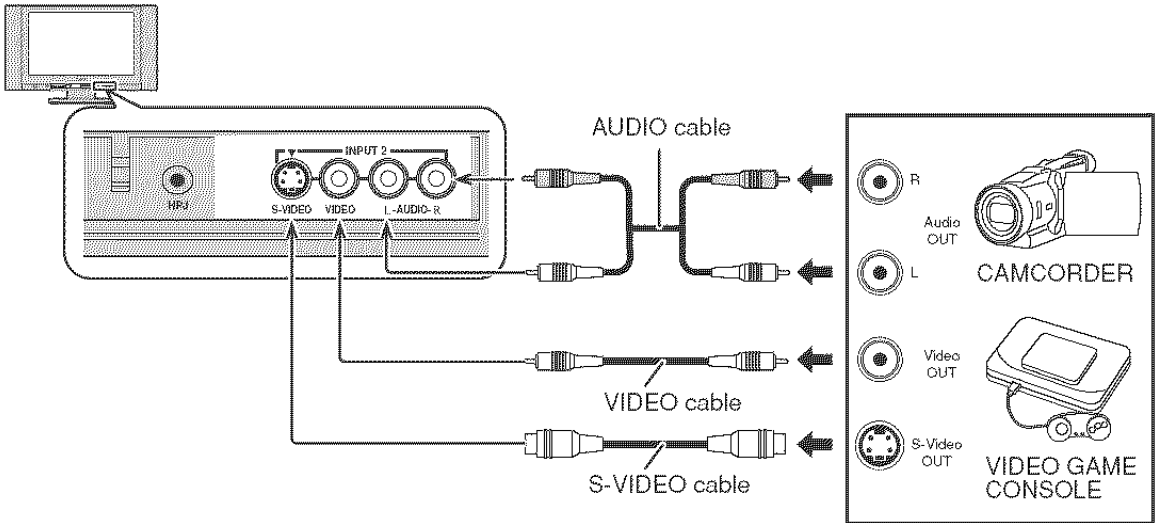

Connecting Headphones / Earphones

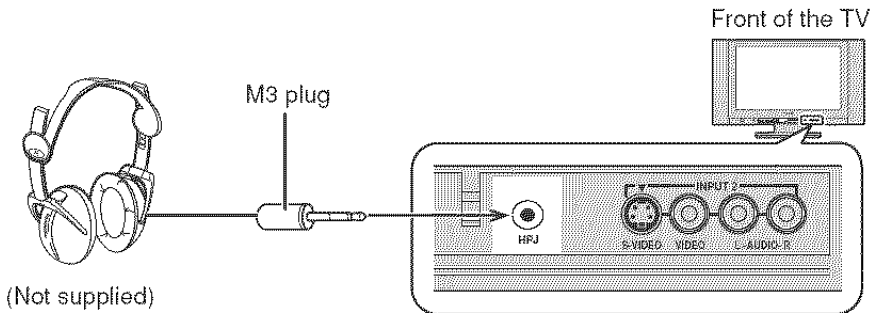

HDMI Connection

HDMI*1 (High Definition Multimedia Interface) is the first all digital consumer electronics A/V interface that supports uncompressed standard. The HDMI terminal supports both video and audio information. You can connect an EIA / CEA-861 / 861B*2 compliant consumer electronic device, such as a Set Top Box or DVD player with HDMI or DVI output terminal to the HDMI*1 input terminal.

Input a High-bandwidth Digital Content Protection (HDCP) high-definition picture source to this HDMI terminal, so you can display high-definition pictures on this TV in the digital form.

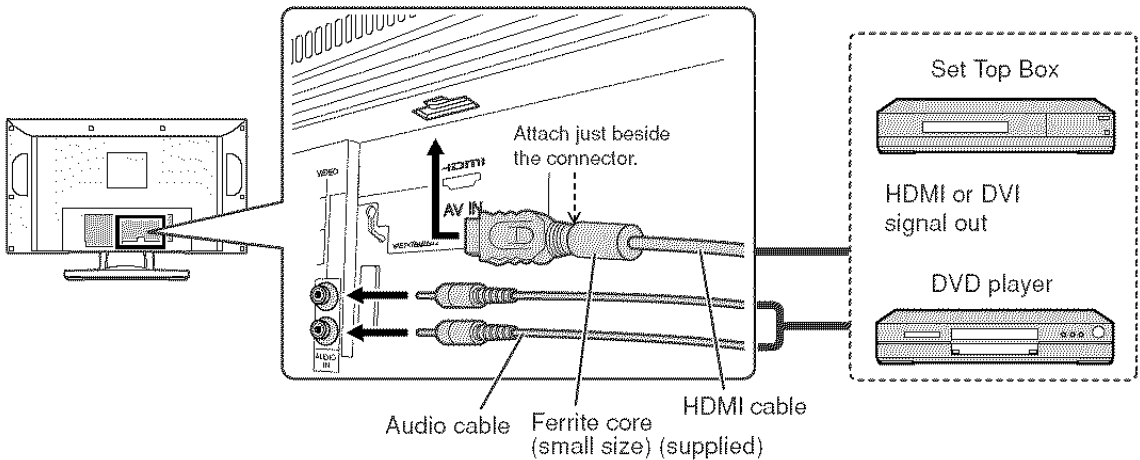

Notes:

- If the external device has DVI output only, use a DVI to HDMI adapter cable*3 to connect to the HDMI terminal.
- Connect the audio cables to the AUDIO IN terminals for HDMI.
- Select the audio setting in HDMI IN (see page 32).

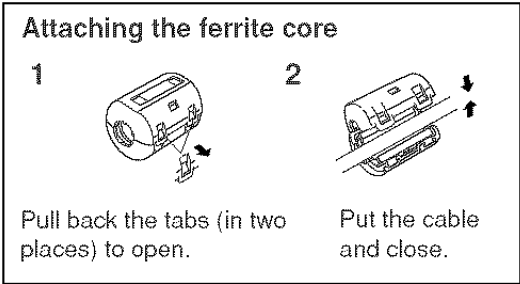

Compatible VIDEO Signal

	No. of dots (H × V)	Vertical scanning frequency (Hz)
1080i	1,920 × 1,080i	59.94 / 60
720p	1,280 × 720p	59.94 / 60
480p	720 × 480p	59.94 / 60
	640 × 480p	59.94 / 60
480i	720(1,440) × 480i	59.94 / 60

This input terminal is not intended for use with computers.

Compatible sampling frequency of AUDIO signal (L.PCM) : 48 kHz / 44.1 kHz / 32 kHz

Notes:

- This HDMI connector is Type A.
- If you connect an equipment without a digital output terminal, connect to the COMPONENT VIDEO, S VIDEO or VIDEO input terminal on the TV so you can enjoy an analog signal.

*1. HDMI, the HDMI logo and High-Definition Multimedia Interface are trademarks or registered trademarks of HDMI Licensing LLC.
 *2. EIA / CEA-861 / 861B profiles compliance covers profiles for transmission of uncompressed digital video including high bandwidth digital content protection.
 *3. HDMI-DVI conversion cable (TY-SCHO3DH): available on Panasonic website (www.panasonic.com). Consult your consumer electronics dealer for availability details.

Basic Controls

Remote Control

POWER button

Press to turn the TV on or off (see page 14).

Note:

This does not work when the main power is off (No light).

MUTE button

Press to mute the sound.

Press again to cancel mute.

Mute is canceled when the power is turned off or volume level is changed.

Mode Selection buttons

(see page 33)

MENU button

(see page 20)

RECALL button

Press to display channel number, sleep timer and other options.

R-TUNE button

Press to switch to previously viewed channel or to switch between TV mode and another input mode.

SD button

Press to access Photo Viewer™ (see page 17)

Operation of other devices

(see pages 37, 38)

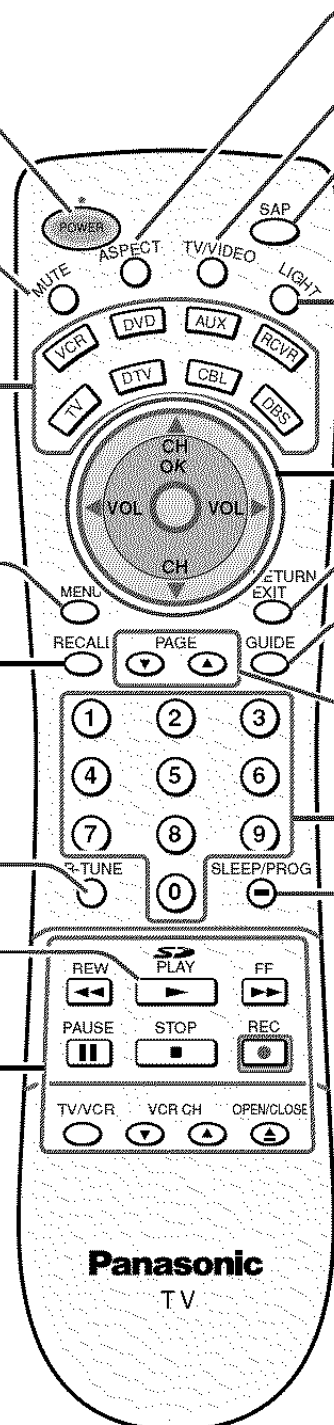

ASPECT button (see page 15)

TV/VIDEO button

Press to change the input mode.

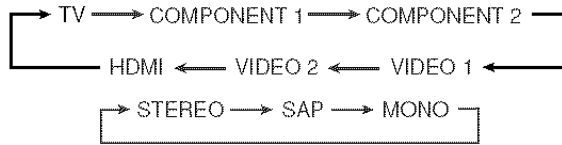

SAP button

Press to select the audio mode. You can also change the mode in the MENU screen (see page 32).

LIGHT button

Press to light the remote control buttons. The selected button blinks when lit.

RETURN button

Return to previous MENU (TV mode).

EXIT button

EXIT from menu (DTV, STB or PVR mode).

GUIDE button (DBS mode)

PAGE button

Page up / down (DBS mode).
Skip + / - (DVD & CD mode).

Numbered buttons

SLEEP button (TV mode)

Set the sleep time to put the TV into standby mode.



- When 3 minutes left, "3" will flash. ("2" for 2 minutes and "1" for 1 minute).
- The SLEEP timer is cancelled when the power is turned off.

PROG - button (DBS or DTV mode)

When tuning digital channel, press the button to enter the minor number in a compound channel number.

- To enter the channel number
ex. CH 15-1: [1] → [5] → [-] → [1] → [OK]

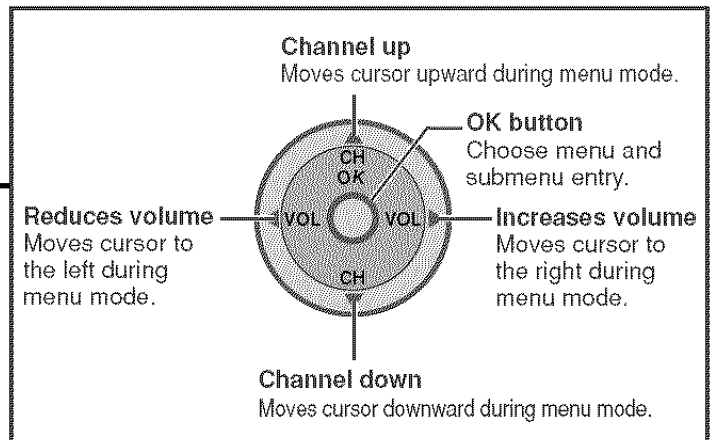

Main Unit

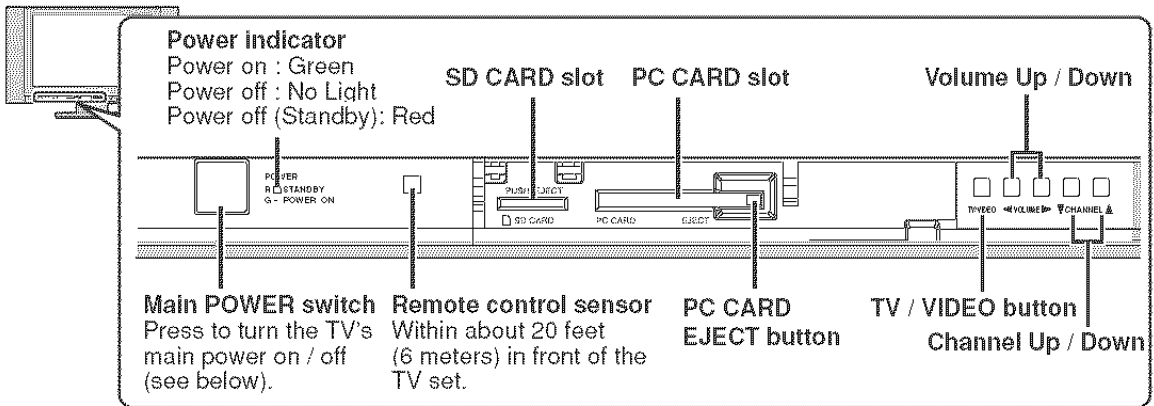

Power ON / OFF

Preparation

Connect the plug to the wall outlet.

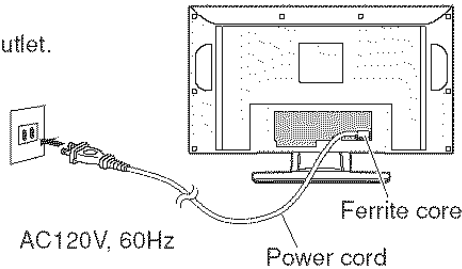

Notes:

- The TV consumes some power as long as the power cord is inserted into the wall outlet.
- Do not remove or slide the ferrite core for the safety purpose.

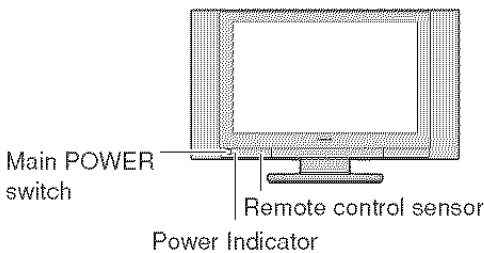

On the main unit



Press to turn the TV's main power on / off.

- Power indicator
 Main power ON: Green
 Main power OFF: No light

On the remote control



Press to turn the TV on / off.

- Power indicator
 Power ON: Green
 Power OFF (Standby): Red
- This does not work when the main power is off (No light) (see above).

Note:

- The screen below is displayed for a few moments when the TV is turned on.



Note:

- Select the menu language before operating the TV (see page 21, LANGUAGE).

ASPECT Controls

This feature allows you to enjoy viewing the picture at its maximum size, including wide screen cinema format picture.

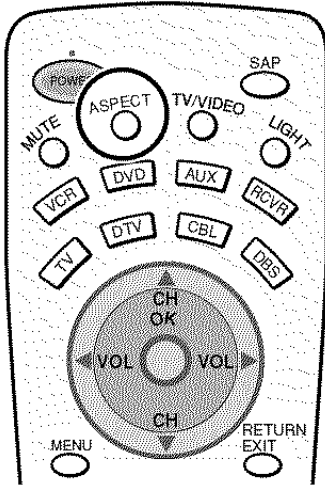

ASPECT

Each time you press the button:



Notes:

- This feature does not work for 1080i and 720p input signals.
- This feature does not work during Photo Viewer™ thumbnail mode or single picture view mode.
- The aspect setting is stored separately for TV, VIDEO1, VIDEO2, COMPONENT1, COMPONENT2, HDMI and Photo Viewer™ Slide Show (see page 18).

Mode	Picture	Explanation
NORMAL		NORMAL mode will display a 4:3 picture at its standard 4:3 size without any stretching.
JUST		JUST mode will display a 4:3 picture at its maximum size but with aspect correction applied to the sides of the screen so that elongation is only apparent at the left and right edges of the screen. The size of the picture will depend on the original signal.
ZOOM		ZOOM mode magnifies the central section of the picture.
FULL		FULL will display the picture at its maximum size but with slight elongation.

Photo Viewer™

Photo Viewer™ lets you display JPEG images recorded by digital still camera on SD card or other types of memory card when it is inserted in the proper card slot.

Compatible card type and card size

SD card slot

- SD Card (512MB)
- Multi Media Card (128MB)
- miniSD Card* (128MB)

PCMCIA card slot

- SD Card (512MB)
- miniSD Card* (128MB)
- Multi Media Card (128MB)
- Compact Flash (1GB)
- Smart Media (128MB)
- Memory Stick (128MB)
- xD Picture Card(128MB)
- Flash ATA (128 MB)
- Memory Stick Pro (1GB)

The cards require standard PCMCIA card adapter. (Some PC card adapter will not be compatible).

* miniSD Card requires miniSD adapter.

- Photo Viewer™ is not compatible with card type hard disk (Micro Drive, Mobile type hard disk, etc).
- Memory cards are not supplied with this television.
- When both SD card and PCMCIA card are inserted in the slot, SD card has the priority.

■ Card Data Protection

- Do not remove the card while Photo Viewer™ is accessing the information (when the card icon is flashing). Such action may damage the memory card or the unit itself.
- Before inserting or removing the PCMCIA card, make sure that the TV is turned Off. Otherwise, it may damage the unit.
- Do not touch the terminals on the back of the SD card / PCMCIA card.
- Always insert a card in the correct direction. Failure to do so may result in damage to the card and this unit.
- Do not subject the card to excessive pressure or strong impacts.
- Electrical interference, electrostatic discharges and malfunctions of the unit or card may all result in data loss or damage to the card.
- Stored data should be periodically backed up as a protection against data corruption, data loss or device malfunction. Please note that Panasonic shall not accept any liability for damage or loss of stored data.
- **WARNING: As with any small object, an SD card can be swallowed by young children. Do not allow children to handle SD card. Please remove SD card immediately after use.**

Folders and Files

- Photo Viewer™ can only show still images recorded by a digital still camera with DCF* and EXIF standard JPEG file.
- * DCF (Design rule for Camera File system) Unified standard established by Japan Electronics and Information Technology Industries Association (JEITA).
- Memory cards must be formatted with FAT12 or FAT16 in order to be viewed on TV. If the card is not formatted, it may cause incompatibility with certain memory card adapters. If this happens, reformat the card using your digital still camera. **Reformatting the card will erase the images stored in it.** Refer to your camera manual for more information.
- Maximum number of folders that can be displayed: **100**.
- Maximum number of files that can be displayed: **3000**.
- **Picture resolution:** Compatible in the range 64 x 64 - 8192 x 8192 (sub-sampling 4:2:2 or 4:2:0)
- If the image is imported from a PC, it must follow the EXIF (Exchangeable Image File Format) 2.0, 2.1, 2.2 in addition to the DCF format.
- The JPEG modified using a PC will not be displayed on TV.
- The Photo Viewer™ cannot display Motion JPEG and still image not DCF formatted (i.e. TIFF, BMP).
- If the file is partially corrupted, it may be shown in lower resolution.
- The displayed image size depends on the recorded size.

Example folder structure

JPEG images in all the folders are displayed sequentially.

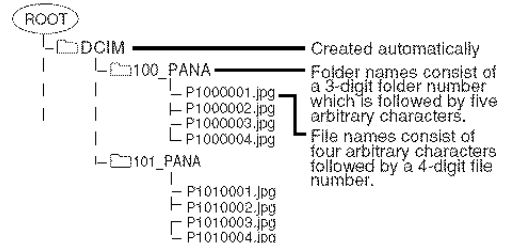

Note:

- Folder and file names may vary according to the digital still camera.
- Use the characters "a-z", "A-Z", "0-9" and "_" to name a directory or a file. Do not use two-byte characters or other special codes.

Inserting and removing a card

SD card slot
Insert the card.

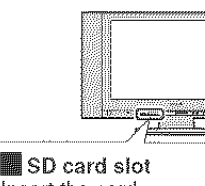

1. Raise. Label side upward
2. Insert it until it clicks in.

Remove the card.

1. Push the center of the card.
2. Lower.

PCMCIA card slot
Turn the TV off before inserting or removing a PCMCIA card.
Insert the card.

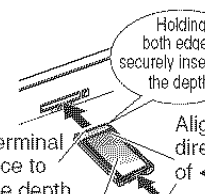

Remove the card.

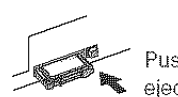

Push the eject button.

If the eject button does not pop out Push in PCMCIA card again, and then push again the eject button.

Note:
If PCMCIA card adapter is used, remove it together with the adapter.

Thumbnail Mode

The thumbnail screen is the initial entry screen from the main menu.

- When both SD card and PCMCIA card are inserted, the TV plays SD card. To play a PCMCIA card, select "PC" in "Card" (see page 19) after inserting the PCMCIA card.

- 1 Insert the card into the appropriate slot (see above).

OR



Press to display the thumbnail screen.

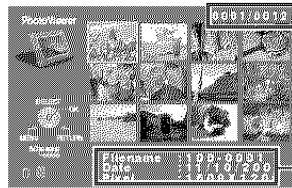

Picture No. / Total No. of pictures

File name, the date and the pixel (resolution) of the picture

Note:

- It may take long time to display the thumbnail if there are lots of files or the file size is large.
- The video disappears from the screen while the Photo Viewer™ access the information from the card. After accessing the images from the card, a thumbnail screen is displayed.

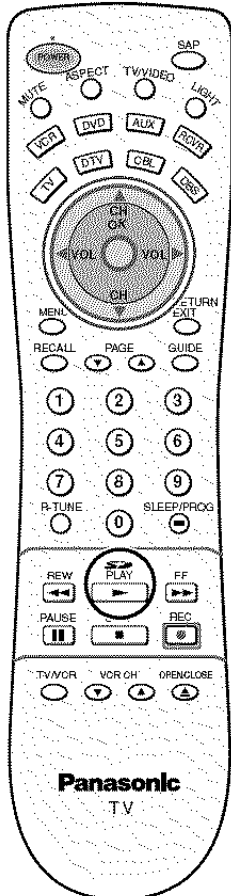

2

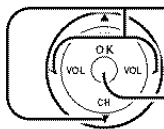

Select the thumbnail image.

Press to display the image in the single picture view mode.

Single picture view mode

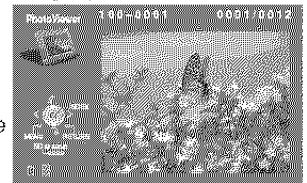

3

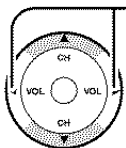

Press to select the next or the previous picture.

• Press OK to return to the thumbnail screen.

To rotate the picture

While in the single picture view mode

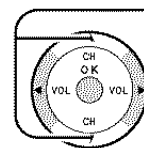

Press to rotate the picture ninety degree.

Photo Viewer™ Setup Menu

This menu allows you to customize features in the Photo Viewer™ Setup Menu.
While in the thumbnail mode or the single picture view mode (see page 17)

1



Press to display the Setup Menu screen.

2

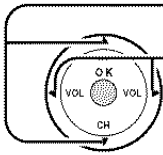

Press to select the sub-menu.

Press to adjust or activate the sub-menu.

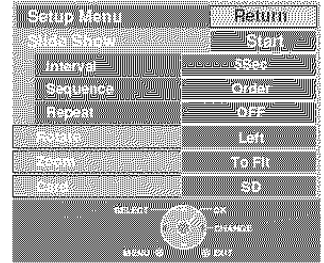

Slide Show

Select the settings of Interval, Sequence and Repeat before starting the slide show.

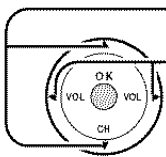

Press to select the sub-menu.

Press to adjust or activate the sub-menu.

Interval

Allows you to change the length of time that a slide is being displayed on screen. (5Sec, 10Sec, 15Sec, 30Sec, 60Sec, 90Sec, 10Min).

Sequence (Order or Random)

Repeat (OFF or ON)

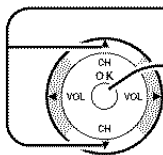

Press to select Start.

Press to start the slide show.

- Press again to stop.
- Press **ASPECT** to change the aspect of the image (see page 15).

Rotate

(While in the single picture view mode only)

Allows you to rotate the image (see also page 17).

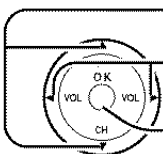

Press to select Rotate.

Press to select Left or Right.

Press to activate the setting.

Zoom

(While in the single picture view mode only)

Lets you select the magnification of the single picture display.

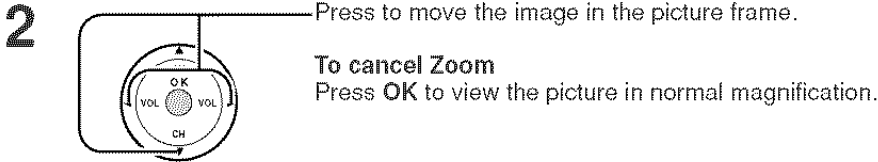
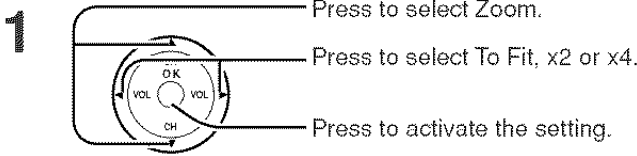

Card

Select either SD or PC when both cards are inserted in the slots.

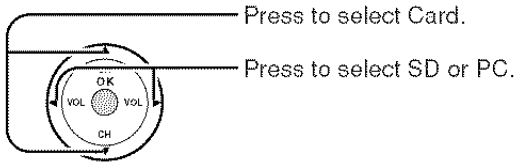



Photo Viewer™ Troubleshooting

Symptom	Cause and remedy
Cannot read the content of the card.	<ul style="list-style-type: none"> • Not compatible format. Must be formatted with FAT 12 or FAT 16. • The extension is not "JPG". • The folders not under DCF standard.
PC card cannot be ejected.	Push the card all the way in, and eject.
Poor picture quality.	If the main image cannot be read (the file is partially corrupted), the Photo viewer™ will read the thumbnail. Please confirm the format of the image.
Picture takes a long time to display.	There are lots of images or the file size is large.

Error messages

"Card is not inserted correctly."	Insert a card.
"This type of image is not supported."	The JPEG file is corrupted and cannot be decoded.
"This type of format is not supported."	The card is not formatted with FAT 12 or FAT 16 or if it is not DCF standard.
"  "	Thumbnail and main picture cannot be shown.
"Photo Viewer cannot support over 3000 JPEG files."	Over 3000 image files.
"Photo Viewer cannot support over 8192 x 8192 pixels."	Resolution over.
"This type of card is not supported."	Incompatible card is inserted.

Menu Operations

1

Press to display MENU screen.

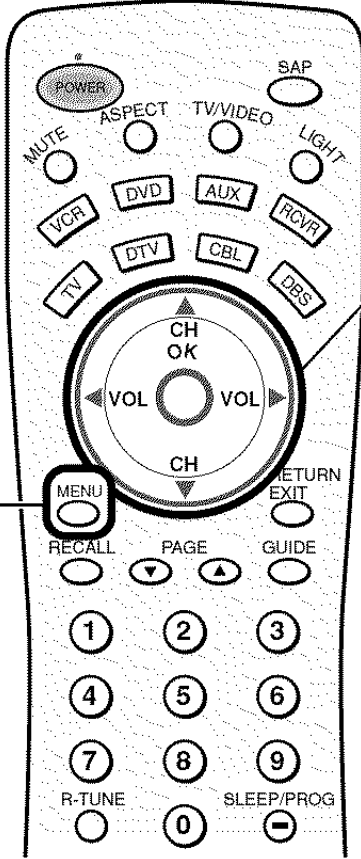
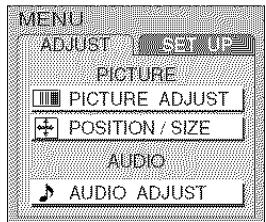

2

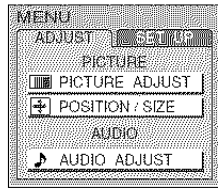

or

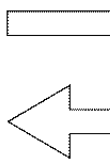
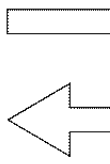
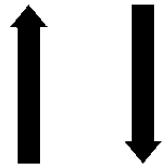
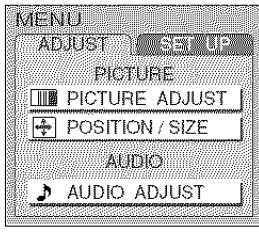
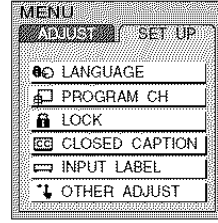

ON SCREEN HELP 'Instruction' box

An On Screen Help box is displayed when a menu is displayed on the TV. This Help box indicates which keys on the remote control are used to navigate the menu shown.

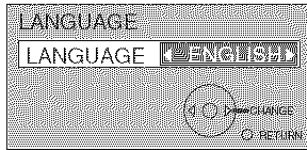

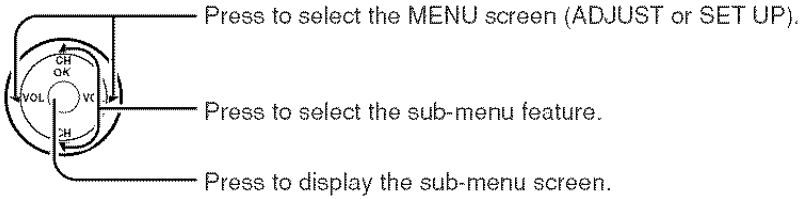

- To return to the previous screen : RETURN EXIT
- To exit the MENU screen: MENU This returns TV to normal viewing.

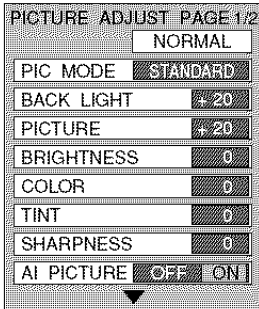

(See page 29)

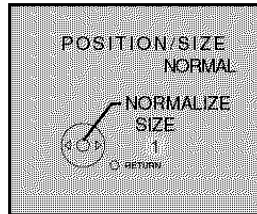

(See page 31)

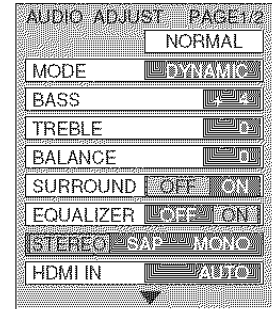

(See page 32)



Select the menu language.

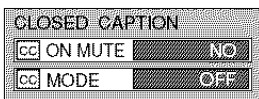
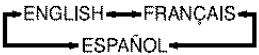

(See page 27)

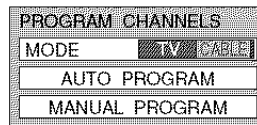

(See pages 22, 23)

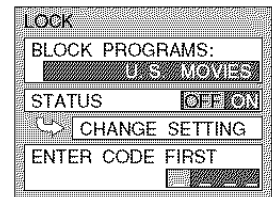

(See pages 24-26)

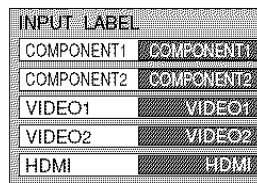

(See page 28)

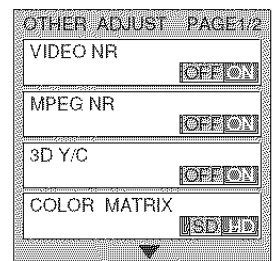

(See page 28)

Menu Operations

Tuning Channels

1 Press the TV/VIDEO button to display the TV channel.

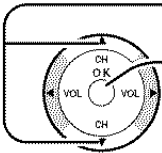
2  Press to select PROGRAM CH.
Press to display the PROGRAM CHANNELS screen.

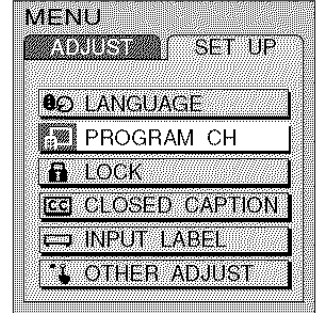

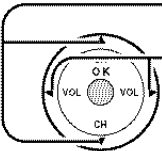
3  Press to select MODE.
Press to select TV or CABLE.

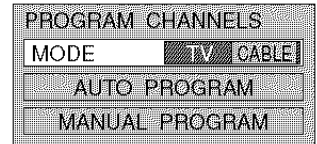

Automatic channel programming

Automatically scans and stores all the TV channels.

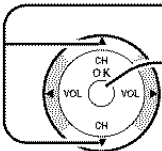
4  Press to select AUTO PROGRAM.
Press to display the AUTO PROGRAM screen.

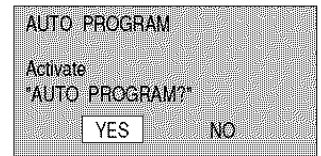

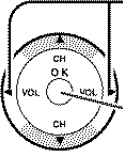
5  Press to select YES.
Press to start AUTO PROGRAM.
Channels will automatically advance until all channels have been scanned. Channel numbers with video signal received will be stored in the Channel Memory.

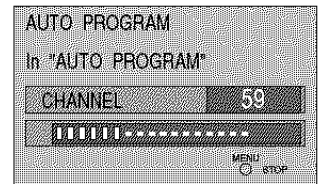

Notes:

- When any button is pressed during AUTO PROGRAM, the TV will return to normal viewing. (Channels searched up to the point are added.)
- After AUTO PROGRAM finishes, the lowest channel number added will be displayed.
- When there are no receivable channels, channel 69 (for TV) or channel 125 (for cable TV) is displayed.

Manual channel programming

Add or delete a channel manually.

4

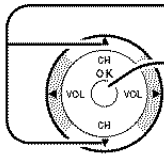

Press to select MANUAL PROGRAM.

Press to display the MANUAL PROGRAM screen.

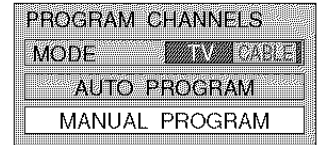

5

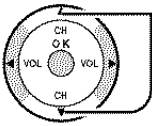

Press to select the channel.

• You can also use the numbered buttons.

6

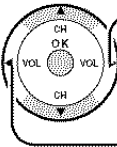

Press to add the channel to the Channel Memory (the channel number turns blue).

Press to delete the channel from the Channel Memory (the channel number turns yellow).

• Repeat steps 5 and 6 for other channels.



Menu Operations

LOCK

In the United States, the V-CHIP consists of two rating systems, which are MPA (MOTION PICTURE) and TV PARENTAL GUIDELINES. Its function is to block programs by the rating data in the XDS data packets sent from broadcasting stations. The user can select which rating programs should be blocked by the LOCK MENU options.

1

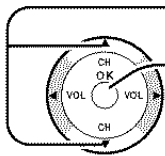

Press to select LOCK.

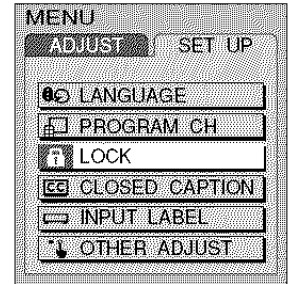

Press to display the LOCK screen.

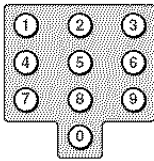

2



Input 4-digit code.

- To clear the numbers while entering the code, press Up  or Down .
- You will need the code to enter the LOCK menu.
- After entering your password for the first time, ENTER CODE FIRST will change to CHANGE CODE.

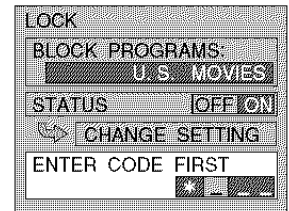

Note:

Use a code that is easy to remember and record it in a safe place.

3

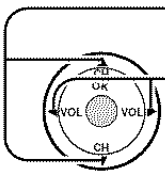

Press to select BLOCK PROGRAMS.

Press to select U.S. MOVIES, U.S. TV PROGRAMS, CANADIAN ENGLISH or CANADIAN FRENCH.

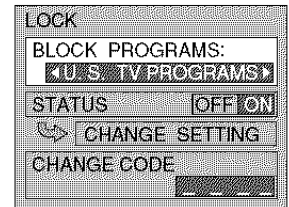

4

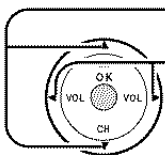

Press to select STATUS.

Press to select ON or OFF.

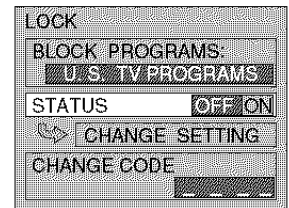

5

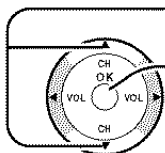

Press to select CHANGE SETTING.

Press to enter the next menu.

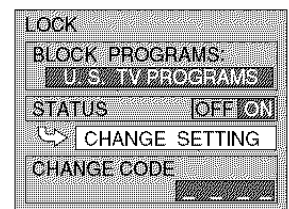

6

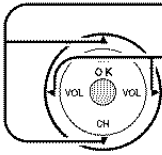

Press to select VIEW NR PROGRAMS?

Press to select NO or YES.

NO : Cannot view programs with NR signals.

YES : Can view programs with NR signals.

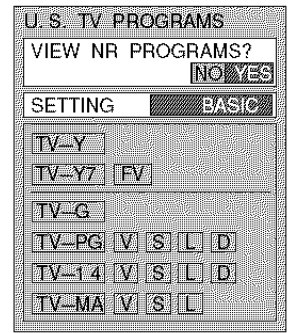

Title Option

7

U.S. TV PROGRAMS only

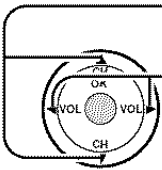

Press to select SETTING.

Press to select BASIC or DETAILED.

BASIC : You can select the titles.

DETAILED : You can select the titles and options.

8

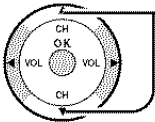

Press to select the rating.

- When a title field is selected, all ratings below this rating are selected.

When options within an option field are selected, ratings below this rating within the same field are selected.

9

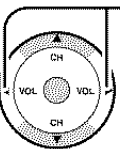

Press to lock or unlock the rating.

Lock : Red

Unlock : Green

Menu Operations

U.S. MOVIES RATINGS

G : General audience

PG : Parental guidance suggested

PG-13 : Parental guidance needed
under 13 years old

R : Restricted

NC-17 : No one under 17 is admitted

X : Pornography

U.S. TV PROGRAMS RATINGS

1. Ratings for children: Divided into ranks as follows.

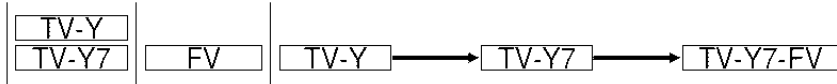

2. Ratings for teenagers: Created out of these major categories to form various combinations. These combinations are described in the below diagram. Ratings for all ages are on top and ratings for adults are on the bottom.

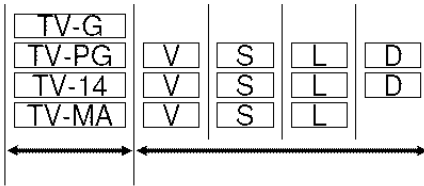

CANADIAN ENGLISH RATINGS

E	Exempt - Exempt programming includes: news, sports, documentaries and other information programming, talk shows, music videos, and variety programming.
C	Programming intended for children under age 8. No offensive language, nudity or sexual content.
C8+	Programming generally considered acceptable for children 8 years and over. No profanity, nudity or sexual content.
G	General programming, suitable for all audiences.
PG	Parental Guidance suggested. Some material may not be suitable for children.
14+	Programming contains themes or content which may not be suitable for viewers under the age of 14. Parents are strongly cautioned to exercise discretion in permitting viewing by pre-teens and early teens.
18+	18+ years old. Programming restricted to adults. Contains constant violence or scenes of extreme violence.

CANADIAN FRENCH RATINGS

E	Exempt - Exempt programming.
G	General - Programming intended for audience of all ages. Contains no violence, or the violence content is minimal or is depicted appropriately.
8 ANS+	8+ General - Not recommended for young children. Programming intended for a broad audience but contains light or occasional violence. Adult supervision recommended.
13ANS+	Programming may not be suitable for children under the age of 13 - Contains either a few violent scenes or one or more sufficiently violent scenes to affect them. Adult supervision strongly suggested.
16ANS+	Programming may not be suitable for children under the age of 16 - Contains frequent scenes of violence or intense violence.
18ANS+	18+ years old. Programming restricted to adults. Contains constant violence or scenes of extreme violence.

CLOSED CAPTION

This unit has a built in decoder that provides a visual depiction of the audio portion of a television program in the form of written words across the screen (white or colored letters on a black background). It allows you to read the dialogue of a television program or other information.

Notes:

- This feature is available only with the 480i input signal and with the programs including the closed caption.
- The closed caption is not displayed when using HDMI connection (see page 11) or when you set the aspect to "ZOOM" (see page 15).

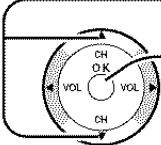
- 1**
- 
- Press to select CLOSED CAPTION.
- Press to display the CLOSED CAPTION screen.

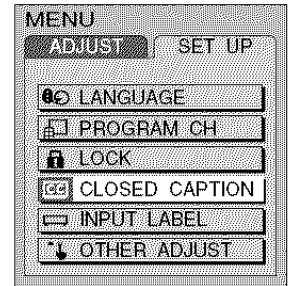

CC ON MUTE

Displays the On-Screen Closed Caption when the MUTE button is pressed. To delete the closed caption, press the MUTE button again.

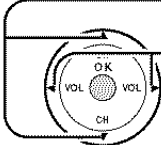
- 2**
- 
- Press to select **CC ON MUTE**.
- Press to select NO (OFF), C1 or C2.



Notes:

- To activate this feature, set **CC MODE** to OFF.

CC MODE

Displays the On-Screen Closed Caption.

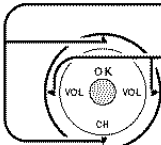
- 2**
- 
- Press to select **CC MODE**.
- Press to select OFF, C1 or C2.



- **OFF** - Recommended mode when Closed Caption is not being used.
- **C1** - For video related information that can be displayed (up to 4 lines of script strategically placed on the television screen so that it does not obstruct relevant parts of the picture).
- **C2** - Another mode used for video related information.

Menu Operations

INPUT LABEL

You can change the video input labels displayed on the screen to match the connected device (VCR, DVD player etc.).

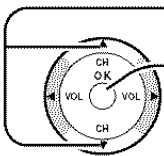
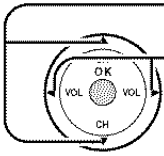
- 1  Press to select INPUT LABEL.
Press to display the INPUT LABEL screen.
- 2  Press to select the video input.
Press to select the INPUT LABEL (COMPONENT1 / COMPONENT2 / VIDEO1 / VIDEO2 / HDMI, VCR, LD, GAME, DVD, DTV, [BLANK] and SKIP*)
* Select to skip unused video input when pressing TV/VIDEO button.

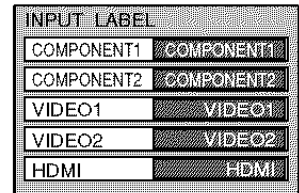
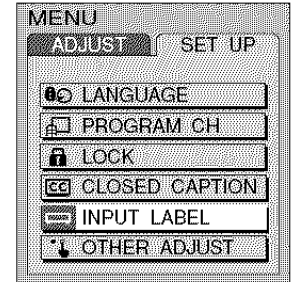

OTHER ADJUST

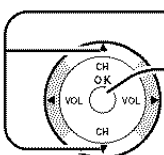
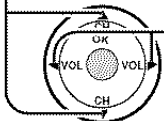
- 1  Press to select OTHER ADJUST.
Press to display the OTHER ADJUST screen.
- 2  Press to select the item.
Press to select the setting.

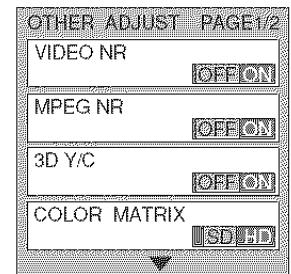
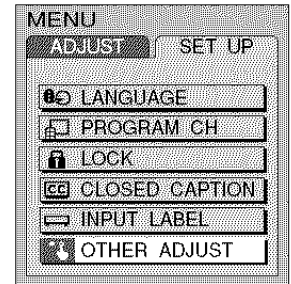

VIDEO NR

Reduce video noise in the picture.

OFF ↔ ON

MPEG NR

Noise unique to DVD, STB etc will be reduced.

OFF ↔ ON

3D Y/C

Minimizes noise and cross color in the picture. Not available for COMPONENT VIDEO INPUT and HDMI input.

OFF ↔ ON

COLOR MATRIX

Displays input signals (480p signals) in a natural color. Automatically adjusts color parameters for HD (high definition) and SD (standard definition).

SD ↔ HD

POWER SAVE

The POWER SAVE mode is suitable for watching television at night. Power consumption will be reduced.

STANDARD ↔ SAVING

PICTURE ADJUST

1

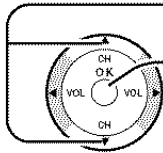

Press to select PICTURE ADJUST.

Press to display the PICTURE ADJUST screen.

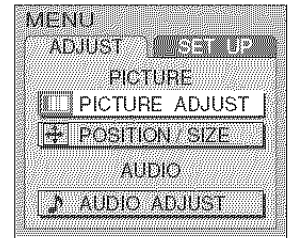

2

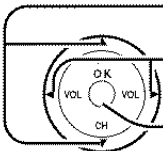

Press to select the sub-menu.

Adjust the setting watching the picture behind the menu.

Press to activate the setting if necessary.

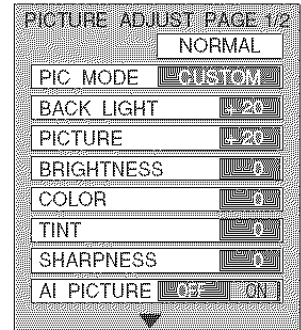

3 **ADVANCED ADJUST**

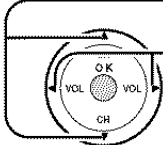

Press to select ADVANCED ADJUST.

Press to select ON.

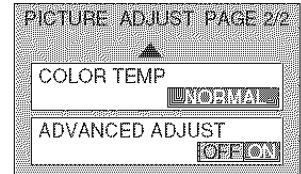

4

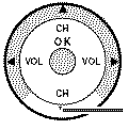

Press to display the sub-menu.

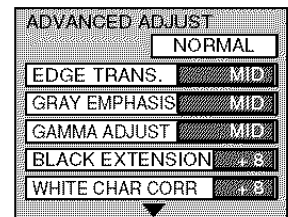

NORMAL / NORMALIZE

Select "NORMALIZE" and press "OK" to return each PIC MODE to the factory default setting.

Notes:

- "NORMAL" means the PIC MODE is in the factory default setting. "NORMAL" changes to "NORMALIZE" when you change the setting of BACK LIGHT, PICTURE, BRIGHTNESS, COLOR, TINT, SHARPNESS, AI PICTURE, COLOR TEMP or ADVANCED ADJUST.
- You can normalize each PIC MODE separately.

PICTURE MODE

MODE	Function
STANDARD	Displays a standard image.
CINEMA	Ideal for watching movies in a dark room.
VIVID	Displays a clear image with high contrast.
CUSTOM	You can customize the picture settings to suit your preference (see page 30, ADVANCED ADJUST).

The CUSTOM setting is stored for TV, VIDEO1, VIDEO2, COMPONENT1, COMPONENT2, HDMI and Photo Viewer™ mode (see page 16) individually.

Menu Operations

BACK LIGHT, PICTURE, BRIGHTNESS, COLOR, TINT, SHARPNESS, AI PICTURE, COLOR TEMP

You can change the level of each Item (BACK LIGHT, PICTURE, BRIGHTNESS, COLOR, TINT, SHARPNESS, AI PICTURE and COLOR TEMP) for each MENU (STANDARD, CINEMA, VIVID and CUSTOM) according to your personal preference.

Sub-menu	Function
BACK LIGHT	Luminance of the back light is adjusted.
PICTURE	Selects proper brightness and density for the room.
BRIGHTNESS	Adjusts for easier viewing of dark pictures such as night scenes.
COLOR	Adjusts the level of color.
TINT	Adjusts for flesh tone color.
SHARPNESS	Adjusts the degree of sharpness.
AI PICTURE	Displays black and white more accurately when turned ON.
COLOR TEMP (Color temperature)	Increases or decreases WARM (red) and COOL (blue) colors to suit personal preference.

ADVANCED ADJUST

(Only when you selected CUSTOM in PIC MODE)

Item	Function
EDGE TRANS.	Improves edges in the background to reduce overshooting and improve the sense of depth.
GRAY EMPHASIS	Emphasizes the sharpness in density of many color differences.
GAMMA ADJUST	Increases the brightness of the center ranges to improve detail and contrast in dark scenes.
BLACK EXTENTION	Contrast level will be improved.
WHITE CHAR CORR	It makes white characters brighter.

POSITION/SIZE

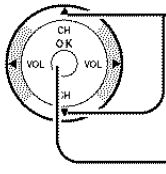

Press to select POSITION/SIZE.

Press to display POSITION/SIZE screen.

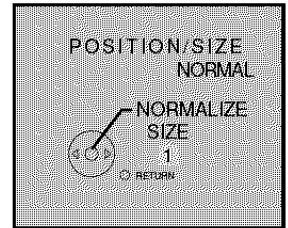
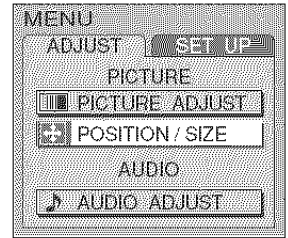

For "ZOOM" mode (see page 15)

• POSITION

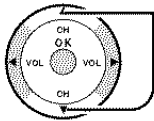

Press to move the picture up or down.

- Press **OK** to return to the original position.

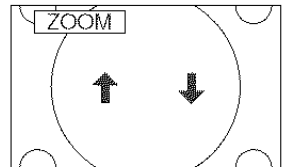

• SIZE

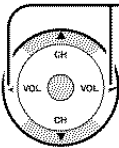

Press to shrink the picture vertically [by 15 steps: 15 (original setting) down to 1].

- Press **OK** to return to the original setting.



For "NORMAL" and "JUST" mode (see page 15)

• SIZE

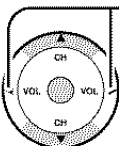

Press to select the size.

Size 1: reduces black bar.

Size 2: widens black bar.

- Press **OK** to return to the original setting.

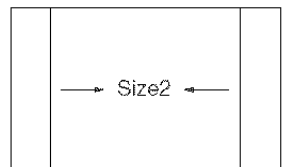
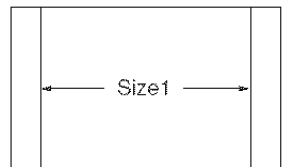

AUDIO ADJUST

1

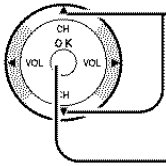

Press to select AUDIO ADJUST.

Press to display the AUDIO ADJUST screen.

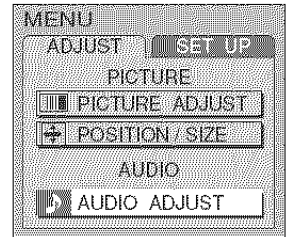

2

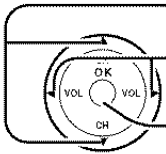

Press to select the sub-menu.

Select the setting listening the sound.

Press to activate the setting if necessary.

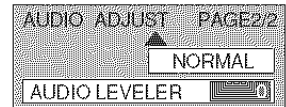
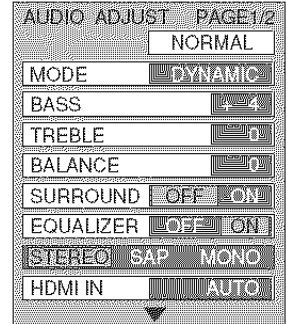

NORMAL / NORMALIZE

Select "NORMALIZE" and press "OK" to return each MODE to the factory default setting.

Notes:

- "NORMAL" means the MODE is in the factory default setting. "NORMAL" changes to "NORMALIZE" when you change the setting of BASS, TREBLE, BALANCE, SURROUND, EQUALIZER or AUDIO LEVELER.
- You can normalize each MODE separately.

MODE

AUTO	Automatically adjusts for a wide Dynamic Range.
STANDARD	Emits the original sound.
DYNAMIC	Gives contrast to sound.

BASS, TREBLE, BALANCE, SURROUND, EQUALIZER

You can change the level of each sub-menu (BASS, TREBLE, BALANCE, SURROUND, EQUALIZER) for each MODE (AUTO, STANDARD and DYNAMIC) according to your personal preference.

BASS	Adjusts low frequencies.
TREBLE	Adjusts high frequencies.
BALANCE	Adjusts left and right volume.
SURROUND	To enjoy a concert hall effect, select ON when stereo is playing.
EQUALIZER	Makes voice sound clear. Normally set to ON.

STEREO / SAP / MONO

- Red display : With signal
- White display : No signal
- White display (All modes) : MONO
- To change the mode using SAP button (see page 13).

STEREO	Two channel Audio reception.
SAP	Second Audio Programming (typically used for bilingual audio)
MONO	Use when stereo signal is weak.

HDMI IN

When using HDMI connection (see page 11), this feature will let you switch between Analog Input and Digital Input.

AUTO	Automatically selects Analog / Digital signal.
DIGITAL	Digital Input only.
ANALOG	Analog Input only.

AUDIO LEVELER

You can adjust the volume level for each of the input mode (TV, VIDEO1, VIDEO2, COMPONENT1, COMPONENT2 and HDMI).

Operating peripheral equipment using the remote control

Programming the remote control code

You can operate other manufacturers' components using this TV's remote control.

Preparation:

- Connect the plug of the external component to the wall outlet.
- Make sure the component is turned off.

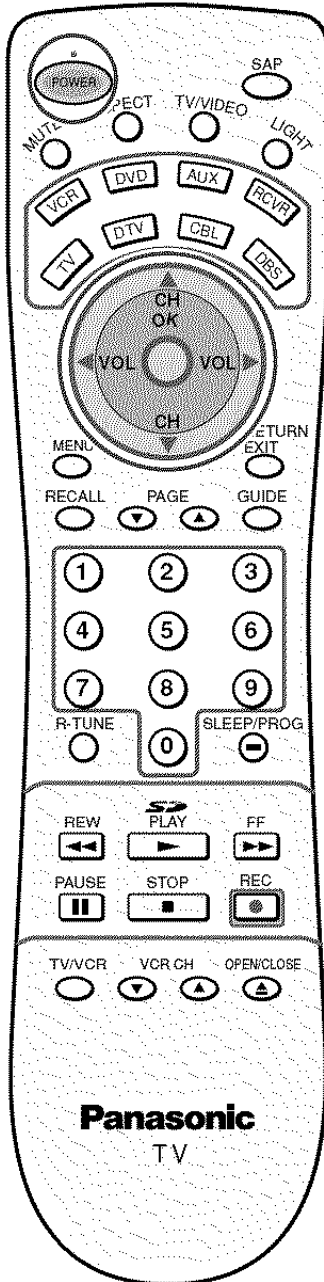

1

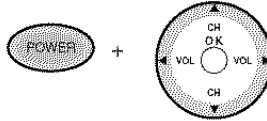

Press and hold **POWER** and **OK** together, for at least **5 seconds**.

- The mode selection buttons flashes, and then release the **POWER** and **OK**.

2

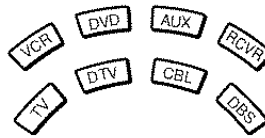

Select the type of the component.

- The selected button light and all others go out.

3

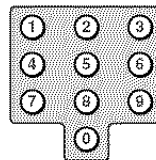

Enter the 3-digit infrared code (see pages 34-36).

- Factory default setting : Panasonic
- Press **POWER** to test the operation.

Notes:

- If the component does not operate with the remote control, repeat the procedure using another code. (Some brands have multiple codes).
- If an incorrect code is entered, or if the procedure takes longer than 30 seconds, the programming will fail.

To find the code not listed in the index

After step 2 above,

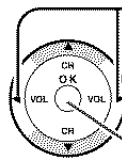

Press to select the code.

- The code starts from the current device.
 - Press **POWER** button to test the operation.
 - Repeat the steps until the component code is found. It may take many attempts before the correct code is found.
- Press to store the code.

Operating peripheral equipment using the remote control

Infrared Code Index

The Universal Remote Control is capable of operating many component brands after entering a code. Some components may not operate because the codes are not available due to limited memory. The Universal Remote Control does not control all features found in each model.

Write the code numbers from tables in this space. This will serve as a reference if you need to program your Remote Control.

VCR □ □ □	DVD □ □ □	DVD (CD) □ □ □	AUX (VCR 2) □ □ □	AUX (TAPE) □ □ □
RECEIVER □ □ □	DTV □ □ □	CABLE □ □ □	DBS □ □ □	

Codes for VCR

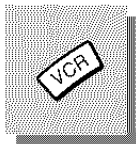

Brand	Code
Admiral	335
Aiwa	332
Akai	314, 315, 316, 329
Audio Dynamic	311, 339
Bell & Howell	305, 313
Broksonic	320, 326
Canon	323, 325
Citizen	306
Craig	305, 306, 329
Curtis Mathes	324, 345
Daewoo	301, 324, 343
DBX	310, 311, 339
Dimensia	345
Emerson	303, 319, 320, 325, 326, 343
Fisher	305, 307, 308, 309, 313
Funai	320, 326, 334
GE	324, 333, 345
Goldstar	306
Gradiente	334
Hitachi	300, 323, 345
Instant Replay	323, 324
Jensen	339
JVC	310, 311, 334, 339
Kenwood	306, 310, 311, 339
LXI	300, 305, 306, 307, 308, 309
Magnavox	323, 324, 331
Marantz	310, 311, 339
Marta	306
Memorex	309, 324
MGA	338, 340, 341, 347, 348
Minolta	300, 345
Mitsubishi	338, 340, 341, 347, 348
Multitech	304, 347
NEC	310, 311, 334, 339
Olympic	323, 324
Optimus	306, 321, 328, 335

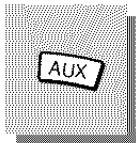

Brand	Code
Orion	320, 326
Panasonic	321, 322, 323, 324
J.C. Penney	300, 305, 310, 311, 324, 339, 345
Pentax	300, 311, 345
Philco	320, 323, 324, 326, 331, 343
Philips	323, 324, 331
Pioneer	323
Proscan	300, 301, 302, 323, 324, 331, 333, 345, 346
Quasar	321, 322, 323, 324
Radio Shack	305, 309, 324, 333, 336, 340
RCA	300, 301, 302, 323, 324, 331, 333, 345, 346
Realistic	305, 309, 324, 336, 340
Samsung	302, 304, 333
Sansui	320, 326, 339, 352
Sanyo	305, 309, 313
Scott	301, 302, 304, 309, 320, 326, 338, 340, 347, 348
Sears	300, 305, 306, 307, 308
Sharp	335, 336
Shintom	317
Signature 2000	335
Singer	317
Sony	328, 329, 330
Sylvania	323, 324, 331
Tashiro	306
Tatung	310, 311, 339
Teac	310, 311, 339
Technics	321, 322, 323, 324
Teknika	324
Toshiba	301, 346
Vector Research	311
Wards	306, 309, 335, 336, 344
Yamaha	305, 310, 311, 339
Zenith	306, 344

Operating peripheral equipment using the remote control

DVD

Codes for DVD

Brand	Code
Denon	100
Ferguson	101
JVC	109
Mitsubishi	105
Nordmende	101
Panasonic	100
Philips	103
Pioneer	102
RCA	101

Brand	Code
Saba	101
Samsung	110
Sharp	108
Sony	104
Technics	100
Thomson	101
Toshiba	103
Yamaha	100
Zenith	107

DVD

Codes for CD

Brand	Code
Admiral	226
Aiwa	233, 235
Carver	229
Denon	242
Emerson	239
Fisher	205
Harman/Kardon	219, 220, 221, 223
Hitachi	207
Jensen	234
JVC	240, 241, 245
Kardon	223
Kenwood	200, 201, 211, 245
LXI/Sears	236
Magnavox	229, 232
Marantz	229
McIntosh	221
Nakamichi	210
Onkyo	214, 215

Brand	Code
Optimus	208, 218, 220, 222
Panasonic	224, 225, 227
Philips	229, 230
Pioneer	208
Quasar	224, 225, 227
RCA	231, 237, 238, 247
Sansui	210, 246
Sanyo	205
Scott	210, 246
Sharp	242, 243
Sherwood	220
Sony	228
Soundesign	244
Teac	212, 216, 218
Technics	224, 225, 227
Victor	240, 241, 245
Yamaha	202, 203, 204

AUX

Codes for Personal Video Recorders

Brand	Code
Panasonic Replay	100
Philips Tivo	101
Sony Tivo	102

AUX

Codes for Cassette Decks

Brand	Code
Aiwa	223, 224, 225
Denon	231
Fisher	203
Jensen	214
JVC	229, 230
Kenwood	200, 207
Marantz	202
Nakamichi	205
Onkyo	208, 209, 213
Panasonic	216, 218

Brand	Code
Philips	222
Pioneer	204
RCA	226, 227, 228
Sansui	205, 210
Sharp	231
Sony	219, 220
Teac	210, 211, 215
Technics	216, 218
Yamaha	201, 202

Operating peripheral equipment using the remote control



Codes for Receivers

Brand	Code
Admiral	120
Aiwa	125, 126
Denon	134, 135, 136
Fisher	104
Garrard	113
Harman Kardon	115, 123
Jensen	129
JVC	132, 133
Kenwood	100, 108
Magnavox	127
Marantz	124
McIntosh	116
Nakamichi	106
Onkyo	109, 114

Brand	Code
Optimus	103, 127, 130, 131
Panasonic	118, 119, 121
Philips	123
Pioneer	105, 107
Quasar	118, 119, 121
RCA	103, 105, 127, 130, 131
Sansui	103, 111, 139
Sharp	134, 137
Sony	122
Soundesign	138
Teac	111, 112, 113
Technics	118, 119, 121
Victor	132, 133
Yamaha	101, 102



Codes for Cable Box

Brand	Code
ABC	124
Archer	125, 132
Cableview	105, 132
Citizen	105, 122
Curtis	112, 113
Diamond	124, 125, 132
Eagle	129
Eastern	134
GC Brand	105, 132
Gemini	122
General Instrument/Jerrold	111, 119, 120, 121, 122, 123, 124, 125, 126, 127
Hamlin	112, 118, 140, 141, 142, 145
Hitachi	103, 124
Macom	103, 104, 105
Magnavox	133
Memorex	130
Movietime	105, 132
Oak	102, 137, 139
Panasonic	109, 110, 114
Philips	106, 107, 128, 129, 130
Pioneer	101, 116
Pulsar	105, 132

Brand	Code
Puser	132
RCA	115
Realistic	132
Regal	112, 118, 140, 141, 142, 145
Regency	134
Rembrandt	105, 132, 137
Samsung	105
Scientific Atlanta	111, 112, 113
Silmark	101, 105
Sprucer	105, 110
Stargate	105, 132
Tel eview	101, 105
Texscan	144
Tocom	135
Toshiba	104
Unika	125, 132
Universal	122, 132
Videoway	106
Viewstar	129, 130
Zenith	100, 117
Zenith /Drae Satellite	100

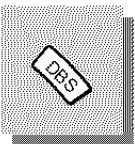

Codes for DBS















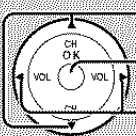

Brand	Code
Dish Network	105, 115, 116
Echo Star (Echostar)	105
Express VU	105, 115
G.E.	106
G.I. (General Instrument)	108
Gradiente	114
Hitachi	103, 111, 112
HNS (Hughes)	103

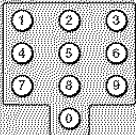
Brand	Code
Magnavox	101, 102
Panasonic	104
Philips	101, 102
Primestar	108
Proscan	106, 109, 110, 113
RCA	106, 109, 110, 113
Sony	107
Star Choice	103, 108
Toshiba	100
Uniden	101, 102

Operating peripheral equipment using the remote control

Mode Operational Key Chart

This chart defines which keys are operational after programming (if needed), while in the selected remote control mode DTV, CABLE, DBS, VCR, DVD ...etc.

KEY NAME	DTV MODE	CABLE MODE	DBS MODE	VCR MODE
	DTV POWER	CABLE POWER	DBS POWER	VCR POWER
	DTV SAP	-	-	-
	TV MUTE	CABLE MUTE	TV MUTE	TV MUTE
	DTV ASPECT	-	DBS ASPECT	-
	TV INPUT SW	TV INPUT SW	TV INPUT SW	TV INPUT SW
	REMOTE BUTTONS	REMOTE BUTTONS	REMOTE BUTTONS	REMOTE BUTTONS
	-	CABLE CH UP/DOWN	DBS NAVIGATION UP/DOWN	VCR CH UP/DOWN
	DTV ACTION	CABLE ENTER	DBS ACTION	TV ACTION
	DTV NAVIGATION LEFT/ RIGHT	CABLE VOL -/+	DBS NAVIGATION LEFT/RIGHT	TV VOLUME -/+
	STB MENU	-	STB MENU	-
	STB PROGRAM INFO	TV DISPLAY	STB PROG. INFO	ONSCREEN VCR DISPLAY
	DTV EXIT (EPG)ELECTRONIC PROGRAM GUIDE	-	STB EXIT	-
	STB PAGE DOWN/ UP	-	STB PAGE DOWN/UP	-
	STB GUIDE (EPG)ELECTRONIC PROGRAM GUIDE	-	DBS PROGRAM GUIDE	-
	Select STB Channel	Select CABLE Channel	Select DBS Channel	Select VCR Channel
	PREVIOUS DTV CH	CABLE PREVIOUS	STB PREVIOUS	-
	DTV PROGRAM/DASH	-	STB PROGRAM/DASH	-
	-	-	-	VCR REW/FF
	-	-	-	VCR PLAY
	-	-	-	VCR PAUSE
	-	-	-	VCR STOP
	-	VCR RECORD	STB RECORD	VCR RECORD
	-	-	STB/DTV/SAT SW	TV/VCR SW
	-	CABLE CH DOWN/UP	STB CH DOWN/UP	VCR CH DOWN/UP
	-	-	STB SEARCH	-

Operating peripheral equipment using the remote control

KEY NAME	DVD MODE		AUX MODE			RCVR MODE
	(DVD)	(CD)	(VCR2)	(PVR)	(TAPE)	
	DVD POWER	CD POWER	VCR POWER	PVR POWER	TAPE POWER	RCVR POWER
	-	-	-	-	-	-
	TV MUTE	RCVR MUTE	TV MUTE	TV MUTE	RCVR MUTE	RCVR MUTE
	-	-	-	-	-	-
	TV INPUT SW	TV INPUT SW	TV INPUT SW	TV INPUT SW	TV INPUT SW	RCVR INPUT SW
	REMOTE BUTTONS	REMOTE BUTTONS	REMOTE BUTTONS	REMOTE BUTTONS	REMOTE BUTTONS	REMOTE BUTTONS
	NAVIGATION UP/DOWN	NEXT/PREVIOUS TRACK	VCR CH UP/DOWN	NAVIGATION UP/DOWN	-	TUNER -/+
	DVD SELECT	-	TV ACTION	-	-	-
	NAVIGATION LEFT/RIGHT	TV/RCVR VOLUME DOWN/UP	TV VOLUME -/+	NAVIGATION LEFT/RIGHT	RCVR VOLUME -/+	RCVR VOLUME -/+
	DVD MENU	-	-	PVR MENU	-	-
	DVD DISPLAY	TIME FORMAT	ON SCREEN VCR DISPLAY	-	-	-
	-	-	-	EXIT PVR MENU	-	-
	DVD SKIP -/+	CD SKIP -/+	-	-	-	-
	DVD TITLE	-	-	-	-	-
	Select DVD Number	Select CD Track Number	Select VCR Channel	Select PVR Channel	-	1.... AV1 2.... AV2 3.... AV3 4.... AV4 5.... CD 6.... TUNER 7.... PHONO 8.... TAPE 9.... AUX
	-	-	-	PREVIOUS PVR CH/ RELAY ZONES	DECK A/B	-
	-	-	-	PVR RETURN TO LIVE	-	-
	SKIP SEARCH REW/FF	SEARCH REW/FF	VCR REW/FF	-	TAPE REW/FF	SURROUND -/+
	DVD PLAY	CD PLAY	VCR PLAY	PVR PLAY	TAPE PLAY	-
	DVD PAUSE	CD PAUSE	VCR PAUSE	PVR PAUSE	TAPE PAUSE	-
	DVD STOP	CD STOP	VCR STOP	-	TAPE STOP	-
	-	-	VCR RECORD	PVR RECORD	TAPE RECORD	-
	-	-	TV/VCR SW	-	-	-
	DVD SLOW -/+	RANDOM/REPLAY	VCR CH DOWN/UP	PVR CH DOWN/UP	-	CENTER -/+
	DVD OPEN/CLOSE	CD OPEN/CLOSE	-	PVR QUICK SKIP	TAPE OPEN/CLOSE	-

Manuel de instrucciones [Resumen]

Estimado cliente de Panasonic

Bienvenido a la familia de clientes de Panasonic.

Esperamos sinceramente que disfrute durante muchos años de su nuevo televisor LCD.

Para obtener el máximo beneficio de su aparato, lea estas instrucciones antes de hacer cualquier ajuste, y guárdelas para poder utilizarlas como referencia en el futuro.

Guarde también el recibo de su compra, y anote el número del modelo y el número de serie de su aparato en el espacio provisto en la cubierta posterior de estas instrucciones.

Instalación de las pilas del mando a distancia

Se necesitan dos pilas AA.

1. Abra la cubierta de las pilas.
2. Instale las pilas. Tenga en cuenta las polaridades (+ y -) al instalar las pilas.
3. Vuelva a colocar la cubierta.

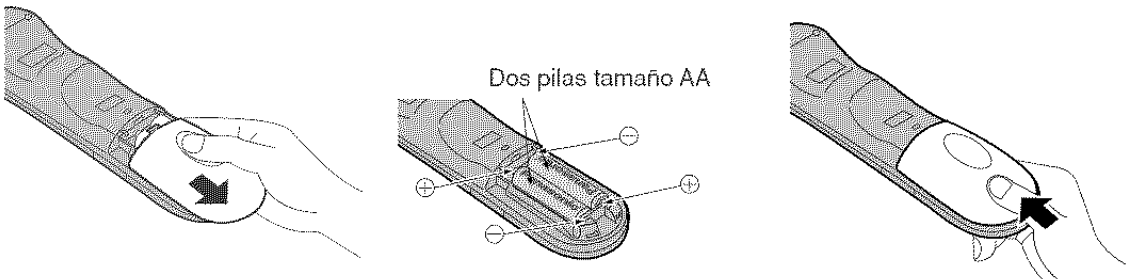

⚠ Precauciones relacionadas con la utilización de las pilas

La instalación incorrecta de las pilas puede causar fugas en las mismas que podrían estropear el transmisor de mando a distancia.

1. Utilice siempre pilas nuevas cuando reemplace las viejas.
2. No intente cargar, cortocircuitar, desarmar, calentar o quemar las pilas usadas.
3. El cambio de las pilas resulta necesario cuando el mando a distancia funciona esporádicamente o no puede controlar esta unidad.

Conexión

Nota:

Otras conexiones (consulte las páginas 9-11).

Extracción e instalación de la tapa del cable

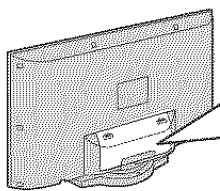

Extracción



1. Presione en los ganchos hacia abajo y tire suavemente de la tapa hacia usted para soltar las garras (en 4 puntos).
2. Tire de la tapa lentamente hacia abajo.

Instalación

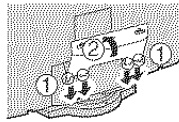

1. Inserte las garras (en 4 puntos) en el extremo de la parte superior.
2. Empuje la cubierta hasta que los ganchos hagan un ruido seco.

Nota:

Para evitar que aparezcan interferencias en la pantalla, separe el cable de RF y el cable de alimentación.

Conexión de antena

Para recibir correctamente los canales de VHF / UHF se requiere una antena externa. Para obtener la mejor recepción se recomienda utilizar una antena para exteriores. El modo de antena debe ajustarse a TV (consulte la página 48, MODO).

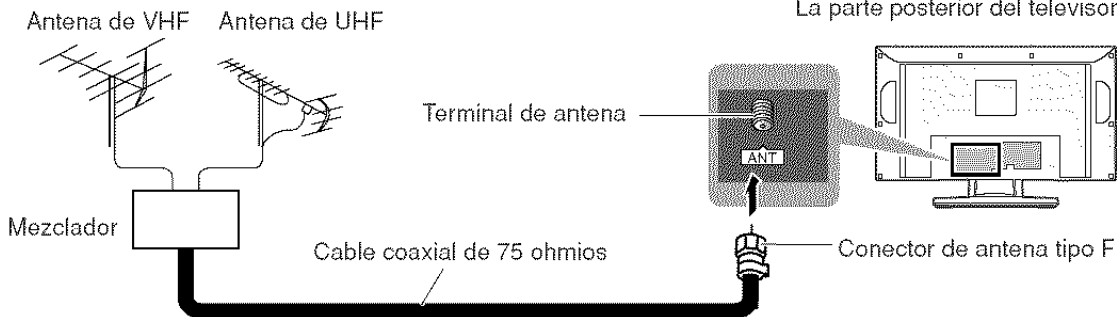

■ Conexión de cable / antena

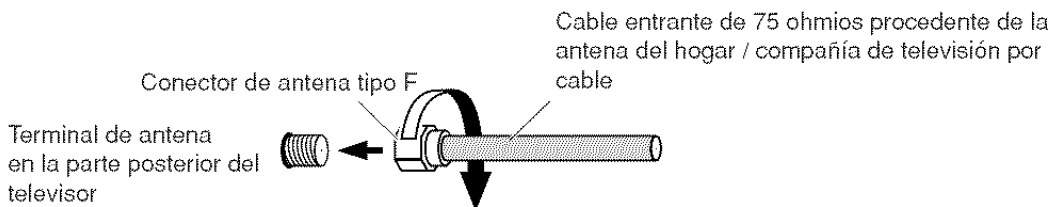

Conexión del receptor de TV por cable

- Para recibir los canales de televisión por cable (01 - 125) conecte el cable suministrado por su compañía de televisión por cable. El modo de antena debe ajustarse a CABLE (consulte la página 48, MODO).
- Ciertos sistemas de televisión por cable neutralizan algunos canales para reducir interferencias o tienen canales especiales (codificados). Para recibir correctamente estos canales se necesita un sintonizador de conversión de televisión por cable. Póngase en contacto con su compañía de televisión por cable para conocer los requerimientos de compatibilidad.
- Ponga el canal del televisor en CH3 o CH4 cuando utilice esta conexión.

Receptor de TV por cable

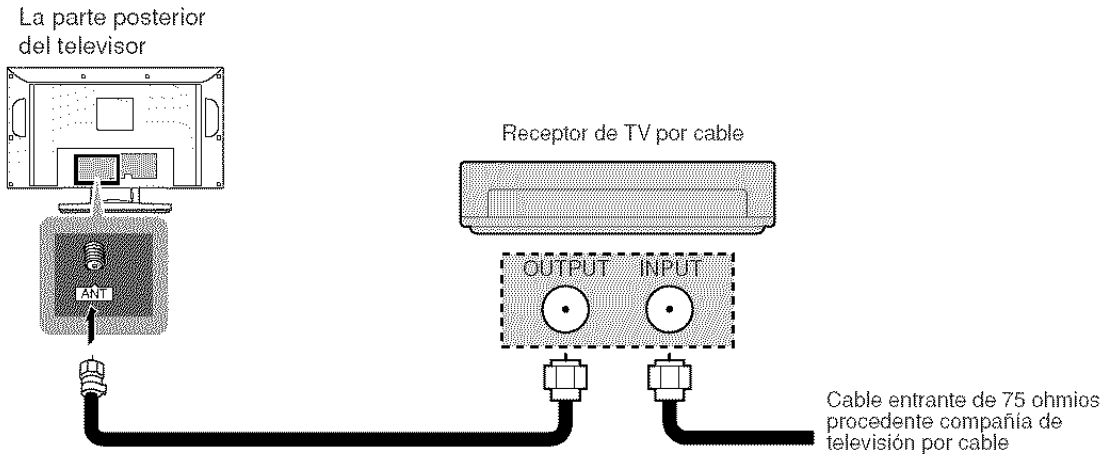

Receptor de TV por cable y Videograbadora

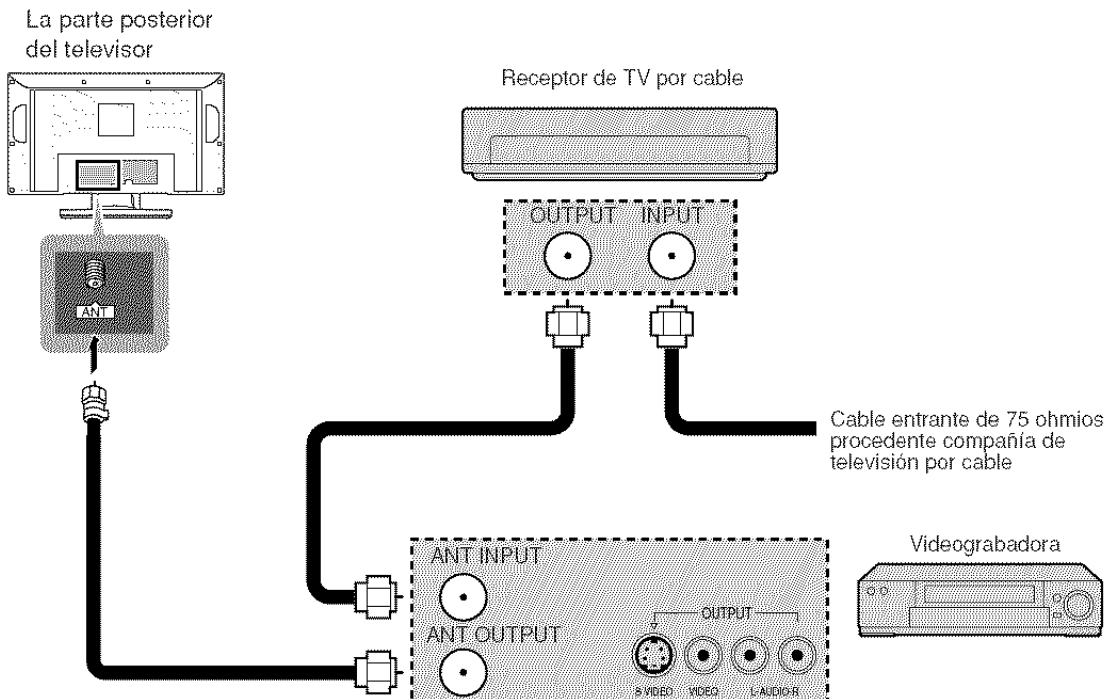

Controles básicos

Control remoto iluminado

Botón de la alimentación

Púselo para encender o apagar el televisor (consulte la página 44).

Nota:

Esto no funciona cuando la alimentación principal está desconectada (apagado).

Botón MUTE

Púselo para silenciar el sonido.

Púselo de nuevo para cancelar el silenciamiento.

El silenciamiento se cancela cuando se desconecta la alimentación o se cambia en nivel del sonido.

Botones de selección de modo

(consulte la página 33)

Botón MENU

(consulte la página 46)

Botón RECALL

Púselo para visualizar el número del canal, el temporizador de cancelado y otras opciones.

Botón R-TUNE

Púselo para cambiar a un canal visto previamente o para cambiar entre el modo del televisor y otro modo de entrada.

Botón SD

Púselo para acceder Photo Viewer™ (consulte la página 45)

Funcionamiento de otro dispositivo

(consulte las páginas 37, 38)

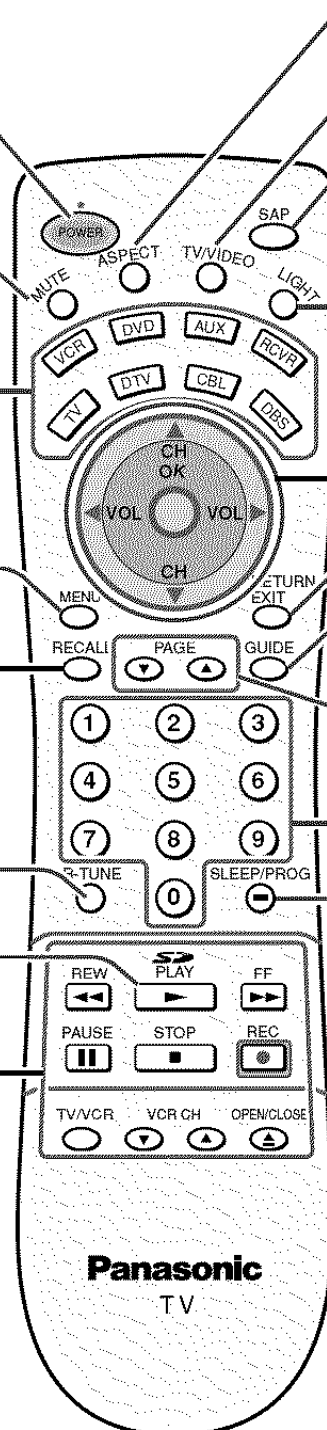

Botón ASPECT



Botón TV/VIDEO

Púlselo para cambiar el modo de entrada.

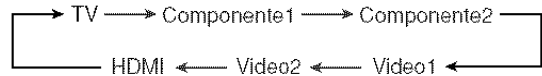

Botón SAP

Púlselo para seleccionar el modo de audio. También puede cambiar el modo en la pantalla MENU (consulte la página 46).

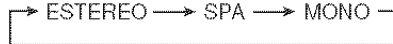

Botón LIGHT

Enciende los botones del control remoto. El botón seleccionado parpadea cuando está encendida esta luz.

Botón RETURN

Return to previous MENU (modo de TV).

Botón EXIT

EXIT from menu (modo de DTV, STB o PVR).

Botón GUIDE (modo de DBS)

Botón PAGE

Subida / bajada de página (modo de DBS).

Salto + / - (modo de DVD y CD).

Botones numerados

Botón SLEEP (modo de TV)

Ponga el tiempo tras el cual el televisor se pondrá en el modo de espera.



- Cuando queden 3 minutos parpadeará " 3" ("2" para 2 minutos y "1" para 1 minuto).
- El temporizador de cancelado se cancelará cuando se desconecte la alimentación.

Botón PROG – (modo de DBS o DTV)

Cuando se sintonicen canales digitales, presione el botón para introducir el número menor en un número de canal complejo.

- Para introducir el número del canal
Ej.: CH 15-1: [1] → [5] → [-] → [1] → [OK]

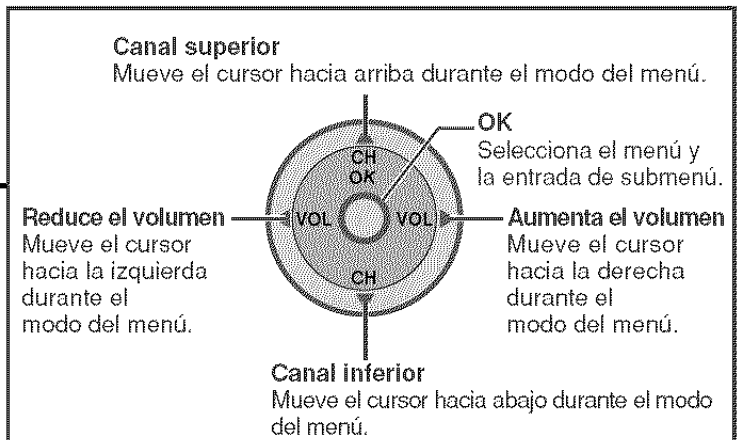

Aparato principal

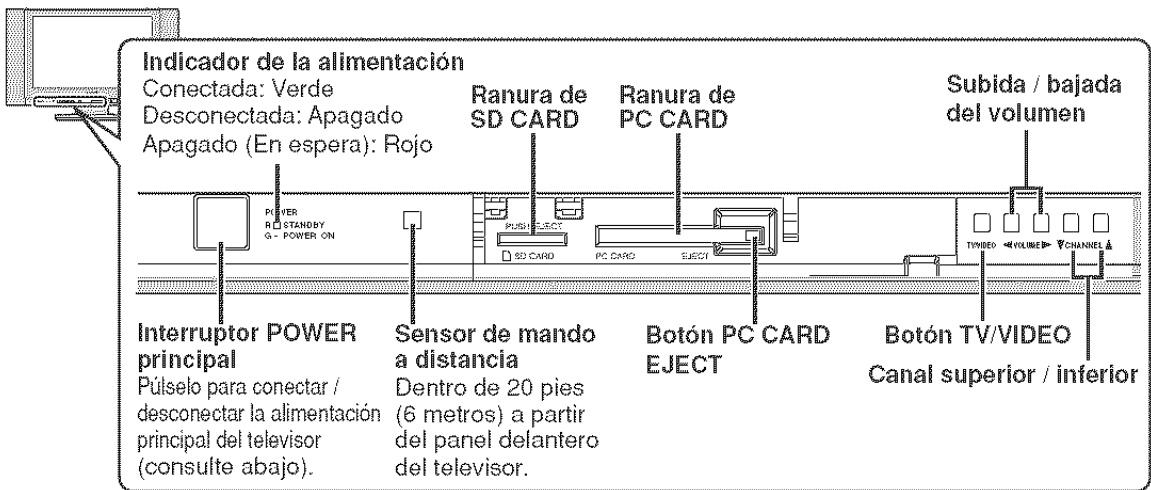

Conexión / desconexión de la alimentación

Preparación

Conecte el enchufe al tomacorriente.

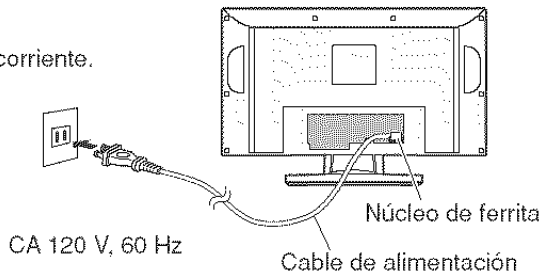

Notas:

- El televisor consumirá algo de corriente siempre que el enchufe del cable de alimentación esté introducido en la toma de corriente.
- Por motivos de seguridad, no quite ni deslice el núcleo de ferrita.

En el aparato principal



Púselo para conectar / desconectar la alimentación principal del televisor.

- Indicador de la alimentación
Conectada: Verde
Desconectada: Apagado

En el mando a distancia



Púselo para encender / apagar el televisor.

- Indicador de la alimentación
Encendido: Verde
Apagado (En espera): Rojo
- Esto no funciona cuando la alimentación principal está desconectada (apagado) (consulte arriba).

Nota:

- La pantalla de abajo se visualiza durante unos momentos cuando se enciende el televisor.

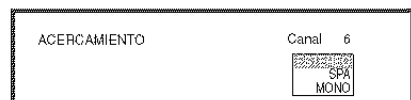

Nota:

- Seleccione el idioma de menú antes de utilizar el televisor (consulte la página 47, Idioma).

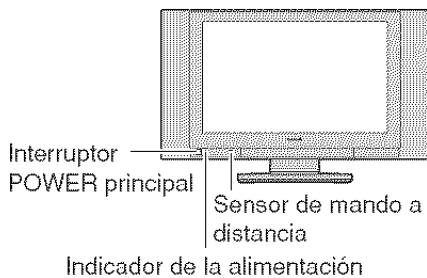

Indicador de la alimentación

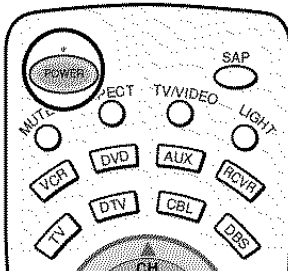

Photo Viewer™

Photo Viewer™ le permite mostrar imágenes JPEG grabadas mediante una cámara digital en una tarjeta SD o en otro tipo de tarjeta de memoria cuando ésta se introduce en la ranura correcta.

Mode de imagen miniatura

La pantalla de imagen miniatura es la pantalla de entrada inicial desde el menú principal.

- Cuando se introduzcan las tarjetas SD y PCMCIA, el televisor reproducirá la tarjeta SD. Para reproducir una tarjeta PCMCIA, seleccione "PC" en "Card" (Tarjeta) del Setup Menu después de introducir la tarjeta PCMCIA.

1 Introduzca la tarjeta en la ranura apropiada (vea las página 17).



Press to display the thumbnail screen.

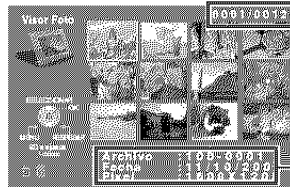

Número de imagen/Número total de imágenes

Nombre de archivo, la fecha y los píxeles (resolución) de la imagen

Notas:

- Si hay muchos archivos o el tamaño del archivo es grande se puede tardar más tiempo en mostrar la imagen miniatura.
- La imagen desaparece de la pantalla mientras Photo Viewer™ accede a la información de la tarjeta. Después de acceder a las imágenes de la tarjeta se muestra una pantalla de imagen miniatura.

2

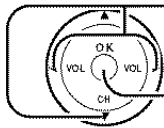

Seleccione la imagen miniatura.

Presione para visualizar la imagen en el modo de visión de una sola imagen.

3

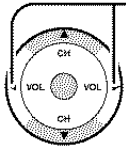

Presione para seleccionar la imagen siguiente o la anterior.

- Presione OK para volver a la pantalla de imagen miniatura.

Modo de visión de una sola imagen

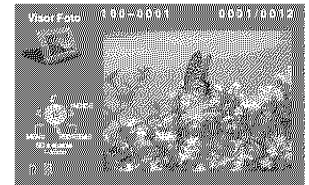

Para girar la imagen

Mientras está en el modo de visión de una sola imagen

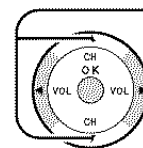

Presione para girar la imagen noventa grados.

■ Setup Menu (Menú de programación) de Photo Viewer™

En el modo de imagen miniatura o en el modo de visión de una sola imagen



Presione para mostrar la pantalla Setup Menu (Menú de programación).



Operaciones con menús

1

Púlselo para visualizar la pantalla MENU.

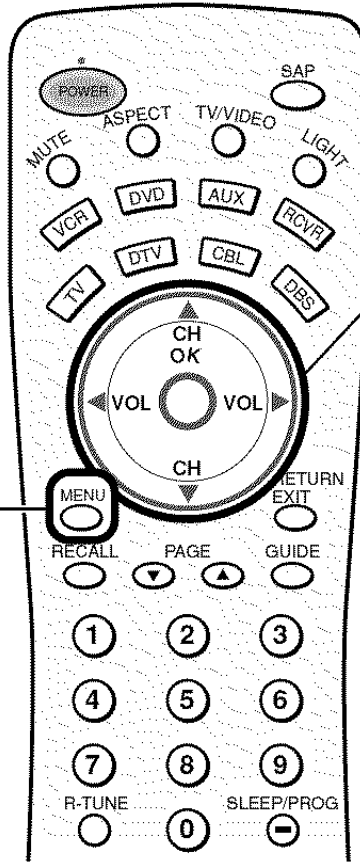
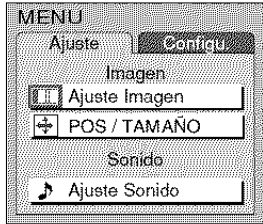

2

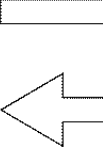
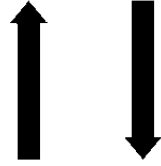
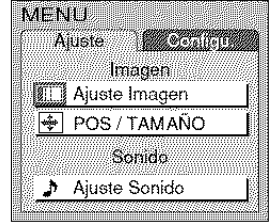

Cuadro de instrucciones de ayuda en pantalla

Cuando se visualiza un menú en el televisor aparece un cuadro de ayuda en la pantalla. Este cuadro de ayuda indica qué teclas del mando a distancia se utilizan para navegar por el menú mostrado.

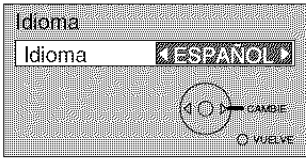

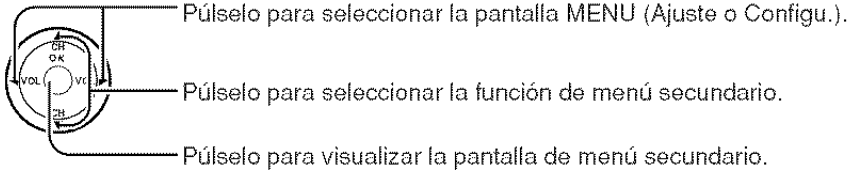

- Para volver a la pantalla anterior : RETURN
EXIT
- Para salir de la pantalla MENU : MENU

Con esto se retorna a la visión normal.

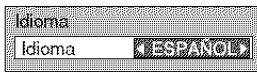
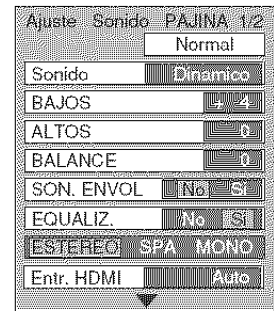
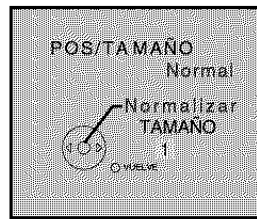
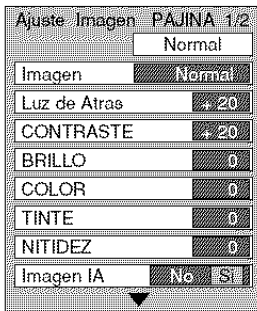

Seleccione el idioma del menú.

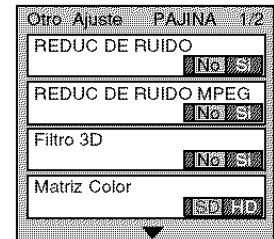
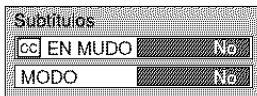
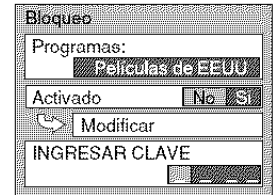
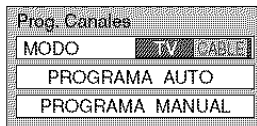
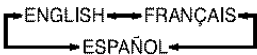

Sintonización de canales

1 Pulse el botón TV/VIDEO para visualizar el canal de TV.

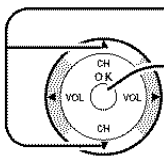
2  Pulse para seleccionar Prog. Canales.
Pulse para visualizar la pantalla Prog. Canales.

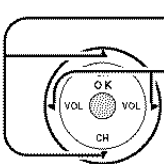

3  Pulse para seleccionar MODO.
Pulse para seleccionar TV o CABLE.

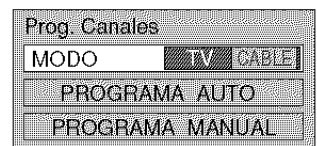

Programación automática de canales

Explora y guarda automáticamente todos los canales de TV.

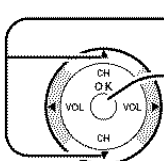
4  Pulse para seleccionar PROGRAMA AUTO.
Púlselo para visualizar la pantalla PROGRAMA AUTO.

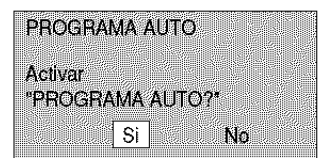

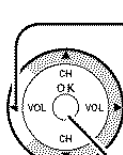
5  Pulse para seleccionar Si.
Púlselo para iniciar PROGRAMA AUTO.
Los canales avanzarán automáticamente hasta que todos ellos hayan sido explorados. Los números de los canales con señal de vídeo recibida se guardarán en la memoria de canales.

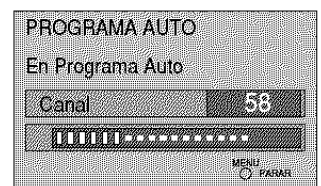

Notas:

- Cuando se pulse cualquier botón durante PROGRAMA AUTO, el televisor volverá a mostrar la imagen normal. (Los canales encontrados hasta ese punto se añaden.)
- Después de terminar PROGRAMA AUTO se visualizará el número del canal más bajo añadido.
- Cuando no haya canales que puedan recibirse, se visualizará el canal 69 (para TV) o el canal 125 (para TV por cable).

Programación automática de canales

Añada o borre un canal manualmente.

4

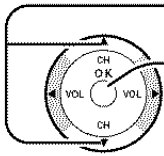

Pulse para seleccionar PROGRAMA MANUAL.
Pulse para visualizar la pantalla PROGRAMA MANUAL.

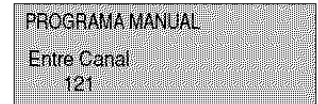
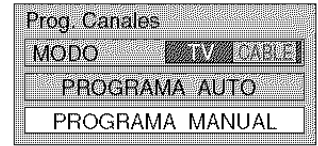

5

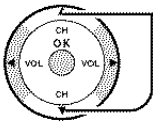

Pulse para seleccionar canal.
• También puede utilizar los botones numerados.

6

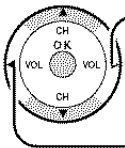









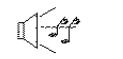

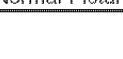

Púselo para añadir el canal a la memoria de canales (el número del canal se pone de color azul).

Púselo para borrar el canal de la memoria de canales (el número del canal se pone amarillo).
• Repita los pasos 5 y 6 para otros canales.

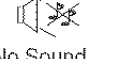
Troubleshooting

If there is a problem with your TV please refer to the table below to determine the symptoms, then carry out the suggested check. If this does not solve the problem, please contact your local Panasonic dealer, quoting the model number and serial number (both found on the rear of the TV).

Symptoms		Checks
Picture	Sound	
 Snowy Picture	 Noisy Sound	Antenna location, direction or connection.
 Multiple Image	 Normal Sound	Aerial location, direction or connection.
 Interference	 Noisy Sound	Electrical appliances. Cars / Motorcycles. Fluorescent lights.
 Normal Picture	 No Sound	Volume level. Sound mute switched on.
 No Picture	 No Sound	TV set to AV mode. Not plugged into AC outlet. Not switched on. Picture / Sound controls set at minimum levels. Check if in Standby mode. Make sure that a PC is not connected to HDMI input. The TV may not display video in HDMI input from devices with HDMI or DVI output due to bad communication between the TV and the devices. Should this happen, unplug the HDMI/DVI device and plug it back on.
 No Colour	 Normal Sound	Color controls set at minimum levels. Weak signal.
 Poor or Distorted Picture	 Weak or No Sound	Retune Channel (s).
 Normal Picture	 Weak Wrong or No Sound	Sound reception may have deteriorated. Switch STEREO mode (AUDIO ADJUST menu) to Off until reception improves. Change the audio of the HDMI device to Linear PCM. Check the audio setting for HDMI. If there is functional problem with Digital Audio, use Analog audio.
Cannot operate with the remote control.		The battery is exhausted. The battery's polarity is wrong. The remote control sensor is exposed to strong light of a fluorescent lamp, etc.
The main unit is hot.		The main unit radiates heat and some of the parts may become hot. This is not a problem for performance or quality. Set up at a location with good ventilation. Do not cover the ventilation holes of the TV with a tablecloth etc., and do not place on top of other equipment.
There may be red spots, blue spots, green spots and black spots on the screen.		This is a characteristic of liquid crystal panels and is not a problem. The liquid crystal panel is built with very high precision technology giving you fine picture details. Occasionally, a few non-active pixels may appear on the screen as a fixed point of red, blue, green, or black. Please note this does not affect the performance of your LCD.
HDMI	Poor Video. (Snow noise, no picture, picture runs, etc.)	HDMI cable is not connected securely. Turn the power supply of the TV set and connected equipment OFF then turn on. Check compatibility of input signal from the connected equipment. The connected equipment must be EIA/CEA-861/861B compliant.
	Poor Audio.	Change the audio setting of the connected equipment to L.PCM. Check the setting of HDMI INPUT. If the problem is due to the digital audio connection, change to the analog audio connection.

Specifications

	TC-26LX20	TC-32LX20
Power Source	AC 120 V, 60 Hz	
Power Consumption	Average use : 133 W (Maximum Current 1.7 A) Stand-by condition : 0.4 W	Average use : 164 W (Maximum Current 2.2 A) Stand-by condition : 0.4 W
LCD	26-inch (661mm) 16:9 aspect ratio LCD panel	32-inch (802mm) 16:9 aspect ratio LCD panel
Screen Size (W × H × diagonal)	22.30 " × 13.38 " × 26.00 " (556.4 mm × 339.8 mm × 660.5 mm)	27.06 " × 16.24 " × 31.56 " (687.4 mm × 412.4 mm × 801.6 mm)
Channel Capability	VHF-12 : UHF-56 : Cable-125	
Sound		
Speakers	Φ 8 cm × 2 pcs, Φ 4 cm × 2 pcs, 8 Ω	
Headphones	M3 (3.5 mm) Jack × 1	
FEATURES	CLOSED CAPTION, V-Chip, SD / PC card slots	
Operating Conditions	Temperature : 41 °F - 95 °F (5 °C - 35 °C) Humidity : 5 % - 90 % RH (non-condensing)	
Connection Terminals		
INPUT	VIDEO (RCA PIN Type × 1) × 2	1.0 Vp-p (75 Ω)
	S-VIDEO (MINI DIN 4pin × 1) × 2	Y : 1 Vp-p (75 Ω), C : 0.286 Vp-p (75 Ω)
	AUDIO L-R (RCA PIN Type × 2) × 2	0.5 Vrms
COMPONENT VIDEO INPUT	Y × 2	1.0 Vp-p (including synchronization)
	P _B / P _R × 2	±0.35 Vp-p
OUTPUT	AUDIO L-R (RCA PIN Type × 2) × 2	0.5 Vrms
	AUDIO L-R (RCA PIN Type × 2) × 1	0.5 Vrms
HDMI	HDMI TYPE A Connector × 1	
	AUDIO L-R (RCA PIN Type × 2) × 1	0.5 Vrms
Dimensions (W × H × D)		
Including TV Stand	33.23 " × 22.51 " × 12.64 " (844 mm × 571.8 mm × 321 mm)	39.37 " × 25.66 " × 12.64 " (1000 mm × 651.7 mm × 321 mm)
TV Set Only	33.23 " × 18.82 " × 5.39 " (844 mm × 478 mm × 137 mm)	39.37 " × 21.97 " × 5.39 " (1000 mm × 558 mm × 137 mm)
Mass (Weight)	22.8 kg (59.2 lb.) NET	27.3 kg (60.1 lb.) NET

Note:

Design and Specifications are subject to change without notice. Weight and Dimensions shown are approximate.

Maintenance

To clean this unit, wipe with a soft, dry cloth.

If the surfaces are extremely dirty, use a soft cloth dipped in a soap and water solution or a weak detergent solution.

- Use eyeglass cleaner to remove stubborn dirt from the LCD.
- Never use alcohol, paint thinner or benzine to clean this unit.
- Before using a chemically treated cloth, read the instructions that came with the cloth carefully.

CAUTION :

If water or other liquid enters the monitor through the display panel surface, a malfunction may occur.

Mild detergent

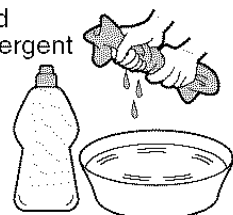

Customer's Record

The model number and serial number of this product can be found on its rear panel. You should note this serial number in the space provided below and retain this book, plus your purchase receipt, as a permanent record of your purchase to aid in identification in the event of theft or loss, and for Warranty Service purposes.

Model Number _____

Serial Number _____

**Panasonic Consumer Electronics
Company, Division of Matsushita
Electric Corporation of America**
One Panasonic Way Secaucus
New Jersey 07094

**Panasonic Sales Company,
Division of Matsushita Electric
of Puerto Rico Inc. ("PSC")**
Ave. 65 de Infanteria, Km 9.5
San Gabriel Industrial Park,
Carolina, Puerto Rico 00985

Panasonic Canada Inc.
5770 Ambler Drive
Mississauga, Ontario
L4W 2T3