

Panasonic®

Operating Instructions DVD Home Theater Sound System

Model No. **SC-PT650**

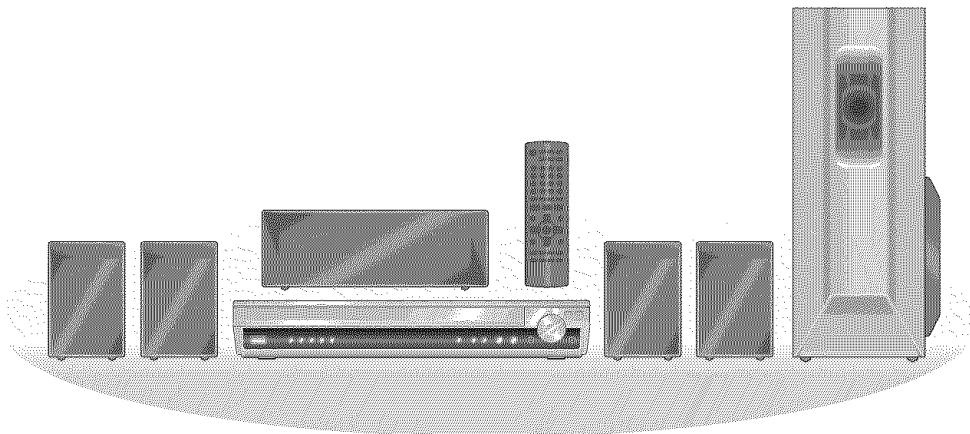

Region number

The player plays DVD-Video marked with labels containing the region number "1" or "ALL".

Example:



Wireless-ready surround sound

Optional wireless surround
speaker connection.

4

High-quality picture

HDMI capability, Advanced
progressive scan and more.

6

XM® Satellite Radio

Enjoy a variety of digital radio
channels.

28



As an ENERGY STAR® Partner,*
Panasonic has determined that
this product meets the ENERGY STAR®
guidelines for energy efficiency.

* For Canada only: The word "Participant" is used in place of the word "Partner".

Before connecting, operating or adjusting this product, please
read the instructions completely.
Please keep this manual for future reference.

If you have any questions contact
In the U.S.A.: 1-800-211-PANA (7262)
In Canada: 1-800-561-5505

Dear customer

Thank you for purchasing this product. For optimum performance and safety, please read these instructions carefully.

Operations in these instructions are described mainly with the remote control, but you can perform the operations on the main unit if the controls are the same.

System	SC-PT650
Main unit	SA-PT650
Front speakers	SB-HF650
Center speaker	SB-HC750
Surround speakers	SB-HS650
Subwoofer	SB-HW750

CAUTION!

THIS PRODUCT UTILIZES A LASER. USE OF CONTROLS OR ADJUSTMENTS OR PERFORMANCE OF PROCEDURES OTHER THAN THOSE SPECIFIED HEREIN MAY RESULT IN HAZARDOUS RADIATION EXPOSURE. DO NOT OPEN COVERS AND DO NOT REPAIR YOURSELF. REFER SERVICING TO QUALIFIED PERSONNEL.

WARNING:

TO REDUCE THE RISK OF FIRE, ELECTRIC SHOCK OR PRODUCT DAMAGE,
● DO NOT EXPOSE THIS APPARATUS TO RAIN, MOISTURE, DRIPPING OR SPLASHING AND THAT NO OBJECTS FILLED WITH LIQUIDS, SUCH AS VASES, SHALL BE PLACED ON THE APPARATUS.
● USE ONLY THE RECOMMENDED ACCESSORIES.
● DO NOT REMOVE THE COVER (OR BACK); THERE ARE NO USER SERVICEABLE PARTS INSIDE. REFER SERVICING TO QUALIFIED SERVICE PERSONNEL.

THE FOLLOWING APPLIES ONLY IN THE U.S.A.

FCC Note:

This equipment has been tested and found to comply with the limits for a Class B digital device, pursuant to Part 15 of the FCC Rules. These limits are designed to provide reasonable protection against harmful interference in a residential installation. This equipment generates, uses and can radiate radio frequency energy and, if not installed and used in accordance with the instructions, may cause harmful interference to radio communications. However, there is no guarantee that interference will not occur in a particular installation. If this equipment does cause harmful interference to radio or television reception, which can be determined by turning the equipment off and on, the user is encouraged to try to correct the interference by one or more of the following measures:

- Reorient or relocate the receiving antenna.
- Increase the separation between the equipment and receiver.
- Connect the equipment into an outlet on a circuit different from that to which the receiver is connected.
- Consult the dealer or an experienced radio/TV technician for help.

Any unauthorized changes or modifications to this equipment would void the user's authority to operate this device.

This device complies with Part 15 of the FCC Rules. Operation is subject to the following two conditions: (1) This device may not cause harmful interference, and (2) this device must accept any interference received, including interference that may cause undesired operation.

Responsible Party:
Panasonic Corporation of North America
One Panasonic Way
Secaucus, NJ 07094

Support Contact:
Panasonic Consumer Electronics Company
Telephone No.: 1-800-211-7262



CAUTION: TO REDUCE THE RISK OF ELECTRIC SHOCK, DO NOT REMOVE SCREWS. NO USER-SERVICEABLE PARTS INSIDE. REFER SERVICING TO QUALIFIED SERVICE PERSONNEL.



The lightning flash with arrowhead symbol, within an equilateral triangle, is intended to alert the user to the presence of uninsulated "dangerous voltage" within the product's enclosure that may be of sufficient magnitude to constitute a risk of electric shock to persons.



The exclamation point within an equilateral triangle is intended to alert the user to the presence of important operating and maintenance (servicing) instructions in the literature accompanying the appliance.

IMPORTANT SAFETY INSTRUCTIONS

Read these operating instructions carefully before using the unit. Follow the safety instructions on the unit and the applicable safety instructions listed below. Keep these operating instructions handy for future reference.

- 1) Read these instructions.
- 2) Keep these instructions.
- 3) Heed all warnings.
- 4) Follow all instructions.
- 5) Do not use this apparatus near water.
- 6) Clean only with dry cloth.
- 7) Do not block any ventilation openings. Install in accordance with the manufacturer's instructions.
- 8) Do not install near any heat sources such as radiators, heat registers, stoves, or other apparatus (including amplifiers) that produce heat.
- 9) Do not defeat the safety purpose of the polarized or grounding-type plug. A polarized plug has two blades with one wider than the other. A grounding-type plug has two blades and a third grounding prong. The wide blade or the third prong are provided for your safety. If the provided plug does not fit into your outlet, consult an electrician for replacement of the obsolete outlet.
- 10) Protect the power cord from being walked on or pinched particularly at plugs, convenience receptacles, and the point where they exit from the apparatus.
- 11) Only use attachments/accessories specified by the manufacturer.
- 12) Use only with the cart, stand, tripod, bracket, or table specified by the manufacturer, or sold with the apparatus. When a cart is used, use caution when moving the cart/apparatus combination to avoid injury from tip-over.
- 13) Unplug this apparatus during lightning storms or when unused for long periods of time.
- 14) Refer all servicing to qualified service personnel. Servicing is required when the apparatus has been damaged in any way, such as power-supply cord or plug is damaged, liquid has been spilled or objects have fallen into the apparatus, the apparatus has been exposed to rain or moisture, does not operate normally, or has been dropped.



TABLE OF CONTENTS

Getting Started



IMPORTANT SAFETY INSTRUCTIONS 2

Simple Setup

step 1 Positioning 4

Speaker installation options 5

step 2 Cable connections 6

- Audio and video connections 6
- Speaker connections 7
- Radio antenna connections 7

step 3 iPod® connection 8

step 4 AC cord connection 8

step 5 Preparing the remote control 9

step 6 Performing QUICK SETUP 9

Control reference guide 10

Discs that can be played 12

Maintenance 13



Playing Discs



Basic play 14

- Using the main unit 14
- Using the remote control 15

Convenient functions 16

- Checking and selecting the disc 16
- Displaying current playback condition 16
- Playing CDs sequentially 16
- Program and Random play 17

Playing data discs using navigation menus . . 18

- Playing data discs 18
- Selecting a track using CD text 18
- Playing HighMAT™ discs 19
- Playing RAM and DVD-R/-RW (DVD-VR) discs 19

Using on-screen menus 20

- Main menu 20
- Other Settings 21

Changing the player settings 23

- Changing the delay time of the speakers 25



Other Operations



Using the EZ Sync™ “HDAVI Control™” 26

- One touch play 26
- Auto input switching 26
- Speaker control 26
- Power off link 26
- EZ Sync Control only with TV's remote control (for “HDAVI Control 2”) 26

Using the FM/AM radio 27

- Presetting stations automatically 27
- Selecting the preset channels 27
- Manual tuning 27

Using the XM® Satellite Radio 28

- Selecting XM channels by direct entry 29
- Selecting XM channels by category 29
- Presetting the XM channels 29

Using sound effects 30

- Using the equalizer function 30
- Enhancing the stereo sound:
 - Dolby Pro Logic II/Super Surround 30
 - Adjusting the amount of bass: Subwoofer level 30
- Adjusting the volume of each speaker:
 - Speaker level adjustments 30

Enjoying audio from an external source 31

- Enjoying audio from the television 31
- Using the Music Port 31
- Using the iPod 31



Reference



Glossary 32

Product Service 32

Troubleshooting guide 33

Specifications 36

Limited Warranty (ONLY FOR U.S.A.) 38

Limited Warranty (ONLY FOR CANADA) 39

Accessories Back cover



step 1

Positioning

How you set up your speakers can affect the bass and the sound field. Note the following points:

- Place speakers on flat secure bases.
- Placing speakers too close to floors, walls, and corners can result in excessive bass. Cover walls and windows with thick curtains.
- For optional wall mount, refer to page 5.

Note

Keep your speakers at least 10 mm ($13/32$ ") away from the system for proper ventilation.

Setup example

Place the front, center, and surround speakers at approximately the same distance from the seating position. The angles in the diagram are approximate.

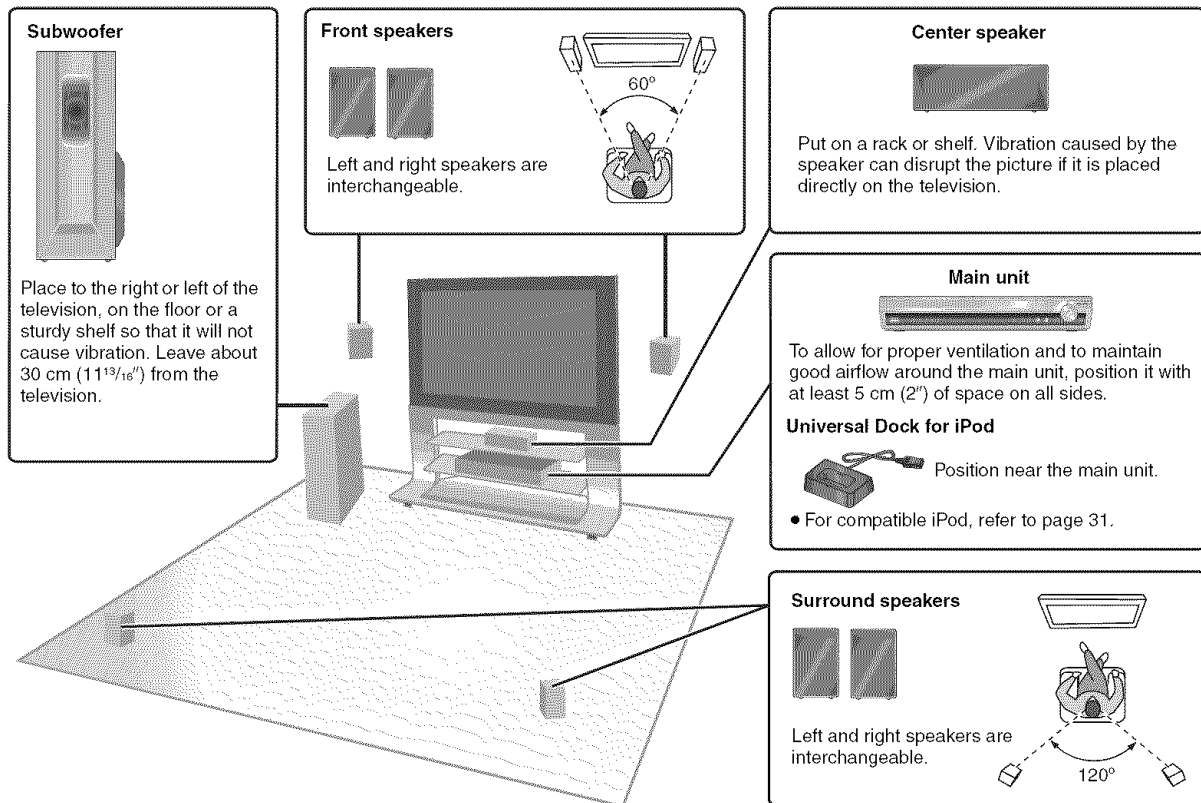

For U.S.A. only

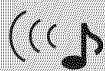

Set your surround sound free!

Optional Panasonic wireless accessory SH-FX65*

You can enjoy surround speaker sound wirelessly when you use the optional Panasonic wireless accessory SH-FX65. For details, please refer to the operating instructions for the optional Panasonic wireless accessory.



Expand your listening options with a multi-room wireless sound system.

Optional Panasonic wireless accessory SH-FX85*

You can enjoy a multi-room wireless sound system when you use the optional Panasonic wireless accessory SH-FX85. For details, please refer to the operating instructions for the optional Panasonic wireless accessory.

* Remove the digital transmitter cover before installing any optional Panasonic wireless accessory.

- Replace the cover when the digital transmitter is not in use.

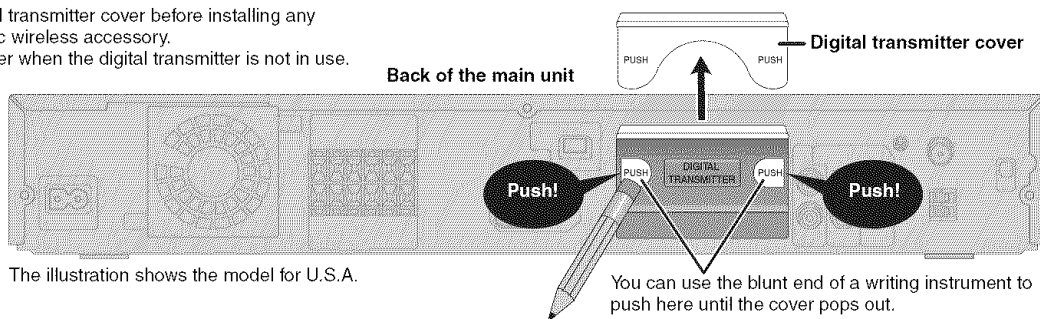

Notes on speaker use

● Use only supplied speakers

- Using other speakers can damage the unit, and sound quality will be negatively affected.
- You can damage your speakers and shorten their useful life if you play sound at high levels over extended periods.
- Reduce the volume in the following cases to avoid damage:
 - When playing distorted sound.
 - When the speakers are reverberating due to a record player, noise from FM broadcasts, or continuous signals from an oscillator, test disc, or electronic instrument.
 - When adjusting the sound quality.
 - When turning the unit on or off.

If irregular coloring occurs on your television

The front and center speakers are designed to be used close to a television, but the picture may be affected with some televisions and setup combinations.

If this occurs, turn the television off for about 30 minutes.

The demagnetizing function of the television should correct the problem. If it persists, move the speakers further away from the television.

	<p>Caution</p> <ul style="list-style-type: none"> ● The main unit and supplied speakers are to be used only as indicated in this setup. Failure to do so may lead to damage to the amplifier and/or the speakers, and may result in the risk of fire. Consult a qualified service person if damage has occurred or if you experience a sudden change in performance. ● Do not attempt to attach these speakers to walls using methods other than those described in this manual.
--	---

Caution

Do not touch the front netted area of the speakers. Hold by the sides.

e.g. Center speaker

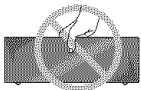

Speaker installation options

■ Attaching to a wall

You can attach all of the speakers (except subwoofer) to a wall.

- The wall or pillar on which the speakers are to be attached should be capable of supporting 10 kg (22 lbs) per screw. Consult a qualified building contractor when attaching the speakers to a wall. Improper attachment may result in damage to the wall and speakers.

① Drive a screw (not included) into the wall.

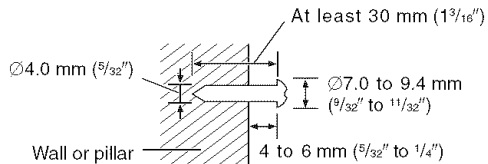

② Fit the speaker securely onto the screw(s) with the hole(s).

Front and surround speakers

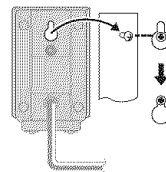

Center speaker

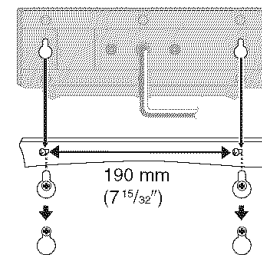

■ Fitting speaker stands (not included)

(except subwoofer)

Ensure the stands meet these conditions before purchasing them. Note the diameter and length of the screws and the distance between screws as shown in the diagram.

- The stands must be able to support over 10 kg (22 lbs).
- The stands must be stable even if the speakers are in a high position.

e.g. Center speaker

Metal screw holes

For attaching to speaker stands

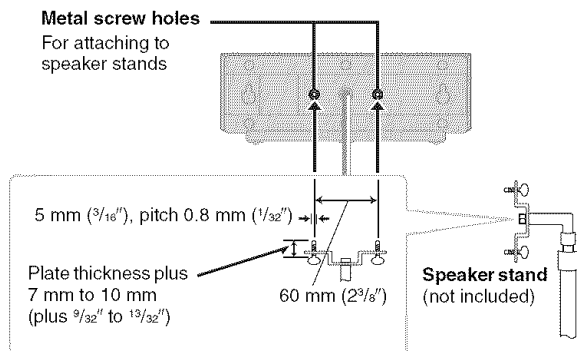

Simple Setup

Positioning

step 2

Cable connections

Turn off all equipment before connection and read the appropriate operating instructions.
Do not connect the AC power supply cord until all other connections are complete.

The illustration shows the model for U.S.A.

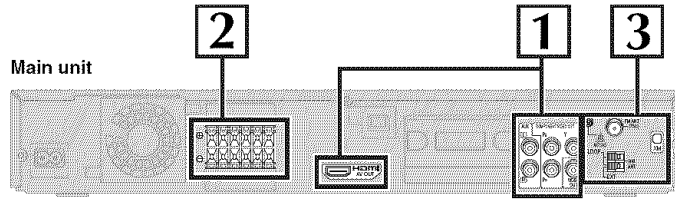

1 Audio and video connections

Basic setup example

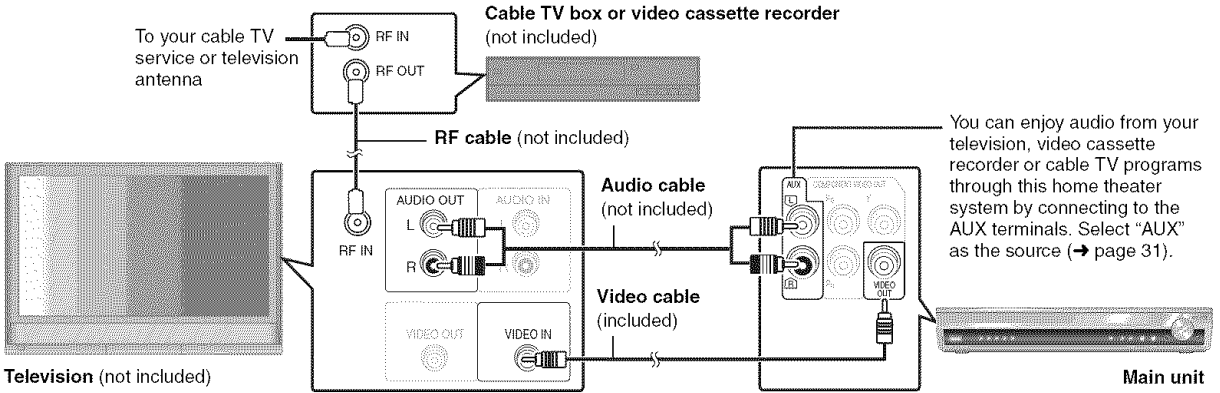

Other video connections for improved picture quality

Television terminals	Cables required (not included)	Main unit terminals	Features
	<p>HDMI cable</p> <p>Note</p> <ul style="list-style-type: none"> Non-HDMI-compliant cables cannot be utilized. It is recommended that you use Panasonic's HDMI cable. Recommended part number: RP-CDHG15 (1.5 m/4.9 ft), RP-CDHG30 (3.0 m/9.8 ft), RP-CDHG50 (5.0 m/16.4 ft), etc. 	<p>HDMI</p> <p>U.S.A.</p> <p>Canada</p>	<p>This connection provides the best picture quality.</p> <ul style="list-style-type: none"> Set "Video Mode" to "On" (→ page 24, "HDMI" menu). Set "Video Output Mode" (→ page 21, Picture Menu). <p>EZ Sync "HDAVI Control"</p> <p>If your Panasonic television is an HDMI control compatible television, you can operate your television synchronizing with home-theater operations or vice versa (→ page 26, Using the EZ Sync™ "HDAVI Control™").</p> <ul style="list-style-type: none"> Make the audio connection (→ above) when you use EZ Sync "HDAVI Control" function.
<p>All Panasonic televisions that have 480p input connectors are compatible. Consult the manufacturer if you have another brand of television.</p>	<p>Video cables</p>	<p>COMPONENT VIDEO</p> <ul style="list-style-type: none"> Connect to terminals of the same color. 	<p>This connection provides a much purer picture than the VIDEO OUT terminal.</p> <ul style="list-style-type: none"> After making this connection, select "Darker" from the "Black Level Control" in the "Video" menu (→ page 24). <p>To enjoy progressive video</p> <ul style="list-style-type: none"> Connect to a progressive output compatible television. <ol style="list-style-type: none"> Set "Video Mode" to "Off" (→ page 24, "HDMI" menu). Set "Video Output Mode" to "480p", and then follow the instructions on the menu screen (→ page 21, Picture Menu).

Note

- Do not make the video connections through the video cassette recorder. Due to copy guard protection, the picture may not be displayed properly.
- Only one video connection is required.

2 Speaker connections



- Be careful not to cross (short-circuit) or reverse the polarity of the speaker wires as doing so may damage the speakers.

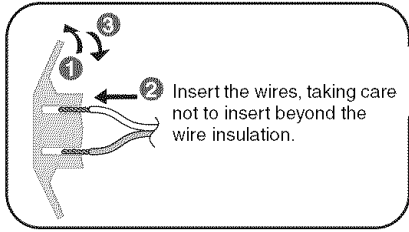

Insert the wires, taking care not to insert beyond the wire insulation.

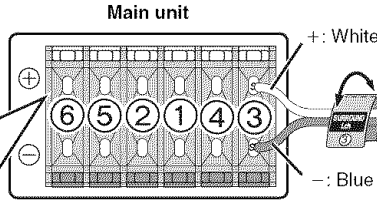

Insert the wires correctly.

- ③ SURROUND (L)
- ④ SURROUND (R)
- ① FRONT (L)
- ② FRONT (R)
- ⑤ CENTER
- ⑥ SUBWOOFER

Speaker cable sticker (included)
Attach the corresponding speaker cables with the speaker-cable stickers to make connection easier.

3 Radio antenna connections

- Keep loose antenna cables away from other wires and cables.

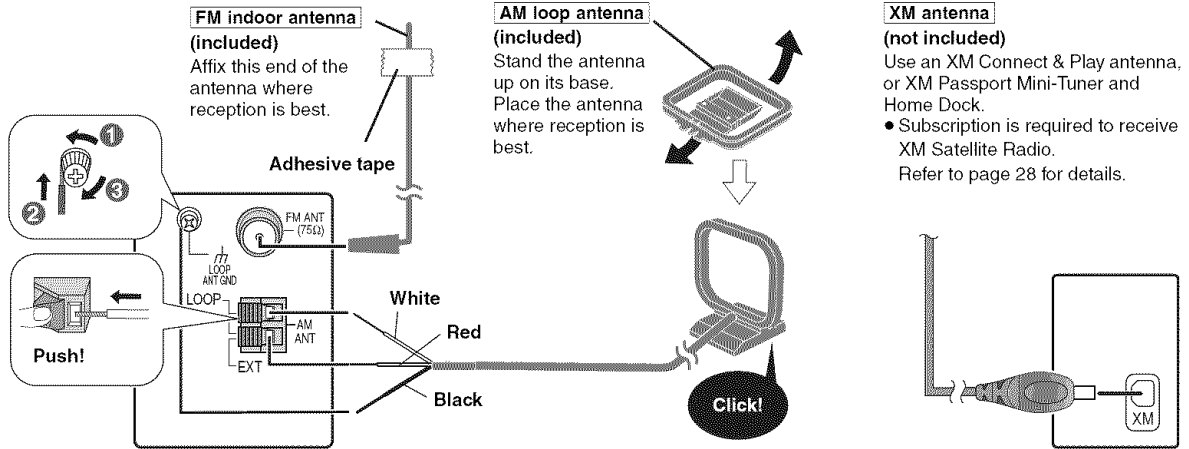

FM indoor antenna (included)
Affix this end of the antenna where reception is best.

AM loop antenna (included)
Stand the antenna up on its base. Place the antenna where reception is best.

XM antenna (not included)
Use an XM Connect & Play antenna, or XM Passport Mini-Tuner and Home Dock.
• Subscription is required to receive XM Satellite Radio.
Refer to page 28 for details.

Using an FM/AM outdoor antenna (optional)

Use outdoor antenna if FM/AM radio reception is poor.

- Disconnect the antenna when the unit is not in use.
- Do not use the outdoor antenna during an electrical storm.

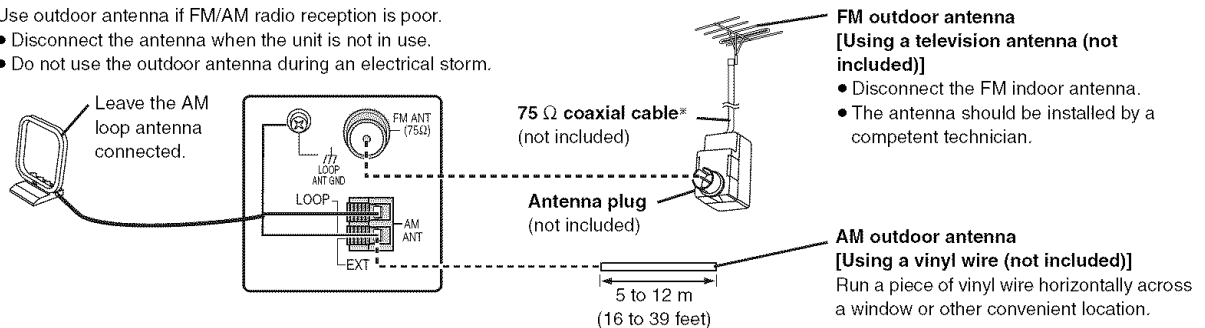

FM outdoor antenna [Using a television antenna (not included)]
• Disconnect the FM indoor antenna.
• The antenna should be installed by a competent technician.

AM outdoor antenna [Using a vinyl wire (not included)]
Run a piece of vinyl wire horizontally across a window or other convenient location.

* Rework your outdoor antenna's 75 Ω coaxial cable as follows.

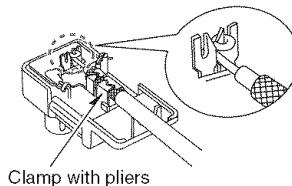
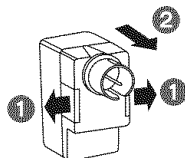
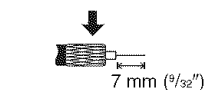
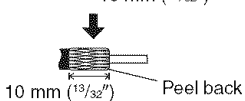
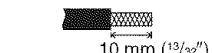

- 1 Remove a piece of the outer vinyl insulator.
- 2 Carefully pull the tabs apart to remove the cover.
- 3 Install the coaxial cable. Clamp the cable conductor, and wind it on so that it does not contact anything else.
- 4 Attach the cover.





step 3 iPod® connection

Proceed to step 4 if you are not connecting an iPod to the main unit.

Dock adapter for iPod nano 2nd generation (aluminum) (2GB, 4GB, 8GB)	Dock adapter for iPod 5th generation (video) (60GB, 80GB)	Dock adapter for iPod 5th generation (video) (30GB)
		
11	10	9

The mark **11**, **10** or **9** is shown on the back of each dock adapter.

- For other types of iPod, use the dock adapter sold separately.
- Or visit the official Apple Computer website for compatible adapters.

Connect the dock to the back of the main unit.

Do not connect or disconnect the dock while the main unit is on.

Universal Dock for iPod

When removing, insert your fingernail or a flat object and lift upwards.

■ Charging the iPod

iPod (not included)

- Connect the iPod firmly.

The indicator lights up when the iPod is inserted, and charging starts.

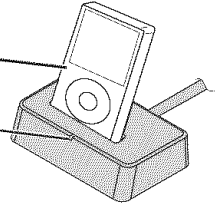

Charging time

iPod nano 2nd generation (aluminum)	Until iPod is fully charged
iPod 5th generation (video)	
iPod nano 1st generation	
iPod 4th generation (color display)	5 hours (fixed)
iPod 4th generation	
iPod mini	

Note

- AC cord must be connected with the main unit.
- "OPTION *" will be shown on the main unit's display during iPod charging in main unit standby mode. It will go off when charging is finished.
- For the above models under "fixed 5-hour charging", "OPTION *" continues to be displayed throughout this duration, even when your iPod is fully charged. You can turn off this display by removing the iPod from the dock.
- Compatibility depends on the software version of your iPod.

step 4 AC cord connection

The illustration shows the model for U.S.A.

Main unit

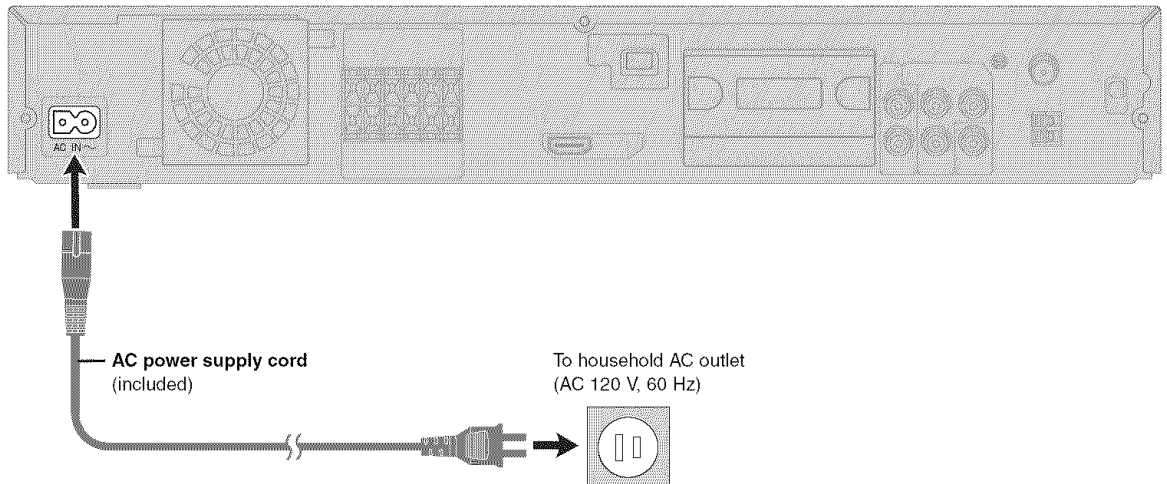

Conserving power

The main unit consumes a small amount of power when it is turned off (approx. 0.5 W). To save power when it is not to be used for a long time, unplug it from the household AC outlet. You will need to reset some memory items after plugging in the main unit.

Note

The included AC power supply cord is for use with the main unit only. Do not use it with other equipment. Also, do not use cords for other equipment with the main unit.

step 5

Preparing the remote control

2 Insert so the poles (+ and -) match those in the remote control.

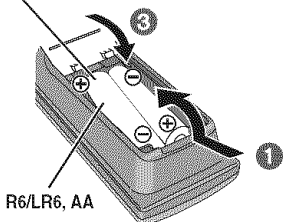

• Do not use rechargeable type batteries.

Do not:

- mix old and new batteries.
 - use different types at the same time.
 - heat or expose to flame.
 - take apart or short circuit.
 - attempt to recharge alkaline or manganese batteries.
 - use batteries if the covering has been peeled off.
- Mishandling of batteries can cause electrolyte leakage which can severely damage the remote control.

Remove the batteries if the remote control is not going to be used for a long period of time. Store in a cool, dark place.

■ Use

Aim at the remote control signal sensor (→ page 11), avoiding obstacles, at a maximum range of 7 m (23 feet) directly in front of the unit.

step 6

Performing QUICK SETUP

The QUICK SETUP screen assists you to make necessary settings.

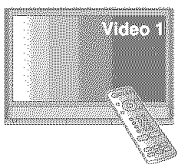

To display the picture from the main unit, turn on your television and change its video input mode (e.g. VIDEO 1, AV 1, etc.).

- To change your television's video input mode, refer to its operating instructions.
- This remote control can perform some basic television operations (→ page 10).

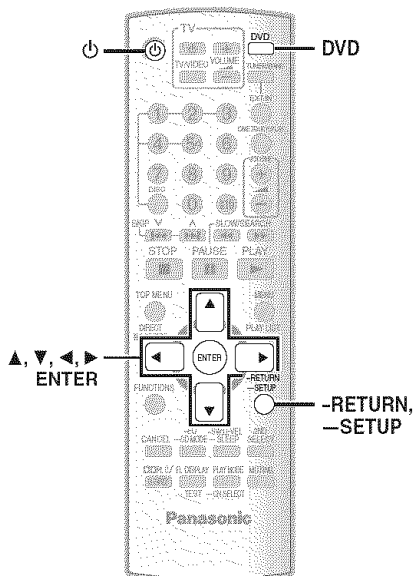

1		Turn on the unit.
2		Select "DVD/CD".
3		Press and hold to show the QUICK SETUP screen.
4		Follow the messages and make the settings.
		<ul style="list-style-type: none"> • Menu Language • TV Type • TV Aspect
5		Press to finish QUICK SETUP.
6		Press to exit.

To change these settings later

Select "QUICK SETUP" in the "Others" menu (→ page 25).

Control reference guide

See page references in parentheses.

Television operations
Refer to "Operating the television" below.

Turn the main unit on/off (9)

Select disc's title numbers etc./Enter numbers (15)

Select the disc or show disc information (16)

Select preset radio stations/channels (27, 29)

Basic operations for play (14, 15)

Show a disc top menu (18) or program list (19)

Frame-by-frame/Select or register menu items on the television screen (15)/Browse XM radio categories (29)

Show on-screen menu (20)

Mute the sound

- "MUTING" flashes in the main unit's display while the function is on.
- To cancel, press the button again or adjust the volume.
- Muting is canceled when you switch the unit to standby.

Select the source
[DVD]: DVD/CD (9)
[TUNER/BAND]: FM/AM (27), XM (28)
[EXT-IN]: MUSIC P. (31), AUX (31), OPTION (31)

Start up and play a disc automatically (15, 26)

Adjust the volume of the main unit

Select radio stations/channels manually (27, 29)

Show a disc menu (18) or play list (19)

Return to previous screen (15) or show the setup menu (23)

This function is available only when using the optional Panasonic wireless sound system SH-FX85.
[2ND SELECT]: Change the source for the second room
MAIN SOURCE (follows the selected source for the main room) → (FM → AM) → XM → OPTION → Return to MAIN SOURCE
* If the main room is in FM/AM mode, you can only select the same mode for the FM/AM tuner of the second room.
For details, refer to the operating instructions for the optional Panasonic wireless sound system SH-FX85.

Turn the unit off automatically (Sleep timer)

- 1 Press and hold the button.
- 2 While the time is shown, press the button repeatedly to select the time (in minutes).
 - The maximum setting is 120-min (in 30-min steps)
 - Press and hold the button again to confirm the remaining time on the unit's display.
 - To cancel, select "OFF" in the main unit's display.

Operating the television

Aim the remote control at the Panasonic television and press the button.

[TV]: Turn the television on/off

[TV/VIDEO]: Change the television's video input mode

[+, -]: Adjust the television volume

- This may not work properly with some models.

Avoiding interference with other Panasonic equipment

Other Panasonic audio/video equipment may start functioning when you operate the unit using the supplied remote control.

You can operate this unit in another mode by setting the remote control operating mode to "REMOTE 2".

The main unit and remote control must be set to the same mode.

- 1 Press and hold [▶▶/▶▶] on the main unit and [2] on the remote control until the main unit's display shows "REMOTE 2".
- 2 Press and hold [ENTER] and [2] on the remote control for at least 2 seconds.

To change the mode back to "REMOTE 1", repeat both steps above by replacing [2] with [1].



Standby/on switch [POWER ⏻/⏻]

Turn the main unit on/off.
Press to switch the unit from on to standby mode or vice versa. In standby mode, the unit is still consuming a small amount of power. (14)

5 DISC SELECTOR
Select a disc directly (14)

■ /-TUNE MODE / —FM MODE
Stop playing (14)/Select the tuning mode (27)
Adjust the FM reception condition (27)

▶ / MEMORY
Play discs (14)/Memorize the receiving radio stations/channels (27, 29)

▲ OPEN/CLOSE
Open/Close the disc drawer (14)

DISC EXCHANGE
Open the disc drawer to exchange the disc in the play position (14)

DISC SKIP
Skip to the next disc tray (14)

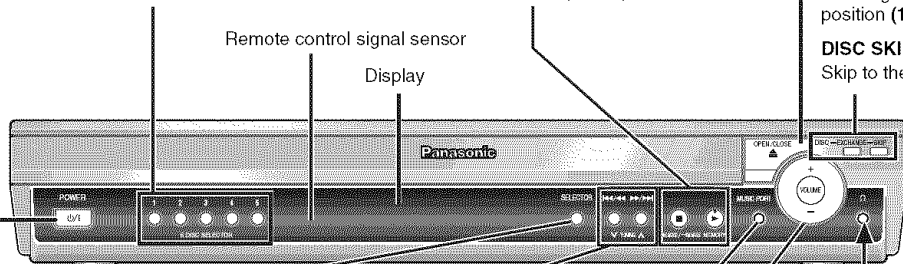

SELECTION (27)
DVD/CD→FM→AM→XM→
AUX→MUSIC P.→OPTION→
Return to DVD/CD

⏪/⏩, ⏮/⏭ / TUNING ^
Skip or slow-search play (14)/
Select the radio stations/channels (27, 29)

MUSIC PORT
Connect an external device (31)

Headphones (not included)

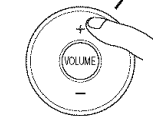

Adjust the volume of the main unit.

Headphone plug type:
Ø3.5 mm (1/8") stereo mini plug

- Reduce the volume before connecting.
- Audio is automatically switched to 2-channel stereo.
- To prevent hearing damage, avoid listening for prolonged periods of time.

Listening caution



Selecting fine audio equipment such as the unit you've just purchased is only the start of your musical enjoyment. Now it's time to consider how you can maximize the fun and excitement your equipment offers. This manufacturer and the Electronic Industries Association's Consumer Electronics Group want you to get the most out of your equipment by playing it at a safe level. One that lets the sound come through loud and clear without annoying blaring or distortion—and, most importantly, without affecting your sensitive hearing.

We recommend that you avoid prolonged exposure to excessive noise.

Sound can be deceiving. Over time your hearing "comfort level" adapts to higher volumes of sound. So what sounds "normal" can actually be loud and harmful to your hearing.

Guard against this by setting your equipment at a safe level BEFORE your hearing adapts.



To establish a safe level:

- Start your volume control at a low setting.
- Slowly increase the sound until you can hear it comfortably and clearly, and without distortion.



Once you have established a comfortable sound level:

- Leave it there.



Taking a minute to do this now will help to prevent hearing damage or loss in the future. After all, we want you listening for a lifetime.

Discs that can be played

Commercial discs

Disc	Logo	Indicated in these instructions by	Remarks
DVD-Video		DVD-V	High quality movie and music discs
Video CD		VCD	Music discs with video Including SVCD (Conforming to IEC62107)
CD		CD	Music discs

Recorded discs (○: Playable, ×: Not playable)

Disc	Logo	Recorded on a DVD video recorder, etc.		Recorded on a personal computer, etc.			Finalizing ^{*6}
		DVD-VR ^{*2}	DVD-V ^{*4}	WMA	MP3	JPEG	
DVD-RAM		○	—	×	○	○	Not necessary
DVD-R/RW		○	○	×	○	○	Necessary
DVD-R DL		○ ^{*3}	○	×	×	×	Necessary
+R/+RW	—	×	(○) ^{*5}	×	×	×	Necessary
+R DL	—	×	(○) ^{*5}	×	×	×	Necessary
CD-R/RW ^{*1}	—	—	—	○	○	○	Necessary ^{*7}

● It may not be possible to play all the above-mentioned discs in some cases due to the type of disc, the condition of the recording, the recording method, or how the files were created (→ page 13, Tips for making data discs).

^{*1} This unit can play CD-R/RW recorded with CD-DA or Video CD format.

WMA **MP3** **JPEG** This unit also plays HighMAT discs.

^{*2} Discs recorded on DVD video recorders or DVD video cameras, etc. using Version 1.1 of the Video Recording Format (a unified video recording standard).

^{*3} Discs recorded on DVD video recorders or DVD video cameras using Version 1.2 of the Video Recording Format (a unified video recording standard).

^{*4} Discs recorded on DVD video recorders or DVD video cameras using DVD-Video Format.

^{*5} Recorded using a format different from DVD-Video Format, therefore some functions cannot be used.

^{*6} A process that allows play on compatible equipment. To play a disc that is indicated as "Necessary", the disc must first be finalized on the device it was recorded on.

^{*7} Closing the session will also work.

Discs that cannot be played

DVD-RW version 1.0, DVD-Audio, DVD-ROM, CD-ROM, CDV, CD-G, SACD, DivX Video Discs and Photo CD, DVD-RAM that cannot be removed from their cartridge, 2.6-GB and 5.2-GB DVD-RAM, and "Chaoyi VCD" available on the market including CVD, DVCD and SVCD that do not conform to IEC62107.

Note about using a DualDisc

The digital audio content side of a DualDisc does not meet the technical specifications of the Compact Disc Digital Audio (CD-DA) format so playback may not be possible.

Disc handling precautions

- Do not attach labels or stickers to discs. This may cause disc warping, rendering it unusable.
- Do not write on the label side with a ball-point pen or other writing instrument.
- Do not use record cleaning sprays, benzene, thinner, liquids which prevent static electricity, or any other solvent.
- Do not use scratch-proof protectors or covers.
- Do not use the following discs:
 - Discs with exposed adhesive from removed stickers or labels (rented discs, etc.).
 - Discs that are badly warped or cracked.
 - Irregularly shaped discs, such as heart shapes.



■ Tips for making data discs

Format	Disc	Extension	Reference
WMA	CD-R/RW	“.WMA” “.wma”	<ul style="list-style-type: none"> • Compatible compression rate: between 48 kbps and 320 kbps • You cannot play WMA files that are copy-protected. • This unit does not support Multiple Bit Rate (MBR: an encoding process for audio content that produces an audio file encoded at several different bit rates).
MP3	DVD-RAM DVD-R/RW CD-R/RW	“.MP3” “.mp3”	<ul style="list-style-type: none"> • Compatible compression rate: <ul style="list-style-type: none"> – between 32 kbps and 320 kbps for sampling frequencies of 32 kHz and above – between 8 kbps and 160 kbps for sampling frequencies of 24 kHz and below • This unit does not support ID3 tags. • Compatible sampling frequencies: <ul style="list-style-type: none"> – DVD-RAM, DVD-R/RW: 11.02, 12, 22.05, 24, 44.1 and 48 kHz – CD-R/RW: 8, 11.02, 12, 16, 22.05, 24, 32, 44.1 and 48 kHz
JPEG	DVD-RAM DVD-R/RW CD-R/RW	“.JPG” “.jpg” “.JPEG” “.jpeg”	<ul style="list-style-type: none"> • JPEG files taken on a digital camera that conform to DCF Standard (Design rule for Camera File system) Version 1.0 are displayed. <ul style="list-style-type: none"> – Files that have been altered, edited or saved with computer picture editing software may not be displayed. • This unit cannot display moving pictures, MOTION JPEG and other such formats, still pictures other than JPEG (e.g. TIFF), or play pictures with attached audio.

- When there are more than 8 groups, the eighth group onwards will be displayed on one vertical line in the menu screen.
- There may be differences in the display order on the menu screen and computer screen.
- This unit cannot play files recorded using packet write.

Naming folders and files

(Files are treated as contents and folders are treated as groups on this unit.)

At the time of recording, prefix folder and file names. This should be with numbers that have an equal number of digits, and should be done in the order you want to play them (this may not work at times).

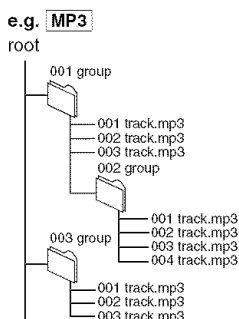

DVD-RAM

- Discs must conform to UDF 2.0.

DVD-R/RW

- Discs must conform to UDF bridge (UDF 1.02/ISO9660).
- This unit does not support multi-session. Only the default session is played.

CD-R/RW

- Discs must conform to ISO9660 level 1 or 2 (except for extended formats).
- This unit supports multi-session but if there are many sessions it takes more time for play to start. Keep the number of sessions to a minimum to avoid this.

Maintenance

■ To clean discs

Wipe with a damp cloth and then wipe dry.

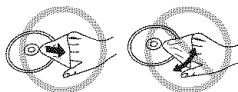

■ Clean this unit with a soft, dry cloth.

- Never use alcohol, paint thinner or benzene to clean this unit.
- Before using chemically treated cloth, carefully read the instructions that came with the cloth.

Do not use commercially available lens cleaners as they may cause malfunction. Cleaning of the lens is generally not necessary although this depends on the operating environment.

Before moving the unit, ensure the disc trays are empty. Failure to do so will risk severely damaging the discs and the unit.

Basic play

To display the picture from the main unit, turn on your television and change its video input mode (e.g. VIDEO 1, AV 1, etc.).

- To change your television's video input mode, refer to its operating instructions.

1 Power on.

POWER 

3 Open the drawer and place the disc(s).

- Load double-sided discs so the label for the side you want to play is facing up.
- To load discs on the other trays, press [DISC SKIP] on the main unit.
- Play will start from the disc in the front-left position of the tray.
- For DVD-RAM, remove the disc from its cartridge before use.
- Do not:
 - load more than one disc per tray.
 - touch the drawer or the carousel while they are in motion.
 - rotate the carousel by hand.
 - close the drawer by hand.

2 Select "DVD/CD".

SELECTOR 

4 Close the drawer.

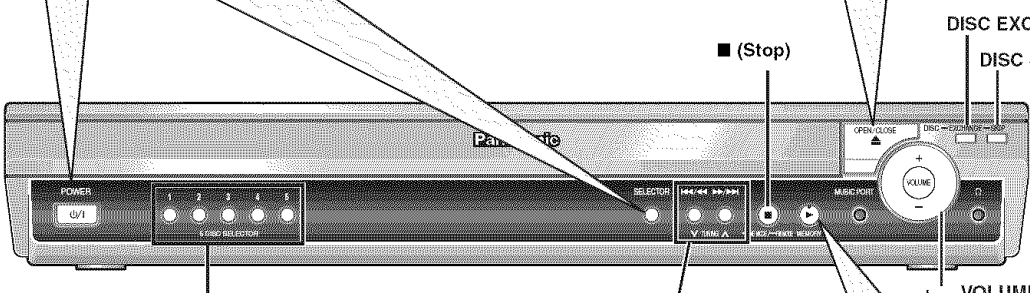

Press to select a disc directly.

- You can also select the disc using the remote control (→ page 16, Checking and selecting the disc).

1 2 3 4 5

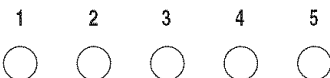

5 DISC SELECTOR

Press to skip.

Press and hold to

- search during play
- start slow-motion play during pause (Motion picture part)

- Press [▶] (Play) to start normal play.



5 Start play.

- Press [+ , - VOLUME] to adjust the volume.
- You can enjoy surround sound when you press [DOLBY PLII/S.SRD] to turn on Dolby Pro Logic II (→ page 30).

Using the main unit

Select the next disc tray

DISC -SKIP 

Exchange the disc in the play position

DISC -EXCHANGE 

- The drawer opens and the disc in the play position comes to the front-left position.
- Press the button again to play the disc after changing the disc in the front-left position.

Change the other discs without interrupting play

OPEN/CLOSE 

↓

DISC -SKIP 

↓

Change the discs

↓

OPEN/CLOSE 

- Each time you press [DISC SKIP], you can select the other trays.

Note

- DISC CONTINUES TO ROTATE WHILE MENUS ARE DISPLAYED. To preserve the unit's motor and your television screen, press [■] (Stop) when you are finished with the menus.
- Total title number may not be displayed properly on +R/+RW.

Using the remote control

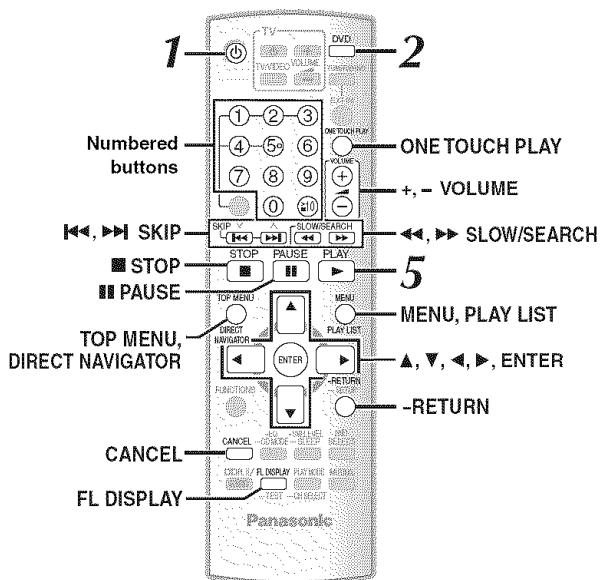

On-screen item select

Select

Register

Enter number

① ② ③
④ ⑤ ⑥
⑦ ⑧ ⑨
⑩ ⑪

DVD-VR DVD-V VCD CD
e.g. To select 12:
[≥10] → [1] → [2]

VCD with playback control
Press [■ STOP] to cancel the PBC function, and then press the numbered buttons.

WMA MP3 JPEG
e.g. To select 123:
[1] → [2] → [3] → [ENTER]

ENTER

CANCEL

- Press [CANCEL] to cancel the number(s).

One touch play

ONE TOUCH PLAY

The main unit automatically turns on and starts playing the disc in the play position (→ page 26).

Stop

STOP

The position is memorized while "RESUME" is on the display.

- Press [▶ PLAY] to resume.
- Press [■ STOP] again to clear the position.

Pause

PAUSE

- Press [▶ PLAY] to restart play.

Skip

SKIP

- WMA MP3 JPEG
[This feature does not work during program and random play (→ page 17).]
- [▲, ▼]: Group skip
- [◀, ▶]: Content skip

Search (during play)

Slow-motion (during pause)

SLOW/SEARCH

- Up to 5 steps.
- Press [▶ PLAY] to start normal play.
- VCD Slow-motion: forward direction only.

Frame-by-frame (during pause)

DVD-VR DVD-V VCD

- VCD Forward direction only.

Disc menu

TOP MENU

DIRECT NAVIGATOR

DVD-V Shows a disc top menu.

DVD-VR Press the button to show the programs (→ page 19).

MENU

PLAY LIST

DVD-V Shows a disc menu.

DVD-VR Press the button to show a playlist (→ page 19).

-RETURN -SETUP

VCD with playback control Shows a disc menu.

Return to previous screen

-RETURN -SETUP

Main unit display

FL DISPLAY

DVD-VR DVD-V VCD CD
WMA MP3

Time display

↔ Information display (e.g. DVD-VR Program number)

JPEG

When Slideshow (→ page 20) is on:
SLIDE ↔ Contents number

When Slideshow is off:
PLAY ↔ Contents number

Basic play

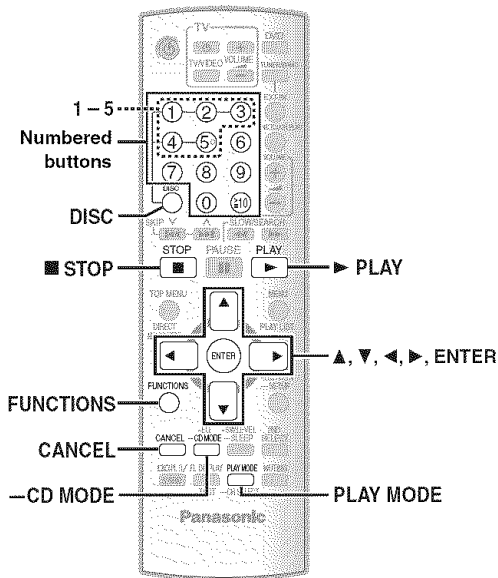

Checking and selecting the disc

DISC

1 Press [DISC] to show the Disc information screen.

- To exit the screen, press [DISC].

e.g.

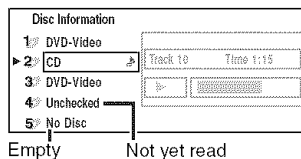

2 Press the numbered buttons ([1] - [5]) to select the disc.

Displaying current playback condition

FUNCTIONS

Press [FUNCTIONS].

Main menu (→ page 20) → Basics → Details

↑ off (No on-screen display) ↓

Basics

e.g. DVD-V

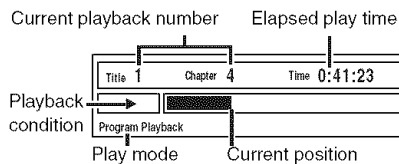

Details

e.g. DVD-V

Details - DVD-Video	
Audio information	Audio 1 --- DTS 3/2.1ch
Subtitle information	Subtitle ---
Angle information	Angle 1/1
Aspect of current title	Source Aspect 4:3
Total play time of current title	Title Total Time 0:54:28

Playing CDs sequentially

VCD CD WMA MP3

-CD MODE

This feature is very convenient if you want to play several music CDs sequentially. Select an applicable disc before playing (→ Checking and selecting the disc, left).

While stopped

1 Press and hold [-CD MODE].



2 Press [▶ PLAY].

- If all loaded discs are DVDs, CD Mode does not work.
- HighMAT menus and Video CD playback control are disabled.
- You cannot turn CD Mode on or off during program or random mode.
- If you want to play a DVD, press and hold [-CD MODE] again while stopped to cancel CD Mode. (CD Mode is also canceled when you switch the unit to standby, select another source, or change the disc in the play position.)
- DVD and JPEG are skipped without being played.

Program and Random play

PLAY MODE



Press [PLAY MODE] while stopped.

Program and random playback screens appear sequentially.

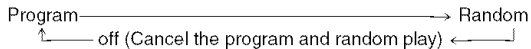

- Select "Play as Data Disc" in Other Menu (→ page 22) when using
 - HighMAT discs without using the HighMAT function, or
 - DVD-RAM or DVD-R/RW discs containing MP3 or JPEG files.
- **DVD-V** Some items cannot be played even if you have programmed them.

Program play (up to 32 items)

■ When CD Mode is off

DVD-V **VCD** **CD** **WMA** **MP3** **JPEG**

You can program all the items on a disc in the play position.

① **VCD** **CD** Skip to step ②

Press the numbered buttons to select a group or title.

WMA **MP3** **JPEG** Press [ENTER] to register the selection.)

e.g. **DVD-V**

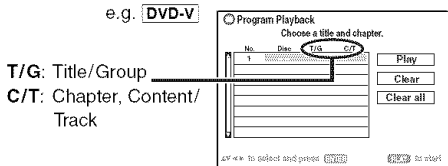

- To select a 2-digit number

e.g. To select 12: [≥10] → [1] → [2]

WMA **MP3** **JPEG** [1] → [2] → [ENTER]

② Press the numbered buttons to select a chapter or track.

WMA **MP3** **JPEG** Press [ENTER] to register the selection.)

- Repeat steps ① and ② to program other items.

③ Press [▶] PLAY].

■ When CD Mode is on (→ page 16)

VCD **CD** **WMA** **MP3**

You can program all the items on all the discs.

① Press the numbered buttons ([1] – [5]) to select a disc.

WMA **MP3** Press the numbered buttons to select a group.
(Press [ENTER] to register the selection.)

- To select a 2-digit number

e.g. To select 12: [1] → [2] → [ENTER]

③ Press the numbered buttons to select a track.

WMA **MP3** Press [ENTER] to register the selection.)

- To select a 2-digit number

e.g. To select 12: [≥10] → [1] → [2]

WMA **MP3** [1] → [2] → [ENTER]

- Repeat steps ① to ③ to program other items.

④ Press [▶] PLAY].

To select an item using the cursor buttons

Press [ENTER] and [▲, ▼] to select an item, and then press [ENTER] again to register.

To change the selected program

- 1 Press [▲, ▼] to select the program number.
- 2 Press the numbered buttons to change each item.
(**WMA** **MP3** Press [ENTER] to register the selection.)

To clear the selected program

- 1 Press [▲, ▼] to select the program number.
- 2 Press [CANCEL] (or press [▲, ▼, ◀, ▶] to select "Clear" and press [ENTER]).

To clear the whole program

Select "Clear all" with [▲, ▼, ◀, ▶] and press [ENTER].

The whole program is also cleared when the disc is moved out of the play position, the unit is turned off or another source is selected.

Random play

■ When CD Mode is off

VCD **CD**

You can play all the items on a disc in the play position in random order.

DVD-V **WMA** **MP3** **JPEG**

You can play selected item(s) on a disc in the play position in random order.

① **DVD-V** **WMA** **MP3** **JPEG**

Press [▲, ▼] to select a group or a title.

WMA **MP3** **JPEG** Press [ENTER] to register the selection.)

e.g. **DVD-V**

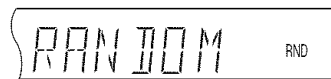

② Press [▶] PLAY].

■ When CD Mode is on (→ page 16)

VCD **CD** **WMA** **MP3**

You can play all the items on all the discs in random order.

Press [▶] PLAY].

e.g. **CD**

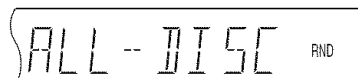
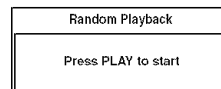

Playing data discs using navigation menus

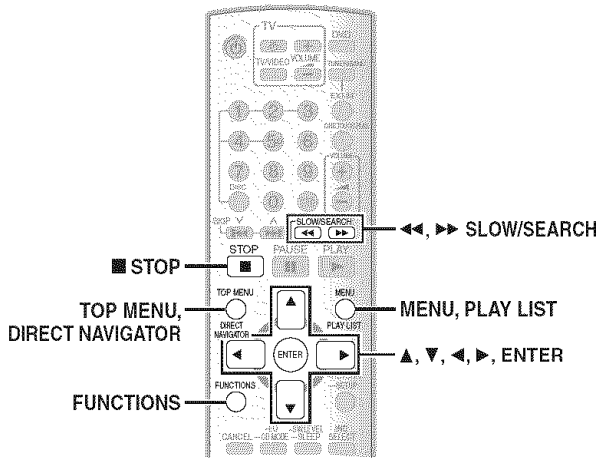

Playing data discs

WMA MP3 JPEG

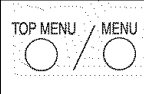

- Select "Play as Data Disc" in Other Menu (→ page 22) when using
 - HighMAT discs without using the HighMAT function, or
 - DVD-RAM or DVD-R/RW discs containing MP3 or JPEG files.

Playing items in order (Playback Menu)

- 1 Press [TOP MENU].
 - To exit the screen, press [TOP MENU].

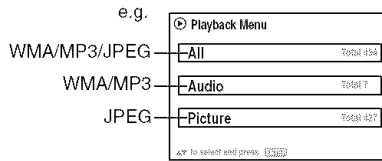

- 2 Press [▲, ▼] to select "All", "Audio" or "Picture" and press [ENTER].

Playing from the selected item (Navigation Menu)

- 1 Press [MENU].
 - To exit the screen, press [MENU].

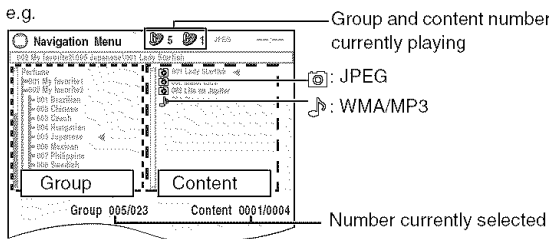

- 2 Press [◀] followed by [▲, ▼] to select the group and press [ENTER].
- 3 To play content in the group in order Press [ENTER].
To start play from the selected content Press [▲, ▼] to select and [ENTER].

To enjoy listening to WMA/MP3 contents while showing a JPEG image on the screen, select a JPEG file first and then select audio contents. (The opposite order is not effective.)

Using the submenu

- 1 While Navigation Menu (→ left) is displayed Press [FUNCTIONS].
- 2 Press [▲, ▼] to select an item and press [ENTER].
Items shown differ depending on the type of disc.

✓ Multi	Groups and contents are displayed.
List	Contents only
Tree	Groups only
Thumbnail	Thumbnail images [JPEG]
Next group	To go to next group [WMA] [MP3]
Previous group	To go to previous group [WMA] [MP3]
All	WMA/MP3 and JPEG
Audio	WMA/MP3 only
Picture	JPEG only
Help display	To switch between guide messages and the elapsed play time indicator
Find	To search by content or group title (→ below)

Searching by a content or group title

Highlight a group title to search the group, or a content title to search its content.

- 1 While the submenu is displayed (→ above) Press [▲, ▼] to select "Find" and press [ENTER].

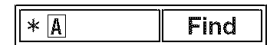

- 2 Press [▲, ▼] to select a character and press [ENTER].

- Repeat to enter another character.
- Lower case characters are also searched.
- Press [◀◀, ▶▶ SLOW/SEARCH] to skip between A, E, I, O and U.
- Press [◀] to erase a character.
- Leave the asterisk (*) when you search for the titles including the character you enter.
- Erase the asterisk (*) to search for the titles starting with the character you enter. To add the asterisk (*) again, display the submenu again and select "Find".

- 3 Press [▶] to select "Find" and press [ENTER].
The search result screen appears.

- 4 Press [▲, ▼] to select the content or group and press [ENTER].

Selecting a track using CD text

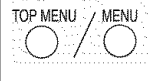

Titles appear with CD Text disc playback.

- 1 Press [TOP MENU] or [MENU].
 - To exit the screen, press [TOP MENU] or [MENU].

e.g. CD text

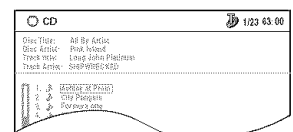

- 2 Press [▲, ▼] to select the track and press [ENTER].
 - Press [FUNCTIONS] to show the playback condition and current position.

Playing HighMAT™ discs

WMA MP3 JPEG

TOP MENU / MENU

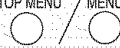

- 1 Press [TOP MENU].
 - To exit the screen, press [STOP].
 - To change the menu background to the one recorded on the disc, press [FUNCTIONS].
- 2 Press [▲, ▼, ◀, ▶] to select the item, and then press [ENTER].
 - Repeat this step if necessary.

e.g.

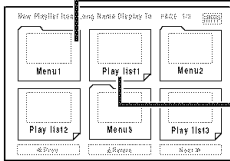

Menu: Takes you to the next menu which shows playlists or another menu

Playlist: Play starts

Selecting from the list

- 1 During play
Press [MENU].
 - To exit the screen, press [MENU].

e.g.

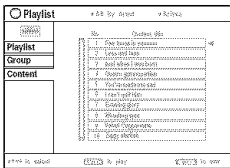

- 2 Press [◀] followed by [▲, ▼] to switch among "Playlist", "Group" and "Content" lists.
- 3 Press [▶] followed by [▲, ▼] to select an item and press [ENTER].

Playing RAM and DVD-R/-RW (DVD-VR) discs

DVD-VR

DIRECT NAVIGATOR / PLAY LIST

- Titles appear only if the titles are recorded on the disc.
- You cannot edit programs, playlists and disc titles.

Playing the programs

- 1 Press [DIRECT NAVIGATOR].
 - To exit the screen, press [DIRECT NAVIGATOR].

e.g.

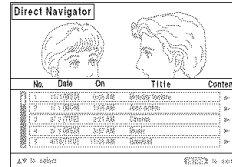

- 2 Press [▲, ▼] to select the program.
 - Press [▶] to show the contents of the program and the disc.
- 3 Press [ENTER].

Playing a playlist

This works only when the disc contains a playlist.

- 1 Press [PLAY LIST].
 - To exit the screen, press [PLAY LIST].

e.g.

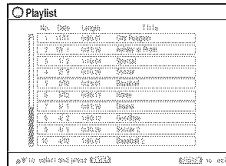

- 2 Press [▲, ▼] to select the playlist.
- 3 Press [ENTER].

Using on-screen menus

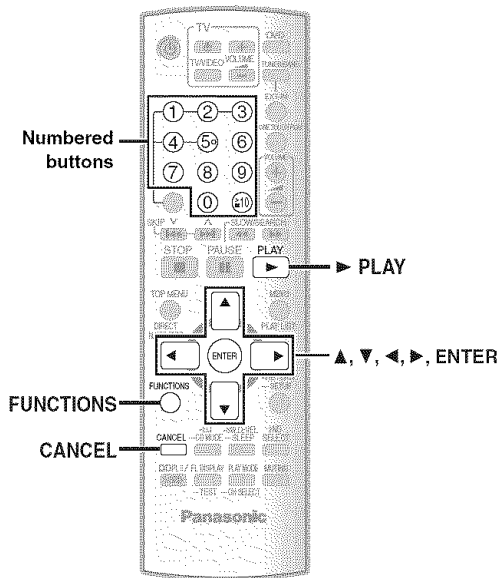

1	FUNCTIONS	Show the Main menu.																		
2	<p>Select</p> <p>Go to the next menu</p> <p>Return to the previous menu</p> <p>Register</p>	<p style="text-align: center;">Select the menu.</p> <p>e.g. DVD-V</p> <table border="1"> <tr><td colspan="2">FUNCTIONS</td></tr> <tr><td>Title</td><td>1/2</td></tr> <tr><td>Chapter</td><td>3/10</td></tr> <tr><td>Time</td><td>0:24:31</td></tr> <tr><td>Audio</td><td>1 English</td></tr> <tr><td>Subtitle</td><td>2</td></tr> </table> <table border="1"> <tr><td><input checked="" type="checkbox"/></td><td>1 English</td></tr> <tr><td><input type="checkbox"/></td><td>2 French</td></tr> <tr><td><input type="checkbox"/></td><td>3 Spanish</td></tr> </table>	FUNCTIONS		Title	1/2	Chapter	3/10	Time	0:24:31	Audio	1 English	Subtitle	2	<input checked="" type="checkbox"/>	1 English	<input type="checkbox"/>	2 French	<input type="checkbox"/>	3 Spanish
FUNCTIONS																				
Title	1/2																			
Chapter	3/10																			
Time	0:24:31																			
Audio	1 English																			
Subtitle	2																			
<input checked="" type="checkbox"/>	1 English																			
<input type="checkbox"/>	2 French																			
<input type="checkbox"/>	3 Spanish																			
3	<p>Select</p> <p>Register</p>	<p style="text-align: center;">Make the settings.</p> <p>e.g. DVD-V</p> <table border="1"> <tr><td colspan="2">FUNCTIONS</td></tr> <tr><td>Title</td><td>1/2</td></tr> <tr><td>Chapter</td><td>3/10</td></tr> <tr><td>Time</td><td>0:24:31</td></tr> <tr><td>Audio</td><td>1 English</td></tr> <tr><td>Subtitle</td><td>2</td></tr> </table> <table border="1"> <tr><td><input checked="" type="checkbox"/></td><td>1 English</td></tr> <tr><td><input checked="" type="checkbox"/></td><td>2 French</td></tr> <tr><td><input type="checkbox"/></td><td>3 Spanish</td></tr> </table>	FUNCTIONS		Title	1/2	Chapter	3/10	Time	0:24:31	Audio	1 English	Subtitle	2	<input checked="" type="checkbox"/>	1 English	<input checked="" type="checkbox"/>	2 French	<input type="checkbox"/>	3 Spanish
FUNCTIONS																				
Title	1/2																			
Chapter	3/10																			
Time	0:24:31																			
Audio	1 English																			
Subtitle	2																			
<input checked="" type="checkbox"/>	1 English																			
<input checked="" type="checkbox"/>	2 French																			
<input type="checkbox"/>	3 Spanish																			
4	FUNCTIONS	Press to exit.																		

Main menu

Items shown differ depending on the type of disc.

<p>Program Group</p> <p>Title</p> <p>Chapter</p> <p>Track</p> <p>Playlist</p> <p>Content</p>	<p>To start from a specific item</p> <p>e.g. DVD-VR To select Program 12</p> <p>Press the numbered buttons: [1] → [2] → [ENTER]</p> <table border="1"> <tr><td colspan="2">FUNCTIONS</td></tr> <tr><td>Program</td><td>2/16</td></tr> <tr><td>Time</td><td>0:34:15</td></tr> <tr><td>Audio</td><td></td></tr> </table> <table border="1"> <tr><td>Program Search</td><td>12</td></tr> </table>	FUNCTIONS		Program	2/16	Time	0:34:15	Audio		Program Search	12
FUNCTIONS											
Program	2/16										
Time	0:34:15										
Audio											
Program Search	12										
Time	<p>(Time Slip does not work with +R/+RW discs.)</p> <p>To skip incrementally or decrementally (Time Slip for play only)</p> <ol style="list-style-type: none"> Press [ENTER] twice to show the Time Slip indicator. Press [▲, ▼] to select the time and press [ENTER]. <ul style="list-style-type: none"> To change the steps more quickly, press and hold [▲, ▼]. <p>To change remaining/elapsed time display</p>										
Audio	<p>DVD-V (with multiple soundtracks)</p> <p>To select audio soundtrack</p> <p>DVD-VR VCD</p> <p>To select "L", "R" or "LR"</p> <p>DVD-V (Karaoke disc)</p> <p>To select "On" or "Off" for vocals</p> <ul style="list-style-type: none"> Read the disc's instructions for details. <p>Signal type/data</p> <p>LPCM/PPCM/DD Digital/DTS/MP3/MPEG: Signal type</p> <p>kHz (Sampling frequency)/bit/ch (Number of channels)</p> <p>e.g. 3/2 .1ch</p> <ul style="list-style-type: none"> .1: Low frequency effect (not displayed if there is no signal) 0: No surround 1: Mono surround 2: Stereo surround (left/right) 1: Center 2: Front left+Front right 3: Front left+Front right+Center <p>WMA MP3</p> <p>To display the current bitrate or sampling frequency</p>										

Number Select	<p>VCD with playback control</p> <p>To select number</p> <p>While the disc menu is displayed</p> <p>Press [▲, ▼] → Press [ENTER]</p> <ul style="list-style-type: none"> To change the numbers more quickly, press and hold [▲, ▼].
Thumbnail	<p>To show thumbnail images</p>
Subtitle	<p>DVD-V (with multiple subtitles) VCD (SVCD only)</p> <p>To select subtitle language</p> <ul style="list-style-type: none"> On +R/+RW, a subtitle number may be shown for subtitles that are not displayed. DVD-VR "On" or "Off" appears only with discs that contain subtitle on/off information (Subtitle on/off information cannot be recorded using Panasonic DVD Recorders).
Marker (VR)	<p>DVD-VR</p> <p>To recall a marker recorded on DVD-Video recorders</p> <p>Press [▲, ▼] → Press [ENTER].</p>
Angle	<p>(with multiple angles)</p> <p>To select a video angle</p>
Rotate Picture	<p>To rotate a picture</p>
Slideshow	<p>To turn slideshow on/off</p> <p>On ↔ Off</p> <p>To change the slideshow timing</p> <p>1 (Fast) to 5 (Slow)</p>
Other Settings	<p>(→ page 21)</p>

Play Speed	DVD-VR DVD-V
	<p>To change play speed – from “×0.6” to “×1.4”</p> <ul style="list-style-type: none"> • Press [▶ PLAY] to return to normal play. • After you change the speed <ul style="list-style-type: none"> – Dolby Pro Logic II has no effect. – Audio output switches to 2-channel stereo. – Sampling frequency of 96 kHz is converted to 48 kHz. • This function may not work depending on the disc’s recording.

■ **Play Menu**

This works only when the elapsed play time can be displayed. It also works with all JPEG content.

Repeat	To repeat a selected item
A-B Repeat	<p>Except JPEG DVD-VR (Still picture part)</p> <p>To repeat a specified section Press [ENTER] at the starting and ending points. Press [ENTER] again to cancel.</p>
Advanced Disc Review	<p>DVD-VR (Except still picture part) DVD-V (Except +R/+RW)</p> <p>Allows you to browse the disc contents and start playing from the selected position. You can select either “Intro Mode” or “Interval Mode” in “Advanced Disc Review” in the “Disc” menu (→ page 23).</p> <p>When you find a title/program to play Press [▶ PLAY].</p> <ul style="list-style-type: none"> • This may not work depending on the disc and the play position. • DVD-VR This does not work when playing a playlist (→ page 19).

■ **Picture Menu**

Picture Mode	<p>Normal</p> <p>Cinema1: Mellows images and enhances detail in dark scenes.</p> <p>Cinema2: Sharpens images and enhances detail in dark scenes.</p> <p>Animation: Suitable for animation.</p> <p>Dynamic: Enhances the contrast for powerful images.</p> <p>User: Press [ENTER] to select “Picture Adjustment” (→ below).</p>
	<p>Picture Adjustment</p> <p>Contrast: Increases the contrast between light and dark parts of the picture.</p> <p>Brightness: Brightens the picture.</p> <p>Sharpness: Adjusts the sharpness of the edges of horizontal lines.</p> <p>Color: Adjusts the shade of the picture’s color.</p> <p>Gamma: Adjusts the brightness of dark parts.</p> <p>Depth Enhancer: Reduces the rough noise in the background to give a greater feeling of depth.</p>
Video Output Mode	<p>To select suitable picture quality with your television (Video recordings will be converted to, and output as, high-definition video.)</p> <p>When HDMI connection is being used and “Video Mode” (→ page 24, “HDMI” menu) is set to “On”</p> <p>480i (interlaced) 480p (progressive) 720p (progressive) 1080i (interlaced) 1080p (progressive)</p> <ul style="list-style-type: none"> • Select a video output with an “*” mark. The “*” mark shows that the video output is acceptable with your television. • Selecting a video output without an “*” mark can result in the picture being distorted. If the picture is distorted, press and hold [CANCEL] until the picture is displayed correctly. (The output will return to “480p”.) • Output from the COMPONENT VIDEO OUT terminals will be “480i”. <p>When HDMI connection is not being used or “Video Mode” (→ page 24, “HDMI” menu) is set to “Off”</p> <p>480i (interlaced) 480p (progressive)</p> <ul style="list-style-type: none"> • When you select “480p”, a confirmation screen appears. Select “Yes” only if connecting to a progressive output compatible television.
	<p>Transfer Mode</p> <p>If you have chosen “480p”, “720p”, “1080i” or “1080p” (→ above), select the method of conversion for progressive output to suit the type of material.</p> <p>Auto1: Detects 24 frame-per-second film content and appropriately converts it.</p> <p>Auto2: Compatible with 30 frame-per-second film content in addition to 24 frame-per-second film content.</p> <p>Video: Select if the video content is distorted when using Auto1 or Auto2.</p>

(Continued on next page)



Other Settings

Items shown differ depending on the type of disc.

Picture Menu (Continued)

HD Picture Enhancer	<p>This works when the HDMI connection is being used and "Video Mode" (→ page 24, "HDMI" menu) is set to "On".</p> <p>To sharpen the "720p", "1080i" and "1080p" picture quality Off ← 1 ← 2 ← 3 (sharpest picture)</p>
HDMI Color Space	<p>This works when the HDMI connection is being used and "Video Mode" (→ page 24, "HDMI" menu) is set to "On".</p> <p>To select suitable picture color with your television</p> <p>RGB YCbCr (4:4:4) YCbCr (4:2:2)</p> <ul style="list-style-type: none"> • If the setting above is not compatible with your television, it will not be displayed. • "RGB Range" (→ page 24, "HDMI" menu) is available when "RGB" is selected.

Audio Menu

Dolby Pro Logic II	(→ page 30, Enhancing the stereo sound: Dolby Pro Logic II/Super Surround)
Dialogue Enhancer	<p>To make the dialogue in movies easier to hear</p> <p>DVD-V (Dolby Digital, DTS, 3-channel or higher, with the dialogue recorded in the center channel)</p> <p>On ← Off</p>

Display Menu

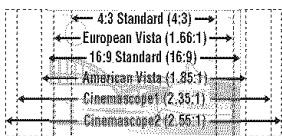
Information	JPEG: On ← Off
Subtitle Position	0 to -60 (in 2 unit steps)
Subtitle Brightness	Auto, 0 to -7
4:3 Aspect	<p>To select how to show images made for 4:3 aspect screens on a 16:9 aspect television</p> <p>Normal: Laterally stretches images. Auto: Expands 4:3 letterbox images to fill more of the screen. Other images appear in full in the center of the screen. Shrink: Images appear in the center of the screen. Zoom: Expands to 4:3 aspect ratio. If your television has a similar feature, use it instead for a better effect.</p>
Just Fit Zoom	<p>To select the appropriate screen size to fit your television screen</p> <p>DVD-VR DVD-V VCD</p> <p>Auto, 4:3 Standard, European Vista, American Vista, Cinemascope1, Cinemascope2</p> <p>e.g.</p> 

Manual Zoom	<p>To zoom in and out manually</p> <ul style="list-style-type: none"> - in 0.01-unit steps from "x 1.00" to "x 1.60" - in 0.02-unit steps from "x 1.60" to "x 2.00" <p>• To change the steps more quickly, press and hold [▲, ▼].</p>
Bit Rate Display	DVD-VR DVD-V VCD On ← Off
GUI See-through	To make the on-screen menu transparent Off, On, Auto
GUI Brightness	To adjust the on-screen menu brightness -3 to +3
HDMI Status	Indicates various information when connected with HDMI AV OUT terminal. (→ below, Confirming HDMI information)

Other Menu

Setup	(→ page 23)
Play as DVD-VR, Play as HighMAT or Play as Data Disc	To use functions for data discs (→ page 18) (To play MP3 or JPEG files on DVD-RAM or DVD-R/RW, or to play a HighMAT disc without using the HighMAT function) Select "Play as Data Disc".

Confirming HDMI information

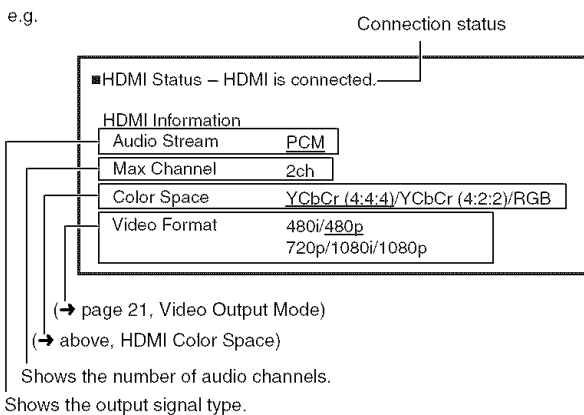

Note

- All possible types of output are displayed.
- The current output for "Audio Stream", "Color Space" and "Video Format" will be underlined.
 (If you select a video output without an "*" mark in the "Video Output Mode" in Picture Menu, the selected video format will not be underlined.)
- When "Off" is selected in "Audio Output" (→ page 24, "HDMI" menu), "—" will be displayed in "Audio Stream" and "Max Channel".

Changing the player settings

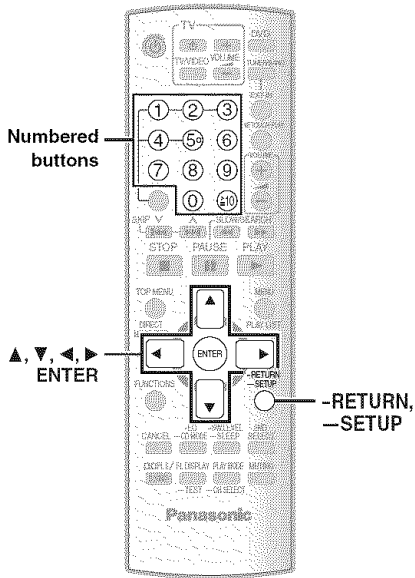

- The settings remain intact even if you switch the unit to standby.
- Underlined items are the factory settings in the following table.

<p>1</p>	<p>Press and hold to show the Setup menu.</p> <p>Menu</p> <p>If you have not performed QUICK SETUP (→ page 9), the QUICK SETUP screen appears.</p>
<p>2</p>	<p>Select the menu.</p>
<p>3</p>	<p>Select the item.</p>
<p>4</p>	<p>Make the settings.</p> <ul style="list-style-type: none"> • Numbered buttons can be used.
<p>5</p>	<p>Press to exit.</p>

QUICK SETUP enables successive settings of the items in the shaded area.

■ “Disc” menu

<p>Audio Choose the audio language.</p>	<p>• <u>English</u> • French • Spanish • Original*¹ • Other* * * * *²</p>
<p>Subtitle Choose the subtitle language.</p>	<p>• <u>Automatic</u>*³ • English • French • Spanish • Other* * * * *²</p>
<p>Menus Choose the language for disc menus. Changing the menu language in QUICK SETUP also changes this setting.</p>	<p>• <u>English</u> • French • Spanish • Other* * * * *²</p>
<p>Advanced Disc Review (→ page 21)</p>	<p>• <u>Intro Mode</u>: Reviews each title/program. • <u>Interval Mode</u>: Reviews not only each title/program but also each 10-minute interval within a title/program.</p>
<p>Ratings Set a rating level to limit DVD-Video play.</p>	<p>Setting ratings (When level 8 is selected) • <u>8 No Limit</u> • 1 to 7 • 0 Lock All: To prevent play of discs without rating levels.</p> <p>When you select your ratings level, a password screen is shown. Follow the on-screen instructions. Do not forget your password. A message screen will be shown if a DVD-Video disc exceeding the rating level is inserted in the unit. Enter your password and then follow the on-screen instructions.</p>

*¹ The original language designated on the disc is selected.

*² Input the appropriate code from the language code list (→ page 25).



*³ If the language selected for “Audio” is not available, subtitles appear in that language (if available on the disc).

(Continued on next page)

Changing the player settings

QUICK SETUP enables successive settings of the items in the shaded area.

■ “Video” menu

TV Aspect Choose the setting to suit your television and preference.	<ul style="list-style-type: none"> ● 4:3 Pan&Scan: Regular aspect television (4:3) The sides of the widescreen picture are cut off so it fills the screen (unless prohibited by the disc). ● 4:3 Letterbox: Regular aspect television (4:3) Widescreen picture is shown in the letterbox style. ● 16:9: Widescreen television (16:9) 	 
TV Type Select to suit the type of television.	<ul style="list-style-type: none"> ● Standard (Direct View TV) ● Projection TV ● CRT Projector ● Plasma TV ● LCD TV/Projector 	
Time Delay When connected with a Plasma display, adjust if you notice the audio is out of sync with the video.	<ul style="list-style-type: none"> ● 0ms ● 20ms ● 40ms ● 60ms ● 80ms ● 100ms 	
Still Mode Specify the type of picture shown when paused.	<ul style="list-style-type: none"> ● Automatic ● Field^{*4}: The picture is not blurred, but picture quality is lower. ● Frame^{*4}: Overall quality is high, but the picture may appear blurred. 	
Black Level Control Change the black level of the picture if you connected a television through the COMPONENT VIDEO OUT terminals.	<ul style="list-style-type: none"> ● Lighter: When connected through VIDEO OUT. ● Darker: When connected through COMPONENT VIDEO OUT (Y/P_B/P_R). 	

^{*4} Refer to “Frame still and field still” (→ page 32, Glossary).

■ “Audio” menu

Dolby Digital^{*5}	<ul style="list-style-type: none"> ● Bitstream ● PCM 	Select to suit the type of equipment you connected to the HDMI AV OUT terminal.
DTS Digital Surround^{*5}	<ul style="list-style-type: none"> ● Bitstream ● PCM 	Select “Bitstream” when the equipment can decode the bitstream (digital form of 5.1-channel data). Otherwise, select “PCM” (audio output is 2-channel). (If the bitstream is output to the equipment without a decoder, high levels of noise can be output and may damage your speakers and hearing.)
Dynamic Range Compression	<ul style="list-style-type: none"> ● Off ● On: Adjusts for clarity even when the volume is low. Convenient for late night viewing. (Only works with Dolby Digital) 	
Speaker Settings (→ page 25) Set the delay time for your center and surround speakers.	<ul style="list-style-type: none"> ● Center: 0.0/1.0/2.0/3.0/4.0/5.0 ms ● Surround (L/R): 0.0/5.0/10.0/15.0 ms 	

^{*5} When audio is output from HDMI AV OUT terminal, and the connected equipment does not support the item selected, the actual output will depend on the performance of this connected equipment.

■ “HDMI” menu

RGB Range Set “HDMI Color Space” to “RGB” (→ page 22, Picture Menu).	<ul style="list-style-type: none"> ● Standard ● Enhanced: When the black and white images are not distinct. 	
Video Mode (This setting is irrelevant when connected through the VIDEO OUT terminal.)	<ul style="list-style-type: none"> ● On: When connected through the HDMI AV OUT terminal. Video is output from the HDMI terminal. Video is also output from the COMPONENT VIDEO OUT terminal, but only in 480i (interlaced). ● Off: When connected through the COMPONENT VIDEO OUT terminal. Video is output from the COMPONENT VIDEO OUT terminal according to the setting of the “Video Output Mode” (→ page 21, Picture Menu). Video is also output from the HDMI AV OUT terminal, but only in 480p (progressive). 	
Audio Output	<ul style="list-style-type: none"> ● On: When audio output is from the HDMI AV OUT terminal. (Depending on the capabilities of the connected equipment, audio output may differ from the audio settings of the main unit.) ● Off: When audio output is not from the HDMI AV OUT terminal. (The audio is output using the settings of the main unit.) 	
EZ Sync	<ul style="list-style-type: none"> ● On: The EZ Sync “HDAVI Control” function is available (→ page 26). ● Off 	

■ “Display” menu

Menu Language	<ul style="list-style-type: none"> ● English ● Français ● Español 	
On-Screen Messages	<ul style="list-style-type: none"> ● On ● Off 	



QUICK SETUP enables successive settings of the items in the shaded area.

■ “Others” menu

FL Dimmer Change the brightness of the unit's display.	<ul style="list-style-type: none"> ● <u>Bright</u> ● Dim ● Auto: The display is dimmed, but brightens when you perform some operations.
QUICK SETUP	<ul style="list-style-type: none"> ● <u>Yes</u> ● No
Re-initialize Setting Return all values in the Setup menus to the default settings.	<ul style="list-style-type: none"> ● Yes: The password screen is shown if “Ratings” (→ page 23) is set. Please enter the same password. After “INIT” on the display disappears, turn the unit off and on again. ● No

Changing the delay time of the speakers

(Effective when playing 5.1-channel sound)

(Center and surround speakers only)

For optimum listening with 5.1-channel sound, all the speakers, except for the subwoofer, should be the same distance from the seating position. If you have to place the center or surround speakers closer to the seating position, adjust the delay time to make up for the difference.

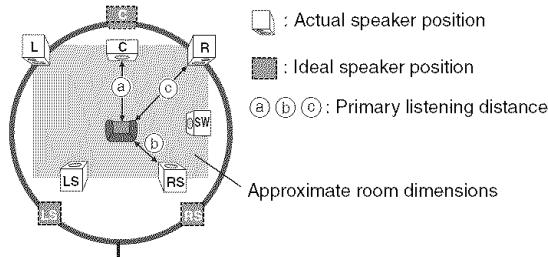

Circle of constant primary listening distance

If either distance **a** or **b** is less than **c**, find the difference in the table and change to the recommended setting.

a) Center speaker		b) Surround speaker	
Difference (Approx.)	Setting	Difference (Approx.)	Setting
30 cm (1 foot)	1.0 ms	150 cm (5 feet)	5.0 ms
60 cm (2 feet)	2.0 ms	300 cm (10 feet)	10.0 ms
90 cm (3 feet)	3.0 ms	450 cm (15 feet)	15.0 ms
120 cm (4 feet)	4.0 ms		
150 cm (5 feet)	5.0 ms		

- 1 Press [**▲**, **▼**] to select the delay time box and press [ENTER].
- 2 Press [**▲**, **▼**] to adjust the delay time and press [ENTER].

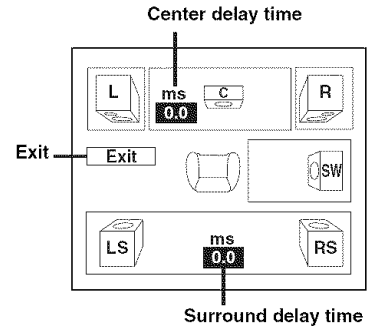

To finish the speaker setting

Press [**◀**] to select “Exit” and press [ENTER].

When you change the surround speaker setting for Dolby Digital, the setting also changes for Dolby Pro Logic II. e.g., the settings for Music are the same as those for Dolby Digital.

Dolby Digital	Dolby Pro Logic II	
	Music	Movie
0 ms	0 ms	10 ms
5 ms	5 ms	15 ms
10 ms	10 ms	20 ms
15 ms	15 ms	25 ms

Language code list

Abkhazian: 6566	Danish: 6865	Italian: 7384	Norwegian: 7879	Swedish: 8386
Afar: 6565	Dutch: 7876	Japanese: 7465	Oriya: 7982	Tagalog: 8476
Afrikaans: 6570	English: 6978	Javanese: 7487	Pashto, Pushto: 8083	Tajik: 8471
Albanian: 8381	Esperanto: 6979	Kannada: 7578	Persian: 7065	Tamil: 8465
Ameharic: 6577	Estonian: 6984	Kashmiri: 7583	Polish: 8076	Tatar: 8484
Arabic: 6582	Faroese: 7079	Kazakh: 7575	Portuguese: 8084	Telugu: 8469
Armenian: 7289	Fiji: 7074	Kirghiz: 7589	Punjabi: 8065	Thai: 8472
Assamese: 6583	Finnish: 7073	Korean: 7579	Quechua: 8185	Tibetan: 6679
Aymara: 6589	French: 7082	Kurdish: 7585	Rhaeto-Romance: 8277	Tigrinya: 8473
Azerbaijani: 6590	Frisian: 7089	Laotian: 7679	Romanian: 8279	Tonga: 8479
Bashkir: 6665	Galician: 7176	Latin: 7665	Russian: 8285	Turkish: 8482
Basque: 6985	Georgian: 7565	Latvian, Lettish: 7686	Samoan: 8377	Turkmen: 8475
Bengali, Bangla: 6678	German: 6869	Lingala: 7678	Sanskrit: 8365	Twi: 8487
Bhutani: 6890	Greek: 6976	Lithuanian: 7684	Scots Gaelic: 7168	Ukrainian: 8575
Bihari: 6672	Greenlandic: 7576	Macedonian: 7775	Serbian: 8382	Urdu: 8582
Breton: 6682	Guarani: 7178	Malagasy: 7771	Serbo-Croatian: 8372	Uzbek: 8590
Bulgarian: 6671	Gujarati: 7185	Malay: 7783	Shona: 8378	Vietnamese: 8673
Burmese: 7789	Hausa: 7265	Malayalam: 7776	Sindhi: 8368	Volapük: 8679
Byelorussian: 6669	Hebrew: 7387	Maltese: 7784	Singhalese: 8373	Welsh: 6789
Cambodian: 7577	Hindi: 7273	Maori: 7773	Slovak: 8375	Wolof: 8779
Catalan: 6765	Hungarian: 7285	Marathi: 7782	Slovenian: 8376	Xhosa: 8872
Chinese: 9072	Icelandic: 7383	Moldavian: 7779	Somali: 8379	Yiddish: 7473
Corsican: 6779	Indonesian: 7378	Mongolian: 7778	Spanish: 6983	Yoruba: 8979
Croatian: 7282	Interlingua: 7365	Nauru: 7865	Sundanese: 8385	Zulu: 9085
Czech: 6783	Irish: 7165	Nepali: 7869	Swahili: 8387	

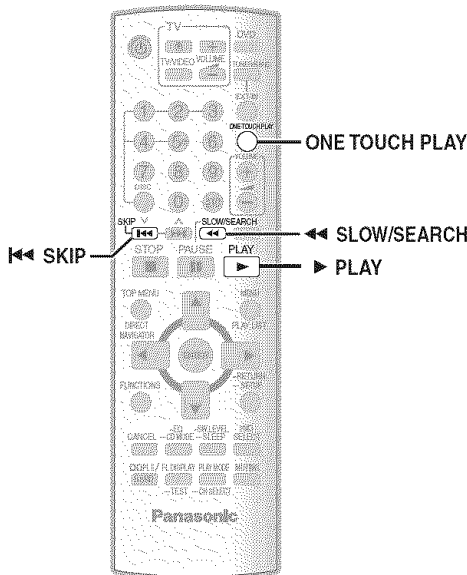

EZ Sync “HDAVI Control”

EZ Sync “HDAVI Control” is a convenient function that offers linked operations of this unit, and a Panasonic television (VIERA) under “HDAVI Control”. You can use this function by connecting the equipment with the HDMI cable. See the operating instructions for connected equipment for operational details.

This unit supports “HDAVI Control 2” function.

The TV with “HDAVI Control 2” function enables the following operation: EZ Sync Control only with TV’s remote control (for “HDAVI Control 2”) (→ right)

Preparation

- Confirm that the HDMI connection (→ page 6) has been made.
- Set “EZ Sync” to “On” (→ page 24, “HDMI” menu).
- To complete and activate the connection correctly, turn on all EZ Sync “HDAVI Control” compatible equipment and set the television to the corresponding HDMI input mode for the home theater system.

Whenever the connection or settings are changed, reconfirm the points above.

One touch play

You can turn on the home theater system and television, and start playing the disc in the play position with a single press of a button.

Press [ONE TOUCH PLAY].

Theater speakers will be automatically activated (→ right).

- This function also works if you press [▶ PLAY] on the home theater remote control during home theater standby mode.

Note

Playback may not be immediately displayed on the television. If you miss the beginning portion of playback, press [◀◀] or [◀] to go back to where playback started.

Auto input switching

- When you switch the television input to:
 - TV tuner mode, the home theater system will automatically switch to “AUX”.
 - HDMI input mode for the home theater system, the home theater system will automatically switch to “DVD/CD” if it is in “AUX” mode.
- When you start disc play, the television will automatically switch to the HDMI input mode for the home theater system.

Speaker control

You can select whether audio is output from the home theater system or the television speakers by using the television menu settings. For details, refer to the operating instructions of your television.

Home theater

Theater speakers are active.

- When the home theater system is in standby mode, changing the television speakers to theater speakers in the television menu will automatically turn the home theater system on and select “AUX” as the source.
- The television speakers are automatically muted.
- You can control the volume setting using the volume or mute button on the TV’s remote control. (The volume level is displayed on the main unit’s FL display.)
- To cancel muting, you can also use the home theater remote control (→ page 10).
- If you turn off the home theater system, television speakers will be automatically activated.

TV

Television speakers are active.

- The volume of the home theater system is set to “0”.
 - This function works only when “DVD/CD” or “AUX” is selected as the source on the home theater system.
- Audio output is 2-channel audio.

- When switching between the theater and television speakers, the TV screen may be blank for several seconds.

Power off link

When the television is turned off, the home theater system goes into standby mode automatically.

- This function works only when “DVD/CD” or “AUX” is selected as the source on the home theater system.
- When the television is turned on, the home theater system does not turn on automatically. (Power on link is not available.)

Note

Only the home theater system turns off when you press [⏻] for shutting it down. Other connected equipment compatible with EZ Sync “HDAVI Control” stay on.

EZ Sync Control only with TV’s remote control (for “HDAVI Control 2”)

You can control the disc menus of the home theater system with the TV’s remote control when using the “DVD/CD” source. When operating the TV’s remote control, refer to the below illustration for operation buttons.

- 1 Select the theater operation menu by using the television menu settings. (For details, refer to the operating instructions of your television.)

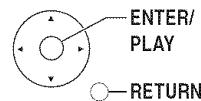

- The home theater system will automatically switch to “DVD/CD” if it is in “AUX” mode.
- 2 Select the desired item.
 - “TOP MENU”: Shows a disc top menu (→ page 15, 18) or program list (→ page 19).
 - “MENU”: Shows a disc menu (→ page 15, 18) or play list (→ page 19).
 - “Control Panel”: The basic operations for discs are available.

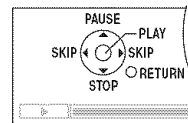
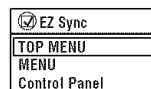

Note

- Depending on the menu, some button operations cannot be performed from the TV’s remote control.
- “Control Panel” can be selected directly by using a button on the TV’s remote control (e.g. [SUB MENU]).



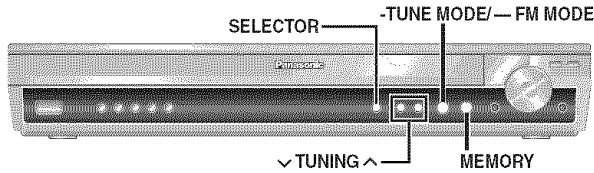
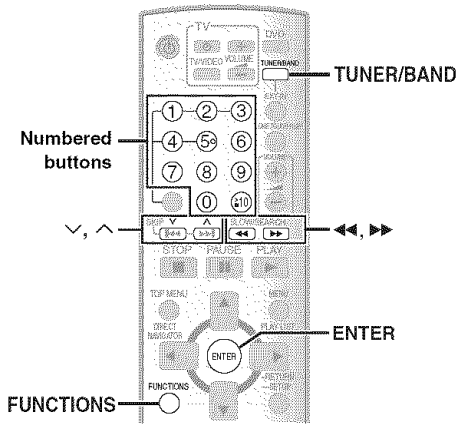

Radio operations are described mainly with the remote control. You can alternatively use the corresponding button on the main unit.

*1 [SELECTOR] *2 [v TUNING ^] *3 [MEMORY]

Presetting stations automatically

Up to 30 stations can be set in each band, FM and AM.

1 Press [TUNER/BAND]*1 to select "FM" or "AM".

2 Press and hold [ENTER]*3.

Release the button when "FM AUTO" or "AM AUTO" is displayed.

The tuner tunes to the lowest frequency and starts to preset all the stations it can receive into the channels in ascending order.

- "SET OK" is displayed when the stations are set, and the radio tunes to the last preset station.
- "ERROR" is displayed when automatic presetting is unsuccessful. Preset the channels manually (→ right).

Selecting the preset channels

1 Press [TUNER/BAND]*1 to select "FM" or "AM".

2 Press the numbered buttons to select the channel.

- To select a 2-digit number
e.g. 12: [≥10] → [1] → [2]

Alternatively, press [v, ^].

- To perform this step on the main unit, first press [-TUNE MODE] to select "PRESET", and then press [v TUNING ^] to select the channel.

When a stereo FM broadcast is being received, "ST" lights in the display.

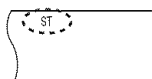

If noise is excessive

When "FM" is selected

Press and hold [-FM MODE] on the main unit to display "MONO".



Press and hold [-FM MODE] again to cancel the mode.

- The mode is also canceled when you change the frequency.

When "AM" is selected

Press [FUNCTIONS] on the remote control.

Each time you press the button: BP 2 ← BP 1

Manual tuning

1 Press [TUNER/BAND]*1 to select "FM" or "AM".

2 Press [◀▶]*2 to select the frequency.

- When performing this step on the main unit, first press [-TUNE MODE] to select "MANUAL", and then press [v TUNING ^] to select the frequency.
- To start automatic tuning, press and hold [◀▶]*2 until the frequency starts scrolling. Tuning stops when a station is found.

Presetting the channel

Up to 30 stations can be set in each band, FM and AM.

① While listening to the radio broadcast

Press [ENTER]*3.

② While the frequency and "PGM" are flashing on the display Press the numbered buttons to select a channel.

- To select a 2-digit number

e.g. 12:
[≥10] → [1] → [2]

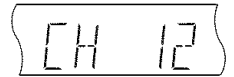

Alternatively, press [v, ^], and then press [ENTER]*3.

A station previously stored is overwritten when another station is stored in the same channel preset.

FM frequency step

Main unit only

The step is factory-set to 0.2-MHz, but you can change it to receive broadcasts allocated in 0.1-MHz steps.

① Press [SELECTOR] to select "FM".

② Press and hold [SELECTOR].

After a few seconds the display changes to show the current minimum frequency. Continue to hold the button down. The minimum frequency changes and the step is changed.

To return to the original step, repeat steps ① and ②.

Note

After changing the setting, previously preset frequencies will be cleared. Preset them again.



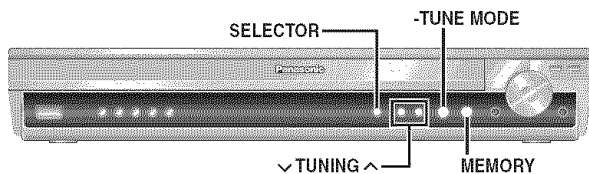
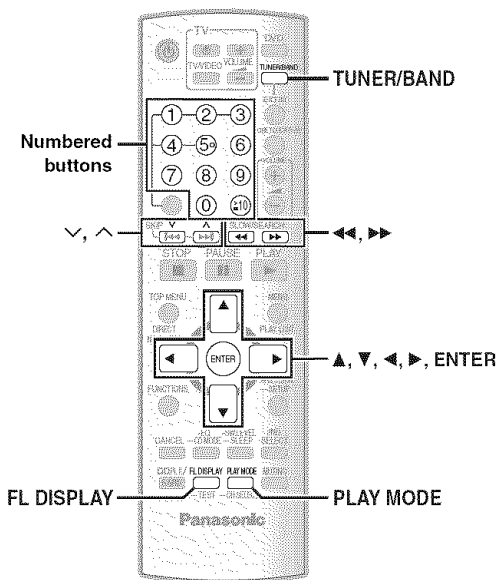

Radio operations are described mainly with the remote control. You can alternatively use the corresponding button on the main unit.

※1 [SELECTOR] ※2 [TUNING] ※3 [MEMORY] ※4 [-TUNE MODE]

XM Satellite Radio

XM Satellite Radio is the provider of satellite radio. XM offers more than 170 digital radio channels with music, talk, news, sports, comedy, traffic and weather reports. To enjoy XM Satellite Radio, subscription is required.

For more information, visit XM on the Web at www.xmradio.com for U.S. customers, or www.xmradio.ca for Canada customers.

How to Subscribe

XM monthly service subscription sold separately. XM Connect & Play antenna, or XM Passport Mini-Tuner and Home Dock (includes home antenna) required to receive XM service (sold separately). Channels with frequent explicit language are indicated with an XL. Channel blocking is available for XM radio receivers by calling 1-800-XMRADIO (U.S. residents) or 1-877-GET-XMSR (Canada residents). Subscriptions subject to Customer Agreement available at xmradio.com (U.S. residents) and xmradio.ca (Canada residents). Only available in the 48 contiguous United States and Canada. ©2006 XM Satellite Radio Inc. All rights reserved. All other trademarks are the property of their respective owners.

• To subscribe in the U.S., visit XM on the Web at www.xmradio.com or call XM's Listener Care at 1-800-XMRADIO (1-800-967-2346).

To subscribe in Canada, visit XM on the Web at www.xmradio.ca or call XM's Listener Care at 1-877-GET-XMSR (1-877-438-9677).

You should have your Radio ID ready (→ right).

Preparation

The XM Satellite Radio ID

Please confirm your XM Satellite Radio ID necessary for activating XM Satellite Radio as follows.

- 1 Press [TUNER/BAND]※1 to select "XM".
 - Ensure the antenna is connected (→ page 7).
- 2 Press [PLAY MODE]※4 to select "MANUAL".

Each time you press the button: MANUAL ← PRESET
- 3 Press [0] to select "XM 0" (XM channel 0).

"RADIO ID" is indicated in the display briefly, followed by an 8-digit alphanumeric ID.
- 4 Note your XM Satellite Radio ID.
 - To avoid ambiguity, the letters I, O, S and F are not used in the ID.



• To exit, press [TUNING]※2 to select another channel.

Optimizing the XM signal reception

The main unit has a signal strength indicator function that allows you to optimize the XM signal reception.

- 1 Press [TUNER/BAND]※1 to select "XM".
 - Ensure the antenna is connected (→ page 7).
- 2 Press and hold [FL DISPLAY] until the XM signal status is displayed.

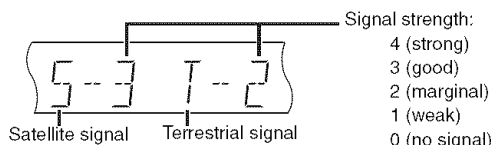

- 3 Position the antenna for the best possible satellite signal reception.

The display changes depending on the signal strength.

• If the satellite signal is weak or not available, you can optimize for the terrestrial signal (where available).

- 4 Press [FL DISPLAY] to return to the previous display.

Tips for optimizing reception

- To prevent interference with wireless equipment, place the antenna away from this unit, Panasonic wireless sound system SH-FX80/SH-FX85, Panasonic wireless system SH-FX50/SH-FX60/SH-FX65, and other equipment that emits radio waves (such as radio equipment and microwave ovens).
- Place the antenna near a south-facing window with an unobstructed view of the sky for the best satellite signal reception.
- Refer also to the operating instructions of your XM antenna.

Selecting XM channels by direct entry

XM channels can be selected manually by directly entering the XM channel number.

- 1 Press [TUNER/BAND]*¹ to select "XM".
- 2 Press [PLAY MODE]*⁴ to select "MANUAL".
Each time you press the button: MANUAL ↔ PRESET
- 3 Press the numbered buttons to select the XM channel.
 - To select a 2-digit or 3-digit number
e.g. 12: [≥10] → [1] → [2]
125: [≥10] → [≥10] → [1] → [2] → [5].

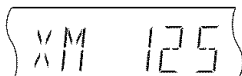

Alternatively, press [◀, ▶]*² to select the desired XM channel.
• Press and hold [◀, ▶]*² to scan through quickly.

Selecting XM channels by category

XM channels are organized into categories such as Rock, Classical, Country and Dance to make browsing and selecting channels easier.

- 1 Press [TUNER/BAND]*¹ to select "XM".
- 2 Press [▲, ▼, ◀, ▶] to enter category tune mode.
The category of the current XM channel flashes on the display.

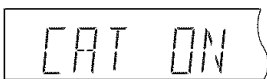

e.g.

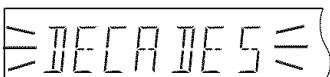

- 3 While the category is flashing
Press [▲, ▼] to select a category.
Available categories vary according to broadcasting hours.
 - Press and hold [▲, ▼] to scan through quickly.
- 4 While the selected category is flashing
Press [◀, ▶] to select a channel in the current category.
The XM channel number and name are displayed briefly, and then the current category flashes on the display.
- 5 Press [ENTER] to exit category tune mode.
The XM channel information will be displayed.

Note

Some XM channels belong to two categories; a primary and secondary category, either of which can be used for XM channel selection. Although you may have selected an XM channel from its secondary category (e.g. DANCE), after exiting and then re-entering category tune mode, the primary category of the XM channel is displayed (e.g. DECADES).

Presetting the XM channels

Channel presets allow you to quickly and conveniently select your favorite XM channels. Up to 30 XM channels can be stored as channel presets.

- 1 While listening to the XM radio broadcast
Press [ENTER]*³.
- 2 While the XM channel and "PGM" are flashing on the display
Press the numbered buttons to select a channel.
 - To select a 2-digit number
e.g. 12: [≥10] → [1] → [2]

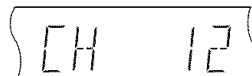

Alternatively, press [v, ^] and then press [ENTER]*³.

- An XM channel previously stored is overwritten when another XM channel is stored in the same channel preset.
- XM channel 0 (RADIO ID) cannot be stored as a channel preset.

Selecting the preset channels

- ① When "XM" is selected
Press [PLAY MODE]*⁴ to select "PRESET".
Each time you press the button: MANUAL ↔ PRESET
- ② Press the numbered buttons to select the desired channel preset.
 - To select a 2-digit number
e.g. 12: [≥10] → [1] → [2]

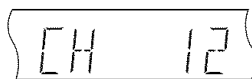

Alternatively, press [v, ^].

Selecting the XM channel information

The XM channel information display can be changed.

While listening to the XM radio broadcast

Press [FL DISPLAY].

Each time you press the button:

XM channel number → XM channel name (factory preset)
↑ ARTIST NAME ← SONG TITLE ← CATEGORY ←

Longer text information will not be fully displayed.

Note

- If there is no text information for the current XM broadcast, "----" is displayed.
- Even if the main unit is turned off, or another source is selected, the setting of channel information will be retained.
- The XM channel number and name are displayed briefly whenever the XM channel is changed.



Enjoying audio from an external source

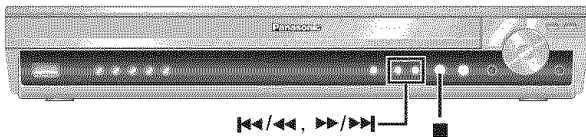
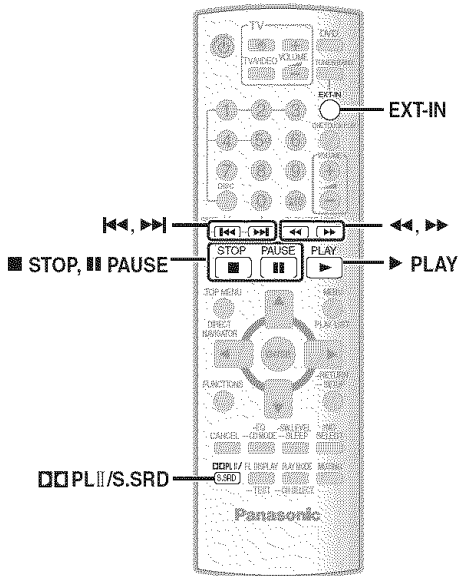

You can enjoy audio from an external source through your home theater system.

Enjoying audio from the television

Preparation

Confirm the audio connection to the AUX terminal on the main unit (→ page 6).

Press [EXT-IN] repeatedly to select “AUX”.

- Reduce the volume on the television to its minimum, and then adjust the volume of the main unit.
- You can enjoy surround sound when you press [PLII/S.SRD] to turn on Super Surround (→ page 30).

Using the Music Port

Preparation

- To avoid distorted sound, make sure that any equalizer function of your external device is turned off.
- Reduce the volume of the main unit and external device.

1 Connect the external device (not included).

Plug type: $\varnothing 3.5$ mm (1/8”) stereo mini plug

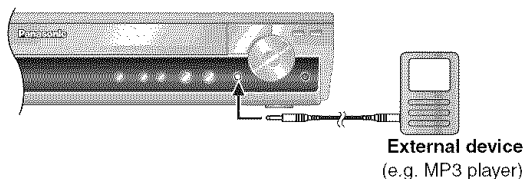

2 Press [EXT-IN] repeatedly to select “MUSIC P.”.

- Adjust the volume on the external device to a normal listening level, and then adjust the volume of the main unit.

Using the iPod

Preparation









- Adjust the volume on the iPod to a normal listening level.
- Reduce the volume of the main unit.
- Confirm the iPod connection (→ page 8).

1 Press [EXT-IN] repeatedly to select “OPTION”.

The iPod turns on.

2 Press [▶ PLAY] to play the iPod.

- Adjust the volume of the main unit.
- You can enjoy surround sound when you press [PLII/S.SRD] to turn on Super Surround (→ page 30).

<p>PAUSE STOP</p>   <p>Alternatively, press [■] on the main unit.</p>	To pause track
<p>(During play/pause)</p>   <p>Alternatively, press [◀◀/▶▶] on the main unit.</p>	To skip a track
<p>(During play/pause)</p>   <p>or press and hold</p>   <p>Alternatively, press and hold [◀◀/▶▶] on the main unit.</p>	To search the current track

When you select another source, or turn the main unit off, the iPod turns off.

Note

Image/video display through the home theater is not available.

Compatible iPod

Name	Memory size
iPod nano 2nd generation (aluminum)	2GB, 4GB, 8GB
iPod 5th generation (video)	60GB, 80GB
iPod 5th generation (video)	30GB
iPod nano 1st generation	1GB, 2GB, 4GB
iPod 4th generation (color display)	40GB, 60GB
iPod 4th generation (color display)	20GB, 30GB
iPod 4th generation	40GB
iPod 4th generation	20GB
iPod mini	4GB, 6GB

- Compatibility depends on the software version of your iPod.



Decoder

A decoder restores the coded audio signals on DVDs to normal. This is called decoding.

Dolby Digital

This is a method of coding digital signals developed by Dolby Laboratories. Apart from stereo (2-channel) audio, these signals can also be 5.1-channel sound.

DTS (Digital Theater Systems)

This surround system is used in many movie theaters around the world. There is good separation between the channels, so realistic sound effects are possible.

Dynamic range

Dynamic range is the difference between the lowest level of sound that can be heard above the noise of the equipment and the highest level of sound before distortion occurs.

Frame still and field still

Frames are the still pictures that go together to make a moving picture. There are about 30 frames shown each second.

One frame is made up of two fields. A regular television shows these fields one after the other to create frames.

A still is shown when you pause a moving picture. A frame still is made up of two alternating fields, so the picture may appear blurred, but overall quality is high.

A field still is not blurred, but it has only half the information of a frame still so picture quality is lower.

HDMI (High-Definition Multimedia Interface)

HDMI is a next-generation digital interface for consumer electronic products. Unlike conventional connections, it transmits uncompressed digital video and audio signals on a single cable. This unit supports high-definition video output (720p, 1080i, 1080p) from the HDMI AV OUT terminal. To enjoy high-definition video, a high-definition compatible television is required.

JPEG (Joint Photographic Experts Group)

This is a system used for compressing/decoding color still pictures. The benefit of JPEG is less deterioration in picture quality considering the degree of compression.

Linear PCM (pulse code modulation)

These are uncompressed digital signals, similar to those found on CDs.

MP3 (MPEG Audio Layer 3)

An audio compression method that compresses audio to approximately one tenth of its size without any considerable loss of audio quality.

Playback control (PBC)

If a Video CD has playback control, you can select scenes and information with menus.

Progressive/Interlaced

NTSC, the video signal standard, has 480 interlaced (i) scan lines, whereas progressive scanning uses twice the number of scan lines. This is called 480p.

Using progressive output, you can enjoy the high-resolution video recorded on media such as DVD-Video.

Your television must be compatible to enjoy progressive video.

Sampling frequency

Sampling is the process of converting the heights of sound wave (analog signal) samples taken at set periods into digits (digital encoding).

Sampling frequency is the number of samples taken per second, so larger numbers mean more faithful reproduction of the original sound.

WMA (Windows Media™ Audio)

WMA is a compression format developed by Microsoft Corporation. It achieves the same sound quality as MP3 with a file size that is smaller than that of MP3.

Product Service

- 1. Damage requiring service**—The unit should be serviced by qualified service personnel if:
 - (a) The AC power supply cord or AC adaptor has been damaged; or
 - (b) Objects or liquids have gotten into the unit; or
 - (c) The unit has been exposed to rain; or
 - (d) The unit does not operate normally or exhibits a marked change in performance; or
 - (e) The unit has been dropped or the cabinet damaged.
- 2. Servicing**—Do not attempt to service the unit beyond that described in these operating instructions. Refer all other servicing to authorized servicing personnel.
- 3. Replacement parts**—When parts need replacing ensure the servicer uses parts specified by the manufacturer or parts that have the same characteristics as the original parts. Unauthorized substitutes may result in fire, electric shock, or other hazards.
- 4. Safety check**—After repairs or service, ask the servicer to perform safety checks to confirm that the unit is in proper working condition.

The servicer will require all components to service your system.

Therefore, should service ever be necessary, be sure to bring the entire system.

Product information

For product information or assistance with product operation:

In the U.S.A., refer to "Customer Services Directory" on page 38.

In Canada, contact the Panasonic Canada Inc. Customer Care Centre at 1-800-561-5505, or visit the website (www.panasonic.ca), or an authorized Servicentre closest to you.

In other areas, consult your dealer.



Troubleshooting guide

Before requesting service, make the following checks. If you are in doubt about some of the check points, or if the solutions indicated in the chart do not solve the problem, refer to "Customer Services Directory" on page 38 if you reside in the U.S.A., or refer to "Product information" on page 32 if you reside in Canada. In other areas, consult your dealer.

Power

No power.	<ul style="list-style-type: none"> Insert the AC power supply cord securely. 	8
The unit is automatically switched to standby mode.	<ul style="list-style-type: none"> The Sleep timer was working and had reached the set time limit. 	10

Unit displays

The display is dark.	<ul style="list-style-type: none"> Select "Bright" in "FL Dimmer" in the "Others" menu. 	25
"NOPLAY"	<ul style="list-style-type: none"> You inserted a disc the unit cannot play; insert one it can. You inserted a blank disc. You inserted a disc that has not been finalized. 	12 — —
"NODISC"	<ul style="list-style-type: none"> You have not inserted a disc; insert one. You have not inserted the disc correctly; insert it correctly. 	— 14
"F61"	<ul style="list-style-type: none"> Check and correct the speaker cable connections. If this does not fix the problem, consult the dealer. 	7
"F76"	<ul style="list-style-type: none"> There is a power supply problem. Consult the dealer. 	—
"DVD U11"	<ul style="list-style-type: none"> Disc may be dirty. Wipe it clean. 	13
"ERROR"	<ul style="list-style-type: none"> Incorrect operation performed. Read the instructions and try again. 	—
"DVD H□□" "DVD F□□□" □ stands for a number.	<ul style="list-style-type: none"> Trouble may have occurred. The numbers following "H" and "F" depend on the status of the unit. Turn the unit off and then back on. Alternatively, turn the unit off, disconnect the AC power supply cord, and then reconnect it. If the service numbers fail to clear, note the service number and contact a qualified service person. 	— —
"W1" or "W2" is flashing.	<ul style="list-style-type: none"> W1 and W2 are the wireless link indicators for the optional wireless accessories: SH-FX65 and SH-FX85 respectively. The flashing will stop after a while. 	—
"U70□" □ stands for a number. The actual number following "U70" will depend on the state of the main unit.	<ul style="list-style-type: none"> The HDMI connection acts unusually. <ul style="list-style-type: none"> The connected equipment is not HDMI-compatible. Please use HDMI cables that have the HDMI logo (as shown on the cover). The HDMI cable is too long. The HDMI cable is damaged. 	— — — —
"XM RADIO"	<ul style="list-style-type: none"> It takes a short time for the XM radio to power up after turning on the main unit, during which time "XM RADIO" is displayed (only when the selected source is XM). Wait a few seconds for this process to complete. 	—
"XM ERROR"	<ul style="list-style-type: none"> There may be an error in the XM radio module. Turn the main unit off, and then back on. The XM antenna may be defective. Consult the dealer of the XM antenna. 	— —
"REMOTE 1" or "REMOTE 2"	<ul style="list-style-type: none"> Match the modes on the main unit and remote control. Depending on the number being displayed ("1" or "2"), press and hold [ENTER] and the corresponding numbered button ([1] or [2]) for at least 2 seconds. 	10

General operation

No response when any buttons are pressed.	<ul style="list-style-type: none"> This unit cannot play discs other than the ones listed in these operating instructions. The unit may not be operating properly due to lightning, static electricity or some other external factor. Turn the unit off and then back on. Alternatively, turn the unit off, disconnect the AC power supply cord, and then reconnect it. Condensation has formed. Wait 1 to 2 hours for it to evaporate. 	12 — —
No response when remote control buttons are pressed.	<ul style="list-style-type: none"> Check that the batteries are installed correctly. The batteries are depleted. Replace them with new ones. Aim the remote control at the remote control signal sensor and operate. 	9 9 11
Other products respond to the remote control.	<ul style="list-style-type: none"> Change the remote control operating mode. 	10
Cannot play DVDs.	<ul style="list-style-type: none"> CD Mode is on. Press and hold [—CD MODE] to turn CD Mode off. 	16
No picture or sound.	<ul style="list-style-type: none"> Check the video or speaker connection. Check the power or input setting of the connected equipment and the main unit. Check that the disc has something recorded on it. 	6, 7 — —
You have forgotten your ratings password. Reset all the settings to Factory Preset.	<ul style="list-style-type: none"> While stopped and "DVD/CD" is the source, press and hold [■] (Stop) on the main unit and [≧10] on the remote control until "Initialized" disappears from the television. Turn the unit off and on again. All settings will return to the default values. 	—
The EZ Sync "HDAVI Control" function does not respond.	<ul style="list-style-type: none"> Depending on the condition of the home theater system or the connected equipment, it may be necessary to repeat the same operation so that the function can work correctly. 	26

(Continued on next page)



Disc operation

It takes time before play starts. [MP3]	<ul style="list-style-type: none"> Play may take time to begin when an MP3 track has still picture data. Even after the track starts, the correct play time will not be displayed. This is normal. 	—
Folders on a data CD are not displayed correctly. [WMA] [MP3] [JPEG]	<ul style="list-style-type: none"> Folders deeper than the eighth layer are displayed as the eighth layer. 	—
A menu screen appears during skip or search. [VCD]	<ul style="list-style-type: none"> This is normal for Video CDs. 	—
Playback control menu does not appear. [VCD] with playback control	<ul style="list-style-type: none"> Press [■ STOP] twice and then press [▶ PLAY]. 	—
Program and Random play do not work. [DVD-V]	<ul style="list-style-type: none"> These functions do not work with some DVD-Videos. 	—
Subtitle position is wrong.	<ul style="list-style-type: none"> Adjust the position. ("Subtitle Position" in Display Menu) 	22
No subtitles.	<ul style="list-style-type: none"> Display the subtitles. ("Subtitle" in Main menu) 	20
Subtitles overlap the closed captions.	<ul style="list-style-type: none"> Clear the subtitles. 	20
Point B is automatically set.	<ul style="list-style-type: none"> The end of an item becomes point B when it is reached. 	—
The Setup menu cannot be accessed.	<ul style="list-style-type: none"> Select "DVD/CD" as the source. Cancel Program and Random play. 	17

Sound

Sound is distorted.	<ul style="list-style-type: none"> Noise may occur when playing WMA. When using the HDMI output, audio may not be output from other terminals. 	— —
Effects do not work.	<ul style="list-style-type: none"> Some audio effects do not work or have less effect with some discs. 	—
Humming is heard during play.	<ul style="list-style-type: none"> An AC power supply cord or fluorescent light is near the main unit or wireless system. Keep other appliances and cables away from the main unit and wireless system. 	—
No sound.	<ul style="list-style-type: none"> There may be a slight pause in sound when you change the play speed. Audio may not be heard when more than 4 devices are connected with HDMI cables. Reduce the number of connected devices. When using the HDMI connection, ensure that "Audio Output" in the "HDMI" menu is set to "On". 	— — 24

Picture

The picture on the television is not displayed correctly or disappears.	<ul style="list-style-type: none"> Ensure that the unit is connected directly to the television, and is not connected through a video cassette recorder. 	6
	<ul style="list-style-type: none"> Mobile telephone chargers can cause some disturbance. 	—
	<ul style="list-style-type: none"> If you are using an indoor television antenna, change to an outdoor antenna. 	—
	<ul style="list-style-type: none"> The television antenna wire is too close to the unit. Move it away from the unit. 	—
	<ul style="list-style-type: none"> Picture may not be seen when more than 4 devices are connected with HDMI cables. Reduce the number of connected devices. 	—
	<ul style="list-style-type: none"> When using the COMPONENT VIDEO OUT terminal, ensure that progressive output is not selected when the connected television is not progressive compatible. Press and hold [CANCEL] until the picture is displayed correctly. (The output will return to "480i".) 	21
	<ul style="list-style-type: none"> When using the HDMI AV OUT terminal, ensure that video output unacceptable with the connected television is not selected. Press and hold [CANCEL] until the picture is displayed correctly. (The output will return to "480p".) 	21
Picture size does not fit the screen.	<ul style="list-style-type: none"> Change "TV Aspect" in the "Video" menu. 	24
	<ul style="list-style-type: none"> Use the television to change the aspect. If your television does not have that function, change "4:3 Aspect" in Display Menu. 	22
	<ul style="list-style-type: none"> Change the Zoom setting. ("Just Fit Zoom" or "Manual Zoom" in Display Menu) 	22
Menu is not displayed correctly.	<ul style="list-style-type: none"> Restore the zoom ratio to "× 1.00". ("Manual Zoom" in Display Menu) 	22
	<ul style="list-style-type: none"> Set "Subtitle Position" in Display Menu to "0". 	22
	<ul style="list-style-type: none"> Set "4:3 Aspect" in Display Menu to "Normal". 	22
Auto zoom function does not work well.	<ul style="list-style-type: none"> Turn off television's zoom function. 	—
	<ul style="list-style-type: none"> Use the other preset aspect ratios or manual adjustment. 	22
	<ul style="list-style-type: none"> Zoom function may not work well, especially in dark scenes and may not work depending on the type of disc. 	—

iPod with Universal Dock for iPod

Cannot charge or operate even when the indicator on the dock lights.	<ul style="list-style-type: none"> Check that the iPod is connected firmly. The battery of the iPod is depleted. Charge the iPod, and then operate again. 	8 —
--	---	--------



HDMI or progressive video

There is ghosting when HDMI or progressive output is on.	<ul style="list-style-type: none"> This problem is caused by the editing method or material used on DVD-Video, but should be corrected if you use interlaced output. <ul style="list-style-type: none"> When using the COMPONENT VIDEO OUT terminal, set "Video Output Mode" in Picture Menu to "480i". (Alternatively, press and hold [CANCEL] to switch to "480i".) When using the HDMI AV OUT terminal, set "Video Output Mode" in Picture Menu to "480i" output marked with an "*". Else, disable the HDMI AV OUT connection and use other video connections. Make the settings in the following order: <ol style="list-style-type: none"> Set "Video Mode" in the "HDMI" menu to "Off". Set "Video Output Mode" in Picture Menu to "480i". (Alternatively, press and hold [CANCEL] to switch to "480i".) 	21 21, 24
Pictures not in progressive output.	<ul style="list-style-type: none"> Select "480p" in "Video Output Mode" in Picture Menu. The unit's VIDEO OUT terminal outputs the interlaced signal even if "PRG" is displayed. 	21 6
Closed captions not displayed.	<ul style="list-style-type: none"> When HDMI or progressive output is on, closed captions will not be displayed. 	—

Radio

Distorted sound or noise is heard. "ST" flickers or does not light.	<ul style="list-style-type: none"> Adjust the position of the FM or AM antenna. Use an outdoor antenna. 	— 7
A beat sound is heard.	<ul style="list-style-type: none"> Turn the television off or move it away from the unit. 	—
A low hum is heard during AM broadcasts.	<ul style="list-style-type: none"> Separate the antenna from other cables. 	—

Television displays

"⊘"	<ul style="list-style-type: none"> The operation is prohibited by the unit or disc. 	—
"Cannot display group xx, content xx"	<ul style="list-style-type: none"> You are trying to display incompatible contents. 	—
"This disc may not be played in your region"	<ul style="list-style-type: none"> Only DVD-Video discs that include or have the same region number as the one on the rear panel of this unit can be played. 	Cover page
No on-screen display.	<ul style="list-style-type: none"> Select "On" in "On-Screen Messages" in the "Display" menu. 	24
Main unit's screen saver remains	<ul style="list-style-type: none"> When using the HDMI connection, audio/video information is continually transferred between the main unit and the television regardless of which source has been selected on the main unit. This is normal. 	—

XM Satellite Radio advisory messages

"ANTENNA" is flashing.	<ul style="list-style-type: none"> The XM antenna is not properly connected. Check the connection and make sure the antenna cable is not damaged. 	7
"UPDATING" is flashing.	<ul style="list-style-type: none"> The XM antenna is being updated with the latest encryption code. Wait a few seconds for the update to complete. You may have selected an XM channel that has been blocked, or is no longer available with your subscription package. For inquiry, call XM's Listener Care at 1-800-XMRADIO (U.S. residents) or 1-877-GET-XMSR (Canada residents). 	— —
"NO SIGNL" is flashing.	<ul style="list-style-type: none"> The XM signal is too weak. Reorient the XM antenna for better reception. 	28
"LOADING" is flashing.	<ul style="list-style-type: none"> The XM antenna is receiving and decoding the broadcast information. Wait a few seconds for loading to complete. 	—
"OFF AIR" is flashing.	<ul style="list-style-type: none"> The selected XM channel is not currently broadcasting. Select a different channel. 	29
"XM ___"	<ul style="list-style-type: none"> The selected XM channel is not available. Select a different channel. 	29
"_____"	<ul style="list-style-type: none"> Supplemental text information, such as the song title or artist's name is not available for that particular broadcast. You can change the type of XM channel information that is displayed by pressing [FL DISPLAY]. 	29
You can receive only promotional XM channels.	<ul style="list-style-type: none"> Your XM Satellite service has not been activated, or your subscription has expired. To activate your XM Satellite service, or to renew your subscription: <ul style="list-style-type: none"> For U.S. residents, visit XM on the Web at www.xmradio.com or call XM's Listener Care at 1-800-XMRADIO (1-800-967-2346). For Canada residents, visit XM on the Web at www.xmradio.ca or call XM's Listener Care at 1-877-GET-XMSR (1-877-438-9677). You should have your Radio ID ready. 	28



Specifications

AMPLIFIER SECTION

RMS Output Power: Dolby Digital Mode

Front Ch	125 W per channel (3 Ω), 1 kHz, 10 % THD
Surround Ch	125 W per channel (3 Ω), 1 kHz, 10 % THD
Center Ch	250 W per channel (6 Ω), 1 kHz, 10 % THD
Subwoofer Ch	250 W per channel (6 Ω), 100 Hz, 10 % THD
Total RMS Dolby Digital mode power	1000 W

FTC Output Power: Dolby Digital Mode

Front Ch	63 W per channel (3 Ω), 120 Hz–20 kHz, 1 % THD
Surround Ch	34 W per channel (3 Ω), 120 Hz–20 kHz, 1 % THD
Center Ch	113 W per channel (6 Ω), 120 Hz–20 kHz, 1 % THD
Subwoofer Ch	121 W per channel (6 Ω), 45 Hz–120 Hz, 1 % THD
Total FTC Dolby Digital mode power	428 W

FM/AM TUNER, TERMINALS SECTION

Preset Memory	FM 30 stations AM/MW 30 stations
----------------------	-------------------------------------

Frequency Modulation (FM)

Frequency range	87.9–107.9 MHz (200-kHz step) 87.5–108.0 MHz (100-kHz step)
Sensitivity	2.5 μV (IHF)
S/N 26 dB	2.2 μV
Antenna terminals	75 Ω (unbalanced)

Amplitude Modulation (AM/MW)

Frequency range	520–1710 kHz (10-kHz step)
AM Sensitivity S/N 20 dB at 1000 kHz	560 μV/m

Phone jack

Terminal	Stereo, 3.5 mm (1/8") jack
----------	----------------------------

Music Port (Front)

Sensitivity	100 mV, 1.2 kΩ
Terminal (Input)	Stereo, 3.5 mm (1/8") jack

DISC SECTION

Discs played [8 cm (3") or 12 cm (5")]

- (1) DVD (DVD-Video)
- (2) DVD-RAM (DVD-VR, MP3^{*2,5}, JPEG^{*4,5})
- (3) DVD-R (DVD-Video, DVD-VR, MP3^{*2,5}, JPEG^{*4,5})
- (4) DVD-R DL (DVD-Video, DVD-VR)
- (5) DVD-RW (DVD-Video, DVD-VR, MP3^{*2,5}, JPEG^{*4,5})
- (6) +R/+RW (Video)
- (7) +R DL (Video)
- (8) CD, CD-R/RW [CD-DA, Video CD, SVCD^{*1}, MP3^{*2,5}, WMA^{*3,5}, JPEG^{*4,5}, HighMAT Level 2 (Audio and Image)]

^{*1} Conforming to IEC62107

^{*2} MPEG-1 Layer 3, MPEG-2 Layer 3

^{*3} Windows Media Audio Ver.9.0 L3
Not compatible with Multiple Bit Rate (MBR)

^{*4} Exif Ver 2.1 JPEG Baseline files

Picture resolution: between 160×120 and 6144×4096 pixels (Sub sampling is 4:0:0, 4:2:0, 4:2:2 or 4:4:4). Extremely long and narrow pictures may not be displayed.

^{*5} The total combined maximum number of recognizable audio and picture contents and groups: 4000 audio and picture contents and 400 groups.

Pick up

Wavelength (DVD/CD)	662/785 nm
Laser power (DVD/CD)	

U.S.A. CLASS II/CLASS I
Canada CLASS 1/CLASS 1M

Audio output (Disc)

Number of channels	5.1ch (FL, FR, C, SL, SR, SW)
--------------------	-------------------------------

VIDEO SECTION

Video system

NTSC

Composite video output

Output level	1 Vp-p (75 Ω)
Terminal	Pin jack (1 system)

Component video output (480p/480i)

Y output level	1 Vp-p (75 Ω)
P _B output level	0.7 Vp-p (75 Ω)
P _R output level	0.7 Vp-p (75 Ω)
Terminal	Pin jack (Y: green, P _B : blue, P _R : red) (1 system)

HDMI AV output

Terminal	Type A connector (19-pin), CEC Ver.1.3a
----------	---

SPEAKER SECTION

Front speakers SB-HF650

Type	1 way, 1 speaker system (Bass reflex)
Speaker unit(s)	Impedance 3 Ω
Full range	6.5 cm (2 1/2") Cone type
Input power (IEC)	125 W ^{*6} (Max)
Output sound pressure	80 dB/W (1.0 m)
Frequency range	95 Hz–25 kHz (–16 dB) 120 Hz–22 kHz (–10 dB)

Dimensions (W×H×D)

92 mm×142 mm×95 mm
(3 5/8"×5 13/32"×3 3/4")
0.6 kg (1.32 lbs)

Mass

Surround speakers SB-HS650

Type	1 way, 1 speaker system (Bass reflex)
Speaker unit(s)	Impedance 3 Ω
Full range	6.5 cm (2 1/2") Cone type
Input power (IEC)	125 W ^{*6} (Max)
Output sound pressure	80 dB/W (1.0 m)
Frequency range	95 Hz–25 kHz (–16 dB) 120 Hz–22 kHz (–10 dB)

Dimensions (W×H×D)

92 mm×142 mm×95 mm
(3 5/8"×5 13/32"×3 3/4")
0.6 kg (1.32 lbs)

Mass

Center speaker SB-HC750

Type	1 way, 2 speaker system (Bass reflex)
Speaker unit(s)	Impedance 6 Ω
1. Full range	6.5 cm (2 1/2") Cone type
2. Full range	6.5 cm (2 1/2") Cone type
Input power (IEC)	250 W ^{*6} (Max)
Output sound pressure	82 dB/W (1.0 m)
Frequency range	80 Hz–25 kHz (–16 dB) 96 Hz–22 kHz (–10 dB)

Dimensions (W×H×D)

270 mm×94 mm×95 mm
(10 5/8"×3 11/16"×3 3/4")
1.3 kg (2.9 lbs)

Mass

Subwoofer SB-HW750

Type	1 way, 1 speaker system (Bass reflex)
Speaker unit(s)	Impedance 6 Ω
Woofer	16 cm (6 1/2") Cone type
Input power (IEC)	250 W (Max)
Output sound pressure	82 dB/W (1.0 m)
Frequency range	29 Hz–220 Hz (–16 dB) 36 Hz–180 Hz (–10 dB)

Dimensions (W×H×D)

178 mm×425 mm×257 mm
(7"×16 23/32"×10 1/8")
4 kg (8.8 lbs)

Mass

GENERAL

Power supply	AC 120 V, 60 Hz
Power consumption	Main unit 135 W
Dimensions (W×H×D)	430 mm×70 mm×424 mm (16 15/16"×2 15/16"×16 11/16")
Mass	Main unit 5 kg (11.02 lbs)
Operating temperature range	+5 °C to +35 °C (+41 °F to +95 °F)
Operating humidity range	5 % to 90 % RH (no condensation)

Power consumption in standby mode approx. 0.5 W

^{*6} Rating with low-cut filter equipped amplifier

Note

1. Specifications are subject to change without notice. Mass and dimensions are approximate.
2. Total harmonic distortion is measured by a digital spectrum analyzer.
3. This unit supports "HDAVI Control 2" function.



Manufactured under license from Dolby Laboratories. "Dolby", "Pro Logic" and the double-D symbol are trademarks of Dolby Laboratories.

"DTS" and "DTS Digital Surround" are registered trademarks of DTS, Inc.

Apparatus Claims of U.S. Patent Nos. 4,631,603, 4,577,216, and 4,819,098, licensed for limited viewing uses only.

This product incorporates copyright protection technology that is protected by method claims of certain U.S. patents and other intellectual property rights owned by Macrovision Corporation and other rights owners. Use of this copyright protection technology must be authorized by Macrovision Corporation, and is intended for home and other limited viewing uses only unless otherwise authorized by Macrovision Corporation. Reverse engineering or disassembly is prohibited.

Windows Media and the Windows logo are trademarks or registered trademarks of Microsoft Corporation in the United States and/or other countries.

This product is protected by certain intellectual property rights of Microsoft Corporation and third parties. Use or distribution of such technology outside of this product is prohibited without a license from Microsoft or an authorized Microsoft subsidiary and third parties.

WMA is a compression format developed by Microsoft Corporation. It achieves the same sound quality as MP3 with a file size that is smaller than that of MP3.



HighMAT™ and the HighMAT logo are either trademarks or registered trademarks of Microsoft Corporation in the United States and/or other countries.

HDMI, the HDMI logo and High-Definition Multimedia Interface are trademarks or registered trademarks of HDMI Licensing LLC.

HDAVI Control™ is a trademark of Matsushita Electric Industrial Co., Ltd.

EZ Sync™ is a trademark of Matsushita Electric Industrial Co., Ltd.

The XM name and related logos are registered trademarks of XM Satellite Radio Inc. All rights reserved.

iPod is a trademark of Apple Computer, Inc., registered in the U.S. and other countries.

User memo:

DATE OF PURCHASE _____

DEALER NAME _____

DEALER ADDRESS _____

TELEPHONE NUMBER _____

The model number and serial number of this product can be found on either the back or the bottom of the unit.

Please note them in the space provided below and keep for future reference.

MODEL NUMBER _____ SC-PT650 _____

SERIAL NUMBER _____



Limited Warranty (ONLY FOR U.S.A.)

Panasonic Consumer Electronics Company,
Division of Panasonic Corporation of North America
One Panasonic Way Secaucus, New Jersey 07094

Panasonic Puerto Rico, Inc.
Ave. 65 de Infantería, Km. 9.5
San Gabriel Industrial Park, Carolina, Puerto Rico 00985

Panasonic Audio Products Limited Warranty

Limited Warranty Coverage

If your product does not work properly because of a defect in materials or workmanship, Panasonic Consumer Electronics Company or Panasonic Puerto Rico, Inc. (collectively referred to as "the warrantor") will, for the length of the period indicated on the chart below, which starts with the date of original purchase ("warranty period"), at its option either (a) repair your product with new or refurbished parts, or (b) replace it with a new or a refurbished product. The decision to repair or replace will be made by the warrantor.

Product or Part Name	Parts	Labor
Audio Products (except items listed below)	One (1) year	One (1) year
USB Reader-Writer, Personal Computer Card Adapters (in exchange for defective item)	One (1) year	Not Applicable
Accessories: Headphones, Cartridges, Microphones, Adapters	Ninety (90) days	Ninety (90) days
Rechargeable Batteries, DVD-R/RAM Discs (in exchange for defective item)	Ten (10) days	Not Applicable
SD Memory Cards, Rechargeable Battery Packs (in exchange for defective item)	Ninety (90) days	Not Applicable

During the "Labor" warranty period there will be no charge for labor. During the "Parts" warranty period, there will be no charge for parts. You must carry-in or mail-in your product during the warranty period. If non-rechargeable batteries are included, they are not warranted. This warranty only applies to products purchased and serviced in the United States or Puerto Rico. This warranty is extended only to the original purchaser of a new product which was not sold "as is". A purchase receipt or other proof of the original purchase date is required for warranty service.

Carry-In or Mail-In Service

For Carry-In or Mail-In Service in the United States call 1-800-211-PANA (1-800-211-7262) or visit Panasonic web site: <http://www.panasonic.com>
For assistance in Puerto Rico call Panasonic Puerto Rico, Inc. (787)-750-4300 or fax (787)-768-2910.

Limited Warranty Limits And Exclusions

This warranty ONLY COVERS failures due to defects in materials or workmanship, and DOES NOT COVER normal wear and tear or cosmetic damage. The warranty ALSO DOES NOT COVER damages which occurred in shipment, or failures which are caused by products not supplied by the warrantor, or failures which result from accidents, misuse, abuse, neglect, mishandling, misapplication, alteration, faulty installation, set-up adjustments, misadjustment of consumer controls, improper maintenance, power line surge, lightning damage, modification, or commercial use (such as in a hotel, office, restaurant, or other business), rental use of the product, service by anyone other than a Factory Servicenter or other Authorized Servicer, or damage that is attributable to acts of God.

THERE ARE NO EXPRESS WARRANTIES EXCEPT AS LISTED UNDER "LIMITED WARRANTY COVERAGE". THE WARRANTOR IS NOT LIABLE FOR INCIDENTAL OR CONSEQUENTIAL DAMAGES RESULTING FROM THE USE OF THIS PRODUCT, OR ARISING OUT OF ANY BREACH OF THIS WARRANTY. (As examples, this excludes damages for lost time, travel to and from the servicer, loss of media or images, data or other memory content. The items listed are not exclusive, but are for illustration only.) **ALL EXPRESS AND IMPLIED WARRANTIES, INCLUDING THE WARRANTY OF MERCHANTABILITY, ARE LIMITED TO THE PERIOD OF THE LIMITED WARRANTY.**

Some states do not allow the exclusion or limitation of incidental or consequential damages, or limitations on how long an implied warranty lasts, so the exclusions may not apply to you. This warranty gives you specific legal rights and you may also have other rights which vary from state to state. If a problem with this product develops during or after the warranty period, you may contact your dealer or Servicenter. If the problem is not handled to your satisfaction, then write to the warrantor's Consumer Affairs Department at the addresses listed for the warrantor.

PARTS AND SERVICE WHICH ARE NOT COVERED BY THIS LIMITED WARRANTY ARE YOUR RESPONSIBILITY.

Customer Services Directory

Obtain Product Information and Operating Assistance; locate your nearest Dealer or Servicenter; purchase Parts and Accessories; or make Customer Service and Literature requests by visiting our Web Site at:

<http://www.panasonic.com/consumersupport>

or, contact us via the web at:

<http://www.panasonic.com/contactinfo>

You may also contact us directly at:

1-800-211-PANA (7262),

Monday-Friday 9 am-9 pm; Saturday-Sunday 10 am-7 pm, EST.

For hearing or speech impaired TTY users, TTY : 1-877-833-8855

Accessory Purchases

Purchase Parts, Accessories and Instruction Books online for all Panasonic Products by visiting our Web Site at:

<http://www.pasc.panasonic.com>

or, send your request by E-mail to:

npcparts@us.panasonic.com

You may also contact us directly at:

1-800-332-5368 (Phone) 1-800-237-9080 (Fax Only) (Monday - Friday 9 am to 8 pm, EST.)

Panasonic Service and Technology Company

20421 84th Avenue South, Kent, WA 98032

(We Accept Visa, MasterCard, Discover Card, American Express, and Personal Checks)

For hearing or speech impaired TTY users, TTY : 1-866-605-1277

Service in Puerto Rico

Panasonic Puerto Rico, Inc.

Ave. 65 de Infantería, Km. 9.5, San Gabriel Industrial Park, Carolina, Puerto Rico 00985

Phone (787)750-4300, Fax (787)768-2910



Limited Warranty (ONLY FOR CANADA)

Panasonic Canada Inc.

PANASONIC PRODUCT – LIMITED WARRANTY

Panasonic Canada Inc. warrants this product to be free from defects in material and workmanship and agrees to remedy any such defect for a period as stated below from the date of original purchase.

Technics Audio Product	One (1) year, parts and labour
Panasonic Portable / Clock Radio (without Tape, CD, MD)	One (1) year, parts and labour
Panasonic Audio / SD Audio Product	One (1) year, parts and labour
Panasonic DVD Product	One (1) year, parts and labour
Panasonic Combination DVD Player / VCR	One (1) year, parts and labour
Panasonic Combination DVD Recorder / VCR	One (1) year, parts and labour
Accessories including rechargeable batteries	Ninety (90) days

LIMITATIONS AND EXCLUSIONS

This warranty does not apply to products purchased outside Canada or to any product which has been improperly installed, subjected to usage for which the product was not designed, misused or abused, damaged during shipping, or which has been altered or repaired in any way that affects the reliability or detracts from the performance, nor does it cover any product which is used commercially. Dry cell batteries are also excluded from coverage under this warranty.

This warranty is extended to the original end user purchaser only. A purchase receipt or other proof of date of original purchase is required before warranty service is performed.

THIS EXPRESS, LIMITED WARRANTY IS IN LIEU OF ALL OTHER WARRANTIES, EXPRESS OR IMPLIED, INCLUDING ANY IMPLIED WARRANTIES OF MERCHANTABILITY AND FITNESS FOR A PARTICULAR PURPOSE. IN NO EVENT WILL PANASONIC CANADA INC. BE LIABLE FOR ANY SPECIAL, INDIRECT OR CONSEQUENTIAL DAMAGES.

In certain instances, some jurisdictions do not allow the exclusion or limitation of incidental or consequential damages, or the exclusion of implied warranties, so the above limitations and exclusions may not be applicable.

WARRANTY SERVICE

FOR PRODUCT OPERATION ASSISTANCE, please contact:

Our Customer Care Centre:	Telephone #:	(905) 624-5505
	1-800 #:	1-800-561-5505
	Fax #:	(905) 238-2360
	Email link:	"Customer support" on www.panasonic.ca

FOR PRODUCT REPAIRS, please locate your nearest Authorized Servicentre at www.panasonic.ca :

Link : "Servicentres™ locator" under "Customer support"

IF YOU SHIP THE PRODUCT TO A SERVICENTRE

Carefully pack and send prepaid, adequately insured and preferably in the original carton.
Include details of the defect claimed, and proof of date of original purchase.

Limited Warranty (ONLY FOR CANADA)



Accessories



Please check and identify the supplied accessories. Use numbers indicated in parentheses when asking for replacement parts. (Product numbers correct as of December 2006. These may be subject to change.)
Only for U.S.A.: To order accessories, refer to "Accessory Purchases" on page 38.
For other areas: To order accessories, call the dealer from whom you made your purchase.

- 1 Remote control
(N2QAYB000083)



- 1 AM loop antenna
(N1DAAAA00002)



- 1 Video cable
(K2KA2BA00001)



- 1 Universal Dock for iPod
(RFE0205)



- 2 Remote control batteries



- 1 FM indoor antenna
(RSA0007-L)



- 1 Sheet of speaker cable stickers



- 1 AC power supply cord
(K2CB2CB00018)



CAUTION!

DO NOT INSTALL OR PLACE THIS UNIT IN A BOOKCASE, BUILT-IN CABINET OR IN ANOTHER CONFINED SPACE. ENSURE THE UNIT IS WELL VENTILATED. TO PREVENT RISK OF ELECTRIC SHOCK OR FIRE HAZARD DUE TO OVERHEATING, ENSURE THAT CURTAINS AND ANY OTHER MATERIALS DO NOT OBSTRUCT THE VENTILATION VENTS.

The socket outlet shall be installed near the equipment and easily accessible. The mains plug of the power supply cord shall remain readily operable.

To completely disconnect this apparatus from the AC Mains, disconnect the power supply cord plug from AC receptacle.

-If you see this symbol-

Information on Disposal in other Countries outside the European Union



This symbol is only valid in the European Union. If you wish to discard this product, please contact your local authorities or dealer and ask for the correct method of disposal.

CAUTION	- LASER RADIATION WHEN OPEN. DO NOT STARE INTO BEAM. F0A-21 (CFR) Class
CAUTION	- CLASS 1M VISIBLE AND INVISIBLE LASER RADIATION WHEN OPEN. DO NOT VIEW DIRECTLY WITH OPTICAL INSTRUMENTS. (EC00625) + A2 (Class 1M)
VARNING	- KLASS 1M SYNLIG OCH OSYNLIG LASERSTRÅLNING NÄR DENNA DEL ÄR ÖPPNAD. BETRÄKTA EJ STRÅLEN DIREKT GENOM OPTISKA INSTRUMENTER.
FORSIGTIG	- SYNLIG OG USYNLIG LASERSTRÅLING KLASS 1M NÄR LÅGET ER ÅBENT. UNDEGÅ ÅT SE IJDE PÅ NEDRE OPTISKE INSTRUMENTER.
VARO!	- KÄRÄTÄSSÄ OLET KÄLTIIVÄ LUKOKAN MI NÄKYVÄÄ JA NÄKYMÄTTÖÄ LASERISÄTELYÄ. ÄLÄ KÄYDÖ OPTISILLÄ LAITTEILLA SUORAN SÄTEENÄ.
VORSICHT	- KEUTTAARE (UNDENDE) VISIBEL LASERSTRÅLING KLASSE 1M WEIEN ANSCHAUUNG GEÖFFNET. NICHT DIREKT MIT OPTISCHEN INSTRUMENTEN BETRACHTEN.
ATTENTION	- RAYONNEMENT LASER VISIBLE ET INVISIBLE. CLASSE 1M EN CAS D'OUVERTURE. NE PAS REGARDER DIRECTEMENT À L'ŒIL DES INSTRUMENTS OPTIQUES.
注意	- ここを開くと可視及び不可視レーザー光が出ます。 ビームを見たり、覗いたりしないでください。
注意	- 打开時有可能及不可见激光辐射。避免直视辐射。 GB7241.1-2001GB 类 RQLX50075

(Inside of product)

For U.S.A.

Panasonic Consumer Electronics Company,
 Division of Panasonic Corporation of North America
 One Panasonic Way Secaucus,
 New Jersey 07094
<http://www.panasonic.com>

Panasonic Puerto Rico, Inc.

Ave. 65 de Infantería, Km. 9.5
 San Gabriel Industrial Park, Carolina,
 Puerto Rico 00985

For Canada

Panasonic Canada Inc.
 5770 Ambler Drive
 Mississauga, Ontario
 L4W 2T3
www.panasonic.ca

