

ANAFI™

ANYTIME. ANYWHERE

USER GUIDE

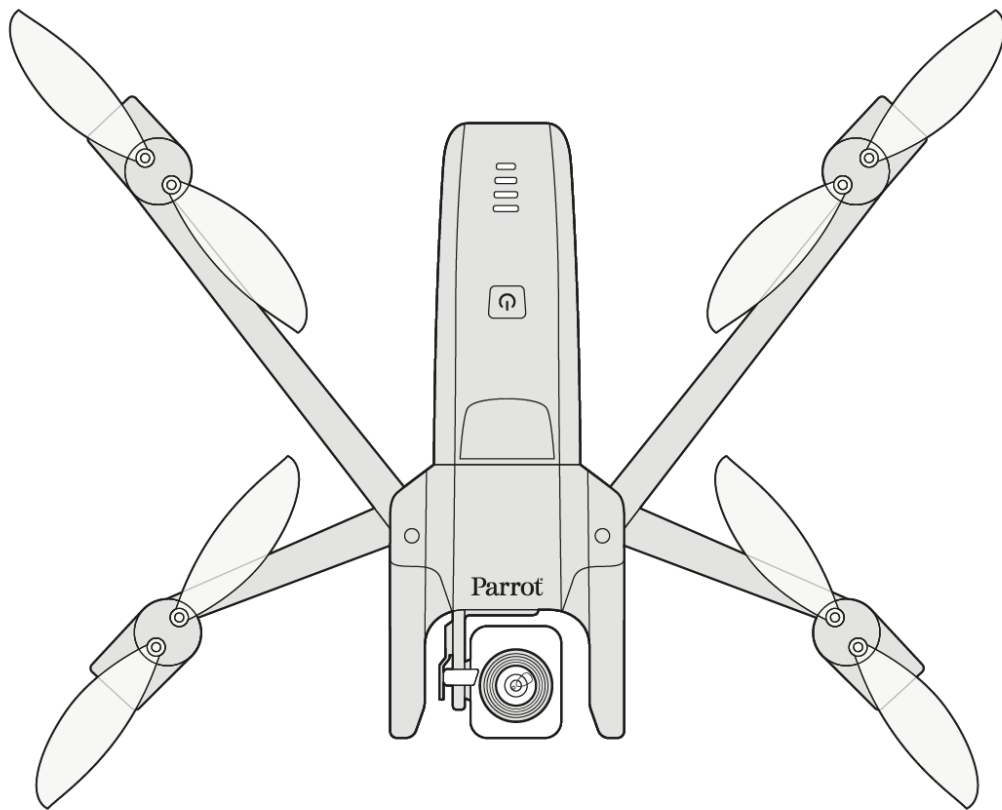

Parrot®

EVERYDAY LIFE. ELEVATED

PAGE IS BLANK
ON PURPOSE

WE ARE PARROT. WELCOME TO THE FAMILY!

With **ANAFI**, you have chosen the finest, quietest, and most portable flying 4K HDR camera, you can use everywhere on the go, anytime.

We strongly recommend you read the following information and instructions thoroughly before you get **ANAFI** in the air, to make the most of your first amazing 25-minute flight.

The indispensable prerequisites, on the next 2 pages, will not occupy more than 5 minutes of your time: ANAFI requires the FreeFlight 6 app to fly, and to make sure your drone and controller are fully up-to-date with the latest features.

As you discover the world of possibilities that **ANAFI** opens to you, you will find out that carefully planning your flights is exciting, and only adds to the fun of flying them.

Have a great read, and many outstanding hours flying **ANAFI**!

PREREQUISITES

We want your ANAFI up in the air as soon as possible, as we are sure you do. Refer to the enclosed Super Quick Start Guide (SQSG) if you need illustrated guidance to get these quick prerequisites out of the way.

1. **Wake your ANAFI's smart battery up.** Use the enclosed USB-C to USB-A cable and plug the battery to your laptop or tabletop computer, for example - you can also use an AC adapter to plug the battery to a wall socket. The battery's LEDs start flashing; it is awake and ready for the initial updates.
2. **Download FreeFlight 6 on your iOS or Android smartphone: ANAFI requires FreeFlight 6 to fly.** The app will enable you to update Parrot Skycontroller 3 and ANAFI when you power them on for the first time.



When you have downloaded and installed FreeFlight 6, unfold the central arm of Parrot Skycontroller 3 to power it on.

Use your device's USB cable to connect it to Parrot Skycontroller 3 USB-A port, and install it on the device holder, as shown in the enclosed SQSG.

A prompt appears on your screen, which invites you to allow the communication between your device and the controller.

Tap "Allow" (iOS) or "OK" (Android); FreeFlight 6 runs. After your device displays the app's splash screen, you get to FreeFlight 6 homepage.

If the prompt does not appear on your screen when you connect your device to your Parrot Skycontroller 3, launch FreeFlight 6 manually, as any other app.

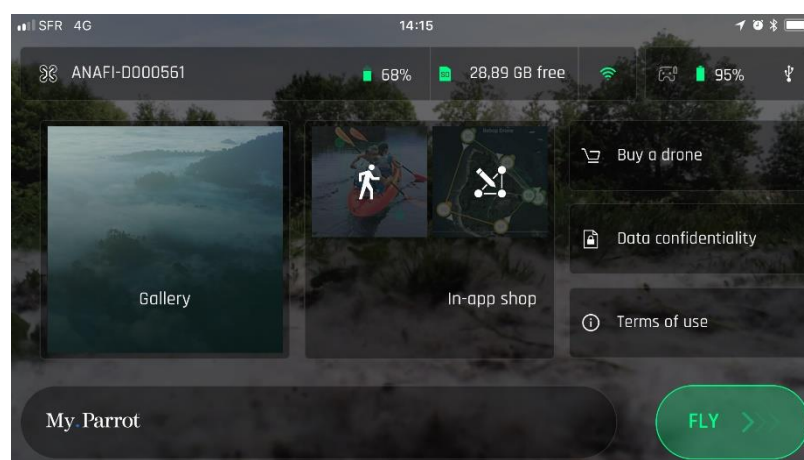

iOS FreeFlight 6 homepage

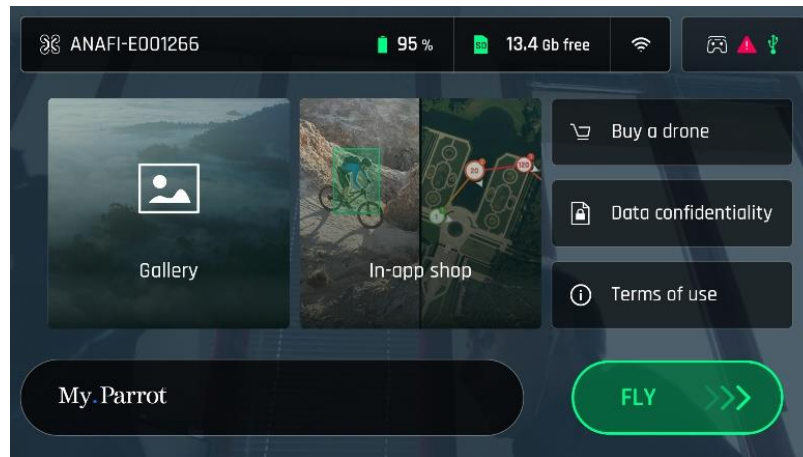

Android FreeFlight 6 homepage

3. Tap the green "FLY" box on the homepage of FreeFlight 6 to launch the initial updates. This action calls the following screen.

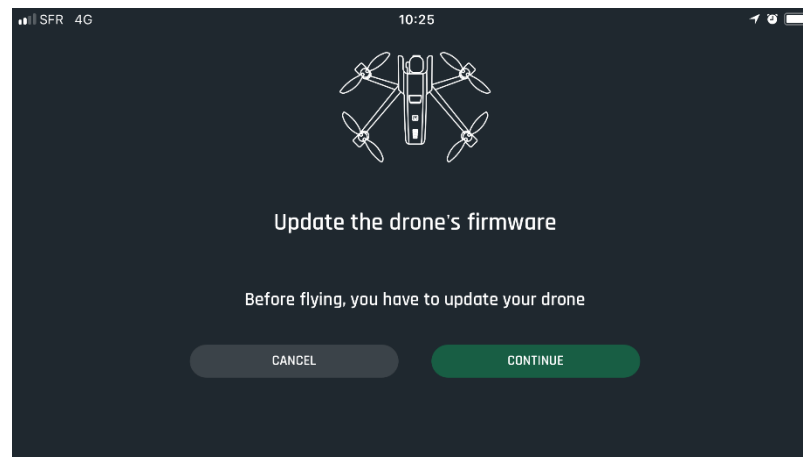

iOS ANAFI firmware update

Tap the green "CONTINUE" box to proceed. FreeFlight 6 displays an animation and a progress circle on a screen labelled "Preparing your drone". The updates of Parrot Skycontroller 3 and ANAFI do not take more than 5 minutes.

4. When updates are done, the screen displays "Your drone is ready" and a "CONTINUE" box. Tap this "CONTINUE" box to come back to FreeFlight 6 homepage.
5. All systems are ready for flight!

TABLE OF CONTENTS

We are Parrot. Welcome to the family!	3
Prerequisites	4
Table of contents	6
Foreword	8
About 4K video formats	8
About the smart battery	8
About auto-RTH (return home)	8
About devices	8
Disclaimer	9
Technical specifications	10
Package contents	11
Presentation of ANAFI	12
Ready to store or carry	12
Ready to fly	12
Presentation of Parrot Skycontroller 3	13
Ready to store or carry	13
Ready to pilot	13
Camera and gimbal controls	14
Pre-flight checklist	15
Equipment	15
Regulations	15
Flight conditions	15
Getting started	16
Taking off	17
Ground take-off	17
Hand take-off	17
Flying	18
Returning home	19
Landing	19
Smart LiPo Battery	20
Battery removal	20
Battery installation	21

Battery charging	21
Battery care and safety.....	22
Media retrieval	23
Extracting the microSD card	23
Retrieving photos and videos	23
Installing the microSD card.....	23
Introducing FreeFlight 6	24
Presentation of the iOS HUD (video mode view)	25
Presentation of the Android HUD (photo mode view).....	26
Preferences	27
Videos and Photos	29
Making videos	29
Taking photos	31
Gimbal tilt and zoom controls.....	33
Gimbal tilt control	33
Zoom control.....	33
Pro imaging settings.....	35
Exposure value (EV).....	35
Shutter speed (s).....	35
ISO value (ISO)	35
White balance (WB)	35
Style.....	35
Cineshots.....	35
360°	35
Reveal	35
Rise	35
Epic.....	36
Piloting modes	36
Cameraman	36
SmartDronies.....	36
Touch & Fly.....	36

FOREWORD

About 4K video formats

4K video formats are professional grade media which may not be read natively by slower computers. In that case, shoot in 1080p or use a video converter to turn your ANAFI's 4K videos into a more manageable format (like 1080p) if they do not read properly on your equipment. This is especially true for Parrot's 4K Cinema format, which can only be handled by professional editing equipment.

About the smart battery

ANAFI's smart battery is preinstalled on your drone. Always install it the same way and never attempt to install it upside down as it could expose your battery and your drone to irrecoverable electrical damage. As you will find out by reading this guide, ANAFI's battery is smart enough to enter a wintering mode when you are not using it for ten days in a row. This also means you need to wake it up and charge it completely before you fly ANAFI for the first time.

About auto-RTH (return home)

By design, when synchronized to GPS and Glonass satellites and when short on power, ANAFI will always attempt to come back to its most recent take-off point, at a minimal height of 20 meters over this take-off point.

For this reason, Parrot recommends ANAFI pilots take extra care when moving away from the take-off location of their drone (for example to follow ANAFI). In such cases, pilots must always try to land ANAFI as soon as the first auto-RTH alert pops up on the screen of their device (1 minute before auto-RTH). Landing resets the drone's auto-RTH position before a new take-off. This ensures ANAFI users make the most of their battery flight time, and keep their drone in a controlled and safe flying environment.

About devices

In the following pages, the word "*device*" refers to the smartphone, either iOS or Android-based, on which FreeFlight 6 is installed.

DISCLAIMER

1. **ANAFI** IS NOT A TOY and should not be used or handled by a person under the age of 14 years.
2. BEFORE USING **ANAFI**:
 - (A) CAREFULLY READ the user manual and all information and documentation available on www.parrot.com, which is susceptible to be updated at any time and without prior notice (hereinafter referred to as "Parrot Documentation"). SPECIAL ATTENTION must be given to the paragraphs marked with the symbol ;
 - (B) ENSURE YOU ARE AWARE OF THE REGULATIONS APPLICABLE TO THE USE OF DRONES AND THEIR ACCESSORIES (hereinafter referred to as "Applicable Regulations");
 - (C) REMEMBER that **ANAFI** may expose others and yourself to EQUIPMENT DAMAGE, PERSONAL INJURY, OR BOTH, which could result in serious harm or death.
3. Be aware that videos and photos that are promoted and advertised by Parrot Drones SAS and its affiliates have been made by and with experienced professionals and drone pilots. IN CASE OF DOUBT RELATING TO THE USE OF YOUR **ANAFI** DRONE AND ITS ACCESSORIES, ALWAYS REFER TO THE MOST RECENT VERSION OF THE PARROT DOCUMENTATION.
4. TO THE EXENT PERMITTED BY APPLICABLE LAW, PARROT DRONES SAS, ITS SUBSIDIARIES, AND THEIR RESPECTIVE DISTRIBUTORS AND RETAILERS SHALL NOT BE LIABLE FOR ANY DAMAGES ARISING FROM, OR IN CONNECTION WITH THE NON-COMPLIANCE OF PARROT WITH THE DOCUMENTATION OR THE APPLICABLE REGULATIONS BY YOURSELF OR ANY PERSON USING YOUR **ANAFI**.

TECHNICAL SPECIFICATIONS

DRONE

- Size folded: 244x67x65mm
- Size unfolded: 175x240x65mm
- Weight: 320g
- Max transmission range: 4km with Skycontroller 3
- Max flight time: 25min
- Max horizontal speed: 55km/h
- Max vertical speed: 4m/s
- Max wind resistance: 50km/h
- Service ceiling: 4,500m above sea level
- Operating temperature range: -10°C to 40°C

DRONE SENSORS

- Satellite Positioning: GPS and Glonass
- Barometer & magnetometer
- Vertical camera & ultrasound sensor
- 2x6-axis IMUs (1 for the flight, 1 for the camera):
 - 2x3-axis accelerometers
 - 2x3-axis gyroscopes

SMART BATTERY

- Type: High density LiPo (2 cells)
- Capacity: 2,700mAh
- Flight time per charge: 25min
- Charging port: USB-C
- Weight: 125g
- Voltage: 7.6V
- Max charging power: 24W

CONTROLLER

- Size folded: 94x152x72mm
- Size unfolded: 153x152x116mm
- Weight: 386g
- Transmission system: Wi-Fi 802.11a/b/g/n
- Operating frequencies: 2.4GHz – 5.8GHz
- Max transmission range: 4km
- Live streaming resolution: HD 720p
- Battery capacity: 2,500mAh 3.6V
- Supported mobile devices: screen size up to 6.2"
- USB ports: USB-C (charge), USB-A (connection)

IMAGING SYSTEM

- Sensor: 1/2.4" CMOS
- LD-ASPH (low dispersion aspherical) lens:
 - Aperture: f/2.4
 - 35mm format equivalent: 23mm
 - Depth of field: 1.5m to ∞
- Electronic shutter speed: 1 to 1/10000s
- ISO range: 100 to 3200
- Video resolutions:
 - 4K Cinema 4096x2160 24fps
 - 4K UHD 3840x2160 24/25/30fps
 - FHD 1920x1080 24/25/30/48/50/60fps
- Video horizontal field of view (HFOV): 69°
- Max video bitrate: 100Mbps
- Video format: MP4 (H264)
- Digital zoom:
 - Lossless: up to x2.8 (FHD); up to x1.4 (4K UHD)
 - Standard: up to x3 (all resolutions)
- HDR: 4K UHD video
- Photo resolutions:
 - Wide (JPEG & DNG): 21MP (5344x4016) / 4:3 / 84° HFOV
 - Rectilinear (JPEG): 16MP (4608x3456) / 4:3 / 75.5° HFOV
- Photo modes:
 - Single
 - Timer

IMAGE STABILIZATION

- 3-axis hybrid stabilization:
 - Mechanical: 2-axis (roll & pitch)
 - Electronic (EIS): 3-axis (roll, pitch & yaw)
- Controllable tilt range: -90° to +90° (ground to sky)

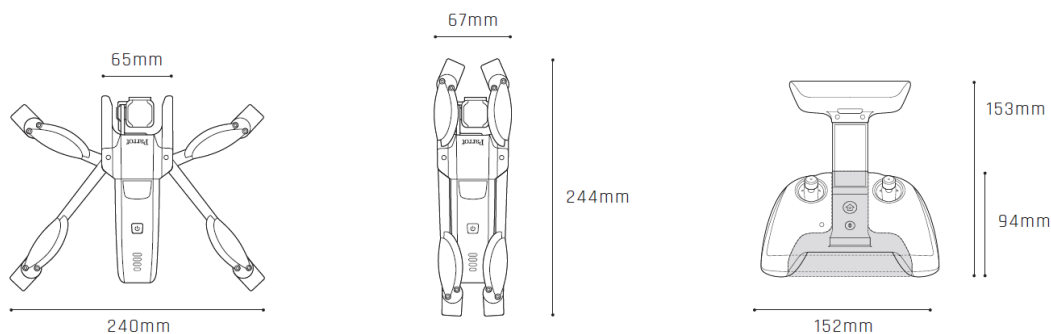

PACKAGE CONTENTS

Your **ANAFI** package contains:

- an **ANAFI** drone
- a smart battery, preinstalled on **ANAFI**
- a carrying case
- a lens cap
- a USB-A to USB-C charging cable
- a 16GB microSD card, preinstalled in **ANAFI**
- a microSD to SD card adapter
- a Parrot Skycontroller 3
- 8 spare propeller blades
- a mounting tool
- a Flight Safety Guide
- a Super Quick Start Guide (SQSG)
- a Wi-Fi settings card



PRESENTATION OF ANAFI

Ready to store or carry

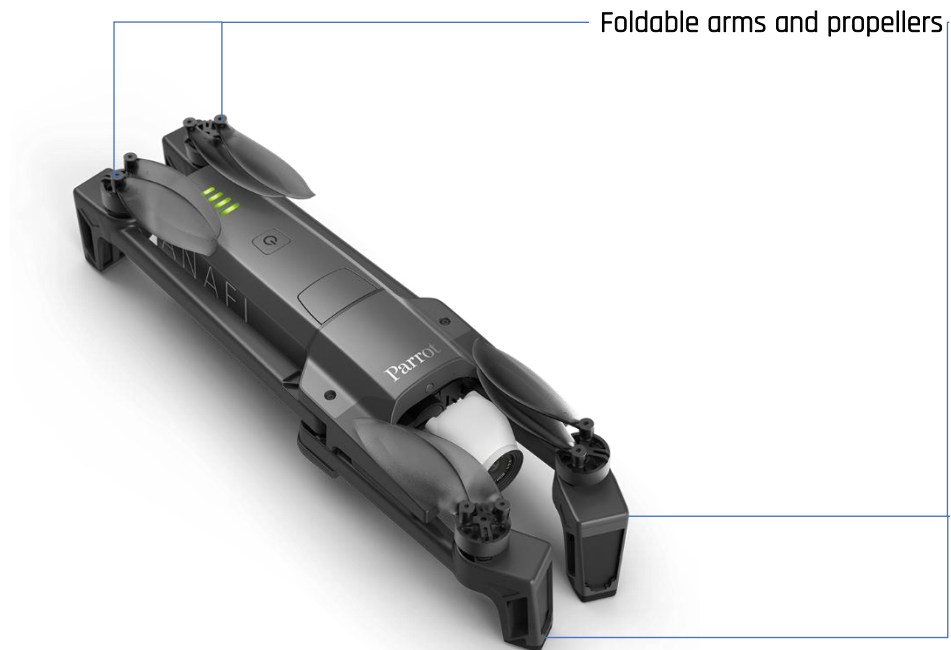

Ready to fly

Charge level LED indicators

Smart battery

Power button

Battery extraction button



USB-C charging port

180° tilt 4K camera gimbal

PRESENTATION OF PARROT SKYCONTROLLER 3

Ready to store or carry

Left control stick

Right control stick



Power-on foldable arm and device holder

Ready to pilot

LED status indicator

Wi-Fi antenna



RTH (return home) button

Take-off/landing button

Camera and gimbal controls

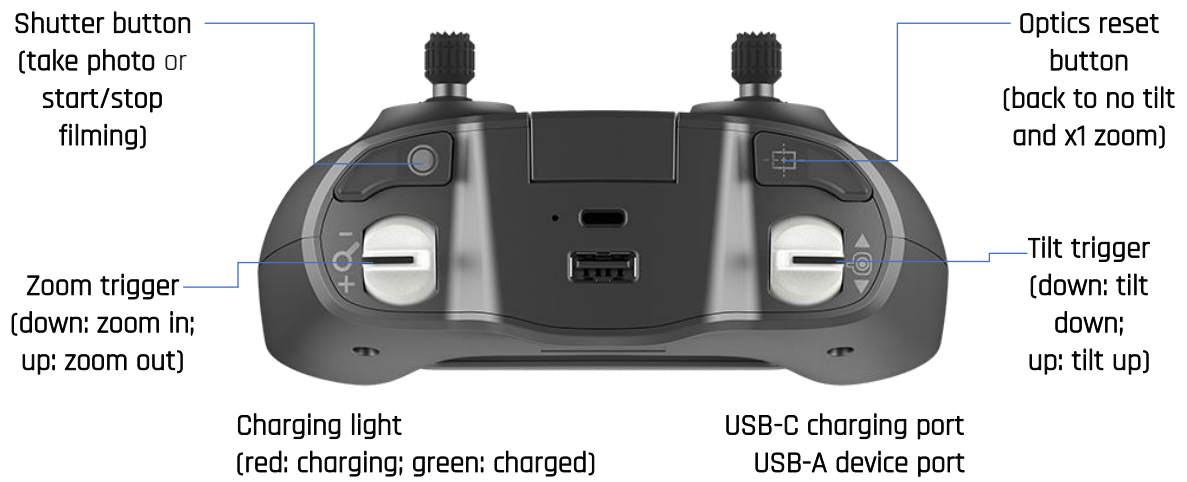

PRE-FLIGHT CHECKLIST

Equipment

- Make sure you have downloaded FreeFlight 6 and that both your Parrot Skycontroller 3 and your ANAFI have been updated with the latest versions of firmware.
- For the ultimate ANAFI experience, make sure you have the right USB-A cable to connect your Parrot Skycontroller 3 and your device.
- Make sure ANAFI is fitted with a microSD card with enough free memory space.
- Make sure all four foldable arms of ANAFI are unfolded.
- Make sure its propellers are clean, intact and unobstructed.
- Make sure both ANAFI's and Parrot Skycontroller 3's batteries are fully charged.
- Make sure ANAFI's battery is securely installed on the drone's body.
- Make sure the lens cap has been removed from ANAFI's camera.

Regulations

- Make sure the use of ANAFI is allowed where you are intending to fly.
- Check for potential restrictions regarding the use of Wi-Fi frequencies in the area where you are intending to fly.

Flight conditions

- Check that your flying zone is safe and clear.
- Do not fly ANAFI at night.
- Do not fly ANAFI over urban areas or over restricted airspaces such as airports, train stations, power plants, national reserves, and so on.
- Check the weather: do not fly ANAFI in the rain, fog, snow, or in a wind exceeding 14 meters per second or 50 km/h.
- Due to the operating mode of its vertical camera and ultrasound sensor, Parrot recommends you do not fly ANAFI over water and other reflective surfaces (mirrors, glass, and so on).

GETTING STARTED

1. Charge the battery using the enclosed USB cable and a USB-A voltage adapter (not included in the box). Charging times depends on the supply capacity of the adapter. Refer to the *"Battery charging"* section of this guide for additional information.
2. If you want to use a controller, charge Parrot Skycontroller 3.
3. To start the drone, place it on a flat horizontal surface and press the power button.
4. **If you do not use a controller**, connect your device to the Wi-Fi network of **ANAFI**, using the Wi-Fi settings card located inside the drone's carrying case - SSID format: Anafi-xxxxx.
If you use Parrot Skycontroller 3, unfold the central part of the controller to power it on, wait for the steady dark blue light, then plug your device to the controller using a USB cable.
5. FreeFlight 6 runs automatically on your device and connects to **ANAFI** and to Parrot Skycontroller 3.
6. Check for drone and controller software updates.
7. Calibrate your **ANAFI**, your Parrot Skycontroller 3, or both, following the instructions on the screen.
8. Check that your flying zone is safe and clear.
9. Press the **[TO/land icon]** button and enjoy your flight!

TAKING OFF

Ground take-off

Position **ANAFI** on a flat, even, and clear surface.

Press the [TO/land icon] button on your Parrot Skycontroller 3, or tap the green "TAKE-OFF" box, on the screen of your device.

ANAFI takes off and stabilizes at 1 meter from the ground, waiting for commands from the pilot.









Hand take-off

Position **ANAFI** on a flat, even, and clear surface.

Press the [TO/land icon] button on your Parrot Skycontroller 3, or tap the green "TAKE-OFF" box, on the screen of your device.

ANAFI takes off and stabilizes at 1 meter from the ground, waiting for commands from the pilot.

FLYING

Left control stick (default mode)	Right control stick (default mode)
 <p>Rise</p>	 <p>Forward</p>
 <p>Descend</p>	 <p>Reverse</p>
 <p>Turn right</p>	 <p>Move to the right</p>
 <p>Turn left</p>	 <p>Move to the left</p>

RETURNING HOME

To bring **ANAFI** back to its take-off position, press the **[RTH icon]** button on your Parrot Skycontroller 3, or tap the **[RTH icon]** icon on the screen of your device.

ANAFI rises to 20 meters over its take-off point - if it was flying lower than this altitude - and flies back to its take-off position.

LANDING

Fly **ANAFI** directly over a flat, even, and clear surface, then press the **[TO/land icon]** button, or tap the orange "LANDING" box on the screen of your device.

ANAFI lands.

SMART LIPO BATTERY

ANAFI's smart LiPo battery is preinstalled on the drone and should always be reinstalled in the same way, with the LEDs and power button facing up, to avoid irrecoverable electric damage to the battery, to the drone, or to both.

The smart battery can be charged whether it is installed on ANAFI, or not. However, you will need to remove the battery from the drone to access your microSD card and retrieve the photos and videos you have taken. Refer to the *"Retrieving media"* section of this guide for further information.

When handling ANAFI, you should never apply pressure and generally avoid touching the drone's camera and gimbal – its most sensitive parts. The following directions will help you handle your drone and battery safely.

Battery removal

To remove the smart battery from the drone, unfold the back arms of ANAFI. Set the drone on a flat and even surface (such as a table), and press the push-button which connects the battery to the body of the drone with your thumb. Gently slide your thumb and the battery toward the back of ANAFI. When the hook of the push-button is disengaged from the body of the drone, lift the battery away from ANAFI.

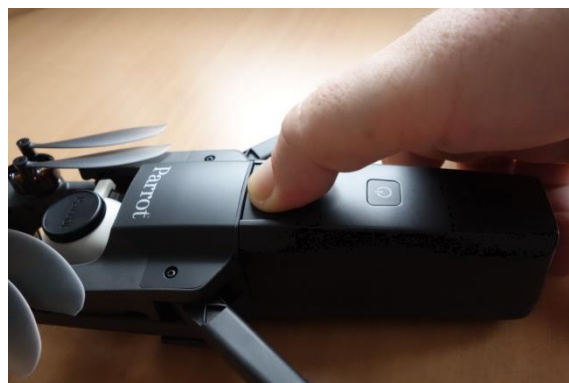

ANAFI: battery removal

Battery installation

To install the smart battery back on the drone, unfold the back arms of **ANAFI**. Set the drone on a flat and even surface (such as a table), and position the battery's three hooks into the drone's corresponding slots. Place your middle finger on the Parrot logo of **ANAFI** and your thumb on the back of the smart battery. Squeeze your fingers together until you feel and hear the battery clicking into the body of the drone. You are set!



ANAFI: battery installation

Battery charging

To charge **ANAFI's smart LiPo battery**, use the enclosed USB-C to USB-A cable to plug the battery to a power source. This convenient cable enables you to charge your battery from:

- a USB Power Delivery;
- a wall socket, through an AC adapter (not included in the box);
- a tabletop or laptop computer's USB-A port;
- a power bank.

Indicative **full charging times** depending on power sources are as follows:

- USB Power Delivery (5V, 9V, 12V - 3A): 105 minutes;
- AC adapter (5V - 3A): between 150 and 210 minutes;
- computer USB-A port / power bank: approximately 270 minutes.

When **ANAFI's smart LiPo battery** is plugged to a power source and charging, **its 4 LEDs indicate in real time its level of charge:**

- LED 1 flashing: battery is between 0 and 25% charged;
- LED 1 steady & LED 2 flashing: battery is between 25 and 50% charged;
- LEDs 1 and 2 steady & LED 3 flashing: battery is between 50 and 75% charged;
- LEDs 1, 2 and 3 steady & LED 4 flashing: battery is between 75 and 100% charged;
- battery is plugged and all LEDs are off: battery is full.

Similarly, when **your battery is not installed on ANAFI**, you can check its charge level at any time by pressing its power button:

- 1 steady LED lights up: battery is between 0 and 25% charged;
- 2 steady LEDs light up: battery is between 25 and 50% charged;
- 3 steady LEDs light up: battery is between 50 and 75% charged;
- 4 steady LEDs light up: battery is between 75 and 100% charged.

Finally, the same logic applies when **the smart LiPo battery is installed on the drone and when ANAFI is powered on**. The number of steady LEDs enables you to estimate your remaining flying time:

- 1 steady LED is lit up: less than 6 minutes flying time remaining;
- 2 steady LEDs are lit up: between 6 and 12 minutes flying time remaining;
- 3 steady LEDs are lit up: between 12 and 18 minutes flying time remaining;
- 4 steady LEDs are lit up: between 18 and 25 minutes flying time remaining.

Battery care and safety

As you can see, ANAFI's smart LiPo battery is as high-tech as any other element of your flying 4K HDR camera.

It even features a wintering mode, designed to increase its durability and facilitate its care. Ideally, when not in use for a prolonged period, batteries should be stored half-charged. When not in use for 10 days, ANAFI's smart battery discharges itself, if required, to 65% charge, over a 48h period. In other words, after a maximum of 12 days without use, this smart battery enters hibernation with a charge level which never exceeds 65%. If you leave your ANAFI battery for 12 days, you will find out its power button does not activate the charge level LED indicators. The battery needs to be charged for at least a few seconds to exit the wintering mode and start operating as described in the earlier paragraphs: this behavior preserves the battery over time and guarantees 300 charge cycles.

However, like all other LiPo batteries, **ANAFI's** smart battery must be handled, transported and stored with care:

- never let an unattended battery overcharge;
- never expose a battery to extreme temperatures, neither hot, nor cold;
- never charge a battery which is still warm from use;
- never use or recharge a damaged or swollen battery;
- always store your battery in a dry, ventilated place, at a temperature close to 20°C;
- always carry your battery in a fire-retardant bag or case (unless it is installed on **ANAFI**: it can then be transported with the drone, inside its carrying case).

MEDIA RETRIEVAL

Your ANAFI is equipped with a 16GB microSD card which enables you to record videos and photos, and to transfer them easily to your computer. This section explains how to extract the microSD card from ANAFI, how to retrieve your media from the microSD card, and how to reinstall it in the drone.

Extracting the microSD card

To extract the microSD card from ANAFI, the battery must be removed from the drone. Refer to the *"Battery removal"* section of this guide for details.

When you remove the battery from the body of the drone, you uncover the microSD slot, which is protected by a small metal lock.

Slide this metal lock with a finger toward the back of ANAFI to open it – you will hear and feel a slight click. Lift the front part of the lock to open the slot. Reach the microSD card and extract it. An open lock icon and an arrow, located on the left of the microSD slot, confirm to you the way you must slide the lock to open it.

Retrieving photos and videos

Use the enclosed microSD to SD card adapter to transfer videos and photos you have taken with ANAFI to your computer. Slide the microSD card into the adapter and use the adapter how you would use any other SD card: access your videos and photos through a card reader or the specialized port of your computer. Copy your videos and photos to the hard drive of your computer to edit, store, and manage your media.

 The enclosed 16GB microSD card enables you to record just over 20 minutes of 4K video. For this reason, Parrot recommends you backup your photos and videos, and you empty your 16GB microSD card after each flight, to ensure you always have available memory space to capture new still or moving images.

Installing the microSD card

To install the microSD card back into its slot, open the metal lock as you did when you extracted the card from ANAFI. Position the microSD card into its keyed slot: make sure the metal contacts of the card are facing down and set on the contacts of the drone. The shortest side of the microSD card should be facing toward the back of the drone.

Tilt the metal lock over the microSD card. Press a finger gently on the lock and slide it toward the front of ANAFI to close and lock it – you will hear and feel a slight click. A closed lock icon and an arrow, located on the right of the microSD slot, confirm to you the way you must slide the lock to close it.

INTRODUCING FREEFLIGHT 6

The HUD (head-up display) interface of FreeFlight 6 is the ultimate companion to ANAFI. It enables you to access all the outstanding features of ANAFI, from the screen of your device, at the touch of your thumbs.

This section explores FreeFlight 6 functions, starting with a presentation of the top and bottom bars of the HUD (iOS and Android).

Access the HUD by tapping "FLY" on the bottom right of the homepage of FreeFlight 6.

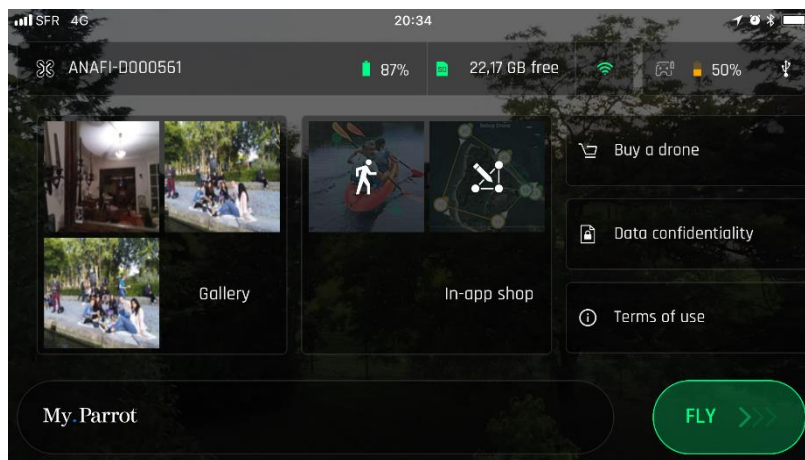

iOS FreeFlight 6 homepage

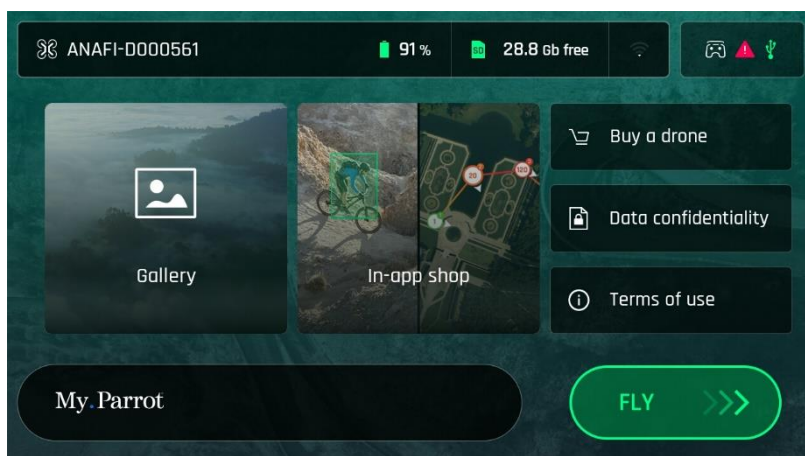

Android FreeFlight 6 homepage

Presentation of the iOS HUD (video mode view)

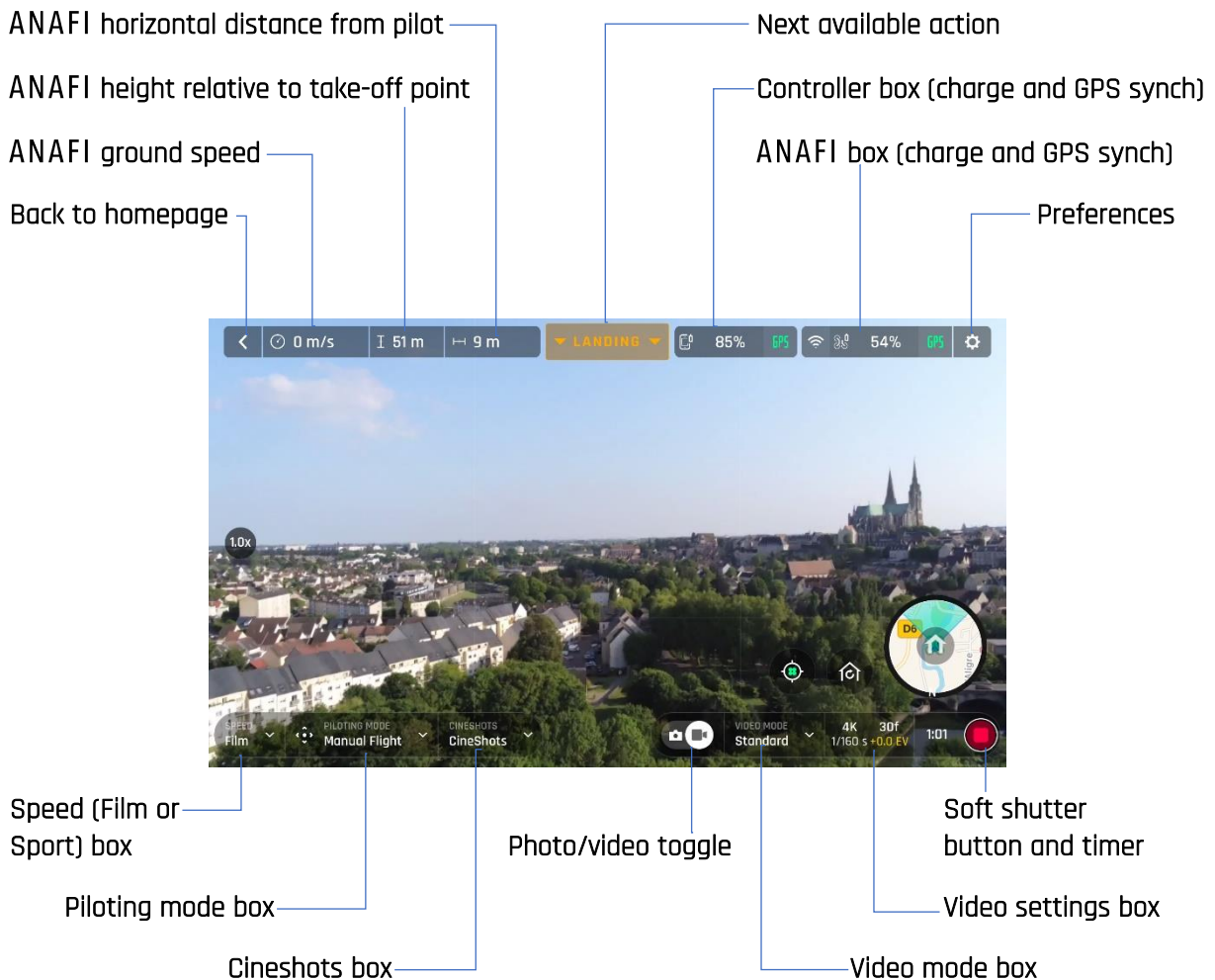

ANAFI and FreeFlight 6 are packed with features which are accessible from the HUD. Before we present the "PREFERENCES" interface of FreeFlight 6, here is an overview of your drone's current piloting, Cineshots and video modes.

- Piloting modes:**
- Manual flight
 - Cameraman
 - Follow Me (in-app purchase)
 - Smartdronies
 - Touch & Fly
 - Flight Plan (in-app purchase)

- Cineshots:**
- 360° (left & right)
 - Reveal (30 & 60m)
 - Rise (30 & 60m)
 - Epic (30 & 60m)

- Video modes:**
- Standard
 - Cinema
 - Hyperlapse
 - High-Framerate
 - Slow Motion

Presentation of the Android HUD (photo mode view)

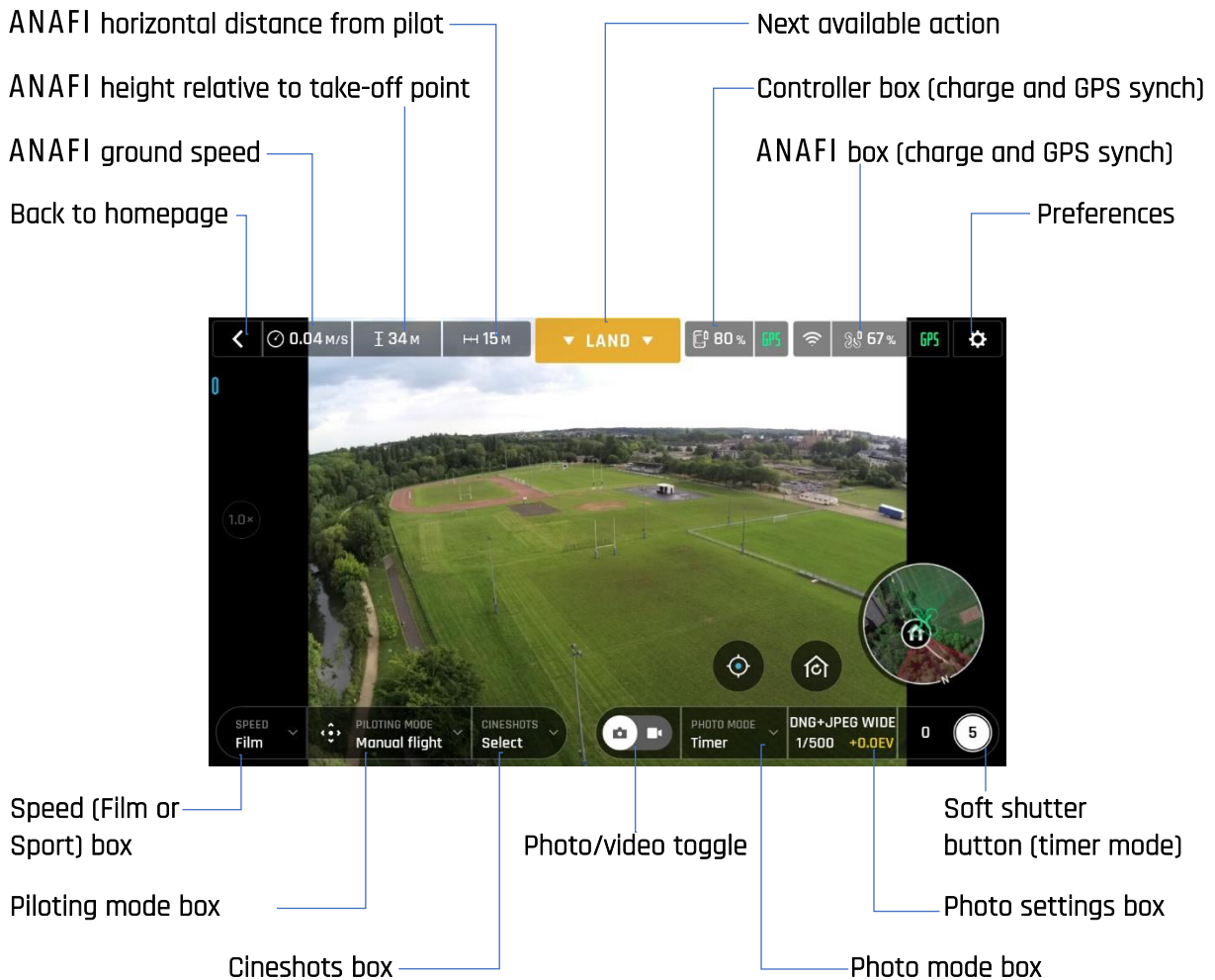

ANAFI's photo modes currently include a single shot mode, and a timer mode.

The Android HUD of FreeFlight 6 displays strictly the same information, buttons, toggles, and menus as the iOS HUD, in the same way - despite slight cosmetic differences.

/! Note that both GPS icons are green, on both screen captures. This means that the drone's controller (Skycontroller 3 or device) and ANAFI are both synchronized to enough GPS and Glonass satellites to optimize the stability of the drone, especially at higher altitudes.

Parrot therefore recommends you always check both your FreeFlight 6 HUD's GPS icons are green (and not red), before you make your ANAFI take off.

PREFERENCES

Access FreeFlight 6 preferences through the icon on the extreme right of the top bar of the HUD. Preferences enable you to fine-tune **ANAFI** to your hand – to customize it, to fit your piloting and filming styles.

Access **Preferences** submenus from the boxes on the left of the screen. Tap a box to select it and access its items. For each item, the default value is shown in **bold characters**.

Interface

The Interface preferences set the way your controller behaves and the amount of information you want on your FreeFlight 6 HUD. It also enables you to activate the “Hand-launch” option.

Tap an item option to select it.

- Control mode: **DEFAULT** / SPECIAL
- Inverse jogs **OFF** (white) / ON (green)
- Show minimap NEVER / WITH CONTROLLER / **ALWAYS**
- Map type **ROADMAD** / SATELLITE / HYBRID
- Hand-launch **NO** / YES
- Show framing grid NO / **YES**

Tap “RESET ALL INTERFACE PREFERENCES” on the bottom of the page to reset preferences.

Piloting

Piloting preferences set the way ANAFI behaves, in each individual speed mode. Tap “**FILM**” – default values in **bold** – or “*SPORT*” – default values in ***bold & italic*** – to select the speed mode you want to set.

For each item, either move the slider to select a value – or tap your choice (Banked turn).

- Max inclination: 5° to 40° (**10°** - ***25°***)
- Max inclination speed 80°/s to 300°/s (**80°/s** - ***80°/s***)
- Max vertical speed 1m/s to 4m/s (**1m/s** - ***2m/s***)
- Max rotation speed 10°/s to 200°/s (**10°/s** - ***30°/s***)
- Max camera tilt speed 1°/s to 180°/s (**4°/s** - ***10°/s***)
- Banked turn **NO** / YES

Tap “RESET ALL PILOTING PREFERENCES” on the bottom of the page to reset preferences.

Safety

Through safety preferences, you can set a safe and clear flying area for **ANAFI**: activate the Geofence and set a maximum altitude, a maximum distance from the pilot, or both, using the sliders.

- Geofence **NO** / YES
- Max altitude 0m to 150m
- Max distance 10m to 2000m

Tap "RESET ALL SAFETY PREFERENCES" on the bottom of the page to reset preferences.

Camera

Camera preferences enable you to select camera options, both in photo and video modes.

- Autorecord from take-off **NO** / **YES**
- Lossless zoom only **NO** / YES
- Timer 3 secs / **5 secs** / 10 secs
- Hyperlapse speed x15 / **x30** / x60 / x120 / x240
- Anti-flickering OFF / AUTO / **50Hz** / 60 Hz

Tap "RESET ALL CAMERA PREFERENCES AND SETTINGS" on the bottom of the page to reset preferences.

Network

Network preferences let you change your **ANAFI**'s Wi-Fi network name, password, and band.

- Network's name Tap the field to change your **ANAFI**'s network name
- Password Tap the box to change your network's password
- Wi-Fi band **ALL** / 2.4 GHz / 5 GHz / MANUAL

VIDEOS AND PHOTOS

ANAFI is equipped with a state-of-the-art 4K, 3-axis-stabilized camera, which delivers astoundingly sharp motion and still pictures, through a 1/2.4" CMOS 21MP sensor.

The lens of the camera includes low dispersion aspherical elements, that reduce chromatic aberrations and flare, and guarantee optical excellence to such a small, smart and versatile airborne imaging system.

Making videos

By default, ANAFI and FreeFlight 6 are set to start recording a video as soon as ANAFI takes off. This literally means all you have to do, to start filming, is to fly ANAFI into the sky!

However, depending on your filming objectives, ANAFI and FreeFlight 6 offer a wealth of settings, from full auto to manual professional options, for you to make the most of every situation.

If required, tap the photo/video toggle in the middle of the bottom bar of the HUD, to circle the film camera (right icon) in white.

Main filming options are twofold, and accessible from the HUD of FreeFlight 6.

- First, select a **video mode** by tapping the corresponding box of the HUD. The options appear on your device, as they do on the screen capture below. Tap a video mode to select it and tap the **video mode** box again to confirm your choice.

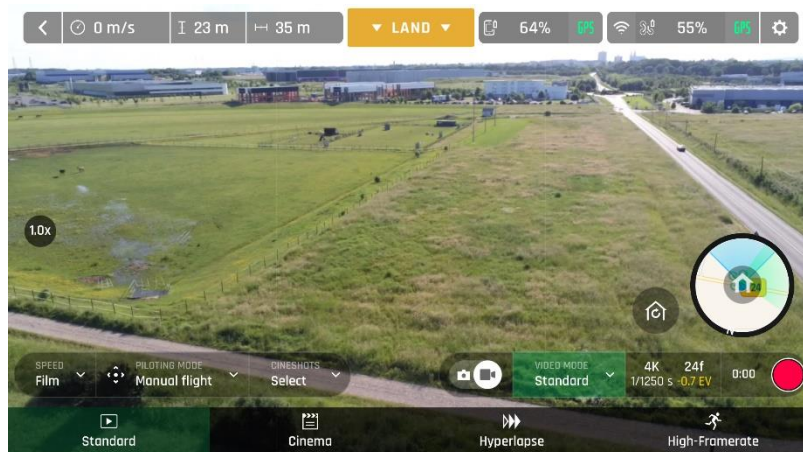

iOS Video mode menu

ANAFI video modes:

Standard:	all-round 4K or 1080p filming, at 24, 25 or 30fps.
Cinema:	spectacular 4K cinema filming at 24fps only.
Hyperlapse:	accelerated rendering 4K or 1080p filming, at 24, 25 or 30fps.
Slow-Motion	
High-Framerate:	slow-motion rendering 1080p filming, at 48, 50 or 60fps.

- **Second**, select a **video resolution** and a **fps (frame per second)** value from the corresponding box of the HUD.
Tap the **video settings box** to call the individual **video resolution** and **fps** boxes.
Tap the **video resolution box** to access the available video resolutions and tap one to select it.
Tap the **fps box** to access the available fps values and tap one to select it.
Tap the **video settings box** again to close the sub-boxes and confirm your choices.

Available video resolutions and fps values depend on the video mode you have selected.

In the following screen capture, **Standard video mode** is activated: available video resolution formats are **4K (UHD)** and **1080p (FHD)** – either in **24, 25 or 30fps**, which you would find out by tapping “24 fps” on the bottom right of the screen.



iOS Standard video format menu

When you are happy with your settings and your framing, press the hard shutter button on the right of the Parrot Skycontroller 3 (or tap the soft shutter button of the HUD) to start filming.

The soft shutter button of the HUD animates and displays a cycle between red square, and red circle. The timer starts running.

Press the hard shutter button of the controller (or tap the soft shutter button of the HUD) again to end the recording. The soft shutter button of the HUD comes back to steady, red and round. The timer resets.

Taking photos

To access the photo camera of ANAFI, tap the photo/video toggle in the middle of the bottom bar of the HUD, to circle the photo camera (left icon) in white.

Two photo modes are currently available on ANAFI: single shot and timer.

In addition, thanks to its 21MP CMOS sensor, ANAFI produces two main picture formats:

- **rectilinear JPEG** (up to 16MP);
- **wide 21MP JPEG and DNG** (Digital NeGative: Adobe open standard RAW format).

Main photography options are accessible from the HUD of FreeFlight 6.

- **First**, select a **photo mode** by tapping the corresponding box of the HUD. The options appear on your device, as they do on the screen capture below. Tap a photo mode to select it and tap the **photo mode** box again to confirm your choice.



Android Photo mode menu

When the “Single” mode is selected, the soft shutter button of the HUD appears as a full white circle.

When the “Timer” mode is selected, the soft shutter button of the HUD appears as a digit (representing a timer ready to countdown) inside a white circle.

ANAFI photo formats:

- JPEG RECT: 4:3 aspect ratio, up to 16MP and 75.5° horizontal field of view (HFOV)
- JPEG WIDE: 4:3 aspect ratio, 21MP, 84° HFOV – zoom is disabled for this format
- DNG+JPEG: 4:3 aspect ratio, 21MP, 84° HFOV – zoom is disabled for this format

! The DNG+JPEG option produces 2 files (1 DNG, 1 JPEG) for each shutter action. As other RAW picture formats, **DNG is a very useful format for professional photography** processing and workflow. Indeed, RAW formats retain all the information gathered by photography sensors, contrary to JPEG formats – which are compressed and processed renderings of this comprehensive information. In consequence, RAW pictures such as **ANAFI's DNG are heavy files**, but they offer the very best post-processing and retouching possibilities.

- **Second**, select a **photo format** from the corresponding box of the HUD.
Tap the **photo settings box** to call the **photo settings boxes**.
Tap the **last box on the right of the screen** to access the **available photo formats**.
Tap a format (**JPEG RECT**, or **JPEG WIDE**, or **DNG+JPEG**) to select it.
Tap the photo settings box again to close the sub-boxes and confirm your choice.

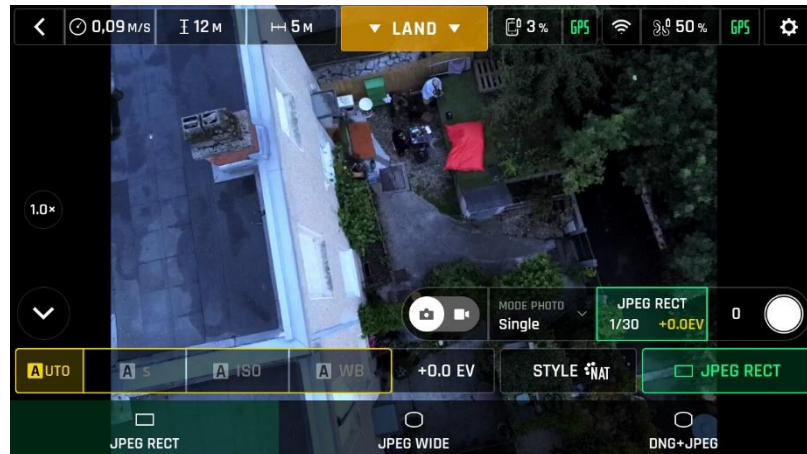

Android photo formats: JPEG RECT



Android photo formats: DNG+JPEG

When you are happy with your settings and your framing, press the hard shutter button on the right of the Parrot Skycontroller 3 (or tap the soft shutter button of the HUD) to take a photo.

In "Single" mode, the screen flashes white to confirm a picture has been taken.

In "Timer" mode, the timer of the soft button of the HUD countdowns, then the screen flashes white to confirm a picture has been taken. The timer of the soft shutter button resets.

GIMBAL TILT AND ZOOM CONTROLS

Two of ANAFI's main assets are its gimbal tilt control capabilities (180°, from the ground to the sky), and its zoom. This section presents these features and the way to activate them.

Gimbal tilt control

ANAFI's gimbal tilt control is activated through the left trigger of Parrot Skycontroller 3. It is available in **all video and photo modes**, and in all manual piloting modes.

- To aim the gimbal toward the ground, push the tilt control trigger down.
- To aim the gimbal toward the sky, pull the tilt control trigger up.
- To reset the gimbal tilt to a horizontal position, press the optics reset button on the left of Parrot Skycontroller 3 (this action also resets the zoom factor of the lens to x1).

Zoom control

ANAFI's zoom control is activated through the right trigger of Parrot Skycontroller 3. It is available in **all video modes, and in JPEG RECT photo mode** (with an impact on the final resolution of your pictures). WIDE photo modes imply the use and rendering of all 21MP delivered by ANAFI's CMOS sensor: zoom is deactivated in both WIDE photo modes.

- To zoom in on a subject, push the zoom trigger down.
- To zoom out, pull the zoom trigger up.
- Pressing the optics reset button on the left of Parrot Skycontroller 3 instantly resets the zoom factor of the lens to x1 (this action also resets the gimbal tilt to a horizontal position).

The HUD of FreeFlight 6 presents precise, decimal-by-decimal zoom information at all times, in the middle of the left side of the screen, as shown on the following screen captures - note that in these examples, ANAFI's gimbal is tilted all the way toward the ground.



Android x1 zoom



Android x2 zoom

As already mentioned, **ANAFI** presents no lossless zoom capabilities for pictures: the zoom is deactivated by design in WIDE formats (JPEG and DNG+JPEG), and it has an impact on the resolution of the pictures in JPEG RECT format.

By contrast, **ANAFI** offers **impressive lossless zoom** capabilities for **4K UHD (x1.4)** and **1080p (X2.8)** videos.

Note that when you leave the lossless envelope of the zoom, the zoom indicator, on the middle left of the HUD, turns orange instead of white.

PRO IMAGING SETTINGS

//material ready (except shutter speed and style) - settings not stabilized//

Exposure value (EV)

Shutter speed (s)

ISO value (ISO)

White balance (WB)

Style

CINESHOTS

ANAFI features a series of automated shots, which enable you to capture scenes professionally. Tap "CINESHOTS" in the bottom bar of the HUD to access Cineshots. Tap a Cineshot to select it. For each, two options appear.

360°

The 360° Cineshot is self-explanatory: when it is activated, ANAFI rotates slowly and completely around its axis to uncover a full panorama.

Tap "Right" or "Left" to select the direction you want your drone to rotate and to activate the 360°. After 2,3,4,5 seconds, ANAFI starts its rotation. On iPhones, the 360° box progressively fills in green as the Cineshot unfolds.

Reveal

The 360° Cineshot is self-explanatory: when activated, ANAFI rotates slowly and completely around its axis to uncover a full panorama.

Tap "Right" or "Left" to select the way you want your drone to rotate and to activate the 360°. After 2,3,4,5 seconds, ANAFI starts its rotation. On iPhones, the 360° box progressively fills with green as the Cineshot unfolds.

Rise

The 360° Cineshot is self-explanatory: when activated, ANAFI rotates slowly and completely around its axis to uncover a full panorama.

Tap "Right" or "Left" to select the way you want your drone to rotate and to activate the 360°. After 2,3,4,5 seconds, ANAFI starts its rotation. On iPhones, the 360° box progressively fills with green as the Cineshot unfolds.

Epic

The 360° Cineshot is self-explanatory: when activated, ANAFI rotates slowly and completely around its axis to uncover a full panorama.

Tap "Right" or "Left" to select the way you want your drone to rotate and to activate the 360°. After 2,3,4,5 seconds, ANAFI starts its rotation. On iPhones, the 360° box progressively fills with green as the Cineshot unfolds.

PILOTING MODES

Cameraman

SmartDronies

Touch & Fly

For questions, comments, or feedback about v0.9.2 of ANAFI's user guide, reach out to technical.writer@parrot.com

CANADA DECLARATION OF CONFORMITY : ANAFI AND PARROT SKYCONTROLLER 3

The Anafi drone and the Parrot Skycontroller 3 comply with the Industry Canada RSS applicable to license-exempt radio apparatus. Operation is permitted subject to the following two conditions:

- (1) the device must not produce interference, and
- (2) the user of the device must accept any radio interference encountered, even if the interference is likely to compromise operations.

The Anafi and the Parrot Skycontroller 3 are category B digital devices and are compliant with the NMB-003 standard of Canada. A minimum distance of 80 mm between the user's hands and the antenna must be kept in order to comply with IC SAR requirement.

FCC/IC

Any changes or modifications to this equipment not expressly approved by PARROT DRONES may cause, harmful interference and void the FCC authorization to operate this equipment.

This device complies with part 15 of the FCC Rules. Operation is subject to the following two conditions: (1) This device may not cause harmful interference, and (2) this device must accept any interference received, including interference that may cause undesired operation.

This device contains licence-exempt transmitter(s)/receiver(s) that comply with Innovation, Science and Economic Development Canada's licence-exempt RSS(s). Operation is subject to the following two conditions:

- (1) This device may not cause interference.
- (2) This device must accept any interference, including interference that may cause undesired operation of the device.

ANAFI (drone)

This equipment complies with FCC's radiation exposure limits set forth for an uncontrolled environment under the following conditions :

This equipment should be installed and operated such that a minimum separation distance of 20cm is maintained between the radiator (antenna) and user's/nearby person's body at all times.

This transmitter must not be co-located or operating in conjunction with any other antenna or transmitter.

SKYCONTROLLER 3 (Remote control)

This portable equipment with it's antenna complies with FCC's radiation exposure limits set forth for an uncontrolled environment. This equipment has shown compliance with FCC's Specific Absorption Rate (SAR) limits.

To maintain compliance, follow the instructions below : This transmitter must not be co-located or operating in conjunction with any other antenna or transmitter.

To meet FCC SAR requirements, the product must be spaced at least 10 mm from the user's body.