

Pasadena Metro Radio System

Maintenance Handbook
For Canam Technology Inc.

AFL Works Order Nō.: Q107519
AFL product part Nō's.:

60-055900 **PBL Location One UHF1/1A & UHF2 (This document)**
60-056000 Tunnels 1 & 2
60-056100 PBL location TWO & 800MHz BDA

 Aerial Facilities Limited www.AerialFacilities.com Technical Literature	PBL UHF1/1A 1 & 2 Air Interface Maintenance Handbook		
	H/book Number:- 60-055900HBKM	Issue No:-2	Date:- 20/10/2003

Table of Contents

<u>AMENDMENT LIST RECORD SHEET</u>	5
<u>INTRODUCTION</u>	6
<u>SCOPE</u>	6
<u>PURPOSE</u>	6
<u>GLOSSARY OF TERMS</u>	7
<u>AFL DRAWING SYMBOL KEYS</u>	8
1. <u>SAFETY CONSIDERATIONS</u>	9
1.1 <u>ELECTRIC SHOCK HAZARD</u>	9
1.2 <u>RF RADIATION HAZARD</u>	9
1.3 <u>CHEMICAL HAZARD</u>	10
1.4 <u>LASER SAFETY</u>	11
1.5 <u>EMERGENCY CONTACT NUMBERS</u>	11
2. <u>OVERVIEW/SYSTEM DESCRIPTION</u>	12
3. <u>SPECIFICATIONS</u>	13
3.1 <u>PARTS LISTS</u>	13
3.1.1 <u>UHF1/1A & UHF2 Location ONE 60-055900 Parts List</u>	13
3.1.1.1 <u>F/O Air Interface 60-055901 Location ONE-UHF1 Parts List</u>	13
3.1.1.2 <u>F/O Air Interface 60-055902 Location ONE, UHF2 Parts List</u>	15
3.1.1.3 <u>F/O Air Interface 60-055903 Location ONE, UHF1A Parts List</u>	17
3.2 <u>TECHNICAL SPECIFICATIONS</u>	18
3.2.1 <u>UHF ONE to Tunnels 1 & 2 Technical Specification</u>	18
3.2.2 <u>UHF1A Technical Specification</u>	19
3.2.3 <u>UHF ONE to Location TWO Technical Specification</u>	20
3.2.4 <u>UHF TWO to Tunnels 1 & 2 Technical Specification</u>	21
3.2.5 <u>UHF TWO to Location TWO Technical Specification</u>	22
3.2.6 <u>800MHz Bi-directional Amplifier to Location TWO Technical Specification</u>	23
3.3 <u>MECHANICAL SPECIFICATION (UHF1/1A & UHF2 WALL CASES)</u>	24
4. <u>SYSTEM DRAWINGS</u>	25
4.1 <u>DRG. Nō. 60-055990, LOCATION ONE, UHF1/1A CASE OUTLINE DRAWING</u>	25
4.2 <u>DRG. Nō. 60-055994 LOCATION ONE, UHF1A (UPGRADE) CASE OUTLINE DRAWING</u>	26
4.3 <u>DRG. Nō. 60-055991, LOCATION ONE, UHF 2 CASE OUTLINE DRAWING</u>	27
4.4 <u>COMPLETE SYSTEM DIAGRAM SKETCH</u>	28
4.5 <u>UHF1/1A & UHF2 SYSTEM DIAGRAM SKETCH</u>	29
5. <u>SUB-UNIT MODULES</u>	30
5.1 <u>UHF 1 AIR INTERFACE (60-055901)</u>	30
5.1.1 <u>Bandpass Duplexers (02-013401)</u>	30
5.1.1.1 <u>Description</u>	30
5.1.1.2 <u>Technical Specification</u>	30
5.1.2 <u>2 & 4 Way UHF Splitters (05-002603 & 05-003401)</u>	31
5.1.2.1 <u>Description</u>	31
5.1.2.2 <u>Technical Specification (05-002603)</u>	31
5.1.2.3 <u>Technical Specification 05-003401</u>	31
5.1.3 <u>¼Watt 0- -30dB Switched Attenuator (10-000701)</u>	32
5.1.3.1 <u>General Application</u>	32
5.1.3.2 <u>Switched Attenuators</u>	32
5.1.4 <u>Low Noise Amplifiers (11-006102, 11-007302 & 11-007402)</u>	32
5.1.4.1 <u>General Description</u>	32
5.1.4.2 <u>Technical Specification (11-006102)</u>	32
5.1.4.3 <u>Drğ. Nō. 11-006102, Low Noise Amplifier General Assembly</u>	33
5.1.4.4 <u>Drğ. Nō. 11-006170, LNA RF Circuit Diagram</u>	34
5.1.4.5 <u>Drğ. Nō. 11-006171, LNA DC Wiring Diagram</u>	35

5.1.4.6	Drg. Nō. 11-003971, LNA DC Schematic Diagram	36
5.1.4.7	Technical Specification (11-007302)	37
5.1.4.8	Drg. Nō. 11-007302, LNA Assembly With Alarm Relay	38
5.1.4.9	Drg. Nō. 11-007370, LNA RF Circuit Diagram	39
5.1.4.10	Drg. Nō. 11-007371, LNA DC Wiring Diagram	40
5.1.4.11	Technical Specification (11-007402)	41
5.1.4.12	Drg. Nō. 11-007402, LNA General Assembly	42
5.1.4.13	Drg. Nō. 11-007470, LNA RF Circuit Diagram	43
5.1.4.14	Drg. Nō. 11-007471 LNA DC Wiring Diagram	44
5.1.5	5Watt Power Amplifier (12-001801)	45
5.1.5.1	Description	45
5.1.5.2	Technical Specification	45
5.1.5.3	Drg. Nō. 12-001801, 5Watt PA General Assembly Drawing	46
5.1.5.4	Drg. Nō. 12-001870, 5Watt PA Circuit Diagram	47
5.1.5.5	Drg. Nō. 12-001870C1, 5W PA Component List(1)	48
5.1.5.6	Drg. Nō. 12-001870C2, 5W PA Component List(2)	49
5.1.5.7	Drg. Nō. 80-008450, Power Amplifier/Alarm Board DC Wiring Details	50
5.1.6	3 Stage Amplifier Alarm Boards (12-002201)	51
5.1.6.1	Description	51
5.1.6.2	Technical Specification	52
5.1.6.3	Drg. Nō. 12-002201, 3 Stage Alarm Board Assembly Drawing & Parts List	53
5.1.6.4	Drg. Nō. 12-002270, 3 Stage Alarm Board Circuit Diagram	54
5.1.6.5	Generic Wall Enclosure Alarm Wiring Sketch	55
5.1.7	DC/DC Converter, 24V in, 12V 8A out (13-003011)	56
5.1.7.1	Description	56
5.1.7.2	Technical Specification	56
5.1.8	Channel Selective & Channel Control Modules (17-003012 & 17-002101)	57
5.1.8.1	Channel Selective Module Description	57
5.1.8.2	Drg. Nō. 17-003080, Generic Channel Module Block Diagram	58
5.1.8.3	Channel Selectivity Control Module Description	59
5.1.8.4	Channel Controller DIP Switch Configuration Frequencies	59
5.1.8.5	UHF1 Downlink Channel Module Configuration Table	60
5.1.8.6	UHF1 Uplink Channel Module Configuration Table	60
5.1.8.7	UHF1A Downlink Channel Module Configuration Table	60
5.1.8.8	UHF1A Uplink Channel Module Configuration Table	61
5.1.8.9	UHF2 Downlink Channel Module Configuration Table	61
5.1.8.10	UHF2 Uplink Channel Module Configuration Table	61
5.1.9	Single & Dual 24Volt Relay Boards (20-001602 & 80-008902)	62
5.1.9.1	24V Relay Boards (20-001602 & 80-008902) Description	62
5.1.9.2	Drg. Nō. 20-001602, Dual 24V Relay Board Assembly Drawing	63
5.1.9.3	Drg. Nō. 20-001671, Dual 24V Relay Board Circuit Diagram	64
5.1.9.4	Drg. Nō. 80-008970, Single Relay Board Circuit Diagram	65
5.1.10	SMA coaxial termination (93-930003)	66
5.1.10.1	Description	66
5.1.11	24V 400W Flat-Pack Power Supply (96-300011)	66
5.1.11.1	Description	66
5.1.11.2	Technical Specification	66
5.2	UHF 2 AIR INTERFACE (60-055902)	67
5.2.1	Bandpass Filter (02-013401) See section 5.1.1	67
5.2.2	4 Port Tx Hybrid Combiner (05-003019)	67
5.2.2.1	Description	67
5.2.2.2	Technical Specification	67
5.2.3	Four Way Low Power Splitter (05-003401) See section 5.1.2	68
5.2.4	¼Watt 0- -30dB Switched Attenuator (10-000701) See section 5.1.3	68
5.2.5	Low Noise Amplifiers (11-007302 & 11-007402) See section 5.1.4	68
5.2.6	3 Stage Amplifier Alarm Boards (12-002201) See section 5.1.6	68
5.2.7	20Watt Power Amplifier (12-004201)	68

5.2.7.1	Description	68
5.2.7.2	Technical Specification	68
5.2.7.3	Drg. Nō. 12-004201, PA General Assembly	69
5.2.7.4	Drg. Nō. 12-004270, PA Circuit Diagram	70
5.2.7.5	Drg. Nō. 12-004270C1, PA Parts List(1)	71
5.2.7.6	Drg. Nō. 12-004270C2, PA Parts List(2)	72
5.2.7.7	Drg. Nō. 12-003670, PA to Alarm Wiring Details	73
5.2.8	DC/DC Converter, 24V in, 12V 8A out (13-003011) See section 5.1.7	74
5.2.9	Chan. Selec. & Chan. Contr. Mdls (17-003012 & 17-002101) See section 5.1.8	74
5.2.10	21MHz IF Filter Board (17-002502)	74
5.2.10.1	Description	74
5.2.11	Single & Dual 24Volt Relay Boards (20-001602 & 80-008902) See section 5.1.9	74
5.2.12	SMA Coaxial Termination (93-930003) See section 5.1.10	74
5.2.13	24V 400W Flat-Pack Power Supply (96-300011) See section 5.1.11	74
5.2.14	JWS75-15/A PSU (96-300045)	74
5.2.14.1	Description	74
5.2.14.2	Technical Specification	74
5.2.15	Single Mode Optical Coupler (98-100001)	75
5.2.15.1	Description	75
5.2.16	Fibre Optic Receiver & Transmitter (98-200003 & 98-300003)	75
5.2.16.1	Description	75
5.2.16.2	Technical Specification	76
5.3	UHF1A 60-055903 470MHZ 3 CHANNEL BDA	77
6.	INSTALLATION	78
6.1	INITIAL INSTALLATION RECORD	78
6.2	GENERAL	78
6.3	ELECTRICAL CONNECTIONS	78
6.4	OPTICAL CONNECTIONS	78
6.5	RF CONNECTIONS	79
6.6	COMMISSIONING	79
7.	MAINTENANCE	80
7.1	GENERAL PROCEDURES	80
7.1.1	Fault Finding	80
7.1.2	Downlink	81
7.1.3	Uplink	81
7.1.4	Fault repair	81
7.1.5	Checking service	82
7.1.6	Service Support	82
7.2	TOOLS & TEST EQUIPMENT	82
7.3	CARE OF MODULES	83
7.3.1	General Comments	83
7.3.2	Module Removal (LNA's, general procedure)	83
7.3.3	Module Replacement (general)	83
7.3.4	Power Amplifiers	83
7.3.5	Low Power Amplifier Replacement	84
7.3.6	Module Transportation	84
APPENDIX A INITIAL EQUIPMENT SET-UP CALCULATIONS		85

INTRODUCTION

Scope

This handbook is for use solely with the equipment identified by the AFL Part Number shown on the front cover. It is not to be used with any other equipment unless specifically authorised by Aerial Facilities Limited. This is a controlled release document and, as such, becomes a part of Aerial Facilities' Total Quality Management System. Alterations and modification may therefore only be performed by Aerial Facilities Ltd.

Purpose

The purpose of this handbook is to provide the user/maintainer with sufficient information to service and repair the equipment to the level agreed. Maintenance and adjustments to any deeper level must be performed by AFL, normally at the company's repair facility in Chesham, England.

This handbook has been prepared in accordance with BS 4884, and AFL's Quality procedures, which maintain the company's registration to ISO 9001: 1994 and to the R&TTE Directive of the European Parliament. Copies of the relevant certificates and the company Quality Manual can be supplied on application to the Quality Manager. This document fulfils the relevant requirements of Article 6 of the R&TTE Directive.

Limitation of Information Notice

This manual is written for the use of technically competent operators/service persons. No liability is accepted by AFL for use or misuse of this manual, the information contained therein, or the consequences of any actions resulting from the use of the said information, including, but not limited to, descriptive, procedural, typographical, arithmetical, or listing errors.

Furthermore, AFL does not warrant the absolute accuracy of the information contained within this manual, or its completeness, fitness for purpose, or scope.

AFL has a policy of continuous product development and enhancement, and as such, reserves the right to amend, alter, update and generally change the contents, appearance and pertinence of this document without notice.

All AFL products carry a twelve month warranty from date of shipment. The warranty is expressly on a return to base repair or exchange basis and the warranty cover does not extend to on-site repair or complete unit exchange.

 Aerial Facilities Limited www.AerialFacilities.com Technical Literature	PBL UHF1/1A 1 & 2 Air Interface Maintenance Handbook		
	H/book Number:- 60-055900HBKM	Issue No:-2	Date:- 20/10/2003

Glossary of Terms

Repeater or Cell Enhancer	A Radio Frequency (RF) amplifier which can simultaneously amplify and re-broadcast Mobile Station (MS) and Base Transceiver Station (BTS) signals.
Band Selective Repeater	A Cell Enhancer designed for operation on a range of channels within a specified frequency band.
Channel Selective Repeater	A Cell Enhancer, designed for operation on specified channel(s) within a specified frequency band. Channel frequencies may be factory set or on-site programmable.
BTS	Base Transceiver Station
C/NR	Carrier-to-Noise Ratio
Downlink (D.L.)	RF signals transmitted from the BTS and to the MS
Uplink (U.L.)	RF signals transmitted from the MS to the BTS
EMC	Electromagnetic Compatibility
GND	Ground
DC	Direct Current
AC	Alternating Current
ID	Identification Number
OIP3	Output Third Order Intercept Point = $RF_{out} + (C/I)/2$
LED	Light Emitting Diode
M.S.	Mobile Station
N/A	Not Applicable
N/C	No Connection
NF	Noise Figure
RF	Radio Frequency
Rx	Receiver
Tx	Transmitter
S/N	Serial Number

AFL Drawing Symbol Keys

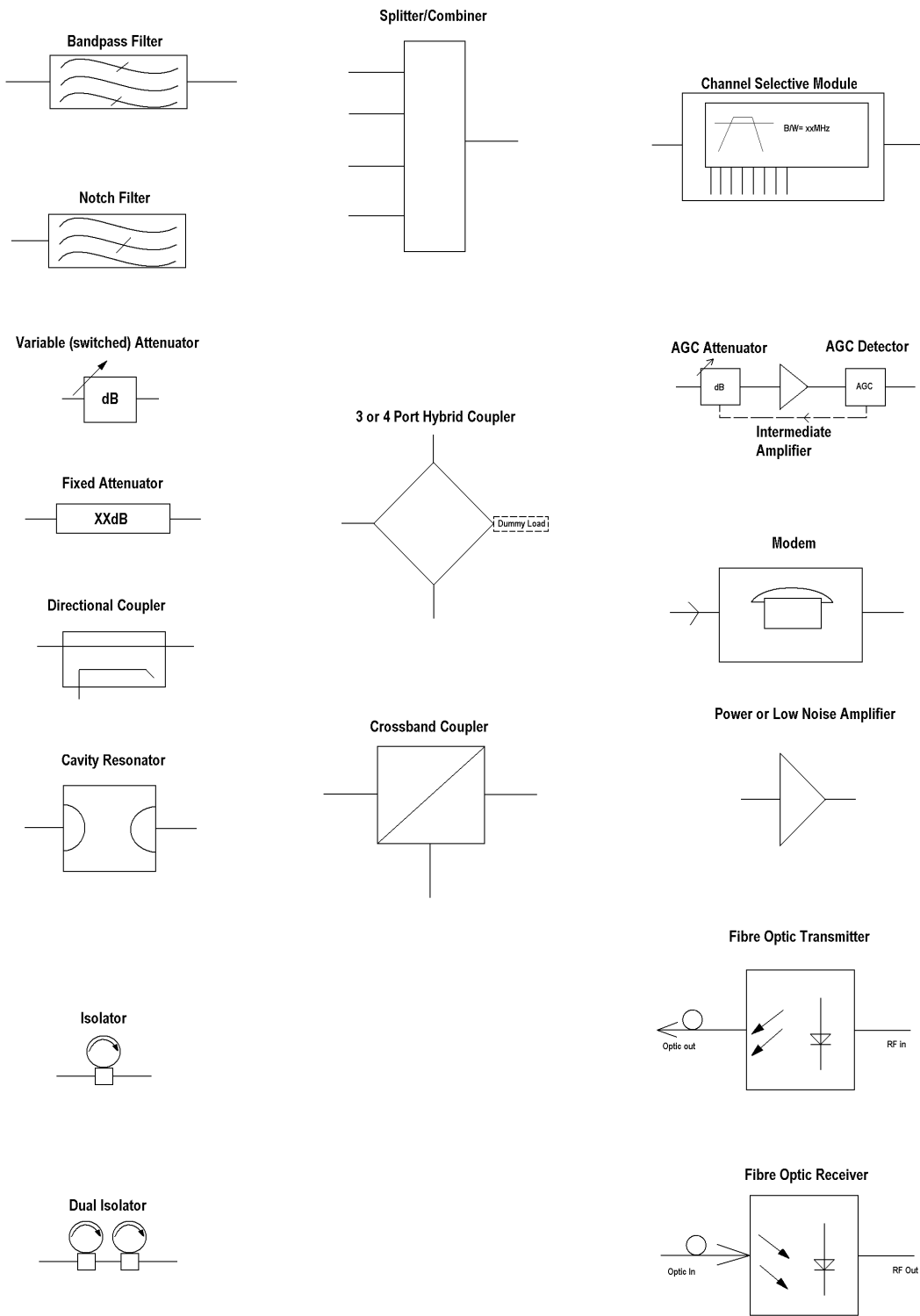

Key to AFL RF Modules

 <p>Aerial Facilities Limited www.AerialFacilities.com Technical Literature</p>	<p>PBL UHF1/1A 1 & 2 Air Interface Maintenance Handbook</p>		
	H/book Number:-60-055900HBKM	Issue No:-2	Date:-20/10/2003

1. SAFETY CONSIDERATIONS

1.1 Electric Shock Hazard

Electrical shocks due to faulty mains driven power supplies.

Whilst ever potentially present in any electrical equipment, such a condition would be minimised by quality installation practice and thorough testing at:

- a) Original assembly.
- b) Commissioning.
- c) Regular intervals, thereafter.

All test equipment to be in good working order prior to its use. High current power supplies can be dangerous because of the possibility of substantial arcing. Always switch off during disconnection and reconnection.

1.2 RF Radiation Hazard

“CAUTION: This equipment is approved for antennas mounted on fixed outdoor permanent structures. A minimum separation distance of 2 metres must be maintained between the radiating elements and any nearby persons. A maximum antenna gain of 21 dBi may be used. Operating this equipment without regard to these restrictions will result in RF exposure levels above the limits allowed by FCC rules.”

This equipment complies with part 90 of the FCC rules. Any changes or modifications not expressly approved by the manufacturer could void the user’s authority to operate the equipment.

Antenna positions should be chosen to comply with requirements (both local & statutory) regarding exposure of personnel to RF radiation. When connected to an antenna, the unit is capable of producing RF field strengths, which may exceed guideline safe values especially if used with antennas having appreciable gain. In this regard the use of directional antennas with backscreens and a strict site rule that personnel must remain behind the screen while the RF power is on, is strongly recommended.

RF radiation, (especially at UHF frequencies) arising from transmitter outputs connected to AFL’s equipment, must be considered a safety hazard.

This condition might only occur in the event of cable disconnection, or because a ‘spare’ output has been left unterminated. Either of these conditions would impair the system’s efficiency. No investigation should be carried out until all RF power sources have been removed. This would always be a wise precaution, despite the severe mismatch between the impedance of an N type connector at 50Ω, and that of free space at 377Ω, which would severely mitigate against the efficient radiation of RF power. Radio frequency burns could also be a hazard, if any RF power carrying components were to be carelessly touched!

Where the equipment is used near power lines, or in association with temporary masts not having lightning protection, the use of a safety earth connected to the case-earthing bolt is strongly advised.

 Aerial Facilities Limited www.AerialFacilities.com Technical Literature	PBL UHF1/1A 1 & 2 Air Interface Maintenance Handbook		
	H/book Number:-60-055900HBKM	Issue No:-2	Date:-20/10/2003

1.3 Chemical Hazard



Beryllium Oxide, also known as Beryllium Monoxide, or Thermalox™, is sometimes used in devices within equipment produced by Aerial Facilities Ltd. Beryllium oxide dust can be toxic if inhaled, leading to chronic respiratory problems. It is harmless if ingested or by contact.

Products that contain beryllium are load terminations (dummy loads) and some power amplifiers. These products can be identified by a yellow and black “skull and crossbones” danger symbol (shown above). They are marked as hazardous in line with international regulations, but pose no threat under normal circumstances. Only if a component containing beryllium oxide has suffered catastrophic failure, or exploded, will there be any danger of the formation of dust. Any dust that has been created will be contained within the equipment module as long as the module remains sealed. For this reason, any module carrying the yellow and black danger sign should not be opened. If the equipment is suspected of failure, or is at the end of its life-cycle, it must be returned to Aerial Facilities Ltd for disposal.

To return such equipment, please contact the Quality Department, who will give you a Returned Materials Authorisation (RMA) number. Please quote this number on the packing documents, and on all correspondence relating to the shipment.

PolyTetraFluoroEthylene, (P.T.F.E.) and P.T.F.E. Composite Materials

Many modules/components in AFL equipment contain P.T.F.E. as part of the RF insulation barrier.

This material should never be heated to the point where smoke or fumes are evolved. Any person feeling drowsy after coming into contact with P.T.F.E. especially dust or fumes should seek medical attention.

 Aerial Facilities Limited www.AerialFacilities.com Technical Literature	PBL UHF1/1A 1 & 2 Air Interface Maintenance Handbook		
	H/book Number:- 60-055900HBKM	Issue No:-2	Date:- 20/10/2003

1.4 Laser safety



General good working practices adapted from EN60825-2: 1994

“Do not stare with unprotected eyes or with any unapproved optical device at the fibre ends or connector faces or point them at other people.”

“Use only approved filtered or attenuating viewing aids.”

“Any single or multiple fibre end or ends found not to be terminated (for example, matched, spliced) shall be individually or collectively covered when not being worked on. They shall not be readily visible and sharp ends shall not be exposed.”

“When using test cords, the optical power source shall be the last connected and the first disconnected.”

“Use only approved methods for cleaning and preparing optical fibres and optical connectors.”

Always keep optical connectors covered to avoid physical damage

Do not allow any dirt/foreign material ingress on the optical connector bulkheads.

The optical fibre jumper cable maximum bend radius is 3cm, any smaller radii may result in optical cable breakage or excessive transmission losses.

Caution: Do not get them wet, the FO units are NOT weather proof.

1.5 Emergency Contact Numbers

The AFL Quality Department can be contacted on:

Telephone +44 (0)1494 777000
Fax +44 (0)1494 777002
e-mail qa@aerial.co.uk

 Aerial Facilities Limited www.AerialFacilities.com Technical Literature	PBL UHF1/1A 1 & 2 Air Interface Maintenance Handbook		
	H/book Number:-60-055900HBKM	Issue No:-2	Date:-20/10/2003

2. OVERVIEW/SYSTEM DESCRIPTION

The AFL Off air Amplifiers for the Pasadena Blue line project are 2 way on-band RF amplifiers. Their application is as an interface between the donor radio sites and the Fibre optic receivers and transmitters which will extend coverage to the locations via the fibre optic link. There are two units one designated for the ‘UHF1’ frequencies the other for the ‘UHF2’ frequencies.

Each unit is housed in an environmentally protected IP65 steel wall-mount case. Handles are provided for carrying the unit and the door is fitted with locks. The unit interfaces with ‘N’ type female connectors for RF connections and heavy duty connectors for routing of AC power supply input and alarm output wiring. Cable glands are provided for routing of the Fibre optic cable in to the unit.

To provide adequate selectivity in the Downlink and Uplink paths, combine design bandpass quadplexers and duplexers are used at the air interface ports. In addition each channel to be passed is selected by a 15kHz or 25KHz Channel module which provides a high level of rejection at adjacent channels. To provide the required gain to reach the required signal levels, low-noise amplifiers (LNA’s) are used in each path, these being followed by power amplifier modules in the uplink to provide the required intermodulation performance. Gain adjustment is available locally using switched attenuators.

Note that “Downlink” refers to the RF path from the base station (donor site) to the FO transmitter and that “Uplink” refers to the RF path from the FO receiver to the remote base station.

 Aerial Facilities Limited www.AerialFacilities.com Technical Literature	PBL UHF1/1A 1 & 2 Air Interface Maintenance Handbook		
	H/book Number:- 60-055900HBKM	Issue No:-2	Date:- 20/10/2003

3. SPECIFICATIONS

3.1 Parts Lists

3.1.1 UHF1/1A & UHF2 Location ONE 60-055900 Parts List

AFL Part Nō.	Part Description	Qty.
60-055901	PBL F/O AIR INTERFACE LOC1 UHF1	1
60-055902	PBL F/O AIR INTERFACE LOC1 UHF2	1

3.1.1.1 F/O Air Interface 60-055901 Location ONE-UHF1 Parts List

02-013401	6P CL FILTER (0.5 min BW) LARGE SMA ASSY	4
05-002603	UHF 3dB SPLITTER SMA	2
05-003401	4 WAY SPLITTER LOW POWER	2
10-000701	1/4W0-30dB SWITCHED ATTENUATOR	6
11-006102	LNA 380-500MHz 1W WITH RELAY	1
11-007302	LNA. 380-500MHz 20dB (C/W RELAY) GA	5
11-007402	LNA. 380-500MHz 30dB (C/W RELAY) GA	2
12-001801	UHF PWR AMP.450MHz 5W SMA ALARMS	1
12-002201	3 STAGE AMPLIFIER ALARM BOARD	1
12-002220	3 STAGE ALARM PCB COVER	1
12-002826	ALARM BOARD ACRYLIC LENS	1
13-003011	DC/DC CONVERTER 24-12V 8A PCB SUB-ASS	1
17-000126	CELL ENHANCER LABEL 6 DIGIT	1
17-001523	GREY C.E. HEATSINK BLANKING PLATE	1
17-002020	CASE 620 x 620 x 250 SCHROFF CUSTOM	1
17-002021	BASE PLATE 585 x 570mm FOR 17-002020	1
17-002101	CHANNEL CONTROL MODULE	2
17-002103	26WAY RIBBON CABLE LEAD	0
17-003012	CHAN MOD 450MHz, 15kHz B/W	6
17-003022	MODULE PATTERNED LEAVE	6
17-003023	SUBRACK SIDE PANEL	2
17-003024	SUBRACK REAR BRACKET	6
17-003025	BOTTOM MODULE GUIDE	6
17-003028	MODULE SQUARE LEAVE	6
17-003029	TOP MODULE GUIDE	6
17-009723	EQUIP. MTG PLATE No.4	8
17-009727	EQUIP. MTG PLATE No.8	1
20-001602	24V RELAY BOARD	1
80-008902	24V RELAY PCB ASSEMBLY	1
80-032320	POWER AMP HEATSINK 10W 900MHz	1
80-032322	POWER SUPPLY HEATSINK 10W	1
90-010021	RF CABLE SUPFLEX SMA R/A MALE 100mm	15

 Aerial Facilities Limited www.AerialFacilities.com Technical Literature	PBL UHF1/1A 1 & 2 Air Interface Maintenance Handbook		
	H/book Number:- 60-055900HBKM	Issue No:-2	Date:- 20/10/2003

90-010022	RF CABLE SUPFLEX SMA R/A MALE 200mm	2
90-010026	RF CABLE HIFLEX SMA R/A MALE 150mm	6
90-010027	RF CABLE HIFLEX SMA R/A MALE 250mm	2
90-010028	RF CABLE HIFLEX SMA R/A MALE 350mm	1
90-010130	RF CABLE SMA R/A-N PANEL JACK 100mm	1
90-010131	RF CABLE SMA R/A-N PANEL JACK 200mm	3
90-010134	RF CABLE SMA R/A-N PANEL JACK 400mm	1
90-010135	RF CABLE SMA R/A-N PANEL JACK 500mm	2
91-030002	N ADAPTOR PANEL FEMALE:FEMALE	0
91-500011	PWR 3POLE PNL PLUG SEALED IP68	1
91-500015	PWR CON CAP SEALED with INT. THREAD	2
91-500016	PWR 6POLE PNL PLUG SEALED IP68	1
91-510010	PWR 3POLE FREE SOC.SEALED IP68	1
91-510013	PWR CON CAP SEALED with Ext. THREAD	2
91-510014	PWR 6POLE FREE SOC.SEALED IP68	1
91-600005	'D' 9 WAY SOCKET S/B TERM	0
91-600007	'D' 9 WAY BLACK SHELL	0
91-600014	'D' 9 WAY SOCKET S/B (NON FILTERED)	8
91-620002	'D' 25 WAY SOCKET/IDC TERMS	6
91-640003	MISC 26 WAY RIBBON CABLE SOCK.	6
91-700017	ICD 15 WAY 0.1' CONNECTOR	2
92-280033	Captive Screw	12
92-400017	GASKET FOR N TYPE CONNECTOR	3
93-540035	1K3 0.25W 1% RES MRS25 M:F	2
93-930003	SMA COAX TERMINATION [RADIAL]	2
96-300011	24 V 400 W FLATPACK PWR SUPPLY	1
96-500003	AC FILTER 110V 5A	1
96-500005	DC INPUT FILTERS	1
96-700002	LED.GREEN 5mm SEALED IP66	1
96-700005	LED.RED 5mm SEALED IP66	1
96-900018	AC TRIP SWITCH (5 AMP M.C.B.)	1
96-920011	PROXIMITY SWITCH	1
96-920012	PROXIMITY SWITCH MAGNET	1
97-000002	BLACK MODULE CAGE RUNNER	12
97-300010	SUPPLY I/P COVERS	1
97-400010	BLACK PLASTIC HANDLE 37311	2
97-600001	SUBRACK FRONT HORIZ	2
97-600002	SUBRACK M2.5 STD TAP	8
97-900004	RUBBER FOOT FOR CELL ENHANCERS	4

3.1.1.2 F/O Air Interface 60-055902 Location ONE, UHF2 Parts List

AFL Part No.	Part Description	Qty.
02-013401	6P CL FLTR(0.5 min BW) LARGE SMA ASSY	2
05-002603	UHF 3dB SPLITTER SMA	1
05-003019	4 PORT THC 3dB 450MHz SMA TYPE	1
05-003401	4 WAY SPLITTER LOW POWER	4
10-000701	1/4W0-30dB SWITCHED ATTENUATOR	2
11-007302	LNA. 380-500MHz 20dB (C/W RELAY) GA	1
11-007402	LNA. 380-500MHz 30dB (C/W RELAY) GA	5
12-002201	3 STAGE AMPLIFIER ALARM BOARD	1
12-002220	3 STAGE ALARM PCB COVER	1
12-002826	ALARM BOARD ACRYLIC LENS	1
12-004201	PWR AMP.450MHz 20W version CLASS A	1
13-003011	DC/DC CONVERTER 24-12V 8A PCB SUB-ASS	1
17-000126	CELL ENHANCER LABEL 6 DIGIT	1
17-002020	CASE 620 x 620 x 250 SCHROFF CUSTOM	1
17-002021	BASE PLATE 585 x 570mm FOR 17-002020	1
17-002101	CHANNEL CONTROL MODULE	1
17-002103	26WAY RIBBON CABLE LEAD	0
17-002502	IF FILTER BOARD 21.4MHz 30kHz	1
17-003012	CHAN MOD 450MHz, 15kHz B/W	8
17-003022	MODULE PATTERNED LEAVE	7
17-003023	SUBRACK SIDE PANEL	2
17-003024	SUBRACK REAR BRACKET	8
17-003025	BOTTOM MODULE GUIDE	8
17-003028	MODULE SQUARE LEAVE	8
17-003029	TOP MODULE GUIDE	8
17-009723	EQUIP. MTG PLATE No.4	6
17-009726	EQUIP. MTG PLATE No.7	1
20-001602	24V RELAY BOARD	0
80-008902	24V RELAY PCB ASSEMBLY	1
80-031820	POWER AMP HEATSINK 20W 900MHz	1
80-032320	POWER AMP HEATSINK 10W 900MHz	0
80-032322	POWER SUPPLY HEATSINK 10W	2
90-010021	RF CABLE SUPFLEX SMA R/A MALE 100mm	20
90-010022	RF CABLE SUPFLEX SMA R/A MALE 200mm	3
90-010024	RF CABLE SUPFLEX SMA R/A MALE 400mm	1
90-010025	RF CABLE SUPFLEX SMA R/A MALE 500mm	3
90-010026	RF CABLE HIFLEX SMA R/A MALE 150mm	8
90-010027	RF CABLE HIFLEX SMA R/A MALE 250mm	2
90-010028	RF CABLE HIFLEX SMA R/A MALE 350mm	2
90-010030	RF CABLE HIFLEX SMA R/A MALE 600mm	3
90-010131	RF CABLE SMA R/A-N PANEL JACK 200mm	1
90-010135	RF CABLE SMA R/A-N PANEL JACK 500mm	2

91-030002	N ADAPTOR PANEL FEMALE:FEMALE	0
91-500011	PWR 3POLE PNL PLUG SEALED IP68	1
91-500015	PWR CON CAP SEALED with INT. THREAD	2
91-500016	PWR 6POLE PNL PLUG SEALED IP68	1
91-510010	PWR 3POLE FREE SOC.SEALED IP68	1
91-510013	PWR CON CAP SEALED with Ext. THREAD	2
91-510014	PWR 6POLE FREE SOC.SEALED IP68	1
91-600005	'D' 9 WAY SOCKET S/B TERM	0
91-600007	'D' 9 WAY BLACK SHELL	0
91-600014	'D' 9 WAY SOCKET S/B (NON FILTERED)	6
91-620002	'D' 25 WAY SOCKET/IDC TERMS	8
91-640003	MISC 26 WAY RIBBON CABLE SOCK.	8
91-700017	ICD 15 WAY 0.1' CONNECTOR	2
91-800014	3 WAY TERMINAL BLOCK	1
91-800019	OPTICAL BARREL ADAPT	4
92-120009	M20 IP68 CABLE GLAND	2
92-280033	Captive Screw	16
92-400017	GASKET FOR N TYPE CONNECTOR	3
93-540035	1K3 0.25W 1% RES MRS25 M:F	2
93-930003	SMA COAX TERMINATION [RADIAL]	0
96-300011	24 V 400 W FLATPACK PWR SUPPLY	1
96-300045	JWS75-15/A PSU (COUTANT LAMBDA)	1
96-500003	AC FILTER 110V 5A	1
96-500005	DC INPUT FILTERS	1
96-700002	LED.GREEN 5mm SEALED IP66	1
96-700005	LED.RED 5mm SEALED IP66	1
96-900018	AC TRIP SWITCH (5 AMP M.C.B.)	1
96-920011	PROXIMITY SWITCH	1
96-920012	PROXIMITY SWITCH MAGNET	1
97-000002	BLACK MODULE CAGE RUNNER	16
97-300010	SUPPLY I/P COVERS	1
97-400010	BLACK PLASTIC HANDLE 37311	2
97-600001	SUBRACK FRONT HORIZ	2
97-600002	SUBRACK M2.5 STD TAP	8
97-900004	RUBBER FOOT FOR CELL ENHANCERS	4
98-100001	1 x 2 SINGLE MODE OPTICAL COUPLR 1310	1
98-200003	FIBRE OPTIC Rx 6325 1310nm <2.2GHz	2
98-300003	FIBRE OPTIC Tx 6325 1310nm <2.2GHz	1
98-500004	FC/APC-FC/APC FIBREOPTIC CABLE 0.5M	2

3.1.1.3 F/O Air Interface 60-055903 Location ONE, UHF1A Parts List

AFL Part Nō.	Part Description	Qty.
02-013401	6P CL FILTER (0.5 min BW)LARGE SMA ASSY	2
05-002603	UHF 3dB SPLITTER SMA	3
05-003401	4 WAY SPLITTER LOW POWER	4
10-000701	1/4W0-30dB SWITCHED ATTENUATOR	4
11-007402	LNA. 380-500MHz 30dB (C/W RELAY) GA	5
12-002201	3 STAGE AMPLIFIER ALARM BOARD	1
12-002220	3 STAGE ALARM PCB COVER	1
12-016301	PA 380-470MHz 20W CLASS A	1
13-003011	DC/DC CONVERTER 24-12V 8A PCB SUB-ASS	1
17-000126	CELL ENHANCER LABEL 6 DIGIT	1
17-002020	CASE 620 x 620 x 250 SCHROFF CUSTOM	1
17-003012	CHAN MOD 450MHz, 15kHz (8p) BW	6
17-003022	MODULE PATTERNED LEAVE	32
17-003023	SUBRACK SIDE PANEL	4
17-003024	SUBRACK REAR BRACKET	32
17-003025	BOTTOM MODULE GUIDE	16
17-003028	MODULE SQUARE LEAVE	32
17-003029	TOP MODULE GUIDE	16
20-001602	24V RELAY BOARD	1
80-031820	20W PA HEATSINK (NEEDS 17-000526)	1
80-032320	10W PA HEATSINK (NEEDS 17-000526)	1
91-030002	N ADAPTOR PANEL FEMALE:FEMALE	3
91-500011	PWR 3POLE PNL PLUG SEALED IP68	1
91-500015	PWR CON CAP SEALED with INT. THREAD	2
91-500016	PWR 6POLE PNL PLUG SEALED IP68	1
91-600005	'D' 9 WAY SOCKET S/B TERM	6
91-600007	'D' 9 WAY BLACK SHELL	6
93-540035	1K3 0.25W 1% RES MRS25 M:F	1
93-930003	SMA COAX TERMINATION [RADIAL]	2
96-300011	24 V 400 W FLATPACK PWR SUPPLY	1
96-500005	DC INPUT FILTERS	1
96-700002	LED.GREEN 5mm SEALED IP66	1
96-700005	LED.RED 5mm SEALED IP66	1
96-920011	PROXIMITY SWITCH	1
96-920012	PROXIMITY SWITCH MAGNET	1
97-400010	BLACK PLASTIC HANDLE 37311	2
97-900004	RUBBER FOOT FOR CELL ENHANCERS	4

3.2 Technical Specifications

3.2.1 UHF ONE to Tunnels 1 & 2 Technical Specification

Frequency Range:	Downlink Channels: 470.2125MHz 470.2625MHz 482.2375MHz	Uplink Channels: 473.2125MHz 473.2625MHz 485.2375MHz
Band Width	Downlink :15kHz Uplink : 25kHz	
Nō. of Paths	2	
Downlink Gain	82 dB min	
Uplink Gain	70 dB min	
RF Connector	N type female	
RF Impedance	50Ω	
VSWR	Better than 1.5:1	
Gain Adjustment	0 to 30 in 2dB steps	
Downlink PA	470.2125MHz, 470.2125MHz: 5W Class A Linear PA 482.2375MHz :20W Class A Linear PA	
Uplink PA	485.2375MHz : 1W Class A Linear 473.2625MHz, 473.2125MHz : 5W Class A Linear	
Duplexer UP/DN Isolation	>80 dB	
Passband Ripple	<±1.5 dB	
Noise Figure	Downlink <7 dB at maximum gain	
Noise Figure	Uplink <18 dB at maximum gain	
In-Band Spurious	Better than -13dBm downlink Better than -13dBm uplink (measure with 30KHz BW & max gain setting)	
Out-band Spurious up to 3GHz:	Better than -90dBc	

3.2.2 UHF1A Technical Specification

Frequency Range:	Downlink Channels: 470.0875MHz 470.1375MHz 470.3625MHz	Uplink Channels: 473.0875MHz 473.1375MHz 473.3625MHz
Band Width	Downlink : 15kHz Uplink : 15kHz	
Nō. of Paths	4	
Nō. of RF Ports	6	
Downlink Gain	51 dB min	
Uplink Gain	40 dB min	
RF Connector	N type female	
RF Impedance	50Ω	
VSWR	Better than 1.5:1	
Gain Adjustment	0 to 30 in 2dB steps	
Downlink Power	3 channels at -11dBm	
Uplink Power	3 channels at +20dBm	
Uplink PA	10Watts Class A Linear	
Passband Ripple	<±1.5dB	
Duplexer UP/DN Isolation	>80 dB	
Passband Ripple	<±1.5 dB	
Noise Figure	Downlink	<5 dB at maximum gain
Noise Figure	Uplink	<18 dB at maximum gain
In-Band Spurious	Better than -55dBm downlink Better than -55dBm uplink (measure with 30KHz BW & max gain setting)	
Out-band Spurious up to 3GHz:	Better than -90dBc	

3.2.3 UHF ONE to Location TWO Technical Specification

Frequency Range:	Downlink Channels: 470.2125MHz 470.2625MHz 482.2375MHz	Uplink Channels: 473.2125MHz 473.2625MHz 485.2375MHz
Band Width:	Downlink :15kHz Uplink : 25kHz	
No. of Paths	2	
Downlink Gain	82 dB min	
Uplink Gain	80 dB min	
RF Connector	N type female	
RF Impedance	50Ω	
VSWR	Better than 1.5:1	
Gain Adjustment	0 to 30dB in 2dB steps	
Downlink PA	470.2125MHz, 470.2125MHz: 5W Class A Linear PA 482.2375MHz :20W Class A Linear PA	
Uplink PA	485.2375MHz : 1W Class A Linear 473.2625MHz, 473.2125MHz : 5W Class A Linear	
Duplexer UP/DN Isolation	>80 dB	
Passband Ripple	<±1.5 dB	
Noise Figure	Downlink <7dB at maximum gain	
Noise Figure	Uplink <12dB	
In-Band Spurious	Better than -13dBm downlink Better than -13dBm uplink (measure with 30KHz BW with max gain setting)	
Out-band Spurious up to 3GHz	Better than -90dBc	

3.2.4 UHF TWO to Tunnels 1 & 2 Technical Specification

Frequency Range:	Downlink Channels: 483.0625MHz 483.2875MHz 483.3125MHz 483.5625MHz	Uplink Channels: 486.0625MHz 486.2875MHz 486.3125MHz 486.5625MHz
Band Width:	Downlink :15kHz Uplink : 25kHz ,486.0625MHz, 486.5625MHz 15kHz ,486.2875MHz, 486.3125MHz	
Nõ. of Paths:	2	
RF Connector:	N type female	
RF Impedance:	50Ω	
VSWR:	Better than 1.5:1	
Downlink Gain:	90 dB min	
Uplink Gain:	68 dB min	
Gain Adjustment:	0 to 30 in 2dB steps	
Downlink PA:	20W Class A Linear	
Uplink PA:	20W Class A Linear	
Duplexer UP/DN Isolation:	>80 dB	
Passband Ripple:	<±1.5 dB	
Noise Figure:	Downlink <5 dB at maximum gain	
Noise Figure:	Uplink <12dB at maximum gain	
In-Band Spurious:	Better than -13dBm downlink Better than -13dBm uplink (measure with 30KHz BW with max gain setting)	
Out-band Spurious up to 3GHz:	Better than -90dBc	

3.2.5 UHF TWO to Location TWO Technical Specification

Frequency Range:	Downlink Channels: 483.0625MHz 483.2875MHz 483.3125MHz 483.5625MHz	Uplink Channels: 486.0625MHz 486.2875MHz 486.3125MHz 486.5625MHz
Band Width:	Downlink :15kHz Uplink : 25kHz ,486.0625MHz, 486.5625MHz 15kHz ,486.2875MHz, 486.3125MHz	
Nō. of Paths:	2	
RF Connector:	N type female	
RF Impedance:	50Ω	
VSWR:	Better than 1.5:1	
Downlink Gain:	90 dB min	
Uplink Gain:	78 dB min	
Gain Adjustment:	0 to 30 in 2dB steps	
Downlink PA:	20W Class A Linear	
Uplink PA:	20W Class A Linear	
Duplexer UP/DN Isolation:	>80 dB	
Passband Ripple:	<±1.5 dB	
Noise Figure:	Downlink <5 dB at maximum gain	
Noise Figure:	Uplink <12 dB at maximum gain	
In-Band Spurious:	Better than -13dBm downlink Better than -13dBm uplink (measure with 30KHz BW & max gain setting)	
Out-band Spurious up to 3GHz:	Better than -90dBc	

3.2.6 800MHz Bi-directional Amplifier to Location TWO Technical Specification

Frequency Range:	Downlink Channels: 857.9375MHz 859.7625MHz	Uplink Channels: 812.9375MHz 814.7625MHz
Band Width:	Downlink :15kHz Uplink : 25kHz	
No. of Paths:	2	
No. of RF Ports:	2	
No. of Fibre Connections:	N/A	
RF Connector:	N type female	
RF Impedance:	50Ω	
VSWR:	Better than 1.5:1	
Downlink Gain:	78 dB min	
Uplink Gain:	80 dB min	
Gain Adjustment:	0 to 30 in 2dB steps	
Downlink PA:	5W Class A Linear	
Downlink Power:	2 Carriers at +18dBm	
Uplink PA:	5W Class A Linear	
Uplink Power:	2 Carriers at +18dBm	
Duplexer UP/DN Isolation:	>80 dB	
Passband Ripple:	<±1.5 dB	
Noise Figure:	Uplink <6 dB at maximum gain Downlink <5 dB at maximum gain	
In-Band Spurious:	Better than -13dBm downlink Better than -13dBm uplink (measure with 30KHz BW with max gain setting)	
MTBF:	>50,000 hours	
Supply Input Voltage:	110V AC	
Alarms Fitted:	Alarm:- Volts free contacts Alarm indicator:- Red LED Power Indicator:-Green LED Door Intrusion:- Magnetic proximity switch	

3.3 Mechanical Specification (UHF1/1A & UHF2 Wall Cases)

Case size	Height:	620mm
	Width:	620mm
	Depth:	250mm
(excluding heatsinks, connectors, handles and feet)		
Fixings:		4 holes on 670(w) x 557(h)mm
Temperature Range	operational:	-10°C to +55°C
	storage:	-40°C to +70°C
Weight:		70kg (approximately)
RF Connectors:		N type female
Environmental Protection:		IP65 (with door closed and all ports terminated)
Finish:	Case:	To RAL 7032
	Heatsinks:	Matt black (where fitted)
	Handles:	Black plastic
Supply Cable:		Unit supplied with suitable supply input leads with connector and appropriate length of cable

4. SYSTEM DRAWINGS

4.1 Drg. No. 60-055990, Location ONE, UHF1/1A Case Outline Drawing

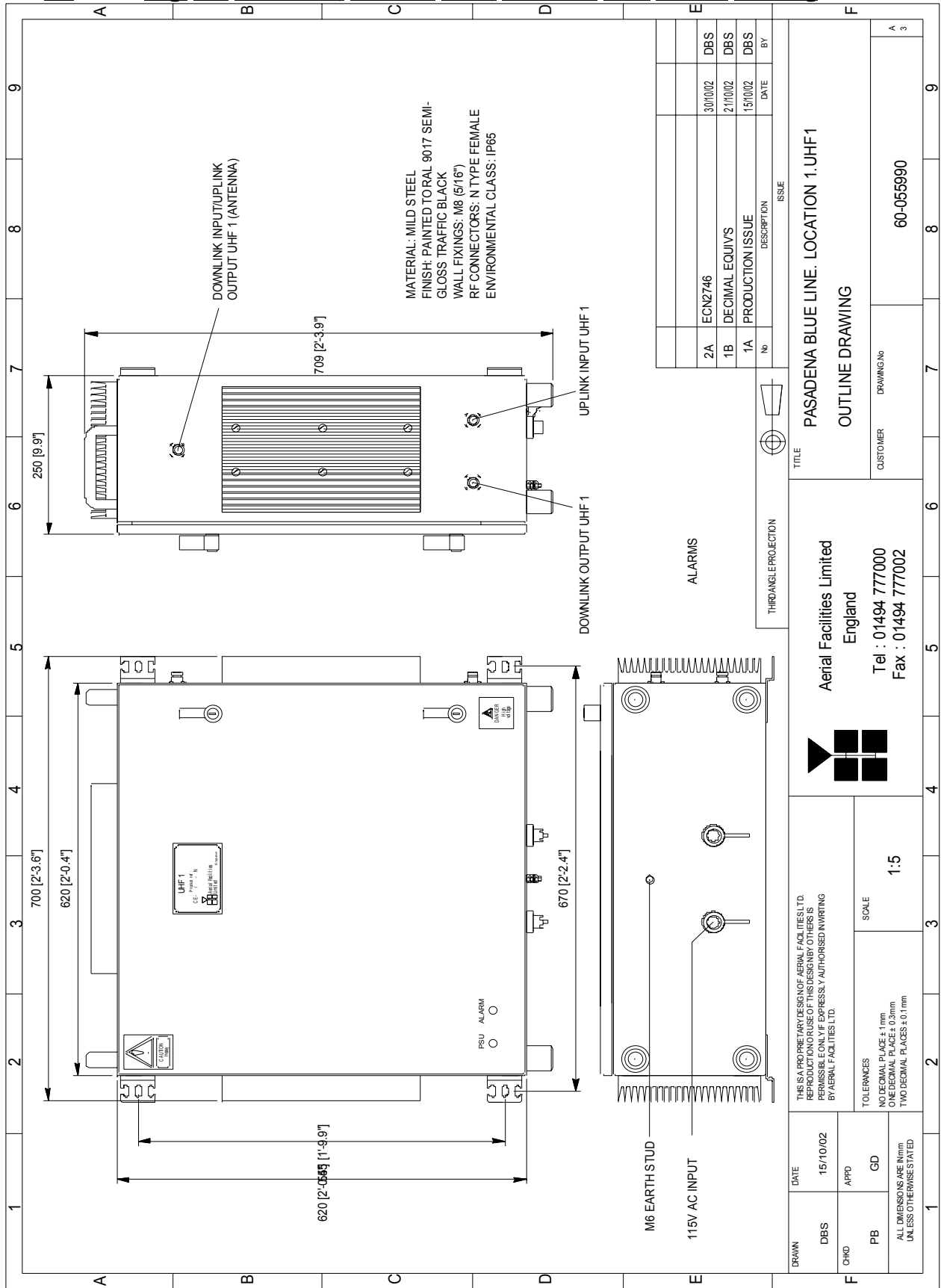

4.2 Drg. No. 60-055994 Location one, UHF1A (Upgrade) Case Outline Drawing

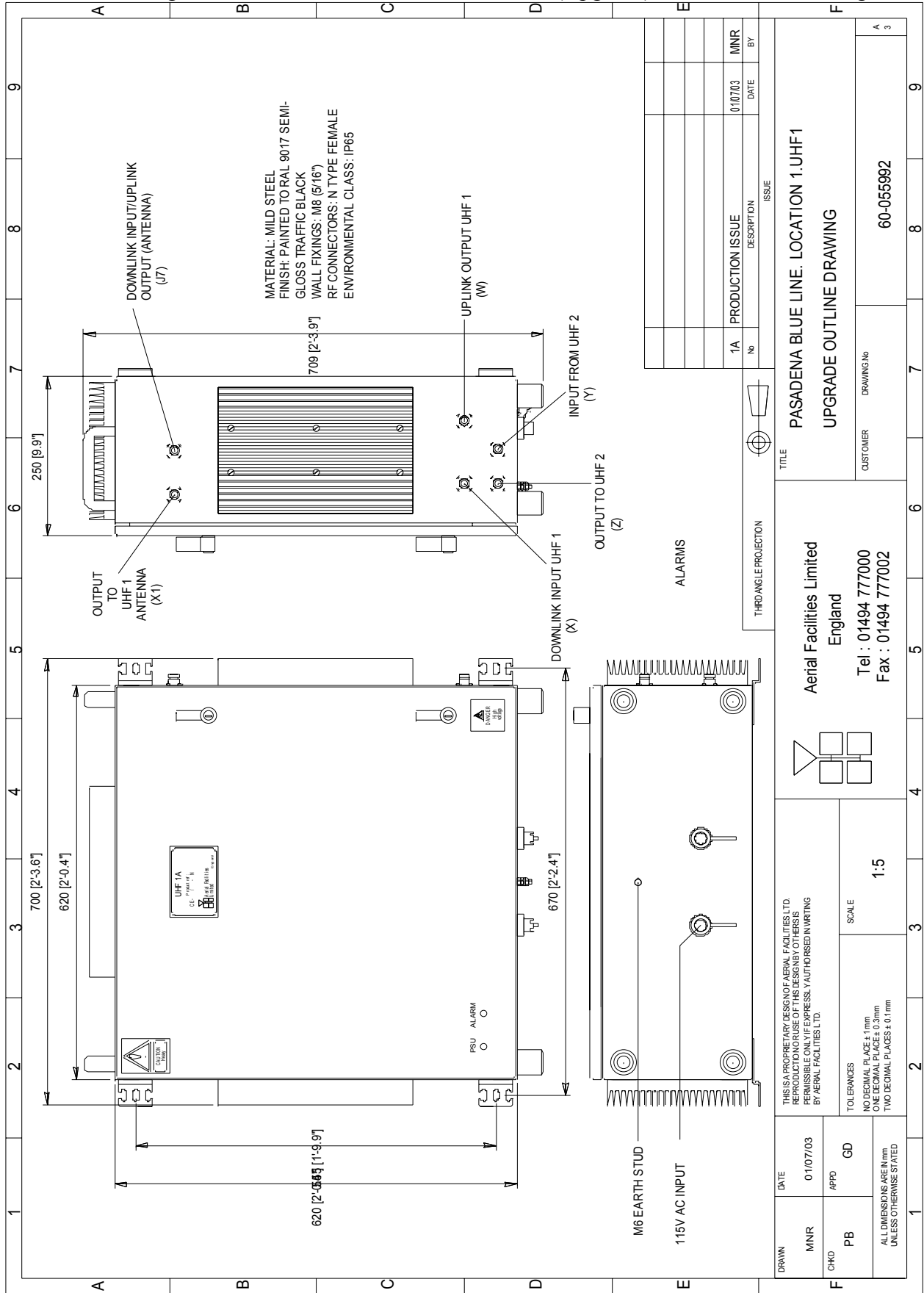

4.3 Drg. No. 60-055991, Location One, UHF 2 Case Outline Drawing

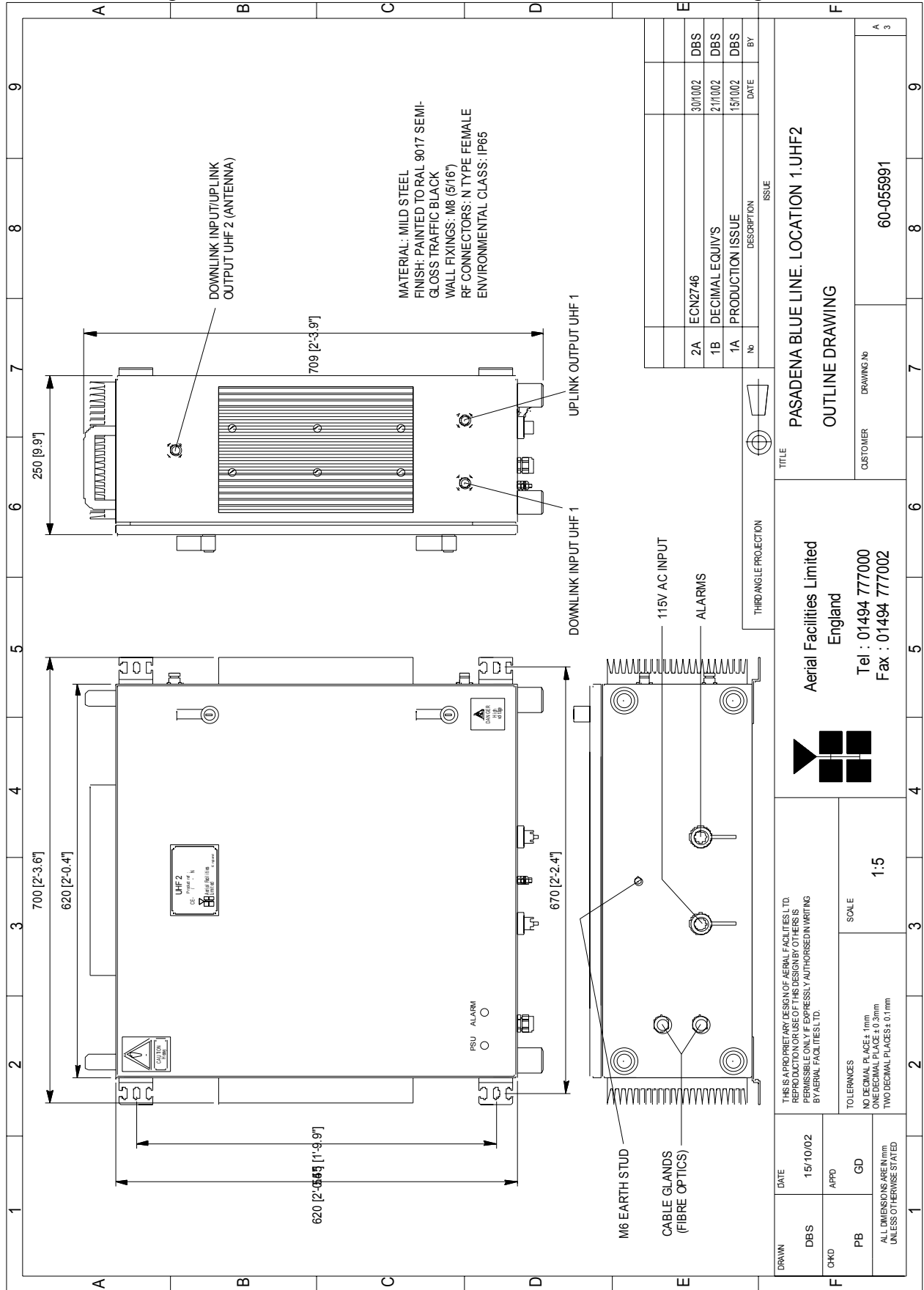

TITLE PASADENA BLUE LINE. LOCATION 1. UHF2
 OUTLINE DRAWING
 CUSTOMER DRAWING No 60-055991
 Aerial Facilities Limited
 England
 Tel : 01494 777000
 Fax : 01494 777002

THIS IS A PROPRIETARY DESIGN OF AERIAL FACILITIES LTD.
 REPRODUCTION OR USE OF THIS DESIGN BY OTHERS IS
 EXPRESSLY FORBIDDEN WITHOUT THE EXPRESSLY AUTHORISED WRITING
 BY AERIAL FACILITIES LTD.
 TOLERANCES
 NO DECIMAL PLACE: 1mm
 ONE DECIMAL PLACE: 0.3mm
 TWO DECIMAL PLACE: 0.1mm
 SCALE 1:5
 DATE 15/10/02
 APPD GD
 DRAWN DBS

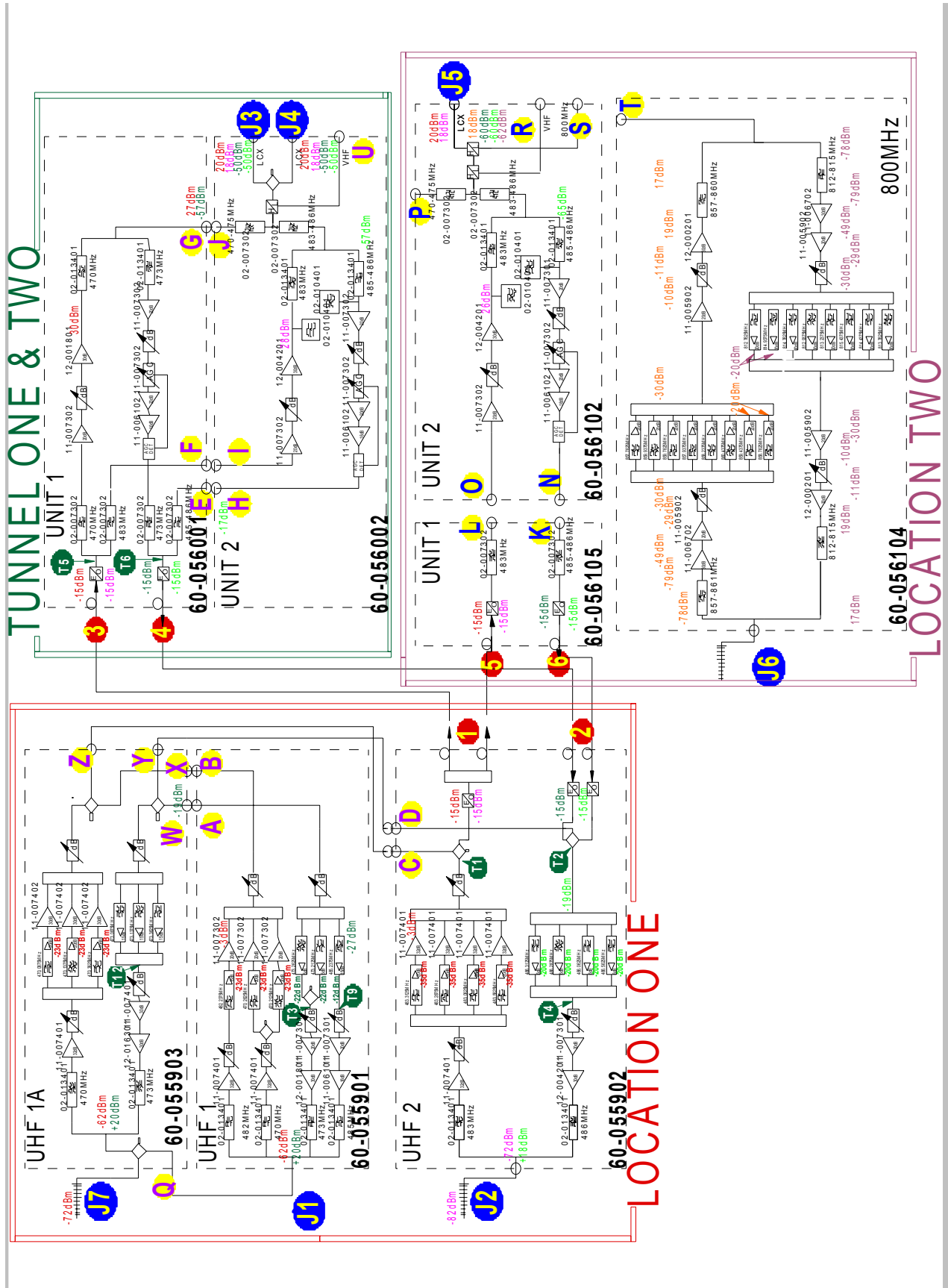

4.5 UHF1/1A & UHF2 System Diagram Sketch

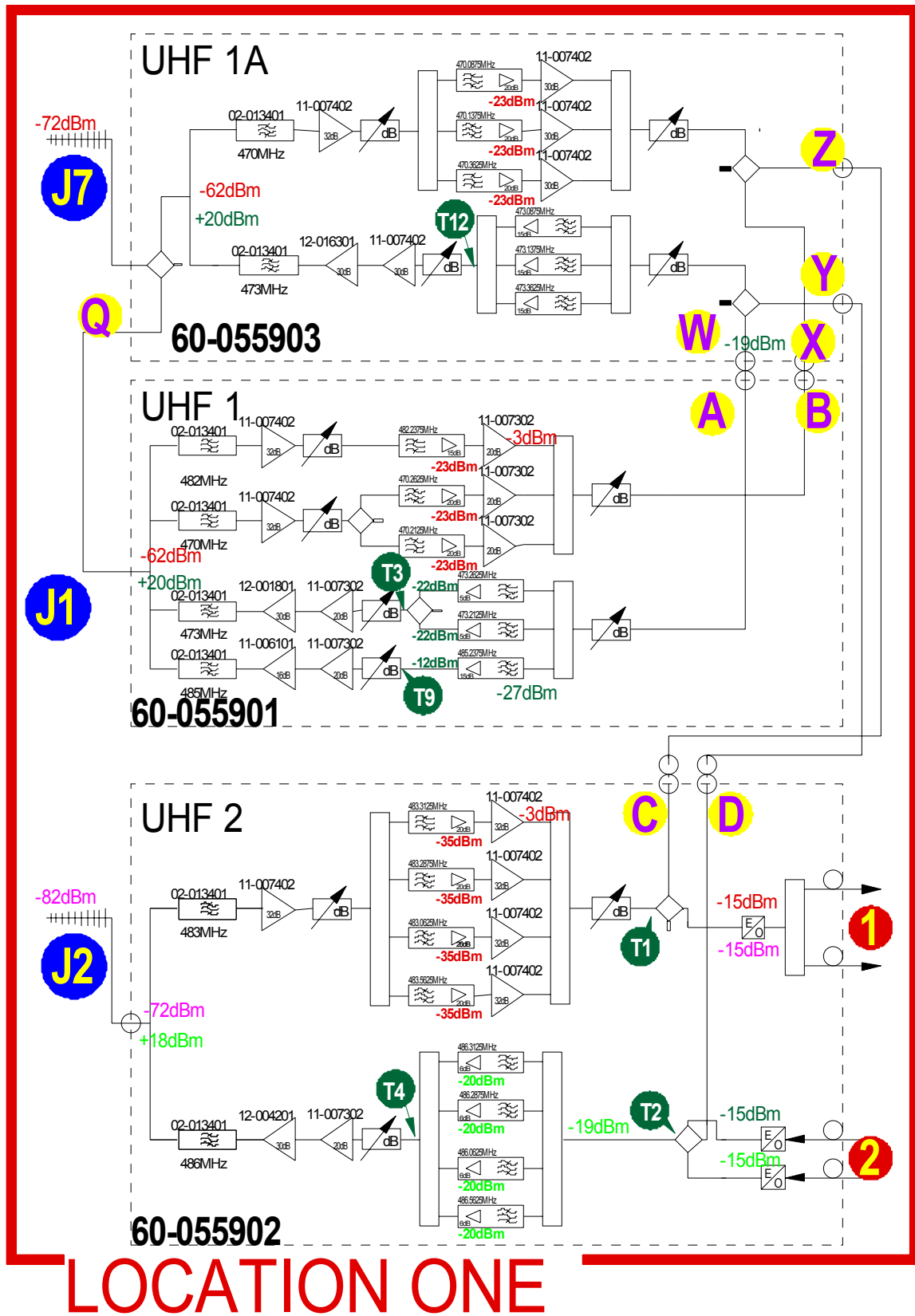

5. SUB-UNIT MODULES

5.1 UHF 1 Air Interface (60-055901)

5.1.1 Bandpass Duplexers (02-013401)

5.1.1.1 Description

The bandpass filters are multi-section designs with a bandwidth dependent upon the passband frequencies, (both tuned to customer requirements). The response shape is basically Chebyshev with a passband design ripple of 0.1dB. The filters are of combline design, and are carefully aligned during manufacture in order to optimise the insertion loss, VSWR and intermodulation characteristics of the unit. The tuned elements are silver-plated to reduce surface ohmic losses and maintain a good VSWR figure and 50Ω load at the input and output ports. Note that the same filter is used for both UHF 1 & 2, but tuned differently depending on the required frequencies and bandwidth for each air interface.

Being passive devices, the bandpass filters should have an extremely long operational life and require no maintenance. Should a filter be suspect, it is usually most time efficient to replace the module rather than attempt repair or re-tuning.

No adjustments should be attempted without full network sweep analysis facilities to monitor both insertion loss and VSWR simultaneously.

5.1.1.2 Technical Specification

PARAMETER		SPECIFICATION
Passband:	FILTER 1	483.2-483.6 MHz
	FILTER 2	486.2-486.6 MHz
Insertion Loss:	FILTER 1	2.7 dB typical
	FILTER 2	2.7 dB typical
Rejection:	FILTER 1	483.2-483.6 MHz > 80 dB
	FILTER 2	486.2-486.6 MHz > 80 dB
Power Rating:		250 Watt
Impedance:		50 ohm
VSWR:		Better than 1.2:1
Connectors:		SMA female

5.1.2 2 & 4 Way UHF Splitters (05-002603 & 05-003401)

5.1.2.1 Description

The Splitter/Combiners used are UHF (300-500MHz) devices for accurately matching two or more RF signals to single or multiple ports, whilst maintaining an accurate 50Ω load to all inputs/outputs and ensuring that the VSWR and insertion losses are kept to a minimum. Any unused ports will be terminated with an appropriate 50Ω load.

5.1.2.2 Technical Specification (05-002603)

PARAMETER	SPECIFICATION
Frequency Range:	380 - 520 MHz
Bandwidth:	140 MHz
Inputs:	1
Outputs:	2
Insertion Loss:	3.5 dB (typical)
Isolation:	>18 dB
Return Loss (VSWR) – Input:	Better than 1.3:1
Return Loss (VSWR) – Output:	Better than 1.3:1
Impedance:	50 Ω
Power Rating – Splitter:	20 Watts
Power Rating – Combiner:	0.5 Watt
Connectors:	SMA female
Size:	54 x 44 x 21 mm (including connectors)
Weight:	200 g

5.1.2.3 Technical Specification 05-003401

PARAMETER	SPECIFICATION
Frequency range:	70 – 250MHz
Bandwidth:	180MHz
Rejection:	>14dB
Insertion loss:	(in band)
Connectors:	SMA
Weight:	<1.5Kgm
Temperature range:	operational : -10BC to +55BC
	storage : -40BC to +70BC

5.1.3 ¼Watt 0- -30dB Switched Attenuator (10-000701)

5.1.3.1 General Application

In many practical applications for Cell Enhancers etc., the gain in each path is found to be excessive. Therefore, provision is made within the unit for the setting of attenuation in each path, to reduce the gain.

5.1.3.2 Switched Attenuators

The AFL switched attenuators are available in two different types; 0 – 30dB in 2 dB steps (as in this case), or 0 – 15dB in 1 dB steps. The attenuation is simply set using the four miniature toggle switches on the top of each unit. Each switch is clearly marked with the attenuation it provides, and the total attenuation in line is the sum of the values switched in. They are designed to maintain an accurate 50Ω impedance over their operating

5.1.4 Low Noise Amplifiers (11-006102, 11-007302 & 11-007402)

5.1.4.1 General Description

The low noise amplifiers used are double or single stage solid-state low-noise amplifiers. Class A circuitry is used in the units to ensure excellent linearity over a very wide dynamic range. The active devices are very moderately rated to provide a long trouble-free working life. There are no adjustments on these amplifiers, and in the unlikely event of failure then the entire amplifier should be replaced. Note that all three amplifiers use similar DC power circuit boards.

5.1.4.2 Technical Specification (11-006102)

PARAMETER		SPECIFICATION
Frequency range:		70 – 500MHz
Bandwidth:		<430MHz
Gain:		15.5dB (typical)
1dB Compression Point:		+31dBm (typical)
3rd order intercept:		+46dBm (typical)
Input return loss:		>20dB
Output return loss:		>20dB
VSWR:		Better than 1.5:1
Noise figure:		<4.8dB
Connectors:		SMA female
Supply:		530mA @ 10 to 24V DC (typical)
Temperature range:	operational:	-10°C to +60°C
	storage:	-40°C to +70°C
Weight:		260gms

5.1.4.3 Drg. N^o. 11-006102, Low Noise Amplifier General Assembly

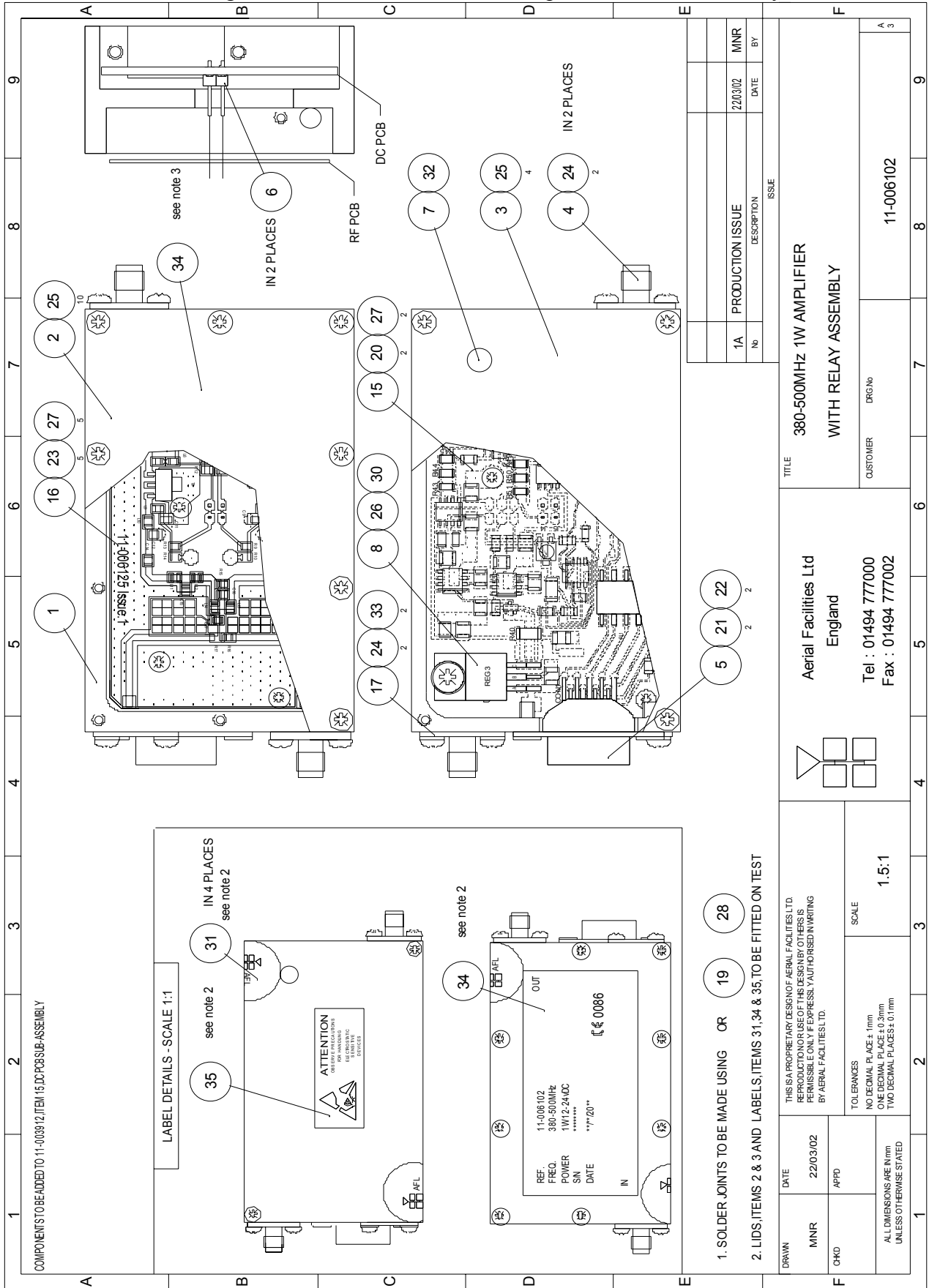

1A	PRODUCTION ISSUE	DATE	BY
		22/03/02	MNR

TITLE		380-500MHz 1W AMPLIFIER WITH RELAY ASSEMBLY	
CUSTOMER	DRG.No	11-006102	
Aerial Facilities Ltd England		Tel : 01494 777000 Fax : 01494 777002	

1. SOLDER JOINTS TO BE MADE USING OR 19 28
 2. LIDS, ITEMS 2 & 3 AND LABELS, ITEMS 31, 34 & 35, TO BE FITTED ON TEST

DATE	22/03/02	SCALE	1.5:1
APPD			
TOLERANCES		NO DECIMAL PLACE ± 1mm ONE DECIMAL PLACE ± 0.3mm TWO DECIMAL PLACES ± 0.1mm UNLESS OTHERWISE STATED	

5.1.4.4 Drg. Nō. 11-006170, LNA RF Circuit Diagram

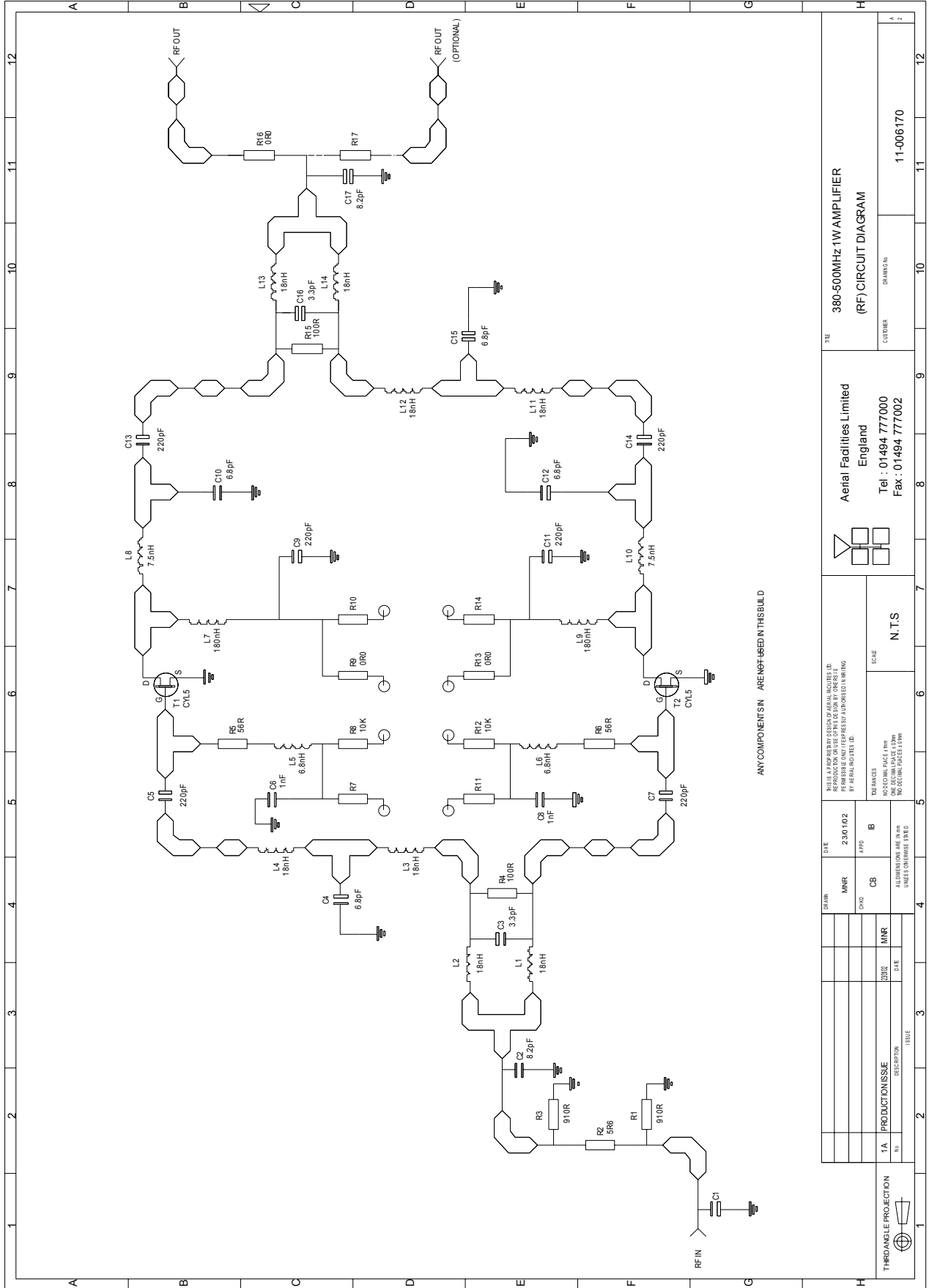

ANY COMPONENTS IN ARE NOT USED IN THIS BUILD

THRU ANGLE PROJECTION		DATE		23/01/02	
DRAWN		MNR		APPD	
CHD		CB		B	
1/A		PRODUCTION ISSUE		20/02	
DESCRIPTION		ISSUE		DATE	
11-006170		N.T.S.		SCALE	
CUSTOMER		Aerial Facilities Limited England		Tel : 01494 777000 Fax : 01494 777002	
DRAWING NO.		380-500MHZ 1W AMPLIFIER (RF) CIRCUIT DIAGRAM		TITLE	

5.1.4.5 Drg. N^o. 11-006171, LNA DC Wiring Diagram

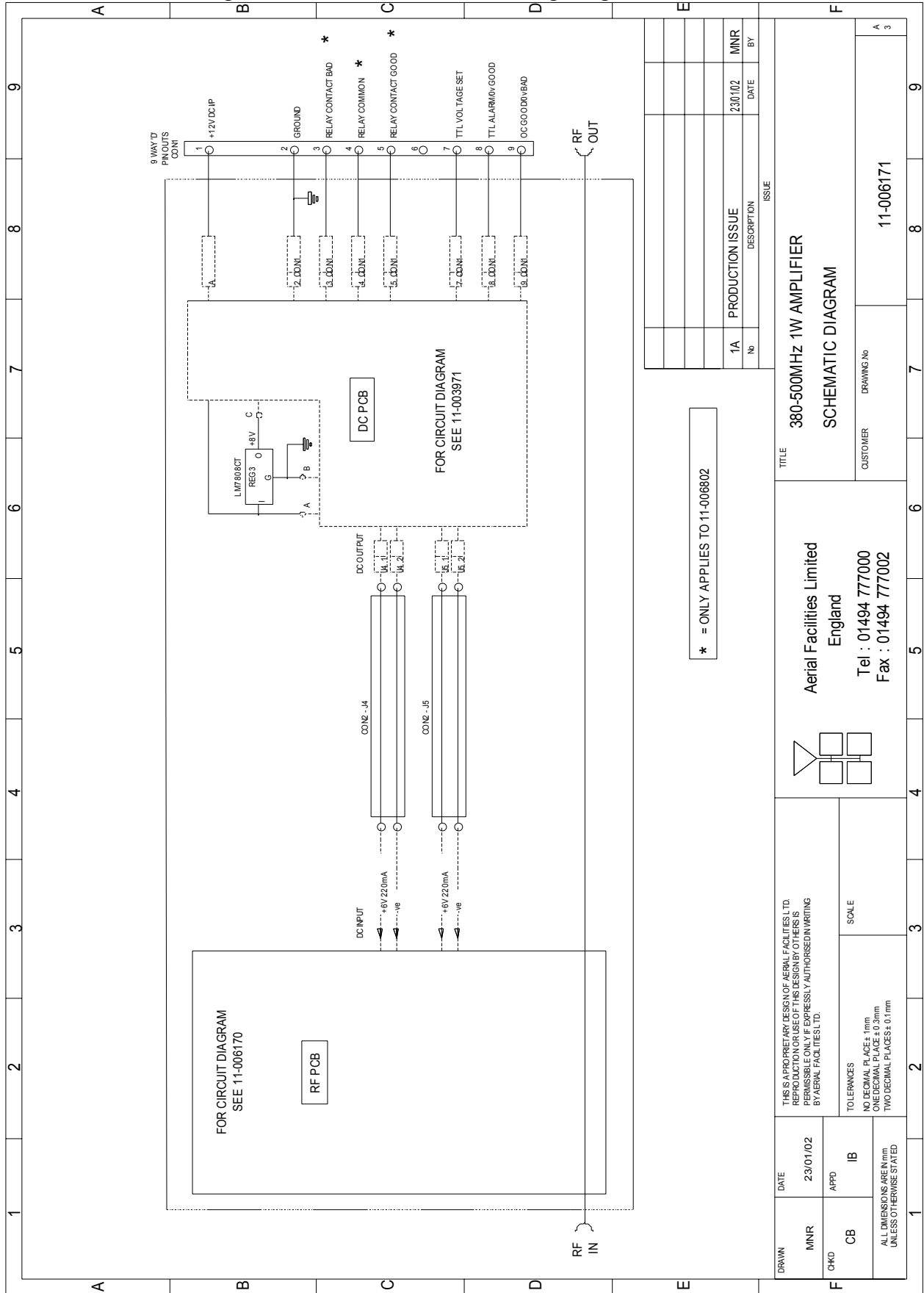

* = ONLY APPLIES TO 11-006802

No	DESCRIPTION	DATE	BY
1A	PRODUCTION ISSUE	23/01/02	MNR

TITLE 380-500MHz 1W AMPLIFIER SCHEMATIC DIAGRAM		CUSTOMER DRAWING No 11-006171	
THIS IS A PROPRIETARY DESIGN OF AERIAL FACILITIES LTD. REPRODUCTION OR USE OF THIS DESIGN OR OTHERS IS EXPRESSLY FORBIDDEN WITHOUT THE WRITING BY AERIAL FACILITIES LTD.		TOLERANCES NO DECIMAL PLACES: 1mm ONE DECIMAL PLACE: 0.1mm TWO DECIMAL PLACES: 0.1mm	
DRAWN MNR DATE 23/01/02	APPD IB	SCALE	
Aerial Facilities Limited England Tel : 01494 777000 Fax : 01494 777002		ALL DIMENSIONS ARE IN mm UNLESS OTHERWISE STATED	

5.1.4.6 Drg. Nō. 11-003971, LNA DC Schematic Diagram

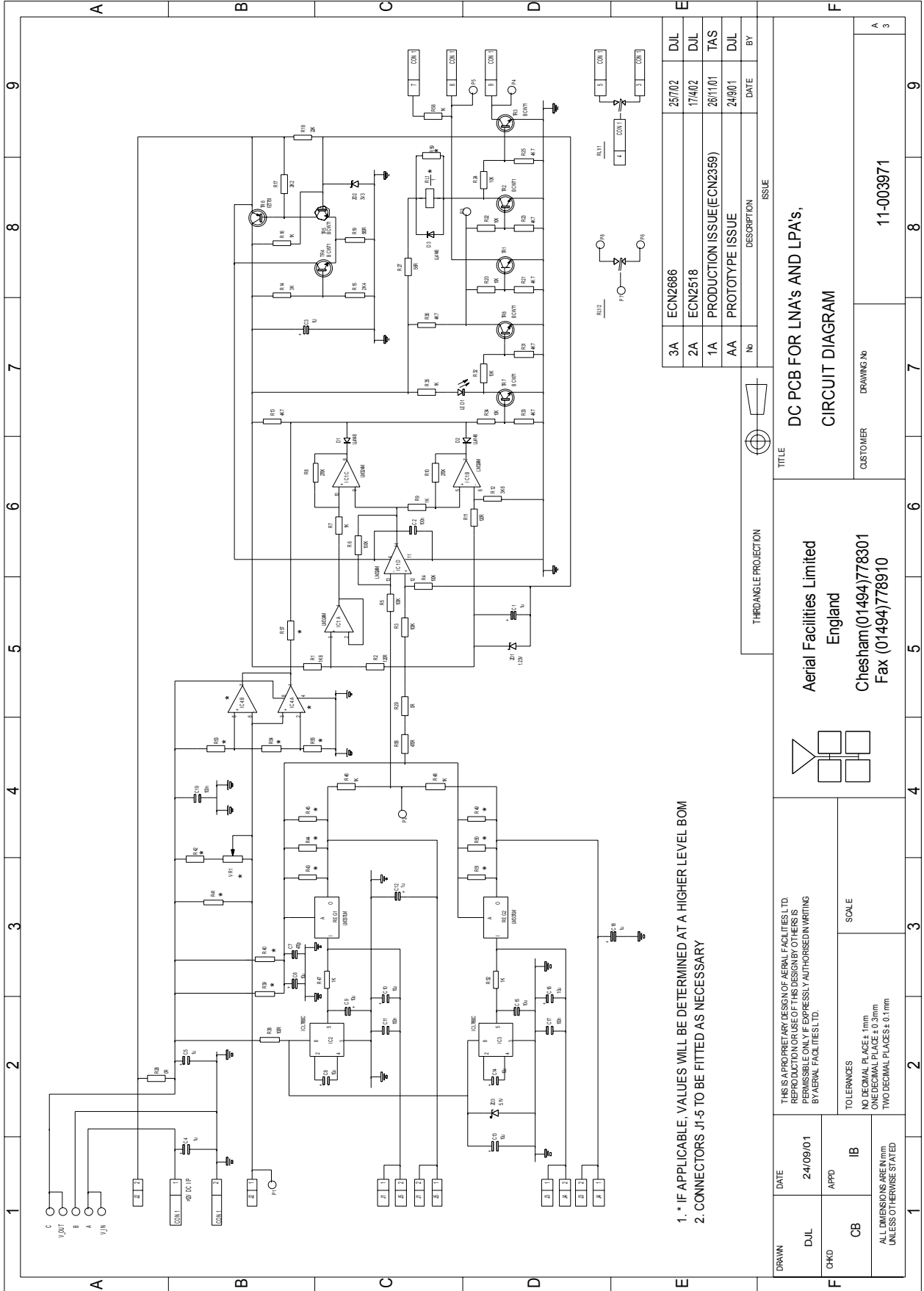

No	DESCRIPTION	DATE	BY
3A	ECN2686	25/02	DJL
2A	ECN2518	17/402	DJL
1A	PRODUCTION ISSUE(ECN2359)	26/11/01	TAS
AA	PROTOTYPE ISSUE	24/9/01	DJL

THREDAngle PROJECTION		ISSUE	
TITLE		DC PCB FOR LNAs AND LPAs,	
CUSTOMER		DRAWING No	
		11-003971	
Aerial Facilities Limited England Chesham(01494)778301 Fax (01494)778910			

1. * IF APPLICABLE, VALUES WILL BE DETERMINED AT A HIGHER LEVEL BOM
 2. CONNECTORS J1-5 TO BE FITTED AS NECESSARY

DRAWN	DATE	THIS IS A PROPRIETARY DESIGN OF AERIAL FACILITIES LTD. REPRODUCTION OR USE BY OTHERS IS PROHIBITED WITHOUT EXPRESSLY AUTHORISED IN WRITING BY AERIAL FACILITIES LTD.	
DJL	24/09/01	TOLERANCES	SCALE
CHKD	APPD	NO DECIMAL PLACES - 1mm	
CB	IB	ONE DECIMAL PLACE - 0.1mm	
ALL DIMENSIONS ARE IN mm UNLESS OTHERWISE STATED		TWO DECIMAL PLACES - 0.1mm	

5.1.4.7 Technical Specification (11-007302)

PARAMETER		SPECIFICATION
Frequency range:		380-500MHz
Bandwidth:		<140MHz
Gain:		20-22dB
1dB Compression Point:		+23.5dB (typical)
3rd order intercept:		+36dB (typical)
Input/Output return loss:		>20dB
Noise figure:		<1.3dB
Connectors:		SMA female
Supply:		200-230mA @ 24V DC
Temperature range:	operational:	-10°C to +55°C
	storage:	-30°C to +70°C
Weight:		<300gms
Size:		90 x 55 x 30.2 (case only)

5.1.4.8 Drg. N^o. 11-007302, LNA Assembly With Alarm Relay

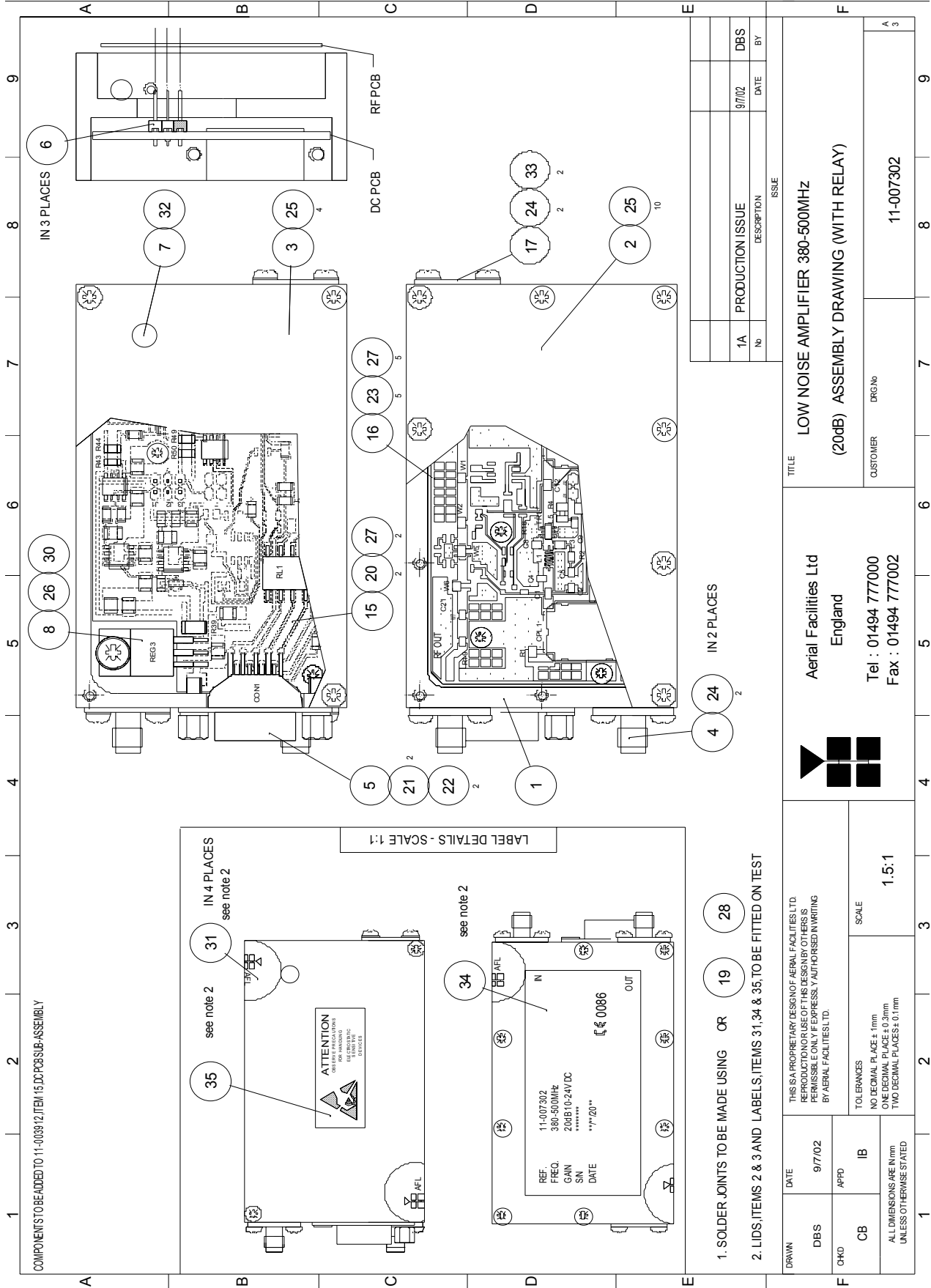

ISSUE	DESCRIPTION	DATE	BY
1A	PRODUCTION ISSUE	9/7/02	DBS

TITLE	LOW NOISE AMPLIFIER 380-500MHZ (20dB) ASSEMBLY DRAWING (WITH RELAY)
CUSTOMER	11-007302
DRG.No	

Aerial Facilities Ltd
 England
 Tel : 01494 777000
 Fax : 01494 777002

SCALE	1.5:1
TOLERANCES	NO DECIMAL PLACE ± 1mm ONE DECIMAL PLACE ± 0.3mm TWO DECIMAL PLACES ± 0.1mm UNLESS OTHERWISE STATED
DATE	9/7/02
APPD	IB
DBS	
CHKD	

5.1.4.9 Drg. Nō. 11-007370, LNA RF Circuit Diagram

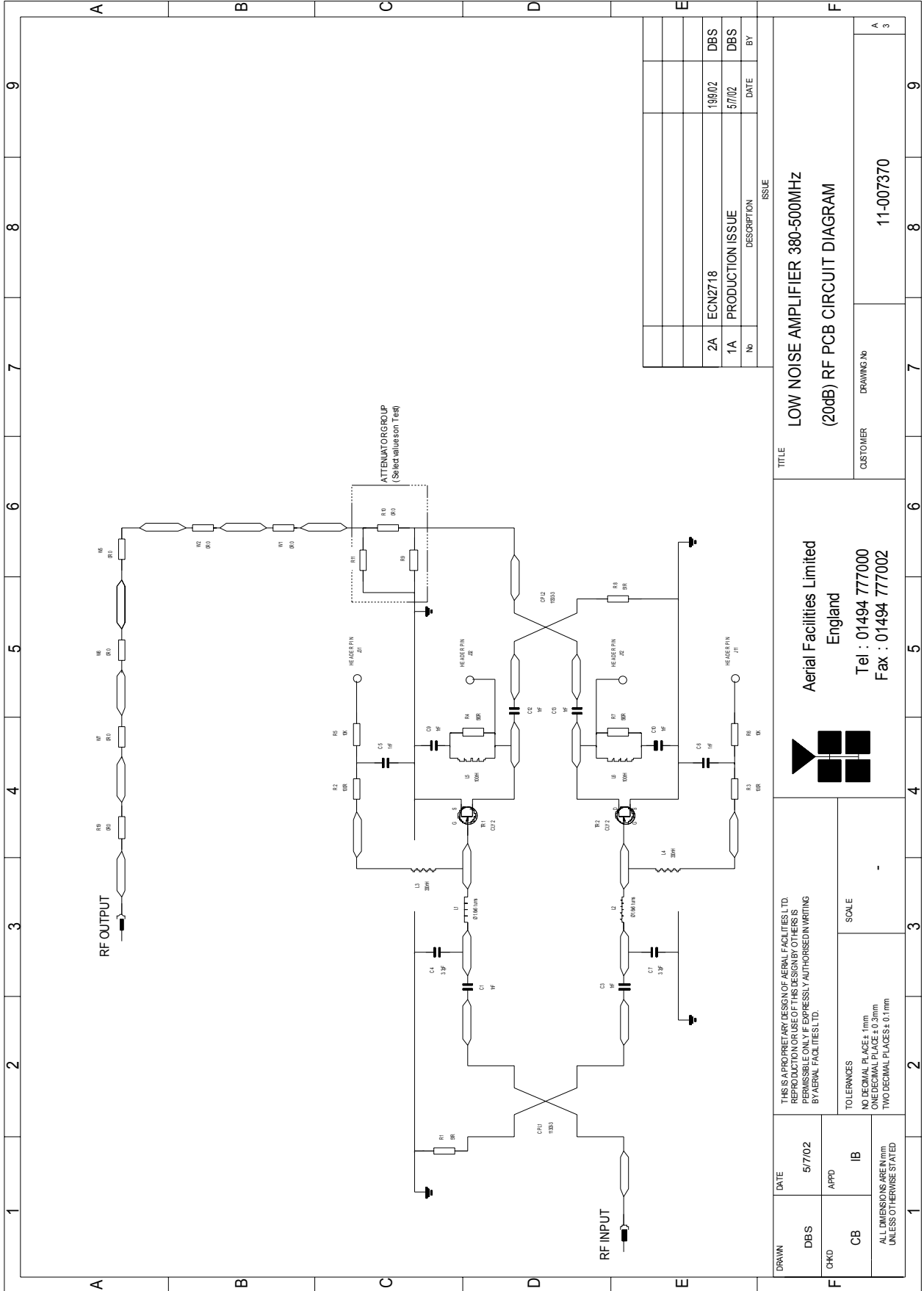

No	DESCRIPTION	DATE	BY
2A	ECN2718	19/02	DBS
1A	PRODUCTION ISSUE	5/7/02	DBS

<p>Aerial Facilities Limited England</p> <p>Tel : 01494 777000 Fax : 01494 777002</p>		<p>LOW NOISE AMPLIFIER 380-500MHZ (20dB) RF PCB CIRCUIT DIAGRAM</p>	
<p>THIS IS A PROPRIETARY DESIGN OF AERIAL FACILITIES LTD. REPRODUCTION OR USE OF THIS DESIGN BY OTHERS IS PROHIBITED WITHOUT THE EXPRESS AUTHORISED WRITING BY AERIAL FACILITIES LTD.</p>		<p>TITLE</p>	
<p>TOLERANCES NO DECIMAL PLACES - 1mm ONE DECIMAL PLACE - 0.1mm TWO DECIMAL PLACES - 0.1mm</p>		<p>CUSTOMER DRAWING NO</p>	
<p>SCALE</p>		<p>11-007370</p>	
<p>DRAWN DBS</p>	<p>DATE 5/7/02</p>	<p>ISSUE</p>	
<p>CHKD CB</p>	<p>APPD IB</p>	<p>DESCRIPTION</p>	
<p>ALL DIMENSIONS ARE IN mm UNLESS OTHERWISE STATED</p>		<p>2A ECN2718 19/02 DBS</p>	
<p>1</p>		<p>9</p>	

5.1.4.10 Drg. N^o. 11-007371, LNA DC Wiring Diagram

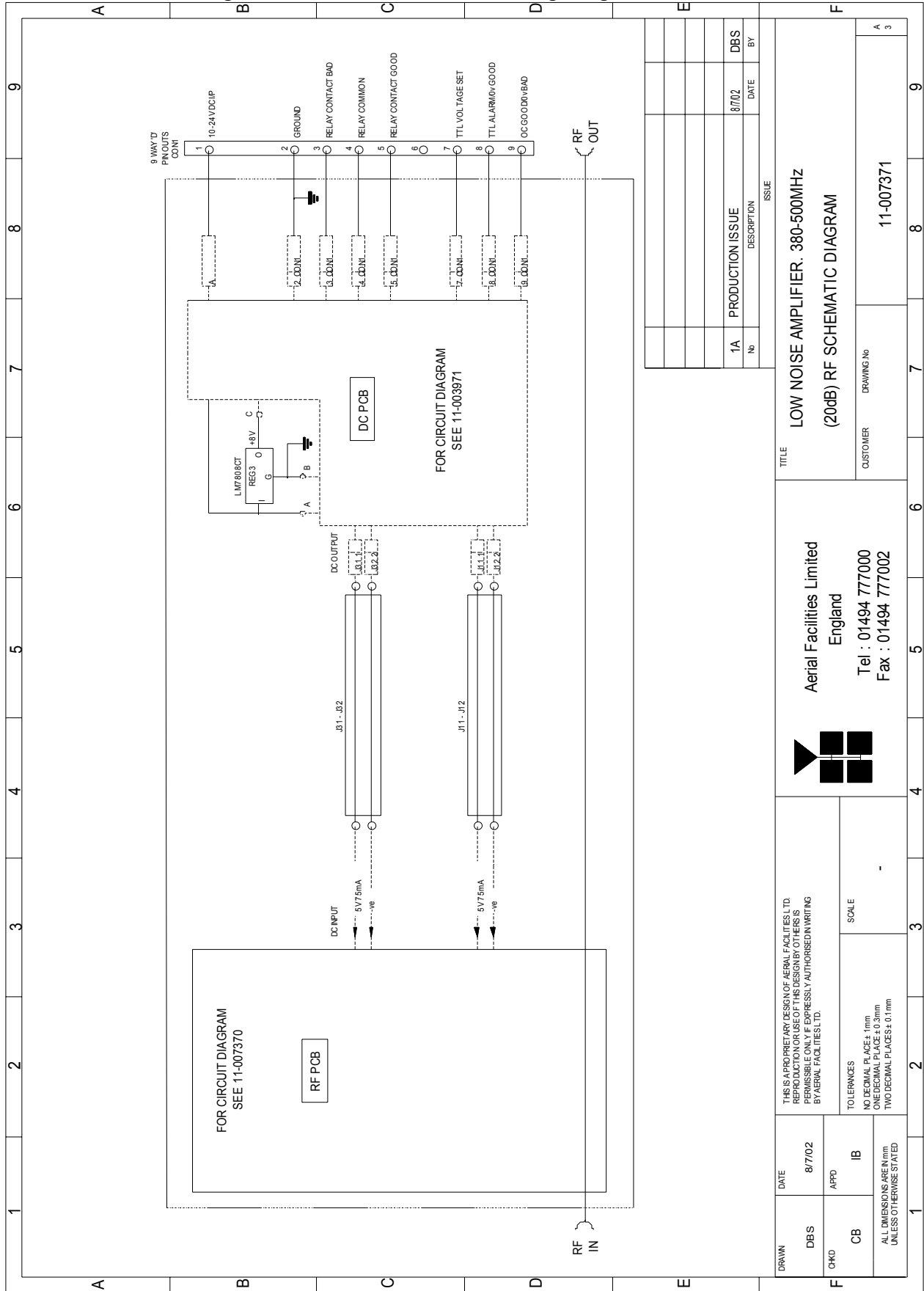

1A	PRODUCTION ISSUE	DATE	DBS	BY
No			8/702	

TITLE
**LOW NOISE AMPLIFIER: 380-500MHZ
 (20dB) RF SCHEMATIC DIAGRAM**

CUSTOMER DRAWING NO
 11-007371

Aerial Facilities Limited
 England
 Tel : 01494 777000
 Fax : 01494 777002

THIS IS A PROPRIETARY DESIGN OF AERIAL FACILITIES LTD.
 REPRODUCTION OR USE OF THIS DESIGN BY OTHERS IS
 PERMISSIBLE ONLY IF EXPRESSLY AUTHORISED IN WRITING
 BY AERIAL FACILITIES LTD.

TOLERANCES
 NO DECIMAL PLACE ± 1mm
 ONE DECIMAL PLACE ± 0.3mm
 TWO DECIMAL PLACES ± 0.1mm

DRAWN	DATE	8/7/02
DBS	APPD	IB
CB	SCALE	-

Aerial Facilities Limited
www.AerialFacilities.com
Technical Literature

5.1.4.11 Technical Specification (11-007402)

PARAMETER		SPECIFICATION
Frequency range:		380-500MHz
Bandwidth:		<140MHz
Gain:		30-32dB
1dB Compression Point:		+22dB (typical)
3rd order intercept:		+34dB (typical)
Input/Output return loss:		>19dB
Noise figure:		<1.3dB
Connectors:		SMA female
Supply:		300-330mA @ 10-24V DC
Temperature range:	operational:	-10°C to +55°C
	storage:	-30°C to +70°C
Weight:		<300gms
Size:		90 x 55 x 30.2 (case only)

5.1.4.13 Drg. Nō. 11-007470, LNA RF Circuit Diagram

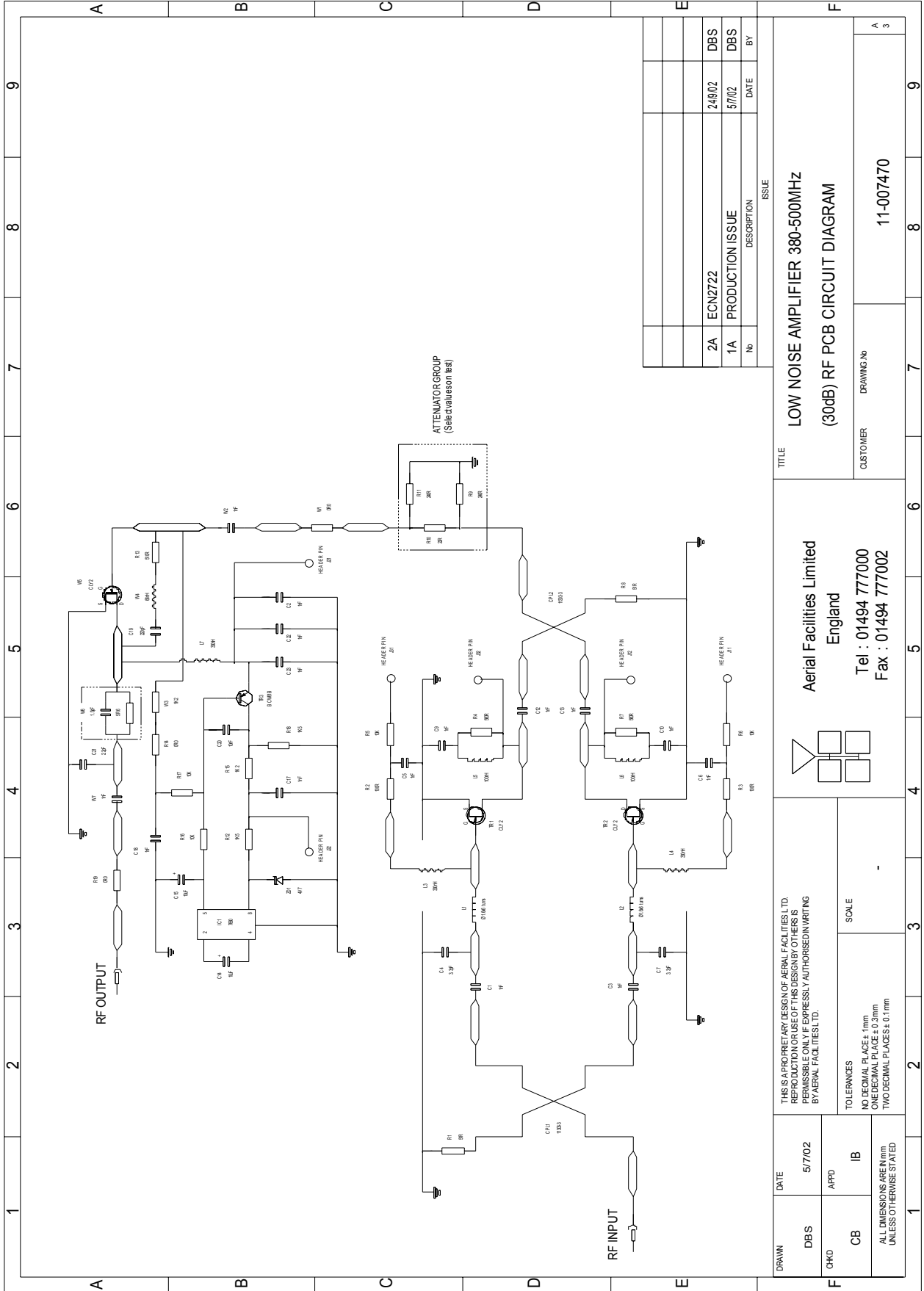

No	DESCRIPTION	DATE	BY
2A	ECN2722	24/02	DBS
1A	PRODUCTION ISSUE	5/7/02	DBS

DRAWN		DATE	TITLE	
DBS	5/7/02	LOW NOISE AMPLIFIER 380-500MHZ (30dB) RF PCB CIRCUIT DIAGRAM		
CHKD	CB	APPD	CUSTOMER	
IB		DRAWING NO		
ALL DIMENSIONS ARE IN mm UNLESS OTHERWISE STATED		11-007470		
TOLERANCES		SCALE		
NO DECIMAL PLACES - 1mm		-		
ONE DECIMAL PLACE - 0.1mm				
TWO DECIMAL PLACES - 0.1mm				
THIS IS A PROPRIETARY DESIGN OF AERIAL FACILITIES LTD. REPRODUCTION OR USE OF THIS DESIGN BY OTHERS IS PROHIBITED WITHOUT THE EXPRESS AUTHORISED WRITING BY AERIAL FACILITIES LTD.		Aerial Facilities Limited England Tel : 01494 777000 Fax : 01494 777002		

5.1.4.14 Drg. N^o. 11-007471 LNA DC Wiring Diagram

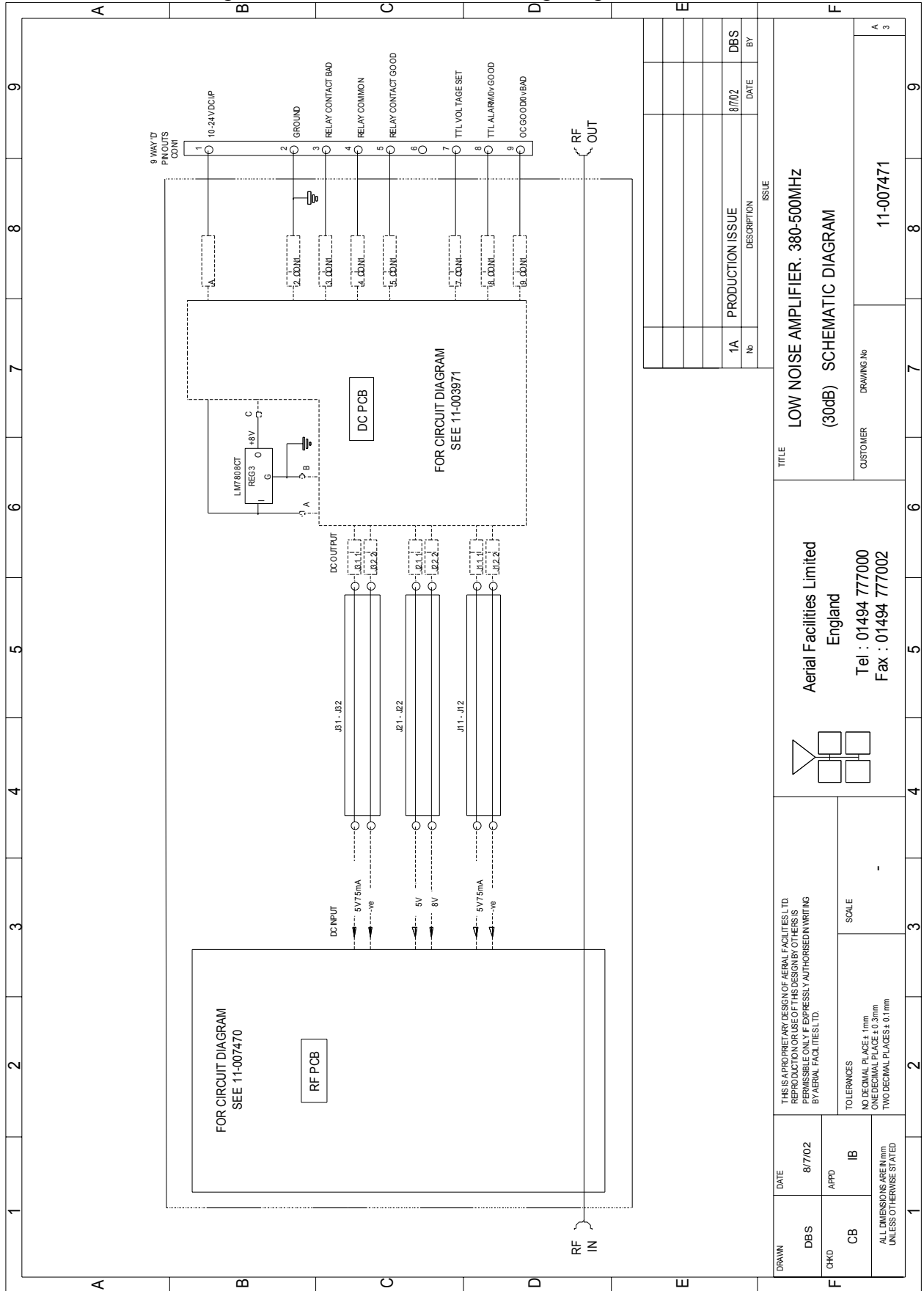

No	DESCRIPTION	DATE	BY
1A	PRODUCTION ISSUE	8/702	DBS

TITLE LOW NOISE AMPLIFIER. 380-500MHZ (30dB) SCHEMATIC DIAGRAM	
CUSTOMER DRAWING No 11-007471	
Aerial Facilities Limited England Tel : 01494 777000 Fax : 01494 777002	
THIS IS A PROPRIETARY DESIGN OF AERIAL FACILITIES LTD. REPRODUCTION OR USE OF THIS DESIGN BY OTHERS IS EXPRESSLY FORBIDDEN WITHOUT THE WRITTEN PERMISSION OF AERIAL FACILITIES LTD.	SCALE -
DATE 8/7/02	TOLERANCES NO DECIMAL PLACES - 1mm ONE DECIMAL PLACE - 0.1mm TWO DECIMAL PLACES - 0.1mm
DRAWN DBS	APPD IB
CHKD CB	ALL DIMENSIONS ARE IN mm UNLESS OTHERWISE STATED

5.1.5 5Watt Power Amplifier (12-001801)

5.1.5.1 Description

The power amplifier fitted to this unit is a multi-stage, solid state class A power amplifier. All the semi-conductor devices are very conservatively rated to ensure low device junction temperatures and a long, trouble free working lifetime.

The power amplifier should require no maintenance over its operating life. Under no circumstances should the cover be removed or the side adjustments disturbed unless it is certain that the amplifier has failed; since it is critically aligned during manufacture and any re-alignment will require extensive test equipment.

5.1.5.2 Technical Specification

PARAMETER		SPECIFICATION
Frequency Range:		400 - 500MHz (tuned to spec.)
Bandwidth:		20MHz (typical, tuneable)
Maximum Output Power:		>5W
Gain:		30dB
3rd Order Intercept Point:		<+37dBm
1dB Compression Point:		<+48dBm
VSWR:		better than 1.45:1
Connectors:		SMA female
Supply:		1.25A @ 24V DC
Temperature range:	operational:	-10°C to +55°C
	storage:	-40°C to +70°C
Size:		276 x 78 x 40mm (case only)
Weight:		1.5 kg (excluding heatsink)

5.1.5.3 Drg. N^o. 12-001801, 5Watt PA General Assembly Drawing

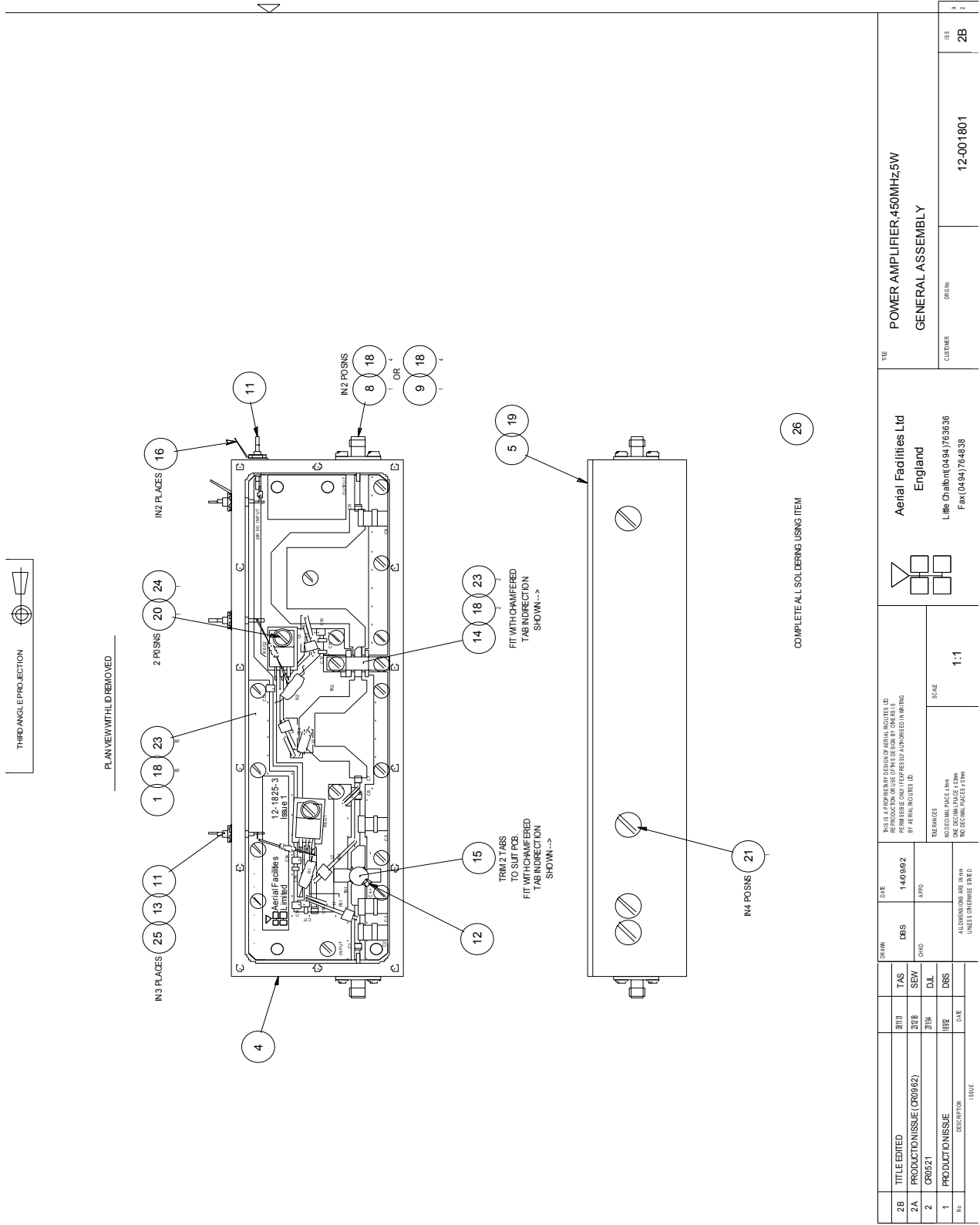

TITLE		PWR AMP LIFIER 450MHZ5W GENERAL ASSEMBLY	
CUSTOMER		12-001801	
DRAWING		ISS 2B	
Aerial Facilities Ltd England		Limbic Chalkehill (0494) 763636 Fax (0494) 764636	
THIS IS A PROPERTY OF AERIAL FACILITIES LTD. REPRODUCTION OR USE OF THIS DESIGN BY OTHERS IS STRICTLY PROHIBITED WITHOUT THE WRITTEN PERMISSION OF AERIAL FACILITIES LTD.		SCALE 1:1	
DATE	14/09/02		
DRW	DBS		
TAS	SEW		
DL	DL		
DBS	DBS		
DESCRIPTION	ISSUE		
2B	TITLE EDITED		
2A	PRODUCTION ISSUE (CR0662)		
2	CR0621		
1	PRODUCTION ISSUE		
No	DESCRIPTION		

5.1.5.4 Drg. Nō. 12-001870, 5Watt PA Circuit Diagram

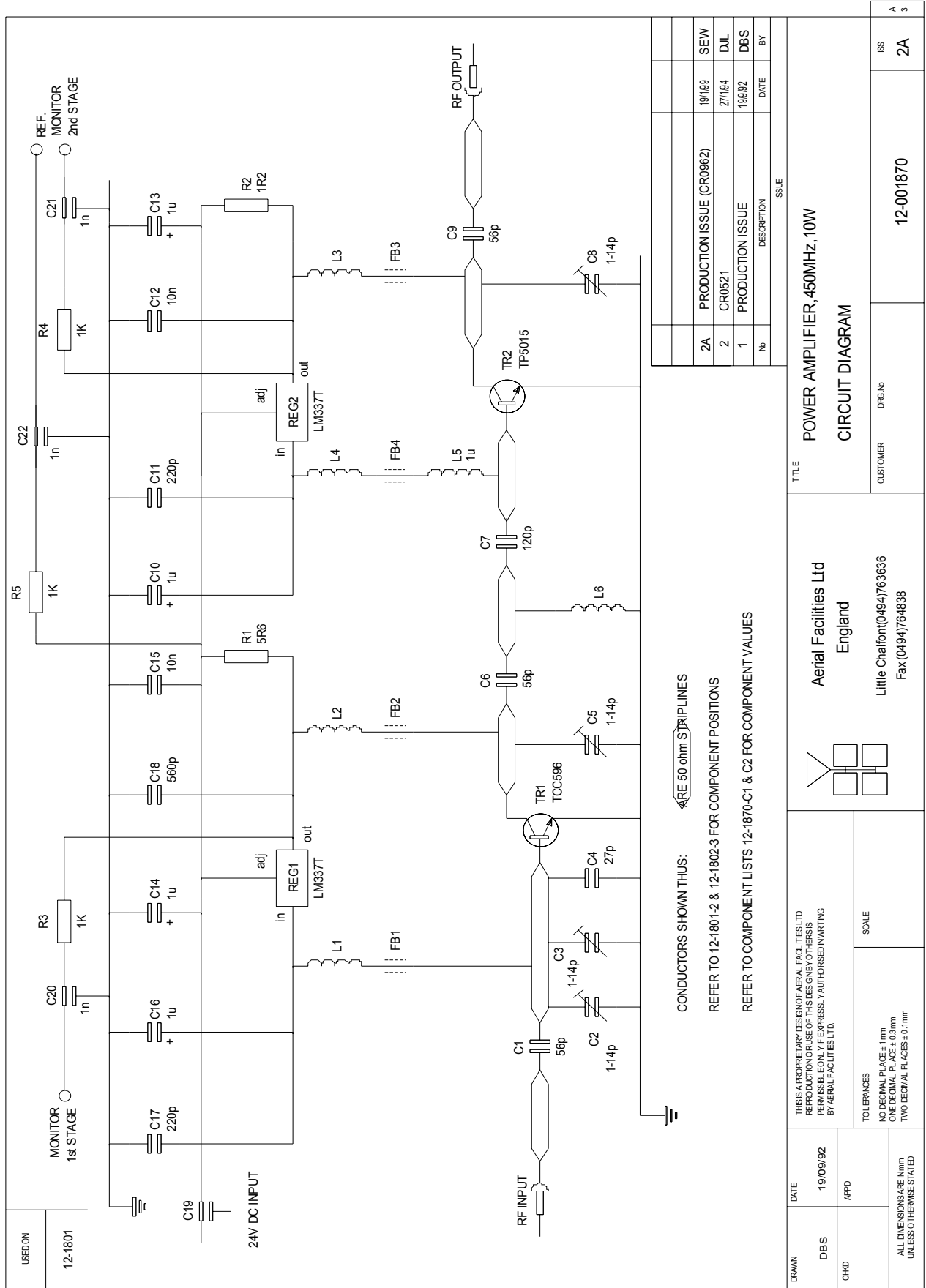

No	DESCRIPTION	DATE	BY
2A	PRODUCTION ISSUE (CR0962)	19/189	SEW
2	CR0621	27/184	DJL
1	PRODUCTION ISSUE	19/82	DBS

CONDUCTORS SHOWN THUS: ARE 50 ohm STRIPLINES
 REFER TO 12-1801-2 & 12-1802-3 FOR COMPONENT POSITIONS
 REFER TO COMPONENT LISTS 12-1870-C1 & C2 FOR COMPONENT VALUES

USED ON	12-1801
DATE	19/09/92
DRAWN	DBS
CHKD	APPD
TOLERANCES NO DECIMAL PLACES ± 1mm ONE DECIMAL PLACE ± 0.3mm TWO DECIMAL PLACES ± 0.1mm UNLESS OTHERWISE STATED	
TITLE POWER AMPLIFIER, 450MHz, 10W CIRCUIT DIAGRAM	
CUSTOMER Aerial Facilities Ltd England Little Chalfont(0494)763636 Fax (0494)764838	
ISS	2A
A	3

5.1.5.5 Drg. N^o. 12-001870C1, 5W PA Component List(1)

USED ON	CIRC. REF.	AFL STOCK REF.	DESCRIPTION
12-1801	C1	CAP0705	56pF CHIP CAP 10% TOL. (MIN)
	C2	CAP0650	P.C.B MOUNT AIR TRIMMER 1 - 14pF
	C3	CAP0650	P.C.B MOUNT AIR TRIMMER 1 - 14pF
	C4	CAP0711	27pF CHIP CAP 10% TOL (MIN)
	C5	CAP0650	P.C.B MOUNT AIR TRIMMER 1 - 14pF
	C6	CAP0705	56pF CHIP CAP 10% TOL. (MIN)
	C7	CAP0713	120pF CHIP CAP 10% TOL. (MIN)
	C8	CAP0650	P.C.B MOUNT AIR TRIMMER 1 - 14pF
	C9	CAP0705	56pF CHIP CAP 10% TOL. (MIN)
	C10	CAP0820	1uF TANTALUM CHIP CAPACITOR
	C11	CAP0714	220pF CHIP CAP 10% TOL. (MIN)
	C12	CAP0719	10 nF 63V 10% CHIP CAPACITOR
	C13	CAP0820	1uF TANTALUM CHIP CAPACITOR
	C14	CAP0820	1uF TANTALUM CHIP CAPACITOR
	C15	CAP0719	10 nF 63V 10% CHIP CAPACITOR
	C16	CAP0820	1uF TANTALUM CHIP CAPACITOR
	C17	CAP0714	220pF CHIP CAP 10% TOL. (MIN)
	C18	CAP0708	560pF CHIP CAP 10% TOL. (MIN)
	C19	CAP0500	1000pF FEED THROUGH CAPACITOR
	C20	CAP0500	1000pF FEED THROUGH CAPACITOR
	C21	CAP0500	1000pF FEED THROUGH CAPACITOR
	C22	CAP0500	1000pF FEED THROUGH CAPACITOR
	FB1	FEC0001	FERROX BEAD 3S1 5 x 2 x 4 (FX4008)
	FB2	FEC0001	FERROX BEAD 3S1 5 x 2 x 4 (FX4008)
	FB3	FEC0001	FERROX BEAD 3S1 5 x 2 x 4 (FX4008)
	FB4	FEC0001	FERROX BEAD 3S1 5 x 2 x 4 (FX4008)
	L1	WIR0101	1.25 ENAMELLED COPPER WIRE
	L2	WIR0101	1.25 ENAMELLED COPPER WIRE
	L3	WIR0101	1.25 ENAMELLED COPPER WIRE
	L4	WIR0101	1.25 ENAMELLED COPPER WIRE
	L5	CHK0013	1.0uH CHOKE SIGMA SC10 SERIES
	L6	WIR0006	18 S.W.G. TINNED COPPER WIRE

ISSUE	DATE	CHANGE No.	ISSUE	DATE	CHANGE No.	ISSUE	DATE	CHANGE No.	ISSUE	DATE	CHANGE No.
2	27 / 1 / 94	CRO 521									
1	14 / 9 / 92	Prod. Issue									



Aerial Facilities Limited

TITLE

POWER AMPLIFIER, 450MHz 10W
CIRCUIT COMPONENT LIST

DRAWN
DBS

DATE
14 / 9 / 92

CHKD

APPD.

CUSTOMER

DRG. N^o.

12 - 001870C1

<p>Aerial Facilities Limited www.AerialFacilities.com Technical Literature</p>	<p>PBL UHF1/1A 1 & 2 Air Interface Maintenance Handbook</p>		
	H/book Number:-60-055900HBKM	Issue No:-2	Date:-20/10/2003

5.1.5.6 Drg. Nō. 12-001870C2, 5W PA Component List(2)

USED ON	CIRC. REF.	AFL STOCK REF.	DESCRIPTION	
12 - 1801	R1	RES 0515	5R6 WELWYN W21 V:E W:W 2.5W	
	R2	RES 0510	1R2 WELWYN W21 V:E W:W 2.5W	
	R3	RES 0071	1K M:F 0.25W MRS25 RESISTOR	
	R4	RES 0071	1K M:F 0.25W MRS25 RESISTOR	
	R5	RES 0071	1K M:F 0.25W MRS25 RESISTOR	
	REG1	VLR0002	LM337T. VOLTAGE REGULATOR	
	REG2	VLR0002	LM337T. VOLTAGE REGULATOR	
	TR1	TRN0208	TPV596A/SD1439 / TCC596 PWR. TRANSISTOR	
	TR2	TRN0204	TP 5015 R.F. POWER TRANSISTOR	

2	27 / 1 / 94	CR 0521										
1	14 / 9 / 92	Prod. Issue										
ISSUE	DATE	Change No.	ISSUE	DATE	Change No.	ISSUE	DATE	Change No.	ISSUE	DATE	Change No.	
 Aerial Facilities Limited						TITLE POWER AMPLIFIER 450MHz, 10 Watt CIRCUIT COMPONENT LIST						
DRAWN DBS	DATE 14 / 9 / 92	CHKD.	APPD.	CUSTOMER	Drg. No.	12 - 001870C2					Iss. 2A	

5.1.5.7 Drg. No. 80-008450, Power Amplifier/Alarm Board DC Wiring Details

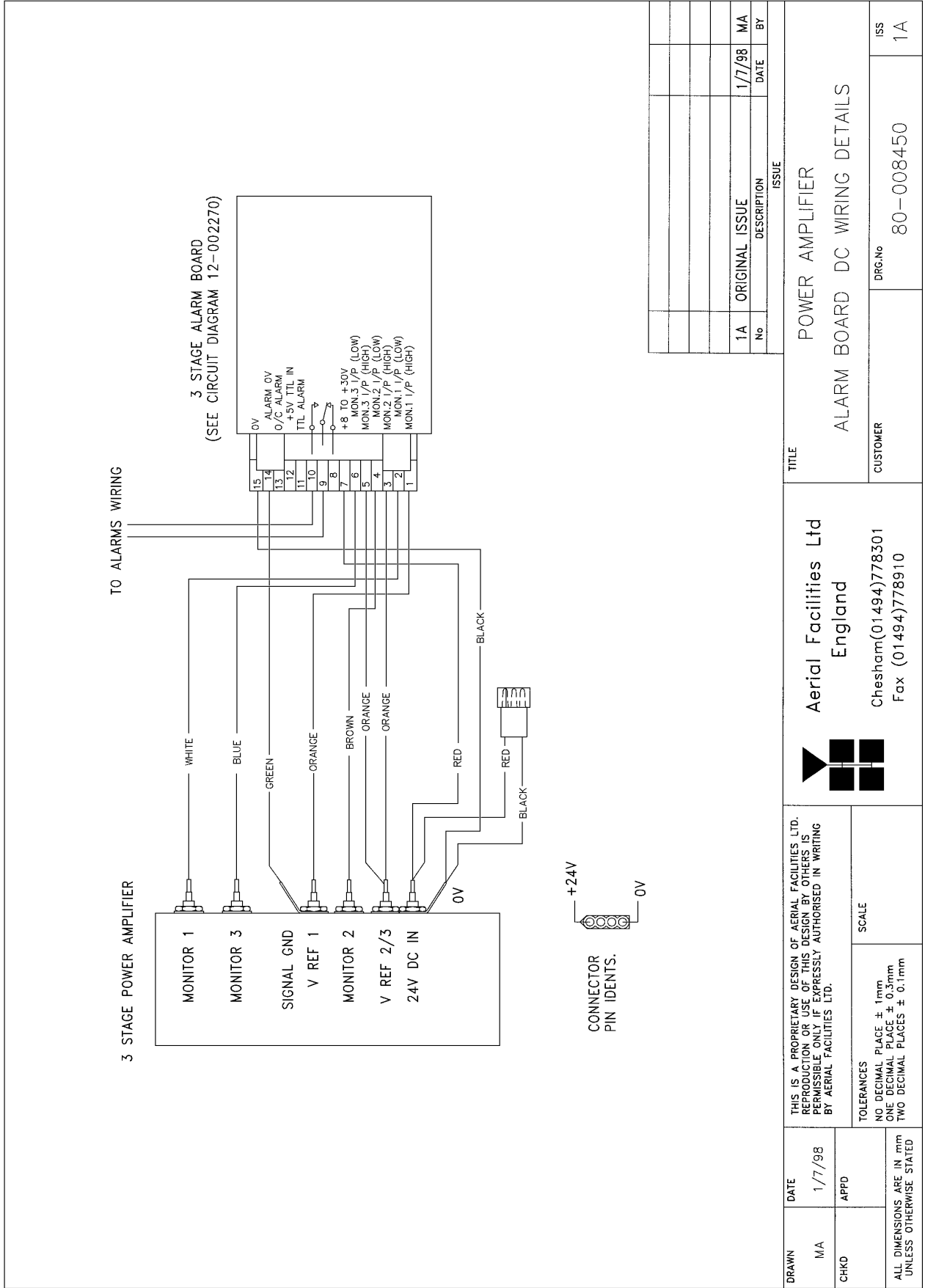

5.1.6 3 Stage Amplifier Alarm Boards (12-002201)

5.1.6.1 Description

Amplifier Alarm Boards are fitted to monitor the bias conditions of AFL Class A amplifiers which remain constant in normal operation. Any departure from normal bias conditions is a result of device failure, excess temperature, over-driving or oscillation (excessive power).

In normal operation, the Class A bias circuit of the amplifier develops a constant voltage of 1.20V across the collector current setting resistor. The Amplifier Alarm Board is a window comparator device, which is adjusted to sense a departure from this condition. Several different alarm outputs are provided to simplify interfacing, (Relay Contact, Open Collector, and TTL Logic Levels)

The basic version of the Alarm Board (12-002801) monitors a single amplifier stage. A three-stage version (12-002201) is used on complex amplifiers where three separate comparators have their outputs logically combined to a common output stage. Failure of any one stage will activate the alarms.

Note that the alarm board has a green Light Emitting Diode located near to the centre of the printed circuit board, which is illuminated on 'Good', and extinguished on 'Alarm'. It is therefore a simple matter to identify an active module failure, by searching for an Alarm Board which has its green LED extinguished. A simple test of the alarm board is possible by shorting across the monitor inputs, pins 1 and 2, 3 and 4 or across pins 5 and 6. This last monitor input is inactive if the board has been converted to a two way alarm board. (Refer to relevant amplifier alarm wiring diagram.)

- 1) Volt-free change over relay contacts.
- 2) Open collector NPN transistor pulls low on alarm.
- 3) TTL driver.

The use of precision voltage sources and resistors has eliminated the need for initial adjustment or calibration, and the board will function correctly with a wide variation in power supply voltage (8 to 30 volts, nominal supply is 12 or 24Volts).

There are two selectable link options on the three-way board:

- LINK1 - Removed to convert to two-way alarm board.
- LINK2 - Removed to isolate 0V from chassis earth.

The one way alarm board only has the 0V isolation link (LINK2) fitted.

 Aerial Facilities Limited www.AerialFacilities.com Technical Literature	PBL UHF1/1A 1 & 2 Air Interface Maintenance Handbook		
	H/book Number:- 60-055900HBKM	Issue No:-2	Date:- 20/10/2003

5.1.6.2 Technical Specification

PARAMETER		SPECIFICATION
Operating voltage:		8 to 30V (floating earth)
Alarm Threshold:		Vcc - 1.20 volt \pm 15%
Alarm output relay contacts:		
Max. switch current:		1.0Amp
Max. switch volts:		120Vdc/60VA
Max. switch power:		24W/60VA
Min. switch load:		10.0 μ A/10.0mV
Relay isolation:		1.5kV
Mechanical life:		>2x10 ⁷ operations
Relay approval:		BT type 56
Connector details:		15-way 0.1" pitch
Temperature range:	operational:	:-10°C to +55°C
	storage:	:-40°C to +70°C
PCB Size:		74 x 56mm (3 stage)
		54 x 56mm (1 stage)

5.1.6.4 Drg. N^o. 12-002270, 3 Stage Alarm Board Circuit Diagram

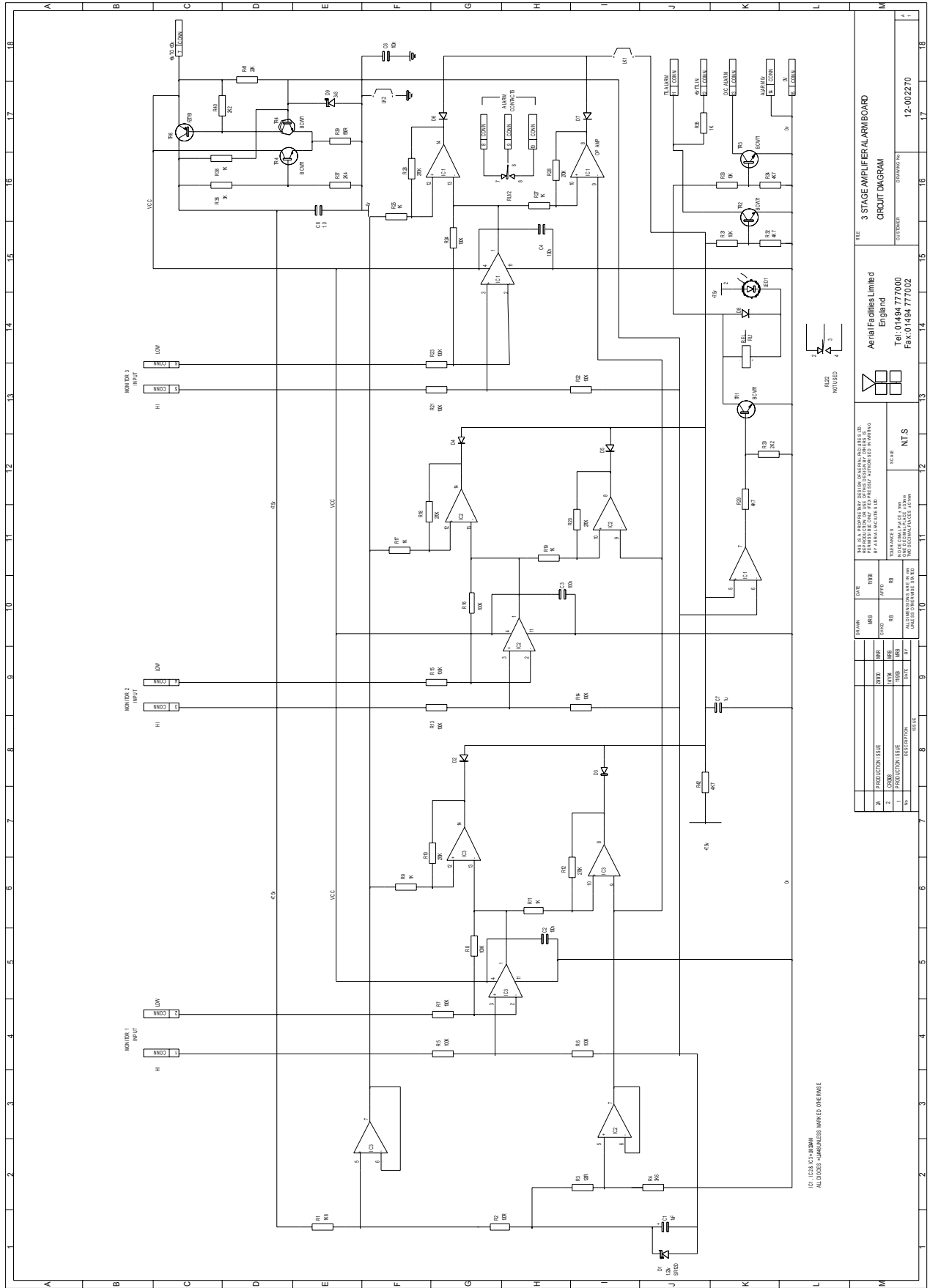

IC1, IC2, IC3 SHOWN
ALL OTHERS SUPPLIERS MARKED OTHERWISE

Aerial Facilities Limited England Tel: 01454 777000 Fax: 01454 777002		3 STAGE AMPLIFIER ALARM BOARD CIRCUIT DIAGRAM
REF: 12-002270 REV: 1 DATE: 12/00	DRAWING NO: 12-002270	
THIS IS A PROOF COPY OF THE ORIGINAL DRAWING. IT IS NOT TO BE USED FOR FABRICATION OR REVISIONS. ANY CHANGES MUST BE APPROVED BY THE ORIGINAL DESIGNER.		
DRAWN: [Blank] CHECKED: [Blank] APPROVED: [Blank]	DESIGNED: [Blank] CHECKED: [Blank] APPROVED: [Blank]	
ALL DIMENSIONS ARE IN MILLIMETERS UNLESS OTHERWISE SPECIFIED. UNLESS OTHERWISE SPECIFIED, ALL DIMENSIONS ARE TO THE CENTER OF HOLES.		
SCALE: N.T.S.		

5.1.6.5 Generic Wall Enclosure Alarm Wiring Sketch

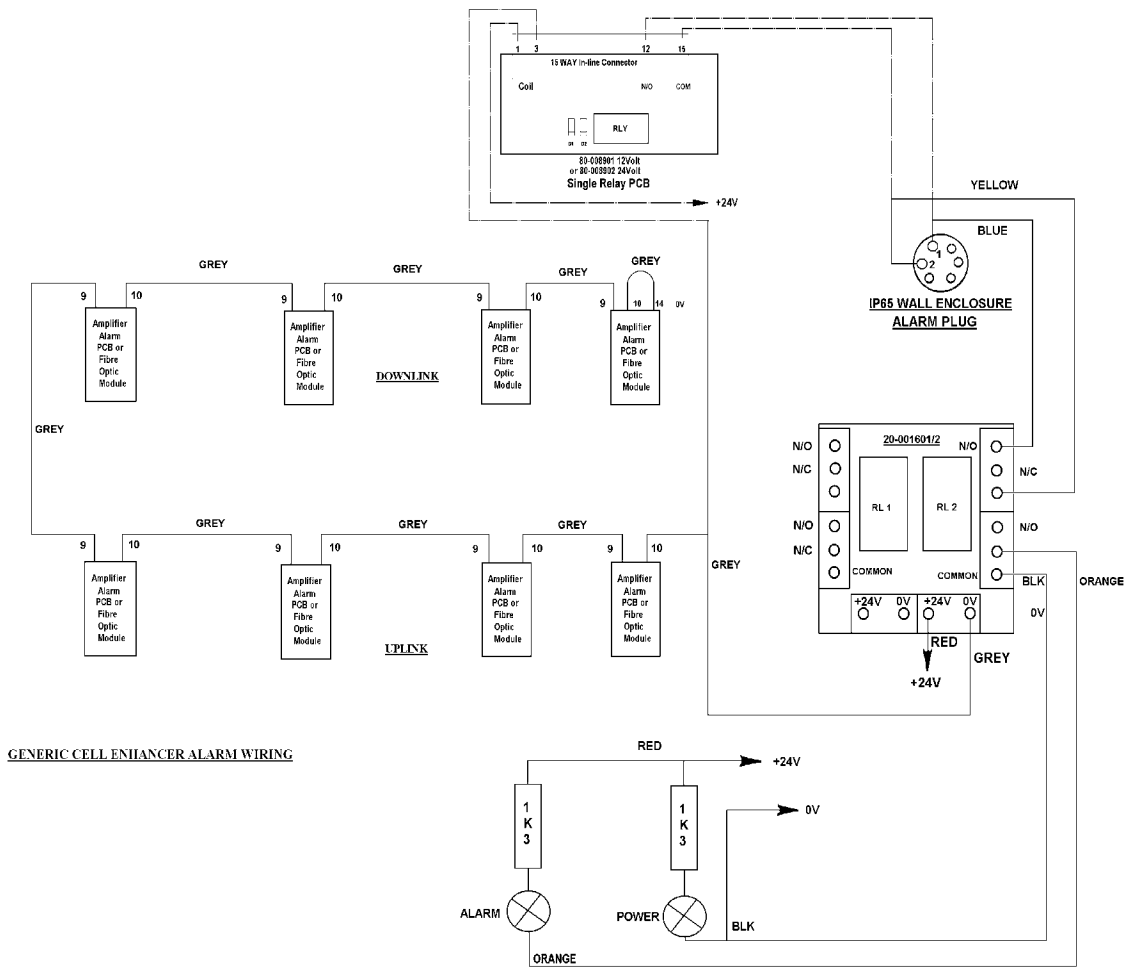

5.1.7 DC/DC Converter, 24V in, 12V 8A out (13-003011)

5.1.7.1 Description

The DC/DC converter fitted is an AFL assembled, high power PCB unit with an 8 amp @ 12V output capability. The circuit is basically an O.E.M semiconductor regulator (one side of which has a heatsink mounting plate, that is usually bolted to the casing of a Cell Enhancer) and smoothing components built onto a printed circuit board with screw block terminations.

Note: no circuit diagram of the O.E.M. regulator is available. This unit should not be repaired, only replaced.

5.1.7.2 Technical Specification

PARAMETER		SPECIFICATION
Input Voltage Range:		18-28V DC
Output Voltage:		12V±0.5V
Max. Current Load:		8.0Amps
Temperature Range:	Operation:	-10°C to +55°C
	Storage:	-40°C to +70°C
Size(PCB):		190 x 63mm
Weight (Loaded PCB):		291gms

5.1.8 Channel Selective & Channel Control Modules (17-003012 & 17-002101)

5.1.8.1 Channel Selective Module Description

The channel selectivity module is employed when the Cell Enhancer requirement dictates that very narrow bandwidths (single operating channels), must be selected from within the operating passband. One channel selectivity module is required for each channel.

The Channel Selectivity Module is an Up/Down frequency converter that mixes the incoming channel frequency with a synthesised local oscillator, so that it is down-converted to an Intermediate Frequency (IF) in the upper HF range. An eight pole crystal filter in the IF amplifier provides the required selectivity to define the operating passband of the Cell Enhancer to a single PMR channel. The same local oscillator then converts the selected IF signal back to the channel frequency.

Selectivity is obtained from a fixed bandwidth block filter operating at an intermediate frequency (IF) in the low VHF range. This filter may be internal to the channel selectivity module (Crystal or SAW filter) or an externally mounted bandpass filter, (LC or Helical Resonator). Various IF bandwidths can therefore be accommodated. A synthesized Local Oscillator is employed in conjunction with high performance frequency mixers, to translate between the signal frequency and IF.

The operating frequency of each channel selectivity module is set by the programming of channel selectivity module frequencies and is achieved digitally, via hard wired links, banks of DIP switches, or via an onboard RS232 control module, providing the ability to remotely set channel frequencies.

Automatic Level Control (ALC) is provided within each channel selectivity module such that the output level is held constant for high level input signals. This feature prevents saturation of the output mixer and of the associated amplifiers.

Alarms within the module inhibit the channel if the synthesised frequency is not locked. The synthesiser will not usually go out of lock unless a frequency far out of band is programmed.

The channel selectivity module is extremely complex and, with the exception of channel frequency programming within the design bandwidth, it cannot be adjusted or repaired without extensive laboratory facilities and the necessary specialised personnel. If a fault is suspected with any channel selectivity module it should be tested by substitution and the complete, suspect module should then be returned to AFL for investigation.

 Aerial Facilities Limited www.AerialFacilities.com Technical Literature	PBL UHF1/1A 1 & 2 Air Interface Maintenance Handbook		
	H/book Number:- 60-055900HBKM	Issue No:-2	Date:- 20/10/2003

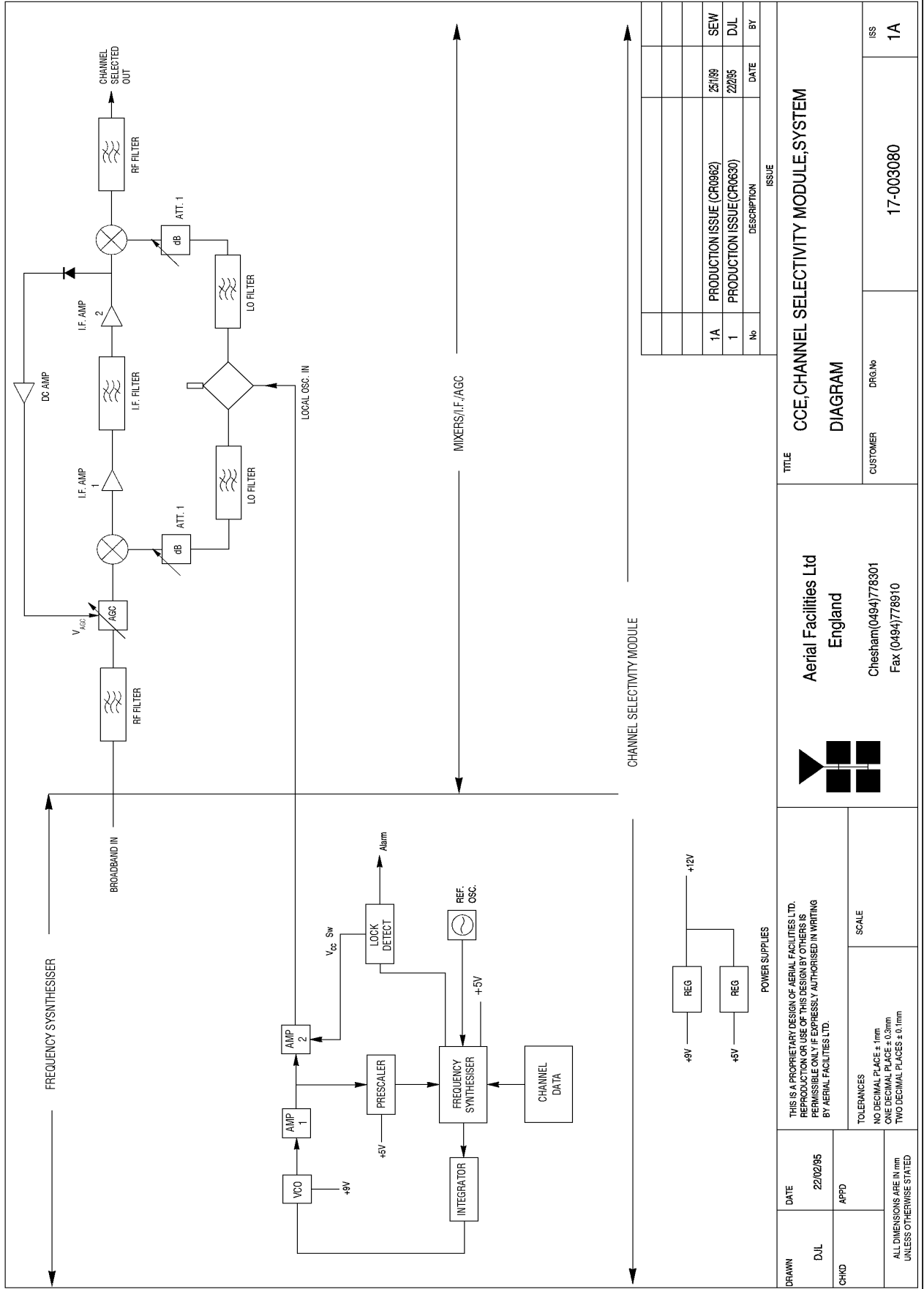

No	DESCRIPTION	DATE	BY
1	PRODUCTION ISSUE (CR0650)	22/05	DJL
1A	PRODUCTION ISSUE (CR0962)	25/09	SEW

DRAWN		DATE	TITLE	
D.J.L		22/02/95	CCE, CHANNEL SELECTIVITY MODULE, SYSTEM	
CHKD		APPD	DIAGRAM	
ALL DIMENSIONS ARE IN mm UNLESS OTHERWISE STATED		Aerial Facilities Ltd England		CUSTOMER
TOLERANCES NO DECIMAL PLACE \pm 1mm ONE DECIMAL PLACE \pm 0.3mm TWO DECIMAL PLACES \pm 0.1mm		Chesterham (0494) 778301 Fax (0494) 778910		DRG. NO
SCALE		17-003080		ISS
				1A

 **Aerial Facilities Limited**
www.AerialFacilities.com
Technical Literature

**PBL UHF1/1A 1 & 2 Air Interface
Maintenance Handbook**

H/book Number:-60-055900HBKM	Issue No:-2	Date:-20/10/2003	Page:-58 of 85
------------------------------	-------------	------------------	----------------

5.1.8.3 Channel Selectivity Control Module Description

The control module consists of a bank of four, in-line data switches each of which control one channel module frequency setting. One controller can therefore control four channel modules. The following list shows the frequencies available for each switch setting.

5.1.8.4 Channel Controller DIP Switch Configuration Frequencies

IDC PIN	25-way Connector	Function
1	13	Freq. bit 1 (12.5kHz)
2	25	Freq. bit 2 (25kHz)
3	12	Freq. bit 3 (50kHz)
4	24	Freq. bit 4 (100kHz)
5	11	Freq. bit 5 (200kHz)
6	23	Freq. bit 6 (400kHz)
7	10	Freq. bit 7 (800kHz)
8	22	Freq. bit 8 (1.6MHz)
9	9	Freq. bit 9 (3.2MHz)
10	21	Freq. bit 10 (6.4MHz)
11	8	Freq. bit 11 (12.8MHz)
12	20	Freq. bit 12 (25.6MHz)
13	7	Freq. bit 13 (51.2MHz)
14	19	Freq. bit 14 (102.4MHz)
15	6	Freq. bit 15 (204.8MHz)
16	18	Freq. bit 16 (409.6MHz)
17	5	Module alarm
18	17	Gain bit 1
19	4	Gain bit 2
20	16	Gain bit 3
21	3	Gain bit 4
22	15	+5V
23	2	0V
24	14	Switched 12V
25	1	0V
26	---	---

5.1.8.5 UHF1 Downlink Channel Module Configuration Table

Setting	D/L(1)	D/L(2)	D/L(3)
Frequency	482.2375MHz	470.2625MHz	470.2125MHz
Gain	15dB	20dB	20dB
ALC	-23dB	-23dB	-23dB
DIP (off) Nō. 's	1,2,13,16	1,3,7,11,12,16	1,7,11,12,16
B/W	15KHz	15KHz	15KHz

5.1.8.6 UHF1 Uplink Channel Module Configuration Table

Setting	U/L(1)	U/L(2)	U/L(3)
Frequency	473.2625MHz	470.2125MHz	485.2375MHz
Gain	5dB	5dB	15dB
ALC	-22dBm	-22dBm	-12dBm
DIP (off) Nō. 's	1,3,5,6,9,11,12,16	1,5,6,9,11,12,16	1,2,5,6,7,8,13,16
B/W	30KHz	30KHz	30KHz

5.1.8.7 UHF1A Downlink Channel Module Configuration Table

Setting	D/L(1)	D/L(2)	D/L(3)
Frequency	470.0875MHz	470.1375MHz	470.3625MHz
Gain	20dB	20dB	20dB
ALC	-23dB	-23dB	-23dB
DIP (off) Nō. 's	1,2,3,5,6,11,12,16	1,2,4,5,6,11,12,16	1,3,4,7,11,12,16
B/W	15KHz	15KHz	15KHz

5.1.8.8 UHF1A Uplink Channel Module Configuration Table

Setting	D/L(1)	D/L(2)	D/L(3)
Frequency	473.0875MHz	473.1375MHz	473.3625MHz
Gain	15dB	15dB	15dB
ALC	-32dB	-32dB	-32dB
DIP (off) Nō. 's	1,2,3,6,9,11,12,16	1,2,4,6,9,11,12,16	1,3,4,5,6,9,11,12,16
B/W	15KHz	15KHz	15KHz

5.1.8.9 UHF2 Downlink Channel Module Configuration Table

Setting	D/L(1)	D/L(2)	D/L(3)	D/L(4)
Frequency	483.3125MHz	483.2875MHz	483.0625MHz	483.5265MHz
Gain	20dB	20dB	20dB	20dB
ALC	-35dBm	-35dBm	-35dBm	-35dBm
DIP (off) Nō. 's	1,4,5,7,13,16	1,2,3,5,7,13,16	1,3,7,13,16	1,3,4,6,7,13,16
B/W	15KHz	15KHz	15KHz	15KHz

5.1.8.10 UHF2 Uplink Channel Module Configuration Table

Setting	D/L(1)	D/L(2)	D/L(3)	D/L(4)
Frequency	486.3125MHz	486.2875MHz	486.0625MHz	486.5265MHz
Gain	6dB	6dB	6dB	6dB
ALC	-20dBm	-20dBm	-20dBm	-20dBm
DIP (off) Nō. 's	1,4,7,9,13,16	1,2,3,7,9,13,16	1,3,5,6,9,13,16	1,3,4,5,7,9,13,16
B/W	15KHz	15KHz	15KHz	15KHz

5.1.9 Single & Dual 24Volt Relay Boards (20-001602 & 80-008902)

5.1.9.1 24V Relay Boards (20-001602 & 80-008902) Description

The General Purpose Dual Relay Board (20-001602) allows the inversion of signals and the isolation of circuits. It is equipped with two dual pole change-over relays RL1 and RL2, with completely isolated wiring, accessed via screw terminals.

Both relays are provided with polarity protection diodes and diodes for suppressing the transients caused by "flywheel effect" which can destroy switching transistors or induce spikes on neighbouring circuits. It's common use is to amalgamate all the alarm signals into one, volts-free relay contact pair for the main alarm system.

Note that the board is available for different voltages (12 or 24V) depending on the type of relays fitted at RL1 and RL2.

The single relay board (80-008902) is electrically identical to the dual version but is proportionately smaller in size. It also has a single in-line IDC connector in place of the screw terminal blocks of the dual model and performs similar summary alarm functions.

 Aerial Facilities Limited www.AerialFacilities.com Technical Literature	PBL UHF1/1A 1 & 2 Air Interface Maintenance Handbook		
	H/book Number:- 60-055900HBKM	Issue No:-2	Date:- 20/10/2003

5.1.9.2 Drg. Nō. 20-001602, Dual 24V Relay Board Assembly Drawing

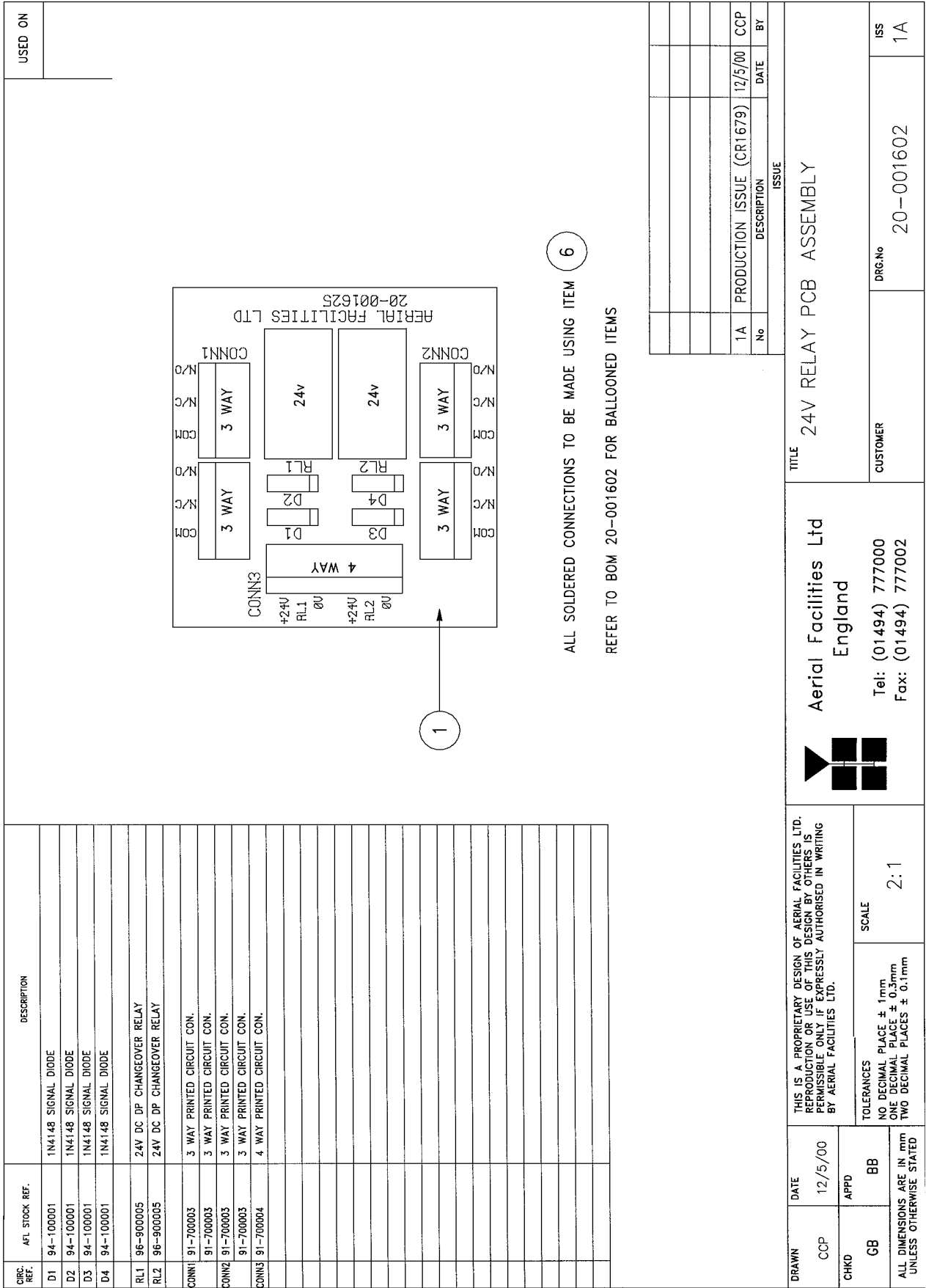

ALL SOLDERED CONNECTIONS TO BE MADE USING ITEM 6

REFER TO BOM 20-001602 FOR BALLOONED ITEMS

No	DESCRIPTION	DATE	BY
1A	PRODUCTION ISSUE (CR1679)	12/5/00	CCP

		Aerial Facilities Ltd England Tel: (01494) 777000 Fax: (01494) 777002		TITLE 24V RELAY PCB ASSEMBLY DRG.No 20-001602 ISS 1A	
DRAWN CCP DATE 12/5/00 APPD BB	THIS IS A PROPRIETARY DESIGN OF AERIAL FACILITIES LTD. REPRODUCTION OR USE OF THIS DESIGN BY OTHERS IS PERMISSIBLE ONLY IF EXPRESSLY AUTHORISED IN WRITING BY AERIAL FACILITIES LTD.	TOLERANCES NO DECIMAL PLACE ± 1mm ONE DECIMAL PLACE ± 0.3mm TWO DECIMAL PLACES ± 0.1mm	SCALE 2:1	ALL DIMENSIONS ARE IN mm UNLESS OTHERWISE STATED	

5.1.9.3 Drg. Nō. 20-001671, Dual 24V Relay Board Circuit Diagram

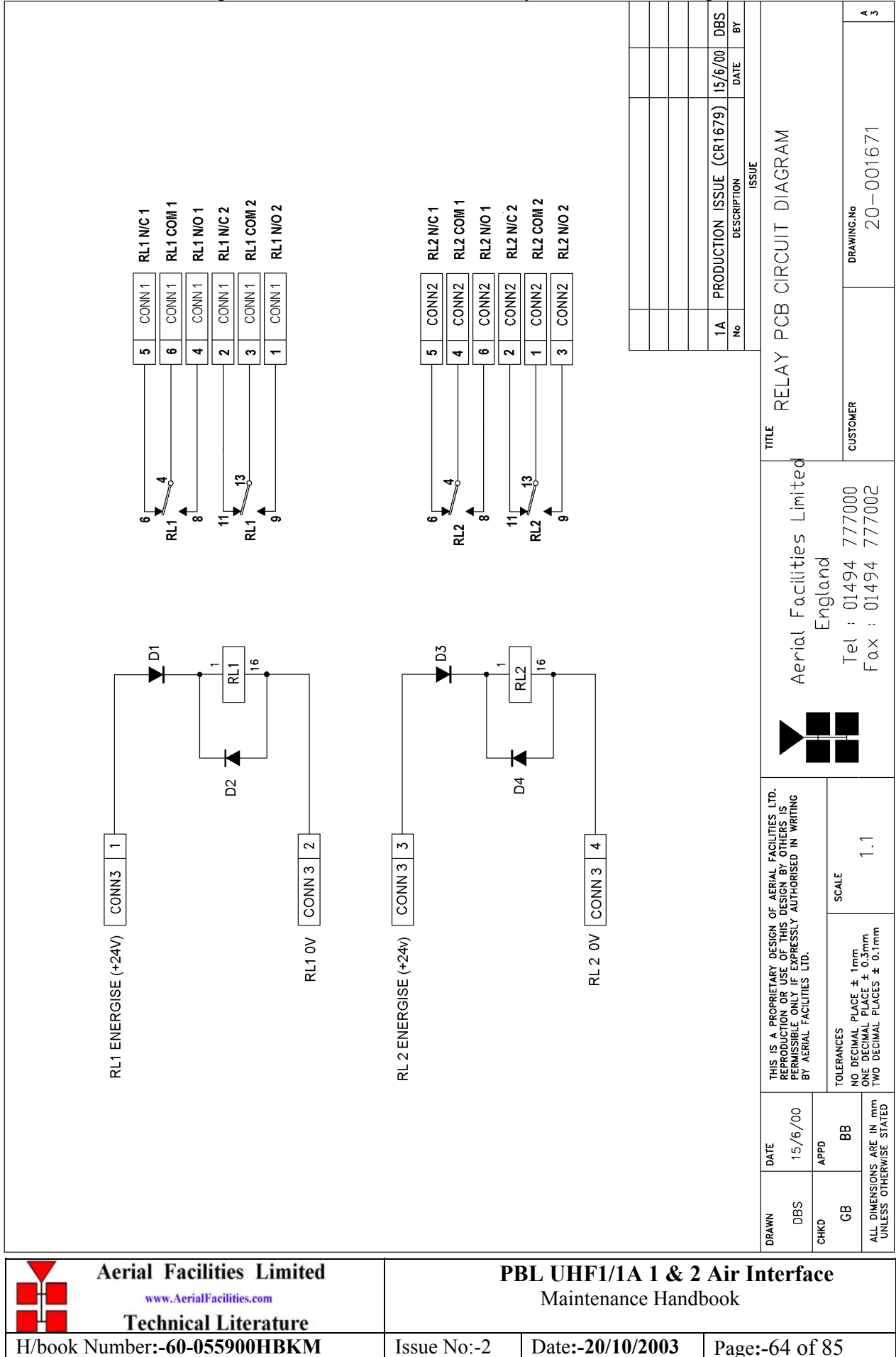

Aerial Facilities Limited
www.AerialFacilities.com
Technical Literature

PBL UHF1/1A 1 & 2 Air Interface
 Maintenance Handbook

5.1.9.4 Drg. Nō. 80-008970, Single Relay Board Circuit Diagram

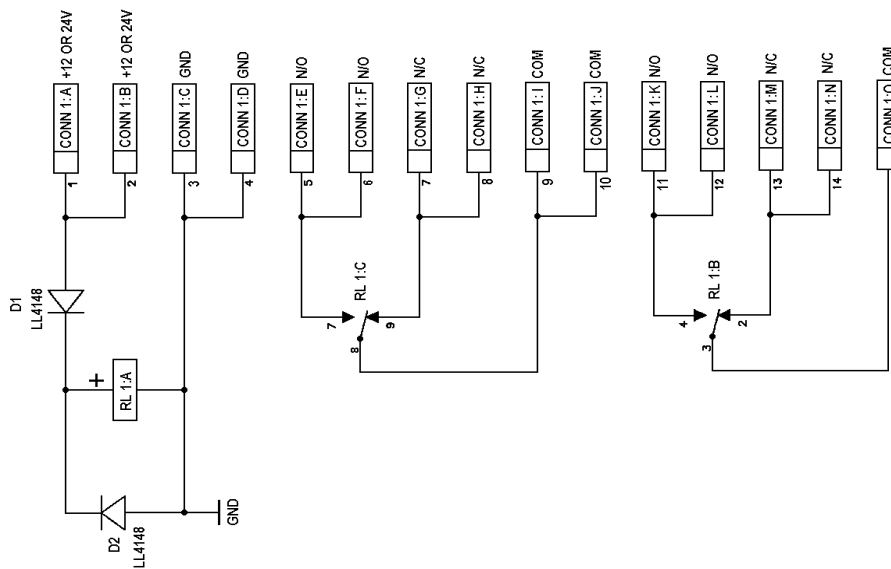

No	DESCRIPTION	DATE	BY
A	PROTOTYPE ISSUE	20/7/98	PDC

TITLE		12 & 24V RELAY PCB CIRCUIT DIAGRAM	
CUSTOMER	DRG. No.	80 - 008970	Iss. A

Aerial Facilities Ltd
 England
 Chesham(01494)778301
 Fax (01494)778910

DRAWN PDC	DATE 20/7/98	THIS IS A PROPRIETY DESIGN OF AERIAL FACILITIES LTD REPRODUCTION OR USE OF THIS DESIGN BY OTHERS IS PERMISSIBLE ONLY IF EXPRESSLY AUTHORISED IN WRITING BY AERIAL FACILITIES LTD	SCALE
CHKD	APPD		
ALL DIMENSIONS ARE IN mm UNLESS OTHERWISE STATED		TOLERANCES NO DECIMAL PLACE : ± 0.040" ONE DECIMAL PLACE : ± 0.010" TWO DECIMAL PLACES : ± 0.005"	

Aerial Facilities Limited
www.AerialFacilities.com
Technical Literature

PBL UHF1/1A 1 & 2 Air Interface Maintenance Handbook		
H/book Number:-60-055900HBKM	Issue No:-2	Date:-20/10/2003
		Page:-65 of 85

5.1.10 SMA coaxial termination (93-930003)

5.1.10.1 Description

When a combiner system is used to split or combine RF signals, in many cases it is most cost effective to use a standard stock item 4, 6 or 8 port device where, in fact, only a 3 - 6 port device is needed. In this case the splitter/combiner module has one of its ports terminated (both uplink & downlink) with an appropriate load in order to preserve the correct impedance of the device over the specified frequency range. This has the advantage of allowing future expansion capability should extra channels or other functions become necessary. Terminations are available for every type of RF connector that may be used, N type, 7/16th or SMA, in this case SMA.

5.1.11 24V 400W Flat-Pack Power Supply (96-300011)

5.1.11.1 Description

The power supply unit is a switched-mode type capable of supplying 24V DC at 16.0Amps continuously. Equipment of this type typically requires approximately 10.0 Amps at 24V DC, so the PSU will be used conservatively ensuring a long operational lifetime.

No routine maintenance of the PSU is required. If a fault is suspected, then the output voltage from the power supply may be measured on its output terminals. This is typically set to 24.5V.

All the PSU's used in AFL Cell Enhancers are capable of operation from either 110 or 220V nominal AC supplies. The line voltage is sensed automatically, so no adjustment or link setting is needed by the operator. No drawings of the PSU are available.

5.1.11.2 Technical Specification

AC Input Supply:	
Voltage:	110 or 220V nominal - 90 to 132 or 180 to 264V (single phase, absolute limits)
Frequency:	47 to 63Hz
DC Output Supply:	
Voltage:	24V DC (nominal), 22 to 26V (absolute limits)
Current:	16.0A
Temperature range:	operational: -10BC to +55BC
	storage: -40BC to +70BC

5.2 UHF 2 Air Interface (60-055902)

5.2.1 Bandpass Filter (02-013401) See section 5.1.1

5.2.2 4 Port Tx Hybrid Combiner (05-003019)

5.2.2.1 Description

The 3dB Hybrid Combiner used is a device for accurately matching two or more RF signals to single or multiple ports, whilst maintaining an accurate 50Ω load to all inputs/outputs and ensuring that the VSWR and insertion losses are kept to a minimum. Any unused ports will be terminated with an appropriate 50Ω load. In UHF 2 this hybrid is used to combine the signals from the channel selective modules (from both UHF 1 & 2) in the downlink direction for onward transmission by fibre, and similar signals for both UHF 1 & 2 are combined before being further split into the uplink channel modules.

5.2.2.2 Technical Specification

PARAMETER		SPECIFICATION
Frequency Range:		$f_o \pm 10\%$ (50 – 500 MHz)
Bandwidth:		$f_o \pm 10\%$
Inputs:		2
Outputs:		2
Insertion Loss:		<3.5 dB
Isolation between Input or Output ports:		>27 dB
Return Loss (VSWR) – Input:		1.3:1
Return Loss (VSWR) – Output:		1.3:1
Impedance:		50 Ω
Temperature Range	operation:	-10°C to +55°C
	storage:	-20°C to +70°C
MTBF:		>180,000 hours
Power Rating – Splitter:		Up to 150 Watts (load dependant)
Power Rating – Combiner:		Available up to 100 Watts
Environmental:		IP54
Connectors:		‘N’ female
Dimensions:		118 x 102 x 35 mm (including connectors)
Weight:		0.5 kg

5.2.3 Four Way Low Power Splitter (05-003401) See section 5.1.2

5.2.4 ¼Watt 0- -30dB Switched Attenuator (10-000701) See section 5.1.3

5.2.5 Low Noise Amplifiers (11-007302 & 11-007402) See section 5.1.4

5.2.6 3 Stage Amplifier Alarm Boards (12-002201) See section 5.1.6

5.2.7 20Watt Power Amplifier (12-004201)

5.2.7.1 Description

The power amplifiers fitted to this unit are multi-stage, solid state power amplifiers. Class A circuitry is employed throughout the units to ensure excellent linearity over a wide dynamic frequency range. All the semi-conductor devices are very conservatively rated to ensure low device junction temperatures and a long, trouble free working lifetime.

The power amplifiers should require no maintenance over their operating lives. Under no circumstances should the cover be removed or the side adjustments disturbed unless it is certain that an amplifier has failed; since they are critically aligned during manufacture and any re-alignment will require extensive test equipment.

5.2.7.2 Technical Specification

PARAMETER		SPECIFICATION
Frequency Range:		350 – 550MHz (tuned to spec.)
Bandwidth:		20MHz (tuned to spec.)
Maximum Output Power:		>20W
Gain:		30dB
1dB Compression Point:		<+43dBm
3rd Order Intercept Point:		<+54dBm
VSWR:		better than 1.45:1
Connectors:		SMA female
Supply:		3.50A @ 24V DC
Size:		276 x 78 x 40mm (ex. connectors & heatsink)
Weight:		1.5 kg (approximately, excluding heatsink)
Temperature range:	operational:	-10°C to +55°C
	storage:	-40°C to +70°C

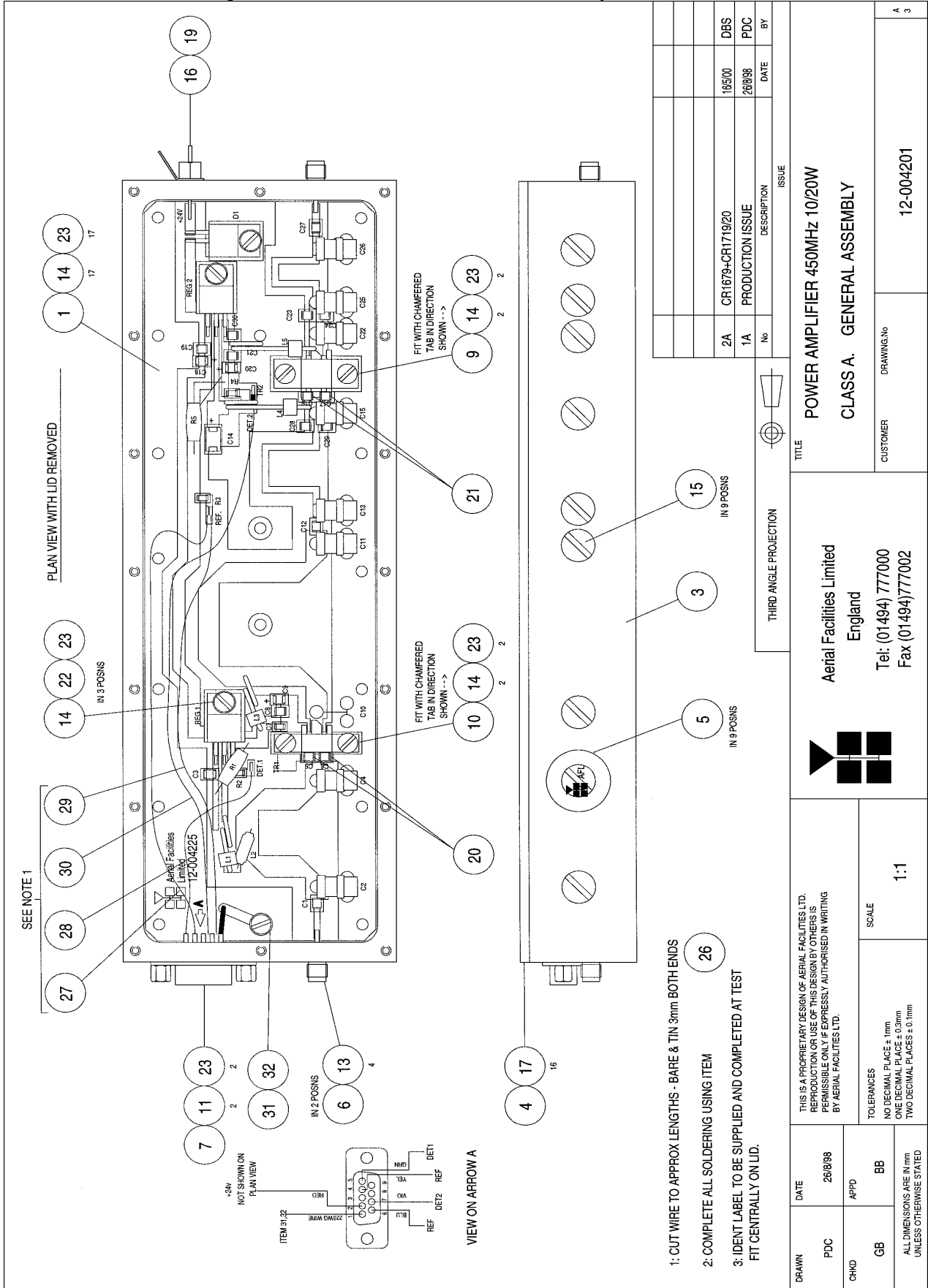

Aerial Facilities Limited
www.AerialFacilities.com
Technical Literature

**PBL UHF1/1A 1 & 2 Air Interface
Maintenance Handbook**

5.2.7.4 Drg. N^o. 12-004270, PA Circuit Diagram

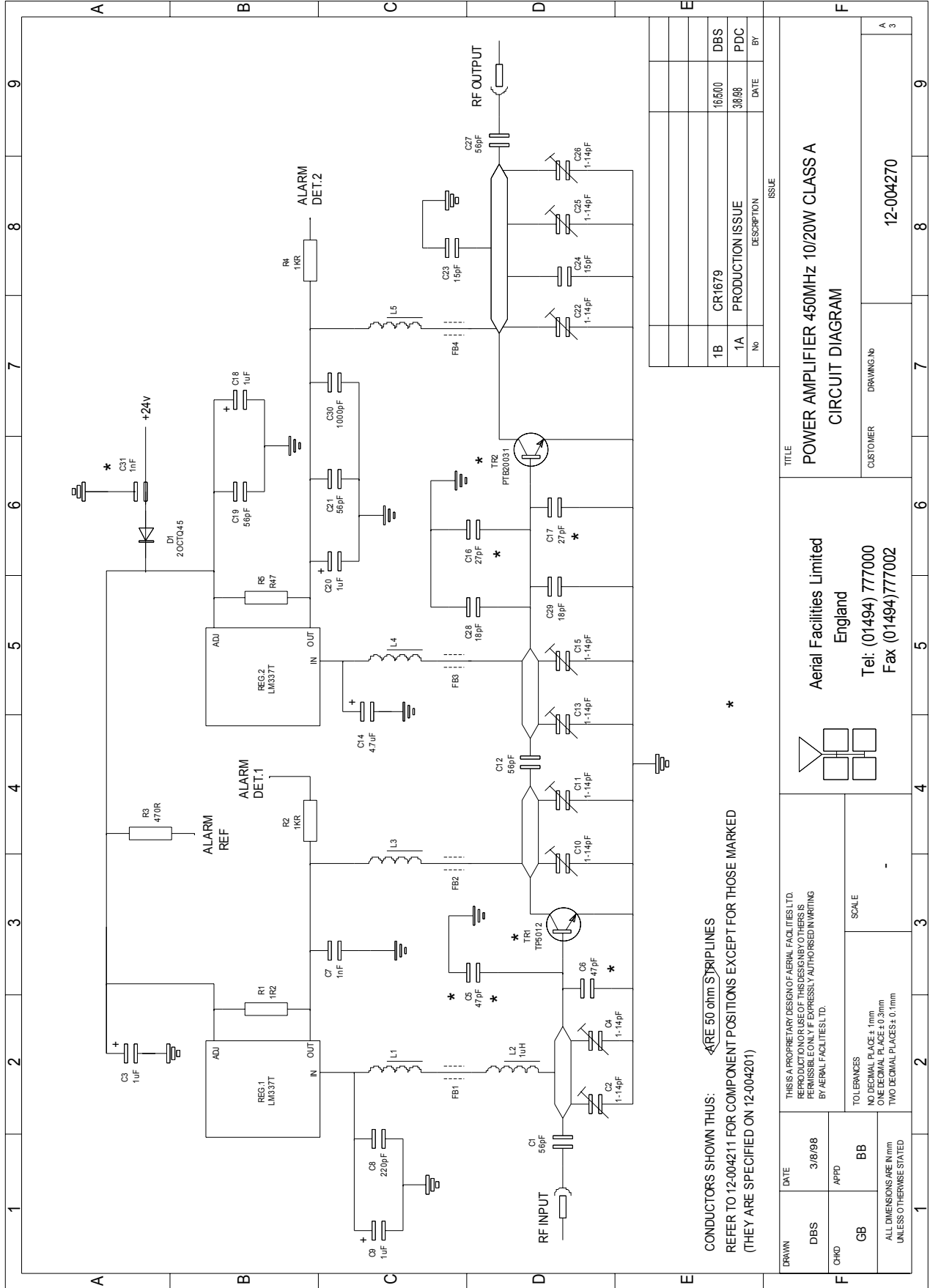

CONDUCTORS SHOWN THUS: ARE 50 ohm STRIPLINES
 REFER TO 12-004211 FOR COMPONENT POSITIONS EXCEPT FOR THOSE MARKED
 (THEY ARE SPECIFIED ON 12-004201)

No	DESCRIPTION	DATE	BY
1B	CR1679	16/500	DBS
1A	PRODUCTION ISSUE	3/8/98	PDC

TITLE		POWER AMPLIFIER 450MHz 10/20W CLASS A	
CIRCUIT DIAGRAM			
CUSTOMER	DRAWING No	12-004270	
A		3	

Aerial Facilities Limited
 England
 Tel: (01494) 777000
 Fax: (01494) 777002

THIS IS A PROPRIETARY DESIGN OF AERIAL FACILITIES LTD. REPRODUCTION OR USE OF THIS DESIGN BY OTHERS IS PERMISSIBLE ONLY IF EXPRESSLY AUTHORISED IN WRITING BY AERIAL FACILITIES LTD.	SCALE
TOLERANCES NO DECIMAL PLACE ± 1mm ONE DECIMAL PLACE ± 0.3mm TWO DECIMAL PLACES ± 0.1mm UNLESS OTHERWISE STATED	-
DATE	3/8/98
DBS	
CHD	APFD
GB	BB

Aerial Facilities Limited
www.AerialFacilities.com
Technical Literature

5.2.7.5 Drg. Nō. 12-004270C1, PA Parts List(1)

	1	2	3	4	5							
	CIRC. REF.	AFL STOCK REF.	DESCRIPTION									
A	C1	93-200006	56pF CHIP CAP 10% TOL.(MIN)									
	C2	93-130023	PCB MOUNT AIR TRIMMER 1-14pF									
	C3	93-240003	1uF TANTALUM CHIP CAP 35V									
	C4	93-130023	PCB MOUNT AIR TRIMMER 1-14pF									
B	C5	REFER TO GA 12-004201 FOR DETAILS										
	C6	REFER TO GA 12-004201 FOR DETAILS										
	C7	93-200020	1nF CHIP CAP 63V 10%									
	C8	93-200014	220pF CHIP CAP 10% TOL (MIN)									
	C9	93-240004	1uF TANTALUM CHIP CAP 35V									
	C10	NOT FITTED	NOT FITTED									
	C11	93-130023	PCB MOUNT AIR TRIMMER 1-14pF									
C	C12	93-200006	56pF CHIP CAP 10% TOL.(MIN)									
	C13	93-130023	PCB MOUNT AIR TRIMMER 1-14pF									
	C14	93-240006	4.7uF TANTALUM CHIP CAP 35V									
	C15	93-130023	PCB MOUNT AIR TRIMMER 1-14pF									
	C16	REFER TO GA 12-004201 FOR DETAILS										
	C17	REFER TO GA 12-004201 FOR DETAILS										
D	C18	93-240003	1uF TANTALUM CHIP CAP 35V									
	C19	93-200006	56pF CHIP CAP 10% TOL.(MIN)									
	C20	93-240004	1uF TANTALUM CHIP CAP 35V									
	C21	93-200006	56pF CHIP CAP 10% TOL.(MIN)									
	C22	93-130023	PCB MOUNT AIR TRIMMER 1-14pF									
	C23	93-200005	15pF CHIP CAP 10% TOL.(MIN)									
	C24	93-200005	15pF CHIP CAP 10% TOL.(MIN)									
	C25	93-130023	PCB MOUNT AIR TRIMMER 1-14pF									
E	C26	93-130023	PCB MOUNT AIR TRIMMER 1-14pF									
	C27	93-200006	56pF CHIP CAP 10% TOL.(MIN)									
	C28	93-200004	18pF CHIP CAP 10% TOL.(MIN)									
	C29	93-200004	18pF CHIP CAP 10% TOL.(MIN)									
F	C30	93-200016	1000pF (1nF) CHIP CAP 10% TOL.(MIN)									
	C31	REFER TO GA 12-004201 FOR DETAILS										
G	2A	5/5/00	CR1679									
	1A	5/8/98	PROD. ISS.									
	ISSUE	DATE	CHANGE No	ISSUE	DATE	CHANGE No	ISSUE	DATE	CHANGE No	ISSUE	DATE	CHANGE No
G	 Aerial Facilities Limited			TITLE POWER AMPLIFIER,450MHZ,10/20W CIRCUIT COMPONENT LIST								
	DRAWN	DATE	CHKD	APPD	CUSTOMER				COMPONENT LIST FOR			
	PDC	5/8/98	GB	BB					12-004270C1			

5.2.7.6 Drg. Nō. 12-004270C2, PA Parts List(2)

1	2		3		4		5																												
CIRC. REF.	AFL STOCK REF.		DESCRIPTION																																
A	TR1	REFER TO GA 12-004201 FOR DETAILS							A																										
	TR2	REFER TO GA 12-004201 FOR DETAILS																																	
B	REG1	94-300002	LM337T, VOLTAGE REGULATOR						B																										
	REG2	94-300002	LM337T, VOLTAGE REGULATOR																																
C	D1	94-120006	20TQ45 45V DUAL SCHOTTKY DIODE						C																										
	R1	93-540075	1R2 2.5W RESISTOR																																
D	R2	93-630037	1KR CHIP RESISTOR						D																										
	R3	93-630032	470R CHIP RESISTOR																																
	R4	93-630037	1KR CHIP RESISTOR																																
	R5	93-540083	47R 6W RESISTOR																																
	L1	90-500012	1.25 ENAMELLED COPPER WIRE																																
E		93-910001	FERRITE BEAD						E																										
	L2	93-400004	1.0uH CHOKE SIGMA SC10 SERIES																																
	L3	90-500012	1.25 ENAMELLED COPPER WIRE																																
		93-910001	FERRITE BEAD																																
	L4	90-500012	1.25 ENAMELLED COPPER WIRE																																
F		93-910001	FERRITE BEAD						F																										
	L5	90-500012	1.25 ENAMELLED COPPER WIRE																																
		93-910001	FERRITE BEAD																																
<table border="1"> <tr> <td>2A</td> <td>5/5/00</td> <td>CR1679</td> <td></td> <td></td> <td></td> <td></td> <td></td> <td></td> <td></td> <td></td> <td></td> </tr> <tr> <td>1A</td> <td>5/8/98</td> <td>PROD. ISS.</td> <td></td> <td></td> <td></td> <td></td> <td></td> <td></td> <td></td> <td></td> <td></td> </tr> </table>												2A	5/5/00	CR1679										1A	5/8/98	PROD. ISS.									
2A	5/5/00	CR1679																																	
1A	5/8/98	PROD. ISS.																																	
ISSUE			DATE			CHANGE No			ISSUE			DATE			CHANGE No																				
 Aerial Facilities Limited						TITLE POWER AMPLIFIER,450MHZ,10x20W CIRCUIT COMPONENT LIST																													
DRAWN		DATE		CHKD		APPD		CUSTOMER				COMPONENT LIST FOR																							
PDC		5/8/98		GB		BB						12-004270C2																							

5.2.8 DC/DC Converter, 24V in, 12V 8A out (13-003011) See section 5.1.7

5.2.9 Chan. Selec. & Chan. Contr. Mdl (17-003012 & 17-002101) See section 5.1.8

5.2.10 21MHz IF Filter Board (17-002502)

5.2.10.1 Description

The above channel selective modules are fitted with a 21MHz filter board to narrow the channel bandwidth from 30kHz to 15kHz.

5.2.11 Single & Dual 24Volt Relay Boards (20-001602 & 80-008902) See section 5.1.9

5.2.12 SMA Coaxial Termination (93-930003) See section 5.1.10

5.2.13 24V 400W Flat-Pack Power Supply (96-300011) See section 5.1.11

5.2.14 JWS75-15/A PSU (96-300045)

5.2.14.1 Description

The power supply unit is a switched-mode type capable of supplying 24V DC at 6.25Amps continuously. This PSU is used to provide power for the fibre optic modules which will typically require approximately 3.0 Amps at 24V DC, so the PSU will be used conservatively ensuring a long operational lifetime.

No routine maintenance of the PSU is required. If a fault is suspected, then the output voltage from the power supply may be measured on its output terminals. This is typically set to 24.5V.

All the PSU's used in AFL Cell Enhancers are capable of operation from either 110 or 220V nominal AC supplies. The line voltage is sensed automatically, so no adjustment or link setting is needed by the operator.

5.2.14.2 Technical Specification

AC Input Supply:	
Voltage:	110 or 220V nominal
	90 to 132 or 180 to 264V (absolute limits)
Frequency:	47 to 63Hz
DC Output Supply:	
Voltage:	24V DC (nominal)
	22 to 26V (absolute limits)
Current:	6.25A

5.2.15 Single Mode Optical Coupler (98-100001)

5.2.15.1 Description

Single or dual optical couplers are used whenever it is required to split optical signals for transmission to more than one destination or combine them to a single common input. The couplers are O.E.M devices and are not considered repairable. Any suspected faulty coupler should be replaced.

5.2.16. Fibre Optic Receiver & Transmitter (98-200003 & 98-300003)

5.2.16.1 Description

The F/O units consist of a receiver & transmitter, which modulates the RF signal onto a laser carrier and transmits it via fibre/optic cable to a receiver unit some distance away where it is demodulated back to the original RF signal with very small values of accrued attenuation. Both transmitter and receiver modules have their own dedicated alarm outputs (volt-free relay contacts) which are integrated into the main alarm system. Being O.E.M devices, no drawings or circuit diagrams are available.

Caution: The FO units are NOT weather proof.

 Aerial Facilities Limited www.AerialFacilities.com Technical Literature	PBL UHF1/1A 1 & 2 Air Interface Maintenance Handbook		
	H/book Number:- 60-055900HBKM	Issue No:-2	Date:- 20/10/2003

5.2.16.2 Technical Specification

PARAMETER		SPECIFICATION
Power Consumption:	Tx:	120mA @ 15V DC (320mA @ -10BC)
	Rx:	330mA @ 15V DC
Frequency Range:		0.1 – 2.2GHz
Link noise figure:		40dB (typical)
Link noise figure (max.):		<45dB
Total link gain:		0dB
CNR @ 5 Km link length:	@30KHz B/W:	>84dB
	@200KHz B/W:	>76dB
	@1.2MHz B/W:	>69dB
RF total input power:		0dBm
Input IP3:		26dBm
Optical budget:		2 – 9.0dB
Max. link length:		20Km
Response Flatness:		<±1.0 dB
Optical Output Power (Tx):		2.4 – 4.0mW
Optical Wavelength:		1310±10nm
Fibre loss:		0.38dB/Km
Optical return loss:		-60dB
Optical Connector loss:		0.5dB per mated pair

Rx 'D' Type Female Connector

Pin Nō.	Signal Description
1	+15V DC Power
2	Optional Data Output
3	Power Ground
4	RF Signal Strength Monitor
5	Optical Power Monitor
6	O.C. Alarm
7	Optional Data Output
8	Relay Alarm Contact 1
9	Relay Alarm Contact 2

Tx 'D' Type Female Connector

Pin Nō.	Signal Description
1	+15V DC Power
2	Optional Data Input
3	Power Ground
4	RF Signal Strength Monitor
5	Laser Photodiode Current Monitor
6	Laser Current Monitor
7	Optional Data Input
8	Relay Alarm Contact 1
9	Relay Alarm Contact 2

5.3 UHF1A 60-055903 470MHz 3 Channel BDA

There are no modules or components in UHF1A unit that have not been covered in earlier section of this document – see the tables in **3. SPECIFICATIONS** for channel module frequencies, and the diagrams in section **4. SYSTEM DRAWINGS** for expected signal levels.

 Aerial Facilities Limited www.AerialFacilities.com Technical Literature	PBL UHF1/1A 1 & 2 Air Interface Maintenance Handbook		
	H/book Number:- 60-055900HBKM	Issue No:-2	Date:- 20/10/2003

6. INSTALLATION

6.1 Initial Installation Record

When this equipment is initially commissioned, please use the equipment set-up record sheet in Appendix A. This will help both the installation personnel and AFL should these figures be needed for future reference or diagnosis.

6.2 General

The size and weight of the wall units mean that they represent a significant health hazard unless they are mechanically installed in the correct manner. In the interests of safety this should be done before any electrical, RF, or optical connections are made.

It is important in determining the location of the wall units that space is allowed for access to the front and underneath of the equipment. To enable maintenance to be carried out, the door must be able to fully open. The location must be served with a duct to allow the entry of cables into the unit.

6.3 Electrical Connections

The mains power supply and the alarms are connected through an IP65 connector which should need no further attention once connected. It is recommended that the AC power connection is approved by a qualified electrician, who must satisfy himself that the supply will be the correct voltage and of sufficient capacity.

All electrical and RF connection should be completed and checked prior to power being applied for the first time.

6.4 Optical Connections

The optical input and output ports are located on a bracket fixed to the lower inside of the case. The optical fibres from the tunnels enter through a cable gland on the case underside. The ports are supplied with a green plastic cover, which must be removed prior to the connection of the fibre cable. Ensure that transmitter and receiver fibre cable are identified to prevent misconnection. At the master site, the fibre transmitters are in the downlink path with the receivers in the uplink. At the remote sites the fibre transmitters are in the uplink with the receivers in the downlink. Where some of the fibre optic transmitter outputs are split with optical couplers to provide a connection to more than one remote site, care must be taken to ensure that the correct connections are made.

Ensure that connections are kept clean and are fully tightened.

 Aerial Facilities Limited www.AerialFacilities.com Technical Literature	PBL UHF1/1A 1 & 2 Air Interface Maintenance Handbook		
	H/book Number:- 60-055900HBKM	Issue No:-2	Date:- 20/10/2003

6.5 RF Connections

All RF connections are made to the cable termination, located on the right-hand side of the wall enclosure. Care must be taken to ensure that the correct connections are made with particular attention made to the base station TX/RX ports. In the event that the base transmitter is connected to the RX output of the rack, damage to the equipment may be done if the base station transmitter is then keyed. If the environment where the equipment is installed is deemed to be 'wet' i.e. water seepage through roofs or walls, then suitable methods to seal the RF N type connectors should be used, for example self amalgamating sealant tape.

Ensure that connections are kept clean and are fully tightened.

6.6 Commissioning

Once all connections are made the equipment is ready for commissioning.

To commission the system the test equipment detailed in section 7.2 will be required. Using the system diagrams and the end-to-end test specification, the equipment should be tested to ensure correct operation. Typical RF levels that are not listed in the end-to-end specification, such as input levels to the fibre transmitters are detailed in the whole system diagram in section 4.

On initial power up the system alarm indicators on the door of the equipment should be checked. A red LED illuminated indicates a fault and that particular module must be investigated before proceeding with the commissioning. A green LED illuminates, to indicate that the power supply is connected and valid.

The individual fibre optic units are fitted with a pair of status indicators on their front panels. One is a green LED, which indicates that the unit is connected to a 15 Volt power supply. This indicator is common to both transmit and receive units. The second LED on the transmitter indicates that the laser is operating. On the receive unit the second LED indicates that a light signal is being received.

When all the fibre connections are completed and power to each site is connected each fibre unit should show two illuminated indicators.

In the event that any part of the system does not function correctly as expected, check all connections to ensure that they are to the correct port, that the interconnecting cables are not faulty and that they are tightened. The majority of commissioning difficulties arise from problems with the interconnecting cables and connectors.

 Aerial Facilities Limited www.AerialFacilities.com Technical Literature	PBL UHF1/1A 1 & 2 Air Interface Maintenance Handbook		
	H/book Number:- 60-055900HBKM	Issue No:-2	Date:- 20/10/2003

7. MAINTENANCE

7.1 General Procedures

7.1.1 Fault Finding

In the event that the performance of the system is suspect, a methodical and logical approach to the problem will reveal the cause of the difficulty. The System consists of modules within a wall mounted, environmentally protected enclosure.

Transmissions from the main base stations are passed though the system to the mobile radio equipment; this could be a handheld walkie-talkie, mobile telephone or a transceiver in a vehicle. This path is referred to as the downlink. The return signal path from the mobile radio equipment to the base station is referred to as the uplink.

The first operation is to check the (optional) alarms of each of the active units and determine that the power supplies to the equipment are connected and active.

This can be achieved remotely (via CEMS, the digital RS232 Cell Enhancer Management System, if fitted), or locally with the front door LED's. The green LED on the front door should be illuminated, while the red alarm indicator should be off.

If an Alarm is on, then that individual module must be removed and tested against the original test specification.

The individual amplifier units have a green LED showing through a hole in their piggy-back alarm board (or directly through a hole in the amplifier lid), which is illuminated if the unit is working correctly.

If an amplifier is suspect, check the DC power supply to the unit. If no other fault is apparent use a spectrum analyser to measure the incoming signal level at the input and then after reconnecting the amplifier input, measure the output level. Consult with the system diagram and amplifier specification to determine the expected gain and compare result.

In the event that there are no alarms on and all units appear to be functioning it will be necessary to test the system in a logical manner to confirm correct operation.

 Aerial Facilities Limited www.AerialFacilities.com Technical Literature	PBL UHF1/1A 1 & 2 Air Interface Maintenance Handbook		
	H/book Number:- 60-055900HBKM	Issue No:-2	Date:- 20/10/2003

7.1.2 Downlink

Confirm that there is a signal at the expected frequency and strength from the base station. If this is not present then the fault may lay outside the system. To confirm this, inject a downlink frequency signal from a known source at the master site BTS input and check for output at the remote site feeder output.

If a signal is not received at the output it will be necessary to follow the downlink path through the system to find a point at which the signal is lost. The expected downlink output for the given input can be found in the end-to-end test specification.

7.1.3 Uplink

Testing the uplink involves a similar procedure to the downlink except that the frequencies used are those transmitted by the mobile equipment.

7.1.4 Fault repair

Once a faulty component has been identified, a decision must be made on the appropriate course to carry out a repair. A competent engineer can quickly remedy typical faults such as faulty connections or cables. The exceptions to this are cable assemblies connecting bandpass filter assemblies that are manufactured to critical lengths to maintain a 50-ohm system. Care should be taken when replacing cables or connectors to ensure that items are of the correct specification. The repair of component modules such as amplifiers, tuned cavities or bandpass filters will not usually be possible in the field, as they frequently require specialist knowledge and test equipment to ensure correct operation. It is recommended that items of this type are replaced with a spare unit and the faulty unit returned to AFL for repair. If spare parts need to be ordered from AFL, be sure to quote the serial number of the Cell Enhancer/Repeater and the serial number [and frequencies] of the module(s) to be replaced.

 Aerial Facilities Limited www.AerialFacilities.com Technical Literature	PBL UHF1/1A 1 & 2 Air Interface Maintenance Handbook		
	H/book Number:- 60-055900HBKM	Issue No:-2	Date:- 20/10/2003

7.1.5 Checking service

Following the repair of any part of the system it is recommended that a full end-to-end test is carried out in accordance with the test specification and that the coverage is checked by survey.

It is important to bear in mind that the system includes a radiating cable network and base stations that may be faulty or may have been damaged.

7.1.6 Service Support

Advice and assistance with maintaining and servicing this system are available by contacting Aerial Facilities Ltd.

7.2 Tools & Test Equipment

The minimum tools and test equipment needed to successfully service this AFL product are as follows:-

Spectrum analyser:	100kHz to 2GHz (Dynamic range = 90dB).
Signal Generator:	30MHz to 2GHz (-120dBm to 0dBm o/p level).
Attenuator:	20dB, 10W, DC-2GHz, (N male – N female).
Test Antenna:	Yagi or dipole for operating frequency.
Optical power meter:	1310 – 1550nm (-40 - +10dB)
Digital multi-meter:	Universal Volt-Ohm-Amp meter.
Test cable x 2:	N male – N male, 2M long RG214.
Test cable x 2:	SMA male – N male, 1m long RG223.
Hand tools:	Philips #1&2 tip screwdriver. 3mm flat bladed screwdriver. SMA spanner and torque setter.

 Aerial Facilities Limited www.AerialFacilities.com Technical Literature	PBL UHF1/1A 1 & 2 Air Interface Maintenance Handbook		
	H/book Number:- 60-055900HBKM	Issue No:-2	Date:- 20/10/2003 Page:-82 of 85

7.3 Care of Modules

7.3.1 General Comments

Many of the active modules contain semiconductor devices utilising MOS technology, which can be damaged by electrostatic discharge. Correct handling of such modules is mandatory to ensure their long-term reliability.

To prevent damage to a module, it must be withdrawn/inserted with care. The module may have connectors on its underside, which might not be visible to the service operative.

7.3.2 Module Removal (LNA's, general procedure):

The following *general* rules should be followed to remove a module:

- 1 Remove power to the unit
- 2 Remove all visible connectors (RF, DC & alarm)
- 3 Release module retaining screws.
- 4 Slowly but firmly, pull the module straight out of its position. Take care not to twist/turn the module during withdrawal. (When the module is loose, care may be needed, as there may be concealed connections underneath).

7.3.3 Module Replacement (general):

- 1 Carefully align the module into its location then slowly push the module directly straight into its position, taking care not to twist/turn it during insertion.
- 2 Reconnect all connectors, RF, alarm, power etc.,(concealed connectors may have to be connected first).
- 3 Replace retaining screws (if any).
- 4 Double-check all connections before applying power.

7.3.4 Power Amplifiers

- 1) Remove power to the unit. (Switch off @ mains/battery, or remove DC in connector)
- 2) Remove alarm wires from alarm screw terminal block or disconnect multi-way alarm connector.
- 3) Carefully disconnect the RF input and output coaxial connectors (usually SMA)

If alarm board removal is not required, go to step 5.

- 4) There is (usually) a plate attached to the alarm board which fixes it to the amplifier, remove its retaining screws and the alarm board can be withdrawn from the amplifier in its entirety. On certain types of amplifier the alarm board is not mounted on a dedicated mounting plate; in this case it will have to firstly be removed by unscrewing it from the mounting pillars, in most cases, the pillars will not have to be removed before lifting the amplifier.

 Aerial Facilities Limited www.AerialFacilities.com Technical Literature	PBL UHF1/1A 1 & 2 Air Interface Maintenance Handbook		
	H/book Number:- 60-055900HBKM	Issue No:-2	Date:- 20/10/2003

- 5) If the amplifier to be removed has a heatsink attached, there may be several different ways it can have been assembled. The most commonly used method, is screws through the front of the heatsink to threaded screw holes (or nuts and bolts), into the amplifier within the main case. If the heatsink is mounted on the rear of the main case (e.g., against a wall in the case of wall mounted enclosures), then the fixing method for the heatsink will be from within the case, (otherwise the enclosure would have to be removed from the wall in order to remove the heatsink).

When the heatsink has been removed, the amplifier may be unscrewed from the main casing by its four corner fixings and gently withdrawn.

Fitting a new power amplifier module will be the exact reverse of the above.

Note: Do not forget to apply fresh heatsink compound to the heatsink/main case joint and also between the amplifier and the main case.

7.3.5 Low Power Amplifier Replacement

- 1 Disconnect the mains power supply and disconnect the 24V dc supply connector for the LPA.
- 2 Disconnect the RF input and output cables from the LPA.
- 3 Disconnect the alarm connector.
- 4 Remove the alarm monitoring wires from (D type connector) pins 9 and 10.
- 5 Remove the LPA module by removing the four retaining screws, replace with a new LPA module and secure it with the screws.
- 6 Connect the RF cables to the LPA input and output connectors. Reconnect the wires to the alarm board connector pins 9 and 10.
- 7 Reconnect the DC supply connector and turn the mains switch on.

Note: Tighten SMA connectors using only a dedicated SMA torque spanner. If SMA connectors are over-tightened, irreparable damage will occur. . Do not use adjustable pliers to loosen/tighten SMA connectors.

Also take care not to drop or knock the module as this can damage (or misalign in the case of tuned passive modules) sensitive internal components. Always store the modules in an environmentally friendly location

7.3.6 Module Transportation:

To maintain the operation, performance and reliability of any module it must be stored and transported correctly. Any module not installed in a whole system must be kept in an anti-static bag or container. These bags or containers are normally identified by being pink or black, and are often marked with an ESD label. Any module sent back to AFL for investigation/repair must be so protected. Please contact AFL's quality department before returning a module.

 Aerial Facilities Limited www.AerialFacilities.com Technical Literature	PBL UHF1/1A 1 & 2 Air Interface Maintenance Handbook		
	H/book Number:-60-055900HBKM	Issue No:-2	Date:-20/10/2003

APPENDIX A INITIAL EQUIPMENT SET-UP CALCULATIONS

GENERAL INFORMATION			
Site Name:		Client Name:	
Date:		AFL Equip. Model Nō.	

ANTENNA SYSTEMS				
	Model	Gain	Azimuth	Comments
A - Service Antenna				
B - Donor Antenna				
	Type	Loss	Length	Comments
C - Service Feeder				
D - Donor Feeder				

INITIAL PARAMETERS	
E - CE Output Power	dBm
F - Antenna Isolation	dB
G - Input signal level from donor BTS	dBm
Operating Voltage	V

DOWNLINK CALCULATIONS		
Parameter	Comments	Value
Input signal level (G)		dBm
CE max. o/p power (E)		dBm
Gain setting	E - G	dB
Isolation required	(Gain + 10dB)	dB
Service antenna gain (A)		dB
Service antenna feeder loss (C)		dB
Effective radiated power (ERP)	E+A-C	dBm
Attenuator setting	CE gain-gain setting	dB

If the input signal level in the uplink path is known and steady, use the following calculation table to determine the gain setting. If the CE features Automatic Gain Control the attenuator should be set to zero and if not, then the attenuation setting for both uplink and downlink should be similar.

UPLINK CALCULATIONS		
Parameter	Comments	Value
Input signal level		dBm
CE max. o/p power (E)		dBm
Gain setting		dB
Required isolation		dB
Donor antenna gain (B)		dB
Donor antenna feeder loss (D)		dB
Effective radiated power (ERP)	E+B-D	dBm
Attenuator setting	(CE gain-gain setting)	dB