

## MBF, Multi Band Repeater

### Product Description and User's Manual

THIS DOCUMENT IS VALID FOR SINGLE-BAND, DUAL-BAND AND TRI-BAND MBF REPEATERS SUPPORTING THE FOLLOWING FREQUENCY BANDS:

LTE 700, 850, 900, 1800, 1900, 2200 and AWS



*Single or dual band repeater*



*Tri band repeater*

Copyright © 2011 Axell Wireless Ltd

All rights reserved.

No part of this document may be copied, distributed, transmitted, transcribed, stored in a retrieval system, or translated into any human or computer language without the prior written permission of Axell Wireless Ltd.

The manufacturer has made every effort to ensure that the instructions contained in this document are adequate and free of errors and omissions. The manufacturer will, if necessary, explain issues which may not be covered by this document. The manufacturer's liability for any errors in the document is limited to the correction of errors and the aforementioned advisory services.

This document has been prepared to be used by professional and properly trained personnel, and the customer assumes full responsibility when using them. The manufacturer welcomes customer comments as part of the process of continual development and improvement of the documentation in the best way possible from the user's viewpoint. Please submit your comments to the nearest Axell Wireless sales representative.

## Contact Information

Headquarters	<p>Axell Wireless Aerial House Asheridge Road Chesham Buckinghamshire HP5 2QD United Kingdom</p> <p>Tel: +44 1494 777000 Fax: +44 1494 777002</p>
Commercial inquiries	<a href="mailto:info@axellwireless.com">info@axellwireless.com</a>
Web site	<a href="http://www.axellwireless.com">www.axellwireless.com</a>
Support issues	<a href="mailto:support@axellwireless.com">support@axellwireless.com</a>
Technical Support Line, English speaking	+44 1494 777 777

Contact information for Axell Wireless offices in other countries can be found on our web site, [www.axellwireless.com](http://www.axellwireless.com)

## About This Manual

This Product Manual provides the following information:

- Description of the Repeater unit
- Procedures for setup, configuration and checking the proper operation of the unit
- Maintenance and troubleshooting procedures

## For whom it is Intended

This Product Manual is intended for experienced technicians and engineers. It is assumed that the customers installing, operating, and maintaining Axell Wireless Repeaters are familiar with the basic functionality of Repeaters.

## Notice

Confidential - Authorized Customer Use

This document may be used in its complete form only and is solely for the use of Axell Wireless employees and authorized Axell Wireless channels or customers. The material herein is proprietary to Axell Wireless. Any unauthorized reproduction, use or disclosure of any part thereof is strictly prohibited.

All trademarks and registered trademarks are the property of their respective owners.

## Disclaimer of Liability

Contents herein are current as of the date of publication. Axell Wireless reserves the right to change the contents without prior notice. The information furnished by Axell Wireless in this document is believed to be accurate and reliable. However, Axell Wireless assumes no responsibility for its use. In no event shall Axell Wireless be liable for any damage resulting from loss of data, loss of use, or loss of profits and Axell Wireless further disclaims any and all liability for indirect, incidental, special, consequential or other similes damages. This disclaimer of liability applies to all products, publications and services during and after the warranty period.

## Warrantee

All antennas must be installed with Lightning protection. Damage to power modules, as a result of lightning are not covered by the warranty.

Switching on AC or DC power prior to the connection of antenna cables is regarded as faulty installation procedure and therefore not covered by the Axell Wireless warranty.

## Safety to Personnel

Before installing or replacing any of the equipment, the entire manual should be read and understood. The user needs to supply the appropriate AC or DC power to the OMU System. Incorrect power settings can damage the OMU System and may cause injury to the user.

Throughout this manual, there are "Caution" warnings. "Caution" calls attention to a procedure or practice, which, if ignored, may result in injury or damage to the system, system component or even the user. Do not perform any procedure preceded by a "Caution" until the described conditions are fully understood and met.

**CAUTION!** This notice calls attention to a procedure or practice that, if ignored, may result in personal injury or in damage to the system or system component. Do not perform any procedure preceded by a "Caution" until described conditions are fully understood and met.

## Safety to Equipment

When installing, replacing or using this product, observe all safety precautions during handling and operation. Failure to comply with the safety precautions and with specific precautions described elsewhere in this manual violates the safety standards of the design, manufacture, and intended use of this product. Axell Wireless assumes no liability for the customer's failure to comply with these precautions. This entire manual should be read and understood before operating or maintaining the OMU System.

## Class 3B Laser

This product is equipped with class 3B lasers, as per definition in EN 60825-1.

	<p><b>Caution!!!</b></p> <p>Un-terminated optical receptacles may emit laser radiation. Do not stare into beam or view with optical instruments.</p>
---	--

Optical transmitters in the opto-module can emit high energy invisible laser radiation. There is a risk for permanent damage to the eye.

Always use protective cover on all cables and connectors which are not connected. Never look straight into a fibre cable or a connector. Consider that a fibre can carry transmission in both directions.

During handling of laser cables or connections ensure that the source is switched off. Regard all open connectors with respect and direct them in a safe direction and never towards a reflecting surface. Reflected laser radiation should be regarded as equally hazardous as direct radiation.

## Radiation Hazard

This equipment emits radio frequency radiation and can, if used the wrong way, be hazardous for personnel. Here follows an example of the power densities from an intentional radiator.

For radiation from a general antenna, the power density (S) at some distance is according to the well-known formula:

$$S = \frac{G_t P_t}{4\pi R^2} = \frac{E^2}{377}$$

For the repeaters described in this handbook the maximum output powers are 5 W for 900 / 1800 MHz and 10 W 2100 MHz. The corresponding power densities using a + 10 dBi antenna as an example at 1 m will be 4 W/ m<sup>2</sup> for the 900/1800 MHz output and 8 W/ m<sup>2</sup> for 2100 MHz output.

1 m distance from the antenna at these frequencies is used as a minimum distance for practical exposure of the public. It is also difficult to have a developed EMF at distances closer than 1 m. According to R&TTE Health requirements referring to the 1999 Council recommendation, the reference level for the frequency range of 400 – 2000 MHz is  $f/200$  W/ m<sup>2</sup> ( f in MHz ) and above 2 GHz, 10 W/ m<sup>2</sup>.

For the repeaters in this manual the levels are:

GSM 900 (960 MHz) = 4.8 W/m<sup>2</sup>

DC 1800 (1880 MHz) = 9.4 W/m<sup>2</sup>

UMTS 2100 (2170 MHz) = 10 W/m<sup>2</sup>.

This means that an installation with a +10 dBi antenna does not exceed the basic restriction levels according to the recommendations.

For frequencies between 400 and 2000 MHz the ICNIRP occupational guideline level of exposure is  $f/40$  W/m<sup>2</sup> ( f in MHz), and 50 W/m<sup>2</sup> for frequencies above 2 GHz.

The ICNIRP levels for the frequency above bands:

GSM 900 (960 MHz) = 24 W/m<sup>2</sup>

DC 1800 (1880 MHz) = 47 W/m<sup>2</sup>

UMTS 2100 (2170 MHz) = 50 W/m<sup>2</sup>.

There are no radiation health issues with the above + 10 dBi antenna installations. However, the repeater is marked with radiation hazard warning.

## Standards

This document covers both GSM and WDCMA repeaters. These references are valid for respective repeater type.

ETSI TS 25.106	Universal Mobile Telecommunications System (UMTS); UTRA repeater radio transmission and reception 3GPP TS 25.106 version 5.8.0 Release 5)
ETSI TS 25.143	Universal Mobile Telecommunications System (UMTS); UTRA repeater conformance testing (3GPP TS 25.143 version 5.8.0 Release 5)
ETSI EN 301 908-3	Electromagnetic compatibility and Radio spectrum Matters (ERM); ElectroMagnetic Compatibility (EMC) standard for radio equipment and services; Part 1: Common technical requirements
ETSI EN 301 489-23	Electromagnetic compatibility and Radio spectrum Matters (ERM); ElectroMagnetic Compatibility (EMC) standard for radio equipment and services; Part 23: Specific Conditions for IMT-2000 CDMA Direct Spread (UTRA) Base Station (BS) radio, repeater and ancillary equipment
EN 60 950	Information technology equipment - Safety - Part 1: General requirements
EN 301 502	Harmonized EN for Global System for Mobile communications (GSM); Base station and Repeater equipment covering essential requirements under article 3.2 of the R&TTE directive (GSM 13.21 version 8.1.2. Release 1999)
ETS 300 342-3	Radio Equipment and Systems (RES); Electro-Magnetic Compatibility (EMC) for European Digital Cellular Telecommunications systems. Base Station Radio and ancillary equipment and Repeaters meeting phase 2 GSM requirements.
R & TTE Directive: ETS EN 301 502 (ETS EN 300 609-4/GSM 11.26)	Harmonized EN for Global System for Mobile communications (GSM); Base Station and Repeater equipment covering essential requirements under article 3.2 of the R&TTE directive
ETS EN 301 489-8	Electromagnetic Compatibility (EMC) Standard For Radio Equipment And Services; Part 8: Specific Conditions For GSM Base Stations
ETS 300 342-3	Electromagnetic Compatibility (EMC) For European Digital Cellular Telecommunications System (GSM 900 MHz and DCS 1 800 MHz); Part 3: Base Station Radio and Ancillary Equipment And Repeaters Meeting Phase 2 GSM Requirements

## Electrostatic Sensitivity

Observe electrostatic precautionary procedures.

*Caution*

ESD = Electrostatic Discharge Sensitive Device

Semiconductor transmitters and receivers provide highly reliable performance when operated in conformity with their intended design. However, a semiconductor may be damaged by an electrostatic charge inadvertently imposed by careless handling.

Static electricity can be conducted to the semiconductor chip from the centre pin of the RF input connector, and through the AC connector pins. When unpacking and otherwise handling the unit, follow ESD precautionary procedures including use of grounded wrist straps, grounded workbench surfaces, and grounded floor mats.

## Table of Contents

<b>1</b>	<b>Introduction</b>	<b>1</b>
1.1	General Information on Installation Approach	1
1.2	Models and Ordering Information	2
1.3	Characteristics	2
1.4	ALC	3
1.5	Operating Temperature	3
1.6	MBF Interfaces	3
1.6.1	Securing the Unit	4
1.6.2	External Interfaces	4
1.6.3	Internal Interfaces	5
<b>2</b>	<b>Installation</b>	<b>7</b>
2.1	Unpacking	7
2.1.1	Unpack the Unit	7
2.2	Mount the Repeater	7
2.2.1	Ensure Proper Cooling	8
2.3	Grounding	8
2.4	Ensure Good EMV Protection	9
2.5	Fibre Optic Connection	10
2.5.1	Cleaning Optical Connectors	12
2.6	External Alarm and Relay Connections	13
2.7	Power and Backup Battery	14
2.7.1	Connecting the Power Source	14
2.7.2	230 VAC Power Source	15
2.7.3	-48V Power Source Connection	16
2.7.4	Backup Battery	17
2.8	Power ON	17
2.8.1	Switching Power ON	17
2.8.2	Verifying LEDs	18
2.9	Closing and Securing the Repeater	18
<b>3</b>	<b>Commissioning Advice</b>	<b>19</b>
3.1	Signal Diagrams	19
3.2	OMU Point of Interface (POI)	20
3.3	Downlink POI / OMU DL Attenuator Adjustment	20
3.4	Repeater Downlink Optical Link Adjustment (OLA)	22
3.5	Downlink Repeater Gain Adjustment	22
3.6	UMTS Signal Measurement	24
3.6.1	Bandwidth	24
3.6.2	Traffic	24
<b>4</b>	<b>Setup</b>	<b>25</b>
4.1	Open a Local Session	26
4.2	Set Repeater Name (TAG)	27
4.3	TCP/IP and Ethernet Communication	28
4.4	Set-up RF Configuration	29
4.5	For Stand-alone Repeaters – Modem Communication	31



---

**PRODUCT DESCRIPTION AND USER'S MANUAL**

---

<b>4.6 AEM Addresses .....</b>	<b>31</b>
<b>4.7 Integration into the AEM.....</b>	<b>31</b>
<b>5 Troubleshooting .....</b>	<b>32</b>
<b>5.1 Module LEDs.....</b>	<b>32</b>
5.1.1 Control Module LEDs .....	32
5.1.2 F/O Converter.....	33
5.1.3 Power Supply LEDs .....	33
<b>6 Maintenance.....</b>	<b>35</b>
<b>6.1 General .....</b>	<b>35</b>
<b>6.2 Preventative Maintenance .....</b>	<b>35</b>
<b>6.3 Trouble Shooting.....</b>	<b>35</b>
<b>6.4 Component Replacement.....</b>	<b>35</b>
<b>6.5 Product Disposal.....</b>	<b>36</b>
<b>7 Modem Communication .....</b>	<b>37</b>
<b>7.1 Modem Initialization .....</b>	<b>37</b>
<b>7.2 Monitoring Modem Connection .....</b>	<b>37</b>
<b>7.3 Scheduled Modem Power Cycling.....</b>	<b>37</b>
<b>7.4 Communication via Wireless Modem .....</b>	<b>38</b>
7.4.1 Modem Configuration, not using GPRS .....	38
7.4.2 Modem Configuration, using GPRS .....	39
7.4.3 Configuration via PSTN (Fixed) Modem .....	41
<b>7.5 Troubleshooting Remote Communication .....</b>	<b>42</b>
7.5.1 Direct Modem Access .....	43
7.5.2 Trace Modem .....	43
7.5.3 Manually Answering Incoming Calls.....	44
7.5.4 Common Problems.....	45
<b>8 Specifications .....</b>	<b>48</b>
<b>8.1 Single Band Repeater MBF-S-7/8/9/17/18/19/22 .....</b>	<b>48</b>
<b>8.2 Dual Band Repeater MBF-D-9-22/8-19/7-17 .....</b>	<b>50</b>
<b>8.3 Tri Band Repeater MBF-T-9-18-22/8-17-19.....</b>	<b>52</b>



# 1 Introduction

Axell MBF (Multi Band Fibre) family of repeaters comprises of three types of fibre fed repeaters: single-band, dual-band and tri-band. The repeaters are available in various models supporting frequency bands LTE 700, 850, 900, 1800, 1900, 2200 and AWS.

The MBF repeater RF signal is supplied via an optic fibre connection to the Axell Optical Master Unit (OMU). The OMU is located at the Base Station RF signal source and converts the RF signal to an optical signal for routing to Repeaters via a fibre optic connection. Each OMU can support up to six repeaters. (The OMU is described in detail in the OMU User Manual).

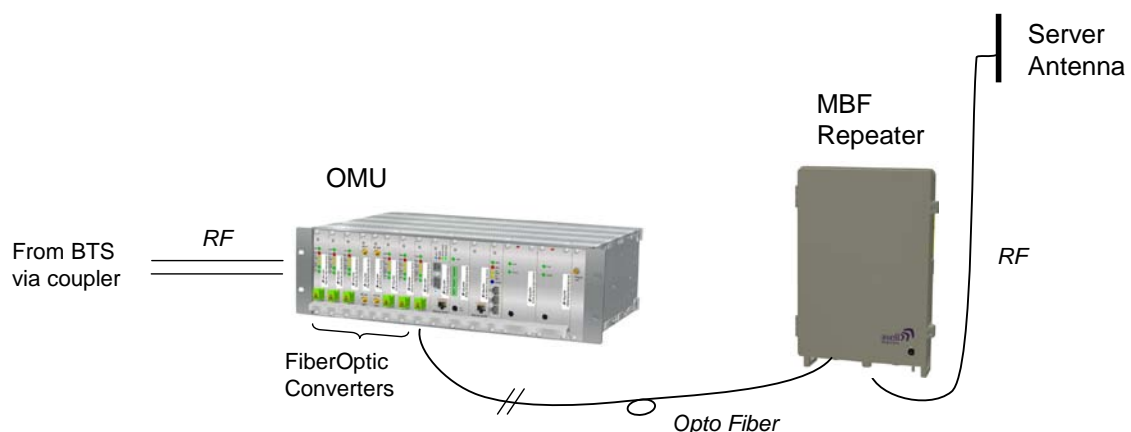

Figure 1-1 Standard OMU-Repeater application where one OMU is used

## 1.1 General Information on Installation Approach

- Single, dual and tri-band models supporting LTE 700, 850, 900, 1800, 1900, 2200 and AWS
- The Repeater door opens to provide access to internal connections
- The door is secured with two screws and a lock
- F/O, power and alarm connections are inserted via the panel interfaces and connected internally
- GND and RF service antennas are connected externally
- Local setup via RS232 connection is accessed internally
- Same mounting brackets are used for either wall or rack mount (different assembly positions)
- Backup battery for 'last gasp' modem indication (sending fault error before power failure)
- Can connect to either 110/230 VAC or -48V power

## 1.2 Models and Ordering Information

Each of the three MBF repeater types are provided in a wide range of models. The following tables list the most models available for single-, dual- and tri-band type repeaters.

**The models are named according to the following conventions:**

- Letters indicating number of bands: “S” (single band), “D” (dual band), “T” (tri band)
- Numbers indicating frequencies: “7” (700MHz), “8” (850MHz), “9” (900 MHz), “18” (1800MHz), “19” (1900 MHz), “22” (2100MHz) and “17” (AWS band).

Single Band	
MBF-S-7	LTE-700
MBF-S-8	GSM/WCDMA850
MBF-S-9	E-GSM
MBF-S-18	GSM1800
MBF-S-19	GSM/WCDMA1900
MBF-S-22	WCDMA2100

Dual Band	
MBF-D-9-22	E-GSM and WCDMA2100
MBF-D-8-19	GSM/WCDMA850 and GSM/WCDMA1900
MBF-D-7-17	LTE700 and AWS

Tri Band	
MBF-T-9-18-22	E-GSM, GSM1800 and WCDMA2100
MBF-T-8-17-19	GSM/WCDMA850, AWS and GSM/WCDMA1900
MBF-T-7-8-19	LTE700,GSM/WCDMA850,GSM/CDMA1900

## 1.3 Characteristics

The following table lists the Composite DL Output Power for the most common bands.

Composite output DL power per band	
Band	Composite Output DL Power
850MHz	+37 dBm
E-GSM	+37 dBm*
700MHz	+37dBm
1800MHz	+37 dBm*
1900MHz	+37 dBm
2100MHz	+39 dBm
Gain is defined by the whole link including the OMU	Adjustable in 1dB steps

*Note: In repeaters that share a common downlink fibre for 900MHZ and 1800MHZ a minimum of 4 carriers in each band is required for the full composite output power to be attainable maintaining full ETSI compliance.*

## 1.4 ALC

The repeater has a constant gain in both uplink and downlink paths. The gain is set by defining the attenuation as described above.

The repeater has a defined maximum output level. If the input signal amplified by the gain set exceeds the set output limit, an ALC (Automatic Level Control) loop is activated. This ALC ensures that the amplifier does not add distortion to the radio signal. Below are examples of the ALC function for one and two carriers.

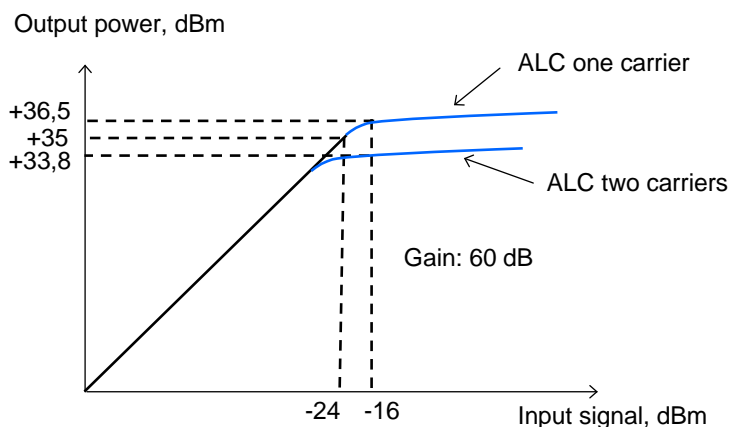

## 1.5 Operating Temperature

**Note!** The MBF repeaters are designed primarily for multi carrier purposes. If the repeaters are run at full output power over a longer period the convection cooling might not be enough. The repeaters have a power management function implemented that will step down the power and if needed fully shut down the amplifier chains until temperature has reached normal values. In situations where a repeater will be run in such a manner extra cooling can be provided for instance by putting the repeater in a temperature controlled environment or via external fans.

---

## 1.6 MBF Interfaces

The MBF unit provide three types of interfaces:

- Securing interfaces – lock and screws for security
- Panel connections to RF, communication and power
- Internal connections for local setup and for connecting optic fibres and power connections that are routed in from the

### 1.6.1 Securing the Unit

The repeaters are secured with two hex screws (M8) and can also be locked with a key.

**Note!** The two screws must be fully tightened. Failure to do so may affect the IP65 compliancy and therefore any warranty.

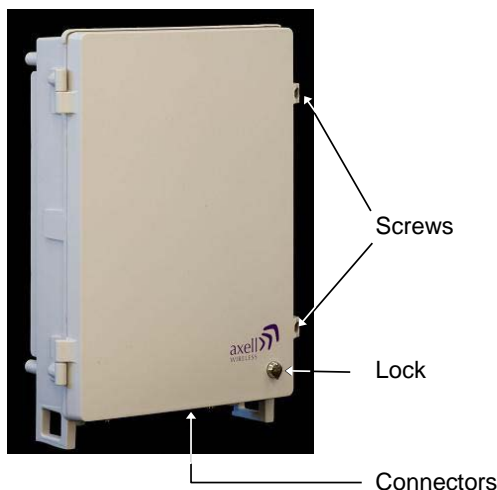

### 1.6.2 External Interfaces

The repeater's interfaces are located on the underside panel.

**Note!** The external connections at the bottom of the repeater can be protected with a cover which is screwed in place.

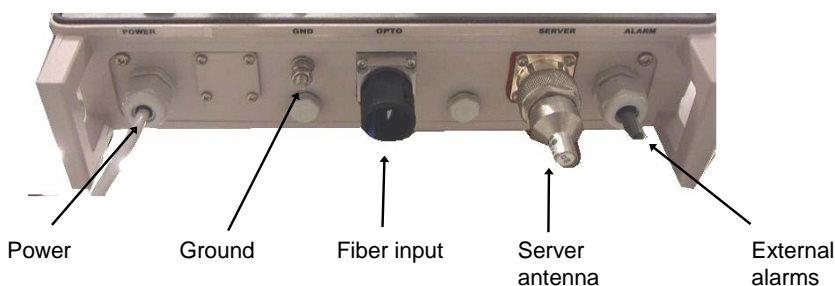

The following table provides a description of the front panel ports and connections.

Port	Description
Server	Service antenna connection - DIN 7/16" connector, female
Optic	SC/APC fibre optic connector through which the optic fibre is routed for internal connections (section 2.5).
Power	Plinth connection for routing power for internal connection (section 2.7)
Alarms	Plinth connector for routing external alarms and relay wiring cable for internal connections (section 2.6).
GND	Grounding lug (section 2.3)

**PRODUCT DESCRIPTION AND USER'S MANUAL**

**1.6.3 Internal Interfaces**

You will need to open the Repeater in order to:

- Connect power and optic fibres
- Connect alarms (if relevant)
- Power up the Repeater
- Connect to the LMT (RS232 connection) for local setup

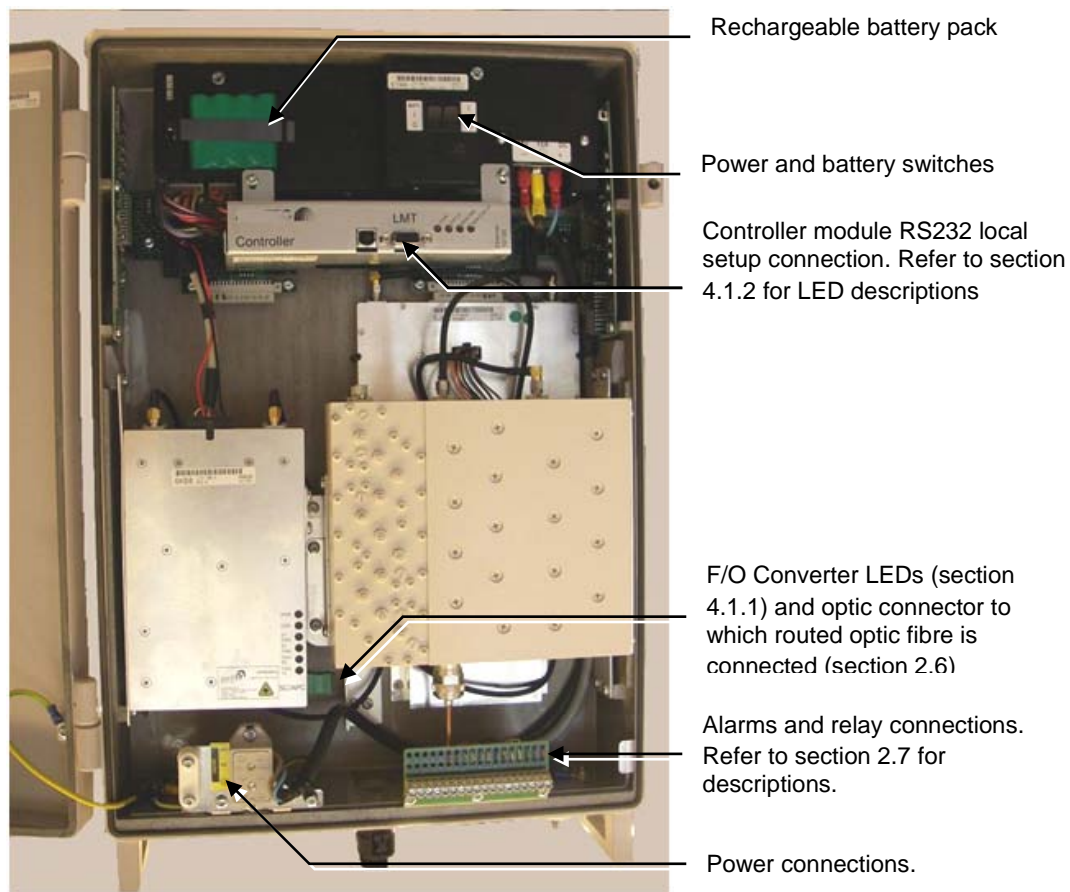

*1-2. Single band repeater with door open*

PRODUCT DESCRIPTION AND USER'S MANUAL

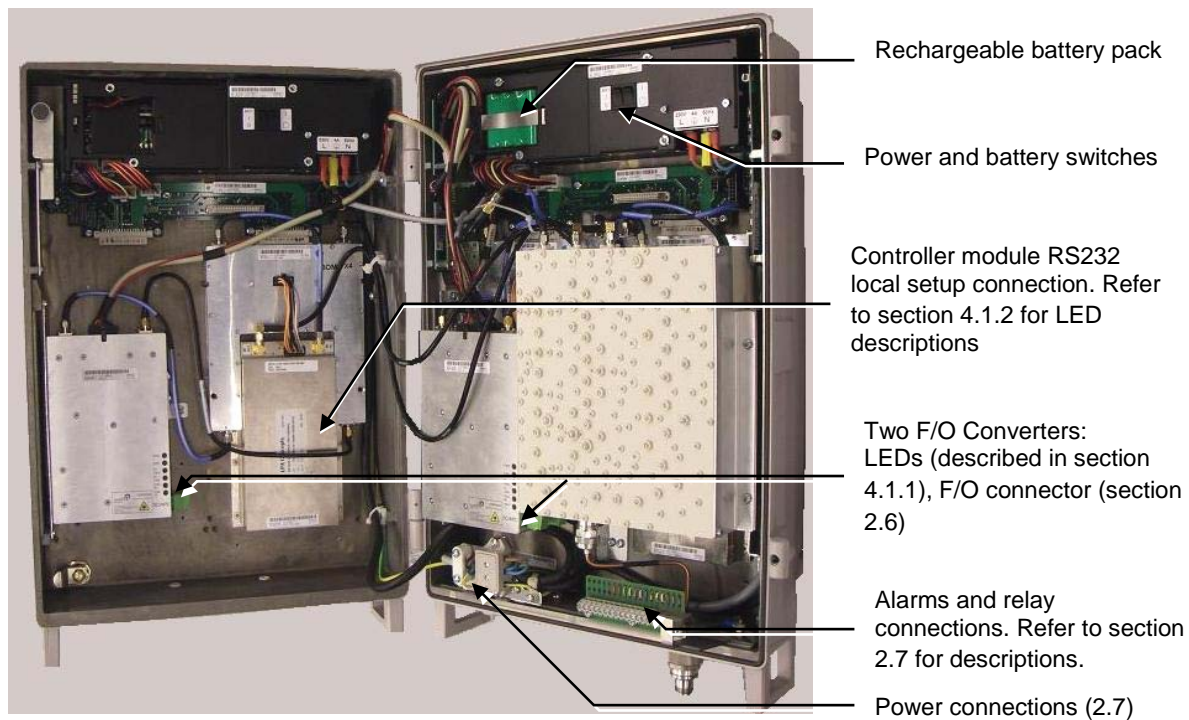

1-3. Dual-band MBF model



## 2 Installation

### 2.1 Unpacking

#### 2.1.1 Unpack the Unit

Inspect the shipped material before unpacking the equipment, document any visual damage and report according to routines.

A delivery of a repeater from Axell Wireless contains:

- Checklist with delivered items
- Repeater
- Mounting brackets
- 4 bolts for attaching repeater to mounting kit
- Cable cover
- Keys to repeater and inset tool for bolts
- Hose for fibre inlet
- CD containing User's Manual and RMC

Any other specifically ordered item

### 2.2 Mount the Repeater

Mount the repeater on a wall, on a pole or in a rack.

Mount the repeater in an accessible location and in a location that fulfils the environmental requirements.

The repeater can be mounted on the wall or in a 19 inch rack. The Repeater is delivered with mounting brackets.

The repeater needs to be mounted tightly to eliminate vibration.

*Mounting bracket position for wall mounting*

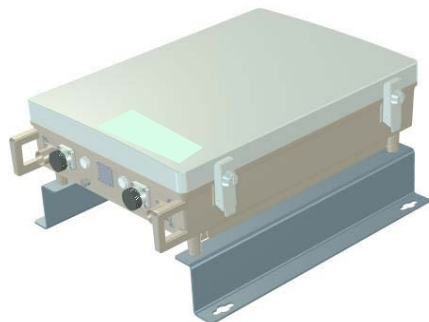

*Mounting bracket position for rack mounting*

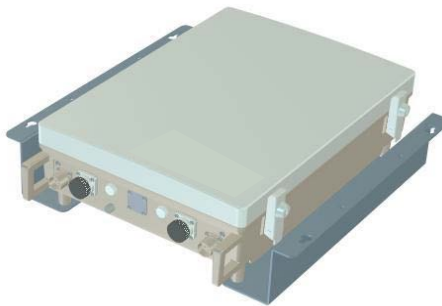

## 2.2.1 Ensure Proper Cooling

- Mount the repeater so that heat can be dispersed from it.
- The repeater wall mounting kit ensures an optimum airflow between the wall and the repeater itself.
- Do not block this air channel as it will cause the MTBF of the repeater to drop dramatically, or even in the worst case cause the repeater to fail completely.
- *If possible use a wall in the shadow to minimize the overall sun loading. If sufficient shielding cannot be obtained, an additional sun shield should be mounted.*



2-1. Example of a sun shield

## 2.3 Grounding

- Connect the grounding protection:
- Ensure that good grounding protection measures are taken to create a reliable repeater site.
- Make sure to use adequately dimensioned grounding cables. The minimum recommended conductive area for a grounding cable is 16mm<sup>2</sup>
- The antenna cabling should be connected to ground every 10m by a reliable grounding kit.
- Make sure the grounding product used is suitable for the kind and size of cable being used.
- Connect the repeater box bolt to the same ground.

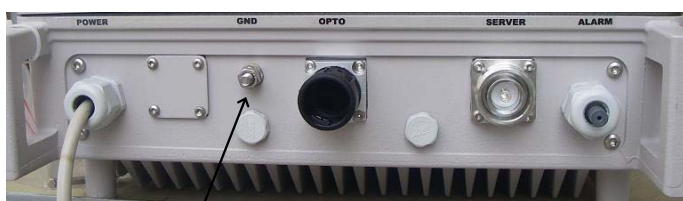
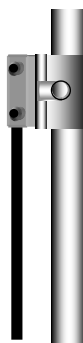

Ground

## 2.4 Ensure Good EMV Protection

**Caution**

If insufficient Electromagnetic Protection is provided, or if EMV measures are not taken, warranties issued by Axell Wireless are not valid.

**Connect the lightning protection**

The lightning hazard to electric and electronic equipment consists in the interferences of direct lightning current infections and high surge voltages induced by the electromagnetic field of nearby lightning channels or down conductors. Amplitudes from cloud-to-earth lightning amounts to several 10kA and may last longer than 2 ms. The damage caused depends on the energy involved and on the sensitivity of the electronics systems.

Ensure that lightning protection measures are taken to create a reliable repeater site. Protect all coaxial cables and power cables from the transients caused by lightning. Fit all cables with suitable lightning protection devices.

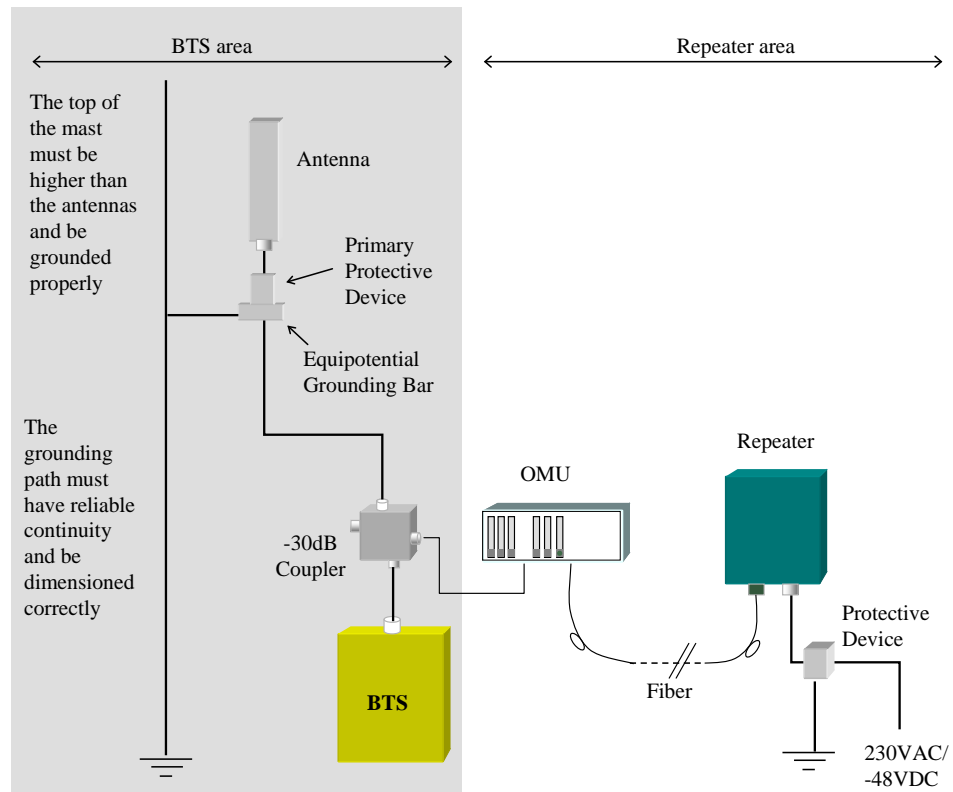

*Example of EMV protection for a repeater system*

For detailed information please refer to IEC 61024-1 and 61312-1 for international standards for protection of information systems against LEMP, Lightning Electromagnetic Pulse, including radio transmitters. They define proper planning, installation and inspection of effective lightning protection systems.

The Axell Wireless repeaters comply with the EN standard ETS 301 498-8 which stipulates demands on lightning/surge protection for typical infrastructure telecom equipment installations.

Several lightning protection devices should be used in series with declining threshold voltages to help attenuate the pulse component which makes it through the first layer of protection.

**PRODUCT DESCRIPTION AND USER'S MANUAL**

The primary protective device is part of the site installation and is not supplied by Axell Wireless. Coaxial lightning protection is normally one of these three types: Gas capsule, High-pass and Bandpass.

There also need to be a protective device installed on the power supply cord.



*Protective device installed in connection with the power supply*





## 2.5 Fibre Optic Connection

This product is equipped with class 3B lasers, as per definition in EN 60825-1.

	<p><b>Caution!!!</b></p> <p>Un-terminated optical receptacles may emit laser radiation. Do not stare into beam or view with optical instruments.</p>
---	--

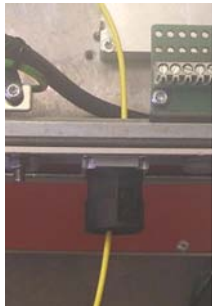
Use the following over the complete link between the Repeater and OMU:

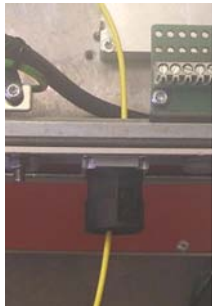
- Use angled APC connectors at 8deg angle
- APC type ODF connections
- Mono-mode type fibre

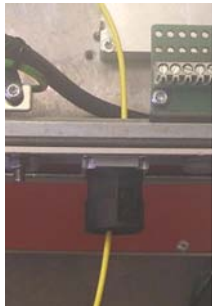
<p>Select fibre</p>  <p>Connect the fibre</p>	<p>Recommended fibre cable is single mode 9/125.</p> <p>The casing of the repeater is equipped with an inlet. The inlet is designed to go with a corrugated hose, which is included in the shipment. The hose, together with the rubber seal meet the protection standard IP65.</p> <table border="0" style="width: 100%;"> <tr> <td data-bbox="443 1512 619 1816" style="width: 30%; vertical-align: top;"> <p>1. Run the fibre through the hose</p> </td> <td data-bbox="635 1512 852 1816" style="width: 30%; text-align: center;">  </td> <td data-bbox="906 1512 1066 1816" style="width: 30%; vertical-align: top;"> <p>2. Run the fibre through the inlet in the repeater</p> </td> <td data-bbox="1082 1512 1294 1816" style="width: 30%; text-align: center;">  </td> </tr> </table>	<p>1. Run the fibre through the hose</p>		<p>2. Run the fibre through the inlet in the repeater</p>	
<p>1. Run the fibre through the hose</p>		<p>2. Run the fibre through the inlet in the repeater</p>			

PRODUCT DESCRIPTION AND USER'S MANUAL

Make necessary measurements

3. Connect the fibre to the Fibre Optic Converter inside the repeater

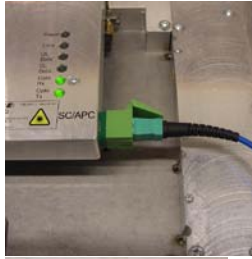

5. Adjust the fibre length inside the repeater and insert the seal into the inlet



4. Place the fibre in the rubber seal



6. Attach the hose to the inlet

**Note!** Make sure the fibre is not bent too sharply inside the repeater. There is room under the optic module to allow for some slack of the fibre.

**Note!** To insert and extract the hose from the inlet press the side levers.

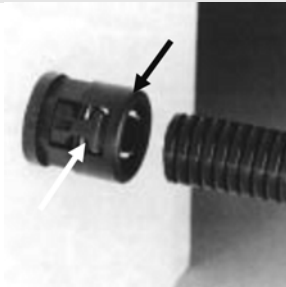

Make necessary measurements to ensure a correct installation. When the cable has been installed, the quality of the optical path should be checked for optical path loss and magnitude and location of any reflections. This can be done with an Optical Time Domain Reflectometer (OTDR). The total return loss should be > 45 dB. Optical reflections can degrade the noise and linearity of a fibre optic link. In particular, reflections that reach the laser can be a problem. Keep all discrete reflections to > 60 dB. The SC/APC connectors are polished to a return loss >60 dB.

Attach the fibre to the fibre optic converter inside the repeater.

**Note!** Clean the fibre connector before it is connected, see instruction below.

### 2.5.1 Cleaning Optical Connectors

Optical reflections from a discontinuity such as a poor connector interface appear on an RF spectrum analyzer trace as stable variations in the noise floor amplitude that are periodic with RF frequency. If the reflection is bad enough, it could impact the system performance. By far, the most common cause for a large discrete reflection is a dirty optical connector. A bit of dust or oil from a finger can easily interfere with, or block this light. Fortunately, it is very easy to clean the connector.

Be sure to use the correct procedure for the given connector. When disconnected, cap the FC/APC connector to keep it clean and prevent scratching the tip of the ferrule.

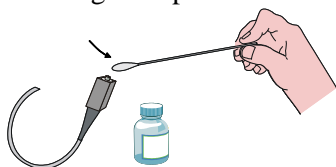

#### Alternative 1

Swipe the tip of the ferrule 2-3 times with a cotton swab soaked in alcohol. Let it air dry.



#### Alternative 2

Use a product specially designed for the purpose.

## 2.6 External Alarm and Relay Connections

The repeater is equipped with an external alarm interface card. The connector plinth for the external alarms is located at the bottom of the repeater.

The strain relief fitting in is a Pg 13.5 suitable for a 6-12 mm cable diameter.

Connect the alarm cords to the plinth according to the pin layout below (in the standard version pins 14 – 18 are not used).

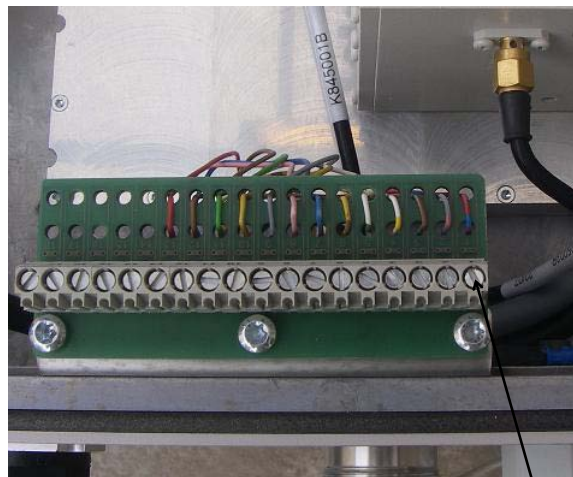

Pin 1

Pin #	Signal
1	External alarm 1A
2	External alarm 1B
3	External alarm 2A
4	External alarm 2B
5	External alarm 3A
6	External alarm 3B
7	External alarm 4A
8	External alarm 4B
9	Alarm +15V
10	Alarm 0V
11	Relay Output 1A
12	Relay Output 1B
13	GND
14	NC
15	NC
16	NC
17	NC
18	NC

### 2.6.1.1 External Alarm

- Four external alarm sources can be connected to the repeater.
- Alarm operating voltage: between 12 and 24VDC.
- Alarm polarity can be configured:
  - Active-low - when there is no voltage the alarm indicator will turn red
  - Active-high - an applied voltage of between 12 and 24 V will cause the external alarm indicator to turn red.
- The repeater can supply +15 VDC to an external alarm source through pin 9 and 10. The maximum allowed load is 100mA.

### 2.6.1.2 Relay

- Relay (pin 11 and 12) can be connected to an external device to indicate an alarm.
- Can be configured to trigger on any number of internal and external alarms. The maximum current that can be supplied is 100mA.

## 2.7 Power and Backup Battery

### Caution!

**Make sure the antenna cables or 50 ohm terminations are connected to the repeater's antenna connectors before the repeater is turned on.**

The image below shows the location of the various power elements. These are described in detail in the following sections.

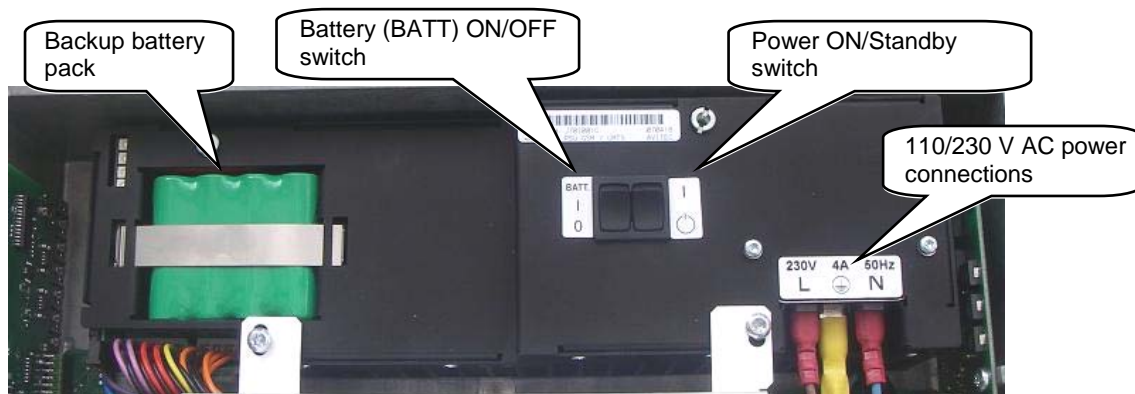

2-2 Power Elements Inside Repeater

### 2.7.1 Connecting the Power Source

- Power Source: 230 VAC 50 Hz, 115 VAC 60 Hz or -48 VDC
- The -48VDC version of the power supply is designed to turn off if the supply voltage falls below -36V ( $\pm 1V$ ). It will turn on again as the supply voltage reaches -43V ( $\pm 1V$ ).
- The power supply has a switch which allows it to be set in “on” position or in “stand by”.

#### Note!

- In the stand by position the repeater is still connected to the power supply but not operational.*
- On repeaters mounted in an extended box with two power supplies, both power supplies needs to be switched on.*



**PRODUCT DESCRIPTION AND USER'S MANUAL**

**2.7.2 230 VAC Power Source**

Connect the power cable to the plinth as show below:

- **Phase** linked to the **brown** cable
- **Neutral** linked to the **blue**
- **Ground** to the **yellow/green**. See illustration below.

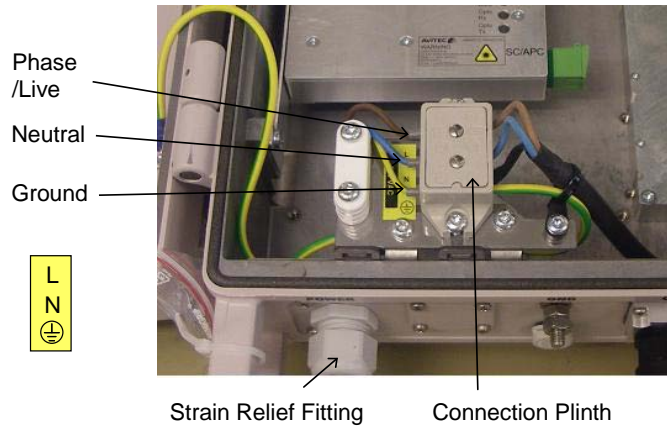

### 2.7.3 -48V Power Source Connection

**Note:** The -48VDC version of the power supply is designed to turn off if the supply voltage falls below -36V ( $\pm 1V$ ), not to drain the feeding battery. It will turn on again as the supply voltage reaches -43V ( $\pm 1V$ ).

#### -48V power supply requirements

The 48VDC power supply must comply with SELV requirements, as defined in EN60950, which implies double isolation. The output power needs to be 48VDC +25%/-15%. The maximum input current is 8A.

#### Connect the power cable to the plinth with:

- Negative (-48V) to the **uppermost** connection
- Positive (0V) to the **lower** connection.
- Do NOT connect the middle connection.

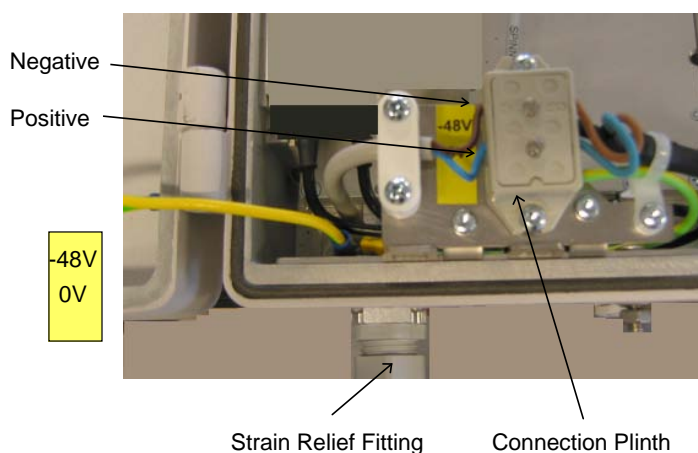

#### Recommended cable areas for 48VDC

Distance	Cable Area
0 - 10 meters between repeater and power supply	2,5 mm <sup>2</sup>
10 – 50 meters between repeater and power supply	4 mm <sup>2</sup>
Over 50 meters between repeater and power supply	Recommendation is to reconfigure the installation, or to make special arrangements to increase cable area

**PRODUCT DESCRIPTION AND USER'S MANUAL**

**2.7.4 Backup Battery**

- On the Power Supply unit a rechargeable battery pack is mounted. This part also includes charging and supervision electronics.
- The backup battery will provide the Control Module and modem with enough capacity to send an alarm in case of input power failure.
- The battery can be switched on and off. The switch is placed adjacent to the main power switch on the power supply.
- At delivery the back-up battery is connected.
- The battery is replaced by lifting the battery pack out of the crate and disconnecting the cable.

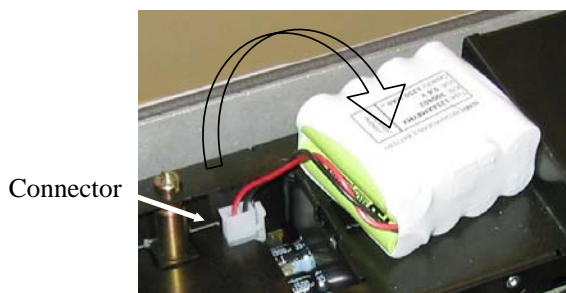

**2.8 Power ON**

**2.8.1 Switching Power ON**

**Caution!**

Make sure the antenna cables or 50 ohm terminations are connected to the repeater's antenna connectors before the repeater is turned on.

Switch the repeater on by using the power switches on the power supply.

**Note!** See caution above!



*There are two switches. One is for the battery and one is for the power*

The rightmost switch is the one that switches the main power. The leftmost is for turning the battery on/off.

**Note!** The power switch has two positions; “on” and “stand by”. In the stand by position the repeater is still connected to the power supply but not operational.

**Note!** On repeaters mounted in an extended box with two power supplies, both power supplies need to be switched on.

## 2.8.2 Verifying LEDs

Verify the LEDs from the following modules are indicating correct operation (5.1):

- Control module
- F/O converter
- Power supply modules

## 2.9 Closing and Securing the Repeater

Close lid, **tighten screws** and lock repeater, or continue with the next section: Start-up the Repeater.

---

**Note!** *The two screws must be fully tightened. Failure to do so may affect the IP65 compliancy and therefore any warranty.*

---

## 3 Commissioning Advice

To set the proper operating RF levels on the repeaters in the MBF family during commissioning there are six steps to be carried out for each band of operation.

- ◆ Set OMU DL attenuation to adjust the RF level from the BTS to suit the fibre optic converter in the OMU (UFO-M)
- ◆ Run the OLA (Optical Link Adjustment) command for each band to correct for DL optical fibre loss
- ◆ Set the DL attenuation in the repeater to adjust gain following fibre optic converter in the repeater (UFO-S)
- ◆ Set the UL attenuation in the repeater to adjust gain before the fibre optic converter in the repeater (UFO-S)
- ◆ Run the OLA (Optical Link Adjustment) command for each band to correct for DL optical fibre loss
- ◆ Set OMU UL attenuation to adjust the OMU output level to suit the BTS

### 3.1 Signal Diagrams

In the downlink the signal from the OMU enters the fibre optic converter in the repeater that translates the optical signal to RF. The signal is fed to the Radio Modules. The signals are amplified in the Radio Modules and further in the separate MCPAs. It is then fed to the combined duplex filter and out on the server port to the antenna.

In the uplink the signal is amplified in the Radio Modules and translated to an optical signal and fed back to the OMU.

A tri band repeater works in a corresponding way.

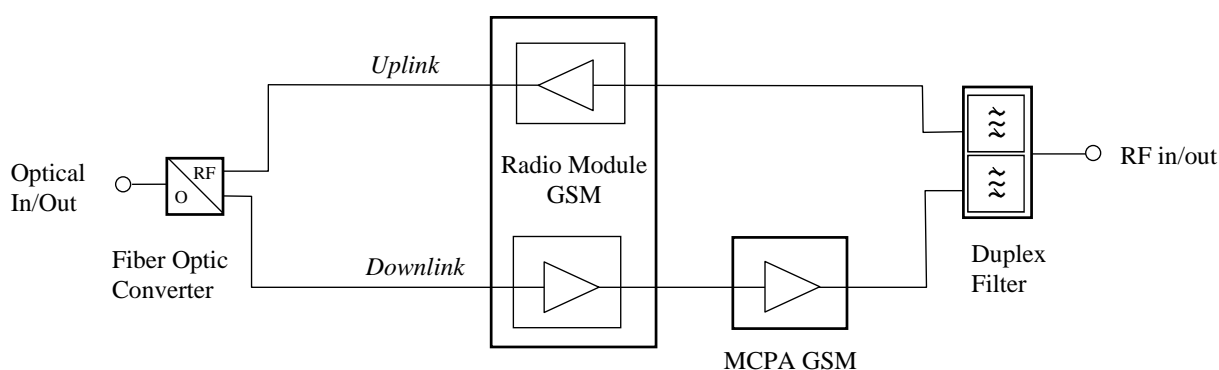

3-1. Single band repeater for E-GSM

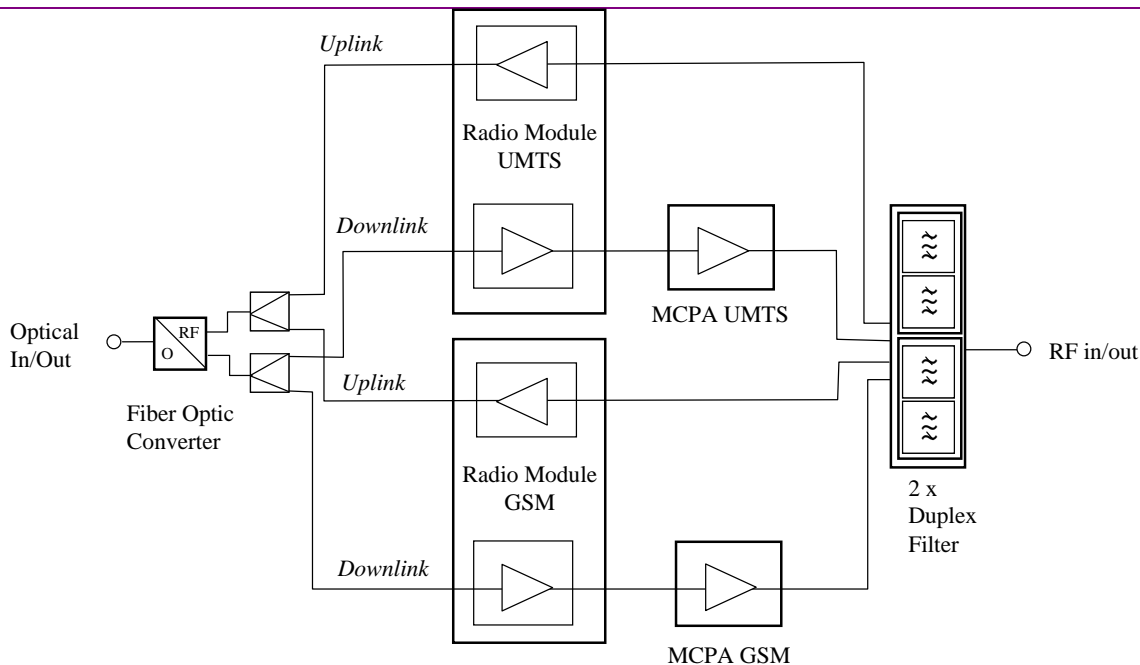

3-2. Dual band repeater for E-GSM and UMTS

## 3.2 OMU Point of Interface (POI)

The OMU will usually be fed from the donor BTS via an attenuator or coupling network. The electrical configuration of this OMU Point of Interface (POI) will be system specific depending on the presentation of the BTS RF ports, the power class of the BTS and whether the BTS itself provides coverage via antennas/radiating cable infrastructure or if coverage is only via the MBF repeaters. The important consideration for commissioning is that the correct attenuation exists between BTS and OMU in order that

- ◆ input power limits of OMU ports are not exceeded
- ◆ operating levels can be brought into the correct range using the OMU internal attenuators
- ◆ isolation is preserved between ports and bands

OMU damage levels are 10dBm RF in to the fibre optic converter.

For some systems the commissioning adjustments may be completely independent (e.g. an MBF Tri Band repeater fed by separate OMUs, one per frequency band). For other systems (e.g. an MBF Tri Band repeater fed by a single OMU carrying all three bands) one adjustment may affect all bands simultaneously. In such cases certain commissioning actions e.g. optical link adjustment only need to be carried out once for all bands but the POI must include some means to level the different frequency bands at the OMU interface ports.

## 3.3 Downlink POI / OMU DL Attenuator Adjustment

The critical aspect for the correct system operating level is the composite power presented at the input of the fibre optic converter in the OMU (UFO-M). The illustration below shows the simplest possible arrangement for a single Tri Band repeater fed by three BTSs - one per band. It is assumed that the BTS for GSM900 and GSM1800 produce two carriers each of +43dBm and that the UMTS BTS produces a single carrier of +43dBm.

PRODUCT DESCRIPTION AND USER'S MANUAL

The correct interface level at the optical fibre converter is -5dBm/carrier in 900MHz and -7dBm/carrier in both GSM1800 and UMTS bands. An attenuation of 48dB in 900MHz and 50dB in 1800/UMTS is therefore required between them.

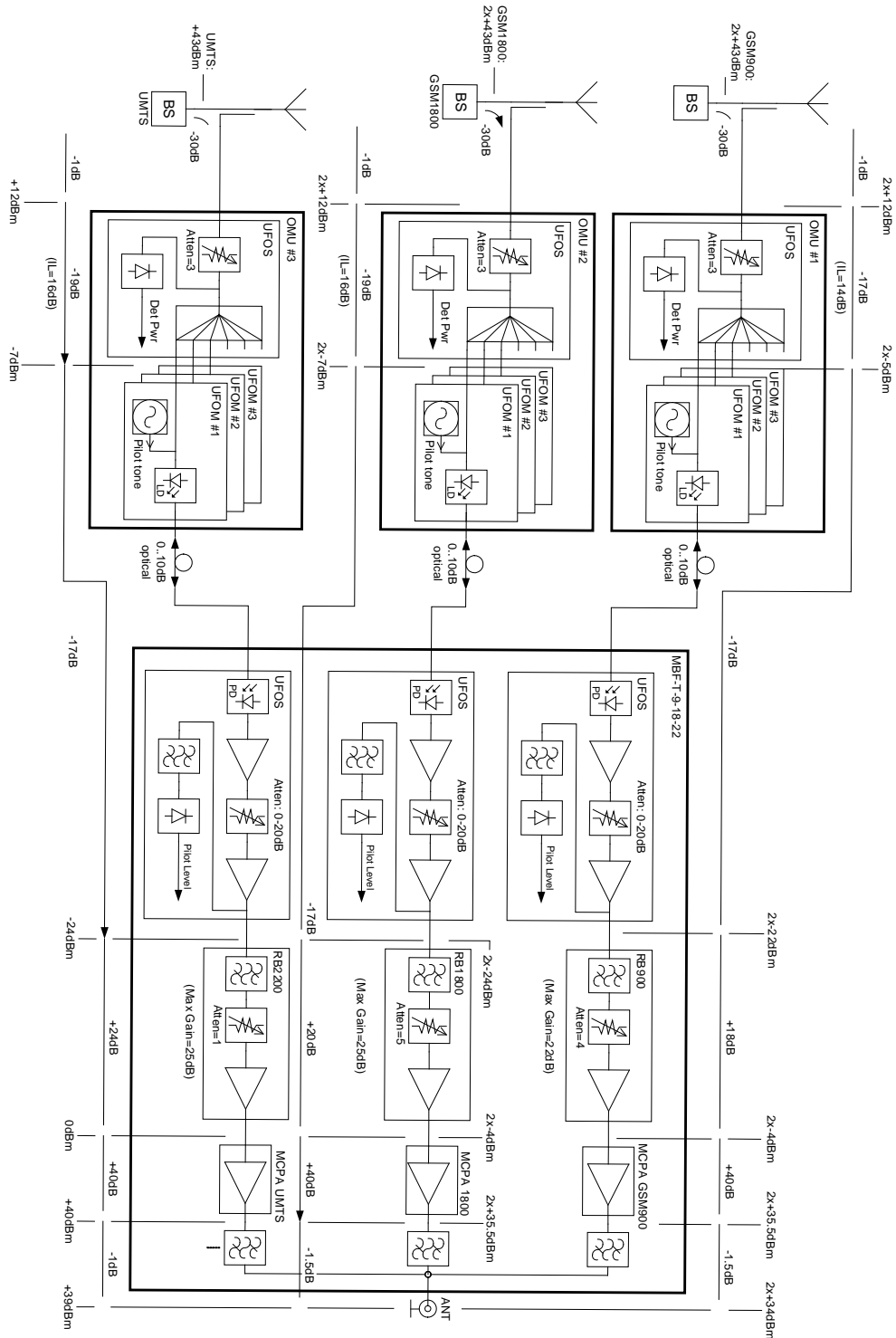

It must also be kept in mind that the OMU might have separated input/output ports for each band (UL/DL) while the interface with the BTS may well be duplex. In that case some duplexing network must be provided to allow these to be brought together. If there is more than one operator's BTS per band the loss of any combining network and any equipment room cabling also becomes part of the overall attenuation required to reach the correct interface level in each frequency band.

The illustration on the next page shows a more complicated arrangement where the same three BTSs feed multiple MBF repeaters (up to 6 is possible using the standard splitter card which fits the OMU rack). In this case an OMU per frequency band is shown. The internal splitter has an insertion loss of 14 or 16dB depending on frequency band. This loss is again a contribution to the overall attenuation which must be provided between BTS and the input ports of the UFO-M for the correct operational levels to be achieved.

The interface levels must be modified to maintain the same composite power if a greater number of carriers is to be applied from the BTS.

The DL POI / OMU Adjustment must be made considering the fully loaded condition – e.g. a BTS capacity of 8 carriers must include a back off of 6dB compared to the 2 carrier level and -11dBm/carrier is then the correct UFO-M drive level for GSM 900. The same rule for back off applies in other bands.

Note that a UMTS BTS at idle (no traffic) will be radiating only a pilot – approx -10dB compared to the average power when it is in traffic. See also section about UMTS Signal Measurement below.

### 3.4 Repeater Downlink Optical Link Adjustment (OLA)

The optical link between the UFO-M of the OMU and the UFO-S in the repeater is equipped with a calibrated pilot tone transmitter/receiver which enables compensation for the loss of the optical fibre plant between them.

The OLA procedure requires a computer running Axell RMC software and an RS232 connection to the LMT Port of the repeater controller.

Start the RMC and login to the repeater as described in the appropriate section of the handbook. Click on the Actions tab on top of the RMC screen. A drop down list will appear where a command will be found to execute the optical link adjustment for each UFO-S module that is fitted to the repeater.

Click the command for the desired optical link and following a short delay (2-3 secs) an information screen will be shown describing the result of the automatic setup process.

This procedure is described in the *OMU Manual* section 4.10.

### 3.5 Downlink Repeater Gain Adjustment

When the DL POI levels and the repeater optical links have both been set up as described in the foregoing the MBF repeater set at maximum gain should produce a composite signal level at the output connector of +37dBm for GSM900 and 1800 and +39dBm for UMTS.

The RMC provides sub screens for each band where the downlink power from UFO-S optical receiver /input to the DL radio board and the composite output power level from the MCPA can be viewed.

The power amplifier for each frequency band can be enabled /disabled and the preset DL attenuation in the radio board for each band can be adjusted. A saturation status indicator (red/green) shows whether the radio board ALC is in operation. This indicator should be green. A red indication indicates overdrive the cause of which should be investigated and rectified.

In each band the DL output power per carrier should be measured using a spectrum analyzer.

Allowing for the maximum DL carrier quantity in each band the composite level per band under full loading should be calculated to ensure it does not exceed the rated maximum otherwise ALC will be in operation when traffic levels are high. See also section about UMTS Signal Measurement below.



PRODUCT DESCRIPTION AND USER'S MANUAL

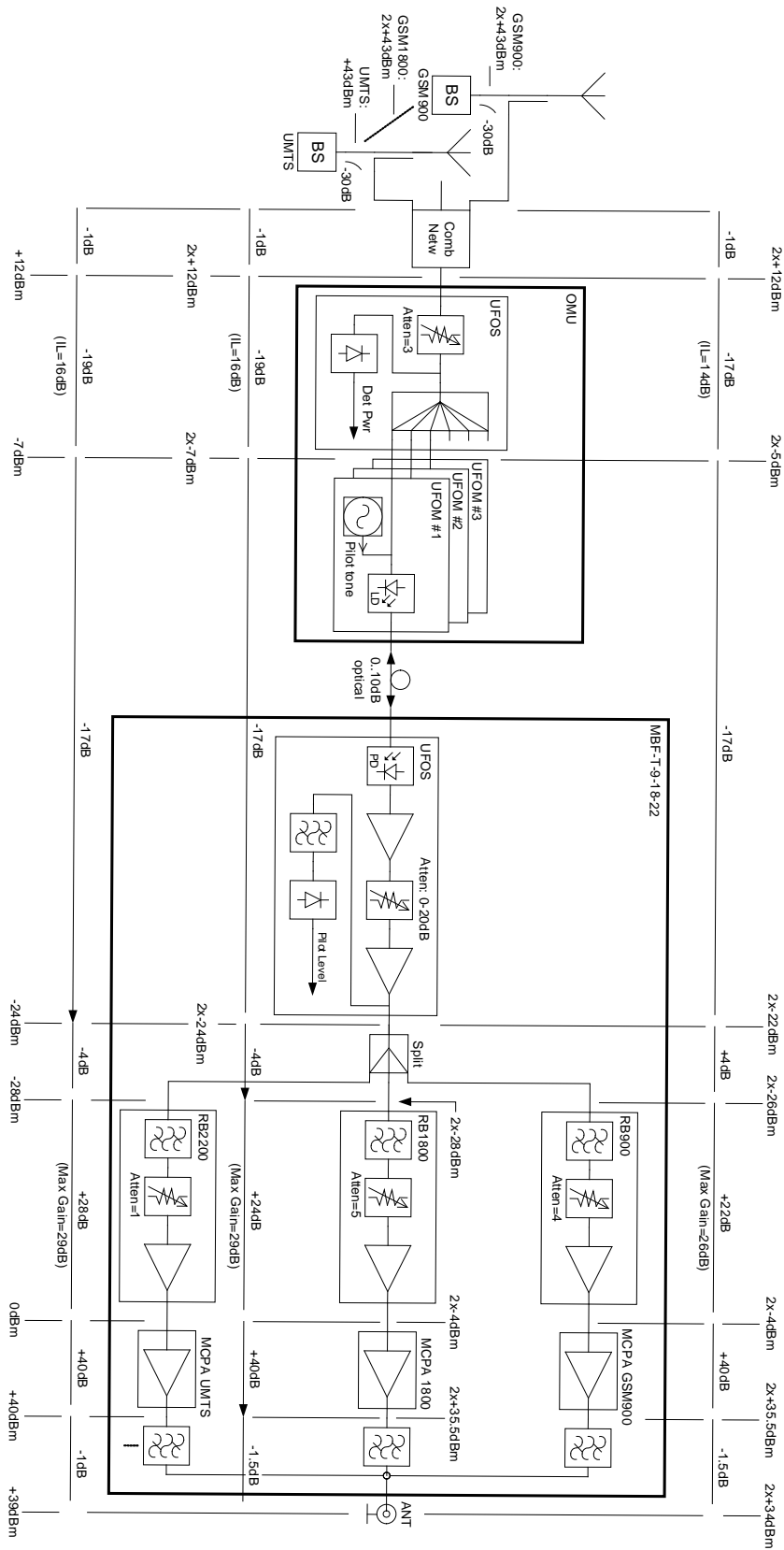

## 3.6 UMTS Signal Measurement

The UMTS signal carries wideband and complex modulation and its properties vary depending on the level of traffic carried.

### 3.6.1 Bandwidth

The first issue is the wideband nature of the signal. It occupies around 3.8MHz and measurements through a narrower filter will reduce the apparent power level since only a portion of the signal reaches the detector in the test equipment.

Equipment that includes a UMTS/3G measurement personality simplifies the task considerably. Usually a stored configuration for power measurement will integrate many samples taken using a narrower filter to display the correct power level for the bandwidth of the signal. Settings can easily become corrupted however leading to erroneous results. In such cases following the manufacturers instructions in detail is advised.

Measuring with a simple spectrum analyzer must use a wider resolution bandwidth than 3.8MHz or else a bandwidth correction factor has to be applied to the observed result. E.g. if measuring with a 300kHz RBW the power level in the centre of the signal would appear to be around 11dB lower than actual ( $10\log 3.84/0.3$ ).

### 3.6.2 Traffic

A further complication is that the power level of a UMTS signal depends on the traffic level being carried. UMTS carrier power is usually quoted as average values e.g. a 5Watt or 37dBm signal can contain peaks up to 10dB greater when traffic is high. An idling base station carrying no traffic radiates only a Pilot in which case the power observed is around 10dB below the average value with traffic.

Advanced test equipment that can measure the different code power components in the UMTS signal avoids this problem but more often in the field repeater commissioning must be done when only simple test equipment is available. This leads to the need to know and allow for the state of traffic when making repeater setup and diagnostic measurements. It is obvious that adjusting a repeater to maximum rated output power by using BTSs that are idling radiating only the pilot will lead to overloading when they are in traffic.

## 4 Setup

## 4.1 Open a Local Session

Connect to the LMT port

Connect the computer to the LMT port via a DB9 male connector with serial RS232 interface.



LMT Port

Select "Cable" connection and communication port

The communication parameters are set automatically by the RMC

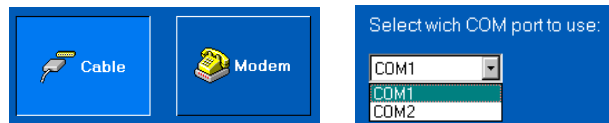

Enter user name and password



Several users at a time can be logged on to a Repeater, for instance one locally via the RS232 interface and one remotely via modem or Ethernet. There is one default user name and password defined for the repeater..

User Name	Password
avitec	AvitecPasswd

**Note!** Both the user name and the password are case sensitive.

**Note!** Do not use the number pad when entering numbers.

**Note!** Failed login attempts are logged. Default maximum number is 8. It is decremented by one every hour, which means that it takes one hour after the last failed attempt before a new try can be made.

PRODUCT DESCRIPTION AND USER'S MANUAL

The Console mode view appears

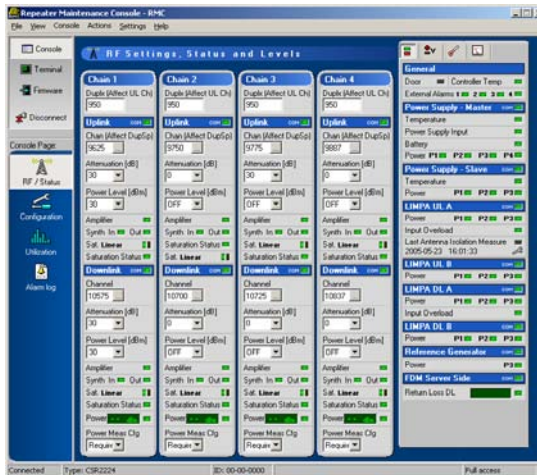

The console mode displays a large number of repeater parameters and contains a number of console pages. It adjusts its user interface to adapt to the features of the connected repeater.

## 4.2 Set Repeater Name (TAG)

The TAG can be chosen freely to give the repeater a name that is linked to the location, the site name, etc. The TAG may contain up to 30 characters including spaces.

Select "Configuration" and "Product"



Insert the repeater's name (TAG) in this box.

General	
Model	MBF-S-9-S
Serial number	6N6Y
Article number	A2020002A
TAG	<input type="text" value="Repeater/Site Name"/>
<input checked="" type="checkbox"/> Lock TAG	
ID	<input type="text" value="01-09-6N6Y"/>
Manufacturing info	AVITEC
System init. time	2008-07-04 00:34:31
System up time	5 days, 9 h, 50 m, 19 s
Current Date	<input type="text" value="2000-01-26"/>
Current Time	<input type="text" value="22:23:38"/>

**Note!** Do **not** assign an ID. The AEM will do this automatically when the repeater is integrated in the AEM.

### 4.3 TCP/IP and Ethernet Communication

A TCP/IP communication is run over a company's network. Therefore each company needs to define the details regarding the configuration, IP addresses, etc. For more information please refer to *Common Commands and Attributes*, section 13 Network Configurations.

Select "Configuration" and "Communication"

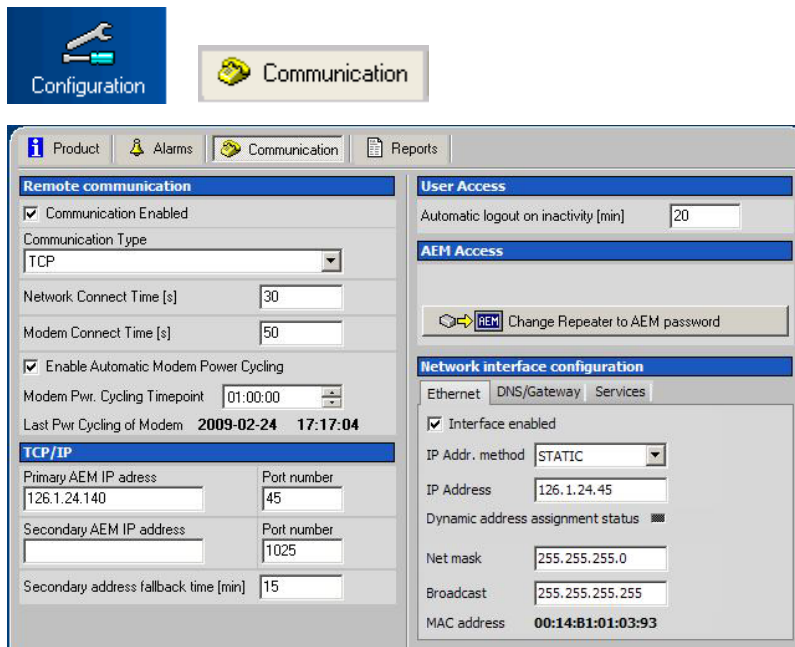

Set IP address and other relevant information here

In these screens the Ethernet and/or DNS Gateway parameters can be set

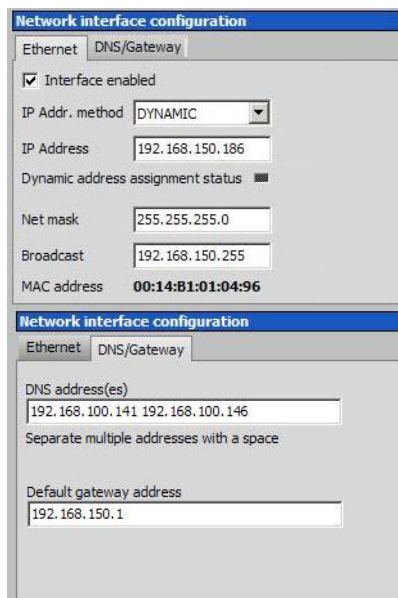

## 4.4 Set-up RF Configuration

Configuration of the repeater amplification can be made locally. If the repeater is connected to an OMU the configuration can also be made via this OMU. See *OMU User's Manual*.

**Note!** This is an example from a single band repeater. Other repeaters will have similar features.

Ensure online communication with the repeater

Alarms and general information

Uplink attenuation

Uplink input and output power

Downlink attenuation

Downlink input and output power

Check that the fibre is OK

Set attenuation level in uplink and downlink to a maximum

Select "RF/Status" window

*This shows a single band repeater with no RF signals*

Make sure there are no alarms relating to the fibre.

Choose the maximum attenuation value from the drop down menu.

Attenuation  
 15

Configure the downlink

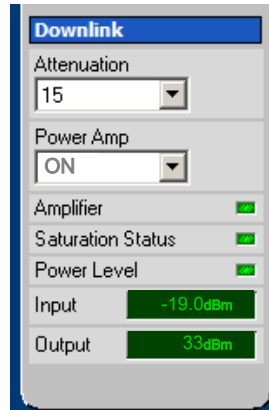

Lower the attenuation level step by step until the desired output power level is reached. In this example +33 dBm. Zero attenuation is the same as maximum gain.

**Note!** Please also consult the OMU User's Manual.

Initiate a fibre loss elimination

This is done from the OMU by sending a pilot tone to the repeater and calculating the loss in the fibre link. This loss is compensated for automatically. The system will behave as if there is no loss at all in the fibre link.

Configure the uplink

In the uplink direction the attenuation needs to be set based on a measurement of a known signal which is transmitted through the repeater and the OMU as well as the fibre. There are two ways of performing this measurement.

Alternative 1

Use a signal generator to insert a signal of approximately -70dBm into the repeater's server antenna port. Measure the signal level on the BTS or on the coupler and adjust the attenuation so that the total gain in the uplink is close to 0dB. (At 0dB gain the signal level at the coupler should be -40dBm and on the BTS -70dBm in this example.)

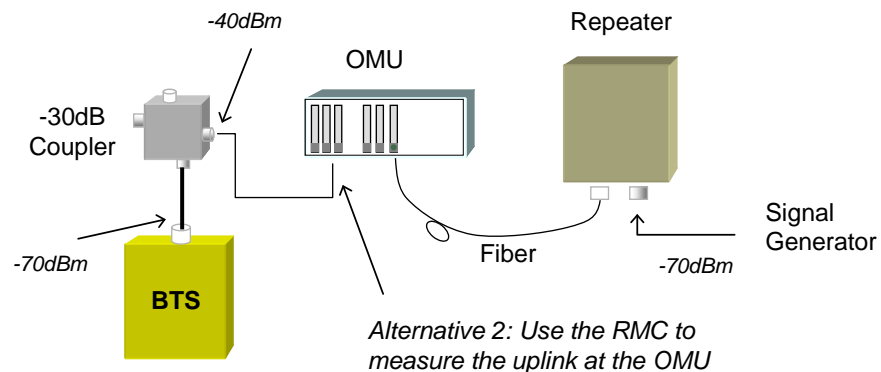

Alternative 2

Use a signal generator to insert a signal of approximately -70dBm into the repeater's server antenna port. Log into the OMU and monitor the uplink via the RMC. This measurement is not as accurate as alternative 1.

**Note!** If several repeaters are connected to the same OMU the total gain in each chain should be slightly lower than 0dB not to insert too much noise into the BTS.

For in-depth instructions for commissioning of an OMU-Repeater system please contact your Axell Wireless representative.

*Note!*



## 4.5 For Stand-alone Repeaters – Modem Communication

**MODEM communication is relevant only for Repeaters installed in stand-alone mode.** If the repeater is fibre fed and is set up as a slave- this section is not relevant since the remote communication is handled by the node master – in most cases an OMU.

For instructions on modem setup and communication, refer to Chapter Modem Communication.

## 4.6 AEM Addresses

The Control Module can be configured with two different addresses (telephone numbers) to which alarms and reports are delivered. In case the repeater cannot deliver alarms and reports to the primary address, the next call will be made to the secondary address.

A fallback functionality is available, which means that the Control Module falls back to the primary address after a configurable number of minutes. If this interval is set to 0, the fallback will not be performed. A user can always force the Control Module to fall back to the primary address.

**Note!** When the repeater is integrated to the Axell Element Manager system, these addresses are set by the AEM, why they need not be configured during site installation.

## 4.7 Integration into the AEM

When the repeater has been installed at site and the remote communication has been enabled, the repeater can be integrated to the Axell Element Manager. This is done by the operator of the AEM. After entering the telephone number to the repeater, the AEM dials up the repeater, downloads all the repeater parameters and statuses into a database. When all parameters have been downloaded, the AEM configures the repeater with the telephone number where alarms and reports should be sent, and optionally with a secondary telephone number where the repeater can dial in case connection to primary number fails.

When heartbeat reports and alarms are sent from the repeater to the AEM also the latest information about the status and RF-configuration is included. This means that the AEM operator always has information about the current status in the AEM database (and do not need to call the repeater to find this out).

**Note!** Once the repeater is integrated to the AEM, all changes to the repeater should preferably be done from the Axell Element Manager in order to ensure that the database always contains correct information.

# 5 Troubleshooting



## 5.1 Module LEDs



### 5.1.1 Control Module LEDs

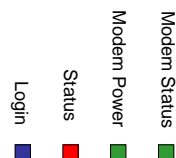

The Control Module has four LEDs which give information regarding the status of the OMU.











If the OMU is configured for Ethernet communication the two LEDs Modem Power and Modem Status do not fill any function and can be disregarded.

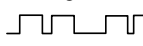

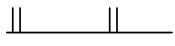
Blue LED - Login		
	Quick flash	Control Module switched on, someone logged in locally and/or remotely
	Off (except for a quick flash every 10th second)	Control Module switched on, no one logged in
	Off (permanent)	Control Module switched OFF

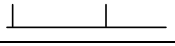
Red LED - Status		
	Quick flash	Control Module switched on, one or more errors/alarms detected
	Off (except for a quick flash every 10th second)	Control Module switched on, status OK
	Off (permanent)	Control Module switched off

Green LED – Modem Power		
	On	Modem Power is on
	Off	Modem Power is off

Green LED – Modem Status		
	On	Depending on type of call: Voice call: Connected to remote party Data call: Connected to remote party or exchange of parameters while setting up or disconnecting a call
	Flashing  (irregular)	Indicates GPRS data transfer. When a GPRS transfer is in progress the LED goes on within 1 second after data packets were exchanged. Flash duration in approximately 0.5s.
	75ms on/75ms off/75ms on/3s off 	One or more GPRS contexts activated
	75ms on/3s off 	Logged to network (monitoring control channels and user interactions). No call in progress
	600ms on/600ms off 	No SIM card inserted, or no PIN entered, or network search in progress, or ongoing user authentications, or network login in progress
	Off	Modem is off

**PRODUCT DESCRIPTION AND USER’S MANUAL**

### 5.1.2 F/O Converter

There are 6 LEDs on the module to indicate the status.



LED 1, Power, Green	
On	Unit is powered on
Off	Unit has no power
LED 2, Error, Red	
On	Error detected
Off	No error
LED 3, UL Data, Yellow	
On	Communication is ongoing in the uplink direction
Off	No communication
LED 4, DL Data, Yellow	
On	Communication is ongoing in the downlink direction
Off	No communication
LED 5, Opto Rx, Green	
On	Received RF signal on fibre channel is above threshold
Off	Input level below threshold
LED 6, Opto Tx, Green	
On	Transmitted RF signal on fibre channel is above threshold
Off	Output level below threshold

### 5.1.3 Power Supply LEDs

This section provides a detailed description of the LEDs and examples of faults.

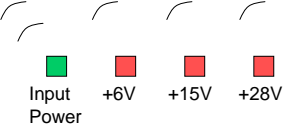
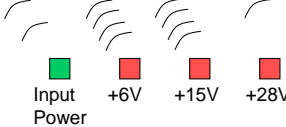
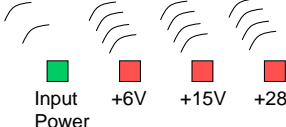

LED 1, Input Power, Green	
Slow flash	Power supply unit operating on AC or DC
OFF	Power supply unit not operating
LED 2, +6V, Red	
Slow flash (every 10 seconds)	+6V power supply operating
Quick flash	+6V power supply not operating or operating with malfunction
LED 3, +15V, Red	
Slow flash (every 10 seconds)	+15V power supply operating
Quick flash	+15V power supply not operating or operating with malfunction
LED 4, +28V, Red	
Slow flash (every 10 seconds)	+28V power supply operating
Quick flash	+28V power supply not operating or operating with malfunction

Examples	
 <p>Input Power    +6V    +15V    +28V</p>	<p>LED 1 is flashing slowly, LED 2 – 4 are flashing slowly (once every 10 seconds) =&gt; power supply unit is operating without problem</p>
 <p>Input Power    +6V    +15V    +28V</p>	<p>LED 1 is flashing slowly, one or two of the red LEDs are flashing quickly =&gt; Input power is operating but there is a problem with some of the other voltages</p>
 <p>Input Power    +6V    +15V    +28V</p>	<p>LED 1 is flashing slowly, all of the red LEDs are flashing quickly =&gt; Input power is out and unit is operating on backup battery</p>

## 6 Maintenance

### Caution

Please be aware that the equipment may, during certain conditions become very warm and can cause minor injuries if handled without any protection, such as gloves.

### Caution

Risk of explosion if battery is replaced by an incorrect type.  
Dispose of used batteries according to local laws and instructions.

### Class 3B Laser

This product is equipped with class 3B lasers, as per definition in EN 60825-1.



### Caution!!!

Un-terminated optical receptacles may emit laser radiation.  
Do not stare into beam or view with optical instruments.

### 6.1 General

The system normally operates without any operator intervention or maintenance. If in the unlikely event of any unit failure, the faulty repeater should be replaced. A failed unit can be removed and replaced with a spare while the rest of the system (other repeaters) is still operating. However, the power supply of the failed repeater should be isolated from the power before anything is replaced. In the event of a malfunction in the system, the status of the antenna systems as well as the continuity of the cabling should be checked before replacing any modules within the repeater.

### 6.2 Preventative Maintenance

The repeater does not require preventative maintenance apart from changing the battery once every three years.

### 6.3 Trouble Shooting

In the event of a failure Axell Wireless's support service should be contacted for advice on a possible module replacement or other action to be taken.

### Caution!

If a shipment of a repeater back to Axell Wireless is made within the period of guarantee the original packing must be used.

### 6.4 Component Replacement

None of the modules in the repeater can be replaced without removing the repeater from its mounting and opening the cover of the repeater.

## 6.5 Product Disposal

Disposal of this product must be handled according to all national laws and regulations. For detailed information regarding materials, please refer to Axell Wireless.

## 7 Modem Communication

---

**Note!** *This section is relevant only for Repeaters installed in stand-alone mode. If the repeater is fibre fed and is set up as a slave- this section is not relevant since the remote communication is handled by the node master – in most cases an OMU.*

---

The Control Module is responsible for enabling the power to the modem, unlocking the SIM-card, using the configured PIN-code and making sure the modem is logged in to the network correctly. Depending on network configuration and modem usage, the modem might require different modem initialization strings to work properly. This modem initialization string is set and verified during repeater setup.

### 7.1 Modem Initialization

After a power failure, or upon user request, the Control Module performs a full initialization of the modem. This consists of three steps:

- ♦ If the SIM-card in the modem has the PIN code enabled, the Control Module unlocks the PIN code. In case wrong PIN-code is configured, the Control Module will not try to unlock the SIM again until the PIN-code is changed. This avoids the SIM card being locked by a Control Module repeatedly trying to unlock the SIM with the wrong PIN code.
- ♦ Once the SIM is unlocked, the Control Module waits for the SIM to log in to the network. Depending on signal quality and network configuration this might take a while. The Control Module will wait a configurable number of seconds (default 50 seconds) for the modem to login to the network. In case no network is found, a modem power cycle will be initiated.

When the modem is successfully logged in to the network, the Control Module configures the modem with the modem initialization string as configured when setting up the remote configuration. The modem initialization string is a network dependent string. The default string is suitable for most networks, but some networks might require some tweaking of this string.

### 7.2 Monitoring Modem Connection

The Control Module constantly monitors the status of the modem connection to ensure that it is working properly, and that the modem is logged in to the network.

In case the modem is not registered to the network, or the Control Module cannot properly communicate with the modem, a power cycling of the modem is initiated, after which the modem will be reinitialized.

### 7.3 Scheduled Modem Power Cycling

In addition to polling the modem to ensure the repeater online status, the Control Module can be configured to perform an automatic power cycling on a scheduled time of the day. Power cycling the modem ensures the latest network configuration for the modem, such as the HLR Update Interval etc.

**Note!** By default, the scheduled modem power cycling is disabled.

## 7.4 Communication via Wireless Modem

There are two different ways of communication for a wireless (GSM) modem:

- ♦ Using data call / modem connection.
  - Note!** This requires the SIM-card in the modem to be configured with data service.
- ♦ Using SMS to configure the repeater with simple text messages
  - Note!** SMS functionality is not implemented in this SW release.

The Axell Element Manager always uses data call communication with the repeater, why all repeaters being controlled by the AEM must have data service enabled on the SIM card.

Configuring the repeater to send alarms and reports via SMS it is still possible to establish data calls to the repeater, as long as the SIM card is data service enabled.

### 7.4.1 Modem Configuration, not using GPRS

Select "Configuration" and "Communication"

Select Data Call

Initialization string

Connect times

AEM addresses are set via the AEM

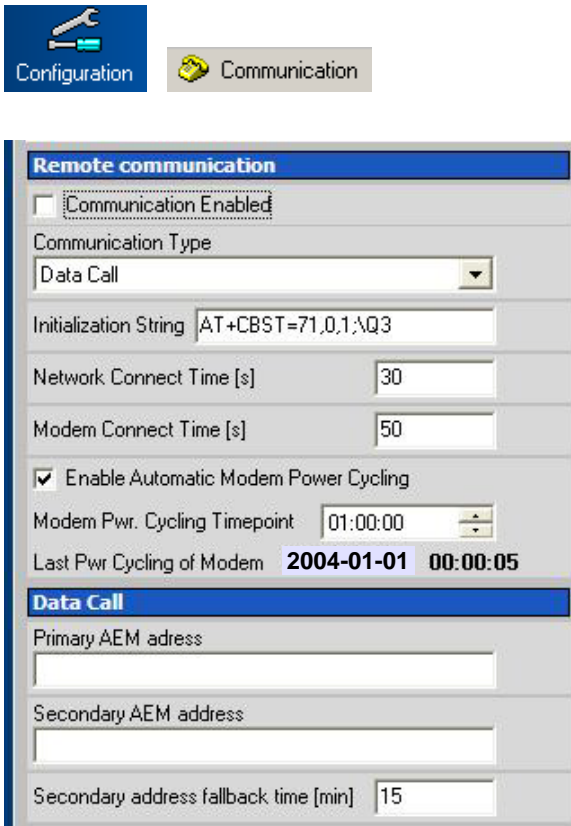

Select Data Call

Set the modem initialization string. This string differs between networks. Primary recommendation is AT+CBST=71,0,1;\Q3. If remote communication cannot be established try 7,0,1 or 0,0,1 or 7,0,3. For more information please refer to the section on Troubleshooting Remote Communication.

Tick "Enable Automatic Modem Power Cycling" for the modem to be power cycled once every 24 hours. Set the time at which the modem should be tested. This function ensures that the repeater always is logged in to the network.



## 7.4.2 Modem Configuration, using GPRS

Select  
"Configuration"  
and  
"Communication"

Select GPRS

Initialization  
string

Connect times

AEM addresses  
are set via the  
AEM

Configure GPRS

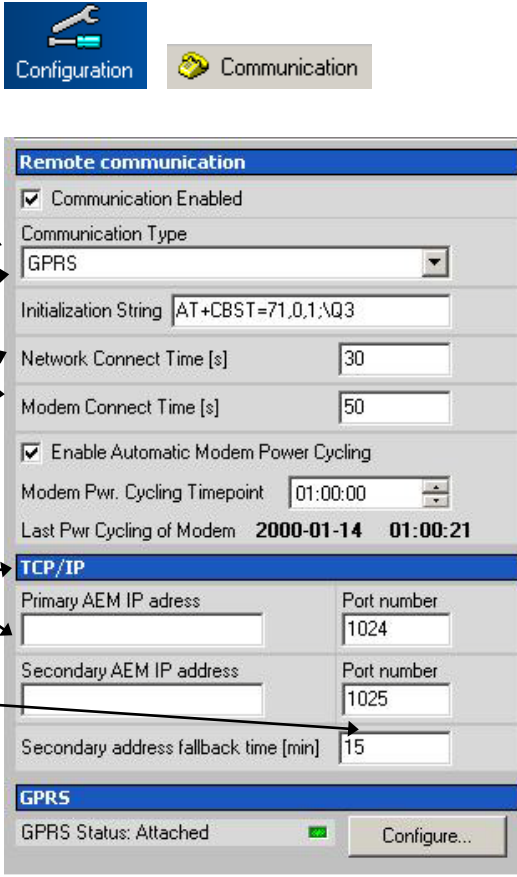

The screenshot shows the 'Configuration' and 'Communication' tabs. The 'Remote communication' section has 'Communication Enabled' checked, 'Communication Type' set to 'GPRS', and 'Initialization String' set to 'AT+CBST=71,0,1;\Q3'. 'Network Connect Time [s]' is 30 and 'Modem Connect Time [s]' is 50. 'Enable Automatic Modem Power Cycling' is checked with a timepoint of 01:00:00. The 'TCP/IP' section shows 'Primary AEM IP address' and 'Secondary AEM IP address' fields, both with 'Port number' set to 1024 and 1025 respectively. The 'GPRS' status is 'Attached'.

Select GPRS

Set the modem initialization string. This string differs between networks. Primary recommendation is AT+CBST=71,0,1;\Q3

Tick "Enable Automatic Modem Power Cycling" for the modem to be power cycled once every 24 hours. Set the time at which the modem should be tested. This function ensures that the repeater always is logged in to the network.

Click on Configure...

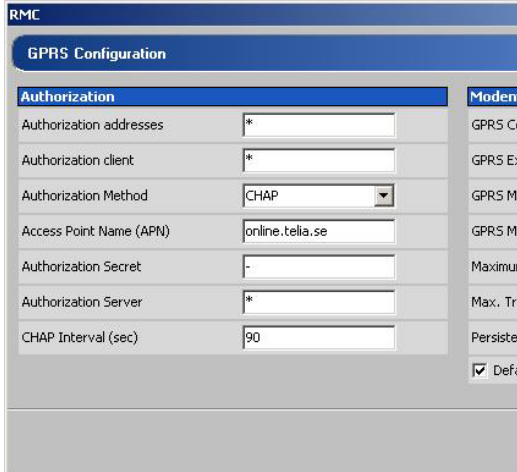

The RMC GPRS Configuration dialog box is divided into 'Authorization' and 'Modem settings' sections. 'Authorization' includes fields for 'Authorization addresses', 'Authorization client', 'Authorization Method' (set to CHAP), 'Access Point Name (APN)' (online.telia.se), 'Authorization Secret', 'Authorization Server', and 'CHAP Interval (sec)' (90). 'Modem settings' includes 'GPRS Connection Type' (IP), 'GPRS Extra Flags' (noauth), 'GPRS Modem dial string' (ATDT\*99\*\*\*1#), 'GPRS Modem timeout (sec)' (10), 'Maximum Receive Unit (0=Default)' (576), 'Max. Transmission Unit (0=Default)' (576), 'Persistence timer (sec)' (35), and a checked 'Default route enable' option.

PRODUCT DESCRIPTION AND USER'S MANUAL

Each parameter is described in *Common Commands and Attributes*, section 14 GPRS Configurations.

Set the Access Point Name. It needs to be defined by the telecom operator Set Maximum Receive Unit and maximum Transmission Unit. These differ depending on access type: 576 for GSM, 1476 for EDGE and 1500 for WCDMA.

Click on Close, and then on “Yes”.

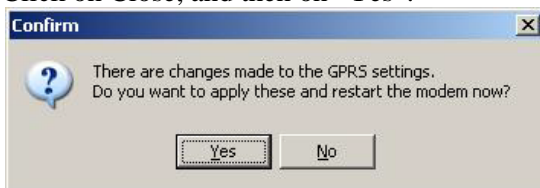

Wait for the modem to restart. This can take a few minutes.



When the modem settings are ready the LED turn green.



**7.4.2.1 Modem Verification**

When the remote configuration has been set up the communication can be verified using the modem feature of the RMC and dialling the data number. The remote communication is verified as soon as a successful remote login to the repeater has been performed.

However, as a first step, it is recommended to verify that the modem is initialized correctly. After configuring the modem using the RMC, make sure to initiate a power cycling of the modem. This is done from the RMC menu.

Click on the drop-down menu Actions, choose Power Cycle Modem on Logout

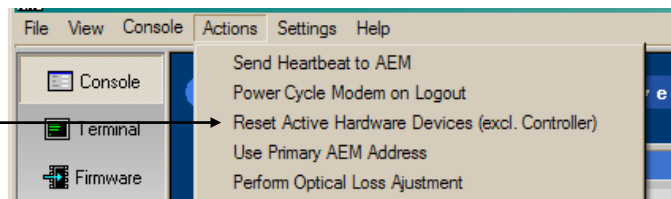







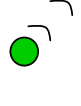
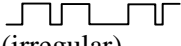

An immediate power cycling is initiated after which the modem is initialized and registered onto the network. The modem is now ready for remote access.

Ensure a successful configuration by observing the modem LED as described below.

**Note!** This LED behaviour is valid only for GSM modems. Other modem types will be added in later editions.

Green LED – Modem Status		
	On	Depending on type of call: Voice call: Connected to remote party Data call: Connected to remote party or exchange of parameters while setting up or disconnecting a call

**PRODUCT DESCRIPTION AND USER'S MANUAL**

	Flashing  (irregular)	Indicates GPRS data transfer. When a GPRS transfer is in progress the LED goes on within 1 second after data packets were exchanged. Flash duration in approximately 0.5s.
	75ms on/75ms off/75ms on/3s off 	One or more GPRS contexts activated
	75ms on/3s off 	Logged to network (monitoring control channels and user interactions). No call in progress
	600ms on/600ms off 	No SIM card inserted, or no PIN entered, or network search in progress, or ongoing user authentications, or network login in progress
	Off	Modem is off

Verify the remote communication either by having someone attempting to integrate the repeater from the Axell Element Manager, or by dialling the repeater using the Repeater Maintenance Console.

**Note!** It is very important to dial the data number of the SIM. In case the voice number is dialled, the call is answered, but almost immediately the call will be hung up.

**7.4.2.2 SIM-card Using Single Numbering Scheme**

If the network is configured using Single Numbering Scheme (SNS), some special considerations apply.

The repeaters are by default configured so that networks using SNS always will have calls routed to the data service in the modem. When dialling from within the network to a repeater having an SNS-configured SIM will operate normally, since the call originator informs the system that the bearer is of type DATA. However, when dialling from outside the network trying to connect to the repeater can be difficult. Depending on the interface to the roaming network or to the PSTN network if an analogue modem is used, the bearer type can default to voice. If the bearer is set to voice, the data service cannot be converted to DATA, and a call setup cannot be completed.

**Note!** This is not a repeater related problem; the solution is to verify how the external network interfaces handles the VOICE vs. DATA bearer type.

**7.4.3 Configuration via PSTN (Fixed) Modem**

Also for PSTN modems data call shall be used.

Select  
"Configuration"  
and  
"Communication"

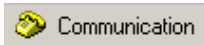
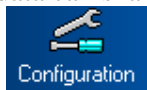

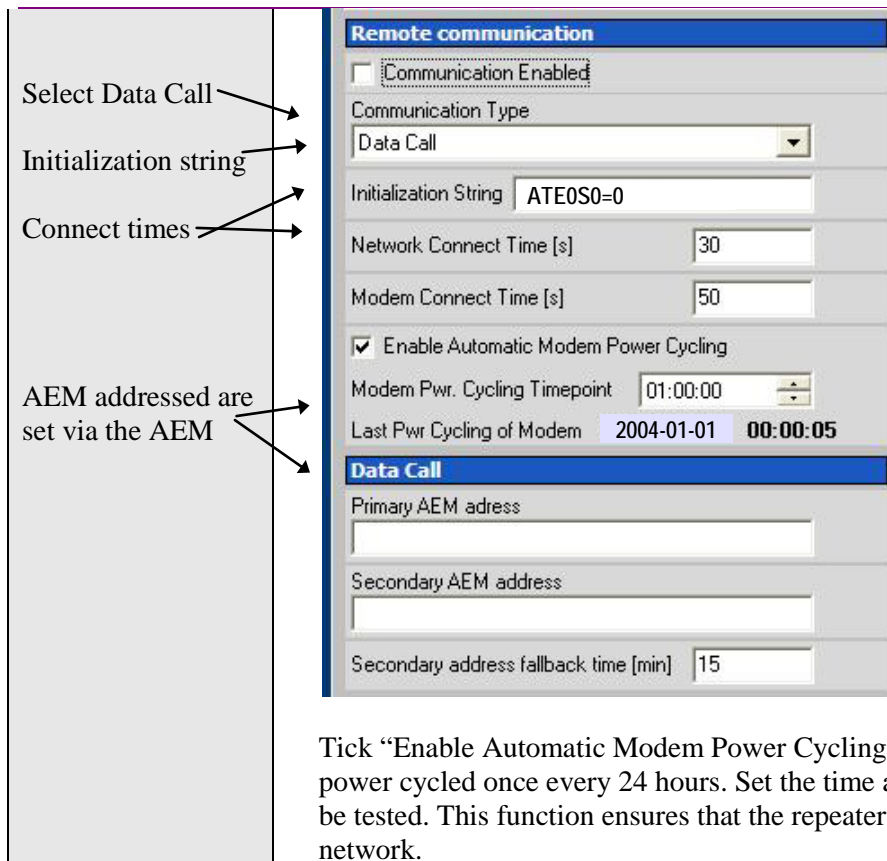

Select Data Call →

Initialization string →

Connect times →

AEM addresses are set via the AEM →

**Remote communication**

Communication Enabled

Communication Type: Data Call

Initialization String: ATE0S0=0

Network Connect Time [s]: 30

Modem Connect Time [s]: 50

Enable Automatic Modem Power Cycling

Modem Pwr. Cycling Timepoint: 01:00:00

Last Pwr Cycling of Modem: 2004-01-01 00:00:05

**Data Call**

Primary AEM address: [ ]

Secondary AEM address: [ ]

Secondary address fallback time [min]: 15

Tick “Enable Automatic Modem Power Cycling” for the modem to be power cycled once every 24 hours. Set the time at which the modem should be tested. This function ensures that the repeater always is logged in to the network.

## 7.5 Troubleshooting Remote Communication

Please also refer to the document *Common Command and Attributes* for guidance.

Since many networks have their own “personality”, performing first time configuration of the remote communication sometimes requires tweaking of the modem parameters.

This section describes some trouble shooting techniques if configuring the repeater for remote access fails.

The illustration below is a simplified schematic of the remote communication between a GSM modem in a repeater and an analogue modem. The analogue modem in the computer communicates with the Interworking Function Unit (IFU), which is the GSM network analogue network interface. The call is routed via the switch centre over the air interface to the data call number in the SIM-card of the GSM module.

The Control Module is responsible for establishing connections with the Axell Element Manager, and to answer incoming calls to the repeater.

As described in previous sections, the Control Module only accepts one login at a time, either via Local Maintenance port (LMT) or modem connection. Hence, when verifying the remote access of the repeater, it is important to log out from the repeater locally before trying to access the repeater remotely.

PRODUCT DESCRIPTION AND USER'S MANUAL

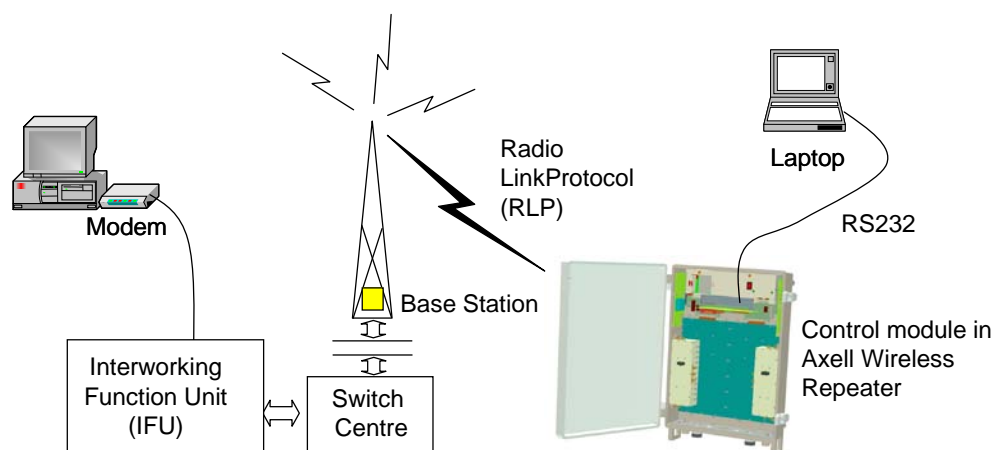

### 7.5.1 Direct Modem Access

To allow for advanced trouble shooting of the communications, it is possible to access the modem directly via the Control Module from a laptop computer.

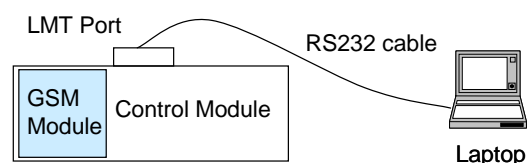

Log in to the repeater, either with RMC, or with a terminal emulation program, such as HyperTerminal™. When the login is completed, select Terminal Mode, this will give access to the repeater command prompt in the same way as with HyperTerminal.

When the repeater prompt is accessible, type in the command  
`ACCESS MODEM <Enter>`.

When typing `ACCESS MODEM`, the controller will send all the characters that are typed directly out to the modem port. All characters replied back from the modem will go directly to the LMT port and back to the computer.

To abort an `ACCESS MODEM` session, press three ‘-’ in a row (all three within one second) to come back to the repeater command prompt.

**Note!** When accessing the modem port the modem might be configured with “echo off”, meaning that the characters entered will not be echoed back to the screen. In order to enable “echo”, press Enter.

Type  
`ATE1 <enter>`  
 (invisible)

The modem replies with  
 OK

indicating that the echo is enabled. All characters entered will now be echoed back to the terminal program.

### 7.5.2 Trace Modem

For troubleshooting purposes it is possible to trace the actual progress of initializing the modem. This trace is useful when having problems with the modem initialization.

Go to Terminal Mode and type  
`TRACE MODEM`

```

GPRS cycling requested, detaching from GPRS network...
Clearing out the GPRS IP settings...
Restoring standard default route...
Restoring standard network settings...
GPRS shutdown completed!
Checking modem connection...
Disabling modem echo...
ERROR: Modem not responding!
Modem not responding!
Recovering modem communications...
GPRS interface shut down...
Modem communication recovered successfully.
Initializing modem...
Disabling modem echo...
Modem echo successfully disabled.
Checking PIN status...
SIM already unlocked.
Checking Network Registration...
Registered on home network.
Initializing modem specific parameters....
Sending modem initialization string AT+CBST=71,0,1;\Q3
Modem initialization completed successfully!
Starting GPRS attach procedure...
  
```

To end session type CTRL-Z

### 7.5.3 Manually Answering Incoming Calls

It is possible to manually answer incoming calls without involving the repeater software at all, to verify that the remote access and the network itself works as intended. In order to verify the remote communication, make sure to have someone stand by to dial up the repeater with a terminal emulation program, for example HyperTerminal™.

Go in to Direct Modem Access as described earlier. When in direct access mode, ask the person standing by to dial up the repeater.

As soon as a call is received, the text

RING

will repeatedly be displayed on the screen.

Type

ATA <enter>

This will inform the modem to answer (ATtention Answer).

When the connection is established, a connect message will be displayed including the connection speed. Sometimes the information comes together with some miscellaneous information, such as error correction protocols etc.

**Note!** Make sure the remote peer dials the Data Call number

If the voice number is dialled instead of the data number, or if the modem contains an illegal modem initialization string, the message

OK

or

NO CARRIER

will be displayed almost immediately.

Try to change the modem initialization string. The modem initialization string mainly used to configure the remote communication is AT+CBST.

Successful modem initialization strings used by Axell Wireless includes (most common first):

AT+CBST=71,0,1;\Q3

AT+CBST=7,0,1;\Q3

AT+CBST=0,0,1;\Q3

AT+CBST=0,0,1;\Q3

AT+CBST=7,0,3;\Q3

Once the modem initialization string is entered, try again to dial up the repeater. For details on the different modem initialization strings, please refer to the modem's user guide.

If the setup is successful, the connect message will be brought up;

## PRODUCT DESCRIPTION AND USER'S MANUAL

CONNECT 9600

This means that an online connection is established to the remote peer. From now on, all characters typed on the keyboard will end up on the remote peer's screen. Similarly, all characters typed by the remote peer will be displayed on the screen.

In the example, the incoming call was successfully answered, and the remote user entered the text message.

```
Time: 08:03:49 Date: 2003-11-28 RID: 00-00-0000 Tag: RFID-2339

To quit, press CTRL-C (or use escape sequence <Hait 1 s>'---'<Hait 1 s>
at
OK

RING
ata
CONNECT 9600
This communication seems to work fine!!!

AVITEC AB>
AVITEC AB>
AVITEC AB>
AVITEC AB>access modem
```

In order to come back to modem command mode, press +++ (three pluses) rapidly (within one second).

Receiving

OK

means that the modem is back in command mode.

Type

ATH <enter>

This terminates the connection to the remote peer. The message

NO CARRIER

will be displayed.

## 7.5.4 Common Problems

### 7.5.4.1 Problem 1

When enabling the remote access for the repeater, the modem fails to log in to the network.

### 7.5.4.2 Solution

Signal strength from the donor site is too low. The signal strength can be read directly from the modem. Go in to Direct Modem Access as described earlier. Use the command AT+CSQ (documented below) to read out the signal strength.

In order to have good signal quality, Axell Wireless recommends that the signal strength should be better than -95 dBm. If signal strength is lower, try to adjust the antennas to get a better signal strength from the donor.



## 6.1 Signal Quality +CSQ

### 6.1.1 Description :

This command is used to know the *received signal strength indication* (<rss>) and the *channel bit error rate* (<ber>) with or without any SIM card inserted.

### 6.1.2 Syntax :

Command syntax : AT+CSQ

Command	Possible responses
AT+CSQ	+CSQ: <rss>,<ber> OK <i>Note : &lt;rss&gt; and &lt;ber&gt; as defined below</i>

### 6.1.3 Defined values :

<rss> :	0	: -113 dBm or less
	1	: -111 dBm
	2...30	: -109 to -53 dBm
	31	: -51dBm or greater
	99	: not known or not detectable
<ber> :	0..7	: as RXQUAL values in the table GSM 05.08
	99	: not known or not detectable

Documentation of +CSQ command from a modem's manual.

In the example the reply to AT+CSQ is 0,7 meaning 7\*2 dB above -113 dBm; the modem detects a signal level of -99 dBm.

```

Time: 07:57:46 Date: 2003-11-28 RID: 00-00-0000 Tag: RFID-2339

To quit, press CTRL-C (or use escape sequence <Hait 1 s>'---'<Hait 1 s>
at+creg?
+CREG: 0,1

OK
at+csq
+CSQ: 7,0

OK

AVITEC AB>
AVITEC AB>
AVITEC AB>
AVITEC AB>access modem
    
```

### 7.5.4.3 Problem 2a

Repeater is configured properly, and answers the incoming call, but when trying to dial the repeater using an analogue mode, no modem handshaking is heard from the dialling modem.

### 7.5.4.4 Problem 2b

When dialling the repeater, the repeater answers the incoming call, but no connection is established, and after a while the repeater disconnects the call.

### 7.5.4.5 Solution

The most common cause is that the number called is the voice number of the SIM, not the data number. Therefore, make sure to dial the data number.

If data call is used, the problem probably is an illegal modem initialization string.

In order to change the modem string, go to the repeater command prompt. Try changing the modem initialization string and log out to let the controller reinitialize the modem.



## PRODUCT DESCRIPTION AND USER'S MANUAL

---

If problem remains, try a few different modem initialization strings. Axell Wireless has been successful with the following modem initialization strings:

```
AT+CBST=71,0,1;\Q3
```

```
AT+CBST=7,0,1;\Q3
```

```
AT+CBST=0,0,1;\Q3
```

```
AT+CBST=0,0,1;\Q3
```

```
AT+CBST=7,0,3;\Q3
```

Please refer to the modem manual for detailed description of the modem initialization strings.

### **7.5.4.6 Problem 3**

It is possible to call the repeater from another GSM mobile, but not from an analogue modem.

### **7.5.4.7 Solution**

This problem is most likely related to the modem configuration and/or the configuration of the IFU unit. Try to decrease the communications speed and make sure that the modem error correction is supported by the IFU. Verify the IFU configuration to see if there are any known problems with the modem connections.

### **7.5.4.8 Problem 4**

When dialling the repeater, or when the repeater is dialling the Element Manager, the connection is terminated before the handshaking is completed.

### **7.5.4.9 Solution**

When a repeater is answering an incoming modem call, or calling up the OMC to deliver an alarm or a report, the repeater will wait a configurable number of seconds for the call to be established. If no communication is established within this time, the call will be hung up. If this interval is set too low, the handshaking is terminated too fast. In the RMC, verify the Modem Connect Time to see that it is set to at least 30 seconds.

# 8 Specifications

**Note!** All data is subject to change without prior notice.

## 8.1 Single Band Repeater MBF-S-7/8/9/17/18/19/22

### Electrical Specifications

	LTE 700	GSM/WCDMA 850	E-GSM	GSM1800	GSM/WCDMA 1900	AWS	WCDMA2100
UL	698-716MHz and 777-787MHz	824 – 849 MHz	880 – 915 MHz	1710 - 1785 MHz	1850 - 1910 MHz	1710-1755 MHz	1920 - 1980 MHz
DL	728-756MHz	869 – 894 MHz	925 – 960 MHz	1805 - 1880 MHz	1930 - 1990 MHz	2110-2155 MHz	2110 - 2170 MHz
Operational bandwidth	28MHz/18MHz/10MHz	25MHz	35 MHz	75MHz	60 MHz	45MHz	60 MHz
Composite Output Power DL	+37dBm	+37 dBm	+37 dBm	+37 dBm	+37 dBm	-39 dBm (for PAR of 8.5 dB)	+39 dBm (for PAR of 8.5 dB)

Ripple in pass band (all bands) < 2 dB  
 Noise figure UL (all bands) 3 dB typical (maximum gain)  
 Propagation delay (all bands) < 2 μs

#### Modulation Accuracy at nominal output power

LTE <3%EVM RMS  
 GSM / GMSK < 2.5 ° RMS and < 10 ° peak  
 EDGE / 8-PSK < 3 % EVM RMS  
 WCDMA/EVM < 12.5% RMS (composite according to ETSI TS 25.106 with TM 1/64 DPCH)  
 WCDMA/PkDCE < -33 dB (according to ETSI TS 25.106 with TM 1/64 DPCH and spreading factor 256)  
 Gain UL/DL (all bands) Adjustable in 1 dB steps  
 System Impedance 50 ohm  
 Return Loss at Antenna Connection > 14 dB  
 Antenna connectors DIN 7/16  
 Electrical ratings 230 VAC, 50 Hz or -48 VDC  
 Power Consumption 140 W

## PRODUCT DESCRIPTION AND USER'S MANUAL

### Optical Module Electrical Specification

Laser class	Class 3B
Optical power level	+3dBm ±2dBm
Optical Wavelength	

	Two colour system	Three colour system	Four colour system
Master	1310 ± 10 nm	1310 ± 10 nm	1310 ± 10 nm
Slave 1	1550 ± 3 nm	1550 ± 3 nm	1530 ± 3 nm
Slave 2	NA	1510 ± 3 nm	1510 ± 3 nm
Slave 3	NA	NA	1550 ± 3 nm

### Mechanical Specifications

Dimensions	540 x 350 x 150 mm
Enclosure	Aluminium (IP 65)
Weight	20 kg

### Environmental Specifications

Cooling	Convection*
EMC	See compliance below
Operating Temperature	- 25 to + 55 ° C
Storage	- 30 to + 70 ° C
Humidity	ETSI EN 300 019-2-4 (see compliance below)
MTBF	> 100 000 hrs

Complies in applicable parts, relevant on different markets, to:

R&TTE Directive including  
 ETS EN 301 502 (ETS EN 300 609-4/GSM 11.26)  
 ETSI TS 25.106, ETSI 25.143  
 ETSI EN 301 908-11  
 ETS EN 301 498-8  
 EN 60 950  
 EN 50 385

\* The MBF repeaters are designed primarily for multi carrier purposes. If the repeaters are run at full output power over a longer period the convection cooling might not be enough. The repeaters have a power management function implemented that will step down the power and if needed fully shut down the amplifier chains until temperature has reached normal values. In situations where a repeater will be run in such a manner extra cooling can be provided for instance by putting the repeater in a temperature controlled environment or via external fans.

## 8.2 Dual Band Repeater MBF-D-9-22/8-19/7-17

### Electrical Specifications

	LTE 700	GSM/WCDMA 850	E-GSM	GSM/WCDMA 1900	AWS	WCDMA2100
UL	698-716MHz and 777-787MHz	824 – 849 MHz	880 – 915 MHz	1850 - 1910 MHz	1710-1755 MHz	1920 - 1980 MHz
DL	728-756MHz	869 – 894 MHz	925 – 960 MHz	1930 - 1990 MHz	2110-2155 MHz	2110 - 2170 MHz
Operational bandwidth	28MHz/18MHz/10MHz	25MHz	35 MHz	60 MHz	45MHz	60 MHz
Composite Output Power DL	+37dBm	+37 dBm	+37 dBm	+37 dBm	-39 dBm (for PAR of 8.5 dB)	+39 dBm (for PAR of 8.5 dB)

Ripple in pass band (all bands)	< 2 dB
Noise figure UL (all bands)	3 dB typical (maximum gain)
Propagation delay (all bands)	< 2 $\mu$ s

#### Modulation Accuracy at nominal output power

LTE 700	<3% EVM RMS
GSM / GMSK	< 2.5 ° RMS and < 10 ° peak
EDGE / 8-PSK	< 3 % EVM RMS
WCDMA/EVM	< 12.5% RMS (composite according to ETSI TS 25.106 with TM 1/64 DPCH)
WCDMA/PkDCE	< -33 dB (according to ETSI TS 25.106 with TM 1/64 DPCH and spreading factor 256)

Gain UL/DL (all bands)	Adjustable in 1 dB steps
System Impedance (all bands)	50 ohm
Return Loss at Antenna Connection	> 14 dB
Antenna connectors	DIN 7/16
Electrical ratings	230 VAC, 50 Hz or -48 VDC
Power Consumption	220 W

**PRODUCT DESCRIPTION AND USER'S MANUAL**
**Optical Module Electrical Specification**

Laser class	Class 3B
Optical power level	+3dBm ±2dBm

## Optical Wavelength

	Two colour system	Three colour system	Four colour system
Master	1310 ± 10 nm	1310 ± 10 nm	1310 ± 10 nm
Slave 1	1550 ± 3 nm	1550 ± 3 nm	1530 ± 3 nm
Slave 2	NA	1510 ± 3 nm	1510 ± 3 nm
Slave 3	NA	NA	1550 ± 3 nm

**Mechanical Specifications**

Dimensions	540 x 350 x 150 mm
Enclosure	Aluminium (IP 65)
Weight	22 kg

**Environmental Specifications**

Cooling	Convection*
EMC	See compliance below
Operating Temperature	- 25 to + 55 ° C
Storage	- 30 to + 70 ° C
Humidity	ETSI EN 300 019-2-4 (see compliance below)
MTBF	> 100 000 hrs

Complies in applicable parts, relevant on different markets, to:

R&TTE Directive including

ETS EN 301 502 (ETS EN 300 609-4/GSM 11.26)

ETSI TS 25.106, ETSI 25.143

ETSI EN 301 908-11

ETS EN 301 498-8

EN 60 950

EN 50 385

\* The MBF repeaters are designed primarily for multi carrier purposes. If the repeaters are run at full output power over a longer period the convection cooling might not be enough. The repeaters have a power management function implemented that will step down the power and if needed fully shut down the amplifier chains until temperature has reached normal values. In situations where a repeater will be run in such a manner extra cooling can be provided for instance by putting the repeater in a temperature controlled environment or via external fans.

## 8.3 Tri Band Repeater MBF-T-9-18-22/8-17-19

### Electrical Specifications

	LTE 700	GSM/WCDMA 850	E-GSM	GSM1800	GSM/WCDMA 1900	WCDMA 2100	AWS
UL	698-716MHz and 777-787MHz	824 – 849 MHz	880 – 915 MHz	1710 - 1785 MHz	1850 - 1910 MHz	1920 - 1980 MHz	1710-1755 MHz
DL	728-756MHz	869 – 894 MHz	925 – 960 MHz	1805 - 1880 MHz	1930 - 1990 MHz	2110 - 2170 MHz	2110-2155 MHz
Operational bandwidth	28MHz/18MHz/10MHz	25MHz	35 MHz	75MHz	60 MHz	60 MHz	45MHz
Composite Output Power DL	+37dBm	+37 dBm	+37 dBm*	+37 dBm*	+37 dBm	+39 dBm (for PAR of 8.5 dB)	+39 dBm (for PAR of 8.5 dB)

\* In repeaters that share a common downlink fibre for 900MHz and 1800MHz a minimum of 4 carriers in each band is required for the full composite output power to be attainable maintaining full ETSI compliance

Ripple in pass band (all bands) < 2 dB  
 Noise figure UL (all bands) 3 dB typical (maximum gain)  
 Propagation delay (all bands) < 2 μs

Modulation Accuracy at nominal output power

GSM / GMSK < 2.5 ° RMS and < 10 ° peak  
 EDGE / 8-PSK < 3 % EVM RMS  
 WCDMA/EVM < 12.5% RMS (composite according to ETSI TS 25.106 with TM 1/64 DPCH)  
 WCDMA/PKDCS < -33 dB (according to ETSI TS 25.106 with TM 1/64 DPCH and spreading factor 256)

Gain UL/DL (all bands) Adjustable in 1 dB steps

System Impedance 50 ohm  
 Return Loss at Antenna Connection > 14 dB

Antenna connectors DIN 7/16  
 Electrical ratings 230 VAC, 50 Hz or -48 VDC  
 Power Consumption 350 W

## PRODUCT DESCRIPTION AND USER'S MANUAL

### Optical Module Electrical Specification

Laser class	Class 3B
Optical power level	+3dBm ±2dBm
Optical Wavelength	

	Two colour system	Three colour system	Four colour system
Master	1310 ± 10 nm	1310 ± 10 nm	1310 ± 10 nm
Slave 1	1550 ± 3 nm	1550 ± 3 nm	1530 ± 3 nm
Slave 2	NA	1510 ± 3 nm	1510 ± 3 nm
Slave 3	NA	NA	1550 ± 3 nm

### Mechanical Specifications

Dimensions	540 x 350 x 220 mm
Enclosure	Aluminium (IP 65)
Weight	33 kg

### Environmental Specifications

Cooling	Convection*
EMC	See compliance below
Operating Temperature	- 25 to + 55 ° C
Storage	- 30 to + 70 ° C
Humidity	ETSI EN 300 019-2-4 (see compliance below)
MTBF	> 100 000 hrs

Complies in applicable parts, relevant on different markets, to:

R&TTE Directive including  
 ETS EN 301 502 (ETS EN 300 609-4/GSM 11.26)  
 ETSI TS 25.106, ETSI 25.143  
 ETSI EN 301 908-11  
 ETS EN 301 498-8  
 EN 60 950  
 EN 50 385

*\* The MBF repeaters are designed primarily for multi carrier purposes. If the repeaters are run at full output power over a longer period the convection cooling might not be enough. The repeaters have a power management function implemented that will step down the power and if needed fully shut down the amplifier chains until temperature has reached normal values. In situations where a repeater will be run in such a manner extra cooling can be provided for instance by putting the repeater in a temperature controlled environment or via external fans.*