

D-CSR 3604 UHF Repeater

Product Description and User's Manual

Doc PN 3604 A284 Series-UM Rev. 2.1

THIS DOCUMENT IS VALID FOR THE
CSR 3604 (421/427MHz) REPEATERS for the US Market



Copyright © 2014 Axell Wireless Ltd

All rights reserved.

No part of this document may be copied, distributed, transmitted, transcribed, stored in a retrieval system, or translated into any human or computer language without the prior written permission of Axell Wireless Ltd.

The manufacturer has made every effort to ensure that the instructions contained in this document are adequate and free of errors and omissions. The manufacturer will, if necessary, explain issues which may not be covered by this document. The manufacturer's liability for any errors in the document is limited to the correction of errors and the aforementioned advisory services.

This document has been prepared to be used by professional and properly trained personnel, and the customer assumes full responsibility when using them. The manufacturer welcomes customer comments as part of the process of continual development and improvement of the documentation in the best way possible from the user's viewpoint. Please submit your comments to the nearest Axell Wireless sales representative.

Contact Information

Headquarters	Axell Wireless Aerial House Asheridge Road Chesham Buckinghamshire HP5 2QD United Kingdom Tel: +44 1494 777000 Fax: +44 1494 777002
Commercial inquiries	info@axellwireless.com
Web site	www.axellwireless.com
Support issues	support@axellwireless.com
Technical Support Line, English speaking	+44 1494 777 747

Contact information for Axell Wireless offices in other countries can be found on our web site, www.axellwireless.com

About This Manual

This Product Manual provides the following information:

- Description of the Repeater
- Procedures for setup, configuration and checking the proper operation of the Repeater
- Maintenance and troubleshooting procedures

Users

This Product Manual is intended for experienced technicians and engineers. It is assumed that the customers installing, operating, and maintaining Axell Wireless Repeaters are familiar with the basic functionality of Repeaters.

Notice

Confidential - Authorized Customer Use

This document may be used in its complete form only and is solely for the use of Axell Wireless employees and authorized Axell Wireless channels or customers. The material herein is proprietary to Axell Wireless. Any unauthorized reproduction, use or disclosure of any part thereof is strictly prohibited.

All trademarks and registered trademarks are the property of their respective owners.

Disclaimer of Liability

Contents herein are current as of the date of publication. Axell Wireless reserves the right to change the contents without prior notice. The information furnished by Axell Wireless in this document is believed to be accurate and reliable. However, Axell Wireless assumes no responsibility for its use. In no event shall Axell Wireless be liable for any damage resulting from loss of data, loss of use, or loss of profits and Axell Wireless further disclaims any and all liability for indirect, incidental, special, consequential or other similes damages. This disclaimer of liability applies to all products, publications and services during and after the warranty period.

Safety to Personnel

- Before installing or replacing any of the equipment, the entire manual should be read and understood.
- *This equipment is to be installed only in a restricted access location.*
- Throughout this manual, there are "Caution" warnings. "Caution" calls attention to a procedure or practice, which, if ignored, may result in injury or damage to the system, system component or even the user. Do not perform any procedure preceded by a "Caution" until the described conditions are fully understood and met.

CAUTION! This notice calls attention to a procedure or practice that, if ignored, may result in personal injury or in damage to the system or system component. Do not perform any procedure preceded by a "Caution" until described conditions are fully understood and met.

Compliance with FCC

Part 90 Signal Boosters	THIS IS A 90.219 CLASS B DEVICE
	<p>WARNING: This is NOT a CONSUMER device. This device is designed for installation by FCC LICENCEES and QUALIFIED INSTALLERS. You MUST have an FCC LICENCE or express consent of an FCC Licensee to operate this device. You MUST register Class B signal boosters (as defined in 47 CFR 90.219) online at www.fcc.gov/signal-boosters/registration.</p> <p>Unauthorized use may result in significant forfeiture penalties, including penalties in excess of \$100,000 for each continuing violation.</p>

	<p>The installation procedure must result in the signal booster complying with FCC requirements 90.219(d). In order to meet FCC requirements 90.219 (d), it may be necessary for the installer to reduce the UL and/or DL output power for certain installations.</p>
---	--

FCC Part 15

This device complies with part 15 of the FCC Rules. Operation is subject to the following two conditions:

1. This device may not cause harmful interference, and
2. This device must accept any interference received, including interference that may cause undesired operation.

If not installed and used in accordance with the instructions, this equipment generates, uses and can radiate radio frequency energy. However, there is no guarantee that interference will not occur in a particular installation. If this equipment does cause harmful interference to RF reception, which can be determined by turning the equipment off and on, the user is encouraged to try to correct the interference by one or more of the following measures:

- Reorient or relocate the Donor antenna.
- Increase the separation between the equipment and receiver.
- Connect the equipment into an outlet on a circuit different from that to which the receiver is connected.

Unauthorized Changes to Equipment

Changes or Modifications not expressly approved by the manufacturer responsible for compliance could void the user's authority to operate the equipment

FCC RF Exposure Limits

This unit complies with FCC RF exposure limits for an uncontrolled environment. This equipment can only be installed in in-building applications, driving passive or active DAS systems. All antennas must be operated at a minimum distance of 49 cm between the radiator and any person's body.

Antenna Installation

Installation of an antenna must comply with the FCC RF exposure requirements. The antenna used for this transmitter must be mounted on permanent structures.

The FCC regulation mandate that the ERP of type A signal boosters should not exceed 5W, this is equivalent to 8.2W EIRP.

Therefore the max antenna gain allowed for this type of signal booster should be limited to the values given by equation (1) for the service antenna and equation (2) for the donor antenna

Equation (1) - Max SERVICE antenna gain

Max SERVICE antenna gain (dBi) = $39.1 - (37\text{dBm} - \# \text{ of antennas in dB} - \text{cable losses in dB})$.

For example:

No. of Antennas	Cable Losses	Max Allowed Antenna Gain
4	3	$39.1 - (37-6-3) = 11.1\text{dBi}$
1	3	$39.1 - (37-0-3) = 5.1\text{dBi}$
10	3	$39.1 - (37-10-3) = 15.1\text{dBi}$

Equation (2) - Max DONOR antenna gain

Max DONOR antenna gain (dBi) = $39.1 - (37\text{dBm} - \text{cable losses in dB})$.

For example:

No. of Antennas	Cable Losses	Max Allowed Antenna Gain
1	10	$39.1 - (37-10) = 12.1\text{dBi}$

Compliance with FCC deployment rule regarding the radiation of noise

Good engineering practice must be used in regard to the signal booster's noise radiation. Thus, the gain of the signal booster should be set so that the ERP of the output noise from the signal booster should not exceed the level of -43 dBm in 10 kHz measurement bandwidth.

In the event that the noise level measured exceeds the aforementioned value, the signal booster gain should be decreased accordingly.

In general, the ERP of noise on a spectrum more than 1 MHz outside of the pass band should not exceed -70 dBm in a 10 kHz measurement bandwidth.

The 3604 A284 Series Repeater has a noise level of -53 dBm in 10 kHz measurement at 1 MHz spectrum outside the passband of the signal booster and an *in-band* noise level at around -34 dBm in a 10 kHz bandwidth. Therefore, the noise at the antenna input port should be calculated based on equation (3).

Equation (3) - Input Noise to service antenna

Input Noise to service antenna:

$-53 \text{ dBm} + \text{Service Antenna gain} - \text{Antenna splitter losses in dB} - \text{cable loss in dB}$

Example:

Signal booster connected to 10 service antennas with a 100m long ½ inch cable.

Losses of such a cable with the connectors = ~ 11dB

Gain = ~ 2 dBi

Assuming 10 service antennas: antenna splitter losses = 11 dB

Based on equation (3) Input antenna noise (to the antenna) = $-53+2-11-11=-73$ dBm

The inband input noise to the antenna should be $-34+2-11-11=-54$ dbm

NOTE: In this example there is no need to add an external band pass filter to attenuate the out of band noise.

Conclusion:





Good engineering practice requires that in general when the out of band noise measured at the service antenna input is more than -70 dBm per 10 kHz measurement bandwidth, an external band pass filter should be added to attenuate the out of band noise level.

All Axell Wireless repeaters include high selectivity duplexers and filters to attenuate the out of band noise. Should additional filtering be required, we have a comprehensive range of interference filters which can be supplied upon request.

General Safety Warnings Concerning Use of This System

Always observe standard safety precautions during installation, operation and maintenance of this product. Only a qualified and authorized personnel should carry out adjustment, maintenance or repairs to the components of this equipment.

NOTE: Please refer to Axell Wireless for additional information and for requests for notifications to authorities.

 Caution labels!	<p>Throughout this manual, there are "Caution" warnings. "Caution" calls attention to a procedure or practice, which, if ignored, may result in injury or damage to the system, system component or even the user. Do not perform any procedure preceded by a "Caution" until the described conditions are fully understood and met.</p>
 Danger: Electrical Shock	<p>This equipment can either be installed indoors or outdoors. When installed outdoors - wet conditions increase the potential for receiving an electric shock when installing or using electrically powered equipment. To prevent electrical shock when installing or modifying the system power wiring, disconnect the wiring at the power source before working with un insulated wires or terminals.</p>
 Caution: RF Exposure	<p>RF radiation, (especially at UHF frequencies) arising from transmitter outputs connected to AWL's equipment, must be considered a safety hazard.</p> <p>This condition might only occur in the event of cable disconnection, or because a 'spare' output has been left un-terminated. Either of these conditions would impair the system's efficiency. No investigation should be carried out until all RF power sources have been removed. This would always be a wise precaution, despite the severe mismatch between the impedance of an N type connector at 50Ω, and that of free space at 377Ω, which would severely compromise the efficient radiation of RF power. Radio frequency burns could also be a hazard, if any RF power carrying components were to be carelessly touched!</p> <p>Where the equipment is used near power lines or in association with temporary masts not having lightning protection, the use of a safety earth connected to the case-earthing bolt is strongly advised.</p> <p>For FCC compliance, the Maximum Channel output must be <5 watts.</p>
 Warning: Antenna Installation	<p>Antenna positions should be chosen to comply with requirements (both local & statutory) regarding exposure of personnel to RF radiation. When connected to an antenna, the unit is capable of producing RF field strengths, which may exceed guideline safe values especially if used with antennas having appreciable gain. In this regard the use of directional antennas with backscreens and a strict site rule that personnel must remain behind the screen while the RF power is on, is strongly recommended.</p> <p>Installation of an antenna must comply with the FCC RF exposure requirements.</p> <p>The antenna used for this transmitter must be mounted on outdoor or indoor permanent structures. Please refer to user manual guidance on maximum antenna gain. In indoor applications the antenna must be installed at a minimum separation distance of 49 cm from all nearby persons.</p>





 <p>Caution: Safety to personnel.</p>	<p>Before installing or replacing any of the equipment, the entire manual should be read and understood.</p> <p>The user needs to supply the appropriate AC or DC power to the repeater. Incorrect power settings can damage the repeater and may cause injury to the user.</p> <p>Please be aware that the equipment may, during certain conditions become very warm and can cause minor injuries if handled without any protection, such as gloves</p>
 <p>Caution: Safety to equipment</p>	<p>When installing, replacing or using this product, observe all safety precautions during handling and operation. Failure to comply with the following general safety precautions and with specific precautions described elsewhere in this manual violates the safety standards of the design, manufacture, and intended use of this product.</p> <p>Axell Wireless assumes no liability for the customer's failure to comply with these precautions. This entire manual should be read and understood before operating or maintaining the repeater.</p>
 <p>Warning: Restricted Access Location</p>	<p>Access to the Axell unit installation location is restricted to SERVICE PERSONNEL and to USERS who have been instructed on the restrictions and the required precautions to be taken.</p>
 <p>Attention: Electrostatic Sensitivity</p>	<p>Observe electrostatic precautionary procedures. ESD = Electrostatic Discharge Sensitive Device.</p> <p>Semiconductor transmitters and receivers provide highly reliable performance when operated in conformity with their intended design. However, a semiconductor may be damaged by an electrostatic discharge inadvertently imposed by careless handling.</p> <p>Static electricity can be conducted to the semiconductor chip from the centre pin of the RF input connector, and through the AC connector pins. When unpacking and otherwise handling the repeater, follow ESD precautionary procedures including use of grounded wrist straps, grounded workbench surfaces, and grounded floor mats.</p>
 <p>Caution: Battery Replacement</p>	<p>Risk of explosion if battery is replaced with incorrect type. Dispose of used batteries according to instructions.</p>

Table of Contents

1	Introduction	1
1.1	Features and Capabilities.....	2
1.2	Rechargeable Battery Pack.....	2
1.3	CSR 3604-A284Series Interfaces.....	3
1.3.1	CSR 3604-A284Series– Wall Mount Casing.....	3
2	Antenna Specifications and Installation Criteria	6
2.1	Base (Donor) Antenna	6
2.1.1	Required Antenna Information	6
2.1.2	Donor Antenna specification	6
2.1.3	Installation Criteria.....	7
2.2	Service Antenna Requirements	7
2.2.1	Required Antenna Information	7
2.2.2	Indoor Installations	7
2.3	RF Cabling Requirements	9
3	Pre-Installation Requirements	10
3.1	Safety Guidelines	10
3.2	Required BTS Information.....	10
3.3	Selecting a Location	10
3.3.1	Relative Location of Base Station	10
3.3.2	Cooling and Airflow	10
3.3.3	Wall Compatibility.....	11
3.3.4	Access to the Repeater	11
4	Physical Installation.....	12
4.1	Overview of the Installation Procedure	12
4.2	Required Tools and Materials	13
4.3	Unpacking.....	13
4.4	Wallmount Procedure	14
4.5	Dimensions and Bracket Assembly	15
4.5.1	Bracket Assembly.....	15
4.5.2	Fixing Centers	16
4.5.3	Requirements	17
4.5.4	Planning the Repeater Location and Drilling.....	17
4.5.5	Hanging the Repeater on the Wall	18
4.6	Grounding	19
4.7	EMV Protection.....	19
4.8	Insert SIM Card	21
4.9	Antenna (RF) Connections.....	22
4.9.1	Verifying the Link between the BTS and the Repeater	22
4.10	External Alarm and Relay (Internal Alarm) Connections	23
4.10.1	External Alarm	24
4.10.2	Relay	24
4.11	Power Connections.....	25
4.11.1	Circuit Breaker Connections.....	25
4.11.2	110/115v AC Power Source Connection.....	25
4.11.3	Switching Power ON	26
4.11.4	Close and secure the Repeater.....	26
5	Login and GUI Navigation	27
5.1	Opening a Local Web Session to the Repeater	27

5.1.1	Connect the Repeater to the Computer	27
5.1.2	Configure the Computer Network Parameters	28
5.2	Web Session Login to the Repeater	30
5.3	Navigating the Web GUI Application	31
5.3.1	Title Bar Menu Options.....	32
6	Setup	33
6.1	Overview of the Setup Procedures.....	33
6.2	Assigning Repeater a Recognizable Name	33
6.3	CSR Channel Configuration.....	34
6.4	Setting Date and Time	36
6.5	Additional Configuration Options	36
6.5.1	Configuring External Alarms.....	36
6.5.2	IP Address.....	37
6.5.3	SNMP Support.....	38
6.5.4	TCP/IP and Ethernet	39
6.5.5	Modem Setup	40
6.6	Integration into the AEM.....	42
7	Administration and Monitoring.....	43
7.1	User Accounts	43
7.1.1	Default User Accounts.....	43
7.1.2	User Access Levels.....	43
7.1.3	Password Change	44
7.2	Reboot	44
7.3	Axell Shell	45
8	Monitoring and Troubleshooting.....	46
8.1	Monitoring.....	46
8.1.1	Logs Screen	46
8.1.2	Alarm Classification and Thresholds.....	47
8.1.3	Home Screen Monitoring.....	49
8.1.4	Site Information and System Performance	50
8.2	Module LEDs.....	51
8.2.1	Control Module LEDs	51
8.2.2	Power Supply LEDs	51
8.3	Troubleshooting Remote Communication	53
8.3.1	Direct Modem Access	53
8.3.2	Trace Modem	54
8.3.3	Manually Answering Incoming Calls.....	55
8.3.4	Common Problems.....	56
9	Maintenance	58
9.1	General	58
9.2	Preventative Maintenance	58
9.3	Component Replacement.....	58
9.4	Product Disposal.....	58
9.5	Replacing Backup Battery.....	58
9.6	Troubleshooting	59
9.7	Component Replacement.....	59
9.8	Product Disposal.....	59
	Appendix A - Specification	60

1 Introduction

The Axell CSR 3604 A284Series (Channel Selective Repeater) is a repeater operating in the UHF bands of 421 MHz to 430MHz. Channel selective repeaters are mainly used for in-building coverage, as well as coverage of dead zones, shadows, or other uncovered patches within the current coverage area. The gap-filler repeaters can be used as a complement to the network of base stations. They acquire their signal over-the-air from the Base Station and transmit over the designated coverage area via service antennas.

A range of CSR repeater models are available for various site coverage requirements. This manual describes the installation procedure for the US market.



Figure 1-1. CSR 3604-3304 Repeater Model

1.1 Features and Capabilities

- Standard frequency ranges available UL/DL
-
- Supports up to 8 channels
 - Output Power per carrier DL/UL: 421-430MHz
 - 2 carriers: 33/33dBm
 - 4 carriers: 30/30dBm
 - 8 carriers: 27/27dBm
- Gain (in 1 dB steps): 55 to 85 dB
- Large repeater coverage footprint due to high output power and gain
- Very low propagation delay leading to higher security, resilience and availability of information
- Easy system implementation with build-in commissioning tools
- Time-slot based ALC
- Supervision available over Radio modems
- Remotely upgradeable for future challenges
- Ethernet and Wireless modem connection for remote management
- Backup battery for 'last gasp' modem indication (sending fault error before power failure)
- Can connect to either 110VAC or -48V power (model dependent)

1.2 Rechargeable Battery Pack

In the event of a power disruption this battery will supply the modem and the Control Module with power for enough time so the repeater can send out an alarm.

1.3 CSR 3604-A284Series Interfaces

1.3.1 CSR 3604-A284Series– Wall Mount Casing

1.3.1.1 Front Cover

The repeater is secured with two hex screws (M8) and can also be locked with a key..

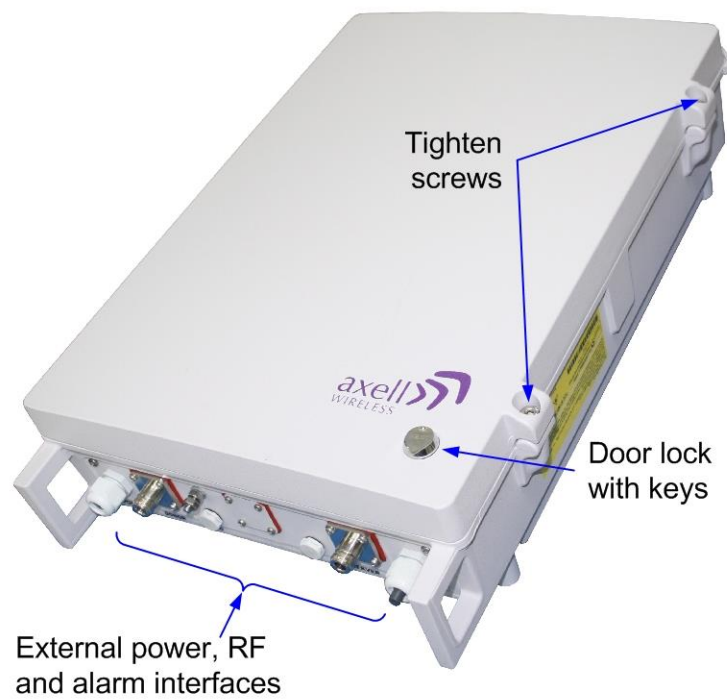

Figure 1-2. CSR 3604-A284Series Enclosure

IMPORTANT: The two locks must be securely closed. Failure to do so may affect the **IP65** compliancy and therefore any warranty.

1.3.1.2 External Interfaces

The repeater is secured with two locks located on the repeater door. The repeater interfaces are located on both the left and right side panels as follows:

- Left panel – Base/Donor antenna port
- Right panel – Mobile/Service antenna port as well as power, GND, and alarm connections

NOTE: Depending on your installation, modem antenna and Ethernet ports may also be located on either the left or right panel.

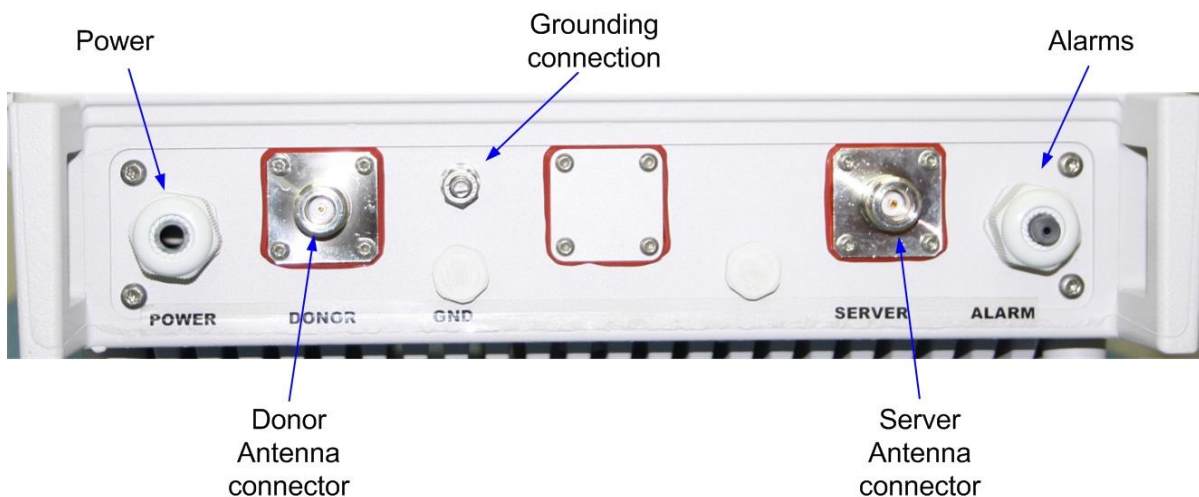

Figure 1-3 External Interfaces on Underside Panel

The following table provides a description of the interfaces shown above.

Port	Description
Donor Antenna	Connection to antenna towards Base Station. Connection – N type female connector.
Service/Mobile antenna	Connection to mobile (service) antennas. Connection - N type female connector.
Power	Plinth connection for routing power for internal connection (See section 4.11)
GND	Grounding lug (See section 4.6)
Alarms	Plinth connector for routing external alarms and relay wiring cable for internal connections (See section 4.10).

1.3.1.3 Internal Interfaces

The following internal interfaces are relevant to the user operations:

- Ethernet port used for setup (and optionally, for remote management)
- RS232 port used for local setup connection
- SIM card slot (On Control module, for models supporting a modem)
- Power and battery switches
- Backup Battery

NOTE: The rechargeable battery pack is located internally and is accessed by opening the repeater.

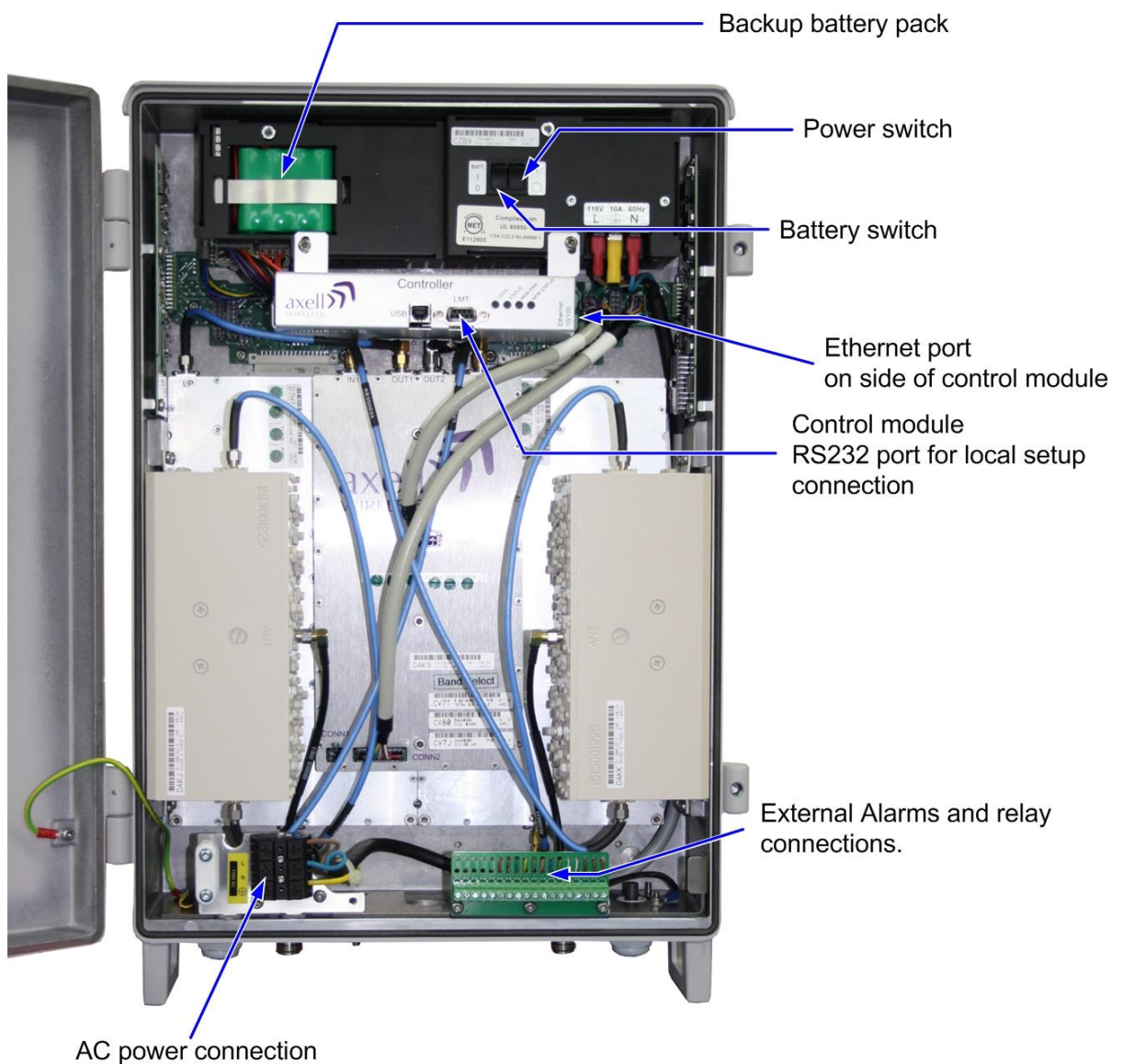

1-4. CSR with door open

2 Antenna Specifications and Installation Criteria

WARNING!!!

The installer is held accountable for implementing the rules required for deployment.

Good engineering practice must be used to avoid interference.

Output power should be reduced to solve any IMD interference issues.

This chapter provides information on the specifications of the donor and service antennas suitable for operation with this repeater, and on the installation requirements of the antennas.

NOTE: The Donor and Mobile antennas can be positioned and installed (without connection to the Repeater) at any time either before or after mounting and grounding the Repeater.

2.1 Base (Donor) Antenna

The Base (Donor) antenna is usually installed outdoors and is either a directional antenna such as a Yagi or a Panel antenna.

2.1.1 Required Antenna Information

You will require the following antenna information:

- Antenna type and characteristics
- Height
- Length and type of coaxial cable required for connecting the Donor antenna to the Repeater and the attenuation.

2.1.2 Donor Antenna specification

- Very sharp beam pointed to the BTS.
- Minimum cable and jumper loss = 2dB.

Equation (2) - Max DONOR antenna gain

Max DONOR antenna gain (dBi) = 39.1 – (37dBm - cable losses in dB).

For example:

No. of Antennas	Cable Losses	Max Allowed Antenna Gain
1	10	39.1 - (37-10) = 12.1dBi

Typical Antenna Types:

- 4 element yagi 8.8dBi beam width 90°
- 6 element yagi 10.3dBi beam width 64°

2.1.3 Installation Criteria

Installation requirements:

- Select a location for the Donor antenna and verify that there is enough signal strength at that location.
- Install the Donor Antenna at the designated height.
- The antenna should point to the direction of the base station for maximum input power.
- Verify that the antenna is in the base stations line of sight (raise the antenna if necessary).
- Install the donor antenna at a higher level (i.e. floor) than the mobile antenna.

2.2 Service Antenna Requirements



WARNING!!!

- a. The installer is held accountable for implementing the rules required for deployment.
- b. Good engineering practice must be used to avoid interference.
- c. Output power should be reduced to solve any IMD interference issues”

The Service antenna type depends on the design of the indoors DAS.

2.2.1 Required Antenna Information

The following antenna requirements, specifications and site considerations should be met:

- Type of installation – indoor DAS/Radiating Cable
- Service area type and size
- Antenna type and characteristics
- Height
- Length and type of coaxial cable required for connecting the antenna to the Repeater and the attenuation.

2.2.2 Indoor Installations

2.2.2.1 Recommended Antennas

The following describes the requirements for an omni-directional mobile used for indoor applications.

Specifications:

- One or a combination of the following antennas can be used: Ceiling Mount Patch antenna, Wall Mount Patch antenna, Corner Reflector.
- Choose an antenna with high side lobe attenuation which enables maximum isolation from the service/ mobile antenna.

Equation (1) - Max SERVICE antenna gain

Max SERVICE antenna gain (dBi) = 39.1 – (37dBm - # of antennas in dB – cable losses in dB).

For example:

No. of Antennas	Cable Losses	Max Allowed Antenna Gain
4	3	39.1 - (37-6-3) = 11.1dBi
1	3	39.1- (37-0-3) = 5.1dBi
10	3	39.1- (37-10-3) = 15.1dBi

Typical Antenna Types:

- Indoor Dome 2.1dBi beam width 360°
- Indoor Panel 4.2dBi beam width 106°
- Radiating Cable Typically < -50dBi

2.2.2.2 Recommended Splitters and Couplers

Axell Wireless can supply a comprehensive range of splitters and Couplers to aid the installation of the internal DAS system. Typical specifications as below:

Splitter Part Numbers	90-851202	90-851203	90-851204
Frequency Band	300 - 500MHz		
Split	2 way	3 way	4 way
Max Insertion Loss	0.3dB	0.5dB	0.4dB
Split Loss	3dB	4.8dB	6dB

Coupler Part Number	90-852306	90-852310	90-852315	90-852320
Frequency Band	300 - 500MHz			
Coupling	-6dB ±1.0dB	-10dB ±1.0dB	-15dB ±1.0dB	-20dB ±1.0dB
Max Mainline Loss	1.7dB	0.8dB	0.4dB	0.22dB

2.2.2.3 Installation Criteria

Determine the antenna installation configuration, according to the transmission requirements and the installation site conditions.

Installation requirements:

- An indoor antenna should be installed at a convenient location. It should be free of metallic obstruction.
- Install the Service Antenna at the designated height and tune it roughly toward the Service coverage area.

2.3 RF Cabling Requirements

- For all coaxial connections to/from the Repeater - high performance, flexible, low loss 50Ω coaxial communications cable.
- All cables shall be weather-resistant type.
- Cable length - determined by the Repeater installation plan. When calculating the cable length, take into account excess cable slack so as not to limit the insertion paths.
- Make sure that cable and connector are compatible. Using cables and connectors from the same manufacturer is helpful.
- All connectors must be clean and dry
- Waterproof all outdoor connections using silicone, vulcanizable tape or other suitable substance as moisture and dust can impair RF characteristics.
- Make sure enough room has been allocated for the bending radius of the cable. RF cables must not be kinked, cut or damaged in any way
- Connect the RF cable to the antenna tightly but without damaging threads
- Fasten cables tight to cable ladder or aluminum sheet
- For short length of feeder cables use 1/2", for longer feeder cables use 7/8". Choose thicker coax cables for lower attenuation. Minimize the length of the coax cables to reduce the attenuation
- Use jumper cable for easy installation. The RF Coaxial cable can be substituted at each end with a jumper cable.

3 Pre-Installation Requirements

3.1 Safety Guidelines

Before installing the Repeater, review the following safety information:

- Follow all local safety regulations when installing the Repeater.
- Only qualified personnel are authorized to install and maintain the Repeater.
- Ground the Repeater with the grounding bolt located on the underside of the Repeater.
- Do not use the grounding bolt to connect external devices.
- Follow Electro-Static Discharge (ESD) precautions.

3.2 Required BTS Information

Required BTS Information

- BTS channels
- BTS output power per channel
- BTS antenna gain
- BTS antenna height
- Distance from Repeater site to BTS

3.3 Selecting a Location

Select a location that will take into account the following criteria:

- Relative location of Base Station
- Cooling and airflow
- Wall compatibility
- Access to the repeater for installation or maintenance

3.3.1 Relative Location of Base Station

The repeater site shall be located where the BTS signal strength is great enough to be recognized by the system. For example, a CSR 3604-3304 (85dBm max gain) and signal strength of -70dBm at the pickup antenna, a gain in the pickup antenna of 10dBi, a repeater gain of 85dBm and a server antenna gain of 2dBi the resulting ERP would be 27dBm. Losses in cables and other elements would change these figures slightly.

- Repeater location near enough to BTS for received signal to be of adequate strength
- Ideally the repeater's donor antenna should have line of sight (LOS) contact with the BTS antenna. If the signal strength is high enough, LOS may in some cases not be necessary.
- Distance from antenna site - It is recommended that the installation location be as close as possible to the antenna site in order to maintain the cable loss to a minimum.

3.3.2 Cooling and Airflow

- Install the Repeater in a shielded, ventilated, and easy-to-reach area.
- The Repeater is convection cooled so airflow and alternation should be possible.
- Verify that ambient temperature of the environment does not exceed 50°C (122°F)

Mount the repeater so that heat can be dispersed from it. The repeater wall mounting kit ensures an optimum airflow between the wall and the repeater itself. Do not block this air

channel as it will cause the MTBF of the repeater to drop dramatically, or even in the worst case cause the repeater to fail completely.

If possible use a wall in the shadow to minimize the overall sun loading. If sufficient shielding cannot be obtained, an additional sun shield should be mounted.



3-1. Example of a sun shield outdoors

Operating Temperature

The CSR repeaters are designed primarily for multi carrier purposes. If the repeater is run at full output power over a long period of time the convection cooling might not be enough. The repeater has a power management function implemented that will step down the power and if needed fully shut down the amplifier chains until temperature has reached normal values. In situations where a repeater will be run in such a manner extra cooling can be provided for instance by putting the repeater in a temperature controlled environment or via external fans.

3.3.3 Wall Compatibility

- Check the suitability of the wall on which the Repeater is to be mounted.
- The Repeater wall mount brackets assembly should be fixed to a solid wall (these include brickwork, blockwork, and concrete.);
- (Due to the weight of the Repeater, it is NOT recommended to fix to a hollow wall).

3.3.4 Access to the Repeater

- **Plan connection cable clearances** - the Optical, RF and power connections located on the underside of the Repeater will need at least 300mm vertical clearance below the Repeater to enable the connections to be made. The minimum bend radius for Optical and RF cables must not be less than the recommendations made by the cable manufacturer. Plan the cable runs and ensure adequate space is available.
- **Allow for door opening** - ensure that there is sufficient space at the front of the Repeater to allow the door to be fully opened and for maintenance engineers to get access to the unit with test equipment such as a spectrum analyzer.
- **Allow space around the repeater** - verify that there is a minimum of a 50 cm (20") radius of space around the Repeater, enabling easy access to the repeater for maintenance and on-site inspection. Allow an additional 50 cm of space in front of the Repeater when the door is fully open.
- **Monitoring repeater** - install the Repeater close to the service area to monitor the output power.

4 Physical Installation

4.1 Overview of the Installation Procedure

Note the following:

- The Donor and Mobile antennas can be positioned and installed (**without connection to the Repeater**) at any time either before or after mounting and grounding the Repeater.
- It is important to perform the installation procedure according to the order described below..

System installation phases:

1. Determine an appropriate location for the system according to the requirements described in section 3.3.
2. Unpack the Repeater Kit
3. Assemble the brackets and mount the CSR Repeater on the (concrete or brick) wall (see 4.4.).
4. For models supporting a modem:
Insert the SIM card (requires opening repeater door).
Connect the modem antenna (external port)
5. Ground the Repeater (see 4.6)
6. If you have not already done so, position and install the Base and Mobile antennas in the relevant locations (see chapter 2).
7. Before powering up the Repeater:
Verify isolation between the donor and mobile antennas.
Verify link between BTS and Base Repeater.
Connect the Donor and Service antennas to the Repeater.
8. Power-up the Repeater.
WARNING! Be sure to perform the power supply connection last, otherwise damage may be caused to the system!
9. Optional - Connect the external alarms. This can be done at any time, before or after powering up the Repeater.
10. Initial system setup. See Chapter 6

4.2 Required Tools and Materials

A standard professional toolbox is required in order to mount the Repeater.

4.3 Unpacking

Upon receiving the CSR Repeater perform the following:

1. Examine the shipping container for damage before unpacking the unit.
2. Perform a visual inspection to reveal any physical damage to the equipment.
3. Verify that all of the equipment (listed below) is included. Otherwise contact Axell Wireless Ltd. The CSR Repeater is shipped with the following equipment:

- Checklist with delivered items
- Repeater
- Mounting brackets
- bolts for attaching repeater to mounting kit
- Cable cover
- Keys to repeater and hex tool for bolts
- CD containing User's Manual and RMC

Any other specifically ordered item

4.4 Wallmount Procedure

- **Wall compatibility** - check the suitability of the wall on which the Repeater is to be fitted.
- **Plan mount** - check the actual fixing centers (see below) and overall dimensions of the Repeater enclosure. The Repeater is supplied with two wall mounting brackets; when the Repeater is mounted on these brackets adequate ventilation is provided between the Repeater and the wall to which it is fixed.
- **Plan connection cable clearances** - the Optical, RF and power connections located on the underside of the Repeater will need at least 300mm vertical clearance below the Repeater to enable the connections to be made. The minimum bend radius for Optical and RF cables must not be less than the recommendations made by the cable manufacturer. Plan the cable runs and ensure adequate space is available.
- **Allow for door opening** - ensure that there is sufficient space at the front of the Repeater to allow the door to be fully opened and for maintenance engineers to get access to the unit with test equipment such as a spectrum analyzer. Allow an additional 500mm of space in front of the Repeater when the door is fully open.
- **Fix bolts** –fix M6 Rawlbolts or similar (50 to 75mm in length) into the wall at the dimensions as illustrated in figure 1 below using equipment as specified by the fixing manufacturer. A recommended method is set out below. Care must be taken to ensure the alignment of the four fixings. A spirit level or plumb line should be used to ensure horizontal/vertical alignment.

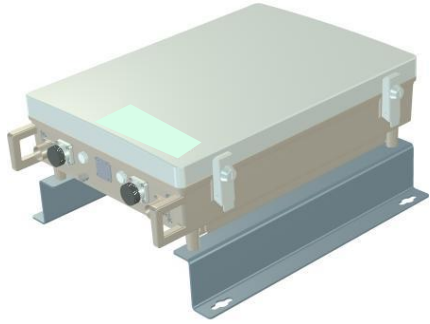
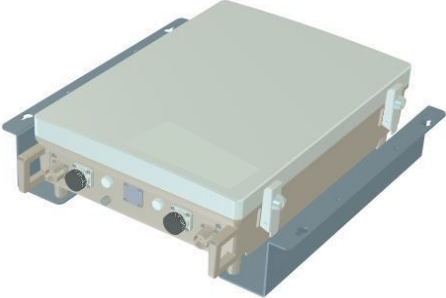
	Wall-mount bracket position	Rack-mount bracket position
Single/Dual Clamshell Casing		

4.5 Dimensions and Bracket Assembly

4.5.1 Bracket Assembly

Fix mounting brackets to Repeater – use the supplied four M8 bolts and spring washers.

Fix mounting brackets to Repeater
with M8 fixing bolts and spring
washers supplied

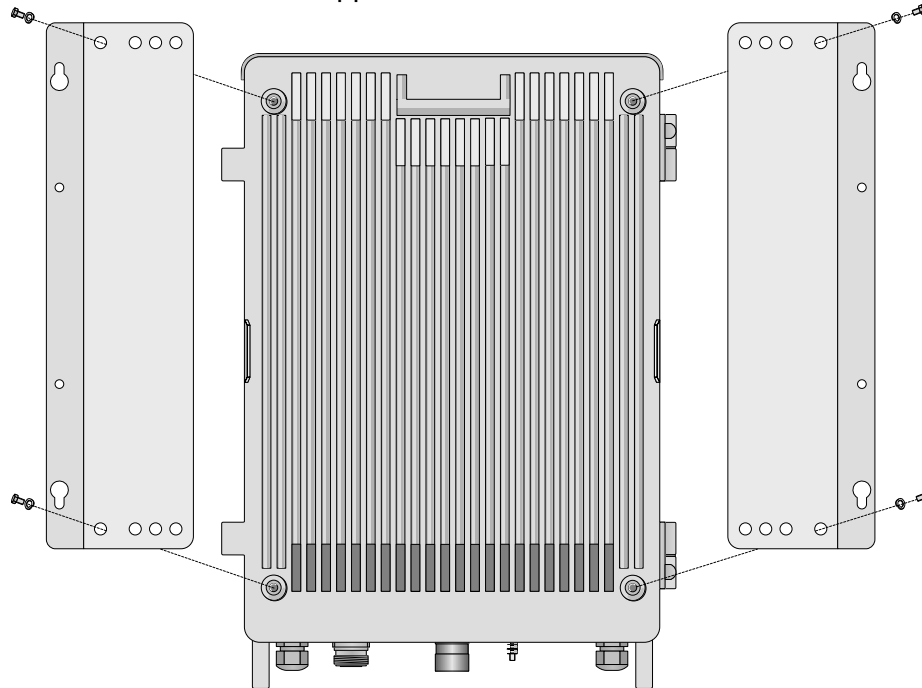

Figure 4-1. Fix mounting plates to Repeater

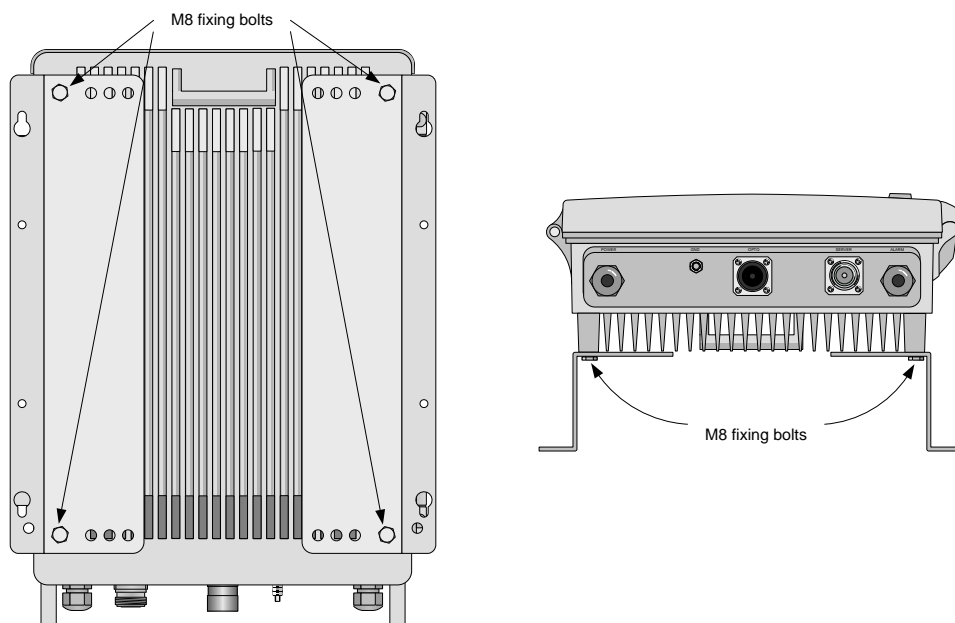

Figure 4-2. Mounting Plates Fixed to Repeater – Single/Dual Clamshell

4.5.2 Fixing Centers

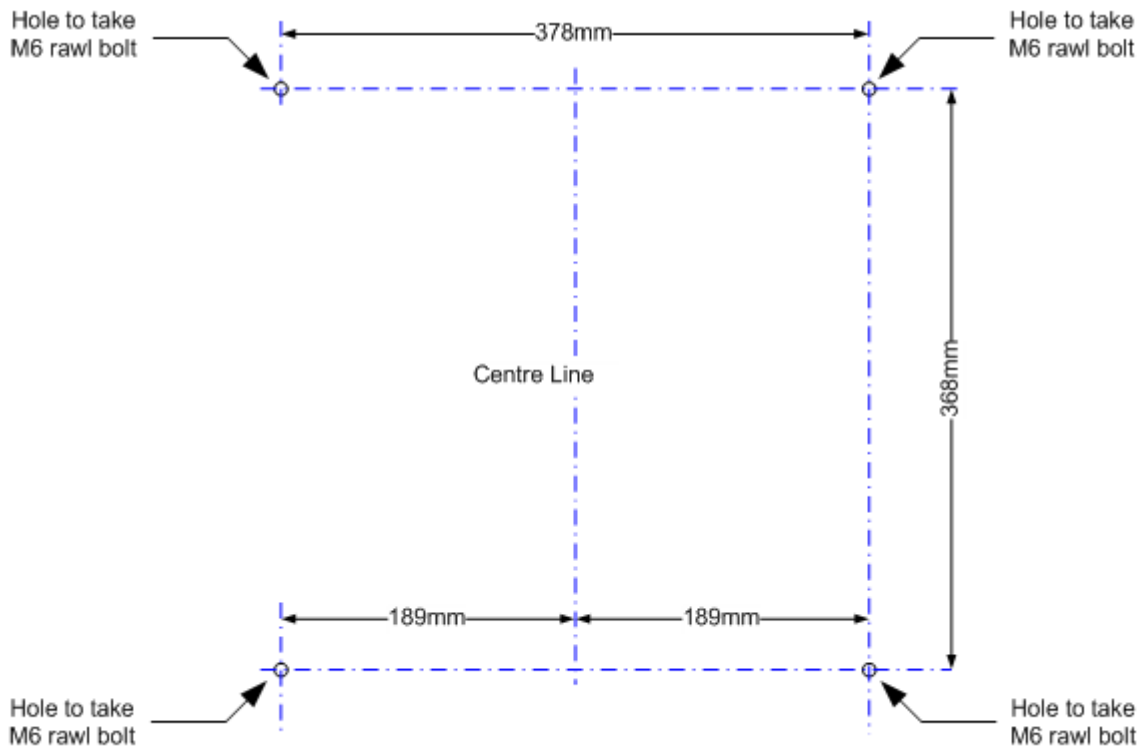

Figure 4-3. Fixing Centers – Single/Dual Clamshell

4.5.3 Requirements

The Repeater wall mount brackets assembly should be fixed to a solid wall (these include brickwork, blockwork, and concrete.);

Due to the weight of the Repeater, it is NOT recommended to fix to a hollow wall.

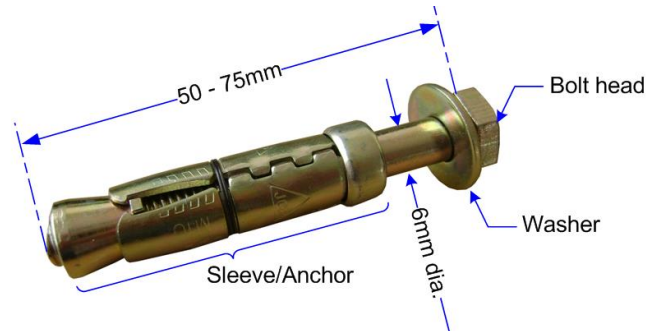

Figure 4-4. M6 Rawlbolt – recommended for wallmount.

IMPORTANT!

Always check that there are no pipes or cables hidden in the wall beneath the area to be drilled. Various pipe and cable detectors are available for this type of inspection.

To provide secure fixing to a solid wall, the most common method is drilling and plugging. The size of fixing is dependent on the item to be fixed and the nature of the wall, The Repeater should be fixed with mild steel, M6 (50mm to 75mm) Rawl bolts or similar.

4.5.4 Planning the Repeater Location and Drilling

1. Mark out on the chosen wall the fixing centres of the repeater and the location of the brackets.
2. Mark and drill the wall with the correct size masonry bit as specified by the fixing manufacturer.

WARNING: It is good practice to wear goggles to protect your eyes from flying debris when using power tools.

3. Hold the drill bit against the mark and begin drilling slowly so that the bit does not wander from the position. The wall should be drilled to a depth which is sufficient to accommodate the full length of the fixing.
4. Insert the fixings so that the top of the sleeve/anchor section is level with the wall surface.
5. Gently tighten the bolt by hand so that the anchor section of the fixing expands and grips the inside of the hole.

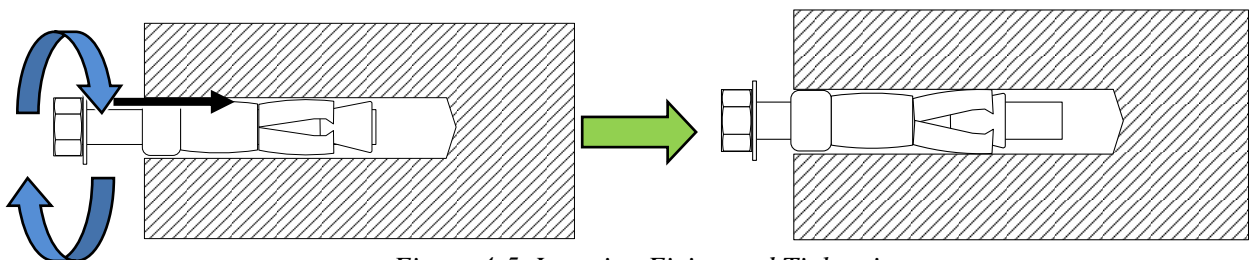

Figure 4-5. Inserting Fixing and Tightening

6. As the bolt pulls its way in, the sides of the anchor section are forced outwards, gripping the surrounding surface.

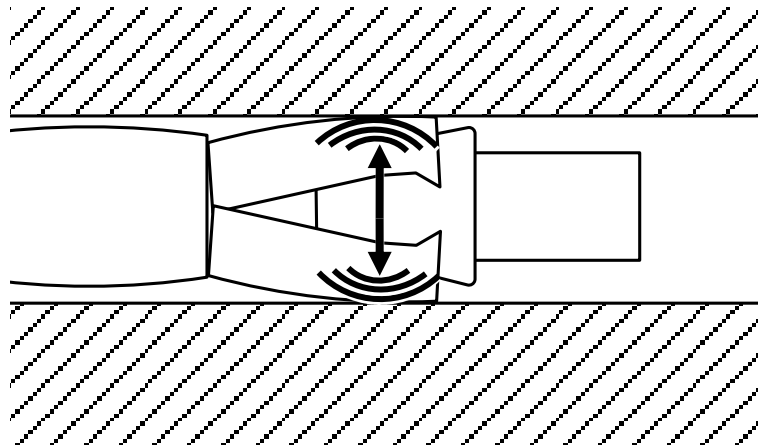

Figure 4-6 Anchor Sides Pushed Outwards

7. Once all four fixings are in place, carefully withdraw the four bolts.

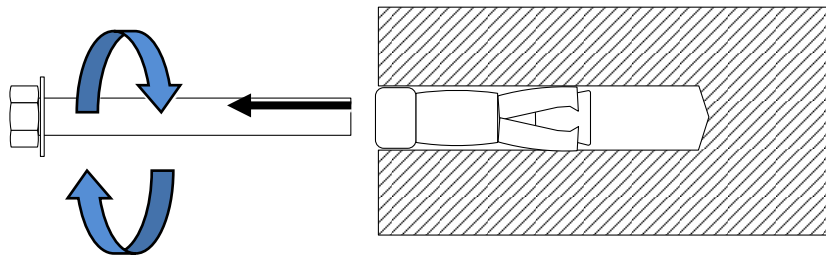

Figure 4-7. Withdraw Bolts.

4.5.5 Hanging the Repeater on the Wall

1. Align repeater with the four fixings. Exercise great care as the repeater is very heavy (a suitably rated heavy duty scissor lift table/trolley may be suitable for this operation).
2. Carefully insert the fixing bolts through the mounting lugs of the Repeater and into the sleeve/anchor sections of the fixing in the wall and tighten the bolts.

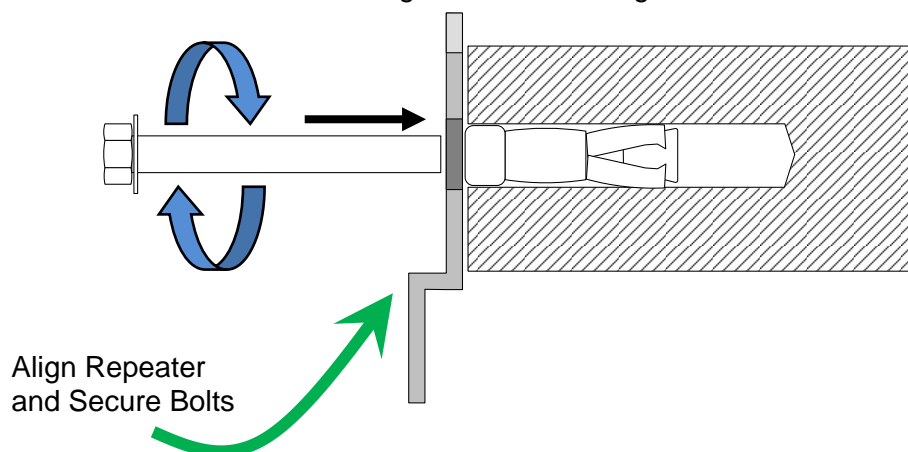

Figure 4-8. Mount Repeater.

4.6 Grounding

1. GND the repeater grounding bolt.
2. Ensure that good grounding protection measures are taken to create a reliable repeater site.
3. Make sure to use adequately dimensioned grounding cables. The minimum recommended conductive area for a grounding cable is 16mm².

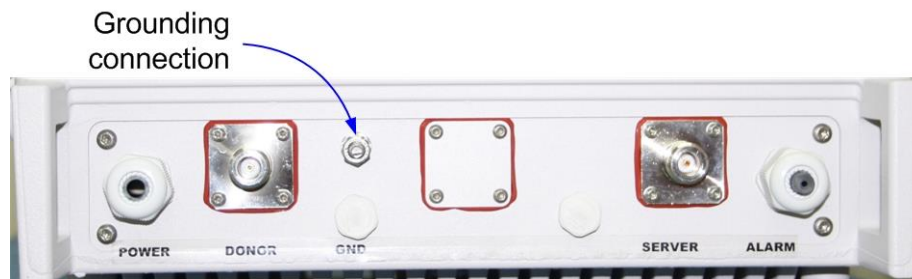

Figure 4-9. Grounding

4.7 EMV Protection

CAUTION! If insufficient Electromagnetic Protection is provided, or if EMV measures are not taken, warranties issued by Axell Wireless are not valid.

The lightning hazard to electric and electronic equipment consists in the interferences of direct lightning current infections and high surge voltages induced by the electromagnetic field of nearby lightning channels or down conductors. Amplitudes from cloud-to-earth lightning amounts to several 10kA and may last longer than 2(ms). The damage caused depends on the energy involved and on the sensitivity of the electronics systems.

Ensure that lightning protection measures are taken to create a reliable repeater site. Protect all coaxial cables and power cables from the transients caused by lightning. Fit all cables with suitable lightning protection devices.

For detailed information please refer to IEC 61024-1 and 61312-1 for international standards for protection of information systems against LEMP, Lightning Electromagnetic Pulse, including radio transmitters. They define proper planning, installation and inspection of effective lightning protection systems.

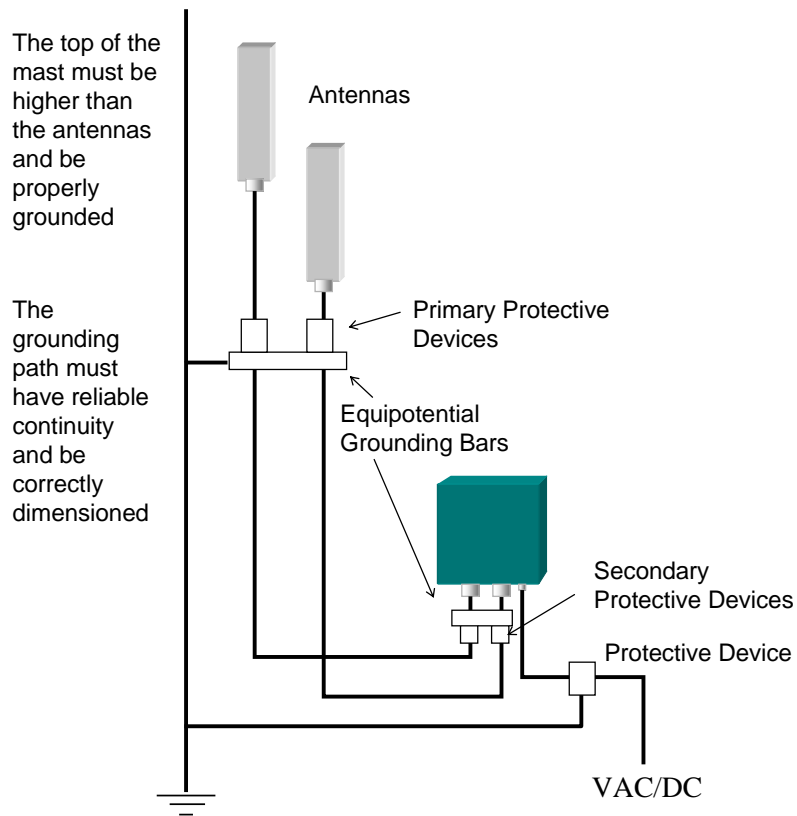

Figure 4-10. Example of EMV protection for a repeater system

About installing lightning protection devices:

- Several lightning protection devices should be used in series with declining threshold voltages to help attenuate the pulse component which makes it through the first layer of protection.
- The primary protective device is part of the site installation and is not supplied by Axell Wireless. Coaxial lightning protection is normally one of these three types: Gas capsule, High-pass and Bandpass.
- There also need to be a protective device installed on the power supply cord.

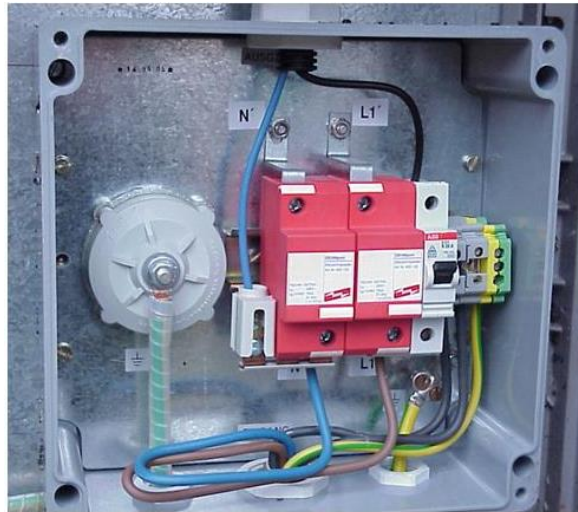
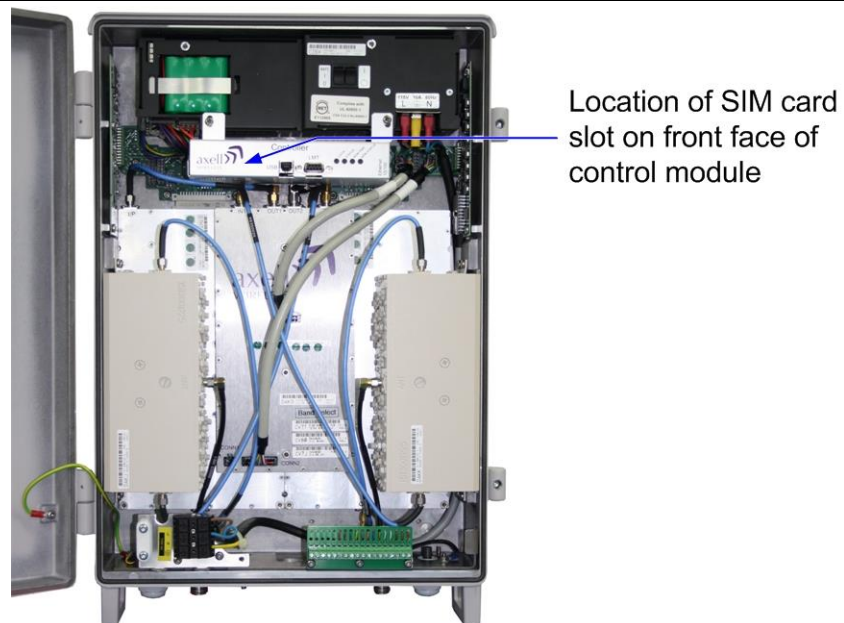

Figure 4-11. Protective device installed in connection with the power supply

4.8 Insert SIM Card

For models supporting GPRS/GSM or PSTN/GSM modems, open the repeater door and insert the SIM card in the slot as illustrated below.

NOTE: You will also need to configure the modem according to section 6.5.5.



4-1. Insert SIM card

4.9 Antenna (RF) Connections

4.9.1 Verifying the Link between the BTS and the Repeater

This test checks the signal strength from the BTS antenna to the Repeater.

Proceed as follows:

1. Using a Spectrum analyzer, measure the received signal from BTS at the Donor antenna port near the Repeater.
2. Adjust the Donor antenna direction to receive the maximum signal strength.
3. Compare the received signal strength with the calculated signal strength from the design phase.

In case of discrepancy, check for one of the following:

- Antenna out of direction
- Antenna tuned to side lobe instead of main lobe
- Antenna connector or antenna cable faulty
- Line-of-sight problem (obstruction), etc.
- Register the signal strength of the downlink channel for the system operation phase.

Refer to the following figure for the CSR RF antenna connections.

NOTE: For models supporting a GPRS modem, you may also connect the modem antennas at this stage. If your repeater includes a modem, the modem antenna port may either be on the left or right panel – depending on your enclosure.



Figure 4-13. Donor AND Mobile Antenna Connections

4.10 External Alarm and Relay (Internal Alarm) Connections



Figure 4-14. Alarm and Relay Connections

The External Alarm and Relay connections requires manual wiring – inserting the cable via the external connector and wiring the plinth located inside the repeater according to the instructions given in this section.

About the external alarms

Four external alarm sources can be connected to the External Alarm module in the repeater (such as fire alarms or external door sensors). The repeater is equipped with an external alarm interface card. The connector plinth for the external alarms is located externally.

The alarm sources must generate a voltage between 12 and 24 VDC. The presence or absence of voltage will trigger the alarm depending on how alarm thresholds have been configured in the controller software (see section **Error! Reference source not found.**).

The strain relief fitting in is a Pg 13.5 suitable for a 6-12 mm cable diameter.

Connect the alarm cords to the plinth according to the pin layout below (in the standard version pins 14 – 18 are not used).

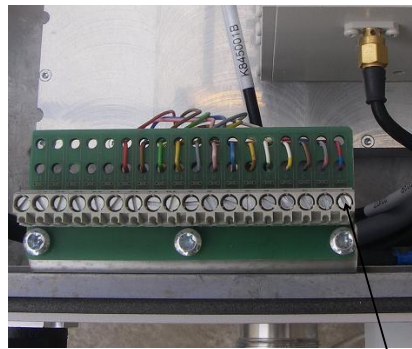

Pin #	Signal
1	External alarm 1A
2	External alarm 1B
3	External alarm 2A
4	External alarm 2B
5	External alarm 3A
6	External alarm 3B
7	External alarm 4A
8	External alarm 4B
9	Alarm +15V
10	Alarm 0V
11	Relay Output 1A
12	Relay Output 1B
13	GND
14	NC
15	NC
16	NC
17	NC
18	NC

Figure 4-15. External Alarm and Dry Contact Connections

NOTE: The External Alarms connections can be protected with a cover which is screwed in place.

4.10.1 External Alarm

- Four external alarm sources can be connected to the repeater.
- Alarm operating voltage: between 12 and 24VDC.
- Alarm polarity can be configured:
Active-low - when there is no voltage the alarm indicator will turn red
Active-high - an applied voltage of between 12 and 24 V will cause the external alarm indicator to turn red.
- The repeater can supply +15 VDC to an external alarm source through pin 9 and 10. The maximum allowed load is 100mA.

4.10.2 Relay

- Relay (pin 11 and 12) can be connected to an external device to indicate an alarm.
- Can be configured to trigger on any number of internal and external alarms. The maximum current that can be supplied is 100mA.

4.11 Power Connections

Caution! Make sure the antenna cables or 50 ohm terminations are connected to the repeater's antenna connectors before the repeater is turned on.

Caution! Be sure a CIRCUIT BREAKER meeting the instructions given in this section is connected near the unit at an easily reachable and accessible location from the unit.

4.11.1 Circuit Breaker Connections

To disconnect the unit (either manually or automatically in case of over-current), it is required to install a circuit breaker *on the wall near* the unit, at an easily accessible distance and location from the unit.

Circuit-breaker minimum requirements

- 10AT, 115V AC
- Needs to be SAFETY approved
- Requires minimum contact separation of 3mm.
- Install on the wall near the unit

4.11.2 110/115v AC Power Source Connection

Cable requirements:

- Cable should be NRTL (safety) approved with a minimum of 14AWG (2.5mm) per conductor.
- For safety, the GND cable must be **10mm longer** than the Phase and Neutral cables.

Connect the power cable to the plinth as show below:

- **Phase** linked to the **Black** cable
- **Neutral** linked to the **White**
- **Ground** to the **Green** where for SAFETY, the GND cable must be **10mm longer** than the Phase and Neutral cables.



Figure 4-16 115V AC Power Source Connection

4.11.3 Switching Power ON

To switch the repeater ON

1. Open repeater door to access switches.
2. Set to ON both Power and Battery switches (located inside the repeater).
3. Connect the supplied power cable between the Repeater Power connector and the circuit breaker.
4. Turn the repeater on from the circuit breaker.
5. Verify the LEDs from the following internal modules are indicating correct operation (section 8.1):
 - Control module.
 - Power supply modules

NOTE: To switch power OFF – set battery switch to OFF and power switch to Standby.

Note the following:

- The power switch has two positions; “on” and “stand by”. In the stand by position the repeater is still connected to the power supply but not operational.
- The backup battery is operational for five years. Refer to section 9.3 for backup battery replacement.
- The CSR supports a backup battery for last gasp in case of power failure. To power on the unit, it is required to switch-on both power and backup battery switches.

The image below shows the location of the various power elements.

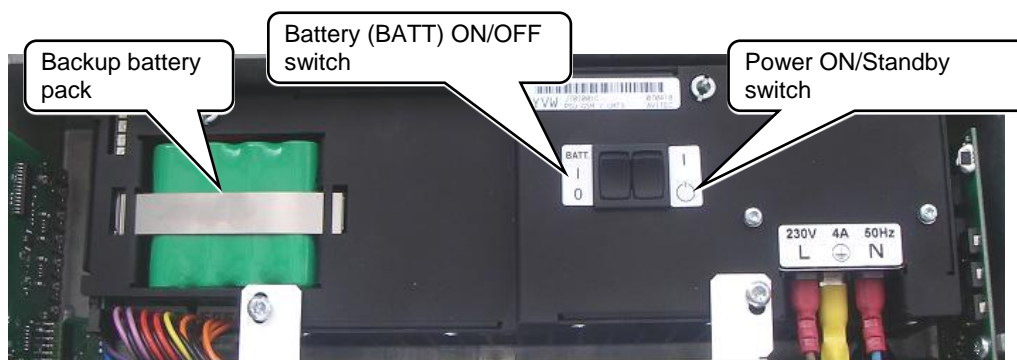

Figure 4-17 Power Elements Inside Repeater

4.11.4 Close and secure the Repeater

Close lid, fully tighten the two screws and lock repeater and continue to the next chapter:

Note! The two screws must be fully tightened. Failure to do so may affect the **IP65** compliancy and therefore any warranty.

5 Login and GUI Navigation

This section describes how to open a session to the repeater, and provides a brief description of the WEB GUI and describes the initial setup procedures.

5.1 Opening a Local Web Session to the Repeater

5.1.1 Connect the Repeater to the Computer

Connect computer to the Repeater Ethernet connection

Using the supplied Ethernet cable, connect either to the internal Ethernet port (located internally at the side of the Controller).

The following figure shows an internal ETH connection – to the side of the controller.

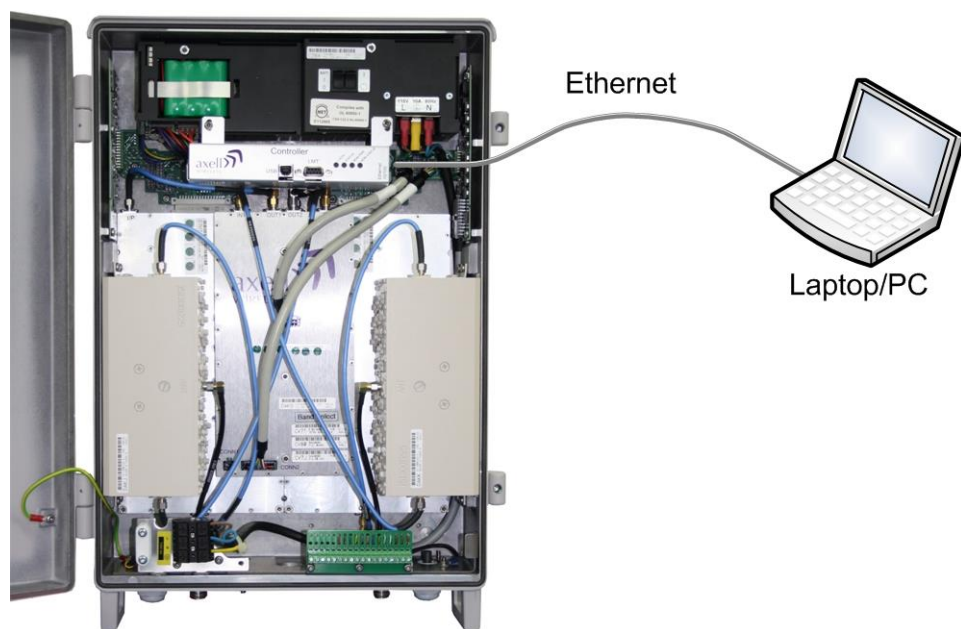

Figure 5-1. Connection to the internal Ethernet port

5.1.2 Configure the Computer Network Parameters

Configure the computer network parameters to communicate with the Repeater. Note that the procedure may vary slightly depending on the operating system installed on your computer. The following procedure is for MS Windows 7.

To configure the computer's network parameters:

1. Click the **Start** menu and choose **Control Panel**.
2. In the Control Panel, click **Network and Internet**.
3. Click Network and Sharing Centre and then click Local Area Connection. The **Local Area Connections Status** dialog appears with the General tab displayed by default.

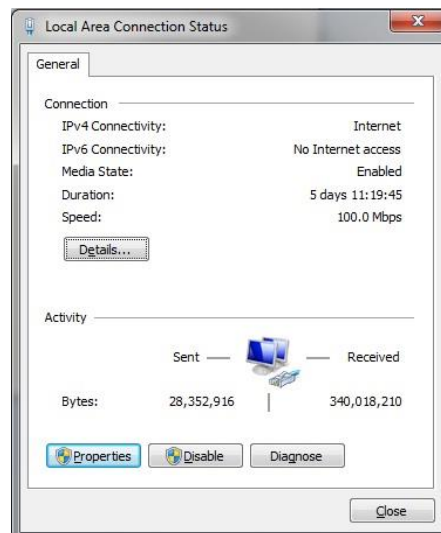

4. Click the **Properties** button. The **Networking** tab appears.

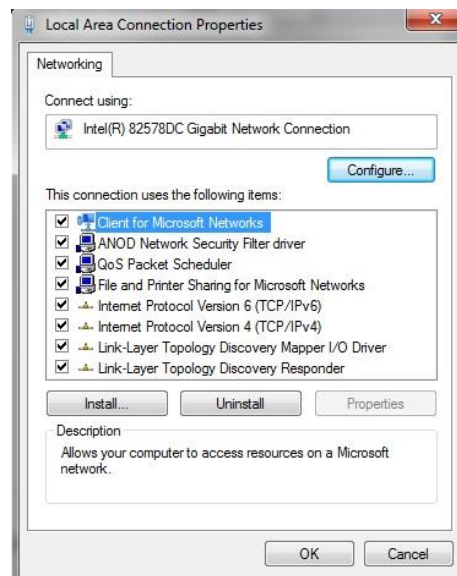

5. In the Items list, double-click the "Internet Protocol Version 4 (TCP*IPv4)" item.
6. The Internet Protocol Version 4 (TCP/IPv4) Properties dialog appears.

Note: The Repeater is supplied with the default IP address 192.168.1.253.

- Assign your computer an IP address in the same subnet, in order to communicate with the unit.

In the IP address area:

Enter the IP address 192.168.1.x, where 'x' can be any number between 2 and 250 inclusive. For example, (192.168.1.9)

Define the subnet mask as shown (255.255.255.0)

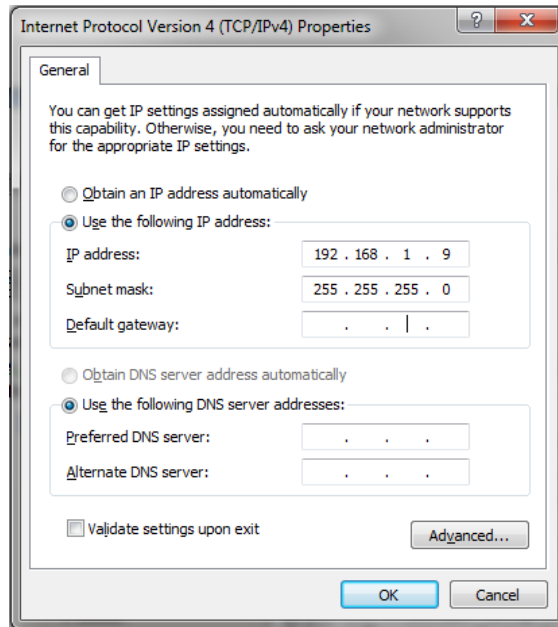

- Click **OK**. The computer communication parameters are now defined and a session to the Repeater can be opened.

5.2 Web Session Login to the Repeater

NOTE: The Repeater is factory assigned the address 192.168.1.253. Initial login is performed using this address; however it is recommended to make the necessary modifications according to information provided by your network administrator.

To login to the Repeater via a web session

1. Open a standard Flash-enabled browser (e.g. Internet Explorer or Firefox).
2. In the address line, enter the IP address of the Repeater. <http://192.168.1.253>. A session will be established with the Repeater and the login dialog appears.

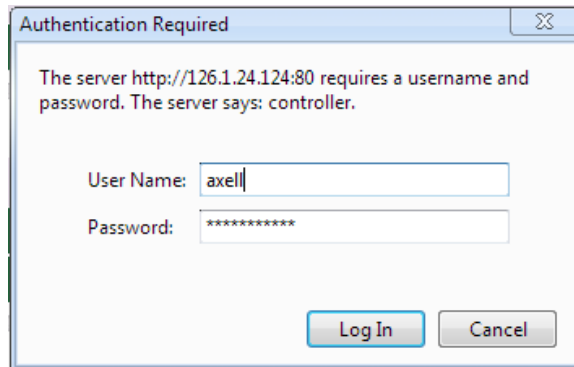

3. Enter the default login values as follows:
Login Name: **axell** (case sensitive)
Password **AxellPasswd** (case sensitive).

Notes:

Do not use the number pad when entering numbers.

For security, it is highly recommended to change the password (section 7).

4. Click **Login**. The application main window appears. The repeater mode appears in the top left side of the Menu bar:
CSR xx02 = Channel operation mode

Repeater Mode

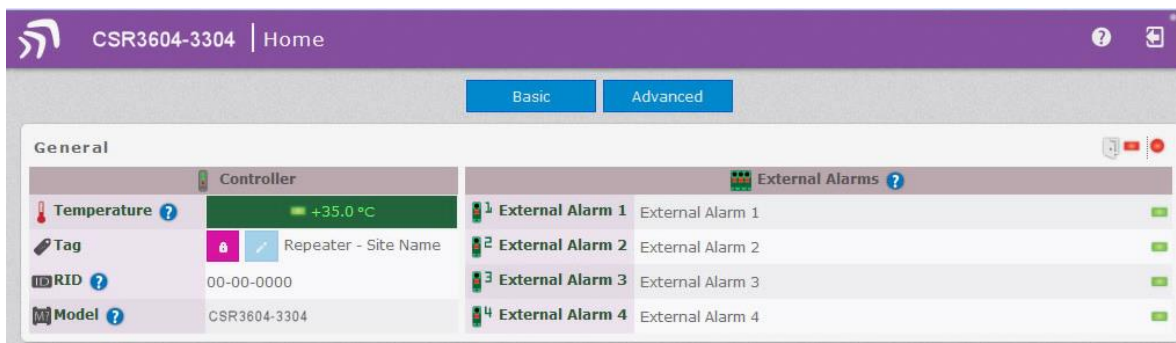

5.3 Navigating the Web GUI Application

NOTE: It is assumed you have already logged in to the Repeater according to section 5.2.

The Web GUI window provides access to the configuration and management options of the CSR units.

The following figure shows an example of the Basic View. The Advanced view provides more options.

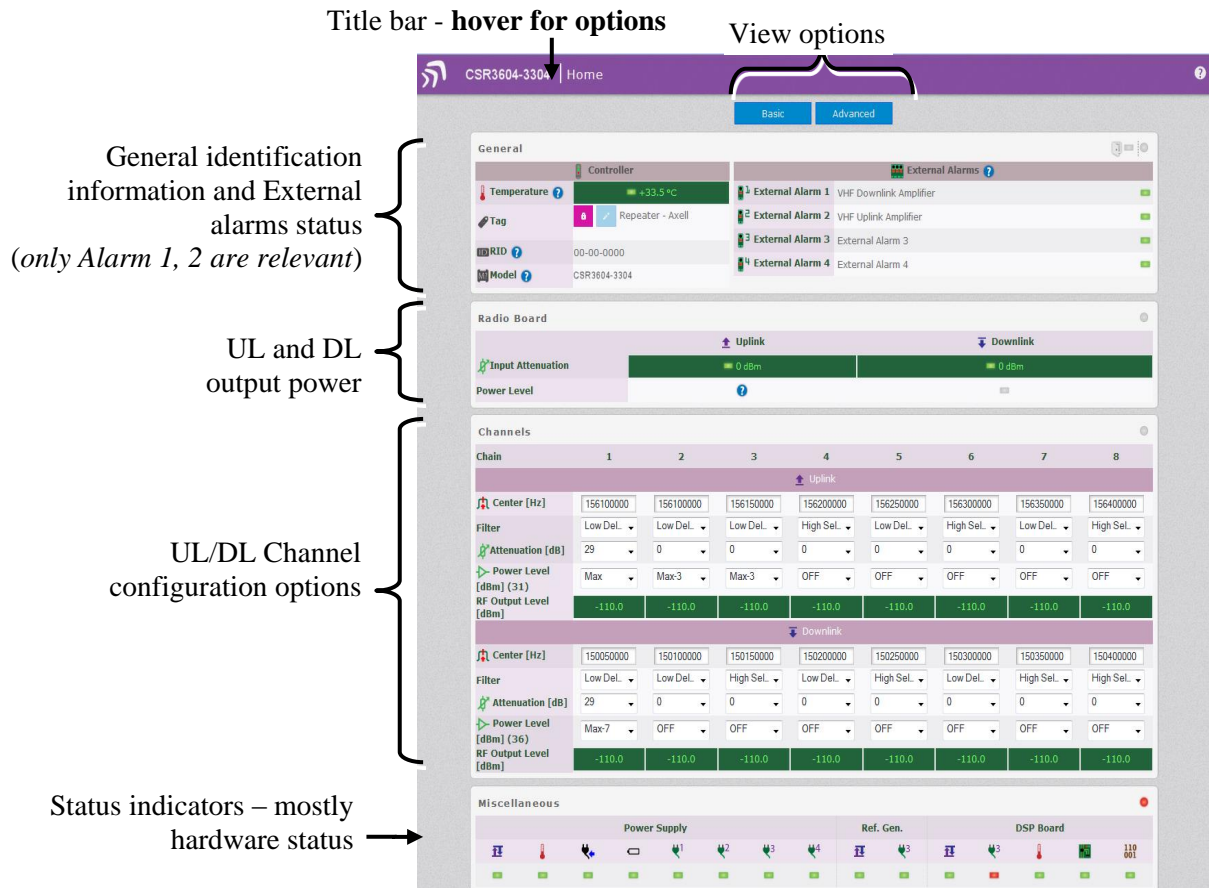

Title bar - hover for options

View options

General identification information and External alarms status
(only Alarm 1, 2 are relevant)

UL and DL output power

UL/DL Channel configuration options

Status indicators – mostly hardware status

The window consists of the following main areas:

- Title bar – provides access to a range of configuration options by *hovering over the bar*. See section 5.3.1 for details.
- View Buttons – Basic (displayed by default) and Advanced display options.
- General information – show user defined repeater name, general identification information and status of external alarms.
- Radio (FCC) – shows current UL and DL power level
- Channels – provides UL and DL channel configuration options and RF output power per channel
- Miscellaneous – status of various parameters, mainly power related

5.3.1 Title Bar Menu Options

NOTE: These options are available by hovering over the Title bar of the main window.

The Menu Bar allows access to all configuration and commissioning options:



Item	Description
Home	This is the default welcome screen. It displays general status information and provides the RF UL and DL channel configuration options.
SNMP	SNMP agent configuration options. (Section 6.5.3.2)
Nodes	Not Applicable
External Alarms	Configure, activate and assign names to two external alarms. (Section 6.5.1)
Logs	List of alarms and operations. Alarms are raised according to user defined Thresholds in Alarm Threshold. (Section 8.1.1)
Alarm Thresholds	Define thresholds for all system alarms (alarms are displayed in Logs). (Section 8.1.2)
Date and Time	Configure the time stamp for dating CSR events. (Section 6.44)
System Information	Display CSR hardware and software identification information and system performance parameters (CPU load average, memory usage and network response time (ms)). (Section 8.1.4)
Password	Change login password. (Section 7) <i>NOTE: It is highly recommended to change the login password.</i>
Reboot	Soft restarts the CSR. (Section 7.2)
Ethernet	Define the IP Address and network parameters for direct remote access via Ethernet. (Section 6.5.2)
Axell Shell	Command line used to communicate with the remote units. List of commands can be found in the <i>Common Commands and Attributes</i> document. (Section 7.3)
Communication	Configure modem parameters (if the unit supports a modem) and view AEM Server IP (provided by AEM). (Section 6.5.5)

6 Setup

This section describes the available setup procedures: required and optional according to your system installation.

6.1 Overview of the Setup Procedures

The following setup procedures are required to operate the repeater:

- Assigning the repeater a recognizable name – for easy identification of the source of events
- Defining channels
- Setting the clock and time – used to timestamp events
- Additional setup procedures – according to your system installation and requirements:
- Configuring external alarms
- IP address – for connection to the Ethernet network
- SNMP support
- TCP/IP
- Modem setup

6.2 Assigning Repeater a Recognizable Name

The CSR is automatically assigned an ID by the AEM. In addition, it is recommended to assign each repeater a recognizable name that will identify the location, site name, etc.

To assign the Tag

NOTE: The repeater tag can be locked in order to prevent being accidentally modified from the AEM side (unlock by clicking on the  button).

1. In the Home screen, under the **General** section next to **Tag**, click the **Edit**  option.



2. Assign the Repeater a name (up to 30 characters) that indicates the location of the Repeater.
3. Click **OK**.

6.3 CSR Channel Configuration

The initial setup procedure consists of defining the required VHF channels. Up to eight channels can be defined, where each channel is defined according to the following parameters:

- UL center frequency and DL center frequency
- Type of channel according to usage (High Selectivity or Low Delay)
- Attenuation
- Power level

To configure channel RF parameters

1. Access the **Home** screen (displayed by default).

A *partial* image showing only the channel definitions area is illustrated below.

Channels		1	2	3	4	5	6	7	8
		Uplink							
Center [MHz]		157.2375	157.11	156.4	156.6	156.8	158	157.2	157.49
Filter		High Sel.	High Sel.	High Sel.	High Sel.	High Sel.	Low DeL.	High Sel.	High Sel.
Attenuation [dB]		0	0	0	0	0	0	0	0
Power Level [dBm] (27)		Max	Max	Max	Max	Max	Max	Max	Max
RF Output Level [dBm]		-45.0	-42.0	-42.0	22.0	22.0	-48.0	22.0	-45.0
ALC		<input checked="" type="checkbox"/>	<input checked="" type="checkbox"/>	<input checked="" type="checkbox"/>	<input checked="" type="checkbox"/>	<input checked="" type="checkbox"/>	<input checked="" type="checkbox"/>	<input checked="" type="checkbox"/>	<input checked="" type="checkbox"/>
		Downlink							
Center [MHz]		151.3	150.2	150.4	150.6	150.8	151	151.2	151.4
Filter		High Sel.	High Sel.	High Sel.	High Sel.	High Sel.	High Sel.	High Sel.	High Sel.
Attenuation [dB]		0	0	0	0	0	0	0	0
Power Level [dBm] (27)		Max	Max	Max	Max	Max	Max	Max	Max
RF Output Level [dBm]		-46.0	-47.0	-47.0	-46.0	-46.0	-47.0	-46.0	-46.0
ALC		<input checked="" type="checkbox"/>	<input checked="" type="checkbox"/>	<input checked="" type="checkbox"/>	<input checked="" type="checkbox"/>	<input checked="" type="checkbox"/>	<input checked="" type="checkbox"/>	<input checked="" type="checkbox"/>	<input checked="" type="checkbox"/>

Uplink channel definitions

Downlink channel definitions

2. Define the **Downlink** and the **Uplink** parameters for each required channel:

- Set the **Centre** frequency.
- Set the type of **Filter** to **Low Delay** or **High Selectivity** according to site requirements.
- Set the **Power Level** according to the following options:
 - Max – maximum power available according to the number of active channels.
 - Max-1 to Max-9 – from 1 to 9 dBm less than the maximum power according to the number of active channels.
 - OFF – no power is transmitted on corresponding UL or DL channel.

NOTE: Be sure to disable inactive channels by setting the Power Level to OFF.

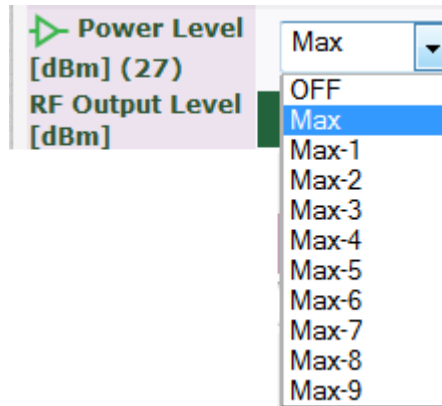

Set the **Attenuation** as follows:

Under the selected **Chain** (channel), in the **Downlink** section, set DL Attenuation to the maximum value. The values shown in the figure below are for example only.

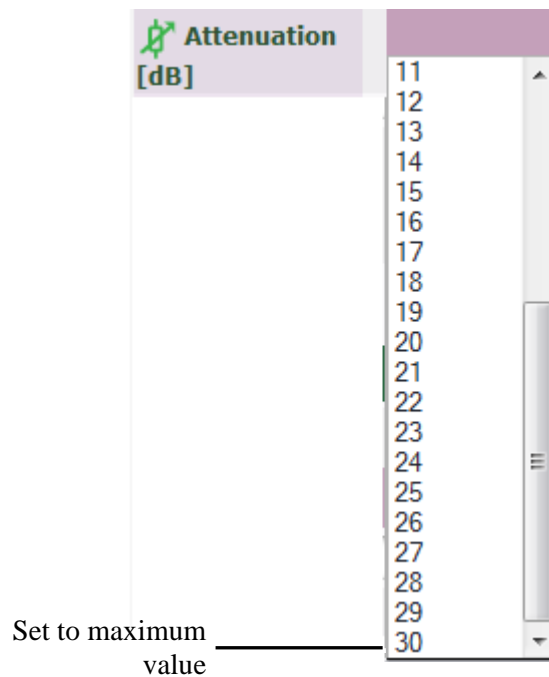

Lower the **Attenuation** level step by step until the desired output power level is reached (zero attenuation = maximum gain).

NOTE: Since the base station is more sensitive than a mobile unit there may be less signal gain from the mobile unit in to the base station (UL) than in the opposite direction. The uplink attenuation can be adjusted more accurately later on, once test signal measurements have been completed.

6.4 Setting Date and Time

Be sure to set the correct date and time in order to accurately timestamp all events occurring on the CSR.

To set the Date & Time

1. From any screen, hover on the **Title** area and click on **Date and Time**.
2. Do one of the following:
Either, enter the correct date and time according to the displayed formats.
Or, click on **Local Time** to set the time according to the PC running the Web-GUI.
3. Click **Apply**.

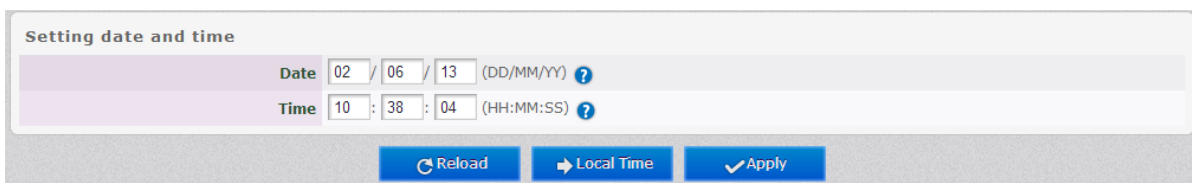

6.5 Additional Configuration Options

Depending on your installation and supported repeater options, you may also want to:

- Configure the external alarms – if external alarms are connected
- IP address – for repeaters that will be connected to the Ethernet network after the initial setup procedure
- SNMP support – requires configuring the agent and trap destination address
- TCP/IP support
- Modem setup – for units supporting a GPRS/GSM modem

NOTE: For units managed via the AEM, no configuration procedures are required on the repeater side; the repeater access information is configured into the AEM.

6.5.1 Configuring External Alarms

The unit supports up to two external alarms. Connected external alarms must be configured according to the trigger (high or low) and it is recommended to assign the alarms recognizable names (such as Door Open, High Temperature, etc.)

To configure the external alarms

1. Hover on the **Title** area and click on **External Alarms**.
2. Set the alarm **Trigger**:
High – voltage triggers alarm
Low – no voltage triggers alarm
3. Assign a description to each relevant alarm in the **Description** area.
4. Click **Apply** to save the changes.

External Alarms Configuration			
External Alarm Pins ?	Trigger ?		Description ?
	Low ?	High ?	
1 Pin 1	<input checked="" type="radio"/>	<input type="radio"/>	VHF Downlink Amplifier
2 Pin 2	<input checked="" type="radio"/>	<input type="radio"/>	VHF Uplink Amplifier
3 Pin 3	<input type="radio"/>	<input checked="" type="radio"/>	External Alarm 3
4 Pin 4	<input type="radio"/>	<input checked="" type="radio"/>	External Alarm 4

6.5.2 IP Address









This procedure describes how to set up the IP address either manually or configure for acquisition via DHCP.

WARNING!
Changing the IP settings on the controller may make it inaccessible. If you change these settings, you may not be able to correct them via this web interface. You may have to use the serial connection (COM PORT) to get or set the value of NIC according to the instructions.

To configure the IP address

1. Hover on the **Title** area and click on **Ethernet**.
2. For manual IP address configuration:
Verify that the option **Automatically obtain IP address** is disabled.
Set the IP, Subnet Mask, Default Gateway and DNS addresses.
Click **Apply**.
3. For DHCP IP address configuration:
Select **Automatically Obtain IP Address (DHCP)**.
No other settings are required.
Click **Apply**.

The Manual configuration settings are illustrated below.

Network IP	
<input type="checkbox"/> Automatically obtain IP address (DHCP) 	
IP	126.124.124  
Subnet Mask	255.255.255.0  
Default Gateway	126.124.1 
DNS 1	126.124.14 
DNS 2	192.168.100.179 
DNS 3	192.168.100.141 

6.5.3 SNMP Support

The CSR includes SNMP support, including an SNMP Agent and SNMP traps (alarms). All SNMP queries and traps are supported either via the OMU II or a direct connection to the unit.

6.5.3.1 SNMP Traps Parameters

The MBF-40 sends SNMP traps to user defined destination addresses.

NOTE: One destination address can currently be defined via the Web.
Seven more destination addresses can be defined via the Axell Shell.

To configure the SNMP traps destination address

1. Click on the **Configure** button (top right corner).
2. Select **Remote Communication**.
3. In the **Device:Method** field, select **ETH:SNMP**

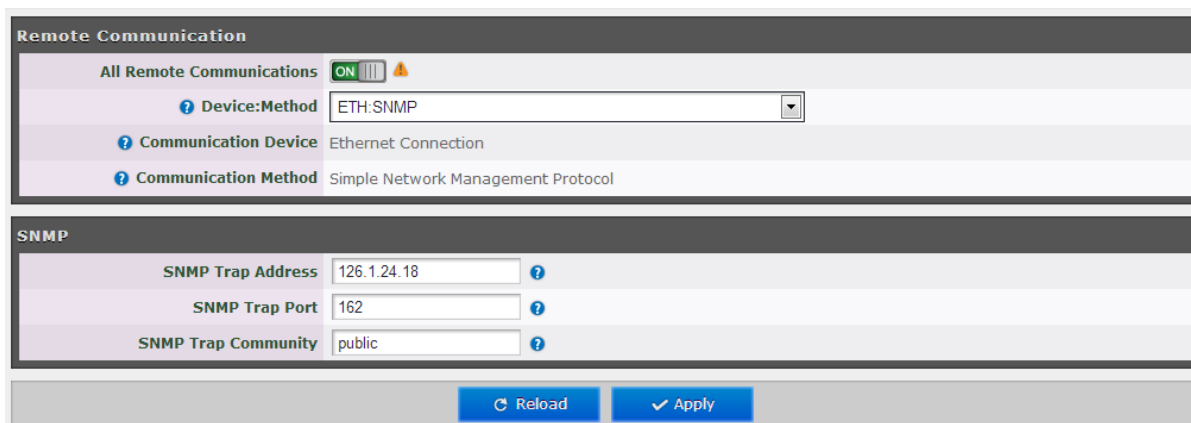

The screenshot shows a web interface for configuring SNMP traps. It is divided into two main sections: 'Remote Communication' and 'SNMP'.
In the 'Remote Communication' section, there is a toggle for 'All Remote Communications' set to 'ON'. Below it, a dropdown menu for 'Device:Method' is set to 'ETH:SNMP'. The 'Communication Device' is set to 'Ethernet Connection' and the 'Communication Method' is 'Simple Network Management Protocol'.
In the 'SNMP' section, there are three input fields: 'SNMP Trap Address' with the value '126.1.24.18', 'SNMP Trap Port' with the value '162', and 'SNMP Trap Community' with the value 'public'. Each field has a help icon to its right.
At the bottom of the interface, there are two buttons: 'Reload' and 'Apply'.

4. Define the SNMP trap destination IP address (additional addresses can be defined via the Axell Shell.).
5. Enter the (destination address device) Trap Port and its Community parameters.
6. Click **Apply**.

6.5.3.2 SNMP Agent - Activating and Configuring

The SNMP agent provides inventory management for hosted repeaters (on which the SNMP agent is enabled) and a table of active alarms in the controller or Fiber system for remote querying.

The SNMP Agent is responsible for responding to queries and carries out requests. The SNMP Agent also provides the proprietary Axell MIB (AXELL-AM-MIB), accessible via any SNMP manager (e.g. HP OpenView).

All SNMP queries to the remote are implemented via an OMU session.

To allow SNMP agent queries

- To allow SNMP queries of the OMU II – the SNMP agent must be enabled on the OMU II.
- To allow SNMP queries of the remote devices via OMU II – the SNMP agent must be enabled on the OMU II *and* on the remote device (repeater).

- Remote units(repeaters) configured with an IP address and connected to the communication infrastructure, can be queried directly.

To activate the CSR SNMP Agent

1. In the Hover menu (hover over the header), select **SNMP**. The following pane appears:

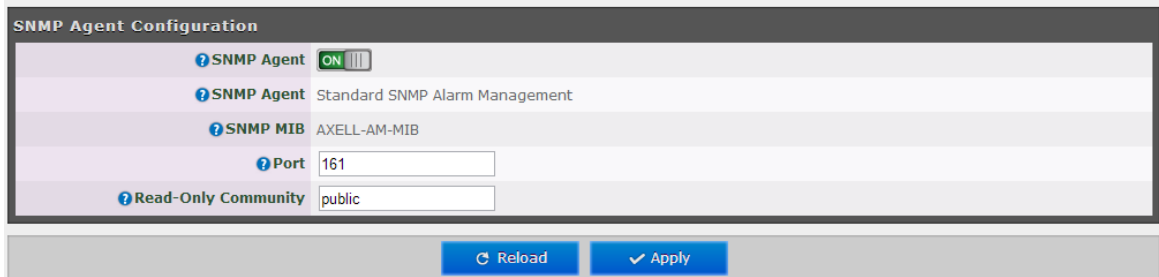

The image shows a configuration pane titled "SNMP Agent Configuration". It contains the following fields and controls:

- SNMP Agent:** A toggle switch set to "ON".
- SNMP Agent:** A dropdown menu set to "Standard SNMP Alarm Management".
- SNMP MIB:** A dropdown menu set to "AXELL-AM-MIB".
- Port:** A text input field containing "161".
- Read-Only Community:** A text input field containing "public".

At the bottom of the pane are two buttons: "Reload" and "Apply".

2. Set the **SNMP Agent** toggle to **ON**.
3. Set the **port** and the **Read-Only community**.
4. Click **Apply**.

6.5.4 TCP/IP and Ethernet

TCP/IP communication is run over a company's network. Therefore, each company needs to define the details regarding the configuration, IP addresses, etc.

TCP/IP Communication Setup

1. Hover on the **Home** page **Title** bar and choose **Communication** from the displayed icons.
2. From **Device:Method** select **ETH:TCP** (Ethernet:TCP/IP).
3. Click **Apply**.

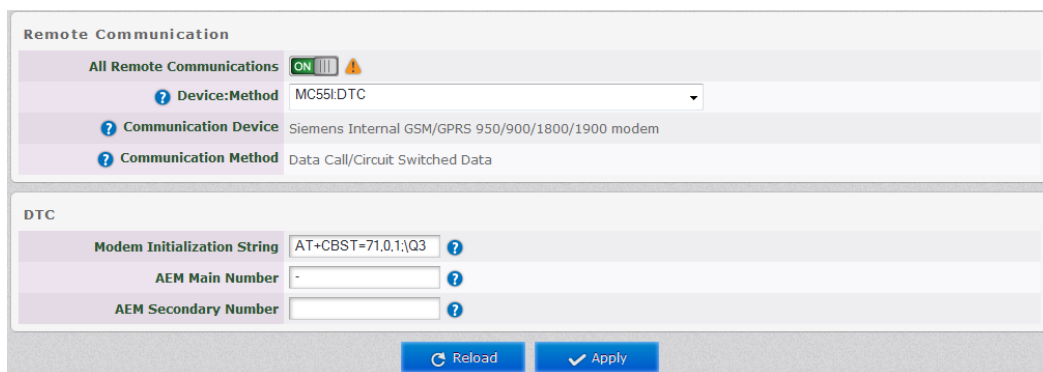

The image shows a configuration pane titled "Remote Communication". It contains the following fields and controls:

- All Remote Communications:** A toggle switch set to "ON" with a warning icon.
- Device:Method:** A dropdown menu set to "MC55i:DTC".
- Communication Device:** A text field containing "Siemens Internal GSM/GPRS 950/900/1800/1900 modem".
- Communication Method:** A text field containing "Data Call/Circuit Switched Data".

Below this is a section titled "DTC" with the following fields:

- Modem Initialization String:** A text field containing "AT+CBST=71,0,1;\Q3".
- AEM Main Number:** A text field containing "-".
- AEM Secondary Number:** An empty text field.

At the bottom of the pane are two buttons: "Reload" and "Apply".

6.5.5 Modem Setup

NOTE: This section is relevant only if a modem is installed in the CSR repeater. If so, the SIM card should already have been installed according to section 4.8.

The CSR can communicate over two types of modem: Packet Switched (GPRS, GSM etc.) or Circuit Switched (PSTN/GSM). The available options depend on the modem type installed in your unit.

Modem Setup Overview

1. The Hover on the **Home** page **Title** bar and choose **Modem** from the displayed icons. The following dialog appears.

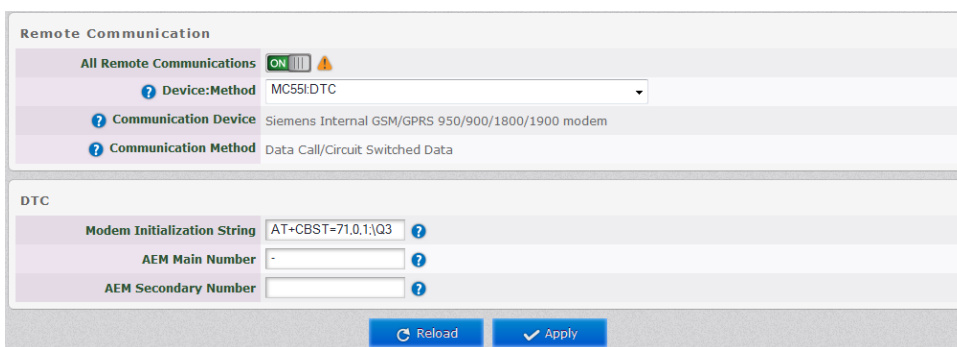

2. Verify that **Remote Communication** is **ON**.
3. Select the **Device:Method** – communication method. Only the options relevant to your installed modem will be displayed. (STD:DTC = Standard AT:Data Call, ETH:TCP = Ethernet:TCP connection)
4. Configure your communication method according to the relevant following section.

6.5.5.1 Packet Switched Modem Configuration (GSM/GPRS)

NOTE: In case the network connection is not performed properly (using GPRS), it is necessary to telnet, SSH or serial into the controller and enter TRACE MODEM to see why modem is not initialized (wrong / missing PIN, wrong APN etc).

- From the Remote communication menu, select *****: GPRS**.
- In the GRPS area, enter the following:
 - Access Point Name – customer's Access Point name.
 - Click **Apply**.

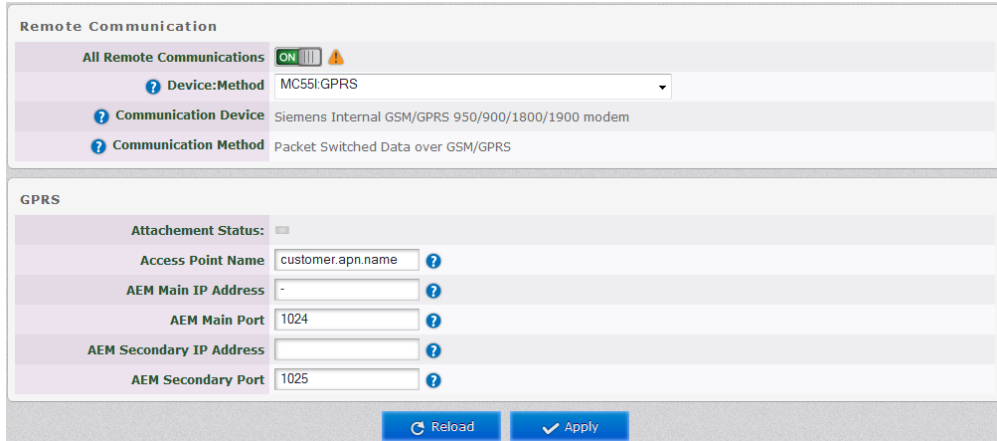

6.5.5.2 Circuit Switched Modem (PSTN/GSM)

Using a circuit switched modem requires a landline connection be present at the site (for PSTN) or a SIM card supporting this feature (for wireless GSM).

Communication Setup

1. From **Device:Method** select **STD:DTC** (Standard AT:DataCall).
2. In the modem initialization string type: **AT+CBST=7,0,1**.
3. Click **Apply**.

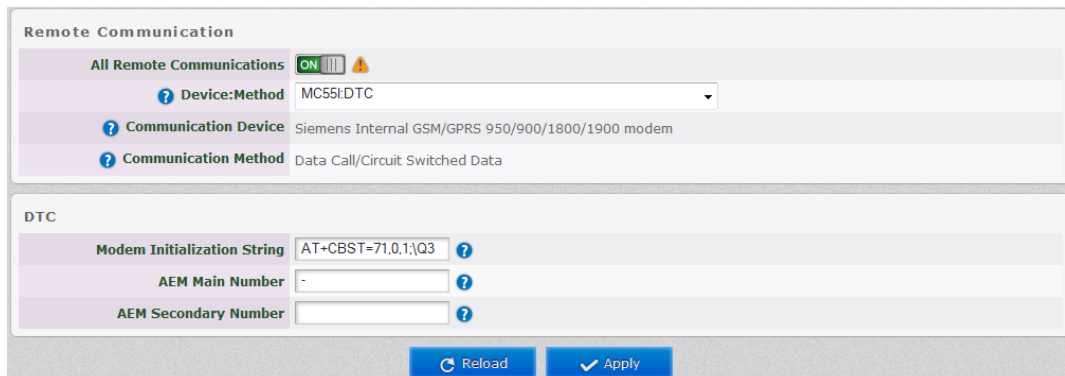

Verify Circuit Switched Modem Functionality

1. Use the ACT RCD command via the Axell Shell or via Terminal to launch a modem restart (if logged in, restart will be performed on the first logout).
2. Dial the modem number (if PSTN) or the data number (if SIM card).
3. Verify modem LEDs are lit correctly (see section 8.1).
4. Use any ACT command using a Terminal to test connectivity and responsiveness.

6.5.5.3 SIM-card Using Single Numbering Scheme

If using SNS (Single Numbering Scheme), calls to the modem **within** the network are automatically classified as DATA. However, if calling from **outside** the network, you must first verify how its interfaces handle the VOICE vs. DATA bearing.

This cannot be solved at remote level. The external network administrator must provide the above information.

6.6 Integration into the AEM

When the repeater has been installed at site and the remote communication has been enabled, the repeater can be integrated to the Axell Element Manager. This is done by the operator of the AEM. After entering the telephone number to the repeater, the AEM dials up the repeater, downloads all the repeater parameters and statuses into a database. When all parameters have been downloaded, the AEM configures the repeater with the telephone number where alarms and reports should be sent, and optionally with a secondary telephone number where the repeater can dial in case connection to primary number fails.

When heartbeat reports and alarms are sent from the repeater to the AEM also the latest information about the status and RF-configuration is included. This means that the AEM operator always has information about the current status in the AEM database (and do not need to call the repeater to find this out).

NOTE: Once the repeater is integrated to the AEM, all changes to the repeater should preferably be done from the Axell Element Manager in order to ensure that the database always contains correct information.

7 Administration and Monitoring

7.1 User Accounts

The CSR comes pre-configured with default usernames and passwords in the various administration levels.

The password for the **Axell** user name can be modified via the Web GUI. Passwords for other user names can be modified via the Command Line Interface (CLI) or Axell Shell. See the *Common Commands and Attributes* document for detailed commands and syntax or click on the **Help** button at the top right of the Web-GUI screen.

7.1.1 Default User Accounts

User Name	Default Password	Details
Axell	AxellPasswd	Default user name. Can be modified via the WEB GUI.
omcuname	iwnkhoob	Axell Element Manager (AEM) user account. This account will not generate VLI, LGO or CLR alarms.
sysadmin	AxellAdmin4050	This is the system administration password which is used for firmware upgrades and user administration. Escalation to this level is achieved by issuing command SYSADMIN from the user prompt.
useradmin	UseradminPwd23	This account contains user administration privileges. Escalation to this level is achieved by issuing command USERADMIN from the user prompt.

NOTE: It is strongly recommended to change the default user names and passwords immediately at commissioning. This is done by using the command **ACT PASSWORD**. Please refer to the User Administration section in Common Commands and Attributes document for detailed syntax.

7.1.2 User Access Levels

In this generation of the system, standard users can be promoted to login via the Web Interface, inheriting the Read-Write or Read-Only access to this interface.

There are five different access levels:

Access Level	Default User Levels
Read-Only	axell, omcuname, useradmin, sysadmin
Read-Write	axell, omcuname, useradmin, sysadmin
Web	Axell
User Administrator	omcuname, useradmin, sysadmin
System Administrator	omcuname, sysadmin

Note: New users added to the system have read-only access.

Users may be promoted to read-write and/or web access using the **ACT USERPROMOTE** command. See **Common Commands and Attributes** document for details on promoting users.

NOTE: Users omcuname, sysadmin and useradmin cannot be promoted to Web Access due to security reasons.

7.1.3 Password Change

To prevent unauthorized access, it is highly recommended to change the default password of the user.

NOTE: Password should be at least 5 characters long and only contain printable characters. You can only change the password for the User Name with which the session was accessed.

To change the Password

1. Hover on the Home screen **Title** bar and select **Password**.
2. For the current User Name (e.g. **axell**):
Enter the New password.
Repeat the entry.
3. Click **Apply**.

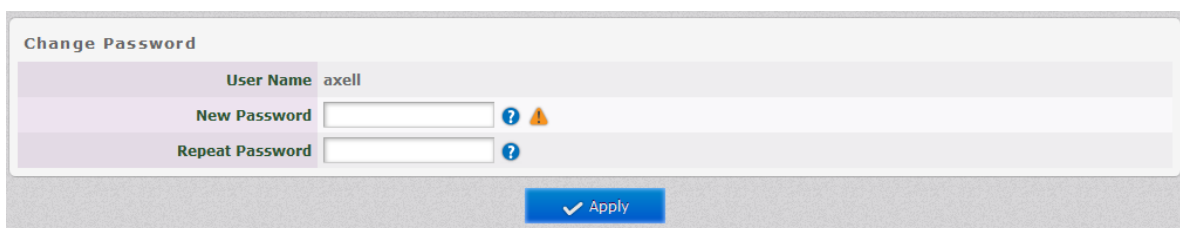

The screenshot shows a 'Change Password' form. It has a title bar 'Change Password'. Below it, there are three input fields: 'User Name' with the value 'axell', 'New Password', and 'Repeat Password'. The 'New Password' and 'Repeat Password' fields have a question mark icon and a warning triangle icon. At the bottom right, there is a blue button with a checkmark and the text 'Apply'.

7.2 Reboot

Caution! Use this function in Emergency Cases ONLY!

To reboot the Repeater

1. Hover on the Home screen **Title** bar and select **Reboot**.
2. Click on the **Reboot** icon.
3. Approve the Reboot sequence.

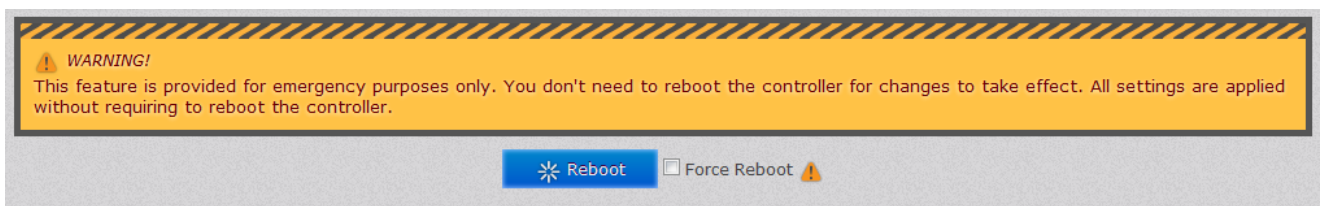

The screenshot shows a warning dialog box with a yellow background and a black border with diagonal stripes. It contains a warning icon and the text 'WARNING! This feature is provided for emergency purposes only. You don't need to reboot the controller for changes to take effect. All settings are applied without requiring to reboot the controller.' At the bottom, there is a blue button with a star icon and the text 'Reboot', and a checkbox labeled 'Force Reboot' with a warning triangle icon.

7.3 Axell Shell

This option provides Axell Command Line Interface capabilities.

The **Axell Shell** button invokes the CLI pane. It is used to run some of the commands that are currently not provided by the Web GUI (e.g. user privileges and administration) and/or for advanced troubleshooting and configurations procedures.

All configuration and management procedures can be implemented using this interface. Please refer to the *Help* section (by clicking the **Help** on the top right) for detailed syntax and available commands.

To access the Axell Shell:

Hover on the Home screen **Title** bar and select **Axell Shell**.

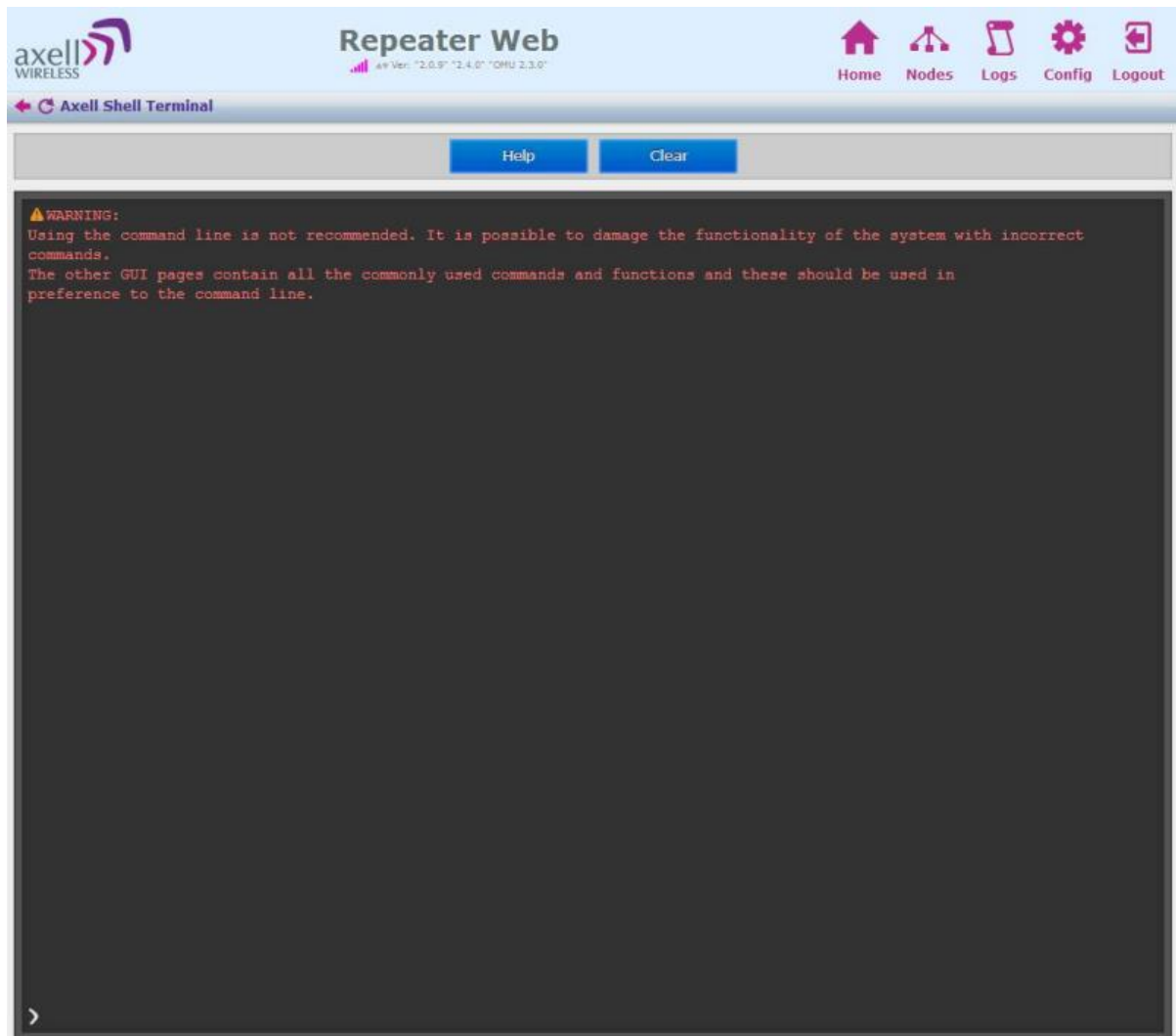

8 Monitoring and Troubleshooting

8.1 Monitoring

The CSR Repeater provides the following monitoring and fault sourcing tools:

- Logs screen – shows alarms and information messages according to user definitions in the Thresholds screen
- Alarm Classification and Threshold – screen allowing user configuration of the alarm generation criteria
- Main screen – displays a summary of all configured channels, module status and general information
- Site information and system performance – site details, system SW and HW versions and system performance indicators.

8.1.1 Logs Screen

The Alarms Log displays the last 100 alarms and/or user actions on the remote system in a chronological order. The alarms are generated according to user defined thresholds (see the following section).

To display the Logs screen

Hover on the Title bar and click **Logs**. The Logs screen appears showing the latest generated alarms and information on user actions.

You can perform the following operations:

- View more information on the log - Hover on the log
- Acknowledge a log - click on a log flag. The log flag will be green and the log details displayed.
- Acknowledge all logs – click **Ack All** operation button.
- View all the logs – click on **More...**

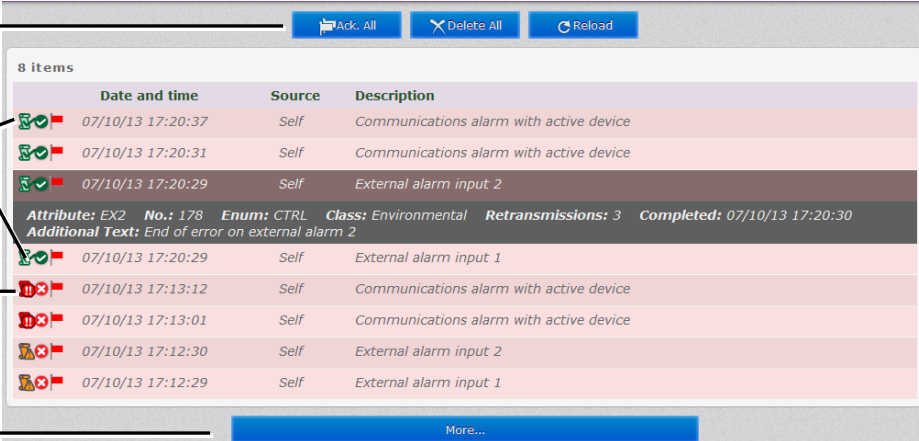

Operation buttons

Acknowledged logs – green flag

Unacknowledged log – red flag

View more logs

Date and time	Source	Description
07/10/13 17:20:37	Self	Communications alarm with active device
07/10/13 17:20:31	Self	Communications alarm with active device
07/10/13 17:20:29	Self	External alarm input 2
Attribute: EX2 No.: 178 Enum: CTRL Class: Environmental Retransmissions: 3 Completed: 07/10/13 17:20:30 Additional Text: End of error on external alarm 2		
07/10/13 17:20:29	Self	External alarm input 1
07/10/13 17:13:12	Self	Communications alarm with active device
07/10/13 17:13:01	Self	Communications alarm with active device
07/10/13 17:12:30	Self	External alarm input 2
07/10/13 17:12:29	Self	External alarm input 1

Figure 8-1: Logs

Icon	Description
	Alarm attended to and cleared.
	System alarm – displayed when system functionality may be compromised.
	Alarm status: OK
	Alarm status: Error
	Acknowledge alarm – Green = Acknowledged. Click to change acknowledgement. Use the Ack All button to acknowledge all alarm logs.

8.1.2 Alarm Classification and Thresholds

The user can set the criteria according to which the alarms are generated. The criteria include Class and Severity selection, whether it will be transmitted to the AEM and more. The alarm generation criteria are grouped according to the type of alarms: External Alarms, User Events, Firmware Events, etc.





To access the Alarm Threshold configuration screen

1. Hover on the **Menu Bar** and click on **Alarm Thresholds**. The following screen appears.

Refresh view and
Apply changes

Criteria

2. For each group of alarms, change the required criteria according to the following table and click **Apply**.

Criteria	Description
Class	Type of alarm or event.
Severity	The severity level allocated to this event.
 AEM Transmission	Whether this alarm is to be sent to the AEM server
 Affect Relay	Whether this alarm will activate the relay
 Acknowledge Required	Whether acknowledgement of the alarm is required.
Trigger Range 	Defines the minimum and maximum range outside of which an alarm will be triggered.
Interval	The number of seconds for consecutive measurements in error state before an alarm is triggered

8.1.3 Home Screen Monitoring

In addition to RF settings and readings, the CSR Home screen provides detailed information on the operation status of internal modules. This information can be used to aid in remotely troubleshooting the repeater.

This section describes monitoring the Basic view Home screens. To view more details, click **Advanced**.

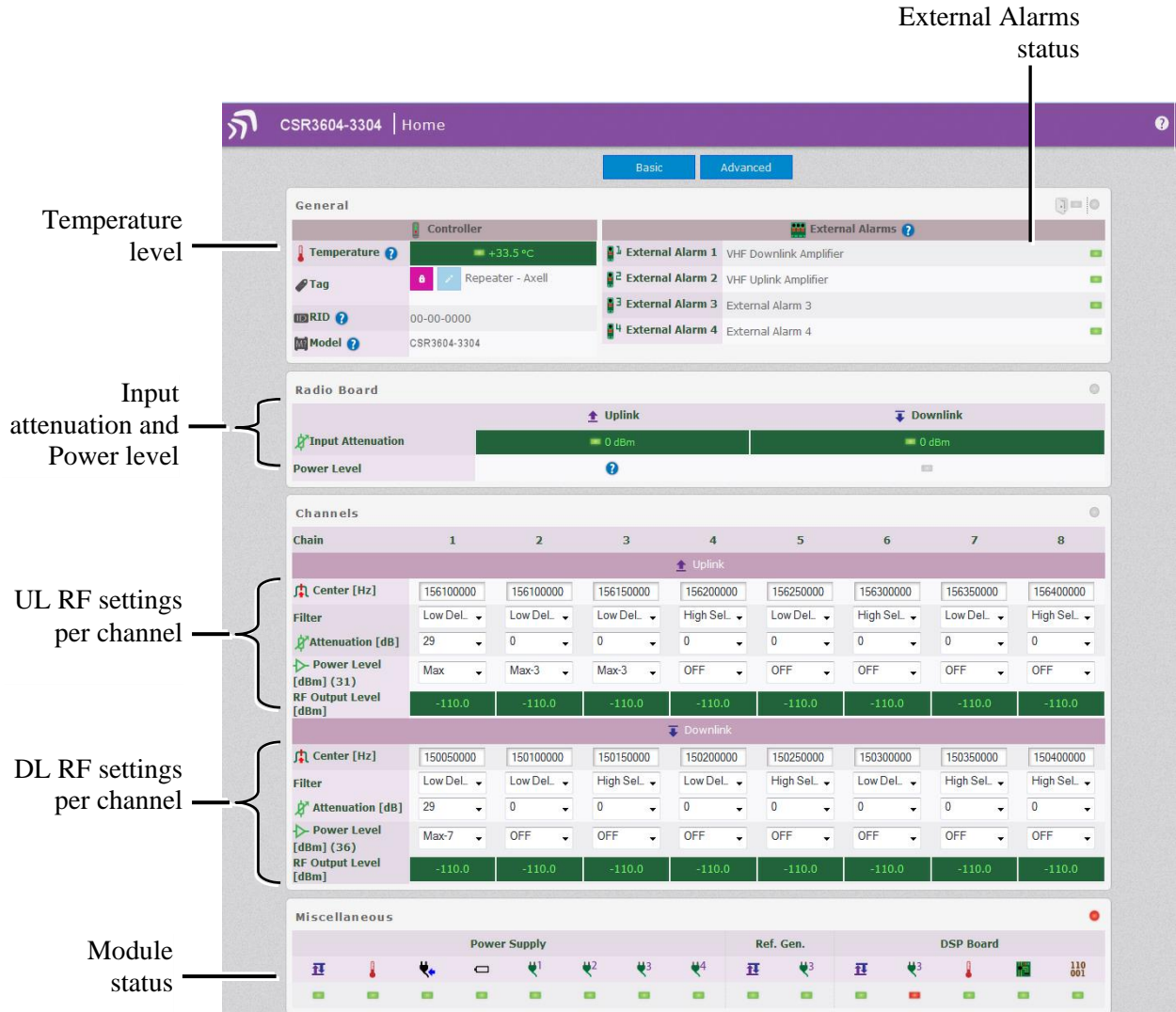

Figure 8-2: Main Screen – Basic View

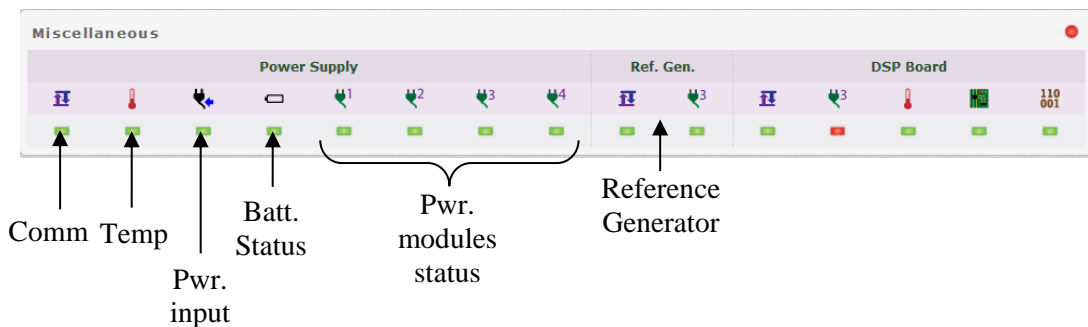

Figure 8-3: Module Status Details

8.1.4 Site Information and System Performance

To view CSR Site Information

Hover over the **Title** bar click on **Site Information**. Two areas are displayed:

- Performance – repeater status dashboard, displaying status of key parameters
- Control Module – provides hardware and software version information.
- Site Information – provides CSR identification information.

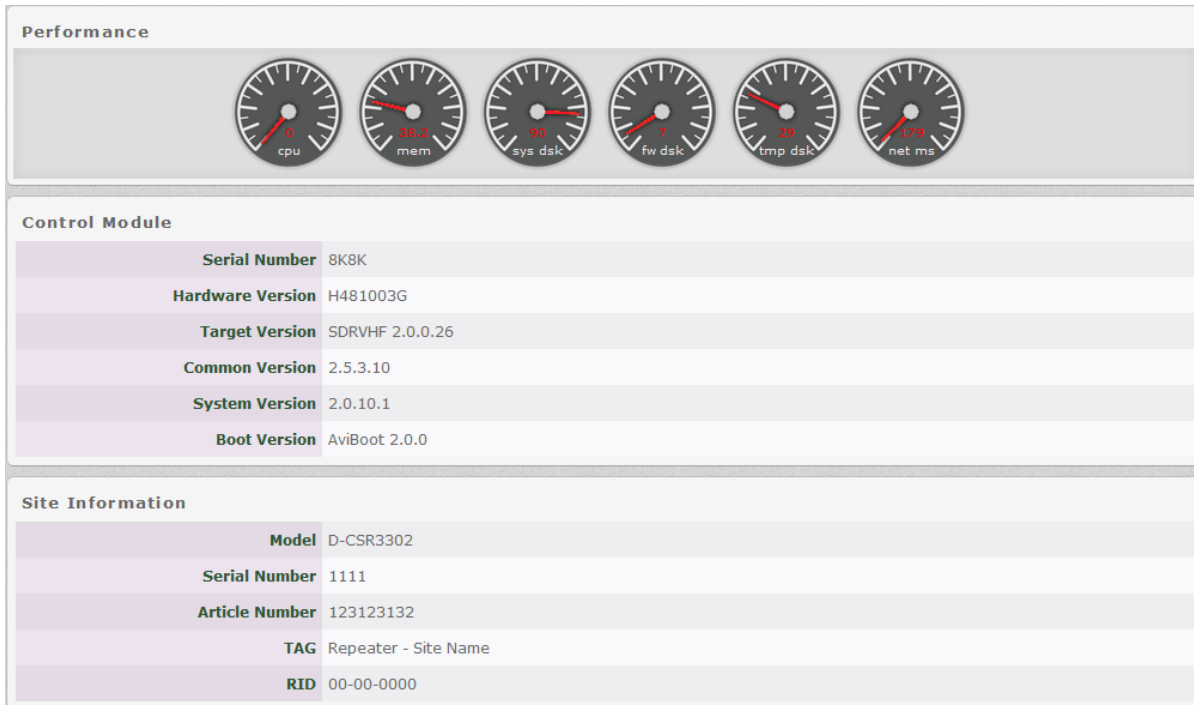
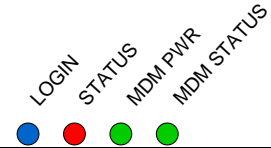











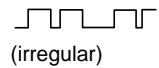

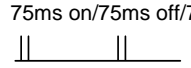

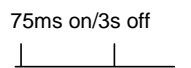

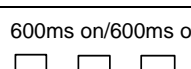

Figure 8-4. CSR Site Information

8.2 Module LEDs

8.2.1 Control Module LEDs



The Control Module has four LEDs which provide information on the repeater and modem status and if someone is logged on to the repeater.



Blue LED - Login		
	Quick flash	Control Module switched on, someone logged in locally and/or remotely
	Off (except for a quick flash every 10th second)	Control Module switched on, no one logged in
	Off (permanent)	Control Module switched OFF
Red LED - Status		
	Quick flash	Control Module switched on, one or more errors/alarms detected
	Off (except for a quick flash every 10th second)	Control Module switched on, status OK
	Off (permanent)	Control Module switched off
Green LED – Modem Power		
	On	Modem Power is on
	Off	Modem Power is off
Green LED – Modem Status		
	On	Depending on type of call: Voice call: Connected to remote party Data call: Connected to remote party or exchange of parameters while setting up or disconnecting a call
	Flashing  (irregular)	Indicates GPRS data transfer. When a GPRS transfer is in progress the LED goes on within 1 second after data packets were exchanged. Flash duration in approximately 0.5s.
	75ms on/75ms off/75ms on/3s off 	One or more GPRS contexts activated
	75ms on/3s off 	Logged to network (monitoring control channels and user interactions). No call in progress
	600ms on/600ms off 	No SIM card inserted, or no PIN entered, or network search in progress, or ongoing user authentications, or network login in progress
	Off	Modem is off

8.2.2 Power Supply LEDs

This section provides a detailed description of the LEDs and examples of faults.

 
 
 
 Input +6V +15V +28V
 Power

LED 1, Input Power, Green	
Slow flash	Power supply unit operating on AC or DC
OFF	Power supply unit not operating
LED 2, +6V, Red	
Slow flash (every 10 seconds)	+6V power supply operating
Quick flash	+6V power supply not operating or operating with malfunction
LED 3, +15V, Red	
Slow flash (every 10 seconds)	+15V power supply operating
Quick flash	+15V power supply not operating or operating with malfunction
LED 4, +28V, Red	
Slow flash (every 10 seconds)	+28V power supply operating
Quick flash	+28V power supply not operating or operating with malfunction

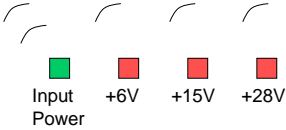
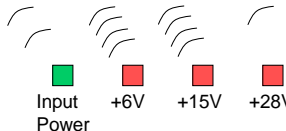
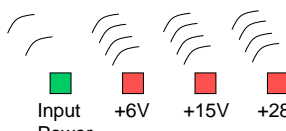
Examples	
 <p>Input Power +6V +15V +28V</p>	<p>LED 1 is flashing slowly, LED 2 – 4 are flashing slowly (once every 10 seconds) => power supply unit is operating without problem</p>
 <p>Input Power +6V +15V +28V</p>	<p>LED 1 is flashing slowly, one or two of the red LEDs are flashing quickly => Input power is operating but there is a problem with some of the other voltages</p>
 <p>Input Power +6V +15V +28V</p>	<p>LED 1 is flashing slowly, all of the red LEDs are flashing quickly => Input power is out and unit is operating on backup battery</p>

8.3 Troubleshooting Remote Communication

Please also refer to the document *Common Command and Attributes* for guidance.

Since many networks have their own “personality”, performing first time configuration of the remote communication sometimes requires tweaking of the modem parameters.

This section describes some trouble shooting techniques if configuring the repeater for remote access fails.

The illustration below is a simplified schematic of the remote communication between a GSM modem in a repeater and an analogue modem. The analogue modem in the computer communicates with the Interworking Function Unit (IFU), which is the GSM network analogue network interface. The call is routed via the switch centre over the air interface to the data call number in the SIM-card of the GSM module.

The Control Module is responsible for establishing connections with the Axell Element Manager, and to answer incoming calls to the repeater.

As described in previous sections, the Control Module only accepts one login at a time, either via Local Maintenance port (LMT) or modem connection. Hence, when verifying the remote access of the repeater, it is important to log out from the repeater locally before trying to access the repeater remotely.

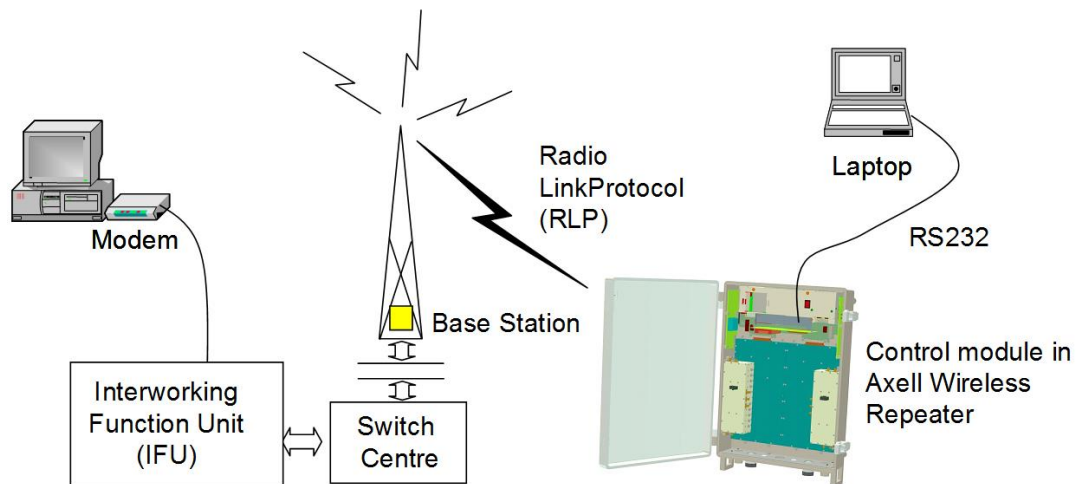

8.3.1 Direct Modem Access

To allow for advanced trouble shooting of the communications, it is possible to connect directly to the modem by opening the repeater and connecting to the Control Module from a computer.

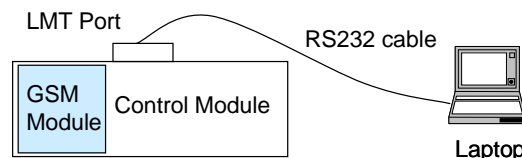

Log in to the repeater, either with RMC, or with a terminal emulation program, such as HyperTerminal™.

When the login is completed, select Terminal Mode, this will give access to the repeater command prompt in the same way as with HyperTerminal.

When the repeater prompt is accessible, type in the command
ACCESS MODEM <Enter>.

When typing ACCESS MODEM, the controller will send all the characters that are typed directly out to the modem port. All characters replied back from the modem will go directly to the LMT port and back to the computer.

To abort an ACCESS MODEM session, press three '-' in a row (all three within one second) to come back to the repeater command prompt.

NOTE: When accessing the modem port the modem might be configured with "echo off", meaning that the characters entered will not be echoed back to the screen. In order to enable "echo", press Enter.

Type

ATE1 <enter>

(invisible)

The modem replies with

OK

indicating that the echo is enabled. All characters entered will now be echoed back to the terminal program.

8.3.2 Trace Modem

For troubleshooting purposes it is possible to trace the actual progress of initializing the modem. This trace is useful when having problems with the modem initialization.

Go to Terminal Mode and type

TRACE MODEM

```
GPRS cycling requested, detaching from GPRS network...
Clearing out the GPRS IP settings...
Restoring standard default route...
Restoring standard network settings...
GPRS shutdown completed!
Checking modem connection...
Disabling modem echo...
ERROR: Modem not responding!
Modem not responding!
Recovering modem communications...
GPRS interface shut down...
Modem communication recovered successfully.
Initializing modem...
Disabling modem echo...
Modem echo successfully disabled.
Checking PIN status...
SIM already unlocked.
Checking Network Registration...
Registered on home network.
Initializing modem specific parameters...
Sending modem initialization string AT+CBST=71,0,1;\Q3
Modem initialization completed successfully!
Starting GPRS attach procedure...
```

To end session type CTRL-Z

8.3.3 Manually Answering Incoming Calls

It is possible to manually answer incoming calls without involving the repeater software at all, to verify that the remote access and the network itself works as intended. In order to verify the remote communication, make sure to have someone stand by to dial up the repeater with a terminal emulation program, for example HyperTerminal™.

Go in to Direct Modem Access as described earlier. When in direct access mode, ask the person standing by to dial up the repeater.

As soon as a call is received, the text **RING** will repeatedly be displayed on the screen.

Type **ATA <enter>**

This will inform the modem to answer (ATtention Answer).

When the connection is established, a connect message will be displayed including the connection speed. Sometimes the information comes together with some miscellaneous information, such as error correction protocols etc.

NOTE: Make sure the remote peer dials the Data Call number

If the voice number is dialed instead of the data number, or if the modem contains an illegal modem initialization string, the message

OK

or

NO CARRIER

will be displayed almost immediately.

Try to change the modem initialization string. The modem initialization string mainly used to configure the remote communication is AT+CBST.

Successful modem initialization strings used by Axell Wireless includes (most common first):

AT+CBST=71,0,1;\Q3

AT+CBST=7,0,1;\Q3

AT+CBST=0,0,1;\Q3

AT+CBST=0,0,1;\Q3

AT+CBST=7,0,3;\Q3

Once the modem initialization string is entered, try again to dial up the repeater. For details on the different modem initialization strings, please refer to the modem's user guide.

If the setup is successful, the connect message will be brought up;

CONNECT 9600

This means that an online connection is established to the remote peer. From now on, all characters typed on the keyboard will end up on the remote peer's screen. Similarly, all characters typed by the remote peer will be displayed on the screen.

In the example, the incoming call was successfully answered, and the remote user entered the text message.

```
Time: 08:03:49 Date: 2003-11-28 RID: 00-00-0000 Tag: RFID-2339

To quit, press CTRL-C (or use escape sequence <Hait 1 s>'---'<Hait 1 s>
at
OK

RING
ata
CONNECT 9600
This communication seems to work fine!!!
```

In order to come back to modem command mode, press +++ (three pluses) rapidly (within one second).

Receiving **OK** means that the modem is back in command mode.

Type **ATH <enter>**

This terminates the connection to the remote peer. The message **NO CARRIER** will be displayed.

8.3.4 Common Problems

8.3.4.1 Problem 1

When enabling the remote access for the repeater, the modem fails to log in to the network.

8.3.4.2 Solution

Signal strength from the donor site is too low. The signal strength can be read directly from the modem. Go in to Direct Modem Access as described earlier. Use the command AT+CSQ (documented below) to read out the signal strength.

In order to have good signal quality, Axell Wireless recommends that the signal strength should be better than -95 dBm. If signal strength is lower, try to adjust the antennas to get a better signal strength from the donor.

6.1 Signal Quality +CSQ

6.1.1 Description :
 This command is used to know the *received signal strength indication* (<rss>) and the *channel bit error rate* (<ber>) with or without any SIM card inserted.

6.1.2 Syntax :
 Command syntax : AT+CSQ

Command	Possible responses
AT+CSQ	+CSQ: <rss>,<ber> OK <i>Note : <rss> and <ber> as defined below</i>

6.1.3 Defined values :

<rss> :	0	: -113 dBm or less			
	1	: -111 dBm			
	2...30	: -109 to -53 dBm			
	31	: -51dBm or greater			
	99	: not known or not detectable			
<ber> :	0...7	: as RXQUAL values in the table GSM 05.08			
	99	: not known or not detectable			

Documentation of +CSQ command from a modem's manual.

In the example the reply to AT+CSQ is 0,7 meaning 7*2 dB above -113 dBm; the modem detects a signal level of -99 dBm.

```

Time: 07:57:46 Date: 2003-11-28 RID: 00-00-0000 Tag: RFID-2339

To quit, press CTRL-C (or use escape sequence <Hait 1 s>'---'<Hait 1 s>
at+creg?
+CREG: 0,1

OK
at+csq
+CSQ: 7,0

OK
    
```

8.3.4.3 Problem 2a

Repeater is configured properly, and answers the incoming call, but when trying to dial the repeater using an analogue mode, no modem handshaking is heard from the dialing modem.

8.3.4.4 Problem 2b

When dialing the repeater, the repeater answers the incoming call, but no connection is established, and after a while the repeater disconnects the call.

8.3.4.5 Solution

The most common cause is that the number called is the voice number of the SIM, not the data number. Therefore, make sure to dial the data number.

If data call is used, the problem probably is an illegal modem initialization string.

In order to change the modem string, go to the repeater command prompt. Try changing the modem initialization string and log out to let the controller reinitialize the modem.

If problem remains, try a few different modem initialization strings. Axell Wireless has been successful with the following modem initialization strings:

```
AT+CBST=71,0,1;\Q3
```

```
AT+CBST=7,0,1;\Q3
```

```
AT+CBST=0,0,1;\Q3
```

```
AT+CBST=0,0,1;\Q3
```

```
AT+CBST=7,0,3;\Q3
```

Please refer to the modem manual for detailed description of the modem initialization strings.

8.3.4.6 Problem 3

It is possible to call the repeater from another GSM mobile, but not from an analogue modem.

8.3.4.7 Solution

This problem is most likely related to the modem configuration and/or the configuration of the IFU unit. Try to decrease the communications speed and make sure that the modem error correction is supported by the IFU. Verify the IFU configuration to see if there are any known problems with the modem connections.

8.3.4.8 Problem 4

When dialing the repeater, or when the repeater is dialing the Element Manager, the connection is terminated before the handshaking is completed.

8.3.4.9 Solution

When a repeater is answering an incoming modem call, or calling up the OMC to deliver an alarm or a report, the repeater will wait a configurable number of seconds for the call to be established. If no communication is established within this time, the call will be hung up. If this interval is set too low, the handshaking is terminated too fast. In the RMC, verify the Modem Connect Time to see that it is set to at least 30 seconds.

9 Maintenance

CAUTION!! Please be aware that the equipment may, during certain conditions become very warm and can cause minor injuries if handled without any protection, such as gloves.

CAUTION!! Risk of explosion if battery is replaced by an incorrect type. Dispose of used batteries according to local laws and instructions.

9.1 General

The system normally operates without any operator intervention or maintenance. If in the unlikely event of any unit failure, the faulty repeater should be replaced. A failed unit can be removed and replaced with a spare while the rest of the system (other repeaters) is still operating. However, the power supply of the failed repeater should be isolated from the power before anything is replaced.

In the event of a malfunction in the system, the status of the antenna systems as well as the continuity of the cabling should be checked before replacing any modules within the repeater.

9.2 Preventative Maintenance

The repeater does not require preventative maintenance apart from changing the battery once every three years.

9.3 Component Replacement

Except for the backup battery, none of the modules in the repeater can be replaced without removing the repeater from its mounting and opening the cover of the repeater.

9.4 Product Disposal

Disposal of this product must be handled according to all national laws and regulations. For detailed information regarding materials, please refer to Axell Wireless.

9.5 Replacing Backup Battery

NOTE: The backup battery should be replaced every five years. Contact your Axell service representative for specifications of the replacement battery.

The image below shows the location of the various power elements. These are described in detail in the following sections.

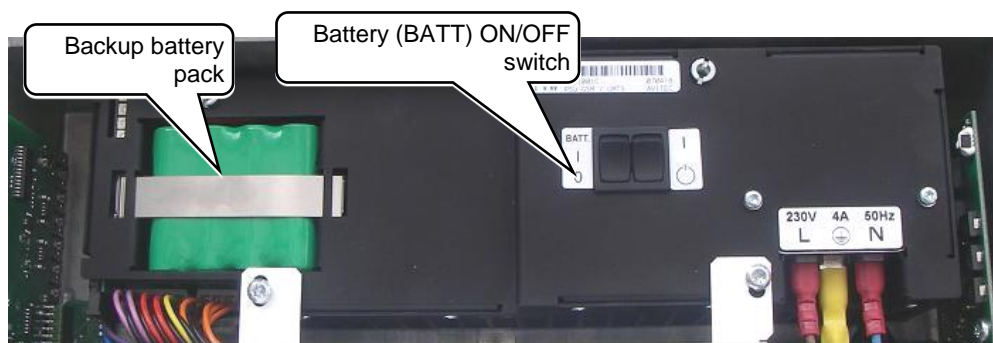

Figure 9-1. Power Elements Inside Repeater

To replace the backup battery

4. Set the battery switch to OFF.
5. The battery is replaced by lifting the battery pack out of the crate and disconnecting the cable.

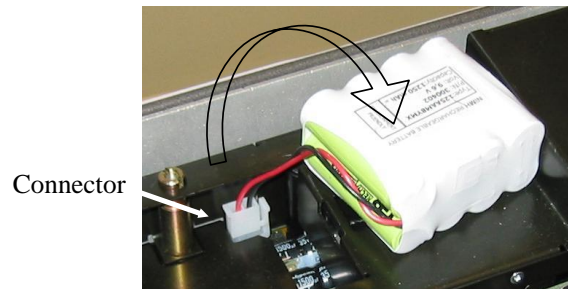

Figure 9-2. Backup Battery Connections

9.6 Troubleshooting

In the event of a failure Axell Wireless's support service should be contacted for advice on a possible module replacement or other action to be taken.

CAUTION! If a shipment of a repeater back to Axell Wireless is made within the period of guarantee the original packing must be used.

9.7 Component Replacement

None of the modules in the repeater can be replaced without removing the repeater from its mounting and opening the cover of the repeater.

9.8 Product Disposal

Disposal of this product must be handled according to all national laws and regulations. For detailed information regarding materials, please refer to Axell Wireless.

Appendix A - Specification

Parameter	Specification	
Downlink		
Frequency Range	421.0 – 424.5MHz	
Maximum Gain	80dB	
Gain Adjustment (in RMC)	0 – 30dB in 1dB steps	
Maximum RF Output Power (1 carrier)	+36dBm	
Output IP3	> +58dBm	
In-Band Spurious Noise (30kHz B/W)	< -13dBm	
Uplink		
Frequency Range	427.0 – 430.0MHz	
Maximum Gain	80dB	
Gain Adjustment (in RMC)	0 – 30dB in 1dB steps	
Maximum RF Output Power (1 carrier)	+36dBm	
Output IP3	> +58dBm	
In-Band Spurious Noise (30kHz B/W)	< -13dBm	
General		
Dimensions H x W x D	540 x 382 x 198 mm	
Enclosure	Aluminium (IP65)	
Weight	22 kg	
AC Supply Voltage	110V	
RF Connectors	N Female	
Cooling	Convection	
Alarm relay output	Dry contact	
Temperature Range	operation	-10 to +50 °C (-14 to +122 °F)
	storage	-30 to 70° C (-58 to 158° F)
Humidity	10% – 90%	