

BSF-4004 UHF Repeater

Product Description and User's Manual

Doc No. PN 4004 BSF0038 Series-UM Rev. 1.0

**THIS DOCUMENT IS VALID FOR THE
BSF 4004 (424/429MHz) REPEATERS for the US Market**



Copyright © 2014 Axell Wireless Ltd

All rights reserved.

No part of this document may be copied, distributed, transmitted, transcribed, stored in a retrieval system, or translated into any human or computer language without the prior written permission of Axell Wireless Ltd.

The manufacturer has made every effort to ensure that the instructions contained in this document are adequate and free of errors and omissions. The manufacturer will, if necessary, explain issues which may not be covered by this document. The manufacturer's liability for any errors in the document is limited to the correction of errors and the aforementioned advisory services.

This document has been prepared to be used by professional and properly trained personnel, and the customer assumes full responsibility when using them. The manufacturer welcomes customer comments as part of the process of continual development and improvement of the documentation in the best way possible from the user's viewpoint. Please submit your comments to the nearest Axell Wireless sales representative.

Contact Information

Headquarters	Axell Wireless Aerial House Asheridge Road Chesham Buckinghamshire HP5 2QD United Kingdom Tel: +44 1494 777000 Fax: +44 1494 777002
Commercial inquiries	info@axellwireless.com
Web site	www.axellwireless.com
Support issues	support@axellwireless.com
Technical Support Line, English speaking	+44 1494 777 747

Contact information for Axell Wireless offices in other countries can be found on our web site, www.axellwireless.com

About This Manual

This Product Manual provides the following information:

- Description of the BSF-4004 repeater
- Procedures for installation, setup, configuration and checking the proper operation of the unit
- Maintenance and troubleshooting procedures

Intended Audience

This Product Manual is intended for experienced technicians and engineers. It is assumed that the customers installing, operating, and maintaining Axell Wireless Repeaters are familiar with the basic functionality of Repeaters.

Notice

Confidential - Authorized Customer Use

This document may be used in its complete form only and is solely for the use of Axell Wireless employees and authorized Axell Wireless channels or customers. The material herein is proprietary to Axell Wireless. Any unauthorized reproduction, use or disclosure of any part thereof is strictly prohibited.

All trademarks and registered trademarks are the property of their respective owners.

Disclaimer of Liability

Contents herein are current as of the date of publication. Axell Wireless reserves the right to change the contents without prior notice. The information furnished by Axell Wireless in this document is believed to be accurate and reliable. However, Axell Wireless assumes no responsibility for its use. In no event shall Axell Wireless be liable for any damage resulting from loss of data, loss of use, or loss of profits and Axell Wireless further disclaims any and all liability for indirect, incidental, special, consequential or other similes damages. This disclaimer of liability applies to all products, publications and services during and after the warranty period.

Safety to Personnel

- Before installing or replacing any of the equipment, the entire manual should be read and understood.
- *This equipment is to be installed only in a restricted access location.*
- Throughout this manual, there are "Caution" warnings. "Caution" calls attention to a procedure or practice, which, if ignored, may result in injury or damage to the system, system component or even the user. Do not perform any procedure preceded by a "Caution" until the described conditions are fully understood and met.

<p>CAUTION! This notice calls attention to a procedure or practice that, if ignored, may result in personal injury or in damage to the system or system component. Do not perform any procedure preceded by a "Caution" until described conditions are fully understood and met.</p>

Compliance with FCC

Part 90 Signal Boosters THIS IS A 90.219 CLASS B DEVICE	
	<p>WARNING: This is NOT a CONSUMER device. This device is designed for installation by FCC LICENCEES and QUALIFIED INSTALLERS. You MUST have an FCC LICENCE or express consent of an FCC Licensee to operate this device.</p> <p>You MUST register Class B signal boosters (as defined in 47 CFR 90.219) online at www.fcc.gov/signal-boosters/registration.</p> <p>Unauthorized use may result in significant forfeiture penalties, including penalties in excess of \$100,000 for each continuing violation.</p>

	<p>The installation procedure must result in the signal booster complying with FCC requirements 90.219(d). In order to meet FCC requirements 90.219 (d), it may be necessary for the installer to reduce the UL and/or DL output power for certain installations.</p>
---	--

FCC Part 15

This device complies with part 15 of the FCC Rules. Operation is subject to the following two conditions:

1. This device may not cause harmful interference, and
2. This device must accept any interference received, including interference that may cause undesired operation.

If not installed and used in accordance with the instructions, this equipment generates, uses and can radiate radio frequency energy. However, there is no guarantee that interference will not occur in a particular installation. If this equipment does cause harmful interference to RF reception, which can be determined by turning the equipment off and on, the user is encouraged to try to correct the interference by one or more of the following measures:

- Reorient or relocate the Donor antenna.
- Increase the separation between the equipment and receiver.
- Connect the equipment into an outlet on a circuit different from that to which the receiver is connected.

Unauthorized Changes to Equipment

Changes or Modifications not expressly approved by the manufacturer responsible for compliance could void the user's authority to operate the equipment

FCC RF Exposure Limits

This unit complies with FCC RF exposure limits for an uncontrolled environment. This equipment can only be installed in in-building applications, driving passive or active DAS systems. All antennas must be operated at a minimum distance of 49 cm between the radiator and any person's body.

Antenna Installation

Installation of an antenna must comply with the FCC RF exposure requirements. The antenna used for this transmitter must be mounted on permanent structures.

The FCC regulation mandate that the ERP of type A signal boosters should not exceed 5W, this is equivalent to 8.2W EIRP.

Therefore the max antenna gain allowed for this type of signal booster should be limited to the values given by equation (1) for the service antenna and equation (2) for the donor antenna

Equation (1) - Max SERVICE antenna gain
 Max SERVICE antenna gain (dBi) = 39.1 – (37dBm - # of antennas in dB – cable losses in dB).

For example:

No. of Antennas	Cable Losses	Max Allowed Antenna Gain
4	3	39.1 - (37-6-3) = 11.1dBi
1	3	39.1 - (37-0-3) = 5.1dbi
10	3	39.1 - (37-10-3) = 15.1dbi

Equation (2) - Max DONOR antenna gain
 Max DONOR antenna gain (dBi) = 39.1 – (37dBm - cable losses in dB).

For example:

No. of Antennas	Cable Losses	Max Allowed Antenna Gain
1	10	39.1 - (37-10) = 12.1dBi

Compliance with FCC deployment rule regarding the radiation of noise

Good engineering practice must be used in regard to the signal booster's noise radiation. Thus, the gain of the signal booster should be set so that the ERP of the output noise from the signal booster should not exceed the level of -43 dBm in 10 kHz measurement bandwidth.

In the event that the noise level measured exceeds the aforementioned value, the signal booster gain should be decreased accordingly.

In general, the ERP of noise on a spectrum more than 1 MHz outside of the pass band should not exceed -70 dBm in a 10 kHz measurement bandwidth.

The 3604 BSF0038 Series Repeater has a noise level of -45 dBm in 10 kHz measurement at 1 MHz spectrum outside the passband of the signal booster and an *in-band* noise level at around -45 dBm in a 10 kHz bandwidth. Therefore, the noise at the antenna input port should be calculated based on equation (3).

Equation (3) - Input Noise to service antenna

Input Noise to service antenna:

$$-45 \text{ dBm} + \text{Service Antenna gain} - \text{Antenna splitter losses in dB} - \text{cable loss in dB}$$
Example:

Signal booster connected to 20 service antennas with a 100m long ½ inch cable.

Losses of such a cable with the connectors = ~ 12dB

Gain = ~ 2 dBi

Assuming 20 service antennas: antenna splitter losses = 15 dB

Based on equation (3) Input antenna noise (to the antenna) = $-45+2-12-15=-70$ dBm

The inband input noise to the antenna should be $-45+2-12-15=-70$ dbm

NOTE: In this example there is no need to add an external band pass filter to attenuate the out of band noise. If fewer antennas are deployed then additional filtering may be required





Conclusion:

Good engineering practice requires that in general when the out of band noise measured at the service antenna input is more than -70 dBm per 10 kHz measurement bandwidth, an external band pass filter should be added to attenuate the out of band noise level.

All Axell Wireless repeaters include high selectivity duplexers and filters to attenuate the out of band noise. Should additional filtering be required, we have a comprehensive range of interference filters which can be supplied upon request.

General Safety Warnings Concerning Use of This System

Always observe standard safety precautions during installation, operation and maintenance of this product.

 <p>Caution labels!</p>	<p>Throughout this manual, there are "Caution" warnings. "Caution" calls attention to a procedure or practice, which, if ignored, may result in injury or damage to the system, system component or even the user. Do not perform any procedure preceded by a "Caution" until the described conditions are fully understood and met.</p>
 <p>Danger: Electrical Shock</p>	<p>To prevent electrical shock when installing or modifying the system power wiring, disconnect the wiring at the power source before working with un insulated wires or terminals.</p>
 <p>Caution: Safety to personnel</p>	<p>Before installing or replacing any of the equipment, the entire manual should be read and understood.</p> <p>The user needs to supply the appropriate AC or DC power to the repeater. Incorrect power settings can damage the repeater and may cause injury to the user.</p> <p>Please be aware that the equipment may, during certain conditions become very warm and can cause minor injuries if handled without any protection, such as gloves.</p>
 <p>Caution: RF Exposure</p>	<p>RF radiation, arising from transmitter outputs connected to AWL's equipment, must be considered a safety hazard.</p> <p>This condition might only occur in the event of cable disconnection, or because a 'spare' output has been left un-terminated. Either of these conditions would impair the system's efficiency. No investigation should be carried out until all RF power sources have been removed. This would always be a wise precaution, despite the severe mismatch between the impedance of an N type connector at 50Ω, and that of free space at 377Ω, which would severely compromise the efficient radiation of RF power. Radio frequency burns could also be a hazard, if any RF power carrying components were to be carelessly touched!</p> <p>Antenna positions should be chosen to comply with requirements (both local & statutory) regarding exposure of personnel to RF radiation. When connected to an antenna, the unit is capable of producing RF field strengths, which may exceed guideline safe values especially if used with antennas having appreciable gain. In this regard the use of directional antennas with backscreens and a strict site rule that personnel must remain behind the screen while the RF power is on, is strongly recommended.</p> <p>Where the equipment is used near power lines or in association with temporary masts not having lightning protection, the use of a safety earth connected to the case-earthing bolt is strongly advised.</p>

PRODUCT DESCRIPTION AND USER'S MANUAL





 <p>Caution: Safety to equipment</p>	<p>When installing, replacing or using this product, observe all safety precautions during handling and operation. Failure to comply with the following general safety precautions and with specific precautions described elsewhere in this manual violates the safety standards of the design, manufacture, and intended use of this product.</p> <p>Changes or modifications not expressly approved by the party responsible for compliance could void the user's authority to operate the equipment.</p> <p>Axell Wireless assumes no liability for the customer's failure to comply with these precautions. This entire manual should be read and understood before operating or maintaining the repeater.</p>
 <p>Warning: Restricted Access Location</p>	<p>Access to the Axell unit installation location is restricted to SERVICE PERSONNEL and to USERS who have been instructed on the restrictions and the required precautions to be taken.</p>
 <p>Attention: Electrostatic Sensitivity</p>	<p>Observe electrostatic precautionary procedures. ESD = Electrostatic Discharge Sensitive Device.</p> <p>Static electricity can be conducted to the semiconductor chip from the centre pin of the RF input connector, and through the AC connector pins. When unpacking and otherwise handling the repeater, follow ESD precautionary procedures including use of grounded wrist straps, grounded workbench surfaces, and grounded floor mats.</p>
 <p>Caution: Class 1 Laser</p>	<p>The repeaters described in this manual are equipped with class 1 lasers, as per definition in EN 60825-1</p> <p>Caution - Un-terminated optical receptacles may emit laser radiation. Exercise caution as follows:</p> <ul style="list-style-type: none"> • Do not stare into beam or view with optical instruments. Optical transmitters in the fibre optic converter can send out high energy invisible laser radiation. There is a risk for permanent damage to the eye. • Always use protective cover on all cables and connectors which are not connected. • Never look directly into a fibre cable or a connector. • Consider that a fibre can carry transmission in both directions. • During handling of laser cables or connections, ensure that the source is switched off. • Regard all open connectors with respect and direct them in a safe direction and never towards a reflecting surface. Reflected laser radiation should be regarded as equally hazardous as direct radiation.

Table of Contents

BSF-4004 UHF Repeater	I
FCC Part 90.....	IV
Unauthorized Changes to Equipment.....	IV
FCC RF Exposure Limits.....	IV
Antenna Installation.....	V
Compliance with FCC deployment rule regarding the radiation of noise.....	V
1 Introduction	1
1.1 Features and Capabilities.....	2
1.2 ALC	3
1.3 Operating Temperature	3
1.4 Management WEB GUI	4
1.5 Interfaces	4
1.5.1 Securing the Unit.....	4
1.5.2 External Interfaces	5
1.5.3 Internal Interfaces.....	6
2 Antenna and Repeater Installation Requirements	7
2.1 BSF-4004 Installation Requirements.....	7
2.1.1 Safety Guidelines	7
2.1.2 Criteria for Repeater Installation Location	7
2.1.3 RF Cable Installation Guidelines	8
2.1.4 F/O Cable Installation Guidelines.....	8
2.2 Service Antenna Requirements	8
2.2.1 Required Antenna Information	8
2.2.2 Indoor Installations	9
2.2.3 Service (Mobile) Antenna Installation Criteria	10
2.3 RF Cabling Requirements	10
3 Installation	1
3.1 Unpacking.....	1
3.2 Mount the Repeater.....	1
3.2.1 Selecting a Location to Ensure Proper Cooling	2
3.2.2 Wall-Mounting Preparation.....	2
3.2.3 Mount the Repeater on the Wall.....	5
3.3 Grounding.....	7
3.4 Ensure Good EMV Protection	8
3.5 Fibre Optic Connection	10
3.6 External Alarm and Relay Connections	13
3.6.1 External Alarm	13
3.6.2 Relay	13
3.7 Power and Backup Battery.....	14
3.7.1 Circuit Breaker.....	14
3.7.2 Power Connections	14
3.7.3 Power ON.....	18
3.8 Closing and Securing the Repeater	18
4 BSF-4004 Commissioning	19
4.1 Open a Session to the BSF-4004 via the OMU II.....	19

PRODUCT DESCRIPTION AND USER'S MANUAL

- 4.2 BSF-4004 Optical Loss Adjustment (OLA)20**
- 4.3 RF Balancing22**
 - 4.3.1 Manual RF Balancing22
 - 4.3.2 Automatic BSF-4004 RF Balancing.....24
- 4.4 Integration into the AEM.....25**
- 4.5 What Next?.....25**
- 5 BSF-4004 Full GUI Description.....26**
 - 5.1 Opening a Direct Web Session26**
 - 5.1.1 Connecting Locally26
 - 5.1.2 Remote Connection and Login27
 - 5.2 Navigating the Web Interface28**
 - 5.2.1 Management Options Buttons29
 - 5.2.2 Home Screen Overview30
 - 5.2.3 Configuration Screen Overview.....31
 - 5.3 Configuring General Parameters.....32**
 - 5.3.1 Site Information – BSF-4004 Identification.....32
 - 5.3.2 Date & Time.....33
 - 5.3.3 Configure External Alarms33
 - 5.3.4 IP Address34
 - 5.4 Remote Communication Setup.....35**
 - 5.4.1 TCP/IP and Ethernet35
 - 5.4.2 Modem Setup36
 - 5.5 SNMP Support38**
 - 5.6 User Accounts40**
 - 5.6.1 Default User Accounts.....40
 - 5.6.2 User Access Levels40
 - 5.6.3 Change Password41
 - 5.7 Reboot41**
 - 5.8 Axell Shell (Command Line Interface).....42**
 - 5.9 Attribute Reference43**
- 6 Monitoring, Fault Sourcing and Maintenance44**
 - 6.1 Cautions and General Statements.....44**
 - 6.2 Monitoring Via the BSF-4004 Home Screen45**
 - 6.3 Logs Screen.....49**
 - 6.4 Module LEDs.....50**
 - 6.4.1 Control Module LEDs51
 - 6.4.2 F/O Converter LEDs.....52
 - 6.4.3 Power Supply LEDs.....53
- Appendix A - Specifications.....54**
- Appendix B - F/O Cleaning Procedure55**

1 Introduction

The BSF 4004 is a fibre optic fed UHF repeater. It is part of a system that is fed from an Optical Master Unit (OMU), supporting WDM technology, lowering the number of fibres needed per system. The maximum optical loss of up to 10dB is allowed over the fibre interconnecting the OMU II and the most distant last remote unit that the OMU supports. This offers great flexibility when providing RF coverage in areas where it is not possible to rely on off-air transmission.

The fibre optic system is easily remotely monitored and controlled by Axell Wireless effective supervision tool, Axell Wireless Element Manager.

The BSF-4004 includes automatic optical gain settings, where the gain is adjusted in the downlink chain by measuring the level of the pilot carrier sent from the Optical Master Unit (OMU). The level of the received pilot carrier is continuously monitored.

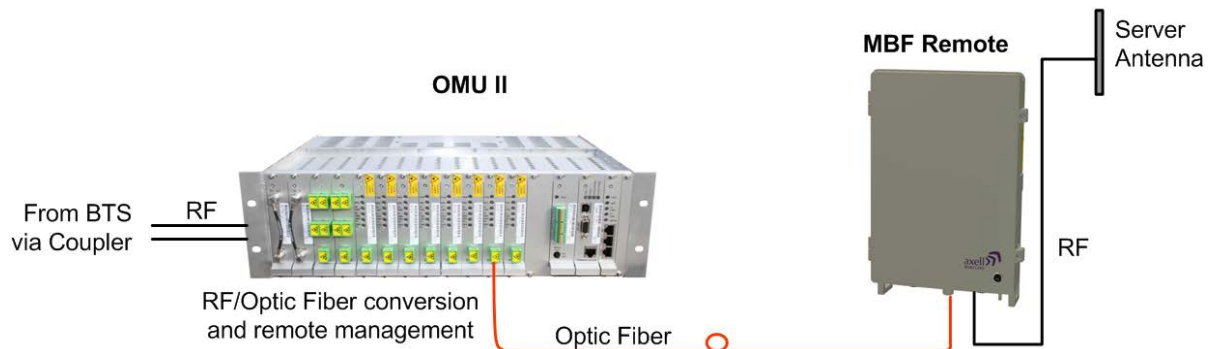

Figure 1-1 Illustration of OMU II Connection to BSF Remote

1.1 Features and Capabilities

- Supports frequency bands 423-430MHz
- Operational bandwidth: 2 MHz
- Duplex Distance: 5 MHz
- Output Power per carrier UL/DL:
 - 1 carrier: + 36dBm
 - 2 carriers: + 33dBm
 - 3-4 carriers: +30dBm
 - 8 carriers: +27dBm
- Supports WDM technology
- Automatic Optical Gain Setting via OMU II
- Remote configuration and management:
 - Via OMU II intuitive Web GUI
 - Via AEM – automatically detected via AEM no local setup required
 - Optionally via Ethernet or GSM, GSM-R PSTN modem
 - SNMP v1/v2c support
- Automatic Level Control (ALC) - provides constant gain in both uplink and downlink paths according to the defined maximum output level
- Very low noise factor - minimizes interference to BTS and increases high speed data throughput
- Backup battery for 'last gasp', sending fault error before power failure
- Wall or pole mount conforming to IP65 and NEMA 4 standard
- Power source: 115VAC, 230 VAC or -48V power (depending on your order)

1.2 ALC

The repeater is equipped with an ALC, Automatic Level Control. The ALC feature enables maintaining the maximum defined output level.

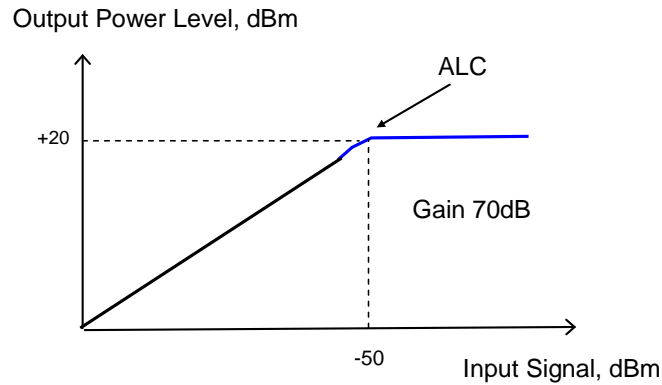

The repeater has a defined maximum output level. If the input signal amplified by the gain set exceeds the set output limit, an ALC (Automatic Level Control) loop is activated. This ALC ensures that the amplifier does not add distortion to the radio signal. Below are examples of the ALC function for one and two carriers.

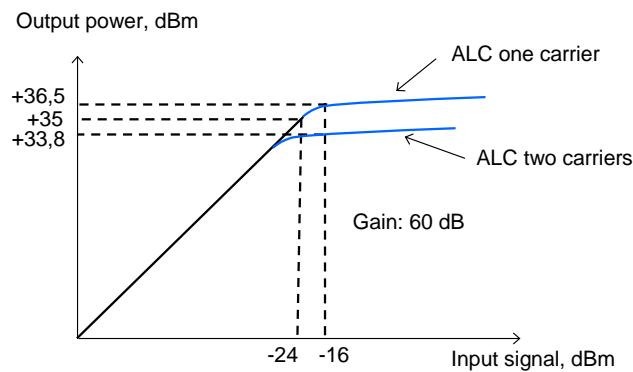

1.3 Operating Temperature

The BSF-4004 is designed primarily for multi carrier purposes. If the repeater is run at full output power over a long period of time, the convection cooling may not be enough. The repeater is equipped with a power management function that steps down the power and, if needed, fully shuts down the amplifier chains until temperature reaches normal values. In situations where a repeater will be run in such a manner extra cooling can be provided by putting the repeater in a temperature controlled environment or via external fans.

1.4 Management WEB GUI

BSF-4004 is remotely commissioned and monitored via an OMU II session. Local access to the unit is not required for commissioning.

Additional configuration and troubleshooting options are available via a direct connection to the BSF-4004 IP address. A direct session can be opened locally or remotely.

Note: Direct remote communication requires connecting the BSF-4004 to an Ethernet network and configuration of an IP address, or via GSM/GSM-R PSTN modem.

1.5 Interfaces

The BSF-4004 unit provides four types of interfaces:

- Lock and screws for protection and security
- External service antenna and GND connections
- Internal connections for power, fibre optics and alarm cables routed via openings in the front panel.
- Internal USB/Ethernet connection for (optional) management and analysis via Web GUI

1.5.1 Securing the Unit

The repeaters are secured with two hex screws (M8) and can also be locked with a key.

Note: The two screws must be fully tightened. Failure to do so may affect the IP65 compliancy and therefore any warranty.

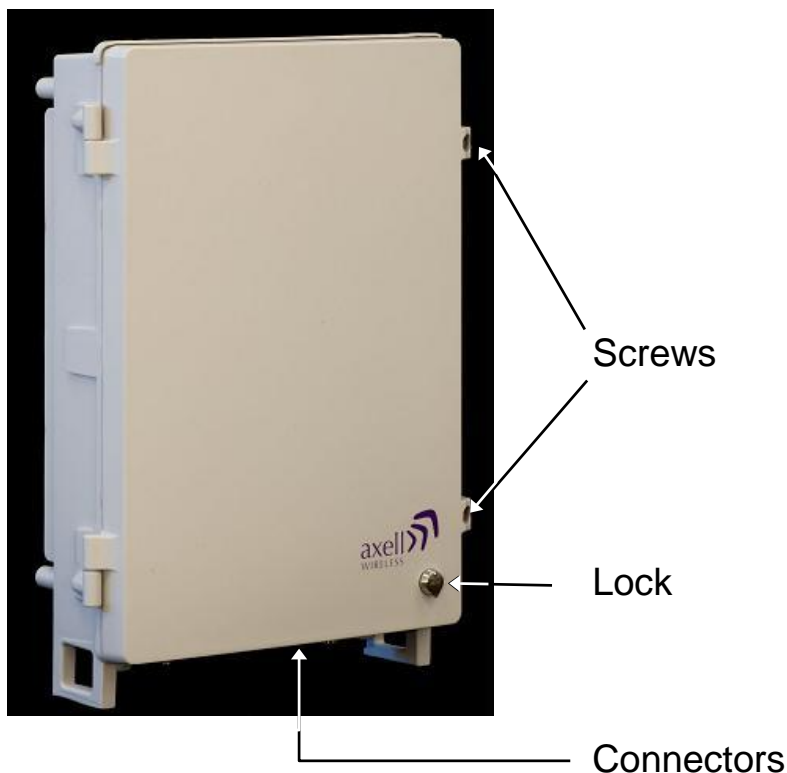
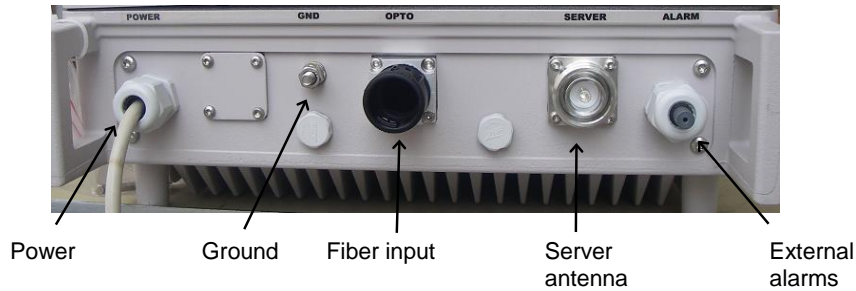

Figure 1-2: Securing the Unit

1.5.2 External Interfaces

The repeater's interfaces are located on the underside panel.

Note: The external connections at the bottom of the repeater can be protected by a cover which is screwed in place.



The following table provides a description of the front panel ports and connections.

Port	Description
Server	Service antenna connection – N type connector, female
Optic	SC/APC fibre optic connector through which the optic fibre is routed for internal connections (section 3.5).
Power	Plinth connection for routing power for internal connection (section 3.7)
Alarms	Plinth connector for routing external alarms and relay wiring cable for internal connections (section 3.6).
GND	Grounding lug (section 3.3)

1.5.3 Internal Interfaces

This section shows the internal interfaces for the repeater. You will need to open the Repeater in order to do the following:

- Connect power
- Connect optic fibres
- Connect alarms (if relevant)
- Power-on (Power-ON and Battery ON switches)
- **Optional** – USB/Ethernet port for local setup

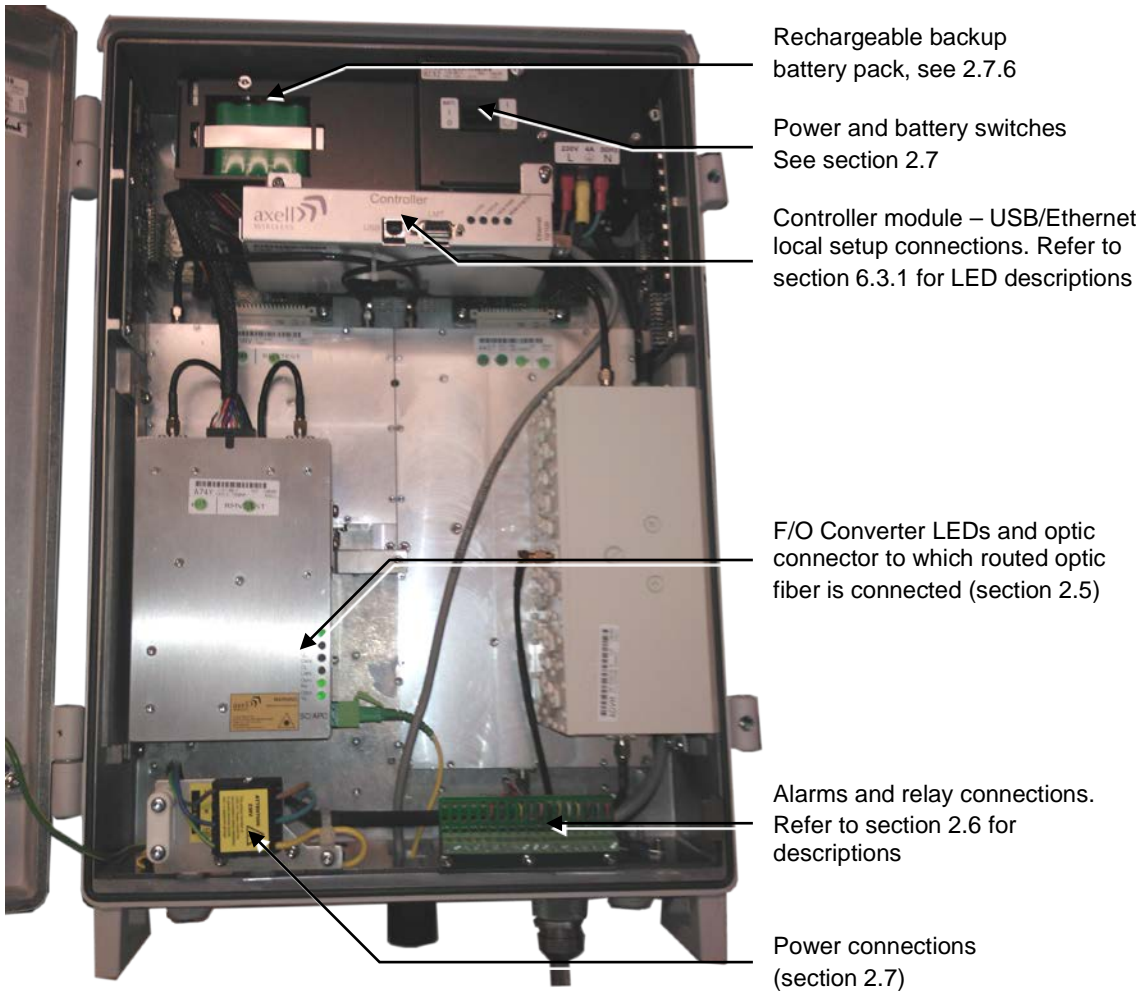

Figure 1-3: Single Band Repeater with Door Open

2 Antenna and Repeater Installation Requirements

This chapter provides information on the Remote installation site requirements, on the installation requirements of the antennas, the specifications of the service antennas suitable for operation with this remote and RF and F/O cable requirements.

2.1 BSF-4004 Installation Requirements



2.1.1 Safety Guidelines

Before installing the Repeater, review the following safety information:

- Follow all local safety regulations when installing the Repeater.
- Only qualified personnel are authorized to install and maintain the Repeater.
- Ground the Repeater with the grounding bolt located on the external lower side of the Repeater.
- Do not use the grounding bolt to connect external devices.
- Follow Electro-Static Discharge (ESD) precautions.
- Use low loss cables to connect the antennas to the Repeater.

Class 1 Laser

This product is equipped with class 1 lasers, as per definition in EN 60825-1.

 	<p style="text-align: center;">Caution!!!</p> <p>Un-terminated optical receptacles may emit laser radiation. Do not stare into beam or view with optical instruments.</p>
---	--

2.1.2 Criteria for Repeater Installation Location

The following criteria should be considered when selecting the Repeater installation site location:

- Application type
- General surroundings
- Available installation
- Install the Repeater in a shielded, ventilated, and easy-to-reach area.
- Verify that there is a minimum of a 50 cm (20”) radius of space around the Repeater, enabling easy access to the repeater for maintenance and on-site inspection.
- Distance from antenna site - It is recommended that the installation location be as close as possible to the antenna site in order to maintain the cable loss to a minimum.
- The Repeater is convection cooled so airflow and alternation should be possible.
- Follow Electro-Static Discharge (ESD) precautions.
- Install the Repeater close to the service area to monitor the output power.
- Use low loss cables to connect the antennas to the Repeater.

2.1.3 RF Cable Installation Guidelines

Required:

- For all coaxial connections to/from the Repeater - high performance, flexible, low loss 50Ω coaxial communications cable.
- All cables shall be weather-resistant type.
- Cable length - determined by the Repeater installation plan. When calculating the cable length, take into account excess cable slack so as not to limit the insertion paths.

2.1.4 F/O Cable Installation Guidelines

Use the following over the complete link between the Remote and OMU:

- Use angled APC connectors at 8deg angle.
- APC type ODF connections.
- Cable length - determined by the Remote installation plan. When calculating the cable length, take into account excess cable slack so as not to limit the insertion paths.

Recommended fibre-optic cable:

- Single mode 9/125

2.2 Service Antenna Requirements

**WARNING!!!**

- a. The installer is held accountable for implementing the rules required for deployment.
- b. Good engineering practice must be used to avoid interference.
- c. Output power should be reduced to solve any IMD interference issues”

The Service antenna type depends on the design of the indoors DAS.

2.2.1 Required Antenna Information

The following antenna requirements, specifications and site considerations should be met:

- Type of installation – indoor DAS/Radiating Cable
- Service area type and size
- Antenna type and characteristics
- Height
- Length and type of coaxial cable required for connecting the antenna to the Repeater and the attenuation.

2.2.2 Indoor Installations

2.2.2.1 Recommended Antennas

The following describes the requirements for an omni-directional mobile used for indoor applications.

Specifications:

- One or a combination of the following antennas can be used: Ceiling Mount Patch antenna, Wall Mount Patch antenna, Corner Reflector.
- Choose an antenna with high side lobe attenuation which enables maximum isolation from the service/ mobile antenna.

Equation (1) - Max SERVICE antenna gain
 Max SERVICE antenna gain (dBi) = 39.1 – (37dBm - # of antennas in dB – cable losses in dB).

For example:

No. of Antennas	Cable Losses	Max Allowed Antenna Gain
4	3	39.1 - (37-6-3) = 11.1dBi
1	3	39.1- (37-0-3) = 5.1dBi
10	3	39.1- (37-10-3) = 15.1dBi

Typical Antenna Types:

- Indoor Dome 2.1dBi beam width 360°
- Indoor Panel 4.2dBi beam width 106°
- Radiating Cable Typically < -50dBi

2.2.2.2 Recommended Splitters and Couplers

Axell Wireless can supply a comprehensive range of splitters and Couplers to aid the installation of the internal DAS system. Typical specifications as below:

Splitter Part Numbers	90-851202	90-851203	90-851204
Frequency Band	300 - 500MHz		
Split	2 way	3 way	4 way
Max Insertion Loss	0.3dB	0.5dB	0.4dB
Split Loss	3dB	4.8dB	6dB

Coupler Part Number	90-852306	90-852310	90-852315	90-852320
Frequency Band	300 - 500MHz			
Coupling	-6dB ±1.0dB	-10dB ±1.0dB	-15dB ±1.0dB	-20dB ±1.0dB
Max Mainline Loss	1.7dB	0.8dB	0.4dB	0.22dB

2.2.2.3 Installation Criteria

Determine the antenna installation configuration, according to the transmission requirements and the installation site conditions.

Installation requirements:

- An indoor antenna should be installed at a convenient location. It should be free of metallic obstruction.

Install the Service Antenna at the designated height and tune it roughly toward the Service coverage area.

2.2.3 Service (Mobile) Antenna Installation Criteria

Determine the antenna installation configuration, according to the transmission requirements and the installation site conditions.

Installation requirements:

- An indoor antenna should be installed at a convenient location. It should be free of metallic obstruction.
- Install the Service Antenna at the designated height and tune it roughly toward the Service coverage area.
- Installation of this antenna must provide a minimum separation distance of 49 cm from any personnel within the area.

2.3 RF Cabling Requirements

- For all coaxial connections to/from the Repeater - high performance, flexible, low loss 50Ω coaxial communications cable.
- All cables shall be weather-resistant type.
- Cable length - determined by the Repeater installation plan. When calculating the cable length, take into account excess cable slack so as not to limit the insertion paths.
- Make sure that cable and connector are compatible. Using cables and connectors from the same manufacturer is helpful.
- All connectors must be clean and dry
- Waterproof all outdoor connections using silicone, vulcanizable tape or other suitable substance as moisture and dust can impair RF characteristics.
- Make sure enough room has been allocated for the bending radius of the cable. RF cables must not be kinked, cut or damaged in any way
- Connect the RF cable to the antenna tightly but without damaging threads
- Fasten cables tight to cable ladder or aluminum sheet
- For short length of feeder cables use ½", for longer feeder cables use 7/8". Choose thicker coax cables for lower attenuation. Minimize the length of the coax cables to reduce the attenuation
- Use jumper cable for easy installation. The RF Coaxial cable can be substituted at each end with a jumper cable.

3 Installation

3.1 Unpacking

Inspect the shipped material before unpacking the equipment, document any visual damage and report according to routines.

A delivery of a repeater from Axell Wireless contains:

- Checklist with delivered items
- Repeater
- Mounting brackets
- 4 bolts for attaching repeater to mounting kit
- Cable cover
- Keys to repeater and insex tool for bolts
- Hose for fibre inlet
- CD containing User's Manual and RMC
- Any other specifically ordered item

3.2 Mount the Repeater

You can mount the BSF-4004 Remote on a wall or in a 19" inch rack. The Repeater is delivered with mounting brackets.

Mount the repeater in an accessible location and in a location that fulfils the environmental requirements. Mounting must be tight to eliminate vibration.

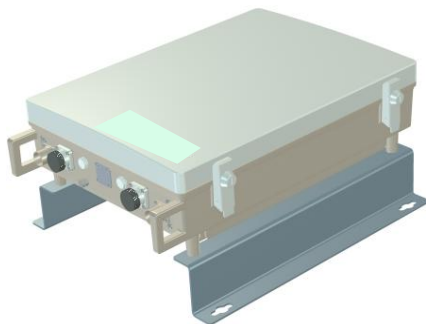

Figure 3-1: Mounting bracket position for wall mounting

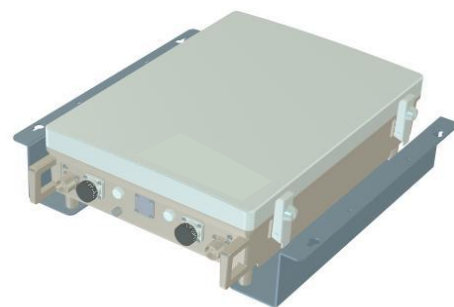

Figure 3-2: Mounting bracket position for rack mounting

3.2.1 Selecting a Location to Ensure Proper Cooling

- Mount the repeater so that heat can be dispersed from it.
- The repeater wall mounting kit ensures an optimum airflow between the wall and the repeater.
- Do not block this air channel as it will cause the MTBF of the repeater to drop dramatically, or even in the worst case cause the repeater to fail completely.
- *If possible, use a wall in the shade to minimize the overall sun loading. If sufficient shielding cannot be obtained, an additional sun shield should be mounted.*



Figure 3-3: Example of a sun shield

3.2.2 Wall-Mounting Preparation

Caution!! It is recommended that two people lift the repeater since (depending upon the configuration) the BSF-4004 weighs approximately 28 kg.

- **Wall compatibility** - check the suitability of the wall on which the BSF-4004 is to be fitted.
- **Plan mount** - check the actual fixing centres (see below) and overall dimensions of the BSF-4004 enclosure. The BSF-4004 is supplied with two wall mounting brackets; when the BSF-4004 is mounted on these brackets adequate ventilation is provided between the BSF-4004 and the wall to which it is fixed.
- **Plan connection cable clearances** - the Optical, RF and power connections located on the underside of the BSF-4004 will need at least 300mm vertical clearance below the BSF-4004 to enable the connections to be made. The minimum bend radius for Optical and RF cables must not be less than the recommendations made by the cable manufacturer. Plan the cable runs and ensure adequate space is available.
- **Allow for door opening** - ensure that there is sufficient space at the front of the BSF-4004 to allow the door to be fully opened and for maintenance engineers to get access to the unit with test equipment such as a spectrum analyzer. Allow an additional 500mm of space in front of the BSF-3604 when the door is fully open.

- Fix bolts** – fix M6 Rawbolts or similar (50 to 75mm in length) into the wall at the dimensions as illustrated in figure 1 below using equipment as specified by the fixing manufacturer. A recommended method is set out below. Care must be taken to ensure the alignment of the four fixings. A spirit level or plumb line should be used to ensure horizontal/vertical alignment.

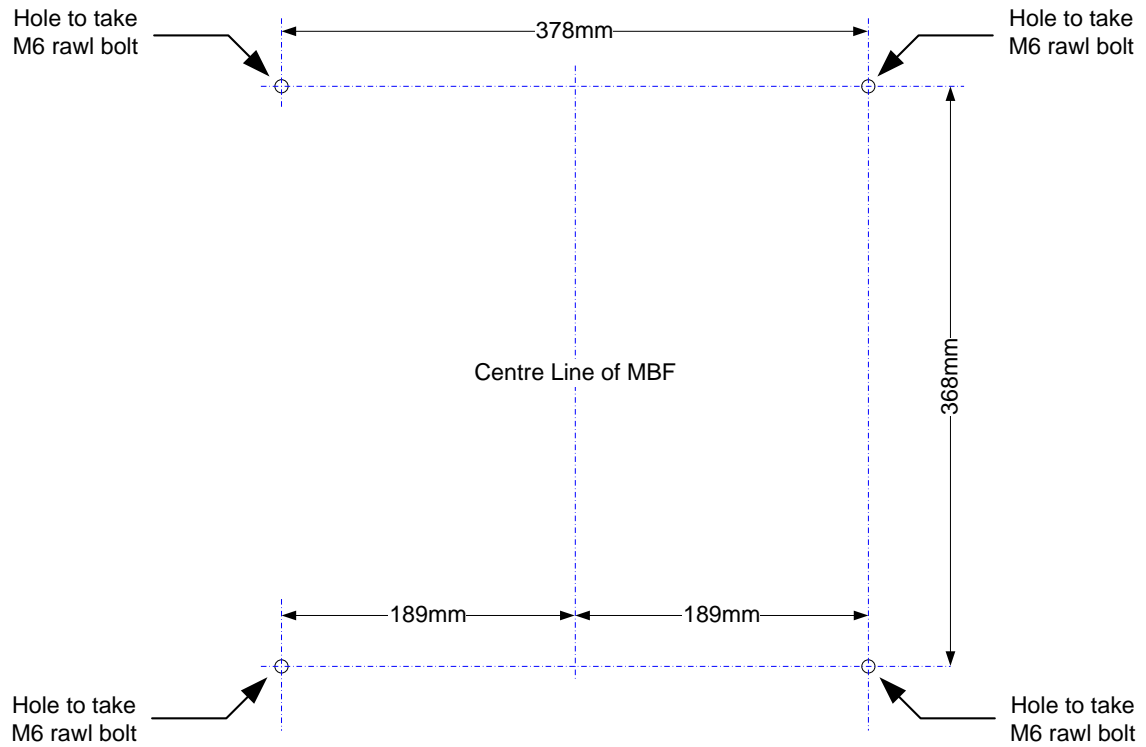

Figure 3-4: Fixing Centres

Fix mounting brackets to BSF – use the supplied four M8 bolts and spring washers.

Fix mounting brackets to MBF with M8 fixing bolts and spring washers supplied

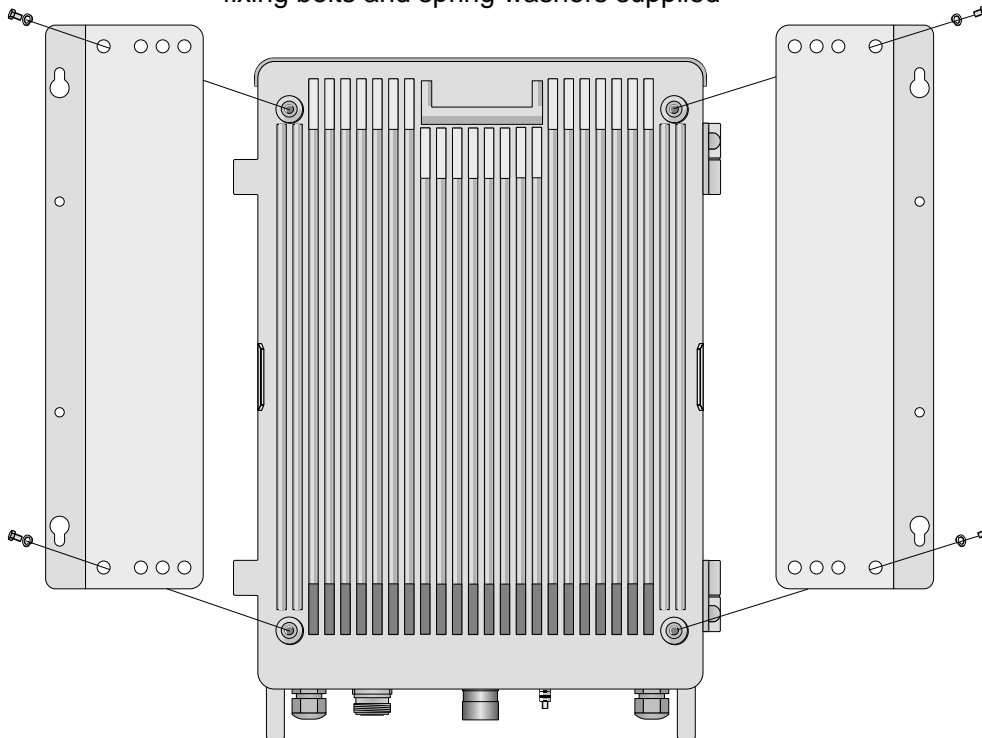

Figure 3-5: Fix mounting plates to BSF

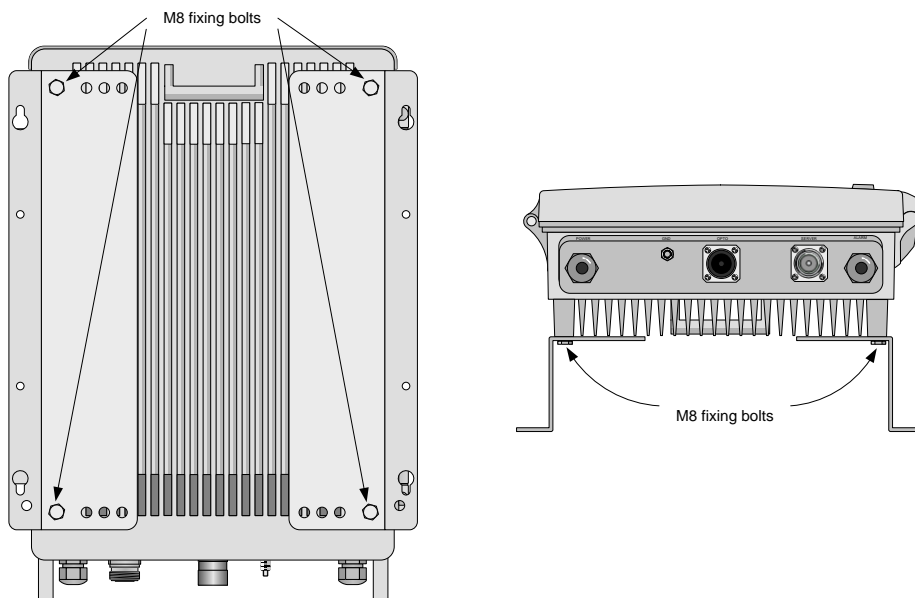

Figure 3-6: Mounting Plates Fixed to BSF

3.2.3 Mount the Repeater on the Wall

The Repeater wall mount brackets assembly should be fixed to a solid wall (these include brickwork, blockwork, and concrete.);

(Due to the weight of the Repeater, it is NOT recommended to fix to a hollow wall).

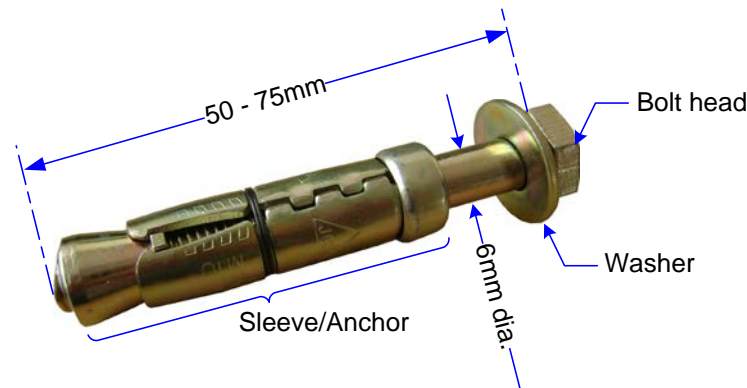

Figure 3-7: M6 Rawlbolt – recommended for wallmount.

IMPORTANT!

Always check that there are no pipes or cables hidden in the wall beneath the area to be drilled. Various pipe and cable detectors are available for this type of inspection.

To provide secure fixing to a solid wall, the most common method is drilling and plugging. The size of fixing is dependent on the item to be fixed and the nature of the wall, The Repeater should be fixed with mild steel, M6 (50mm to 75mm) rawlbolts or similar.

1. Mark out the fixing centres of the repeater on the chosen wall (see 3.2.2).
2. Mark and drill the wall with the correct size masonry bit as specified by the fixing manufacturer.

Note: It is good practice to wear goggles to protect your eyes from flying debris when using power tools.

3. Hold the drill bit against the mark and begin drilling slowly so that the bit does not wander from the position. The wall should be drilled to a depth which is sufficient to accommodate the full length of the fixing.
4. Insert the fixings so that the top of the sleeve/anchor section is level with the wall surface.
5. Gently tighten the bolt by hand so that the anchor section of the fixing expands and grips the inside of the hole.

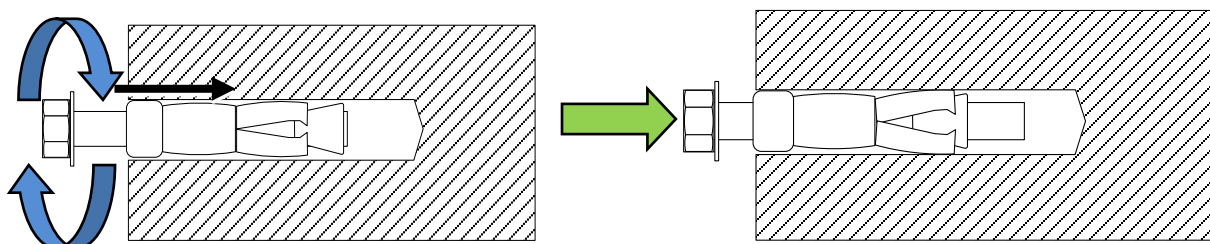

Figure 3-8: Inserting Fixing and Tightening.

- As the bolt pulls its way in, the sides of the anchor section are forced outwards, gripping the surrounding surface.

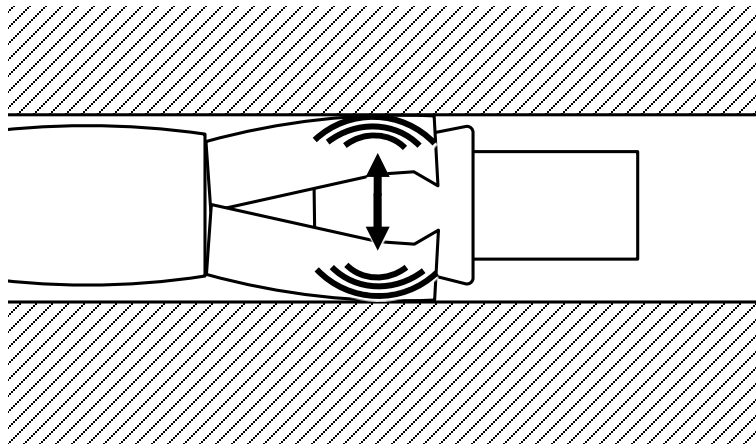

Figure 3-9: Anchor Sides Pushed Outwards.

- Once all four fixings are in place, carefully withdraw the four bolts.

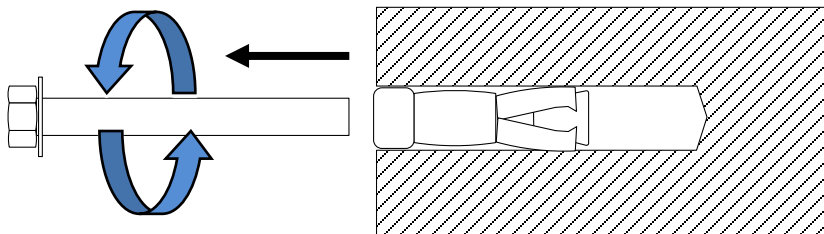

Figure 3-10: Withdraw Bolts.

- Align repeater with the four fixings. Great care should be exercised here as the repeater is very heavy. Once repeater is held in the chosen position (a suitably rated heavy duty scissor lift table/trolley may be suitable for this operation). Carefully insert the fixing bolts through the mounting lugs of the Repeater and into the sleeve/anchor sections of the fixing in the wall and tighten the bolts.

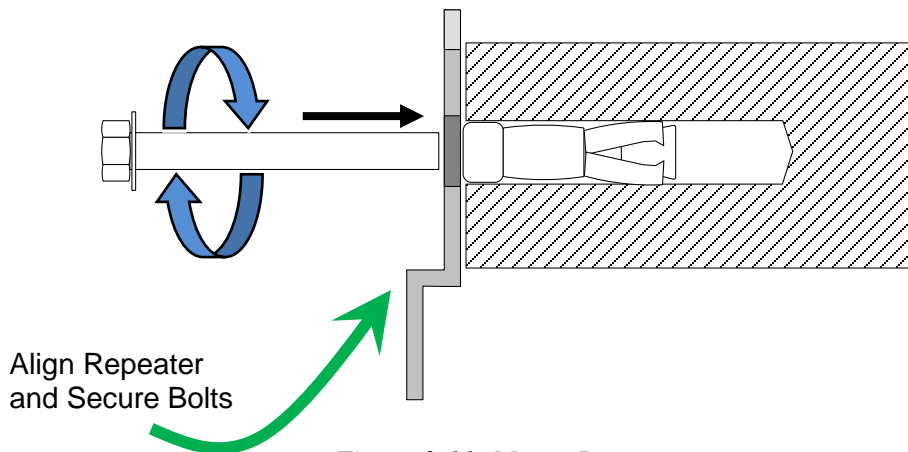

Figure 3-11: Mount Repeater

3.3 Grounding

Connect the grounding protection as follows:

- Ensure that good grounding protection measures are taken to create a reliable repeater site.
- Make sure to use adequately dimensioned grounding cables. The minimum recommended conductive area for a grounding cable is 16mm²
- Make sure the grounding product used is suitable for the kind and size of cable being used.
- Connect the repeater box bolt to the same ground.



Ground

Figure 3-12: Grounding the BSF-3604



3.4 Ensure Good EMV Protection

CAUTION! If insufficient Electromagnetic Protection is provided, or if EMV measures are not taken, warranties issued by Axell Wireless are not valid.

Connect the lightning protection

The lightning hazard to electric and electronic equipment consists in the interferences of direct lightning current infections and high surge voltages induced by the electromagnetic field of nearby lightning channels or down conductors. Amplitudes from cloud-to-earth lightning amounts to several 10kA and may last longer than 2ms. The damage caused depends on the energy involved and on the sensitivity of the electronics systems.

Ensure that lightning protection measures are taken to create a reliable repeater site. Protect all coaxial cables and power cables from the transients caused by lightning. Fit all cables with suitable lightning protection devices.

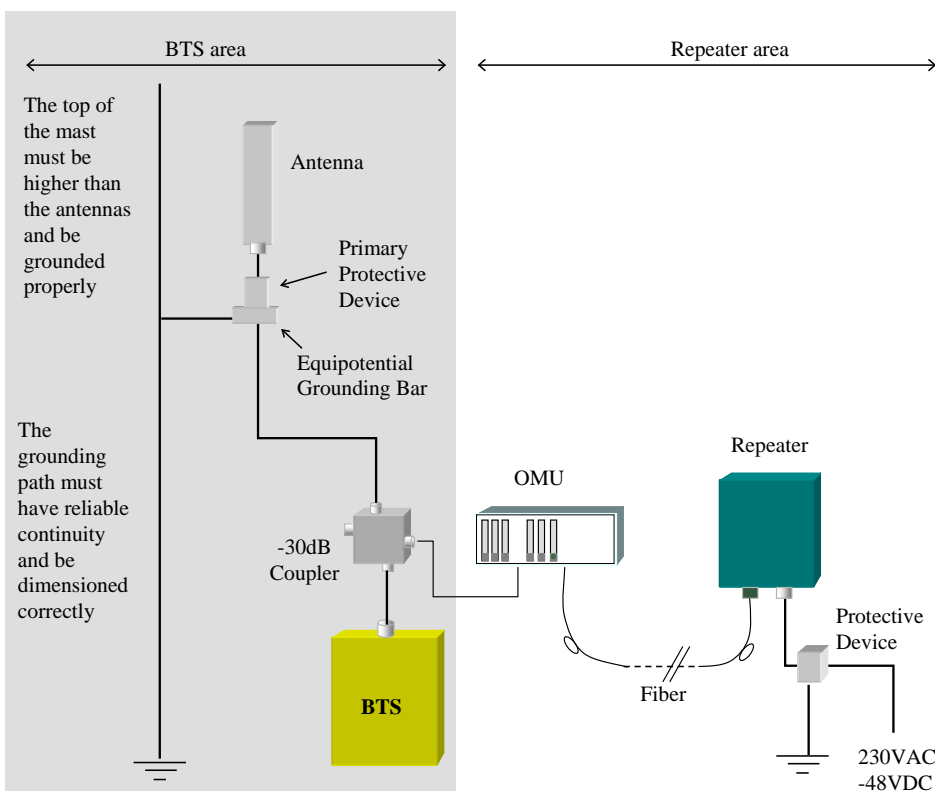

Figure 3-13: Example of EMV protection for a repeater system

For detailed information please refer to IEC 61024-1 and 61312-1 for international standards for protection of information systems against LEMP (Lightning Electromagnetic Pulse), including radio transmitters. They define proper planning, installation and inspection of effective lightning protection systems.

The Axell Wireless repeaters comply with the EN standard ETS 301 498-8 which stipulates demands on lightning/surge protection for typical infrastructure telecom equipment installations.

Several lightning protection devices should be used in series with declining threshold voltages to help attenuate the pulse component which makes it through the first layer of protection.

The primary protective device is part of the site installation and is not supplied by Axell Wireless. Coaxial lightning protection is normally one of these three types: Gas capsule, High-pass and Bandpass.

There also need to be a protective device installed on the power supply cord.





Figure 3-14: Protective device installed in connection with the power supply

3.5 Fibre Optic Connection

Class 1 Laser

This product is equipped with class 1 lasers, as per definition in EN 60825-1.

 	<p style="text-align: center;">Caution!!!</p> <p style="text-align: center;">Un-terminated optical receptacles may emit laser radiation. Do not stare into beam or view with optical instruments.</p>
---	--

Use the following over the complete link between the Repeater and OMU:

- Use angled APC connectors at 8deg angle
- APC type ODF connections
- Mono-mode type fibre

Connecting the Fibre Optic Cable

1. Select type of optic fibre (Recommended fibre cable is single mode 9/125).
2. Run the fibre through a corrugated sleeve (not supplied).



3. Insert the optic fibre hose fitter (may be pre-assembled) and route the fibre cable(s) via the Fibre input (see front panel interfaces in section 1.5.2).

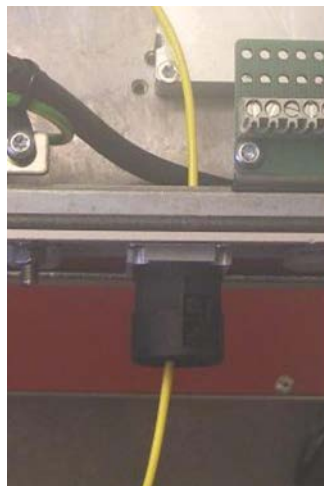

4. Connect the fibre to the Fibre Optic Converter inside the repeater.

Note: Make sure the fibre is not bent too sharply inside the repeater as to avoid communication disruptions.

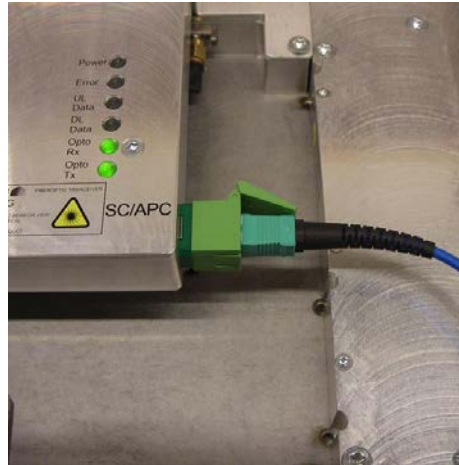

5. Place the fibre in the rubber seal.



Note: The sleeve (not supplied), together with the rubber seal, meets the protection standard IP65.

6. Adjust the fibre length inside the repeater and insert the seal into the fibre input interface.



7. Attach the sleeve to the fibre optic inlet.



Note: Clean the fibre connector before connecting it to the system. See instruction in Appendix B - F/O Cleaning Procedure.

3.6 External Alarm and Relay Connections

The repeater is equipped with an external alarm interface card. The connector plinth for the external alarms is located at the bottom of the repeater.

The strain relief fitting in is a Pg 13.5 suitable for a 6-12 mm cable diameter.

Connect the alarm cords to the plinth according to the pin layout below (in the standard version pins 14 – 18 are not used).

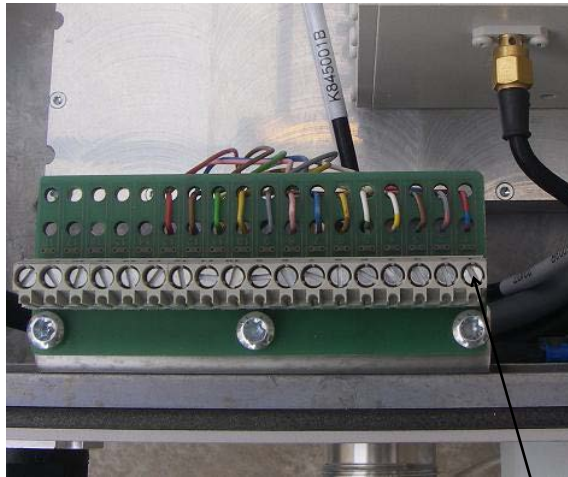

Pin #	Signal
1	External alarm 1A
2	External alarm 1B
3	External alarm 2A
4	External alarm 2B
5	External alarm 3A
6	External alarm 3B
7	External alarm 4A
8	External alarm 4B
9	Alarm +15V
10	Alarm 0V
11	Relay Output 1A
12	Relay Output 1B
13	GND
14	NC
15	NC
16	NC
17	NC
18	NC

3.6.1 External Alarm

- Four external alarm sources can be connected to the repeater.
- Alarm operating voltage: between 12 and 24VDC.
- Alarm polarity can be configured:
 - Active-low - when there is no voltage the alarm indicator will turn red
 - Active-high - an applied voltage of between 12 and 24 V will cause the external alarm indicator to turn red.
- The repeater can supply +15 VDC to an external alarm source through pin 9 and 10. The maximum allowed load is 100mA.

3.6.2 Relay

- Relay (pin 11 and 12) can be connected to an external device to indicate an alarm.
- Can be configured to trigger on any number of internal and external alarms. The maximum current that can be supplied is 100mA.

3.7 Power and Backup Battery

Caution! Make sure the antenna cables or 50 ohm terminations are connected to the repeater's antenna connectors before the repeater is turned on.

Caution! Be sure a **CIRCUIT BREAKER** meeting the instructions given in this section is connected near the unit at an easily reachable and accessible location from the unit.

3.7.1 Circuit Breaker

The power connections to the unit are hard-wired. To disconnect the unit (either manually or automatically in case of overcurrent), it is required to install a circuit breaker *on the wall near the unit*, at an easily accessible distance and location from the unit.

Circuit-breaker minimum requirements

- 10AT, 250VAC
- Needs to be SAFETY approved
- Requires minimum contact separation of 3mm.
- Install on the wall near the unit

3.7.2 Power Connections

The image below shows the location of the various power elements. These are described in detail in the following sections.

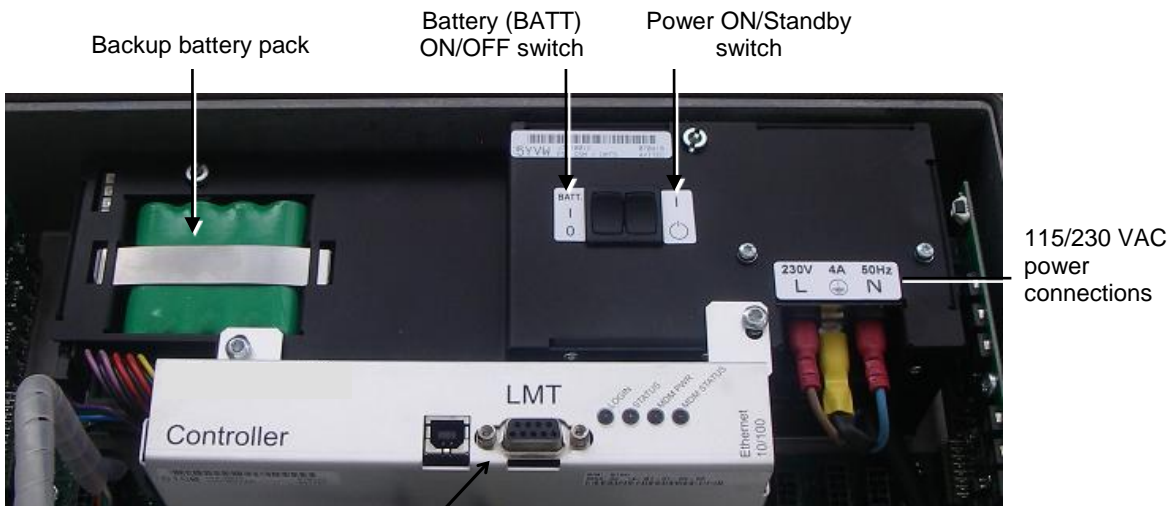

Figure 3-15: Power Elements – Located Inside Repeater

3.7.2.1 Backup Battery

- On the Power Supply unit a rechargeable battery pack is mounted. This part also includes charging and supervision electronics.
- The backup battery will provide the Control Module and modem with enough capacity to send an alarm in case of input power failure.
- The battery can be switched on and off. The switch is placed adjacent to the main power switch on the power supply.
- At delivery the back-up battery is connected.
- The battery is replaced by lifting the battery pack out of the crate and disconnecting the cable.

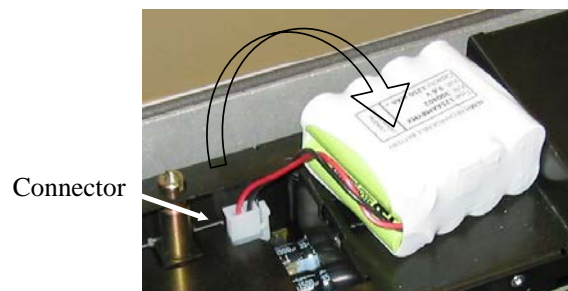

Figure 3-16: Backup Battery

3.7.2.2 Connecting the Power Source

- Power Source: 230 VAC 50 Hz, 115 VAC 60 Hz or -48 VDC
- The -48VDC version of the power supply is designed to turn off if the supply voltage falls below -36V ($\pm 1V$). It will turn on again as the supply voltage reaches -43V ($\pm 1V$).
- The power supply has a switch which allows it to be set in “on” position or in “stand by”.

Notes:

1. In the stand by position the repeater is still connected to the power supply but not operational.
 2. On repeaters mounted in an extended box with two power supplies, both power supplies needs to be switched on.
-

3.7.2.3 230 VAC Power Source

Connect the power cable to the plinth as show below:

- **Phase** linked to the **brown** cable
- **Neutral** linked to the **blue**
- **Ground** to the **yellow/green**. See illustration below.



Figure 3-17: 230 VAC Power Connections

3.7.2.4 115 VAC Power Source

Cable requirements:

- Cable should be NRTL (safety) approved with a minimum of 14AWG (2.5mm) per conductor.
- For safety, the GND cable must be **10mm longer** than the Phase and Neutral cables.

Connect the power cable to the plinth as show below:

- **Phase** linked to the **Black** cable
- **Neutral** linked to the **White**
- **Ground** to the **Green** where for SAFETY, the GND cable must be **10mm longer** than the Phase and Neutral cables.



Figure 3-18: 115VAC Power Connections

3.7.2.5 -48V Power Source Connection

Note: The -48VDC version of the power supply is designed to turn off if the supply voltage falls below -36V ($\pm 1V$), not to drain the feeding battery. It will turn on again as the supply voltage reaches -43V ($\pm 1V$).

-48V power supply requirements

The 48VDC power supply must comply with SELV requirements, as defined in EN60950, which implies double isolation. The output power needs to be 48VDC +25%/-15%. The maximum input current is 8A.

Connect the power cable to the plinth as show below:

- **Phase** linked to the **Brown** cable
- **Neutral** linked to the **Blue**
- **Ground** to the **Green and Yellow**. See illustration below.



Figure 3-19: -48VDC Power Connections

Recommended cable areas for 48VDC

Distance	Cable Area
0 - 10 meters between repeater and power supply	2,5 mm ²
10 – 50 meters between repeater and power supply	4 mm ²
Over 50 meters between repeater and power supply	Recommendation is to reconfigure the installation, or to make special arrangements to increase cable area

3.7.3 Power ON

3.7.3.1 Switching Power ON

Caution!!

Make sure the antenna cables or 50Ω terminations are connected to the repeater's antenna connectors before the repeater is turned on.

1. Switch on the **Main Power Switch**.
2. Switch on the **Battery** power.

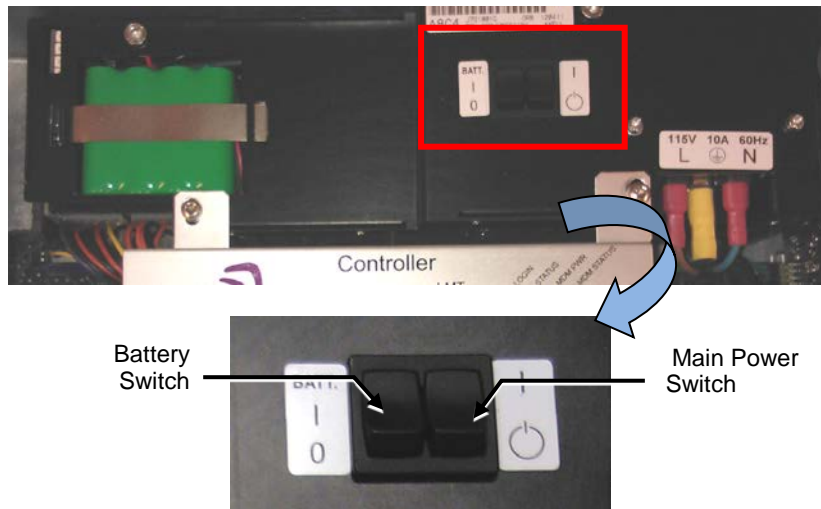

Figure 3-20: BSF-3604 Power Module

Note: The power switches have two positions: “on” and “stand by”. In the stand by position the repeater is still connected to the power supply but not operational.

3.7.3.2 Verifying LEDs

Verify the LEDs from the following modules are indicating correct operation (see section 6.4):

- Control module
- F/O converter
- Power supply modules

3.8 Closing and Securing the Repeater

Close lid, **tighten the screws** and lock repeater. Continue with the following section to setup the repeater.

Note: The two screws must be fully tightened. Failure to do so may affect the IP65 compliancy and therefore any warranty.

4 BSF-4004 Commissioning

After the repeater is connected, it is identified by the OMU II via the fibre connection and the unit is commissioned from the OMU II. The commissioning process consists of a few simple steps.

To commission the BSF-4004 - overview:

1. Open an **OMU II session** – used to access the BSF-4004 configuration window (via OMU II).
2. Perform **Optical Loss Adjustment**.
3. Set the required **RF attenuation and gain levels**
4. Assign the unit a **recognizable name** (according to its location).

4.1 Open a Session to the BSF-4004 via the OMU II

1. Open a local or remote session to the host OMU II:
 - Remote session – open a Browser session in the same subnet as the host OMU II and enter the IP of the host OMU II (see OMU user manual for detailed procedure). Enter the OMU II User Name (e.g. **axell**) and Password (provided by your system administrator).
 - Local session– connect to the OMU II Control Module's USB or Ethernet ports. Enter the OMU II User Name (e.g. **axell**) and Password (provided by your system administrator).
 - After accessing an OMU II session, commission the BSF-3604 according to the following section.



Figure 4-1: Connection to OMU II

4.2 BSF-4004 Optical Loss Adjustment (OLA)

BSF-4004 OLA is performed from the OMU II.

To perform BSF-4004 OLA (via OMU II)

- From the OMU II main window, click the **Opto Adjust** button.

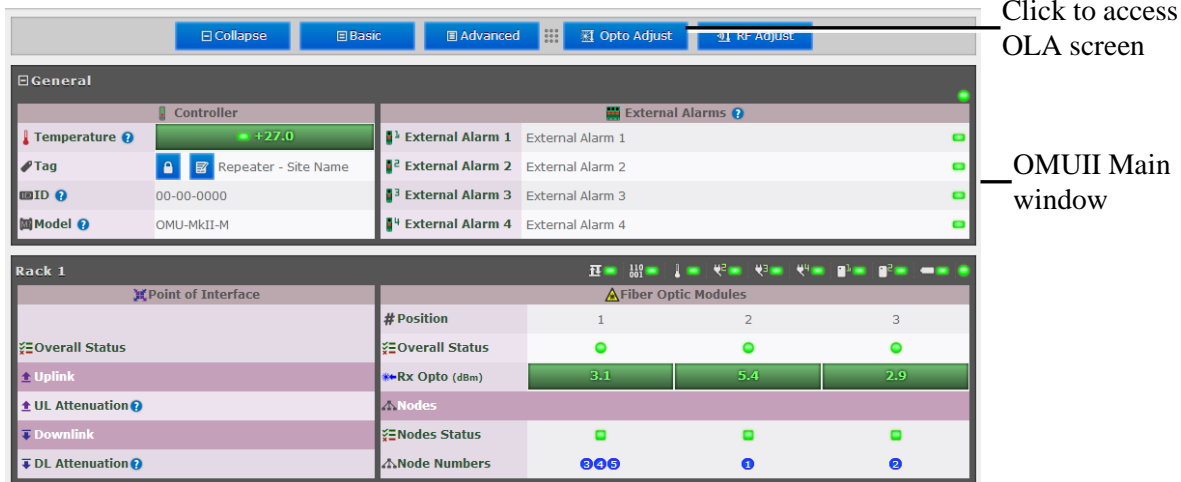

Figure 4-2: OMU II Main window

The OLA screen appears. The screen lists the OLA options (and status) for each link. (The links are listed according to the OMU II slot to which the remote is connected.).

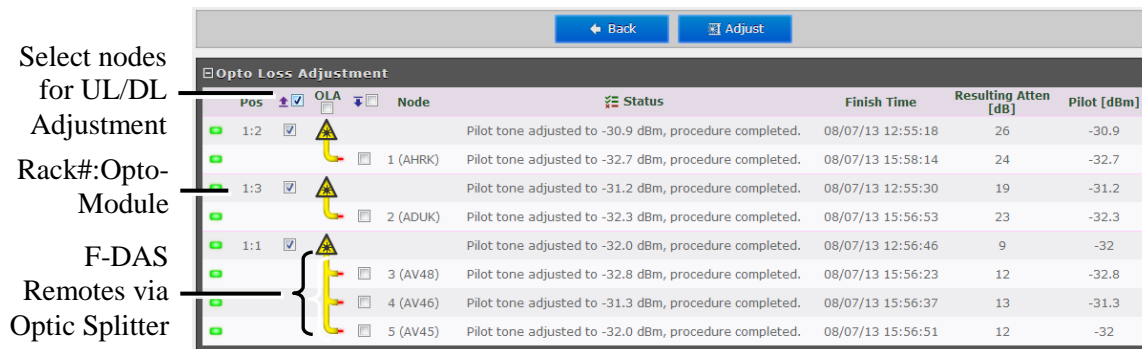



Figure 4-3. Configure and Initiate Optical Loss Adjustment

Column	Description
Pos	Each Rack corresponds to an OMU unit whereas each Slot corresponds to an Opto-Module. Slots are numbered according to their position in the OMU Chassis (numbered left to right).
Select All	Batch selection options:  - mark all remotes for UL opto-adjustment.  - mark all remotes for DL opto-adjustment. OLA - mark all remotes for DL and UL adjustment.
Node	Node list number and identification (e.g. AHFK)
Status	Displays an Error if process failed. If successful the pilot tone used and the adjustment level will be displayed.
Resulting Attenuation	Compensation level used for the opto-module (in dB).

9. Mark the check-boxes corresponding to the remotes (each connected to the designated Opto-module/Opto-Splitter) to which to perform the adjustment.
10. OLA (DL/UL) may be performed on each node individually (or a batch) or on **all** nodes at once by marking the checkbox next to the desired corresponding Opto-module and clicking **Adjust**.
To easily mark all checkboxes mark the checkbox named **OLA**.

NOTE: The process may take several minutes depending on the size of the system and remote distance.

4.3 RF Balancing

The BSF-4004 RF Balancing procedure can be performed manually (the automatic option specified in section 4.3.2 will be available in the future) via the OMU II web interface.

4.3.1 Manual RF Balancing

NOTE: If connected locally, enter the BSF-4004 Home screen and skip to step 2.

The manual balancing procedure consists of the following steps:

- Verifying the DL RF output level is maximized by setting the required DL attenuation of the signal.
- Setting the UL attenuation according to the DL.
- In case of noise, adjusting the UL attenuation to reduce noise

To balance the BSF-4004 UL and DL outputs

1. Access the BSF-4004 Configuration window:
 - Click on the **Nodes** button. The below pane appears
 - Click **Control** next to the node to be balanced.

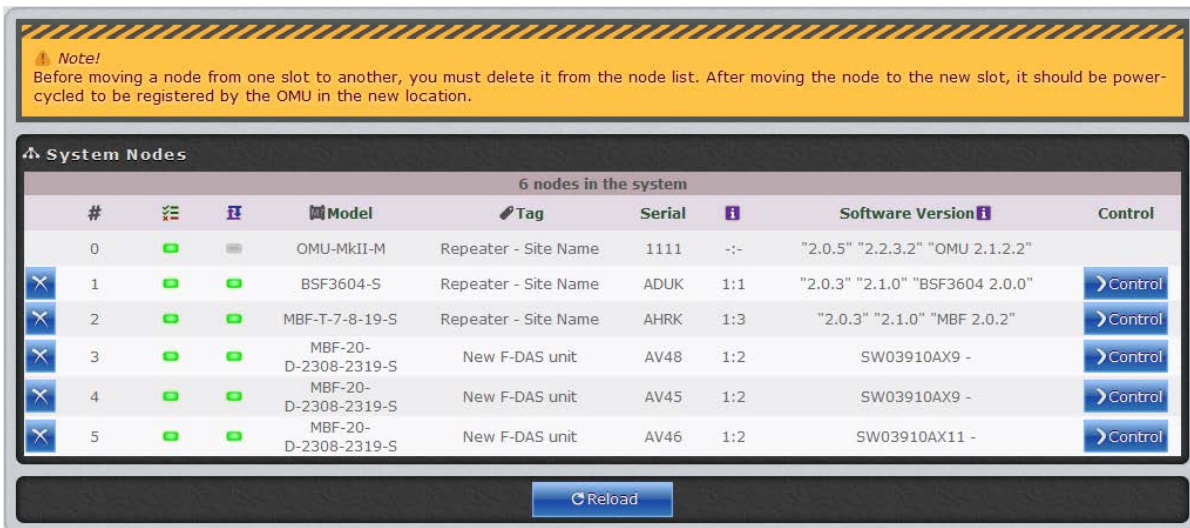

Figure 4-4: OMU II System Nodes window

2. The resulting pane can be displayed in two views:
 - Basic – default view (**Basic** button)
 - Advanced – provides more information (**Advanced** button)

The dialog below shows an example of the Basic (default) view.

Note: The various elements monitoring options are described in detail in section 6.

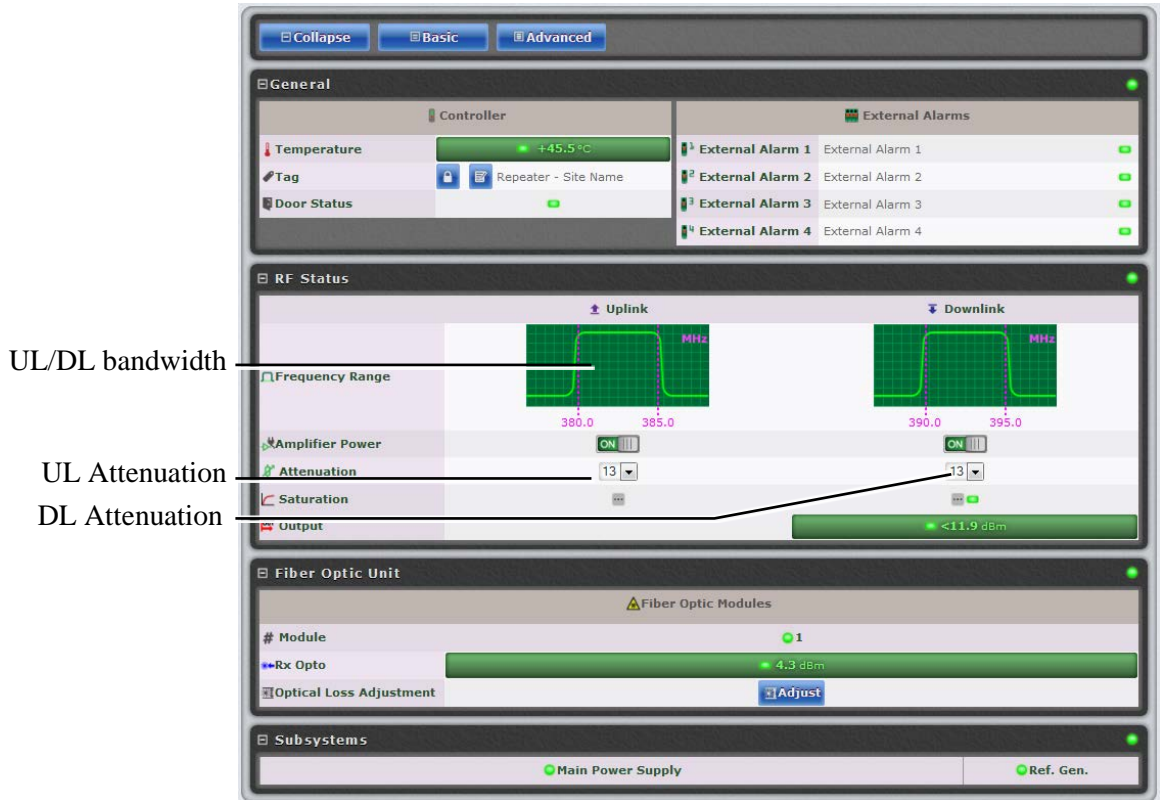

Figure 4-5: Example of Partial view of BSF-3604 Configuration window

3. In the Downlink section:

- Verify the **Amplifier** is set to ON.
- Set **Attenuation** to maximum value (15dB).
- Lower the **Attenuation** level step by step until the desired Output power level is reached (Zero attenuation = maximum gain).
- Verify the Amplifier Saturation is GREEN.

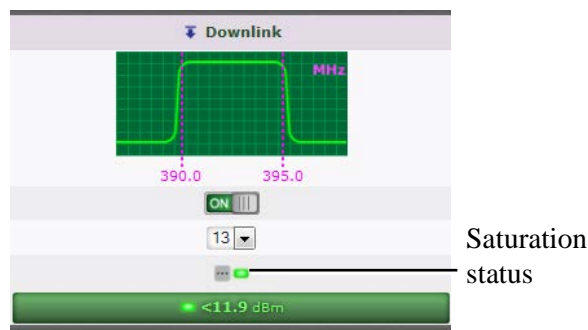

Figure 4-6: BSF-4004 Downlink Configuration Section

4. In the Uplink:

- Verify the **Amplifier** is set to ON.
- Set **UL Attenuation** == **DL Attenuation** value.

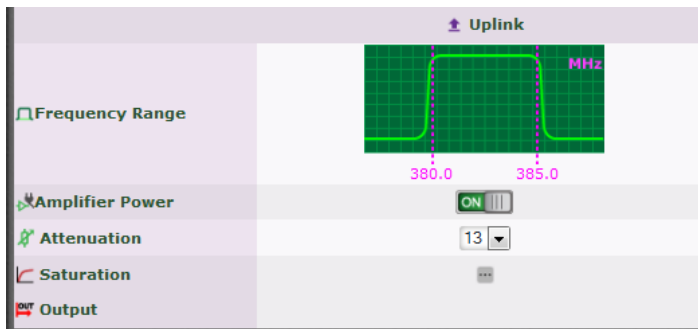

Figure 4-7: BSF-4004 Uplink Configuration Section

5. If noise is detected, adjust only the uplink value.

4.3.2 Automatic BSF-4004 RF Balancing

NOTE: This feature will be available in future release.

To access the Automatic RF Adjustment pane

1. Access the OMU II **Home** window and click on **RF Adjustment**.

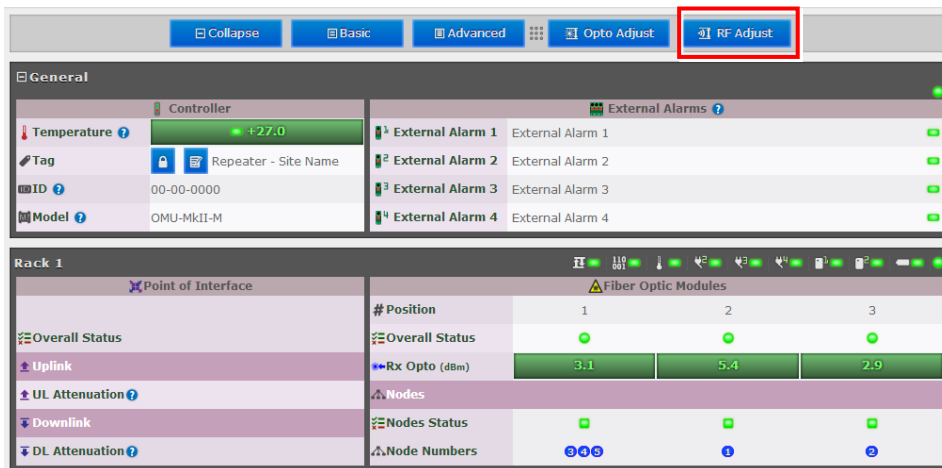

Figure 4-8: OMU II Main window

2. The following pane appears.

Remote with selected bands to adjust

Select All
 Select None

Note:
The automatic RF Adjustment procedure will adjust the output in the downlink path for each chain to the nominal level and then set uplink gain according to the Delta configuration. For this to work, there must be a downlink signal enabled in the downlink from the base station allowing to reach the desired output power level. Before performing RF Adjustments it is strongly recommended to adjust corresponding opto links in the opto adjustment page.

Node #3, AV48, MBF-20-D-2308-2319-S, New F-DAS unit, 1:1							
<input type="checkbox"/>	Freq [MHz]	Nominal Level [dBm]	Uplink Delta [dB]	Status	Finish Time	Resulting Atten [dB]	Output Level [dBm]
<input type="checkbox"/>	850	0	5	MBF-20 RF Adjustments failed. Cannot read OPL, Verify you have input power.	08/07/13 14:43:40	3	-
<input checked="" type="checkbox"/>	1900	0	5	MBF-20 RF Adjustments failed. Cannot read OPL, Verify you have input power.	08/07/13 14:43:29	3	-

Node #4, AV46, MBF-20-D-2308-2319-S, New F-DAS unit, 1:1							
<input type="checkbox"/>	Freq [MHz]	Nominal Level [dBm]	Uplink Delta [dB]	Status	Finish Time	Resulting Atten [dB]	Output Level [dBm]
<input checked="" type="checkbox"/>	850	0	5	MBF-20 RF Adjustments failed. Cannot read OPL, Verify you have input power.	08/07/13 14:43:23	3	-
<input type="checkbox"/>	1900	0	5	MBF-20 RF Adjustments failed. Cannot read OPL, Verify you have input power.	08/07/13 14:43:17	3	-

3. Select the bands of each remote to be adjusted (e.g. 1900MHz band on Node #3)
4. Adjust the following for each band:
 - Nominal Level (dBm)
 - Uplink Delta (dB)
5. Click **Adjust**. The procedure may take several minutes depending on the number of units selected.

4.4 Integration into the AEM

NOTE: All integration into the AEM is performed from the AEM side – no action is required from the BSF-4004 side.

The AEM automatically connects to the repeater, downloads all the repeater parameters and statuses into a database. When all parameters have been downloaded, the AEM configures the repeater with the IP address where alarms and reports should be sent to, and optionally with a secondary IP address where the repeater can connect to in case connection to primary IP fails.

When heartbeat reports and alarms are sent from the repeater to the AEM also the latest information about the status and RF-configuration is included. This means that the AEM operator always has information about the current status in the AEM database (and do not need to call the repeater to find this out).

NOTE: Once the repeater is integrated to the AEM, all changes to the repeater should preferably be done from the Axell Element Manager in order to ensure that the database always contains correct information.

4.5 What Next?

The BSF-4004 unit is now ready for operation. You may monitor the unit's general status via the OMU II Home screen and if the node is faulty (red LED), access the Home screen in Advanced mode for more detailed information.

Note: Consult the OMU II User Manual for additional information on RF and Optical adjustments.

5 BSF-4004 Full GUI Description

This chapter provides a detailed description of the complete BSF-4004 Web GUI that is accessed when a *direct* session is opened to the BSF-4004.

When an *indirect session* (via OMU II) is opened to the BSF-4004, only the BSF-4004 Main window is available. The additional options are available when a *direct* session is opened to the BSF-4004 (*not* via OMU II).

This chapter describes how to open local and remote *direct* sessions to the Remote and the available options when such a session is opened.

5.1 Opening a Direct Web Session

You may open a direct Web session to the BSF-4004 by connecting to the unit either:

- A. Locally
- B. Remotely via an Ethernet/modem connection – requires to unit to be connected to the network.

5.1.1 Connecting Locally

NOTE: This connection requires downloading the USB driver from the provided setup disk (or connection to the internet, where the driver is automatically loaded).

To open a local session:

1. Open the BSF-4004 cover
 - Connect to the USB/Ethernet port on the Controller module. If the USB driver is not already installed on your laptop, the system will search for the driver on the provided setup disk or on the internet (if a network connection is available).
 - Run a browser and login according to the following section.



Figure 5-1: BSF-4004 Controller Module Connection

1. Open the web browser and type "axell-ne" in the address bar.



The Axell login dialog appears.



Figure 5-2: Login Screen

2. Use the following username and password to login:

- Username: **axell**
- Password: **AxellPasswd**

For backwards compatibility, you may also use:

- User Name: **Avitec**
- Password: **AvitecPasswd**

Note: It is highly recommended to change the default password according to section 5.6.3.

The Web GUI Main Window appears. This is the same window is also viewed via the OMU II.

5.1.2 Remote Connection and Login

This type of Web session requires connecting the Repeater to the network and defining an IP address. See section 5.3.4.

To login:

- Open a standard Browser.
- Enter the IP address of the Repeater in the address bar.
- Enter the User Name and Password as described in the following section.

5.2 Navigating the Web Interface

The Web GUI window provides access to the management options of the BSF-4004. Several tabs (and sub-tabs) are available: Home, Nodes, Logs, etc., while the Home tab (illustrated below), is displayed on login.

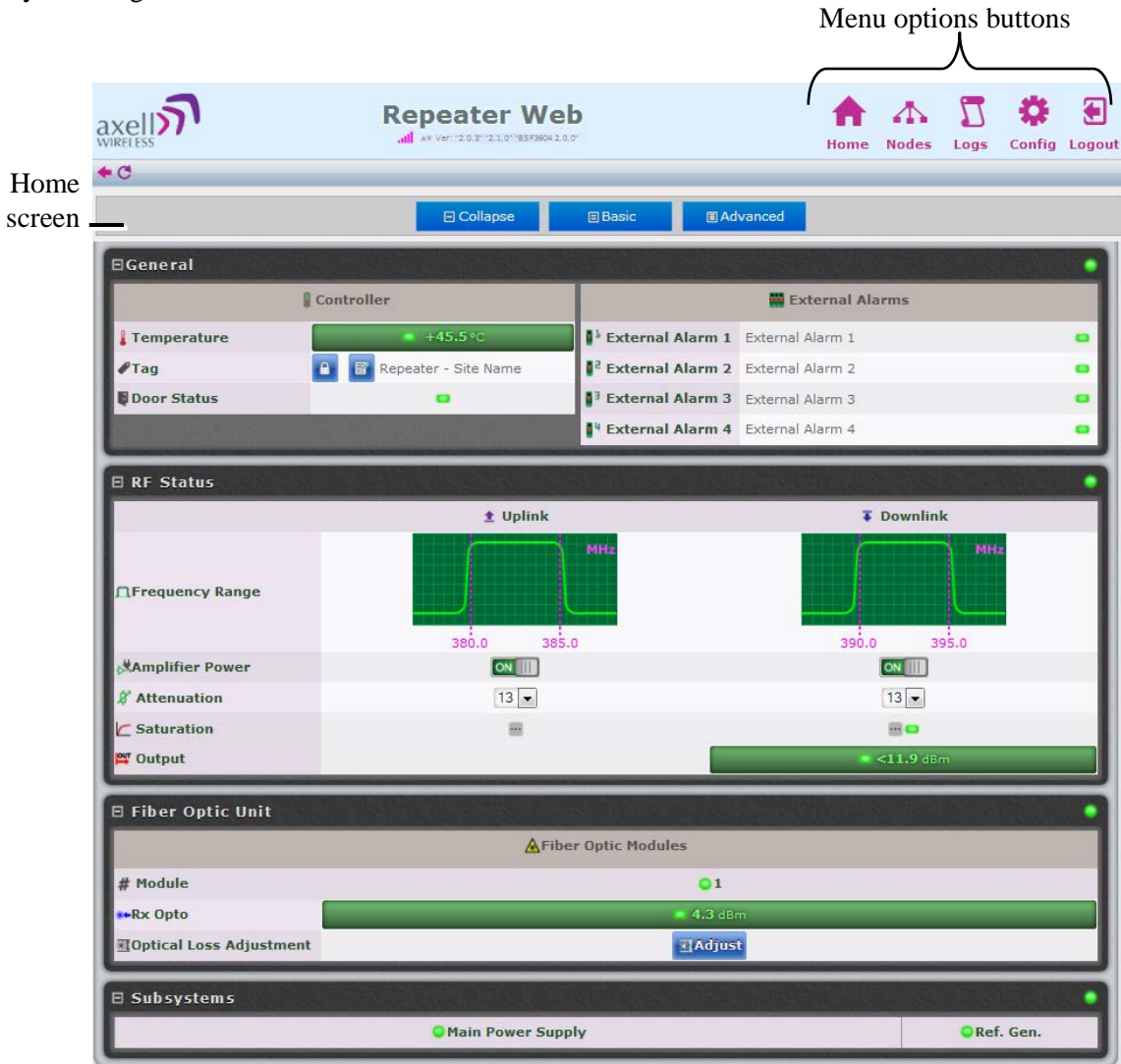
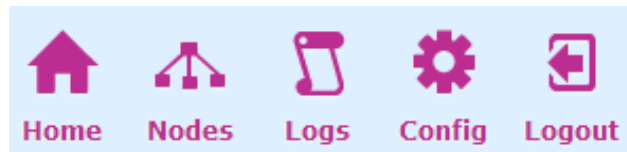







Figure 5-3: BSF-4004 Home Screen

5.2.1 Management Options Buttons

The following table briefly describes the main functions of each tab:



Tab	Description
 Home	Provides a general status and alarm information. Switching to <i>Advanced View</i> will toggle a more detailed view of each band and module. Section 6.2.
 Nodes	Lists the remote nodes – corresponding OMU and units connected the specific OMU.
 Logs	List of recent operations. Section 6.3.
 Config	Provides a range of BSF-4004 configuration procedures such as communication, RF, Date and Time, Password, etc. Section 5.3.
 Logout	Logout of the system.

5.2.2 Home Screen Overview

The screen is divided into four basic areas:

- Controller – shows general information on the BSF-4004 device such as identification and temperature level.
- External Alarms – shows status of external alarms and the defined names.
- RF Status – RF connection status is divided into two sections:
 - Frequency Range – shows frequency range used per DL/UL.
 - Uplink/Downlink – gain, attenuation and connection status in the specific direction.
- Fibre Optic Unit – shows status on connection to remote OMU and allows for optical link adjustment.
- Sub-systems – overall status of all sub-systems such as power supplies, battery, communication etc.

The screenshot displays the 'Repeater Web' interface. At the top, there is a navigation bar with 'Home', 'Nodes', 'Logs', 'Config', and 'Logout' buttons. Below this is a 'Collapse', 'Basic', and 'Advanced' view selector. The main content area is divided into several sections:

- General:** Contains 'Controller' information (Temperature: +45.5°C, Tag: Repeater - Site Name, Door Status) and 'External Alarms' (External Alarm 1-4).
- RF Status:** Shows 'Uplink' and 'Downlink' frequency range graphs (380.0-385.0 MHz and 390.0-395.0 MHz respectively). It also includes controls for 'Amplifier Power' (ON), 'Attenuation' (13), 'Saturation', and 'Output' (<11.9 dBm).
- Fiber Optic Unit:** Shows 'Fiber Optic Modules' (1) and 'Rx Opto' (4.3 dBm) with an 'Adjust' button for 'Optical Loss Adjustment'.
- Subsystems:** Shows 'Main Power Supply' and 'Ref. Gen.' status.

Annotations on the left side of the image identify these sections:

- General
- External Alarms
- UL and DL output control options
- Fiber Optic options
- Power monitoring options

5.2.3 Configuration Screen Overview

The configuration screen provides access to the BSF-3604 configuration options.

To access the configuration screen

Click on the **Config** menu option in the Main window. The following screen appears.

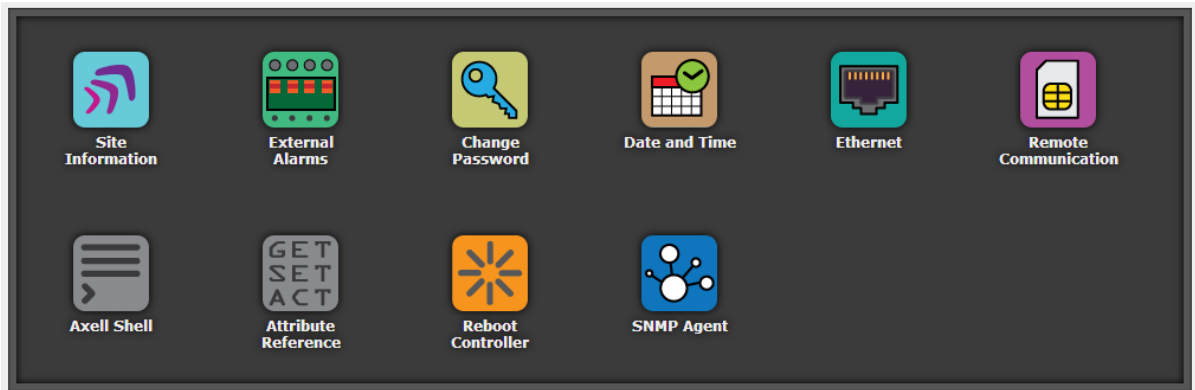

Option	Description
Site Information	Display BSF-4004 identification information. See section 5.3.1
External Alarms	Used to activate and assign names to external alarms. See section 5.3.3
Change password	Used to update system login password for the logged-in user. See section 5.6.3
Date and Time	Used to configure the time stamp for dating BSF-4004 events. See section 5.3.2.
Ethernet	Used to define the IP Address for remote access via Ethernet. See section 5.3.4
Remote Communication	Used to configure remote communication parameters and AEM integration. See section 5.4
Axell Shell	Command line used to communicate with the remote units. List of commands is found under Help. See section 5.8
Attribute Reference	Lists all possible Axell Shell commands, detailed and explained. You may also refer to the <i>Common Commands and Attributes</i> document. See section 5.9
Reboot controller	Soft restarts the BSF-4004 device. See section 5.7.

5.3 Configuring General Parameters

5.3.1 Site Information – BSF-4004 Identification



It is recommended to assign each BSF-4004 a recognizable name that will identify the location, site name, etc. The Site Information button provides access to BSF-4004 hardware and software version information.

To set BSF-4004 TAG

1. In the **Home** window, click the edit button next to Tag.

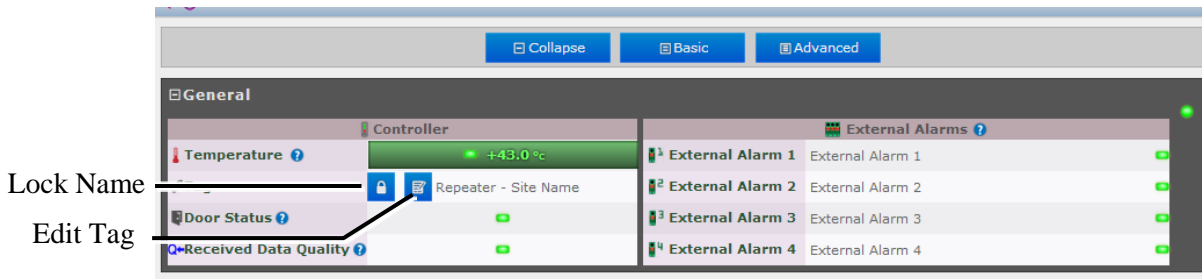

Figure 5-4. Set BSF-4004 TAG Name

2. Enter the Name (up to 30 characters), click OK and click **Apply**.

To view BSF-4004 Site Information

Click the **Config** button and click on the **Site Information** icon. Two areas are displayed:

- Control Module – provides hardware and software version information.
- Site Information – provides BSF-4004 identification information.

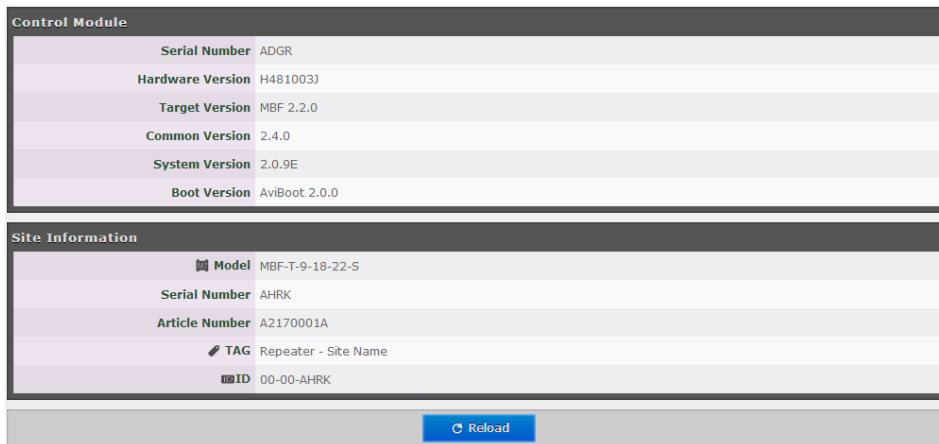

Figure 5-5. BSF-4004 Site Information

5.3.2 Date & Time

NOTE: The date and time are automatically set from the OMU II.



Be sure to set the correct date and time in order to accurately timestamp all events occurring on the BSF-4004.

To set the Date & Time:

1. Click the **Config** button.
2. Click on **Date & Time**.
3. Do one of the following:
 - Either, enter the correct date and time according to the displayed formats.
 - Or, click on **Local Time** to set the time according to the PC running the Web-GUI.
4. Click **Apply**.



Figure 5-6: Configure Date and Time

5.3.3 Configure External Alarms



It is required to configure any connected external alarms according to the trigger (high or low) and it is recommended to assign the alarms recognizable names (such as Door Open, High Temperature, etc.)

To configure the external alarms

1. In the Main menu, click the **Config** button.
2. Click on the **External Alarms** icon.
3. For each alarm:
 - Set the Trigger as High or Low as required.
 - Assign the alarm a recognizable description
4. Click **Apply**.

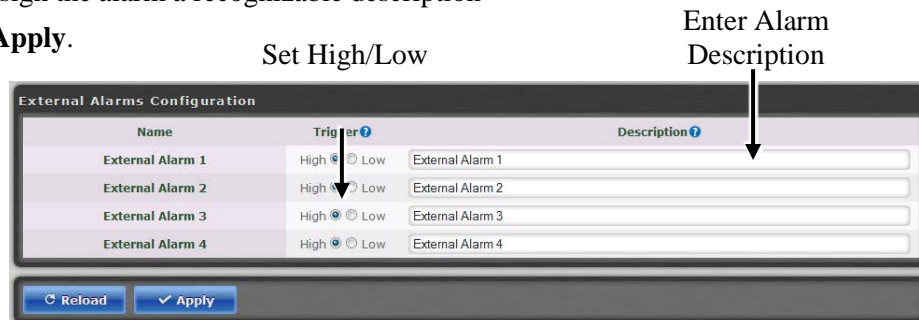

Figure 5-7: Configure External Alarms

5.3.4 IP Address



This procedure describes how to set up the IP address either manually or configure for acquisition via DHCP (usually configured for local management options).

To configure the IP address

1. In the Main menu, click the **Config** button.
2. Click on **Ethernet**.
3. For manual IP address configuration:
 - Select Manually Configure IP Address.
 - Set the IP, Subnet Mask, Default Gateway and DNS addresses.
 - Click **Apply**.
4. For DHCP IP address configuration:
 - Select Automatically Obtain IP Address (DHCP).
 - No other settings are required.
 - Click **Apply**.

The Manual configuration settings are illustrated below.

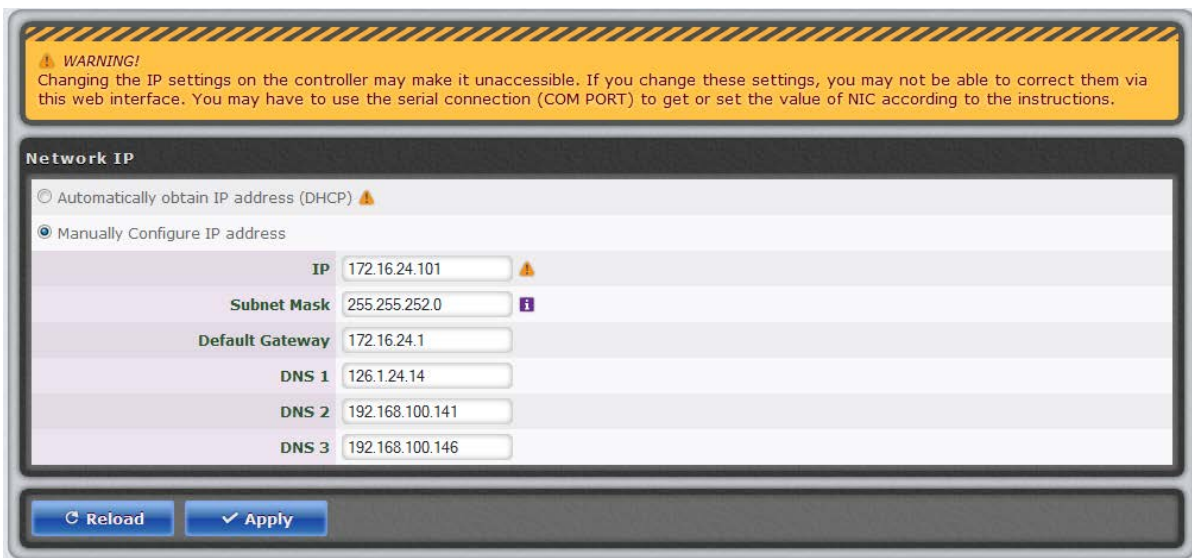
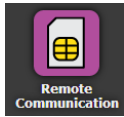

Figure 5-8: Configure Local Network Parameters

5.4 Remote Communication Setup



This section describes the Ethernet and modem setup. The SNMP setup option also available in this dialog is described in section 5.5. SNMP .

Select an option (ETH TCP, Modem or SNMP) and configure. Then select the next relevant option.

NOTE: The configuration of each option is saved and active. It is not relevant which option is currently selected (ETH TCP, Modem or SNMP).

5.4.1 TCP/IP and Ethernet

1. Click on the **Config** button.
2. From **Device:Method** select **ETH:TCP** (Ethernet:TCP/IP).
3. Click **Apply**.



Figure 5-9: Remote ETH Configuration

5.4.2 Modem Setup

NOTE: This section is relevant only if a modem is installed in the system. If connecting directly via Ethernet, see section 5.4.1.

The BSF-4004 can operate over two types of modem: Packet Switched (GPRS, GSM etc.) or Circuit Switched (PSTN/GSM). The available options depend on the modem type installed in your system.

Modem Setup Overview

1. Insert the SIM card in the modem SIM slot (if using a wireless modem).
2. Click the **Config** button and then select **Remote Communication** from the displayed icons. The following dialog appears.

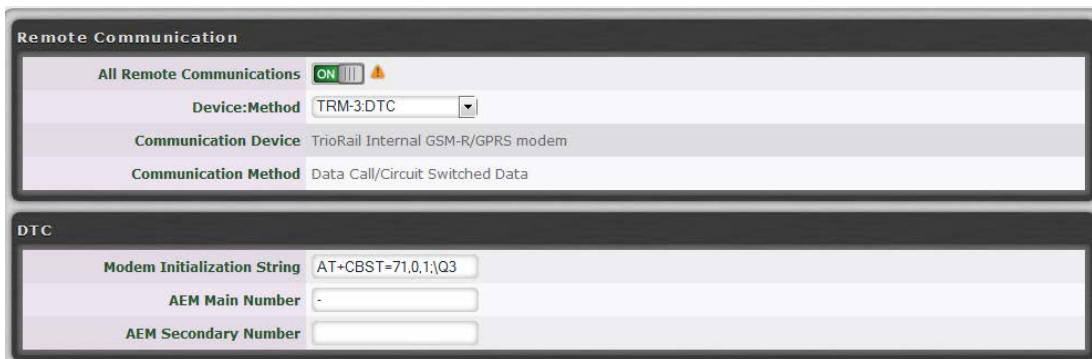

3. Verify that **Remote Communication** is **ON**.
4. Select the **Device:Method** – communication method. Select the option relevant to your installed modem. (STD:DTC = Standard AT:Data Call, ETH:TCP = Ethernet:TCP connection)
5. Configure your communication method according to the relevant following section.

5.4.2.1 Packet Switched Modem Configuration (GSM/GPRS)

NOTE: In case network attach is not done properly (using GPRS), it is necessary to telnet, SSH or serial into the controller and enter TRACE MODEM to see why modem is not initialized (wrong / missing PIN, wrong APN etc).

- From the Remote communication menu, select **TRM-3 GPRS**.
- In the GRPS area, enter the following:
 - Access Point Name – customer’s Access Point name.
 - Click **Apply**.

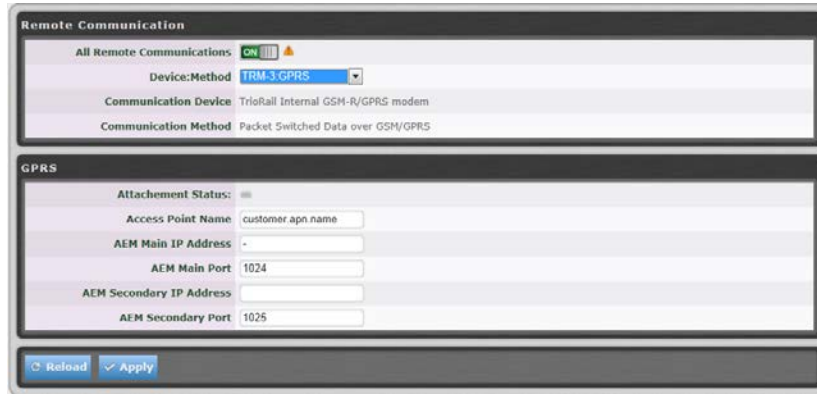

5.4.2.2 Circuit Switched Modem (PSTN/GSM)

Using a circuit switched modem requires a landline connection be present at the site (for PSTN) or a SIM card supporting this feature (for wireless).

Communication Setup

1. From **Device:Method** select **STD:DTC** (Standard AT:DataCall).
2. In the modem initialization string type: **AT+CBST=7,0,1**.
3. Click **Apply**.

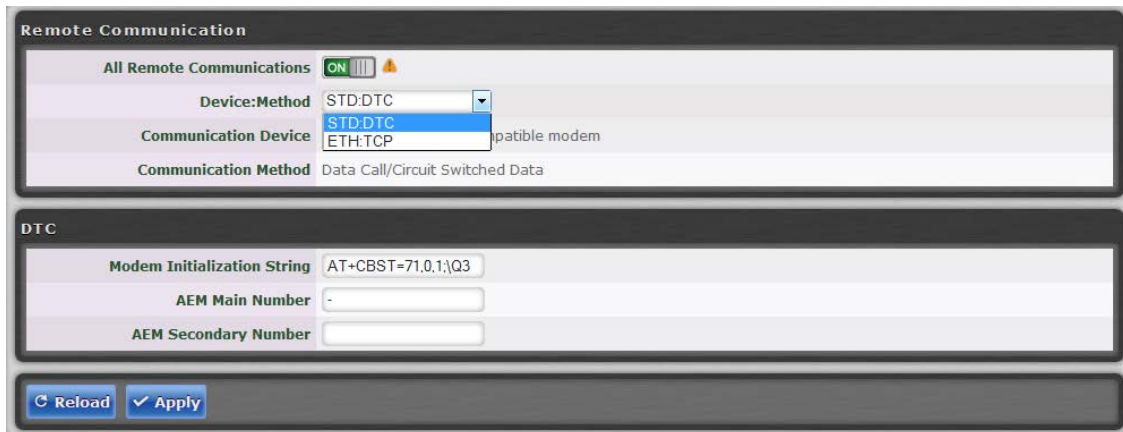

Verify Circuit Switched Modem Functionality

1. Use the ACT RCD command via the Axell Shell or via Terminal to launch a modem restart (if logged in, restart will be performed on the first logout).
2. Dial the modem number (if PSTN) or the data number (if SIM card).
3. Verify modem LEDs are lit correctly (model dependent).
4. Use any ACT command using the RMC or other Terminal to test connectivity and responsiveness.

5.4.2.3 SIM-card Using Single Numbering Scheme

If using SNS (Single Numbering Scheme), calls to the modem **within** the network are automatically classified as DATA. However, if calling from **outside** the network, you must first verify how its interfaces handle the VOICE vs. DATA bearing. This cannot be solved at remote level. The external network administrator must provide the above information.

5.5 SNMP Support

The BSF-4004 includes SNMP support, including an SNMP Agent and SNMP traps (alarms). All SNMP queries and traps are supported either via the OMU II or a direct connection to the unit.

5.5.1.1 SNMP Traps Parameters

The BSF-4004 sends SNMP traps to user defined destination addresses.

NOTE: One destination address can currently be defined via the Web. Seven more destination addresses can be defined via the Axell Shell.

To configure the SNMP traps destination address

1. Click on the **Configure** button (top right corner).
2. Select **Remote Communication**.
3. In the **Device:Method** field, select **ETH:SNMP**

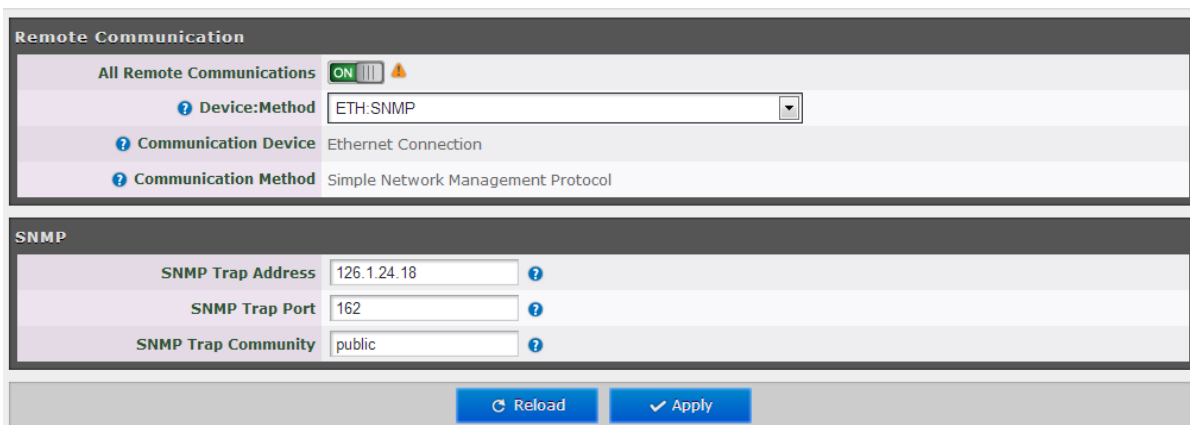

4. Define the SNMP trap destination IP address (additional addresses can be defined via the Axell Shell).
5. Enter the (destination address device) Trap Port and its Community parameters.
6. Click **Apply**.

5.5.1.2 Activating and Configuring the SNMP Agent

The SNMP agent provides inventory management for hosted repeaters (on which the SNMP agent is enabled) and a table of active alarms in the controller or fibre system for remote querying.

The SNMP Agent is responsible for responding to queries and carries out requests. The SNMP Agent also provides the proprietary Axell MIB (AXELL-AM-MIB), accessible via any SNMP manager (e.g. HP OpenView).

All SNMP queries to the remote are implemented via an OMU session.

To allow SNMP agent queries

- To allow SNMP queries of the OMU II – the SNMP agent must be enabled on the OMU II.
- To allow SNMP queries of the remote devices via OMU II – the SNMP agent must be enabled on the OMU II *and* on the remote devices.
- Remote units configured with an IP address and connected to the communication infrastructure, can be queried directly.

To activate the BSF-4004 SNMP Agent

1. Click on the **Config** button (top right corner) and select **SNMP Agent Config**. The following pane appears:

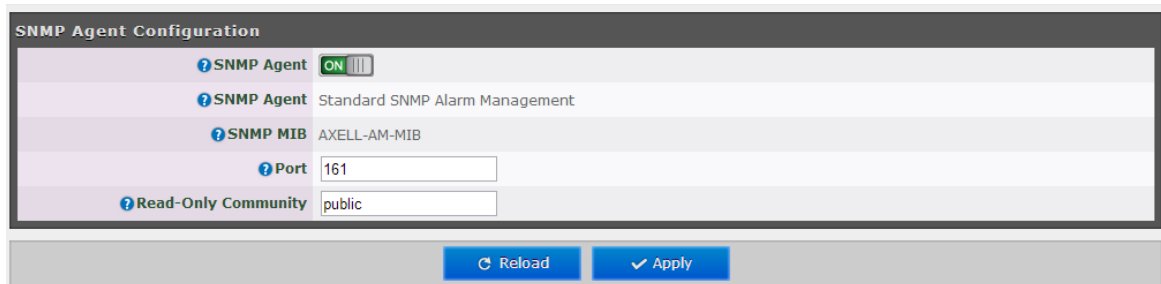

SNMP Agent Configuration	
SNMP Agent	ON
SNMP Agent	Standard SNMP Alarm Management
SNMP MIB	AXELL-AM-MIB
Port	161
Read-Only Community	public

2. Set the **SNMP Agent** toggle to **ON**.
3. Set the **port** and the **Read-Only community**.
4. Click **Apply**.

5.6 User Accounts

The BSF-4004 comes pre-configured with default usernames and passwords in the various administration levels.

At the moment, updating user accounts is available only via Command Line Interface (CLI) or Axell Shell. See the Common Commands and Attributes v2.0.0 document for detailed commands and syntax or click on the **Help** button at the top right of the Web-GUI screen.

5.6.1 Default User Accounts

User Name	Default Password	Details
Axell	AxellPasswd	Default user name.
omcunname	iwnkhoob	Axell Element Manager (AEM) user account. This account will not generate VLI, LGO or CLR alarms.
sysadmin	AxellAdmin4050	This is the system administration password which is used for firmware upgrades and user administration. Escalation to this level is achieved by issuing command SYSADMIN from the user prompt.
useradmin	UseradminPwd23	This account contains user administration privileges. Escalation to this level is achieved by issuing command USERADMIN from the user prompt.
Avitec	AvitecPasswd	Account available for compatibility reasons with older system firmware.

*Note: It is strongly recommended to change the default user names and passwords immediately at commissioning. This is done by using the command **ACT PASSWORD**. Please refer to the User Administration section in Common Commands and Attributes document for detailed syntax.*

5.6.2 User Access Levels

In this generation of the system, standard users can be promoted to login via the Web Interface, inheriting the Read-Write or Read-Only access to this interface.

There are five different access levels:

Access Level	Default User Levels
Read-Only	axell, avitec, omcunname, useradmin, sysadmin
Read-Write	axell, avitec, omcunname, useradmin, sysadmin
Web	axell, avitec
User Administrator	omcunname, useradmin, sysadmin
System Administrator	omcunname, sysadmin

Note: New users added to the system have read-only access.

Users may be promoted to read-write and/or web access using the **ACT USERPROMOTE** command. See **Common Commands and Attributes** document for details on promoting users.

Note: Users omcunname, sysadmin and useradmin cannot be promoted to Web Access due to security reasons.

5.6.3 Change Password

To prevent unauthorized access, it is highly recommended to change the default password of the user.

NOTE: Note that you can only change the password for the User Name with which the session was accessed.

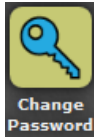

To change the Password

1. In the Main menu, click the **Config** button.
2. Click the **Change Password** button.
3. For the current User Name (e.g. **axell**):
 - Enter the New password.
 - Repeat the entry.
4. Click **Apply**.



5.7 Reboot

Caution! Use this function in *Emergency Cases ONLY!*

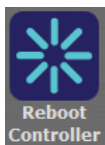

To reboot the Control Module:

1. Click the **Config** tab.
2. Click on the **Reboot** icon.
3. Approve the Reboot sequence.

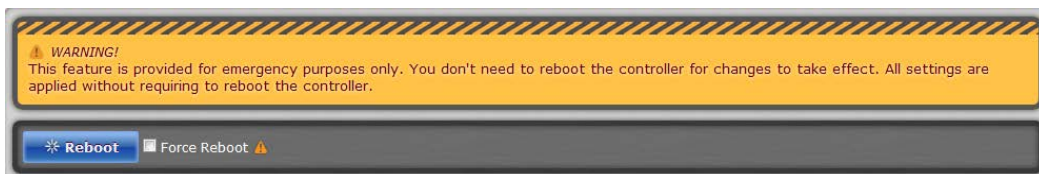

Figure 5-10: Reboot System

5.8 Axell Shell (Command Line Interface)



To access the Axell Shell:

1. Click on the **Config** button.
2. Select the **Axell Shell** option.

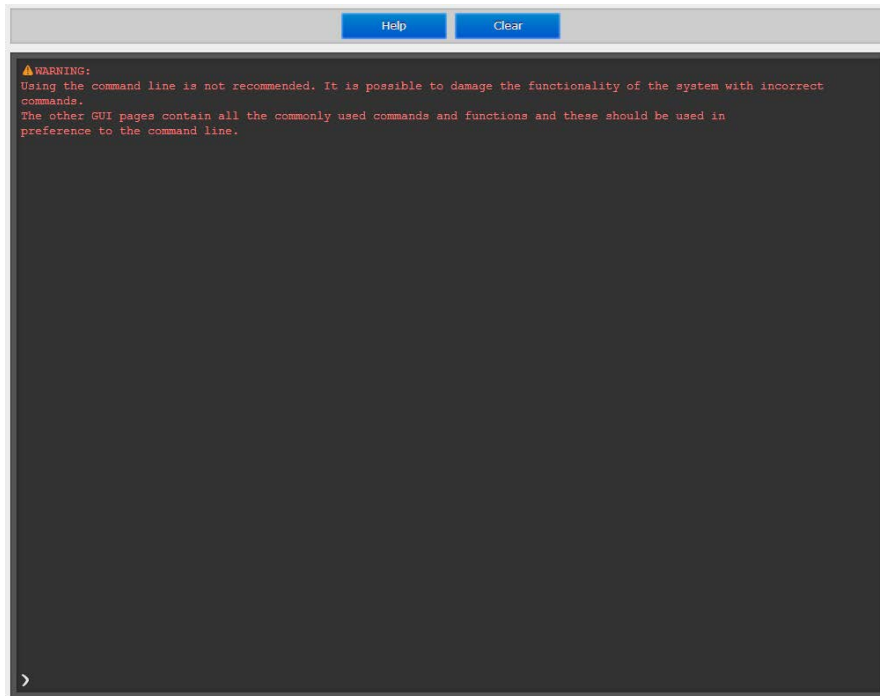

The **Axell Shell** button invokes the CLI screen. It is used to run some of the commands that are currently not provided by the Web GUI (user privileges and administration) and/or for advanced troubleshooting and configurations procedures.

All configuration and management procedures can be implemented using this interface. Please refer to the *Attribute Reference* section (by clicking the **Config** button on the top right and selecting **Attribute Reference** – see 5.9) for detailed syntax and available commands. You may also consider viewing the *BSF-4004 Commands and Attributes* document.

6 Monitoring, Fault Sourcing and Maintenance

BSF-4004 provides the following monitoring and fault sourcing options:

- Web GUI Home screen Advanced mode – shows general status of system and components
- Web GUI Logs screen – provides logs of faults and operations
- Module LEDs – can be seen locally when opening the Repeater

This chapter describes these fault sourcing tools. *Be sure to review the Cautions and General Statements below.*

6.1 Cautions and General Statements

- The system normally operates without any operator intervention or maintenance. If in the unlikely event of any unit failure, the faulty repeater should be replaced. A failed unit can be removed and replaced with a spare while the rest of the system (other repeaters) is still operating. However, the power supply of the failed repeater should be isolated from the power before anything is replaced.
- In the event of a malfunction in the system, the status of the antenna systems as well as the continuity of the cabling should be checked before replacing any modules within the repeater.
- In the event of a failure Axell Wireless' support service should be contacted for advice on a possible module replacement or other action to be taken.
- If a shipment of a repeater back to Axell Wireless is made within the period of guarantee the original packing must be used.
- Component Replacement - None of the modules in the repeater can be replaced without removing the repeater from its mounting and opening the cover of the repeater.
- Product Disposal - Disposal of this product must be handled according to all national laws and regulations. For detailed information regarding materials, please refer to Axell Wireless.
- **CAUTION!!** Please be aware that the equipment may, during certain conditions become very warm and can cause minor injuries if handled without any protection, such as gloves.
- **CAUTION!!** Risk of explosion if battery is replaced by an incorrect type. Dispose of used batteries according to local laws and instructions.

6.2 Monitoring Via the BSF-4004 Home Screen

In addition to RF settings and readings, the BSF-4004 Home screen provides detailed information on the operation status of internal modules. This information can be used to aid in remotely troubleshooting the Repeater.

To access the BSF-3604 Main Monitoring and Configuration window

1. Access the OMU II main windows, click the **Nodes** button, choose the remote related node and click the adjacent **Control** button. The BSF-4004 Home window appears in Basic View. To view more details, click **Advanced**.



The screenshot displays the 'Advanced' view of the BSF-4004 Home screen, organized into several sections:

- General (same as Basic view):** Contains 'Controller' information (Temperature: +45.5°C, Tag: Repeater - Site Name, Door Status: ON) and 'External Alarms' (External Alarm 1-4, all ON).
- Detailed RF Status view:** Shows 'Uplink' and 'Downlink' frequency range graphs (380.0-385.0 MHz and 390.0-395.0 MHz). Below are 'Amplifier Power' (ON), 'Attenuation' (13), 'Amplifier', 'Synthesizer', and 'Saturation' status. 'Input' and 'Output' power levels are shown as -110.0 dBm and <15.0 dBm / <11.9 dBm respectively.
- Detailed fiber optic status:** Displays 'Fiber Optic Modules' with parameters: # Module (1), Comm (ON), Firmware (ON), Temperature (+51.1°C), Tx Opto (ON), Rx Opto (+4.3 dBm), Pilot Tone Synth (ON), Received Pilot Level (-30.7 dBm), Optical Loss Adjustment (Adjust button), and Optical Compensation (25 dB).
- Power measurements status:** Shows 'Subsystems' including 'Main Power Supply' and 'Ref. Gen.' with various status indicators.

Figure 6-1: BSF-4004 Main Screen Advanced

PRODUCT DESCRIPTION AND USER'S MANUAL

6.2.1.1 General Page Area

This section displays general status parameters such as temperature, alarms and site name.

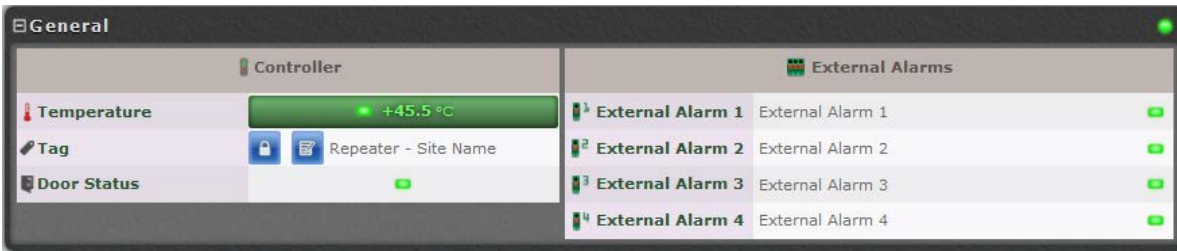

Figure 6-2: BSF-4004 General

Indicator	Description
Temperature	Current ambient temperature
Tag	Name of Repeater, user customizable
Door Status	Green if closed

6.2.1.2 Detailed view of the BSF-4004 RF Status

The BSF-3604 RF Status screen provides the RF balancing options as described in section **Error! Reference source not found.**, as well as various status monitoring options. Below is the **Advanced** view of the RF Status screen.



Comm. Firmware Temp. Pwr. modules status

Figure 6-3: BSF-4004 Repeater Status

Indicator	Details
Frequency Range	Visualization of Bandwidth
Amplifier Power	Turn amp. on/off.
Attenuation	Use to define DL/UL attenuation level (in dBm)
Saturation	Saturation status
Output	output power level

6.2.1.3 Detailed view of Fibre Optic Unit



Figure 6-4: BSF-4004 F/O Status

Indicator	Description
#Module	Overall optic module status
Comm	Optic connection status
Temperature	Temperature level and status indicator
Tx Opto	DL optic signal status
Rx Opto	UL optic signal strength and status
Pilot Tone Synth	Pilot tone synthesizer status
Firmware	Firmware related error
Received Pilot Level	Pilot tone level received in optic module
Optical Level Adjustment	Perform UL OLA (on repeater side)
Optical Compensation	Compensation performed on the optic link

6.2.1.4 Subsystems

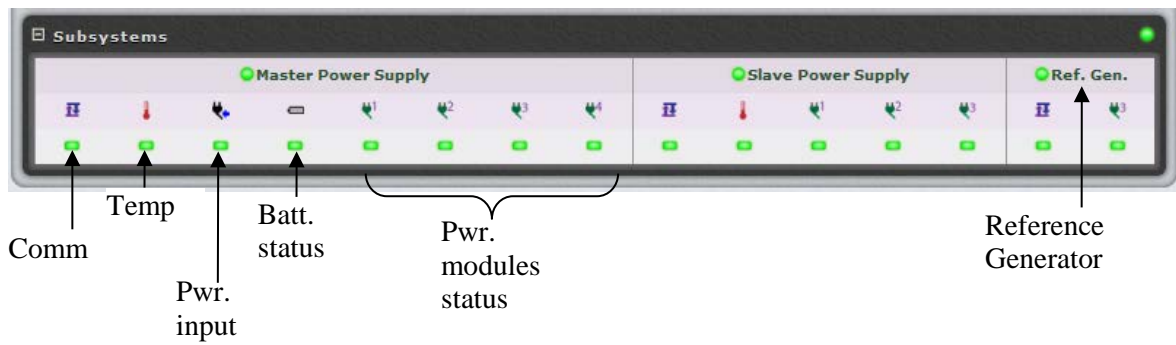

6.3 Logs Screen

The Alarms Log displays the last 100 alarms and/or user actions on the remote system in a chronological order. By hovering with the mouse over each alarm, full alarm details are available, including alarm descriptions, severities, alarm classes and time of event.



Figure 6-5: Logs

To receive a summary containing all information on a reported incident in the Log list, simply hover with the mouse over the specified Log and view all details contained in the Log (see below).

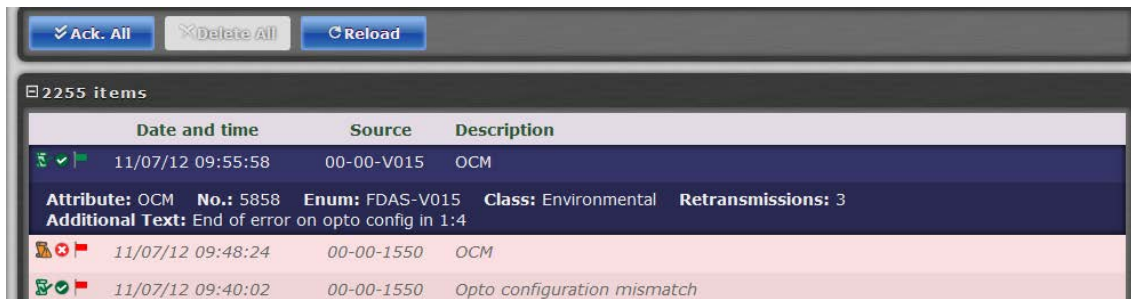







Figure 6-6: Logs – Summary

Column	Description
Date & Time	Time of occurrence
Source	ID of reporting source
Description	Additional alarm information (e.g. Open Door)

Icon	Description
	Alarm attended to and cleared.
	System alarm – displayed when system functionality may be compromised.
	Alarm status: OK
	Alarm status: Error
	Acknowledge alarm – Green = Acknowledged.
	Click to change acknowledgement. Use the Ack All button to acknowledge all alarm logs.

6.4 Module LEDs

This section describes the LEDs of the internal modules. The modules are accessed if the remote is opened. An example of the BSF-3604 Dual-band, dual-service antenna model is given below:

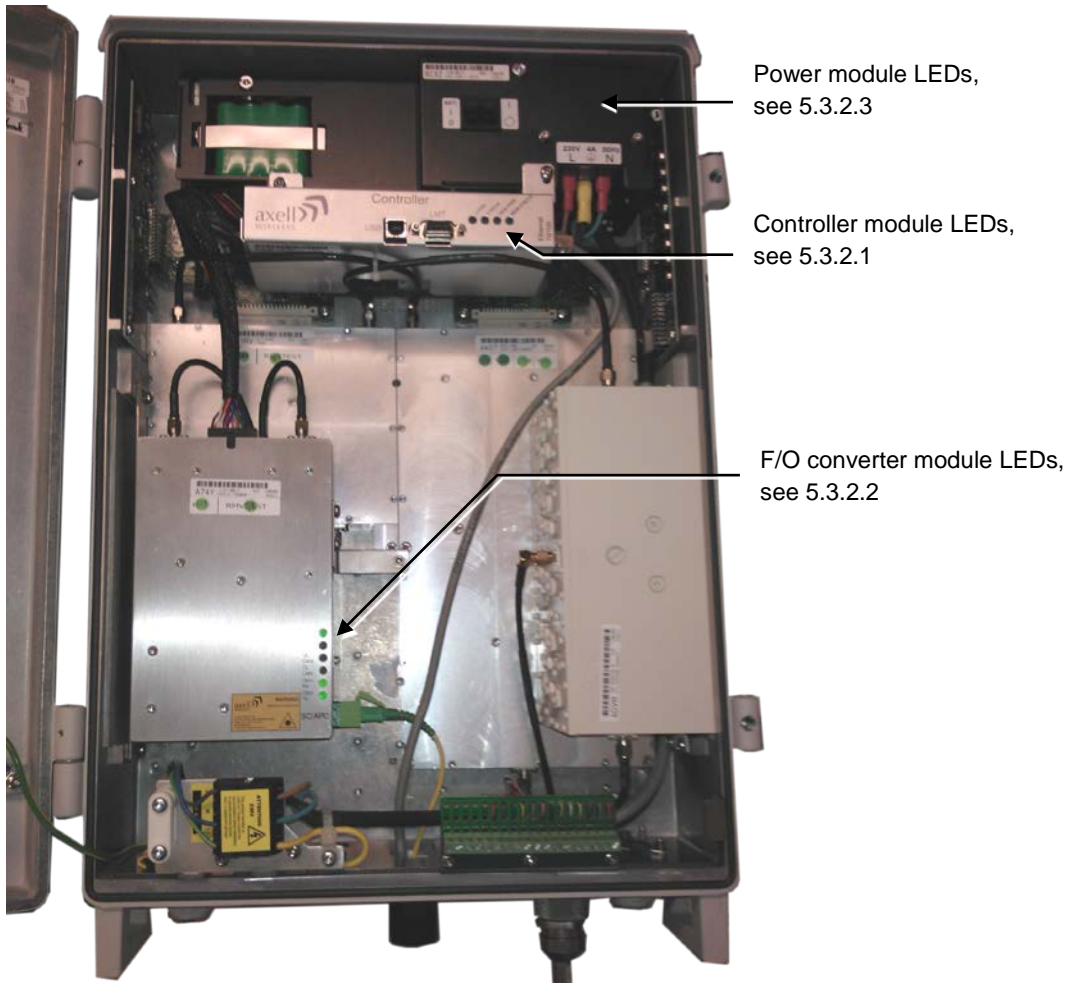
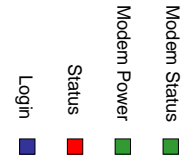











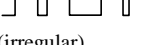

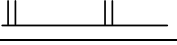

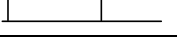

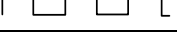

Figure 6-7: Dual band Dual Service Antenna Model

6.4.1 Control Module LEDs

The Control Module has four LEDs which give information regarding the status of the BSF-4004.

If the BSF-4004 is configured for Ethernet communication the two LEDs Modem Power and Modem Status do not fill any function and can be disregarded.



Blue LED - Login		
	Quick flash	Control Module switched on, someone logged in locally and/or remotely
	Off (except for a quick flash every 10th second)	Control Module switched on, no one logged in
	Off (permanent)	Control Module switched OFF
Red LED - Status		
	Quick flash	Control Module switched on, one or more errors/alarms detected
	Off (except for a quick flash every 10th second)	Control Module switched on, status OK
	Off (permanent)	Control Module switched off
Green LED - Modem Power		
	On	Modem Power is on
	Off	Modem Power is off
Green LED - Modem Status		
	On	Depending on type of call: Voice call: Connected to remote party Data call: Connected to remote party or exchange of parameters while setting up or disconnecting a call
	Flashing  (irregular)	Indicates GPRS data transfer. When a GPRS transfer is in progress the LED goes on within 1 second after data packets were exchanged. Flash duration in approximately 0.5s.
	75ms on/75ms off/75ms on/3s off 	One or more GPRS contexts activated
	75ms on/3s off 	Logged to network (monitoring control channels and user interactions). No call in progress
	600ms on/600ms off 	No SIM card inserted, or no PIN entered, or network search in progress, or ongoing user authentications, or network login in progress
	Off	Modem is off

6.4.2 F/O Converter LEDs

There are 6 LEDs on the module to indicate the status.



LED 1, Power, Green	
On	Unit is powered on
Off	Unit has no power
LED 2, Error, Red	
On	Error detected
Off	No error
LED 3, UL Data, Yellow	
On	Communication is ongoing in the uplink direction
Off	No communication
LED 4, DL Data, Yellow	
On	Communication is ongoing in the downlink direction
Off	No communication
LED 5, Opto Rx, Green	
On	Received RF signal on fibre channel is above threshold
Off	Input level below threshold
LED 6, Opto Tx, Green	
On	Transmitted RF signal on fibre channel is above threshold
Off	Output level below threshold

6.4.3 Power Supply LEDs

This section provides a detailed description of the LEDs and fault examples.

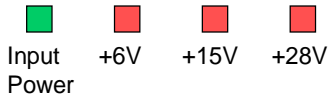

LED 1, Input Power, Green	
Slow flash	Power supply unit operating on AC or DC
OFF	Power supply unit not operating
LED 2, +6V, Red	
Slow flash (every 10 seconds)	+6V power supply operating
Quick flash	+6V power supply not operating or operating with malfunction
LED 3, +15V, Red	
Slow flash (every 10 seconds)	+15V power supply operating
Quick flash	+15V power supply not operating or operating with malfunction
LED 4, +28V, Red	
Slow flash (every 10 seconds)	+28V power supply operating
Quick flash	+28V power supply not operating or operating with malfunction

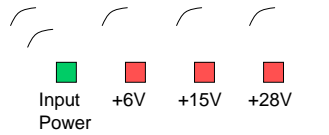
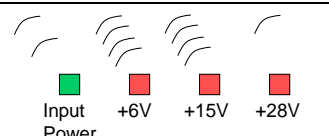
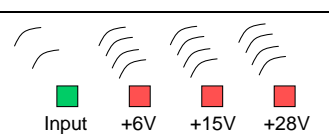
Examples	
 <p>Input Power +6V +15V +28V</p>	<p>LED 1 is flashing slowly, LED 2 – 4 are flashing slowly (once every 10 seconds) => power supply unit is operating without problem</p>
 <p>Input Power +6V +15V +28V</p>	<p>LED 1 is flashing slowly, one or two of the red LEDs are flashing quickly => Input power is operating but there is a problem with some of the other voltages</p>
 <p>Input Power +6V +15V +28V</p>	<p>LED 1 is flashing slowly, all of the red LEDs are flashing quickly => Input power is out and unit is operating on backup battery</p>







Appendix A - Specifications

Frequency Range	Uplink		Downlink
	428-430		423-425
Operational Bandwidth	2MHz		
Duplex distance	5MHz		
Impedance	50Ω		
IP3	> +68dBm		
Output power/carrier (DL)	1 carrier: +36dBm, 2 carriers: +33dBm, 3-4 carriers: +30dBm, 8 carriers: +27dBm		
Group delay	2μs max		
Noise Figure (UL)	< 6dB, 5dB Typical at maximum gain		
Fibre Optic Loss Compensation	Implemented		
Spurious Emissions from RF port	< -13dBm		
Optical Module Electrical Specifications			
Optical Wavelength	Two Colour System	Three Colour System	Four Colour System
Master	1310±10nm	1310±10nm	1310±10nm
Slave 1	1550±3nm	1550±3nm	1550±3nm
Slave 2	N/A	1510±3nm	1510±3nm
Slave 3	N/A	N/A	1570±3nm
Maximum optical output power	+3dBm ±2dB		
Maximum optical input power	+2dBm		
Power requirements	230VAC 50Hz, 115VAC 60Hz, -48VDC		
Power Consumption	<100W, typical		
External Connection			
Local Maintenance Terminal	RS232		
Server Port	N Type female		
Optical Ports	1xSC/APC female		
Modem Antenna Connector	SMA		
Remote Connection	Via OMU or (optional) GSM, GSM-R PSTN modem or Ethernet		
Mechanical			
Dimensions	540 x 382 x 198mm		
Weight	28kg		
Enclosure	Aluminium (IP 65)		
Cooling	Convection		
Environmental			
Operating Temperature	-25 to +55°C		
Storage	-30 to +70°C		
MTBF	>100,000 hrs		

Appendix B - F/O Cleaning Procedure

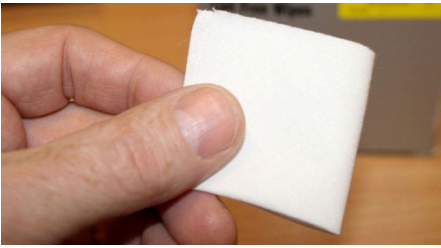
NOTE: The process is demonstrated on an OMU F/O module and is similar to all F/O equipment supplied by Axell.

Tools:

Tool Description	Illustration
<p>Fibrescope connected to a PC running the appropriate viewing software.</p> <p>It is highly recommended that some form of fibre viewing equipment such as a Fibrescope is used to ensure that all fibre connections are clean before termination; failure to do so could result in poor system performance</p>	
<p>Lint-free swabs (box), Axell P/N 99-000127</p>	
<p>Lint-free wipes (pack) Axell P/N 99-000125</p>	
<p>Fujikura "One Click" cleaner, Axell P/N 98-900004.</p>	
<p>99% isopropyl alcohol (can), Axell P/N 99-000126</p>	
<p>Cletop type S Cassette Cleaner, Axell P/N 98-900001</p>	

The Cleaning Procedure:

Dry Cleaning

<p>ATTENTION!</p> 	<p>Invisible laser radiation might be emitted from disconnected fibres or connectors. Do not stare into beams or view directly with optical instruments.</p>
--	--

1. Before cleaning the optical connectors on the OMU it is advisable to clean the connector of the mating cable being attached to the optical port.

An unclean optical connector is often the cause for reduced system performance. A bit of dust or oil from a finger can easily interfere with, or block light. Fortunately, it is very easy to clean the connector. Be sure to use the correct procedure for the given connector. When disconnected, cap the SC/APC connector to keep it clean and prevent scratching the tip of the ferrule.

Use a product specially designed for the purpose, such as the Cletop type S Cassette Cleaner.

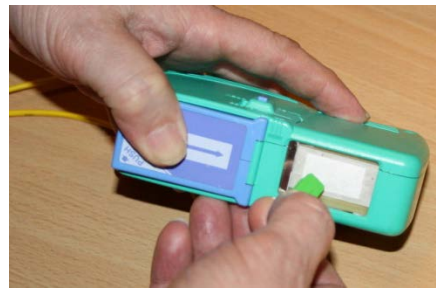

2. Begin by dry cleaning the F/O bulkhead connector (shown below is the Fujikura One-Click in use).

<p>IMPORTANT</p>	<p>Always make sure there is a way of inspecting the connector after cleaning. Cleaning can actually leave the end-face in a worse condition, since alcohol residue is one of the most difficult contaminants to remove.</p>
-------------------------	--

3. Remove the protective cap from the cleaning-head end of the “One Click” cleaner, lift the protective end-cap on the fibre connector and offer-up the end to the fibre connector.



4. With the cleaning-head end fully engaged in the connector, push until an audible “click” is heard
5. Without fully withdrawing the cleaning head end push it in again twice more, each time until an audible “click” is heard.
6. Withdraw the “One Click” cleaner and replace the protective end cap.



7. Inspect the fibre connector using a Fibrescope. On the PC monitor, verify that there is no contamination present on the connector end-face.
8. If the connector is dirty, clean it with a wet cleaning technique followed immediately by dry cleaning. This is to remove any remaining residue from the wet clean (the following steps demonstrate a wet cleaning technique).

Wet Cleaning

 ATTENTION!	<p>Invisible laser radiation might be emitted from disconnected fibers or connectors. Do not stare into beams or view directly with optical instruments.</p>
--	--

1. Lightly moisten a new lint-free wipe with 99% isopropyl alcohol. (Step 1 below).

Tip: Have a dry lint-free swab available for immediately drying after performing the wet-cleaning.

2. Lightly press and turn a clean lint-free swab in the moistened area of the wipe to moisten the swab. It is important that the swab is not too wet. (Step 2 below).
3. Insert the moistened lint-free swab into the bulkhead adapter. Lightly press and rotate several times in the same direction. (Step 3 below).

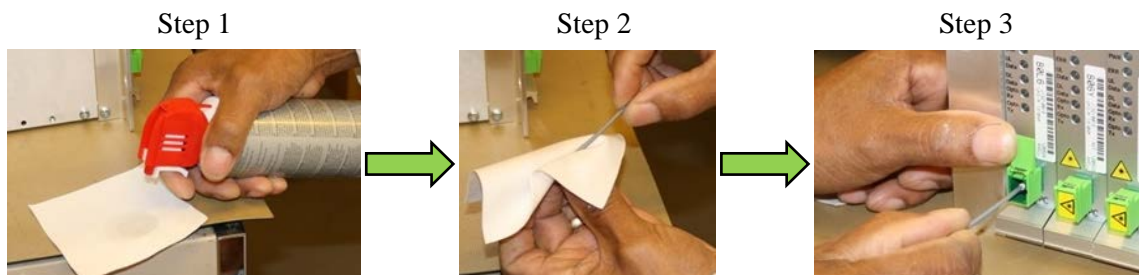

Wet-Cleaning Technique

4. Immediately use a dry lint-free swab to clear any remaining alcohol residue.

*NOTE: Do **not** re-use any of the wipes and/or swabs. Dispose of them properly.*

5. Follow steps 3 to 6 of Dry Cleaning above
6. Re-inspect the fibre using the Fibrescope. On the PC monitor, verify that there is no contamination present on the connector end-face.
7. If the fibre is still dirty, go back to step 1 (Wet Cleaning) and repeat the entire process.

NOTE: The entire wet/dry cleaning cycle should only be used twice, if the fibre is still dirty after two cycles of wet/dry cleaning seek advice from the Axell Wireless Support Desk.
