

Pasadena Blue Line

Metro Radio System

Maintenance Handbook
For

Canam Technology Inc.
AFL Works Order Nō.: Q107519
Including AFL product part Nō's.:

60-056100 UHF Units 1 & 2 (This document)

| | | | |
|---|---|-------------|--------------------------|
|  Aerial Facilities Limited www.AerialFacilities.com Technical Literature | P B L Tunnel Units 1 & 2 Maintenance Handbook | | |
| | H/book Number:- 60-056100HBKMFCC | Issue No:-2 | Date:- 04/01/2006 |

Table of Contents

| | |
|---|-----------|
| AMENDMENT LIST RECORD SHEET | 5 |
| INTRODUCTION | 6 |
| Scope..... | 6 |
| Purpose..... | 6 |
| Glossary of Terms | 7 |
| AFL Drawing Symbol Keys..... | 8 |
| 1. SAFETY CONSIDERATIONS | 9 |
| 1.1 Electric Shock Hazard | 9 |
| 1.2 RF Radiation Hazard..... | 9 |
| 1.3 Chemical Hazard..... | 10 |
| 1.4 Emergency Contact Numbers | 10 |
| 2. OVERVIEW/SYSTEM DESCRIPTION..... | 11 |
| 3. SPECIFICATIONS | 12 |
| 3.1 Parts Lists | 12 |
| 3.1.1 Equipment 60-056100 Parts List | 12 |
| 3.1.2 Unit 1 Fibre Fed Tunnel Amplifier 60-056101 Parts List | 12 |
| 3.1.3 Unit 2 Fibre Fed Tunnel Amplifier 60-056102 Parts List | 13 |
| 3.2 Technical Specifications..... | 15 |
| 3.2.1 UHF ONE to Tunnels 1 & 2 Technical Specification | 15 |
| 3.2.2 UHF TWO to Tunnels 1 & 2 Technical Specification | 16 |
| 3.3 Mechanical Specifications..... | 17 |
| 3.3.1 Unit 1 60-056101 Mechanical Specification | 17 |
| 3.3.2 Unit 2 60-056102 Mechanical Specification | 17 |
| 4. SYSTEM DRAWINGS..... | 18 |
| 4.1 Drg. Nō. 60-056190, Location 2 Unit 1 Case Outline Drawing | 18 |
| 4.2 Drg. Nō. 60-056192, Location 2 Unit 2 Case Outline Drawing | 19 |
| 4.3 Complete Pasadena Metro System Diagram | 20 |
| 5. SUB-UNIT MODULES | 21 |
| 5.1 Location 2, Unit 1 (60-056101)..... | 21 |
| 5.1.1 Bandpass Filters (02-007302)..... | 21 |
| 5.1.1.1 Description | 21 |
| 5.1.1.2 Technical Specification (02-007302)..... | 21 |
| 5.1.2 AFL Fibre Optic Receiver & Transmitter (20-004001, Tx & 20-004101, Rx)..... | 22 |
| 5.1.2.1 Description | 22 |
| 5.1.2.2 Fibre Optic Units Technical Specification | 22 |
| 5.1.2.3 'D' Connector Pinouts..... | 23 |
| 5.1.3 JWS75-15/A PSU (96-300045)..... | 24 |
| 5.1.3.1 Description | 24 |
| 5.1.3.2 Technical Specification | 24 |
| 5.2 Location 2, Unit 2 (60-056102)..... | 25 |
| 5.2.1 Bandpass Filter (02-013401)..... | 25 |
| 5.2.1.1 Description | 25 |
| 5.2.1.2 Technical Specification | 25 |
| 5.2.2 Two Section Notch Filter (02-010401)..... | 26 |
| 5.2.2.1 Description | 26 |
| 5.2.2.2 Technical Specification (Uplink) | 26 |
| 5.2.2.3 Technical Specification (Downlink) | 26 |
| 5.2.3 Crossband Couplers (07-004801 & 07-005705)..... | 27 |
| 5.2.3.1 Description | 27 |
| 5.2.3.2 Technical Specification (07-004801)..... | 27 |
| 5.2.3.3 Technical Specification | 27 |
| 5.2.4 ¼Watt 0- -30dB Switched Attenuator (10-000701) | 28 |
| 5.2.4.1 General Application | 28 |

| | | |
|------------|---|-----------|
| 5.2.4.2 | Switched Attenuators | 28 |
| 5.2.5 | Low Noise Amplifiers (11-006102, & 11-007302) | 28 |
| 5.2.5.1 | Description | 28 |
| 5.2.5.2 | Technical Specification (11-006102) | 28 |
| 5.2.5.3 | Drg. Nō. 11-006102, Low Noise Amplifier General Assembly | 29 |
| 5.2.5.4 | Drg. Nō. 11-006170, LNA RF Circuit Diagram | 30 |
| 5.2.5.5 | Drg. Nō. 11-006171, LNA DC Wiring Diagram | 31 |
| 5.2.5.6 | Drg. Nō. 11-003971, LNA DC Schematic Diagram | 32 |
| 5.2.5.7 | Technical Specification (11-007302) | 33 |
| 5.2.5.8 | Drg. Nō. 11-007302, LNA Assembly With Alarm Relay | 34 |
| 5.2.5.9 | Drg. Nō. 11-007370, LNA RF Circuit Diagram | 35 |
| 5.2.5.10 | Drg. Nō. 11-007371, LNA DC Wiring Diagram | 36 |
| 5.2.6 | 3 Stage Amplifier Alarm Boards (12-002201) | 37 |
| 5.2.6.1 | Description | 37 |
| 5.2.6.2 | Technical Specification | 38 |
| 5.2.6.3 | Drg. Nō. 12-002201, 3 Stage Alarm Board Assembly Drawing & Parts List | 39 |
| 5.2.6.4 | Drg. Nō. 12-002270, 3 Stage Alarm Board Circuit Diagram | 40 |
| 5.2.6.5 | Generic Wall Enclosure Alarm Wiring Sketch | 41 |
| 5.2.7 | 450MHz 20W Power Amplifier (12-004201) | 42 |
| 5.2.7.1 | Description | 42 |
| 5.2.7.2 | Technical Specification | 42 |
| 5.2.7.3 | Drg. Nō. 12-004201, PA General Assembly | 43 |
| 5.2.7.4 | Drg. Nō. 12-004270, PA Circuit Diagram | 44 |
| 5.2.7.5 | Drg. Nō. 12-004270C1, PA Parts List(1) | 45 |
| 5.2.7.6 | Drg. Nō. 12-004270C2, PA Parts List(2) | 46 |
| 5.2.7.7 | Drg. Nō. 12-003670, PA to Alarm Wiring Details | 47 |
| 5.2.8 | DC/DC Converter, 24V in, 12V 8A out (13-003011) | 48 |
| 5.2.8.1 | Description | 48 |
| 5.2.8.2 | Technical Specification | 48 |
| 5.2.8.3 | Photo of Regulator PCB (regulator heatsink side) | 48 |
| 5.2.9 | Wide Dynamic Range AGC (17-001105, Det. & 17-001201, Atten.) | 49 |
| 5.2.9.1 | Description | 49 |
| 5.2.9.2 | Technical Specification | 50 |
| 5.2.9.3 | Drg. Nō. 17-001105, ACG Detector Assembly | 51 |
| 5.2.9.4 | Drg. Nō. 17-001175, Wide Range AGC Detector Circuit Diagram | 52 |
| 5.2.9.5 | Drg. Nō. 17-001201, AGC Attenuator Assembly Drawing | 53 |
| 5.2.9.6 | Drg. Nō. 17-001270, AGC Attenuator Circuit Diagram | 54 |
| 5.2.10 | 24V Single Relay Board (80-008902) | 55 |
| 5.2.10.1 | Description | 55 |
| 5.2.11 | 24V Flat-Pack PSU (96-300002) | 55 |
| 5.2.11.1 | Description | 55 |
| 5.2.11.2 | Technical Specification | 55 |
| 6. | INSTALLATION | 56 |
| 6.1 | Initial Installation Record | 56 |
| 6.2 | General | 56 |
| 6.3 | Electrical Connections | 56 |
| 6.4 | Optical Connections | 56 |
| 6.5 | RF Connections | 57 |
| 6.6 | Commissioning | 57 |
| 7. | MAINTENANCE | 58 |
| 7.1 | General Procedures | 58 |
| 7.1.1 | Fault Finding | 58 |
| 7.1.2 | Downlink | 59 |
| 7.1.3 | Uplink | 59 |
| 7.1.4 | Fault repair | 59 |
| 7.1.5 | Checking service | 60 |
| 7.1.6 | Service Support | 60 |
| 7.2 | Tools & Test Equipment | 60 |
| 7.3 | Care of Modules | 61 |

| | | |
|---|--|-----------|
| 7.3.1 | General Comments | 61 |
| 7.3.2 | Module Removal (LNA's, general procedure): | 61 |
| 7.3.3 | Module Replacement (general): | 61 |
| 7.3.4 | Power Amplifiers | 61 |
| 7.3.5 | Low Power Amplifier Replacement | 62 |
| 7.3.6 | Module Transportation: | 62 |
| APPENDIX A INITIAL EQUIPMENT SET-UP CALCULATIONS | | 63 |

AMENDMENT LIST RECORD SHEET

| Issue Nō. | Date | Incorporated by | Page No.'s Amended | Reason for new issue |
|------------------|-------------|------------------------|---------------------------|-----------------------------|
| 1 | 09/04/2003 | CMH | | 1 st Issue |
| | | | | |
| | | | | |
| | | | | |
| | | | | |
| | | | | |
| | | | | |
| | | | | |
| | | | | |
| | | | | |
| | | | | |
| | | | | |
| | | | | |
| | | | | |
| | | | | |
| | | | | |
| | | | | |
| | | | | |
| | | | | |
| | | | | |
| | | | | |

Document Ref:-60-056100HBKM

INTRODUCTION

Scope

This handbook is for use solely with the equipment identified by the AFL Part Number shown on the front cover. It is not to be used with any other equipment unless specifically authorised by Aerial Facilities Limited. This is a controlled release document and, as such, becomes a part of Aerial Facilities' Total Quality Management System. Alterations and modification may therefore only be performed by Aerial Facilities Ltd.

Purpose

The purpose of this handbook is to provide the user/maintainer with sufficient information to service and repair the equipment to the level agreed. Maintenance and adjustments to any deeper level must be performed by AFL, normally at the company's repair facility in Chesham, England.

This handbook has been prepared in accordance with BS 4884, and AFL's Quality procedures, which maintain the company's registration to ISO 9001: 1994 and to the R&TTE Directive of the European Parliament. Copies of the relevant certificates and the company Quality Manual can be supplied on application to the Quality Manager. This document fulfils the relevant requirements of Article 6 of the R&TTE Directive.

Limitation of Information Notice

This manual is written for the use of technically competent operators/service persons. No liability is accepted by AFL for use or misuse of this manual, the information contained therein, or the consequences of any actions resulting from the use of the said information, including, but not limited to, descriptive, procedural, typographical, arithmetical, or listing errors.

Furthermore, AFL does not warrant the absolute accuracy of the information contained within this manual, or it's completeness, fitness for purpose, or scope.

AFL has a policy of continuous product development and enhancement, and as such, reserves the right to amend, alter, update and generally change the contents, appearance and pertinence of this document without notice.

All AFL products carry a twelve month warranty from date of shipment. The warranty is expressly on a return to base repair or exchange basis and the warranty cover does not extend to on-site repair or complete unit exchange.

| | | | |
|---|---|-------------|--------------------------|
|  Aerial Facilities Limited www.AerialFacilities.com Technical Literature | P B L Tunnel Units 1 & 2 Maintenance Handbook | | |
| | H/book Number:- 60-056100HBKMFCC | Issue No:-2 | Date:- 04/01/2006 |

Glossary of Terms

| | |
|-----------------------------------|--|
| Repeater or Cell Enhancer | A Radio Frequency (RF) amplifier which can simultaneously amplify and re-broadcast Mobile Station (MS) and Base Transceiver Station (BTS) signals. |
| Band Selective Repeater | A Cell Enhancer designed for operation on a range of channels within a specified frequency band. |
| Channel Selective Repeater | A Cell Enhancer, designed for operation on specified channel(s) within a specified frequency band. Channel frequencies may be factory set or on-site programmable. |
| BTS | Base Transceiver Station |
| C/NR | Carrier-to-Noise Ratio |
| Downlink (D.L.) | RF signals transmitted from the BTS and to the MS |
| Uplink (U.L.) | RF signals transmitted from the MS to the BTS |
| EMC | Electromagnetic Compatibility |
| GND | Ground |
| DC | Direct Current |
| AC | Alternating Current |
| ID | Identification Number |
| OIP3 | Output Third Order Intercept Point = $RF_{out} + (C/I)/2$ |
| LED | Light Emitting Diode |
| M.S. | Mobile Station |
| N/A | Not Applicable |
| N/C | No Connection |
| NF | Noise Figure |
| RF | Radio Frequency |
| Rx | Receiver |
| Tx | Transmitter |
| S/N | Serial Number |

AFL Drawing Symbol Keys

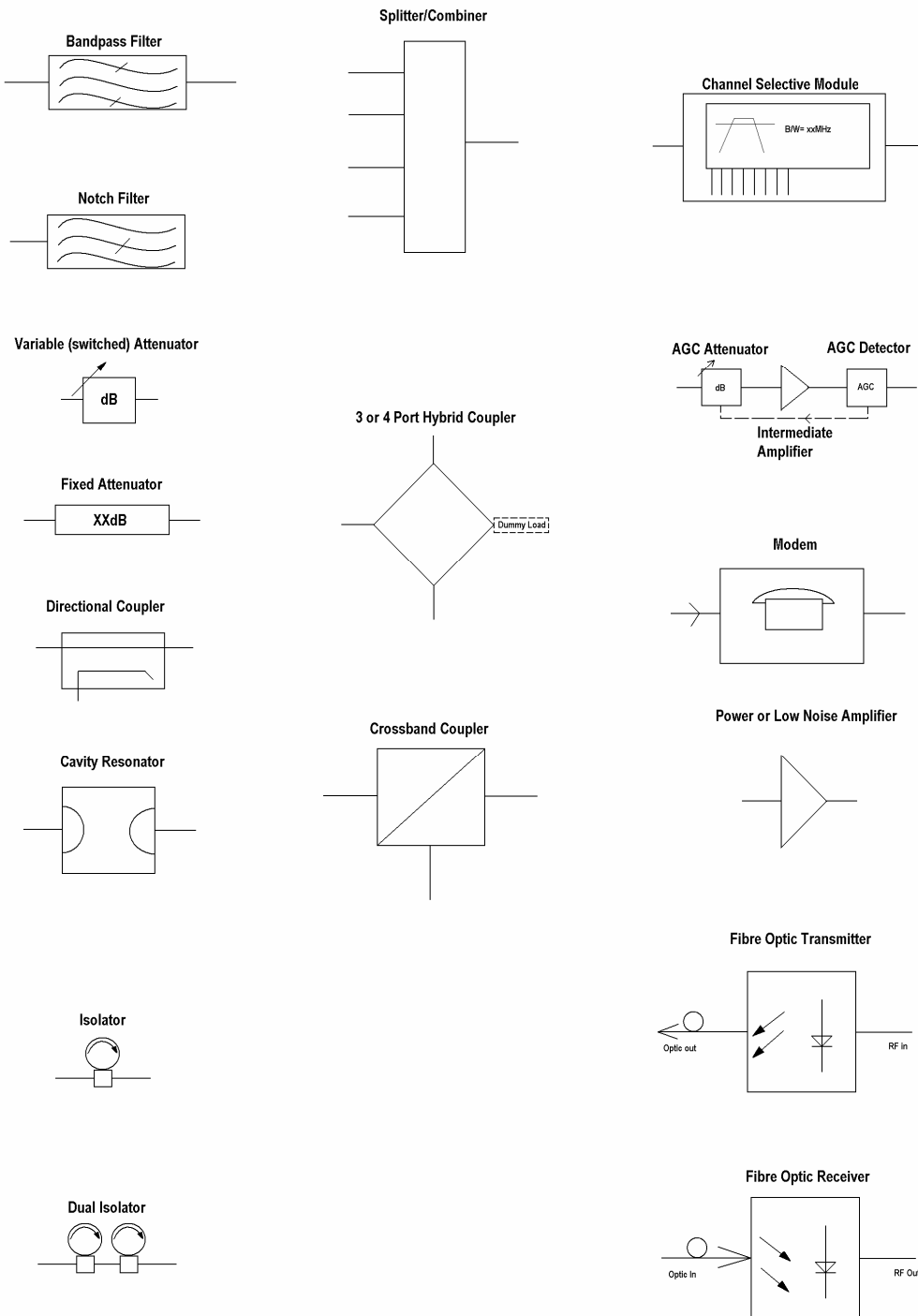

Key to AFL RF Modules

1. SAFETY CONSIDERATIONS

1.1 Electric Shock Hazard

Electrical shocks due to faulty mains driven power supplies.

Whilst ever potentially present in any electrical equipment, such a condition would be minimised by quality installation practice and thorough testing at:

- a) Original assembly.
- b) Commissioning.
- c) Regular intervals, thereafter.

All test equipment to be in good working order prior to its use. High current power supplies can be dangerous because of the possibility of substantial arcing. Always switch off during disconnection and reconnection.

1.2 RF Radiation Hazard

“CAUTION: This equipment is approved for antennas mounted on fixed outdoor permanent structures. A minimum separation distance of 2 metres must be maintained between the radiating elements and any nearby persons. A maximum antenna gain of 21 dBi may be used. Operating this equipment without regard to these restrictions will result in RF exposure levels above the limits allowed by FCC rules.”

This equipment complies with part 90 of the FCC rules. Any changes or modifications not expressly approved by the manufacturer could void the user’s authority to operate the equipment.

RF radiation, (especially at UHF frequencies) arising from transmitter outputs connected to AFL’s equipment, must be considered a safety hazard.

This condition might only occur in the event of cable disconnection, or because a ‘spare’ output has been left unterminated. Either of these conditions would impair the system’s efficiency. No investigation should be carried out until all RF power sources have been removed. This would always be a wise precaution, despite the severe mismatch between the impedance of an N type connector at 50Ω, and that of free space at 377Ω, which would severely mitigate against the efficient radiation of RF power. Radio frequency burns could also be a hazard, if any RF power carrying components were to be carelessly touched!

Antenna positions should be chosen to comply with requirements (both local & statutory) regarding exposure of personnel to RF radiation. When connected to an antenna, the unit is capable of producing RF field strengths, which may exceed guideline safe values especially if used with antennas having appreciable gain. In this regard the use of directional antennas with backscreens and a strict site rule that personnel must remain behind the screen while the RF power is on, is strongly recommended.

Where the equipment is used near power lines, or in association with temporary masts not having lightning protection, the use of a safety earth connected to the case-earthing bolt is strongly advised.

| | | | |
|---|---|-------------|--------------------------|
|  Aerial Facilities Limited www.AerialFacilities.com Technical Literature | P B L Tunnel Units 1 & 2 Maintenance Handbook | | |
| | H/book Number:- 60-056100HBKMFCC | Issue No:-2 | Date:- 04/01/2006 |

1.3 Chemical Hazard



Beryllium Oxide, also known as Beryllium Monoxide, or Thermalox™, is sometimes used in devices within equipment produced by Aerial Facilities Ltd. Beryllium oxide dust can be toxic if inhaled, leading to chronic respiratory problems. It is harmless if ingested or by contact.

Products that contain beryllium are load terminations (dummy loads) and some power amplifiers. These products can be identified by a yellow and black “skull and crossbones” danger symbol (shown above). They are marked as hazardous in line with international regulations, but pose no threat under normal circumstances. Only if a component containing beryllium oxide has suffered catastrophic failure, or exploded, will there be any danger of the formation of dust. Any dust that has been created will be contained within the equipment module as long as the module remains sealed. For this reason, any module carrying the yellow and black danger sign should not be opened. If the equipment is suspected of failure, or is at the end of its life-cycle, it must be returned to Aerial Facilities Ltd for disposal.

To return such equipment, please contact the Quality Department, who will give you a Returned Materials Authorisation (RMA) number. Please quote this number on the packing documents, and on all correspondence relating to the shipment.

PolyTetraFluoroEthylene, (P.T.F.E.) and P.T.F.E. Composite Materials

Many modules/components in AFL equipment contain P.T.F.E. as part of the RF insulation barrier.

This material should never be heated to the point where smoke or fumes are evolved. Any person feeling drowsy after coming into contact with P.T.F.E. especially dust or fumes should seek medical attention.

1.4 Emergency Contact Numbers

The AFL Quality Department can be contacted on:

Telephone +44 (0)1494 777000
Fax +44 (0)1494 777002
e-mail qa@aerial.co.uk

| | | | |
|---|---|-------------|--------------------------|
|  Aerial Facilities Limited www.AerialFacilities.com Technical Literature | P B L Tunnel Units 1 & 2 Maintenance Handbook | | |
| | H/book Number:- 60-056100HBKMFCC | Issue No:-2 | Date:- 04/01/2006 |

2. OVERVIEW/SYSTEM DESCRIPTION

The AFL Fibre feed Amplifier for the Pasadena Blue line project is a 2 way on-band RF amplifier. The primary application is as an interface between the fibre optical link from UNIT ONE (Port 3 Downlink/Port 4 Uplink) and the tunnel antenna/leaky feeder system(Ports J3 and J4). There are two units, one designated 'UNIT 1', which is a fibre Tx or Rx with an associated bandpass filter for each RF path, and 'UNIT 2' (a Bi-Directional amplifier) for the frequencies in the 483-486MHz range.

Each unit is housed in an environmentally protected IP65 steel wall-mount case. Handles are provided for carrying the unit and the door is fitted with locks. The unit interfaces with 'N' type female connectors for RF connections and heavy duty connectors for routing of AC power supply input and alarm output wiring. Cable glands are provided for routing of the Fibre optic cable in to the units.

The downlink signal path is as follows: The signal is received by a fibre optic receiver located in unit 1 it is then split in to two paths using bandpass filtering for the frequencies required. One downlink path is contained in unit 1 the other in unit 2. To provide the required gain to reach the required signal levels, low-noise amplifiers (LNA's) are used in each path, these being followed by power amplifier modules to provide the required intermodulation performance. The paths are then recombined using bandpass filtering (in unit 2) and are fed to the radiating cable. Gain adjustment is available locally using switched attenuators.

Similarly the uplink path is taken from the radiating cable and spilt into the two required frequency bands. One uplink path is contained in unit 1 the other in unit 2, again to provide the required gain to reach the required signal levels, low-noise amplifiers (LNA's) are used in each path, these being followed by power amplifier modules to provide the required intermodulation performance. The paths are then recombined using bandpass filtering and are fed to a fibre optic transmitter. Gain adjustment is available locally using switched attenuators.

To provide adequate selectivity in the Downlink and Uplink paths, combine design duplexers are used at the input and output ports.

Note that "Downlink" refers to the RF path from FO receiver to the leaky feeder port and that "Uplink" refers to the RF path from the leaky feeder port to either the FO transmitter or off-air antenna.

| | | | |
|---|---|-------------|--------------------------|
|  Aerial Facilities Limited www.AerialFacilities.com Technical Literature | P B L Tunnel Units 1 & 2 Maintenance Handbook | | |
| | H/book Number:- 60-056100HBKMFCC | Issue No:-2 | Date:- 04/01/2006 |

3. SPECIFICATIONS

3.1 Parts Lists

3.1.1 Equipment 60-056100 Parts List

| AFL Part N. | Description | Qty. | Ref |
|-------------|--|------|-----|
| 60-056105 | PBL F/O Filter Interface UNIT1 470/473 MHz | 1 | - |
| 60-056102 | PBL F/O BDA UNIT2 483/485 MHz | 1 | - |
| 60-056104 | PBL BDA LOC2 812/857MHz | 1 | - |

3.1.2 Unit 1 Fibre Fed Amplifier 60-056101 Parts List

| | | | |
|-----------|-------------------------------------|---|-------|
| 02-007302 | SDF C/L5P 380MHz VAR.BW TOPSMA | 2 | 5.1.1 |
| 02-007339 | 02-0073(FOUR) MTG PLATE | 1 | |
| 20-004001 | FIBRE OPTIC RF TRANSMITTER | 1 | 5.1.2 |
| 20-004101 | FIBRE OPTIC RF RECEIVER | 1 | 5.1.2 |
| 80-000720 | CASE 420 x 420 x 260 SCHROFF CUSTOM | 1 | |
| 91-500011 | PWR 3POLE PNL PLUG SEALED IP68 | 1 | |
| 91-500015 | PWR CON CAP SEALED with INT. THREAD | 2 | |
| 91-500016 | PWR 6POLE PNL PLUG SEALED IP68 | 1 | |
| 91-510010 | PWR 3POLE FREE SOC.SEALED IP68 | 1 | |
| 91-510013 | PWR CON CAP SEALED with Ext. THREAD | 2 | |
| 91-510014 | PWR 6POLE FREE SOC.SEALED IP68 | 1 | |
| 91-600007 | 'D' 9 WAY BLACK SHELL | 2 | |
| 91-600014 | 'D' 9 WAY SOCKET S/B (NON FILTERED) | 2 | |
| 91-600015 | 'D' 9 WAY PLUG S/B (NON FILTERED) | 1 | |
| 96-300045 | JWS75-15/A PSU (COUTANT LAMBDA) | 1 | 5.1.3 |
| 96-500003 | AC FILTER 110V 5A | 1 | |
| 96-700002 | LED.GREEN 5mm SEALED IP66 | 1 | |
| 96-700005 | LED.RED 5mm SEALED IP66 | 1 | |
| 96-900018 | AC TRIP SWITCH (5 AMP M.C.B.) | 1 | |
| 96-920011 | PROXIMITY SWITCH | 1 | |
| 96-920012 | PROXIMITY SWITCH MAGNET | 1 | |
| 97-300010 | SUPPLY I/P COVERS | 1 | |
| 97-400010 | BLACK PLASTIC HANDLE 37311 | 2 | |
| 97-900004 | RUBBER FOOT FOR CELL ENHANCERS | 4 | |

3.1.3 Unit 2 Fibre Fed Tunnel Amplifier 60-056102 Parts List

| AFL Part No. | Description | Qty. | Ref. |
|--------------|---|------|-------|
| 02-007302 | 6P TETRA C/L FILT(NARROW) SMA | 2 | |
| 02-013401 | SDF C/L5P 380MHzVAR.BW TOP SMA | 2 | |
| 02-010401 | UHF 2 SECTION NOTCH FILTER SMA | 2 | 5.2.1 |
| 02-007339 | 02-0073(FOUR) MTG PLATE | 2 | |
| 07-004801 | 500-800MHz CROSS BAND COUPLER | 1 | 5.2.2 |
| 07-005705 | CROSSBAND CPLR XC 250/380 SMA | 1 | 5.2.2 |
| 10-000701 | 1/4W0-30dB SWITCHED ATTENUATOR | 2 | |
| 11-006102 | LNA 380-500MHz 1W WITH RELAY | 1 | |
| 11-007302 | LNA. 380-500MHz 20dB (C/W RELAY) GA | 3 | |
| 12-002201 | 3 STAGE AMPLIFIER ALARM BOARD | 1 | |
| 12-002220 | 3 STAGE ALARM PCB COVER | 1 | |
| 12-002826 | ALARM BOARD ACRYLIC LENS | 1 | |
| 12-004201 | PWR AMP.450MHz 20W version CLASS A | 1 | |
| 13-003011 | DC/DC CONVERTER 24-12V 8A PCB SUB-ASS | 1 | |
| 17-000126 | CELL ENHANCER LABEL 6 DIGIT | 1 | |
| 17-001105 | CE AGC UNIT LOG DET/AMP ASSY | 1 | |
| 17-001201 | C/E AGC UNIT ATTENUATOR ASSY | 1 | |
| 17-001520 | CASE620 x 420 x 250 HOFFMAN X2HS CUSTOM | 1 | |
| 17-001522 | BASE PLATE 560x345mm 17-001520&9020 | 1 | |
| 17-009720 | EQUIP. MTG PLATE No.1 | 2 | |
| 17-009723 | EQUIP. MTG PLATE No.4 | 4 | |
| 17-009726 | EQUIP. MTG PLATE No.7 | 1 | |
| 80-008902 | 24V RELAY PCB ASSEMBLY | 1 | |
| 80-031820 | POWER AMP HEATSINK 20W 900MHz | 1 | |
| 80-032322 | POWER SUPPLY HEATSINK 10W | 1 | |
| 90-010021 | RF CABLE SUPFLEX SMA R/A MALE 100mm | 6 | |
| 90-010023 | RF CABLE SUPFLEX SMA R/A MALE 300mm | 1 | |
| 90-010026 | RF CABLE HIFLEX SMA R/A MALE 150mm | 3 | |
| 90-010027 | RF CABLE HIFLEX SMA R/A MALE 250mm | 1 | |
| 90-010120 | RF CABLE SMA R/A - N-TYPE (M) 100mm | 1 | |
| 90-010121 | RF CABLE SMA R/A - N-TYPE (M) 200mm | 1 | |
| 90-010122 | RF CABLE SMA R/A - N-TYPE (M) 250mm | 1 | |
| 90-010122 | RF CABLE SMA R/A - N-TYPE (M) 250mm | 1 | |
| 90-010123 | RF CABLE SMA R/A - N-TYPE (M) 300mm | 1 | |
| 90-010130 | RF CABLE SMA R/A-N PANEL JACK 100mm | 2 | |
| 90-010132 | RF CABLE SMA R/A-N PANEL JACK 250mm | 1 | |
| 90-010133 | RF CABLE SMA R/A-N PANEL JACK 300mm | 2 | |
| 90-010134 | RF CABLE SMA R/A-N PANEL JACK 400mm | 1 | |
| 90-010520 | RF CABLE N-TYPE(M)-N-TYPE(M)150MM | 1 | |
| 90-010522 | RF CABLE N-TYPE(M)-N-TYPE(M)250MM | 1 | |
| 90-010523 | RF CABLE N-TYPE(M)-N-TYPE(M)300MM | 1 | |
| 90-010524 | RF CABLE N-TYPE(M)-N-TYPE(M)350MM | 1 | |

| | | | |
|-----------|-------------------------------------|---|--|
| 90-010525 | RF CABLE N-TYPE(M)-N-TYPE(M)400MM | 1 | |
| 91-030002 | N ADAPTOR PANEL FEMALE:FEMALE | 3 | |
| 91-500011 | PWR 3POLE PNL PLUG SEALED IP68 | 1 | |
| 91-500015 | PWR CON CAP SEALED with INT. THREAD | 2 | |
| 91-500016 | PWR 6POLE PNL PLUG SEALED IP68 | 1 | |
| 91-510010 | PWR 3POLE FREE SOC.SEALED IP68 | 1 | |
| 91-510013 | PWR CON CAP SEALED with Ext. THREAD | 2 | |
| 91-510014 | PWR 6POLE FREE SOC.SEALED IP68 | 1 | |
| 91-520003 | POWER SWITCHD/FUSED MAINS INL. | 1 | |
| 91-600005 | 'D' 9 WAY SOCKET S/B TERM | 6 | |
| 91-600007 | 'D' 9 WAY BLACK SHELL | 6 | |
| 91-600014 | 'D' 9 WAY SOCKET S/B (NON FILTERED) | 4 | |
| 91-600015 | 'D' 9 WAY PLUG S/B (NON FILTERED) | 1 | |
| 91-700017 | ICD 15 WAY 0.1' CONNECTOR | 2 | |
| 92-120009 | M20 IP68 CABLE GLAND | 2 | |
| 92-400017 | GASKET FOR N TYPE CONNECTOR | 6 | |
| 93-540035 | 1K3 0.25W 1% RES MRS25 M:F | 2 | |
| 96-300002 | 24V 6.25A 150W PSU Flatpac | 1 | |
| 96-500003 | AC FILTER 110V 5A | 1 | |
| 96-500005 | DC INPUT FILTERS | 1 | |
| 96-700002 | LED.GREEN 5mm SEALED IP66 | 1 | |
| 96-700005 | LED.RED 5mm SEALED IP66 | 1 | |
| 96-900018 | AC TRIP SWITCH (5 AMP M.C.B.) | 1 | |
| 96-920011 | PROXIMITY SWITCH | 1 | |
| 96-920012 | PROXIMITY SWITCH MAGNET | 1 | |
| 97-300010 | SUPPLY I/P COVERS | 1 | |
| 97-400010 | BLACK PLASTIC HANDLE 37311 | 2 | |
| 97-900004 | RUBBER FOOT FOR CELL ENHANCERS | 4 | |

3.2 Technical Specifications

3.2.1 UHF ONE to Tunnels Technical Specification

| | | |
|-------------------------------|--|---|
| Frequency Range: | Downlink Channels: 470.2125MHz 470.2625MHz Spare | Uplink Channels: 473.2125MHz 473.2625MHz Spare |
| Band Width | Downlink :15kHz Uplink : 25kHz | |
| Nõ. of Paths | 2 | |
| Downlink Gain | 82 dB min | |
| Uplink Gain | 70 dB min | |
| RF Connector | N type female | |
| RF Impedance | 50Ω | |
| VSWR | Better than 1.5:1 | |
| Gain Adjustment | 0 to 30 in 2dB steps | |
| Downlink PA | 470.2125MHz, 470.2125MHz: 5W Class A Linear PA 482.2375MHz :20W Class A Linear PA | |
| Uplink PA | 485.2375MHz : 1W Class A Linear 473.2625MHz, 473.2125MHz : 5W Class A Linear | |
| Duplexer UP/DN Isolation | >80 dB | |
| Passband Ripple | <±1.5 dB | |
| Noise Figure | Downlink <7 dB at maximum gain | |
| Noise Figure | Uplink <18 dB at maximum gain | |
| In-Band Spurious | Better than -13dBm downlink Better than -13dBm uplink (measure with 30KHz BW & max gain setting) | |
| Out-band Spurious up to 3GHz: | Better than -90dBc | |

3.2.3 UHF TWO to Tunnels Technical Specification

| | | |
|-------------------------------|---|--|
| Frequency Range: | Downlink Channels: 483.0625MHz 483.2875MHz 483.3125MHz 483.5625MHz | Uplink Channels: 486.0625MHz 486.2875MHz 486.3125MHz 486.5625MHz |
| Band Width: | Downlink :15kHz Uplink : 25kHz ,486.0625MHz, 486.5625MHz 15kHz ,486.2875MHz, 486.3125MHz | |
| Nõ. of Paths: | 2 | |
| RF Connector: | N type female | |
| RF Impedance: | 50Ω | |
| VSWR: | Better than 1.5:1 | |
| Downlink Gain: | 90 dB min | |
| Uplink Gain: | 68 dB min | |
| Gain Adjustment: | 0 to 30 in 2dB steps | |
| Downlink PA: | 20W Class A Linear | |
| Uplink PA: | 20W Class A Linear | |
| Duplexer UP/DN Isolation: | >80 dB | |
| Passband Ripple: | <±1.5 dB | |
| Noise Figure: | Downlink <5 dB at maximum gain | |
| Noise Figure: | Uplink <12dB at maximum gain | |
| In-Band Spurious: | Better than -13dBm downlink Better than -13dBm uplink (measure with 30KHz BW with max gain setting) | |
| Out-band Spurious up to 3GHz: | Better than -90dBc | |

3.3 Mechanical Specifications

3.3.1 Unit 1 60-056101 Mechanical Specification

| PARAMETER | | SPECIFICATION |
|---|--------------|---|
| Size: | height: | 620 mm |
| | width: | 420 mm |
| | depth: | 260 mm |
| (excluding connectors, heatsinks, handles and feet) | | |
| Fixings: | | 4 holes on 250 mm (h) x 470 mm (w) |
| Weight: | | 50 kg (approx.) |
| Temperature Range: | operational: | -20°C to +50°C |
| | storage: | -40°C to +70°C |
| Humidity: | | 10% to 95% non-condensing |
| Environmental Protection: | | IP65 (with door closed and all ports terminated) |
| Finish: | Case: | RAL 7032 |
| | Heatsinks: | Black anodised |
| | Handles: | Black (where fitted) |
| Supply Cable: | | Unit supplied with 3-pin IP68 connector for customer interface with AC input. |

3.3.2 Unit 2 60-056102 Mechanical Specification

| | | |
|---|--------------|---|
| Size: | height: | 620 mm |
| | width: | 420 mm |
| | depth: | 250 mm |
| (excluding connectors, heatsinks, handles and f | | |
| Fixings: | | 4 holes on 500 mm (h) x 467 mm (w) |
| Weight: | | 50 kg (approx.) |
| Temperature Range: | operational: | -20°C to +50°C |
| | storage: | -40°C to +70°C |
| Humidity: | | 10% to 95% non-condensing |
| Environmental Protection: | | IP65 (with door closed and all ports terminated) |
| Finish: | Case: | RAL 7032 |
| | Heatsinks: | Black anodised |
| | Handles: | Black (where fitted) |
| Supply Cable: | | Unit supplied with 3-pin IP68 connector for customer interface with AC input. |

4. SYSTEM DRAWINGS

4.1 Drg. No. 60-056190, Location 2 UHF 1 Case Outline Drawing

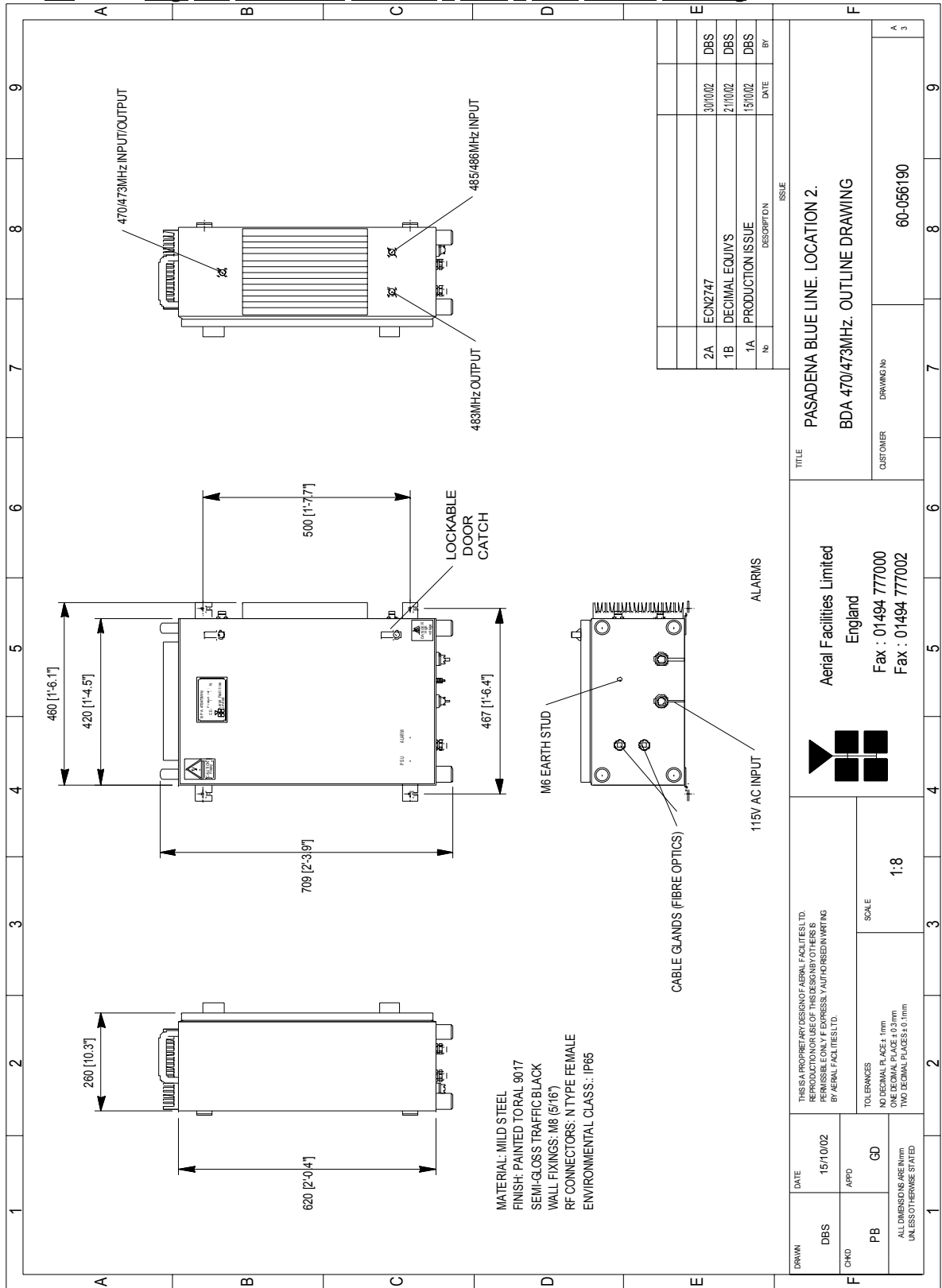

4.2 Drg. Nō. 60-056192, Location 2 UHF 2 Case Outline Drawing

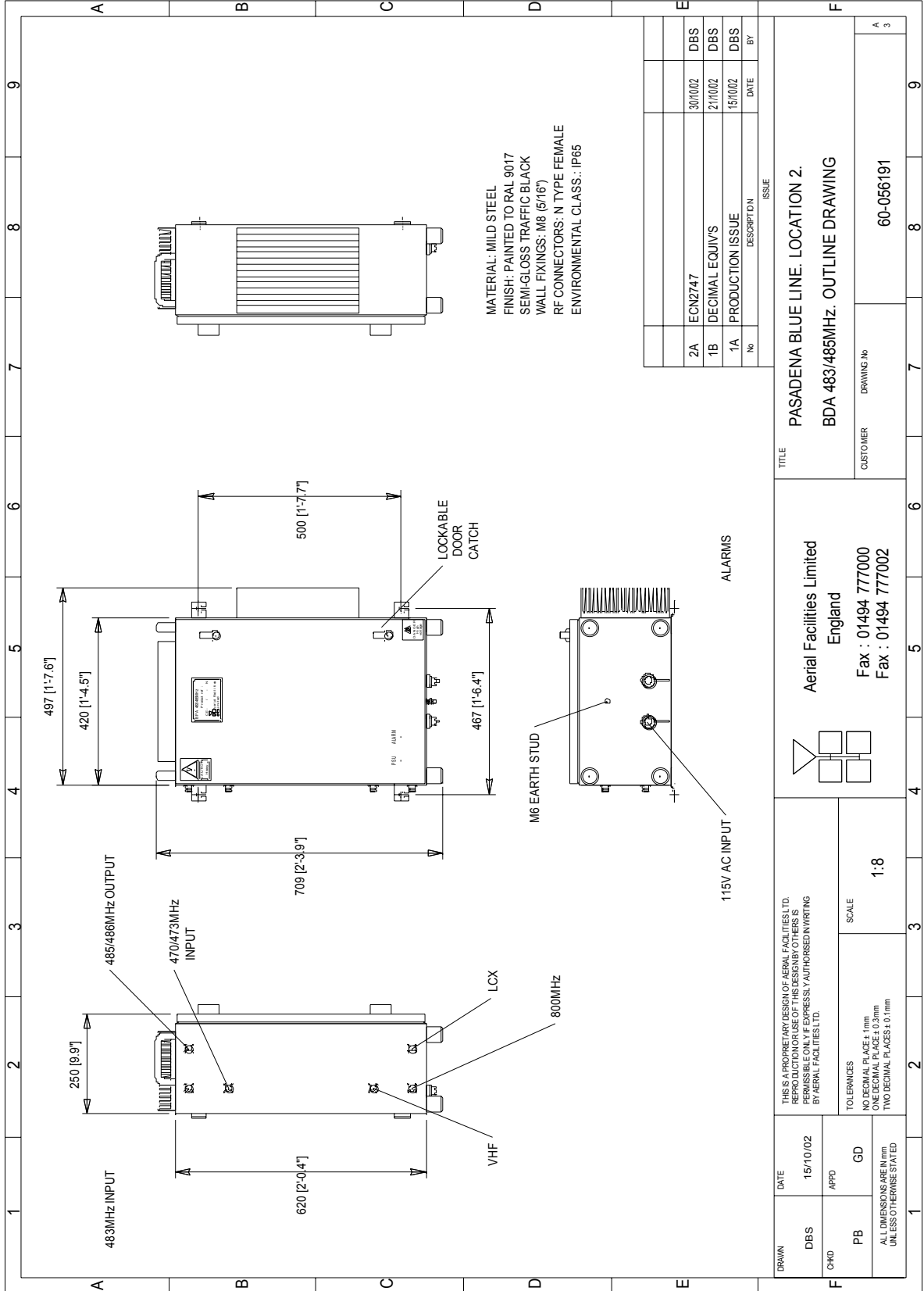

Remote Locations

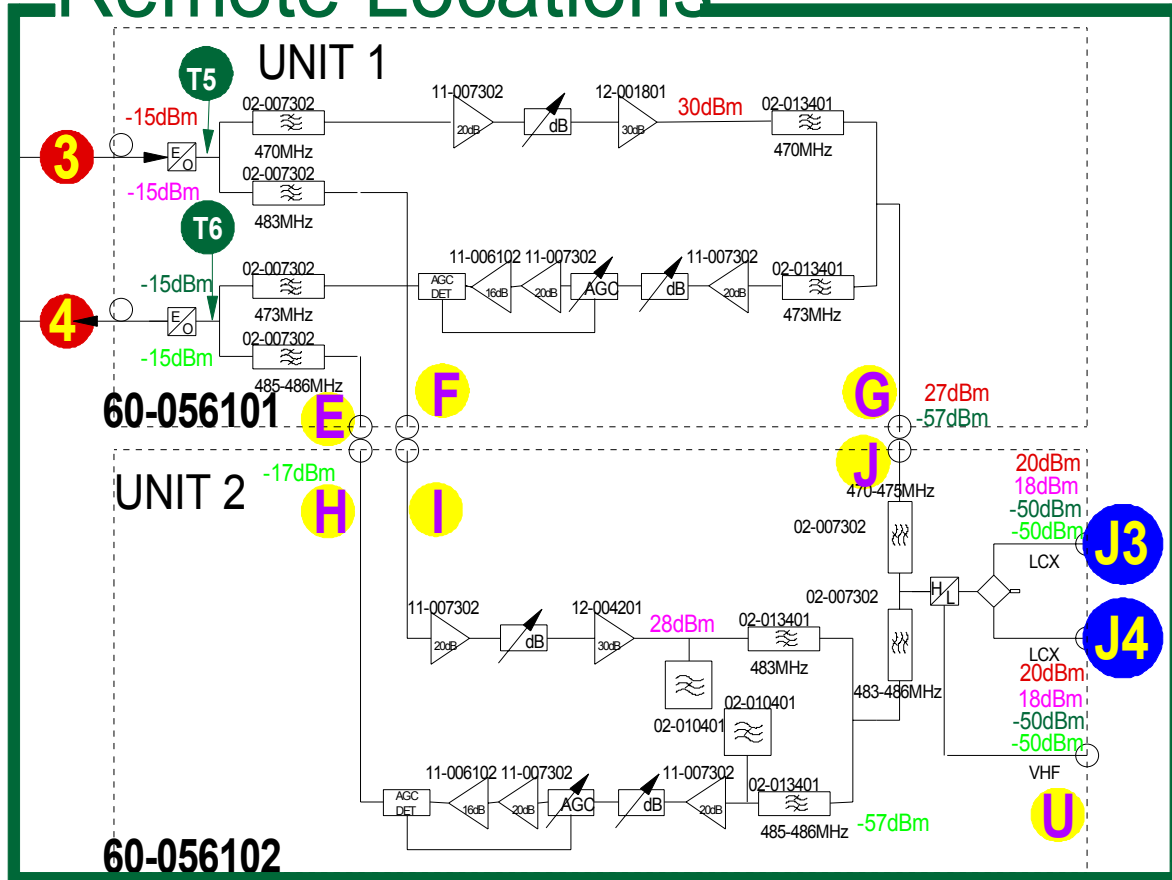

5. SUB-UNIT MODULES

5.1 Unit 1 (60-056101)

5.1.1 Bandpass Filters (02-007302)

5.1.1.1 Description

The bandpass filters are multi-section designs with a bandwidth dependent upon the passband frequencies, (both tuned to customer requirements). The response shape is basically Chebyshev with a passband design ripple of 0.1dB. The filters are of combline design, and are carefully aligned during manufacture in order to optimise the insertion loss, VSWR and intermodulation characteristics of the unit. The tuned elements are silver-plated to reduce surface ohmic losses and maintain a good VSWR figure and 50Ω load at the input and output ports.

No adjustments should be attempted without full network sweep analysis facilities to monitor both insertion loss and VSWR simultaneously.

5.1.1.2 Technical Specification (02-007302)

| PARAMETER | | SPECIFICATION |
|---------------------|------------|-----------------------------|
| Response type: | | Chebyshev |
| Frequency range: | | 350-500MHz (tuned to spec.) |
| Bandwidth: | | <3.5 MHz |
| Number of sections: | | 5 |
| Insertion loss: | | 2.7 dB (typical) |
| VSWR: | | better than 1.2:1 |
| Connectors: | | SMA |
| Power handling: | | 100W max |
| Temperature range | operation: | -10°C to +55°C |
| | storage: | -40°C to +70°C |
| Weight: | | 3 kg (approximately) |
| Size: | | 266 x 143 x 39.5mm |

5.1.2 AFL Fibre Optic Receiver & Transmitter (20-004001, Tx & 20-004101, Rx)

5.1.2.1 Description

The FO units consist of a receiver & transmitter, which modulates the RF signal onto a laser carrier and transmits it via fibre/optic cable to a receiver unit some distance away where it is demodulated back to the original RF signal with very small values of accrued attenuation.

Both transmitter and receiver modules have their own dedicated alarm outputs (volt-free relay contacts) which are integrated/summed into the main alarm system. The alarms are non-latching, so an alarm condition may revert to 'good' if the fault clears for any reason (e.g. momentary DC power loss).

The AFL Fibre Optic transmitters and receivers both have two LED status indicators, one on each module showing DC power and the other indicating 'Laser On' for the transmitter, and 'Carrier Being Received' for the receiver.

Typically the input to transmitter units will be at a level of between -30 and -15 dBm. The RF gain of a pair (Tx to Rx) units is factory set to give a 0dB gain, but this is with a short, low loss fibre. In determining the performance of any link, the insertion loss of the fibre and any power splitters fitted must be considered. A general rule of thumb figure would be around 0.5 - 1.5dB loss per fibre Kilometre.

The fibre optic transmitter module (20-004001) takes two RF inputs, one containing signals between 20- and 35 MHz (generally used by laser-modems for carrying alarm, and status information between sites) and another containing signals between 70 MHz and 2.5 GHz (the main RF carrier) and modulates them both onto to a fibre optic cable. The Laser Tx module uses a Class IIIa Transmitting Laser Device, see laser safety precautions in section 1. The receiver module (20-004101) takes a fibre optic signal, and converts this into two RF outputs, one containing signals between 20- and 35 MHz and another containing signals between 70 MHz and 2.5 GHz.

5.1.2.2 Fibre Optic Units Technical Specification

| PARAMETER | SPECIFICATION |
|-------------------------------------|-------------------------------|
| Frequency range (Traffic) | 70-2500MHz |
| Frequency range ('Data') | 20-35 MHz |
| Tx Max. Optical Output Power | +10dBm 61.5 |
| Rx Alarm: | @10dBm Fibre Loss |
| Gain (back-to-back connection) | +10dB |
| Flatness 70-2500MHz | +/-1.5dB |
| IP3 (All conditions) | >+30dBm |
| Noise Figure (back-back connector): | <40dB |
| Power Supply: | 12V DC -Ve GND |
| Consumption: | 350mA (typical) @ 12V DC (Rx) |
| | 100mA (typical) @ 12V DC (Tx) |

5.1.2.3 'D' Connector Pinouts

Rx 'D' Type Female Connector

| Pin Nō. | Signal Description |
|---------|------------------------------|
| 1 | +12V DC Power |
| 2 | No Connection |
| 3 | Power Ground |
| 4 | No Connection |
| 5 | No Connection |
| 6 | O/C. Alarm |
| 7 | Relay Alarm Contact (N.C) |
| 8 | Relay Alarm Contact (Common) |
| 9 | Relay Alarm Contact (N.O) |

Tx 'D' Type Female Connector

| Pin Nō. | Signal Description |
|---------|------------------------------|
| 1 | +12V DC Power |
| 2 | No Connection |
| 3 | Power Ground |
| 4 | No Connection |
| 5 | No Connection |
| 6 | O/C Alarm |
| 7 | Relay Alarm Contact (N.C) |
| 8 | Relay Alarm Contact (Common) |
| 9 | Relay Alarm Contact (N.O) |

5.1.3 JWS75-15/A PSU (96-300045)

5.1.3.1 Description

The power supply unit is a switched-mode type capable of supplying 24V DC at 3.25Amps continuously. This PSU is used to provide power for the fibre optic modules which will typically require less than 1.50 Amps at 15V DC, so the PSU will be used conservatively ensuring a long operational lifetime.

No routine maintenance of the PSU is required. If a fault is suspected, then the output voltage from the power supply may be measured on its output terminals. The output voltage is set at test but can be adjusted by a multi-turn potentiometer mounted close to the DC output terminals.

All the PSU's used in AFL Cell Enhancers are capable of operation from either 110 or 220V nominal AC supplies. The line voltage is sensed automatically, so no adjustment or link setting is needed by the operator.

5.1.3.2 Technical Specification

| AC Input Supply: | |
|--------------------------|---|
| Voltage: | 110 or 220V nominal |
| | 90 to 132 or 180 to 264V (absolute limits) |
| Frequency: | 47 to 63Hz |
| DC Output Supply: | |
| Voltage: | 24V DC (nominal) |
| | 22 to 26V (absolute limits) |
| Current: | 6.25A |

5.2 Unit 2 (60-056102)

5.2.1 Bandpass Filter (02-013401)

5.2.1.1 Description

The bandpass filters are multi-section designs with a bandwidth dependent upon the passband frequencies, (both tuned to customer requirements). The response shape is basically Chebyshev with a passband design ripple of 0.1dB. The filters are of combline design, and are carefully aligned during manufacture in order to optimise the insertion loss, VSWR and intermodulation characteristics of the unit. The tuned elements are silver-plated to reduce surface ohmic losses and maintain a good VSWR figure and 50Ω load at the input and output ports. Being passive devices, the bandpass filters should have an extremely long operational life and require no maintenance. Should a filter be suspect, it is usually most time efficient to replace the module rather than attempt repair or re-tuning.

No adjustments should be attempted without full network sweep analysis facilities to monitor both insertion loss and VSWR simultaneously.

5.2.1.2 Technical Specification

| PARAMETER | | SPECIFICATION |
|-----------------|------------|----------------------|
| Passband: | FILTER 1 | 470-470.5MHz |
| | FILTER 2 | 473-473.5MHz |
| Insertion Loss: | FILTER 1 | 2.8 dB typical |
| | FILTER 2 | 2.8 dB typical |
| Rejection: | FILTER 1 | 470-470.5MHz > 60 dB |
| | FILTER 2 | 473-473.5MHz > 60 dB |
| Power Rating | | 250 Watt |
| | Impedance | 50 ohm |
| | VSWR | Better than 1.2:1 |
| | Connectors | SMA female |

5.2.2 Two Section Notch Filter (02-010401)

5.2.2.1 Description

Fitted in Unit 2 after the amplification stages is a 2 element notch filter (one in downlink, one in uplink), which is designed to reject the uplink frequencies in the downlink path and vice-versa. The notch filter is not required for Unit One as the rejection from the two series bandpass filters as apposed to one, is sufficient to meet the specification.

5.2.2.2 Technical Specification (Uplink)

| PARAMETER | | SPECIFICATION |
|--------------------|---------|---------------------|
| Frequency range: | | 485.2-485.6 MHz |
| Stopband: | | 482.2 – 483.6MHz |
| Nō. of sections: | | 2 |
| Attenuation: | | >40dB @ 482.2MHz |
| Insertion loss: | | 0.5dB |
| VSWR: | | Better than 1.2:1 |
| Connectors: | | SMA |
| Power Handling: | | 50W maximum |
| Temperature range: | operate | -10°C to +55°C |
| | store: | -30°C to +70°C |
| Weight: | | <3 kg |
| Size: | | 384 x 82.5 x 56.4mm |

5.2.2.3 Technical Specification (Downlink)

| | | |
|--------------------|----------|---------------------|
| Frequency range: | | 482.2-483.6 MHz |
| Stopband: | | 485.2-486.6MHz |
| Nō. of sections: | | 2 |
| Attenuation: | | >40dB @ 485.2MHz |
| Insertion loss: | | 0.5dB |
| VSWR: | | Better than 1.2:1 |
| Connectors: | | SMA |
| Power Handling: | | 50W maximum |
| Temperature range: | operate: | -10°C to +55°C |
| | store: | -30°C to +70°C |
| Weight: | | <3 kg |
| Size: | | 384 x 82.5 x 56.4mm |

5.2.3 Crossband Couplers (07-004801 & 07-005705)

5.2.3.1 Description

The purpose of a crossband coupler is to either combine/split transmission signals from different parts of the frequency spectrum.

The crossband coupler fitted here, is the means by which the separate UHF & GSM frequency band signals are mixed to form a composite RF signal.

It basically comprises of a 3 port device, two filters, one a low pass the other a high pass, that are then mixed and fed to a common output. The couplers are built into a machined aluminium casing having a centre screening wall between the filter sections and lid secured by screws at frequent intervals over its perimeter to obtain a tight seal and to ensure linearity and stability of response.

5.2.3.2 Technical Specification (07-004801)

| PARAMETER | SPECIFICATION |
|-------------------|------------------|
| Passband: | 390-490MHz |
| | 700-900MHz |
| Nō. Of i/p ports: | 2 |
| Nō. Of o/p ports: | 1 |
| Insertion loss: | 0.5dB (typical) |
| Isolation: | >40dB 390-490MHz |
| | >40dB 700-900MHz |
| Impedance: | 50Ω |
| Connectors: | SMA female |
| Power rating: | 50Watts (CW) |

5.2.3.3 Technical Specification

| PARAMETER | SPECIFICATION |
|------------------------|--|
| Passband: | 250 MHz 70.0-250MHz |
| | 380 MHz 380-960MHz |
| Power Rating | 50 Watts (CW) |
| Number of Input ports | 2 |
| Number of Output ports | 1 |
| Insertion loss | 0.5 dB |
| Isolation | > 50 dB 70-250 MHz > 50 dB 380-960 MHz (15 dB typical return loss 500-960) |
| Impedance | 50 Ω |
| Connectors | SMA- female |

5.2.4 ¼Watt 0- -30dB Switched Attenuator (10-000701)

5.2.4.1 General Application

In many practical applications for Cell Enhancers etc., the gain in each path is found to be excessive. Therefore, provision is made within the unit for the setting of attenuation in each path, to reduce the gain.

5.2.4.2 Switched Attenuators

The AFL switched attenuators are available in two different types; 0 – 30dB in 2 dB steps (as in this case), or 0 – 15dB in 1 dB steps. The attenuation is simply set using the four miniature toggle switches on the top of each unit. Each switch is clearly marked with the attenuation it provides, and the total attenuation in line is the sum of the values switched in. They are designed to maintain an accurate 50Ω impedance over their operating frequency at both input and output.

5.2.5 Low Noise Amplifiers (11-006102, & 11-007302)

5.2.5.1 Description

The low noise amplifiers used are double or triple stage solid-state low-noise amplifiers. Class A circuitry is used in the units to ensure excellent linearity over a very wide dynamic range. The active devices are very moderately rated to provide a long trouble-free working life. There are no adjustments on these amplifiers, and in the unlikely event of failure then the entire amplifier should be replaced. Note that all LNA's use similar DC power circuit boards.

5.2.5.2 Technical Specification (11-006102)

| PARAMETER | | SPECIFICATION |
|------------------------|--------------|--------------------------------|
| Frequency range: | | 70 – 500MHz |
| Bandwidth: | | <430MHz |
| Gain: | | 15.5dB (typical) |
| 1dB Compression Point: | | +31dBm (typical) |
| 3rd order intercept: | | +46dBm (typical) |
| Input return loss: | | >20dB |
| Output return loss: | | >20dB |
| VSWR: | | Better than 1.5:1 |
| Noise figure: | | <4.8dB |
| Connectors: | | SMA female |
| Supply: | | 530mA @ 10 to 24V DC (typical) |
| Temperature range: | operational: | -10°C to +60°C |
| | storage: | -40°C to +70°C |
| Weight: | | 260gms |

5.2.5.3 Drg. Nō. 11-006102, Low Noise Amplifier General Assembly

| | | | | |
|---|---|---|----------------|--|
|  | Aerial Facilities Limited www.AerialFacilities.com Technical Literature | P B L Tunnel Units 1 & 2 Maintenance Handbook | | |
| H/book Number:- 60-056100HBKMFCC | Issue No:-2 | Date:- 04/01/2006 | Page:-29 of 63 | |

5.2.5.4 Drg. Nō. 11-006170. LNA RF Circuit Diagram

| | | | | |
|---|---|---|--------------------------|----------------|
|  | Aerial Facilities Limited www.AerialFacilities.com Technical Literature | P B L Tunnel Units 1 & 2 Maintenance Handbook | | |
| H/book Number:- 60-056100HBKMFCC | | Issue No:-2 | Date:- 04/01/2006 | Page:-30 of 63 |

5.2.5.5 Drg. Nō. 11-006171, LNA DC Wiring Diagram

| | | | | |
|---|---|---|--------------------------|----------------|
|  | Aerial Facilities Limited www.AerialFacilities.com Technical Literature | P B L Tunnel Units 1 & 2 Maintenance Handbook | | |
| H/book Number:- 60-056100HBKMFCC | | Issue No:-2 | Date:- 04/01/2006 | Page:-31 of 63 |

5.2.5.6 Drg. Nō. 11-003971, LNA DC Schematic Diagram

| | | | | |
|---|---|---|--------------------------|----------------|
|  | Aerial Facilities Limited www.AerialFacilities.com Technical Literature | P B L Tunnel Units 1 & 2 Maintenance Handbook | | |
| H/book Number:- 60-056100HBKMFCC | | Issue No:-2 | Date:- 04/01/2006 | Page:-32 of 63 |

5.2.5.7 Technical Specification (11-007302)

| PARAMETER | | SPECIFICATION |
|---------------------------|--------------|----------------------------|
| Frequency range: | | 380-500MHz |
| Bandwidth: | | <140MHz |
| Gain: | | 20-22dB |
| 1dB Compression Point: | | +23.5dB (typical) |
| 3rd order intercept: | | +36dB (typical) |
| Input/Output return loss: | | >20dB |
| Noise figure: | | <1.3dB |
| Connectors: | | SMA female |
| Supply: | | 200-230mA @ 24V DC |
| Temperature range: | operational: | -10°C to +55°C |
| | storage: | -30°C to +70°C |
| Weight: | | <300gms |
| Size: | | 90 x 55 x 30.2 (case only) |

5.2.5.8 Drg. Nō. 11-007302, LNA Assembly With Alarm Relay

| | | | | |
|---|---|---|--------------------------|----------------|
|  | Aerial Facilities Limited www.AerialFacilities.com Technical Literature | P B L Tunnel Units 1 & 2 Maintenance Handbook | | |
| H/book Number:- 60-056100HBKMFCC | | Issue No:-2 | Date:- 04/01/2006 | Page:-34 of 63 |

5.2.5.9 Drg. Nō. 11-007370. LNA RF Circuit Diagram

| | | | | |
|---|---|---|----------------|--|
|  | Aerial Facilities Limited www.AerialFacilities.com Technical Literature | P B L Tunnel Units 1 & 2 Maintenance Handbook | | |
| H/book Number:- 60-056100HBKMFCC | Issue No:-2 | Date:- 04/01/2006 | Page:-35 of 63 | |

5.2.5.10 Drg. Nō. 11-007371, LNA DC Wiring Diagram

| | | | | |
|---|---|---|--------------------------|----------------|
|  | Aerial Facilities Limited www.AerialFacilities.com Technical Literature | P B L Tunnel Units 1 & 2 Maintenance Handbook | | |
| H/book Number:- 60-056100HBKMFCC | | Issue No:-2 | Date:- 04/01/2006 | Page:-36 of 63 |

5.2.6 3 Stage Amplifier Alarm Boards (12-002201)

5.2.6.1 Description

Amplifier Alarm Boards are fitted to monitor the bias conditions of AFL Class A amplifiers which remain constant in normal operation. Any departure from normal bias conditions is a result of device failure, excess temperature, over-driving or oscillation (excessive power).

In normal operation, the Class A bias circuit of the amplifier develops a constant voltage of 1.20V across the collector current setting resistor. The Amplifier Alarm Board is a window comparator device, which is adjusted to sense a departure from this condition. Several different alarm outputs are provided to simplify interfacing, (Relay Contact, Open Collector, and TTL Logic Levels)

The basic version of the Alarm Board (12-002801) monitors a single amplifier stage. A three-stage version (12-002201) is used on complex amplifiers where three separate comparators have their outputs logically combined to a common output stage. Failure of any one stage will activate the alarms.

Note that the alarm board has a green Light Emitting Diode located near to the centre of the printed circuit board, which is illuminated on 'Good', and extinguished on 'Alarm'. It is therefore a simple matter to identify an active module failure, by searching for an Alarm Board which has its green LED extinguished. A simple test of the alarm board is possible by shorting across the monitor inputs, pins 1 and 2, 3 and 4 or across pins 5 and 6. This last monitor input is inactive if the board has been converted to a two way alarm board. (Refer to relevant amplifier alarm wiring diagram.)

- 1) Volt-free change over relay contacts.
- 2) Open collector NPN transistor pulls low on alarm.
- 3) TTL driver.

The use of precision voltage sources and resistors has eliminated the need for initial adjustment or calibration, and the board will function correctly with a wide variation in power supply voltage (8 to 30 volts, nominal supply is 12 or 24Volts).

There are two selectable link options on the three-way board:

- LINK1 - Removed to convert to two-way alarm board.
- LINK2 - Removed to isolate 0V from chassis earth.

The one way alarm board only has the 0V isolation link (LINK2) fitted.

| | | | |
|---|---|-------------|--------------------------|
|  Aerial Facilities Limited www.AerialFacilities.com Technical Literature | P B L Tunnel Units 1 & 2 Maintenance Handbook | | |
| | H/book Number:- 60-056100HBKMFCC | Issue No:-2 | Date:- 04/01/2006 |

5.2.6.2 Technical Specification

| PARAMETER | | SPECIFICATION |
|-------------------------------------|--------------|---------------------------------------|
| Operating voltage: | | 8 to 30V (floating earth) |
| Alarm Threshold: | | V _{cc} - 1.20 volt \pm 15% |
| Alarm output relay contacts: | | |
| Max. switch current: | | 1.0Amp |
| Max. switch volts: | | 120Vdc/60VA |
| Max. switch power: | | 24W/60VA |
| Min. switch load: | | 10.0 μ A/10.0mV |
| Relay isolation: | | 1.5kV |
| Mechanical life: | | >2x10 ⁷ operations |
| Relay approval: | | BT type 56 |
| Connector details: | | 15-way 0.1" pitch |
| Temperature range: | operational: | :-10°C to +55°C |
| | storage: | :-40°C to +70°C |
| PCB Size: | | 74 x 56mm (3 stage) |
| | | 54 x 56mm (1 stage) |

5.2.6.3 Drg. Nō. 12-002201, 3 Stage Alarm Board Assembly Drawing & Parts List

| | | | | |
|---|---|---|----------------|--|
|  | Aerial Facilities Limited www.AerialFacilities.com Technical Literature | P B L Tunnel Units 1 & 2 Maintenance Handbook | | |
| H/book Number:- 60-056100HBKMFCC | Issue No:-2 | Date:- 04/01/2006 | Page:-39 of 63 | |

5.2.6.4 Drg. Nō. 12-002270. 3 Stage Alarm Board Circuit Diagram

| | | | | |
|---|---|---|--------------------------|----------------|
|  | Aerial Facilities Limited www.AerialFacilities.com Technical Literature | P B L Tunnel Units 1 & 2 Maintenance Handbook | | |
| H/book Number:- 60-056100HBKMFCC | | Issue No:-2 | Date:- 04/01/2006 | Page:-40 of 63 |

5.2.6.5 Generic Wall Enclosure Alarm Wiring Sketch

| | | | | |
|---|---|---|----------------|--|
|  | Aerial Facilities Limited www.AerialFacilities.com Technical Literature | P B L Tunnel Units 1 & 2 Maintenance Handbook | | |
| H/book Number:- 60-056100HBKMFCC | Issue No:-2 | Date:- 04/01/2006 | Page:-41 of 63 | |

5.2.7 450MHz 20W Power Amplifier (12-004201)

5.2.7.1 Description

The power amplifiers fitted to this unit are multi-stage, solid state power amplifiers. Class A circuitry is employed throughout the units to ensure excellent linearity over a wide dynamic frequency range. All the semi-conductor devices are very conservatively rated to ensure low device junction temperatures and a long, trouble free working lifetime.

The power amplifiers should require no maintenance over their operating lives. Under no circumstances should the cover be removed or the side adjustments disturbed unless it is certain that an amplifier has failed; since they are critically aligned during manufacture and any re-alignment will require extensive test equipment.

5.2.7.2 Technical Specification

| PARAMETER | | SPECIFICATION |
|----------------------------|--------------|--------------------------------------|
| Frequency Range: | | 350 – 550MHz (tuned to spec.) |
| Bandwidth: | | 20MHz (tuned to spec.) |
| Maximum Output Power: | | >20W (each) |
| Gain: | | 30dB |
| 1dB Compression Point: | | <+43dBm |
| 3rd Order Intercept Point: | | <+54dBm |
| VSWR: | | better than 1.45:1 |
| Connectors: | | SMA female |
| Supply: | | 3.50A @ 24V DC |
| Size: | | 276 x 78 x 40mm (ex. Cons. & h'sink) |
| Weight: | | 1.5 kg (approx., excl. h'sink) |
| Temperature range: | operational: | -10°C to +55°C |
| | storage: | -40°C to +70°C |

5.2.7.3 Drg. Nō. 12-004201, PA General Assembly

| | | | | |
|---|---|---|--------------------------|----------------|
|  | Aerial Facilities Limited www.AerialFacilities.com Technical Literature | P B L Tunnel Units 1 & 2 Maintenance Handbook | | |
| H/book Number:- 60-056100HBKMFCC | | Issue No:-2 | Date:- 04/01/2006 | Page:-43 of 63 |

5.2.7.4 Drg. Nō. 12-004270. PA Circuit Diagram

| | | | | |
|---|---|---|----------------|--|
|  | Aerial Facilities Limited www.AerialFacilities.com Technical Literature | P B L Tunnel Units 1 & 2 Maintenance Handbook | | |
| H/book Number:- 60-056100HBKMFCC | Issue No:-2 | Date:- 04/01/2006 | Page:-44 of 63 | |

5.2.7.5 Drg. Nō. 12-004270C1. PA Parts List(1)

| | | | | |
|---|---|---|--------------------------|----------------|
|  | Aerial Facilities Limited www.AerialFacilities.com Technical Literature | P B L Tunnel Units 1 & 2 Maintenance Handbook | | |
| H/book Number:- 60-056100HBKMFCC | | Issue No:-2 | Date:- 04/01/2006 | Page:-45 of 63 |

5.2.7.6 Drg. Nō. 12-004270C2. PA Parts List(2)

| | | | | |
|---|---|---|--------------------------|----------------|
|  | Aerial Facilities Limited www.AerialFacilities.com Technical Literature | P B L Tunnel Units 1 & 2 Maintenance Handbook | | |
| H/book Number:- 60-056100HBKMFCC | | Issue No:-2 | Date:- 04/01/2006 | Page:-46 of 63 |

5.2.7.7. Drg. Nō. 12-003670. PA to Alarm Wiring Details

| | | | |
|---|---|-------------|--------------------------|
|  Aerial Facilities Limited www.AerialFacilities.com Technical Literature | P B L Tunnel Units 1 & 2 Maintenance Handbook | | |
| | H/book Number:- 60-056100HBKMFCC | Issue No:-2 | Date:- 04/01/2006 |

5.2.8 DC/DC Converter, 24V in, 12V 8A out (13-003011)

5.2.8.1 Description

The DC/DC converter fitted is an AFL assembled, high power PCB unit with an 8 amp @ 24V in, 12V output capability. The circuit is basically an O.E.M semiconductor regulator (one side of which has a heatsink mounting plate, that is usually bolted to the casing of a Cell Enhancer) and smoothing components built onto a printed circuit board with screw block terminations.

Note: no circuit diagram of the O.E.M. regulator is available. This unit should not be repaired, only replaced.

5.2.8.2 Technical Specification

| PARAMETER | | SPECIFICATION |
|----------------------|------------|----------------|
| Input Voltage Range: | | 18-28V DC |
| Output Voltage: | | 12V±0.5V |
| Max. Current Load: | | 8.0Amps |
| Temperature Range: | operation: | -10°C to +55°C |
| | storage: | -40°C to +70°C |
| Size(PCB): | | 190 x 63mm |
| Weight (Loaded PCB): | | 291gms |

5.2.8.3 Photo of Regulator PCB (regulator heatsink side)

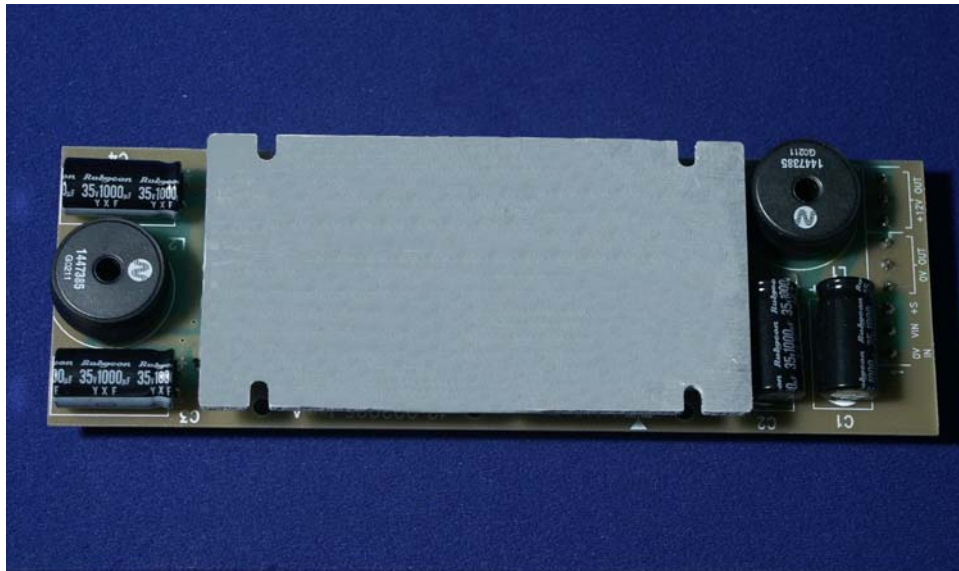

5.2.9 Wide Dynamic Range AGC (17-001105 Det. & 17-001201 Atten.)

5.2.9.1 Description

The equipment is fitted with a wide dynamic range Automatic Gain Control (AGC) system. This is generally fitted in the Uplink path (not usually needed in the downlink path, as the signal here is at an almost constant level), to avoid overloading the amplifiers (with the associated performance degradation) should a mobile be operated very close to the unit.

The AFL wide dynamic range Automatic Gain Control system consists of two units, a detector/amplifier and an attenuator. The detector/amplifier unit is inserted in the RF path on the output of the power amplifier, and the attenuator is situated in the RF path between the 1st and 2nd stages of amplification.

Normally the attenuator is at minimum attenuation. The detector/amplifier unit monitors the RF level being delivered by the power amplifier, and when a certain threshold is reached it begins to increase the value of the attenuator to limit the RF output to the (factory set) threshold. Therefore overloading of the power amplifier is avoided.

The factory set threshold is 1dB below the Enhancer 1dB compression point. Some adjustment of this AGC threshold level is possible, a 10dB range is mostly achieved. It is not recommended under any circumstances to adjust the AGC threshold to a level greater than the 1dB compression point as system degradation will occur.

The detector comprises of a 50Ω transmission line with a resistive tap which samples a small portion of the mainline power. The sampled signal is amplified and fed to a conventional half wave diode rectifier, the output of which is a DC voltage proportional to the RF input signal.

This DC voltage is passed via an inverting DC amplifier with integrating characteristics, to the output, which drives the attenuation control line of the corresponding AGC attenuator. This unit is fitted at some earlier point in the RF circuit.

The unit contains a 12V DC regulator in the detector module, which supplies stabilised voltage to the DC amplifier and via an external cableform to the AGC attenuator.

| | | | |
|---|---|-------------|--------------------------|
|  Aerial Facilities Limited www.AerialFacilities.com Technical Literature | P B L Tunnel Units 1 & 2 Maintenance Handbook | | |
| | H/book Number:- 60-056100HBKMFCC | Issue No:-2 | Date:- 04/01/2006 |

For small signals, below AGC onset, the output control line will be close to 12V and the AGC attenuator will have minimum attenuation. As the signal level increases the control line voltage will fall, increasing the attenuator value and keeping the system output level at a constant value.

The AGC onset level is adjusted by the choice of sampler resistor R1 and by the setting of potentiometer VR1.

The attenuator comprises a 50Ω P.I.N diode, voltage-variable attenuator with a range of 3 to 30dB. The attenuation is controlled by a DC voltage which is derived from the associated AGC detector unit.

5.2.9.2 Technical Specification

| PARAMETER | | SPECIFICATION |
|--------------------|------------------|-----------------------|
| Frequency Range: | | up to 1000MHz |
| Attenuation Range: | | 3 to 30dB |
| Attenuation Steps: | | continuously variable |
| VSWR: | | better than 1.2:1 |
| RF Connectors: | | SMA female |
| Power Handling: | attenuator: | 1W |
| | detector/amp: | >30W (or as required) |
| Temperature Range: | operation: | -10°C to +55°C |
| | storage: | -40°C to +70°C |
| Size: | attenuator (pcb) | 50 x 42 x 21mm |
| | Detector (pcb) | 54 x 42 x 21mm |
| Weight: | attenuator: | 90grams |
| | detector/amp: | 100grams |

5.2.9.3 Drg. Nō. 17-001105, ACG Detector Assembly

| | | | | |
|---|---|---|--------------------------|----------------|
|  | Aerial Facilities Limited www.AerialFacilities.com Technical Literature | P B L Tunnel Units 1 & 2 Maintenance Handbook | | |
| H/book Number:- 60-056100HBKMFCC | | Issue No:-2 | Date:- 04/01/2006 | Page:-51 of 63 |

5.2.9.4 Drg. Nō. 17-001175. Wide Range AGC Detector Circuit Diagram

| | | | |
|--|---|--------------------------|----------------|
|  <p>Aerial Facilities Limited www.AerialFacilities.com Technical Literature</p> | <p>P B L Tunnel Units 1 & 2 Maintenance Handbook</p> | | |
| H/book Number:- 60-056100HBKMFCC | Issue No:-2 | Date:- 04/01/2006 | Page:-52 of 63 |

5.2.9.5 Drg. Nō. 17-001201, AGC Attenuator Assembly Drawing

| | | | | |
|---|---|---|--------------------------|----------------|
|  | Aerial Facilities Limited www.AerialFacilities.com Technical Literature | P B L Tunnel Units 1 & 2 Maintenance Handbook | | |
| H/book Number:- 60-056100HBKMFCC | | Issue No:-2 | Date:- 04/01/2006 | Page:-53 of 63 |

5.2.9.6 Drg. Nō. 17-001270, AGC Attenuator Circuit Diagram

| | | | | |
|---|---|---|--------------------------|----------------|
|  | Aerial Facilities Limited www.AerialFacilities.com Technical Literature | P B L Tunnel Units 1 & 2 Maintenance Handbook | | |
| H/book Number:- 60-056100HBKMFCC | | Issue No:-2 | Date:- 04/01/2006 | Page:-54 of 63 |

5.2.10. 24V Single Relay Board (80-008902)

5.2.10.1 Description

The General Purpose Relay Board allows the inversion of signals and the isolation of circuits. It is equipped with a single dual pole change-over relay RL1, with completely isolated wiring, accessed via a 15 way in-line connector.

The relay is provided with polarity protection diodes and diodes for suppressing the transients caused by "flywheel effect" which can destroy switching transistors or induce spikes on neighbouring circuits. It's common use is to amalgamate all the alarm signals into one, volts-free relay contact pair for the main alarm system.

Note that the board is available for different voltages (12 or 24V) depending on the type of relay fitted at RL1.

5.2.11. 24V Flat-Pack PSU (96-300002)

5.2.11.1 Description

The power supply unit is a switched-mode type capable of supplying 24V DC at 6.25Amps continuously. Equipment of this type typically requires approximately 4.0-5.0 Amps at 24V DC, so the PSU will be used conservatively ensuring a long operational lifetime.

No routine maintenance of the PSU is required. If a fault is suspected, then the output voltage from the power supply may be measured on its output terminals. This is typically set to 24.5V.

All the PSU's used in AFL Cell Enhancers are capable of operation from either 110 or 220V nominal AC supplies. The line voltage is sensed automatically, so no adjustment or link setting is needed by the operator.

5.2.11.2 Technical Specification

| AC Input Supply: | |
|--------------------------|---|
| Voltage: | 110 or 220V nominal |
| | 90 to 132 or 180 to 264V (absolute limits) |
| Frequency: | 47 to 63Hz |
| DC Output Supply: | |
| Voltage: | 24V DC (nominal) |
| | 22 to 26V (absolute limits) |
| Current: | 6.25A |

6. INSTALLATION

6.1 Initial Installation Record

When this equipment is initially commissioned, please use the equipment set-up record sheet in Appendix A. This will help both the installation personnel and AFL should these figures be needed for future reference or diagnosis.

6.2 General

The size and weight of the wall units mean that they represent a significant health hazard unless they are mechanically installed in the correct manner. In the interests of safety this should be done before any electrical, RF, or optical connections are made.

It is important in determining the location of the wall units that space is allowed for access to the front and underneath of the equipment. To enable maintenance to be carried out, the door must be able to fully open. The location must be served with a duct to allow the entry of cables into the unit.

6.3 Electrical Connections

The mains power supply and the alarms are connected through an IP65 connector which should need no further attention once connected. It is recommended that the AC power connection is approved by a qualified electrician, who must satisfy himself that the supply will be the correct voltage and of sufficient capacity.

All electrical and RF connection should be completed and checked prior to power being applied for the first time.

6.4 Optical Connections

The optical input and output ports are be located on a bracket fixed to the lower inside of the case. The optical fibres from the tunnels enter through a cable gland on the case underside. The ports are supplied with a green plastic cover, which must be removed prior to the connection of the fibre cable. Ensure that transmitter and receiver fibre cable are identified to prevent misconnection. At the master site, the fibre transmitters are in the downlink path with the receivers in the uplink. At the remote sites the fibre transmitters are in the uplink with the receivers in the downlink. Where some of the fibre optic transmitter outputs are split with optical couplers to provide a connection to more than one remote site, care must be taken to ensure that the correct connections are made.

Ensure that connections are kept clean and are fully tightened.

| | | | |
|---|---|-------------|--------------------------|
|  Aerial Facilities Limited www.AerialFacilities.com Technical Literature | P B L Tunnel Units 1 & 2 Maintenance Handbook | | |
| | H/book Number:- 60-056100HBKMFCC | Issue No:-2 | Date:- 04/01/2006 |

6.5 RF Connections

All RF connections are made to the cable termination, located on the right-hand side of the wall enclosure. Care must be taken to ensure that the correct connections are made with particular attention made to the base station TX/RX ports. In the event that the base transmitter is connected to the RX output of the rack, damage to the equipment may be done if the base station transmitter is then keyed. If the environment where the equipment is installed is deemed to be 'wet' i.e. water seepage through roofs or walls, then suitable methods to seal the RF N type connectors should be used, for example self amalgamating sealant tape.

Ensure that connections are kept clean and are fully tightened.

6.6 Commissioning

Once all connections are made the equipment is ready for commissioning.

To commission the system the test equipment detailed in section 7.2 will be required. Using the system diagrams and the end-to-end test specification, the equipment should be tested to ensure correct operation. Typical RF levels that are not listed in the end-to-end specification, such as input levels to the fibre transmitters are detailed in the whole system diagram in section 4.

On initial power up the system alarm indicators on the door of the equipment should be checked. A red LED illuminated indicates a fault and that particular module must be investigated before proceeding with the commissioning. A green LED illuminates, to indicate that the power supply is connected and valid.

The individual fibre optic units are fitted with a pair of status indicators on their front panels. One is a green LED, which indicates that the unit is connected to a 15 Volt power supply. This indicator is common to both transmit and receive units. The second LED on the transmitter indicates that the laser is operating. On the receive unit the second LED indicates that a light signal is being received.

When all the fibre connections are completed and power to each site is connected each fibre unit should show two illuminated indicators.

In the event that any part of the system does not function correctly as expected, check all connections to ensure that they are to the correct port, that the interconnecting cables are not faulty and that they are tightened. The majority of commissioning difficulties arise from problems with the interconnecting cables and connectors.

| | | | |
|---|---|-------------|--------------------------|
|  Aerial Facilities Limited www.AerialFacilities.com Technical Literature | P B L Tunnel Units 1 & 2 Maintenance Handbook | | |
| | H/book Number:- 60-056100HBKMFCC | Issue No:-2 | Date:- 04/01/2006 |

7. MAINTENANCE

7.1 General Procedures

7.1.1 Fault Finding

In the event that the performance of the system is suspect, a methodical and logical approach to the problem will reveal the cause of the difficulty. The System consists of modules within a wall mounted, environmentally protected enclosure.

Transmissions from the main base stations are passed through the system to the mobile radio equipment; this could be a handheld walkie-talkie, mobile telephone or a transceiver in a vehicle. This path is referred to as the downlink. The return signal path from the mobile radio equipment to the base station is referred to as the uplink.

The first operation is to check the (optional) alarms of each of the active units and determine that the power supplies to the equipment are connected and active.

This can be achieved remotely (via CEMS, the digital RS232 Cell Enhancer Management System, if fitted), or locally with the front door LED's. The green LED on the front door should be illuminated, while the red alarm indicator should be off.

If an Alarm is on, then that individual module must be removed and tested against the original test specification.

The individual amplifier units have a green LED showing through a hole in their piggy-back alarm board (or directly through a hole in the amplifier lid), which is illuminated if the unit is working correctly.

If an amplifier is suspect, check the DC power supply to the unit. If no other fault is apparent use a spectrum analyser to measure the incoming signal level at the input and then after reconnecting the amplifier input, measure the output level. Consult with the system diagram and amplifier specification to determine the expected gain and compare result.

In the event that there are no alarms on and all units appear to be functioning it will be necessary to test the system in a logical manner to confirm correct operation.

| | | | |
|---|---|-------------|--------------------------|
|  Aerial Facilities Limited www.AerialFacilities.com Technical Literature | P B L Tunnel Units 1 & 2 Maintenance Handbook | | |
| | H/book Number:- 60-056100HBKMFCC | Issue No:-2 | Date:- 04/01/2006 |

7.1.2 Downlink

Confirm that there is a signal at the expected frequency and strength from the base station. If this is not present then the fault may lay outside the system. To confirm this, inject a downlink frequency signal from a known source at the master site BTS input and check for output at the remote site feeder output.

If a signal is not received at the output it will be necessary to follow the downlink path through the system to find a point at which the signal is lost. The expected downlink output for the given input can be found in the end-to-end test specification.

7.1.3 Uplink

Testing the uplink involves a similar procedure to the downlink except that the frequencies used are those transmitted by the mobile equipment.

7.1.4 Fault repair

Once a faulty component has been identified, a decision must be made on the appropriate course to carry out a repair. A competent engineer can quickly remedy typical faults such as faulty connections or cables. The exceptions to this are cable assemblies connecting bandpass filter assemblies that are manufactured to critical lengths to maintain a 50-ohm system. Care should be taken when replacing cables or connectors to ensure that items are of the correct specification. The repair of component modules such as amplifiers, tuned cavities or bandpass filters will not usually be possible in the field, as they frequently require specialist knowledge and test equipment to ensure correct operation. It is recommended that items of this type are replaced with a spare unit and the faulty unit returned to AFL for repair. If spare parts need to be ordered from AFL, be sure to quote the serial number of the Cell Enhancer/Repeater and the serial number [and frequencies] of the module(s) to be replaced.

| | | | |
|---|---|-------------|--------------------------|
|  Aerial Facilities Limited www.AerialFacilities.com Technical Literature | P B L Tunnel Units 1 & 2 Maintenance Handbook | | |
| | H/book Number:- 60-056100HBKMFCC | Issue No:-2 | Date:- 04/01/2006 |

7.1.5 Checking service

Following the repair of any part of the system it is recommended that a full end-to-end test is carried out in accordance with the test specification and that the coverage is checked by survey.

It is important to bear in mind that the system includes a radiating cable network and base stations that may be faulty or may have been damaged.

7.1.6 Service Support

Advice and assistance with maintaining and servicing this system are available by contacting Aerial Facilities Ltd.

7.2 Tools & Test Equipment

The minimum tools and test equipment needed to successfully service this AFL product are as follows:-

| | |
|----------------------|---|
| Spectrum analyser: | 100kHz to 2GHz (Dynamic range = 90dB). |
| Signal Generator: | 30MHz to 2GHz (-120dBm to 0dBm o/p level). |
| Attenuator: | 20dB, 10W, DC-2GHz, (N male – N female). |
| Test Antenna: | Yagi or dipole for operating frequency. |
| Optical Power Meter: | 1300 – 1560nm (-40 - +10dB) |
| Digital multi-meter: | Universal Volt-Ohm-Amp meter. |
| Test cable x 2: | N male – N male, 2M long RG214. |
| Test cable x 2: | SMA male – N male, 1m long RG223. |
| Hand tools: | Philips #1&2 tip screwdriver. 3mm flat bladed screwdriver. SMA spanner and torque setter. |

7.3 Care of Modules

7.3.1 General Comments

Many of the active modules contain semiconductor devices utilising MOS technology, which can be damaged by electrostatic discharge. Correct handling of such modules is mandatory to ensure their long-term reliability.

To prevent damage to a module, it must be withdrawn/inserted with care. The module may have connectors on its underside, which might not be visible to the service operative.

7.3.2 Module Removal (LNA's, general procedure):

The following *general* rules should be followed to remove a module:

- 1 Remove power to the unit
- 2 Remove all visible connectors (RF, DC & alarm)
- 3 Release module retaining screws.
- 4 Slowly but firmly, pull the module straight out of its position. Take care not to twist/turn the module during withdrawal. (When the module is loose, care may be needed, as there may be concealed connections underneath).

7.3.3 Module Replacement (general):

- 1 Carefully align the module into its location then slowly push the module directly straight into its position, taking care not to twist/turn it during insertion.
- 2 Reconnect all connectors, RF, alarm, power etc.,(concealed connectors may have to be connected first).
- 3 Replace retaining screws (if any).
- 4 Double-check all connections before applying power.

7.3.4 Power Amplifiers

- 1) Remove power to the unit. (Switch off @ mains/battery, or remove DC in connector)
- 2) Remove alarm wires from alarm screw terminal block or disconnect multi-way alarm connector.
- 3) Carefully disconnect the RF input and output coaxial connectors (usually SMA)

If alarm board removal is not required, go to step 5.

- 4) There is (usually) a plate attached to the alarm board which fixes it to the amplifier, remove its retaining screws and the alarm board can be withdrawn from the amplifier in its entirety. On certain types of amplifier the alarm board is not mounted on a dedicated mounting plate; in this case it will have to firstly be removed by unscrewing it from the mounting pillars, in most cases, the pillars will not have to be removed before lifting the amplifier.

| | | | |
|---|---|-------------|--------------------------|
|  Aerial Facilities Limited www.AerialFacilities.com Technical Literature | P B L Tunnel Units 1 & 2 Maintenance Handbook | | |
| | H/book Number:- 60-056100HBKMFCC | Issue No:-2 | Date:- 04/01/2006 |

- 5) If the amplifier to be removed has a heatsink attached, there may be several different ways it can have been assembled. The most commonly used method, is screws through the front of the heatsink to threaded screw holes (or nuts and bolts), into the amplifier within the main case. If the heatsink is mounted on the rear of the main case (e.g., against a wall in the case of wall mounted enclosures), then the fixing method for the heatsink will be from within the case, (otherwise the enclosure would have to be removed from the wall in order to remove the heatsink).

When the heatsink has been removed, the amplifier may be unscrewed from the main casing by its four corner fixings and gently withdrawn.

Fitting a new power amplifier module will be the exact reverse of the above.

Note: Do not forget to apply fresh heatsink compound to the heatsink/main case joint and also between the amplifier and the main case.

7.3.5 Low Power Amplifier Replacement

- 1 Disconnect the mains power supply and disconnect the 24V dc supply connector for the LPA.
- 2 Disconnect the RF input and output cables from the LPA.
- 3 Disconnect the alarm connector.
- 4 Remove the alarm monitoring wires from (D type connector) pins 9 and 10.
- 5 Remove the LPA module by removing the four retaining screws, replace with a new LPA module and secure it with the screws.
- 6 Connect the RF cables to the LPA input and output connectors. Reconnect the wires to the alarm board connector pins 9 and 10.
- 7 Reconnect the DC supply connector and turn the mains switch on.

Note: Tighten SMA connectors using only a dedicated SMA torque spanner. If SMA connectors are over-tightened, irreparable damage will occur. . Do not use adjustable pliers to loosen/tighten SMA connectors.

Also take care not to drop or knock the module as this can damage (or misalign in the case of tuned passive modules) sensitive internal components. Always store the modules in an environmentally friendly location

7.3.6 Module Transportation:

To maintain the operation, performance and reliability of any module it must be stored and transported correctly. Any module not installed in a whole system must be kept in an anti-static bag or container. These bags or containers are normally identified by being pink or black, and are often marked with an ESD label. Any module sent back to AFL for investigation/repair must be so protected. Please contact AFL's quality department before returning a module.

| | | | |
|---|---|-------------|------------------|
|  Aerial Facilities Limited www.AerialFacilities.com Technical Literature | P B L Tunnel Units 1 & 2 Maintenance Handbook | | |
| | H/book Number:-60-056100HBKMFCC | Issue No:-2 | Date:-04/01/2006 |

APPENDIX A INITIAL EQUIPMENT SET-UP CALCULATIONS

| GENERAL INFORMATION | | | |
|---------------------|--|--------------------------------|--|
| Site Name: | | Client Name: | |
| Date: | | AFL Equip. Model N \bar{o} . | |

| ANTENNA SYSTEMS | | | | |
|----------------------------|--------------|-------------|----------------|-----------------|
| | Model | Gain | Azimuth | Comments |
| A - Service Antenna | | | | |
| B - Donor Antenna | | | | |
| | Type | Loss | Length | Comments |
| C - Service Feeder | | | | |
| D - Donor Feeder | | | | |

| INITIAL PARAMETERS | |
|---------------------------------------|-----|
| E - CE Output Power | dBm |
| F - Antenna Isolation | dB |
| G - Input signal level from donor BTS | dBm |
| Operating Voltage | V |

| DOWNLINK CALCULATIONS | | |
|---------------------------------|----------------------|-------|
| Parameter | Comments | Value |
| Input signal level (G) | | dBm |
| CE max. o/p power (E) | | dBm |
| Gain setting | E - G | dB |
| Isolation required | (Gain + 10dB) | dB |
| Service antenna gain (A) | | dB |
| Service antenna feeder loss (C) | | dB |
| Effective radiated power (ERP) | E+A-C | dBm |
| Attenuator setting | CE gain-gain setting | dB |

If the input signal level in the uplink path is known and steady, use the following calculation table to determine the gain setting. If the CE features Automatic Gain Control the attenuator should be set to zero and if not, then the attenuation setting for both uplink and downlink should be similar.

| UPLINK CALCULATIONS | | |
|--------------------------------|------------------------|-------|
| Parameter | Comments | Value |
| Input signal level | | dBm |
| CE max. o/p power (E) | | dBm |
| Gain setting | | dB |
| Required isolation | | dB |
| Donor antenna gain (B) | | dB |
| Donor antenna feeder loss (D) | | dB |
| Effective radiated power (ERP) | E+B-D | dBm |
| Attenuator setting | (CE gain-gain setting) | dB |