

SMR 700/800 Digital Multi-Channel IP65 (NEMA 4) Band Selective Repeater

PRODUCT DESCRIPTION AND USER'S MANUAL
for AXELL D-MBR 3007-3008-PS NFPA REPEATER

UMCD00013 Rev 2.2



D-MBR 3007-3008 PS NFPA

Copyright © 2014 Axell Wireless Ltd

All rights reserved.

No part of this document may be copied, distributed, transmitted, transcribed, stored in a retrieval system, or translated into any human or computer language without the prior written permission of Axell Wireless Ltd.

The manufacturer has made every effort to ensure that the instructions contained in this document are adequate and free of errors and omissions. The manufacturer will, if necessary, explain issues which may not be covered by this document. The manufacturer's liability for any errors in the document is limited to the correction of errors and the aforementioned advisory services.

This document has been prepared to be used by professional and properly trained personnel, and the customer assumes full responsibility when using them. The manufacturer welcomes customer comments as part of the process of continual development and improvement of the documentation in the best way possible from the user's viewpoint. Please submit your comments to the nearest Axell Wireless sales representative.

Contact Information

Headquarters	Axell Wireless Aerial House Asheridge Road, Chesham Buckinghamshire HP5 2QD United Kingdom Tel: +44 1494 777000 Fax: +44 1494 777002
Commercial inquiries	info@axellwireless.com
Web site	www.axellwireless.com
Support issues	support@axellwireless.com
Technical Support Line, English speaking	+44 1494 777 747

Contact information for Axell Wireless offices in other countries can be found on our web site, www.axellwireless.com

About This Manual

This Product Manual provides the following information:

- Description of the Repeater
- Procedures for setup, configuration and checking the proper operation of the Repeater
- Maintenance and troubleshooting procedures

For whom it is Intended

This Product Manual is intended for experienced technicians and engineers. It is assumed that the customers installing, operating, and maintaining Axell Wireless Mini-Repeaters are familiar with the basic functionality of Repeaters.

Notice

Confidential - Authorized Customer Use

This document may be used in its complete form only and is solely for the use of Axell Wireless employees and authorized Axell Wireless channels or customers. The material herein is proprietary to Axell Wireless. Any unauthorized reproduction, use or disclosure of any part thereof is strictly prohibited.

All trademarks and registered trademarks are the property of their respective owners.

Disclaimer of Liability

Contents herein are current as of the date of publication. Axell Wireless reserves the right to change the contents without prior notice. The information furnished by Axell Wireless in this document is believed to be accurate and reliable. However, Axell Wireless assumes no responsibility for its use. In no event shall Axell Wireless be liable for any damage resulting from loss of data, loss of use, or loss of profits and Axell Wireless further disclaims any and all liability for indirect, incidental, special, consequential or other similes damages. This disclaimer of liability applies to all products, publications and services during and after the warranty period.

Guarantees

- **All antennas must be installed with lightning protection.** Damage to power modules, as a result of lightning are not covered by the warranty.
- **Antennas must be connected before switching on AC or DC power.** Switching power on prior to the connection of antenna cables is regarded as faulty installation procedure and therefore not covered by the Axell Wireless warranty.
- **The repeater box should be closed using the two screws.** The screws must be fully tightened. Failure to do so may affect the IP65 compliancy and therefore any warranty.

Exclusive Remedies

The remedies provided herein are the Buyer's sole and exclusive remedies. Axell Wireless shall not be viable for any direct, incidental, or consequential damages, whether based on contract, tort, or any legal theory.

Compliance with FCC

Note the following: This repeater can be operated as Part 90 Class A repeater.

FCC Part 90 Warning Statement



WARNING: This is NOT a CONSUMER device. It is designed for installation by FCC LICENCEES and QUALIFIED INSTALLERS. You must have an FCC LICENCE or express consent of an FCC Licensee to operate this device.

This is a Class B signal booster. You MUST register Class B signal boosters (as defined in 47 CFR 90.219) online at www.fcc.gov/signal-boosters/registration.

Unauthorized use may result in significant forfeiture penalties, including penalties in excess of \$100,000 for each continuing violation.

Note the following

The installation procedure must result in the signal booster complying with FCC requirements 90.219(d). In order to meet FCC requirements **90.219(d)**, it may be necessary for the installer to reduce the UL and/or DL output power for certain installations.

FCC Part 15

This device complies with part 15 of the FCC Rules. Operation is subject to the following two conditions:

1. This device may not cause harmful interference, and
2. This device must accept any interference received, including interference that may cause undesired operation.

This equipment has been tested and found to comply with the limits for a Class A digital device, pursuant to part 15 of the FCC Rules. These limits are designed to provide reasonable protection against harmful interference when the equipment is operated in a commercial environment. This equipment generates, uses, and can radiate radio frequency energy and, if not installed and used in accordance with the instruction manual, may cause harmful interference to radio communications. Operation of this equipment in a residential area is likely to cause harmful interference in which case the user will be required to correct the interference at his own expense.

FCC RF Exposure Limits

This unit complies with FCC RF exposure limits for an uncontrolled environment. This equipment can only be installed in in-building applications, driving passive or active DAS systems. All antennas must be operated at a minimum distance of 44 cm between the radiator and any person's body.

Antenna Installation

Installation of an antenna must comply with the FCC RF exposure requirements. The antenna used for this transmitter must be mounted on permanent structures.

Signal boosters must be deployed such that the radiated power of the each retransmitted channel, on the forward link and on the reverse link, does not exceed 5 Watts effective radiated power (ERP).

Therefore the max antenna gain allowed for this type of signal booster should be limited to the values given by equation (1) for the service antenna and equation (2) for the donor antenna

Equation (1) - Max SERVICE antenna gain

Max SERVICE antenna gain (dBi) = $37\text{dBm[EIRP]} - (33\text{dbi} - 10\log(N)\text{(dB)} - \text{cable loss in dB})$.

For example:

<i>No. of Antennas</i>	<i>Cable Losses</i>	<i>Max Allowed Antenna Gain</i>
4	2	$37 - (33+6-2) = 0 \text{ dBd}$
1	2	$37 - (33+0-2) = 6 \text{ dBd}$
10	2	$37 - (33+10-2) = -2\text{dBd}$

Note :0dBd = 2.15dBi

Equation (2) - Max DONOR antenna gain

Max DONOR antenna gain (dBi) = $37 - (27\text{dbi} - \text{cable losses in dbi})$.

Compliance with FCC deployment rule regarding the radiation of noise

Good engineering practice must be used in regard to the signal booster's noise radiation. Thus, the gain of the signal booster should be set so that the EIRP of the output noise from the signal booster should not exceed the level of -43 dBm in 10 kHz measurement bandwidth.

In the event that the noise level measured exceeds the aforementioned value, the signal booster gain should be decreased accordingly.

In general, the ERP of noise on a spectrum more than 1 MHz outside of the pass band should not exceed -70 dBm in a 10 kHz measurement bandwidth.

The 3308 signal booster has a noise level of -43 dBm in 10 kHz measurement at 1 MHz spectrum outside the passband of the signal booster and an *in-band* noise level at around -37 dBm in a 10 kHz bandwidth. Therefore, the noise at the antenna input port should be calculated based on equation (3).

Equation (3) - Input Noise to service antenna

Input Noise to service antenna:

$-43 \text{ dBm} + \text{Service Antenna gain} - \text{Antenna splitter losses in dBi} - \text{cable loss in dB}$

Example:

Signal booster connected to 10 service antennas with a 100m long ½ inch cable.

- Losses of such a cable with the connectors = ~ 11dB
- Gain = ~ 2 dBi

Assuming 10 service antennas: antenna splitter losses = 11 dB

Based on equation (3) Input antenna noise (to the antenna) = $-43+2-11-11=-63$ dBm

The inband input noise to the antenna should be $-37+2-11-11=-57$ dbm

NOTE: In this example you may be required in general to add an external bandpass filter that would attenuate by additional 7 dB the out of band noise.

Conclusion:

Good engineering practice requires that in general when the out of band noise measured at the service antenna input is more than -70 dbm per 10 kHz measurement bandwidth, an external band pass filter should be added to attenuate the out of band noise level.

Compliance with IC

Under Industry Canada regulations, this radio transmitter may only operate using an antenna of a type and maximum (or lesser) gain approved for the transmitter by Industry Canada. To reduce potential radio interference to other users, the antenna type and its gain should be so chosen that the equivalent isotropically radiated power (e.i.r.p.) is not more than that necessary for successful communication.

The Manufacturer's rated output power of this equipment is for single carrier operation. For situations when multiple carrier signals are present, the rating would have to be reduced by 3.5 dB, especially where the output signal is re-radiated and can cause interference to adjacent band users. This power reduction is to be by means of input power or gain reduction and not by an attenuator at the output of the device.

This equipment complies with IC RSS-102 radiation exposure limits set forth for an uncontrolled environment. This equipment should be installed and operated with minimum distance of 35 cm between the antenna and your body.

Conformément à la réglementation d'Industrie Canada, le présent émetteur radio peut fonctionner avec une antenne d'un type et d'un gain maximal (ou inférieur) approuvé pour l'émetteur par Industrie Canada. Dans le but de réduire les risques de brouillage radioélectrique à l'intention des autres utilisateurs, il faut choisir le type d'antenne et son gain de sorte que la puissance isotrope rayonnée équivalente (p.i.r.e.) ne dépasse pas l'intensité nécessaire à l'établissement d'une communication satisfaisante.

La puissance de sortie nominale indiquée par le fabricant pour cet appareil concerne son fonctionnement avec porteuse unique. Pour des appareils avec porteuses multiples, on doit réduire la valeur nominale de 3.5dB, surtout si le signal de sortie est retransmis et qu'il peut causer du brouillage aux utilisateurs de bandes adjacentes. Une telle réduction doit porter sur la puissance d'entrée ou sur le gain, et ne doit pas se faire au moyen d'un atténuateur raccordé à la sortie du dispositif.

Cet appareil est conforme aux limitations de la norme IC RSS-102 concernant l'exposition aux radiations dans un environnement non contrôlé. Cet appareil doit être installé et utilisé avec une distance minimale de 30 cm entre l'antenne et le corps de l'utilisateur.

General Safety Warnings Concerning Use of This System

Always observe standard safety precautions during installation, operation and maintenance of this product.







 Caution labels!	Throughout this manual, there are "Caution" warnings. "Caution" calls attention to a procedure or practice, which, if ignored, may result in injury or damage to the system, system component or even the user. Do not perform any procedure preceded by a "Caution" until the described conditions are fully understood and met.
 Danger: Electrical Shock	This equipment must be installed indoors only. . To prevent electrical shock when installing or modifying the system power wiring, disconnect the wiring at the power source before working with un insulated wires or terminals.
 Caution: Safety to personnel	Before installing or replacing any of the equipment, the entire manual should be read and understood. The user needs to supply the appropriate AC or DC power to the repeater. Incorrect power settings can damage the repeater and may cause injury to the user. Please be aware that the equipment may, during certain conditions become very warm and can cause minor injuries if handled without any protection, such as gloves.
 Caution: Safety to equipment	When installing, replacing or using this product, observe all safety precautions during handling and operation. Failure to comply with the following general safety precautions and with specific precautions described elsewhere in this manual violates the safety standards of the design, manufacture, and intended use of this product. Axell Wireless assumes no liability for the customer's failure to comply with these precautions. This entire manual should be read and understood before operating or maintaining the repeater.
 Warning: Restricted Access Location	Access to the Axell unit installation location is restricted to SERVICE PERSONNEL and to USERS who have been instructed on the restrictions and the required precautions to be taken.
 Attention: Electrostatic Sensitivity	Observe electrostatic precautionary procedures. ESD = Electrostatic Discharge Sensitive Device. Semiconductor transmitters and receivers provide highly reliable performance when operated in conformity with their intended design. However, a semiconductor may be damaged by an electrostatic discharge inadvertently imposed by careless handling. Static electricity can be conducted to the semiconductor chip from the centre pin of the RF input connector, and through the AC connector pins. When unpacking and otherwise handling the repeater, follow ESD precautionary procedures including use of grounded wrist straps, grounded workbench surfaces, and grounded floor mats.

Table of Contents

1	Introduction	1
1.1	Main Features	2
1.2	Repeater Model.....	3
1.3	NFPA Installation Architecture	3
1.4	Smart-ALC Function.....	4
1.5	Interfaces.....	4
1.6	Navigating the Web GUI Application.....	5
1.6.1	Topology Tree Branches	5
1.6.2	Operation Buttons	6
1.6.3	Band Pane and Tabs.....	6
1.6.4	CMU Pane and Tabs.....	7
2	Antenna Installation Requirements	8
2.1	Base (Donor) Antenna Requirements.....	8
2.1.1	Required Antenna Information	8
2.1.2	Donor Antenna Specifications	8
2.1.3	Installation Criteria.....	8
2.2	Service Antenna Requirements	9
2.2.1	Required Information.....	9
2.2.2	Indoor Antenna Installations.....	9
2.2.3	Outdoor Installations	10
3	Installing the Repeater	13
3.1	Repeater Pre-Installation Requirements	13
3.1.1	Safety Guidelines	13
3.1.2	Required BTS Information.....	13
3.1.3	Installation Location and Environment	13
3.1.4	RF Cable Installation Guidelines	14
3.1.5	Grounding Wires Requirements	14
3.2	Overview of the Installation Procedure	14
3.3	Unpacking	15
3.4	Mounting the D-MBR.....	16
3.4.1	Pre-Mounting Procedure	16
3.4.2	Installing the Mounting Bracket	17
3.4.3	Preparing Power Supply Cables	17
3.4.4	Mounting the Repeater.....	18
3.5	Grounding.....	20
3.6	Before Connecting Antennas or Powering On!.....	20
3.6.1	Verifying Isolation between Donor and Mobile Antennas	20
3.6.2	Verifying the Link between the BTS and the Repeater	21
3.7	Antenna Connections.....	21
3.8	Powering Up the D-MBR.....	22
3.8.1	Standard Power Connection	22
3.8.2	D-MBR-PS NFPA Power Connection.....	23
3.9	Alarm Connections.....	23
3.9.1	Alarm Connector Pinout	24
3.9.2	Load Restrictions.....	24
3.9.3	Summary Alarms Trigger Criteria.....	25
3.9.4	D-MBR-PS-NFPA Installation Alarm Connections	25

4	Initial Setup and Commissioning	26
4.1	Open a Session to the Repeater	26
4.1.1	Connect the Repeater to the Computer	26
4.1.2	Configure the Computer Network Parameters	26
4.1.3	Login to the Repeater	29
4.2	Configuring RF Parameters and Channels	30
4.2.1	Control Params Tab	30
4.3	Setting Date and Time.....	34
4.4	Configuring the External Alarms	35
4.5	Setting the IP Address.....	36
5	Administrative Operations	37
5.1	User Management.....	37
5.1.1	User Levels.....	37
5.1.2	Viewing the List of Defined Users	37
5.1.3	Adding Users	38
5.1.4	Editing a User	38
5.1.5	Deleting a User	38
5.2	Repeater and Band Level Information	39
5.2.1	Viewing Repeater Level Information	39
5.2.2	Viewing Band Level Info	39
5.3	Configuration Files Backup/Restore.....	40
5.3.1	The Backup/Restore Tab	41
5.3.2	Backup of Repeater Configuration	42
5.3.3	Restoring Previous Repeater Configuration.....	42
5.3.4	Uploading New Configuration File to Repeater.....	43
5.3.5	Saving Configuration File to Computer	43
5.4	CMU Software Upgrade	44
6	Monitoring and Troubleshooting.....	47
6.1	Front Panel LED.....	47
6.2	GUI Alarm Descriptions.....	48
6.3	Alarms Log	50
	Appendix A: Specifications	51

1 Introduction

D-MBR 3007-3008 PS NFPA (Digital Multi Band Repeater for Public Safety) is a high-power digital multi-channel signal booster (DCSB). It features an array of up to 12 DSP based, software-controlled, variable bandwidth filters, that are user-programmable across the 700 and 800 MHz bands.

D-MBR 3007-3008 PS NFPA supports all public safety technologies. For each filter, the user can specify the start and stop frequencies with different options varying in time delay and filter slope. This allows the engineer to trade off adjacent channel rejection and time delay interference against a wider coverage area, permitting D-MBR 3007-3008 PS NFPA usage in applications where no other booster solution will work.

Every parameter of D-MBR 3007-3008 PS NFPA, including filter tuning and selection, can be controlled via web based management. The patented Axell Wireless' digital RF filter enables simple initial setup for any channel plan and if necessary, allows some basic reconfiguration due to re-banding.

SALC-Smart ALC mechanism to protect the digital signal booster from oscillation and shutdown the signal booster when required.

With the NFPA option, this Axell product meets the rigid requirements as defined by the NFPA and International Fire Code developmental organizations. The amplifier meets NEMA4 compliance for hose-down and provides all Alarming outputs as defined by NFPA 2010, Chapter 24, including system and antenna failures.

Axell also offers the following options to meet additional code compliance needs:

- 12 or 24 hour compliant UPS back up – meets NEMA 4 and alarming requirements
- External Phone Dialer – meets NEMA 4 and allows Dial-out to paging devices when an alarm is triggered
- Outer casing is painted Fire Life Safety Red



D-MBR 3007-3008 PS **NFPA**

1.1 Main Features

- Class A or B- signal booster (based on filter setting) for SMR and public safety networks
- Supports APCO 25 phase 1 and 2 for public safety networks
- NFPA 72-2010, Chapter 24 and IFC 510.1 Compliant
- Support of 700MHz D block for LTE network
- SMR 700MHz and 800MHz bands in a single enclosure
- RF Gain: Up to 85dB Gain
- SALC-Smart ALC mechanism to protect the digital signal booster from oscillation and shutdown the signal booster when required
- Output Power per band: DL +30dBm; UL +24dBm
- Composite Output Power: DL +33dBm; UL +27dBm
- Web based management GUI, SNMP traps
- Patented DSP filtering™ technology
 - Supports up to 12 independent filters; user programmable bandwidth / frequency
 - For SMR700: Programmable 12.5 kHz to 17MHz
 - For SMR800: Programmable 12.5 kHz to 10MHz
 - User-selectable adjacent channel rejection and time delay to minimize interference
- IP65 (NEMA 4) Enclosure

1.2 Repeater Model

ORDERING INFORMATION		
Identification	Description	Part Number
D-MBR 3007-3008 PS NFPA AC	Digital Multi Channel Selective Repeater 700/800 12 channels, 30 dBm output power per band, 85 dB gain, AC powering with NFPA and IFC compliant Alarm Outputs, Red colored case	D-MBR 7/8 PS 30DBM 12 FIL NFPA RED
D-MBR 3007-3008 PS NFPA DC	Digital Multi Channel Selective Repeater 700/800 12 channels, 30 dBm output power per band, 85 dB gain, DC powering with NFPA and IFC compliant Alarm Outputs, Red colored case	D-MBR 7/8 PS 30DBM 12F NFPA DC

1.3 NFPA Installation Architecture

To meet the National Fire Protection Association (NFPA) requirements, power to the Repeater is provided via a UPS and the status of the UPS, Repeater and DAS system (antennas) is monitored via alarm connections to the Fire Department Control Box.

NOTE: An alternative to the Fire Department Control Box connections is to connect the D-MBR PS NFPA and UPS dry contact alarms to an Automatic Dialer. Axell Wireless recommends the AD-2000 Automatic Voice/Pager Dialer System.

The alarms are connected as follows:

- From the UPS - the power indicator alarms are connected directly to the Fire Department Control Box.
- From the Repeater – the Repeater status and antenna status alarms are connected to the Control Box

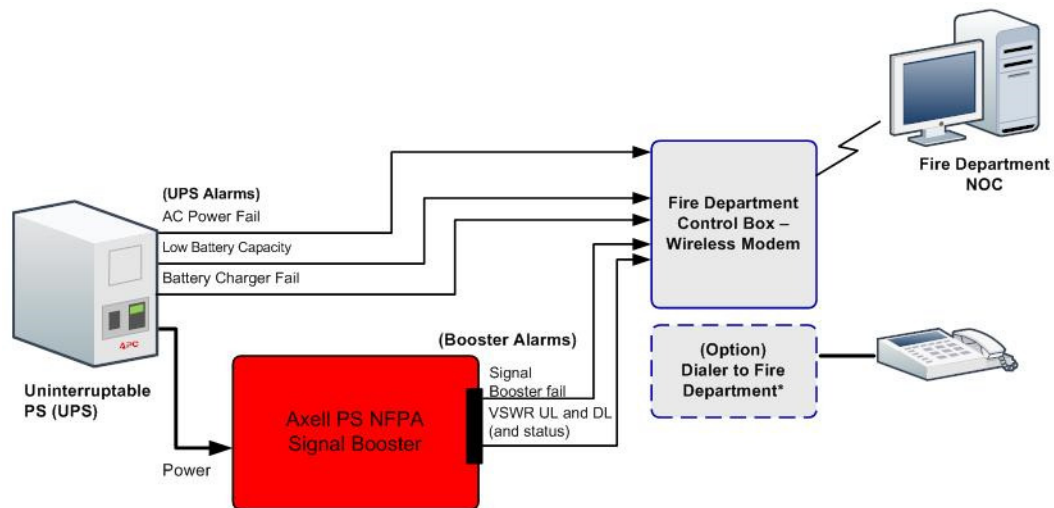

Figure 1-1. D-MBR PS NFPA Architecture

1.4 Smart-ALC Function

The Repeater's power amplifier includes power-monitoring circuits with Automatic Level Control (ALC) that prevents excessive output power while maintaining the power amplifier linearity

The Smart Automatic Level Control (Smart-ALC) is an innovative algorithm for automatic Repeater gain adjustment. Combined with advanced control algorithms, S-ALC is capable of learning the traffic load characteristics and adjusting the Repeater RF Gain to the desired value. Smart-ALC effectively reduces isolation problems.

NOTE: To reset the Repeater to its highest set gain value, disconnect the Repeater power cable for several seconds and re-connect.

1.5 Interfaces

All the Repeater interfaces are located on the units' underside panel. The following figure shows the interfaces on the D-MBR.

NOTE: The NFPA unit is colored **RED**.

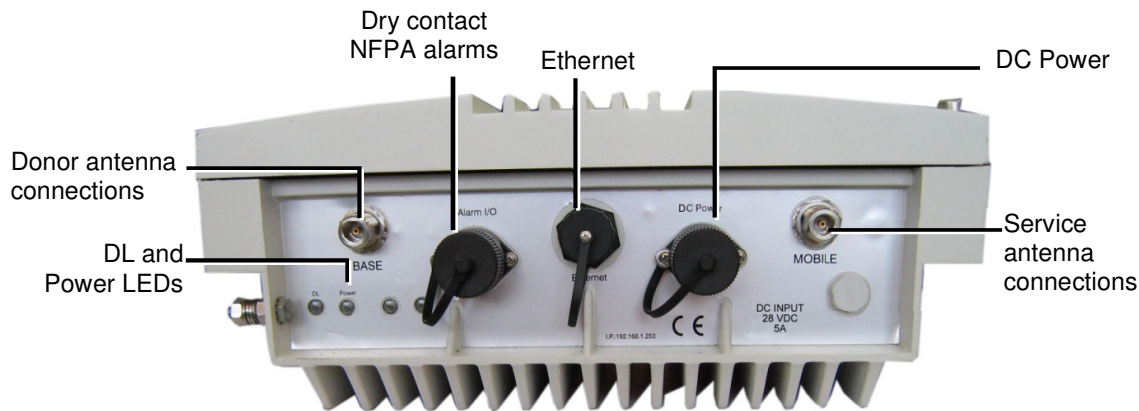

1-2. Axell D-MBR 3007-3008-PS NFPA Front Panel Interfaces

The following table provides a description of the front panel ports and connections.

Interface	Description
Base	Connection to Base (donor) side antenna
Mobile	Connection to mobile (service) side antenna
Ethernet	Connection to Ethernet devices.
Dry contact NFPA alarms	See section 3.9 for description of alarm connections.
DC Power	Model dependant: <ul style="list-style-type: none"> • Power from system AC to DC converter mounted on the wall mount bracket. Do not connect directly to any other power supply!!! • Power from system DC source.
LED	- Steady Green – Normal operation - Red or Orange - see section 6.1 Error! Reference source not found.

1.6 Navigating the Web GUI Application

This section describes how to navigate the Web Management application. The Web Access interface provides the following groups of options:

- Topology Tree – provides access to unit level and band level options
- Tabs – Band and unit (CMU) level options corresponding to the selected tree item
- Operation buttons – control and management options

The operation buttons at the top are common to all tree items and menus.

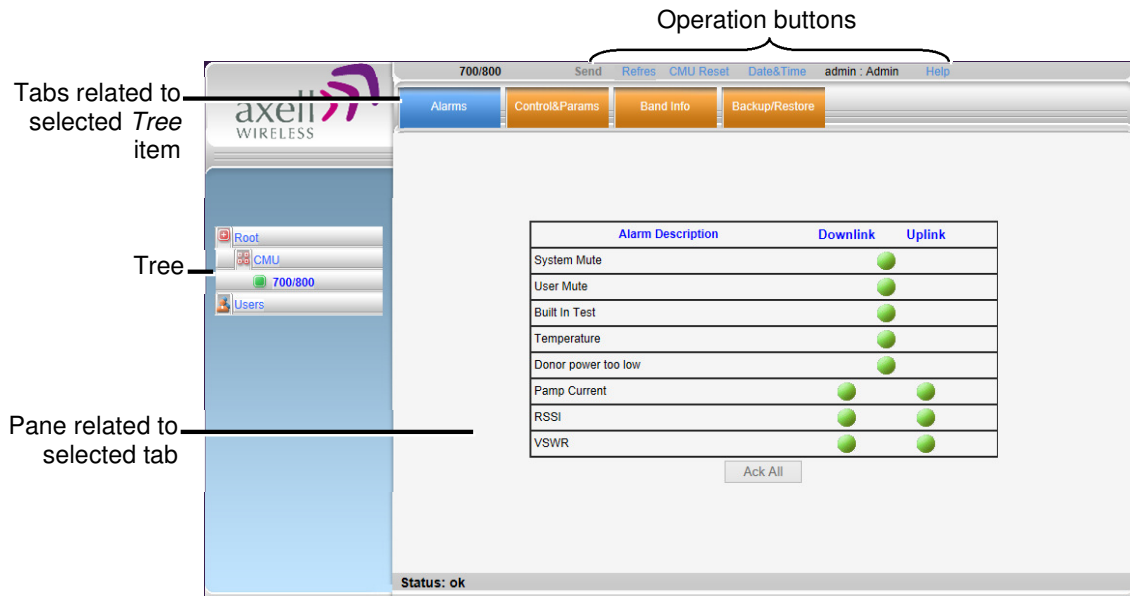

Figure 1-3. Web GUI Overview

1.6.1 Topology Tree Branches

The Topology Tree displays:

- CMU – Communication parameters
- 700/800 - Repeater configuration and monitoring options
- Users - User management options

NOTE: The items in the Tree Pane display the color of the most severe alarm.

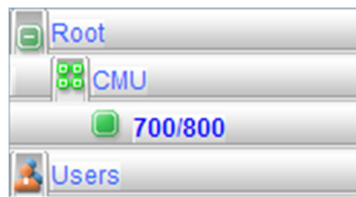

Figure 1-4. Topology Tree

1.6.2 Operation Buttons

The following Operation buttons are available.



Item	Description / Values
Send	Click to save changes – before exiting the screen; otherwise, changes will not be saved.
Refresh	Click to refresh the current screen and update the displayed data
CMU Reset	Click to reset the Web Access application. Use in case of failure or display problems
Date and Time	Used to set the Repeater clock.
Admin: Admin	Shows the current access level.
Help	Click Help to display an e-guide line for the system operation. This Help is general by its nature and some features may not be included.

1.6.3 Band Pane and Tabs

The upper area of each selected pane shows the tabs corresponding to that pane.



Item	Description / Values
Alarms	Displays various alarms generated by the Repeater and enables monitoring. See section 6.2.
Control and Params	Used for adjusting RF parameters and channel configuration (signal level, gain and bandwidth). See section 4.2.
Band Info	Shows information on the current band. See section 5.2.2
Backup and Restore	Configuration files management options (configuration files can be stored on the Repeater for access). See section 5.3.

1.6.4 CMU Pane and Tabs

CMU Topology Tree menu items.



Item	Description / Values
Axell-CMU Alarms	Shows any generated external alarms .
Axell CMU Info	Shows Repeater level information such as SW and HW versions and identification number. In addition, enables setting minimum alarm levels. See section 5.2.1
Communication Configuration	Used to set communication parameters. See section 4.5.
Alarms Log	Log of past and current alarms. See section 6.3
External Alarms	Used to define any connected external alarms. See section 4.4.
Axell-CMU SW Upgrade	Options for CMU software upgrade. See section 5.4.
Modem Direct Access	N/A

2 Antenna Installation Requirements

This chapter provides information on the specifications of the donor and service antennas suitable for operation with this repeater, on the installation requirements of the antennas and on the Repeater installation site and cable requirements.

ATTENTION!!

The BSR-3308 models described in this manual have been approved by Industry Canada to operate with the antenna types listed below with the maximum permissible gain and required antenna impedance for each antenna type indicated. Antenna types not included in this list, having a gain greater than the maximum gain indicated for that type, are strictly prohibited for use with this device.

Le présent émetteur radio (identifier le dispositif par son numéro de certification ou son numéro de modèle s'il fait partie du matériel de catégorie I) a été approuvé par Industrie Canada pour fonctionner avec les types d'antenne énumérés ci-dessous et ayant un gain admissible maximal et l'impédance requise pour chaque type d'antenne. Les types d'antenne non inclus dans cette liste, ou dont le gain est supérieur au gain maximal indiqué, sont strictement interdits pour l'exploitation de l'émetteur.

2.1 Base (Donor) Antenna Requirements

The Base (Donor) antenna is usually installed outdoors and is either a directional antenna such as a Yagi or a Panel antenna.

2.1.1 Required Antenna Information

You will require the following antenna information

- Antenna type and characteristics
- Height
- Length and type of coaxial cable required for connecting the Donor antenna to the Repeater and the attenuation.

2.1.2 Donor Antenna Specifications

- Max DONOR antenna gain (dBi) = 37 – (27dbi - cable losses in dbi).
- Very sharp beam pointed to the BTS.
- Minimum cable and jumper loss = 2dB.

2.1.3 Installation Criteria

Installation requirements:

- Verify the Donor antenna location provides a line-of-sight to the Base Station and maximum input power.
- Install the Donor Antenna at the designated height.
- Install the donor antenna at a higher level (i.e. floor) than the mobile antenna.
- Must be installed at a minimum distance of 30 cm for indoor applications from any personnel within the area.

2.2 Service Antenna Requirements

The Service antenna type depends on whether the Repeater is installed indoors or outdoors.



WARNINGS!!!

- The installer is held accountable for implementing the rules required for deployment.
- Good engineering practice must be used to avoid interference.
- Output power should be reduced to solve any IMD interference issues.

2.2.1 Required Information

The following antenna requirements, specifications and site considerations should be met:

- Type of installation – indoor only
- Service area type and size and characteristics
- Height
- Length and type of coaxial cable required for connecting the antenna to the Repeater and the attenuation.

2.2.2 Indoor Antenna Installations

2.2.2.1 Recommended Antennas

The following describes the requirements for an omni-directional mobile used for indoor applications.

Specifications:

- One or a combination of the following antennas can be used: Ceiling Mount Patch antenna, Wall Mount Patch antenna, Corner Reflector.
- Choose an antenna with high side lobe attenuation which enables maximum isolation.
- Maximum antenna gain for indoor operation 2.2dBi.
- Cable and jumper loss is at least 2dB.
- [Gain **Antenna – Cable loss**] should not exceed 0.2 dB

2.2.2.2 Installation Criteria

Installation requirements:

- An indoor antenna should be installed at a convenient location. It should be free of metallic obstruction.
- Install the Service Antenna at the designated height and tune it roughly toward the Service coverage area.
- Installation of this antenna must provide a minimum separation distance of 22cm from any personnel within the area.

2.2.3 Outdoor Installations

For applications in which the Mobile antenna is installed outdoor, the antenna type is chosen according to the available infrastructure (single-pole or horizontal installation). In addition, isolation between the donor and service antennas must be taken into account when selecting the location of the antennas.

2.2.3.1 Recommended Antennas

The antenna type depends on the installation:

- For vertical *Single Pole* installations a **high side lobe suppression antenna** is required.
- For horizontal installations either on two separate poles or on two sides of one building a **high front to back ratio antenna** is required.

Specifications:

- Maximum antenna gain for outdoor operation 8dBi.
- Cable and jumper loss is at least 2dB.
- [Gain Antenna – Cable loss] should not exceed 6dB

Installation requirements:

- Installation of this antenna must provide a minimum separation distance of 44 cm from any personnel within the area.

NOTE: The Single Pole (Vertical) and Horizontal Installations are described in sections 2.2.3.2 and 2.2.3.3.

2.2.3.2 Vertical Separation Configuration

The Vertical Separation configuration is recommended in cases where the BTS is relatively far and the service coverage area is relatively small.

In Vertical Separation configuration, the Donor antenna can be installed either above or below the Service antenna on a COMMON tower. It is required to set the distance between them to achieve maximum isolation.

The figures below illustrate the installations.

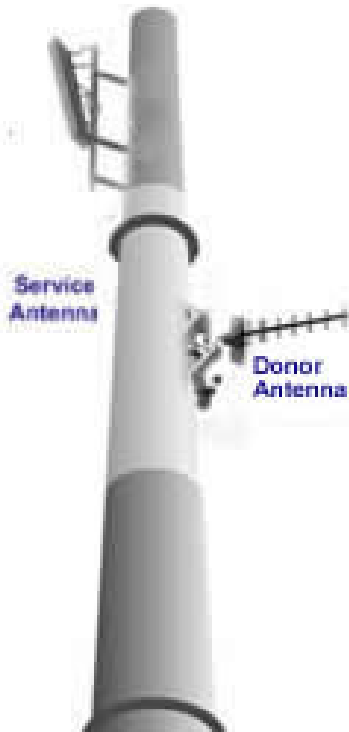

Figure 2-1. Service above Donor Antenna



Figure 2-2. Donor above Service Antenna

2.2.3.3 Horizontal Separation Configuration

In the Horizontal Separation configuration, the Donor and Service antennas are installed on two separate towers at approximately the same height. The towers can be either on the same side of the building or on different sides of the building as shown below.

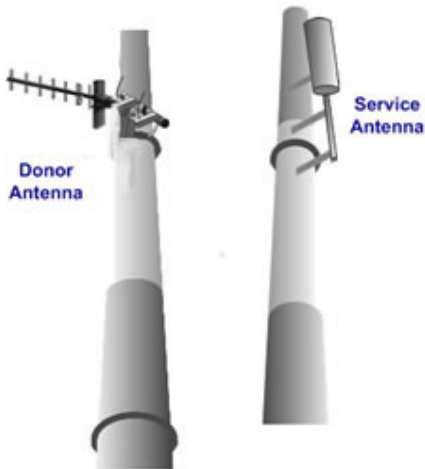

Figure 2-3. Donor and Service Antennas Installed on Separate Towers



Figure 2-4. Service and Donor Antennas Installed on Opposite Sides of the Building

3 Installing the Repeater

3.1 Repeater Pre-Installation Requirements

3.1.1 Safety Guidelines

Before installing the Repeater, review the following safety information:

- Follow all local safety regulations when installing the Repeater.
- Only qualified personnel are authorized to install and maintain the Repeater.
- Ground the Repeater with the grounding bolt located on the external lower side of the Repeater).
- Do not use the grounding bolt to connect external devices.
- Follow Electro-Static Discharge (ESD) precautions.
- Use low loss cables to connect the antennas to the Repeater.

3.1.2 Required BTS Information

Required BTS Information

- BTS channels
- BTS output power per channel
- BTS antenna gain
- BTS antenna height
- Distance from Repeater site to BTS

3.1.3 Installation Location and Environment



WARNINGS!!!

the Repeater must always be installed vertically and top-down – with the connectors on the underside for protection .
Horizontal installation on a bench for long time may cause damage to the Repeater due to over-heating.

The following criteria should be considered when selecting the Repeater installation site location:

- Application type – indoor or outdoor
- Distance from antenna site - It is recommended that the installation location be as close as possible to the antenna site in order to maintain the cable loss to a minimum.
- General surroundings and accessibility of location
- In outdoor applications it is recommended to install a cabinet or a shielding sunroof for further protection against weather wear.
- Use a suitable mounting surface, such as a flat back rigid wall.
- The Repeater is convection cooled so airflow and alternation should be possible.
- Install the Repeater in a shielded, ventilated, and easy-to-reach area – preferably at eye level.
- Ensure that adequate airflow and ventilation within the rack and around the installed components so that the safety of the equipment is not compromised.

- Verify that there is a minimum of a 50 cm (20") radius of space around the Repeater and 1 meter in depth (3 ft) in order to allow the unit door to swing completely open, enabling easy access to the Repeater for maintenance and on-site inspection.
- Follow Electro-Static Discharge (ESD) precautions.
- Install the Repeater close to the service area to monitor the output power and noise figure.
- Verify that ambient temperature of the environment does not exceed 50°C (122°F)

3.1.4 RF Cable Installation Guidelines

- For all coaxial connections to/from the Repeater - high performance, flexible, low loss 50Ω coaxial communications cable.
- All cables shall be weather-resistant type.
- Cable length - determined by the Repeater installation plan. When calculating the cable length, take into account excess cable slack so as not to limit the insertion paths.

3.1.5 Grounding Wires Requirements

Requirements for grounding wires

- Protective grounding conductor - should be aluminum with cross-section 10AWG.
- Lug of the protective grounding conductor - should be aluminum
- Washers and screw - should be high Cr stainless steel, or 12% Cr stainless steel, or Cr on, Ni on steel, tin on steel

3.2 Overview of the Installation Procedure

IMPORTANT: Be sure to perform the power supply connection last, otherwise damage may be caused to the system!

1. Select the location for the system according to the requirements described in section 3.1.3 and unpack the Repeater kit.
2. Mount the D-MBR-PS-NFPA Repeater on a (concrete or brick) wall (see 3.4).
3. Ground the Repeater (see 3.5)
4. If not yet installed, position and install the Base and Mobile antennas in the relevant locations at the site.
5. Before connecting the antennas to the Repeater:
 - Test isolation between the Base and Donor antennas.
 - Verify link between BTS and Base Repeater.
6. Connect the Donor antenna to the Repeater (see 3.7).
7. Connect the power via the UPS (see 3.8).
8. Connect the Alarms from the:
 - Repeater – see 3.9.1 for pinout
 - UPS
9. Commission the system. See Chapter 4 - Initial Setup and Commissioning.

Note: It is important to perform the installation procedure according to the order previously described. ***A standard professional toolbox is required in order to mount the Repeater.***

3.3 Unpacking

Upon receiving the D-MBR unit, perform the following:

- Examine the shipping container for damage before unpacking the unit.
- Perform a visual inspection to reveal any physical damage to the equipment.
- Verify that all of the equipment (listed below) is included (see also the following page). Otherwise contact Axell Wireless.

D-MBR PS-NFPA																												
Ethernet cable																												
CD with documentations																												
Mounting Bracket with AC to DC power converter.																												
US power plug cables (to AC outlet)																												
Additional (supplied) installation components:																												
<table border="1" style="width: 100%; border-collapse: collapse;"> <thead> <tr> <th style="width: 10%;">No.</th> <th style="width: 70%;">Description</th> <th style="width: 20%;">No.</th> </tr> </thead> <tbody> <tr> <td>1</td> <td>Flange nut, 5/16</td> <td>4</td> </tr> <tr> <td>2</td> <td>Wedge anchor, Ø 12 x 65 mm</td> <td>4</td> </tr> <tr> <td>3</td> <td>Hex washer head screw, Ø 8 mm</td> <td>4</td> </tr> <tr> <td>4</td> <td>Washer, spring, Ø 8 mm</td> <td>4</td> </tr> <tr> <td>5</td> <td>Washer, flat, Ø 8 mm</td> <td>2</td> </tr> <tr> <td>6</td> <td>Clamp</td> <td>2</td> </tr> <tr> <td>7</td> <td>Washer, flat, Ø 28 mm</td> <td>4</td> </tr> <tr> <td>8</td> <td>Screwdriver, Allen</td> <td>1</td> </tr> </tbody> </table>	No.	Description	No.	1	Flange nut, 5/16	4	2	Wedge anchor, Ø 12 x 65 mm	4	3	Hex washer head screw, Ø 8 mm	4	4	Washer, spring, Ø 8 mm	4	5	Washer, flat, Ø 8 mm	2	6	Clamp	2	7	Washer, flat, Ø 28 mm	4	8	Screwdriver, Allen	1	 <p style="text-align: center;"><i>Figure 3-1. Installation Components</i></p>
No.	Description	No.																										
1	Flange nut, 5/16	4																										
2	Wedge anchor, Ø 12 x 65 mm	4																										
3	Hex washer head screw, Ø 8 mm	4																										
4	Washer, spring, Ø 8 mm	4																										
5	Washer, flat, Ø 8 mm	2																										
6	Clamp	2																										
7	Washer, flat, Ø 28 mm	4																										
8	Screwdriver, Allen	1																										

3.4 Mounting the D-MBR

3.4.1 Pre-Mounting Procedure

1. Choose the location of the Repeater on the wall according to the following criteria:
 - The location should be at normal eye level height, above ground.
 - Be sure to allow easy access to the Repeater for maintenance and on-site inspection.
2. Place the Mounting Bracket against the wall and mark the *four* holes to be drilled at the extreme four corners of the bracket (additional optional installation holes are also provided).
3. Drill four holes 12mm in diameter and 65mm in depth.

The following illustration shows the bracket with the bracket pins.

NOTE: The NFPA bracket *may* be colored **RED**.

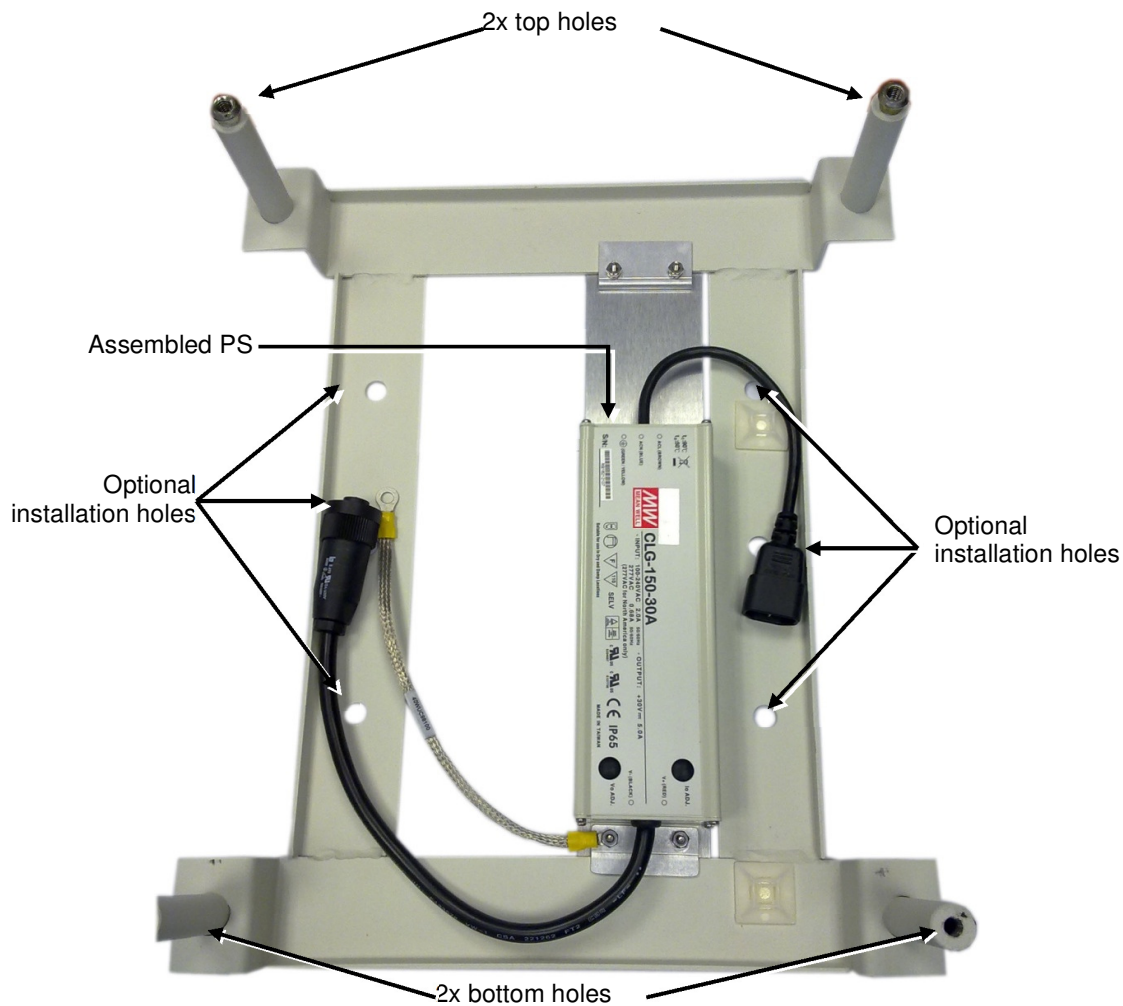

Figure 3-2. D-MBR 3007-3008-PS-NFPA Mounting Holes and Pins

3.4.2 Installing the Mounting Bracket

To install the mounting bracket

1. Insert the four wedge anchors (see item no. 2 in Figure 3-1) into the drilled holes and secure them with an adjustable wrench.
2. Remove the hex nut, spring washer and flat washer from each wedge anchor, revealing a screw from each anchor.
3. Insert a flat washer 28mm in diameter in each of the anchors (see item 7 in Figure 3-1).
4. Fit the support bracket on to the anchors and secure with the flat washers, spring washers and hex nuts removed in Step 2.
5. Verify that the bracket is firmly mounted.

3.4.3 Preparing Power Supply Cables

1. Secure the AC/DC Converter power cable (with kettle socket) to the mounting bracket using one of the supplied cable ties.
2. Connect the provided AC plug cable (EURO/UK) to the power supply kettle socket, routing it to the bottom of the bracket, and secure with supplied cable tie.
3. **DO NOT** connect the AC or DC power cables at this stage – wait until instructed to do so.

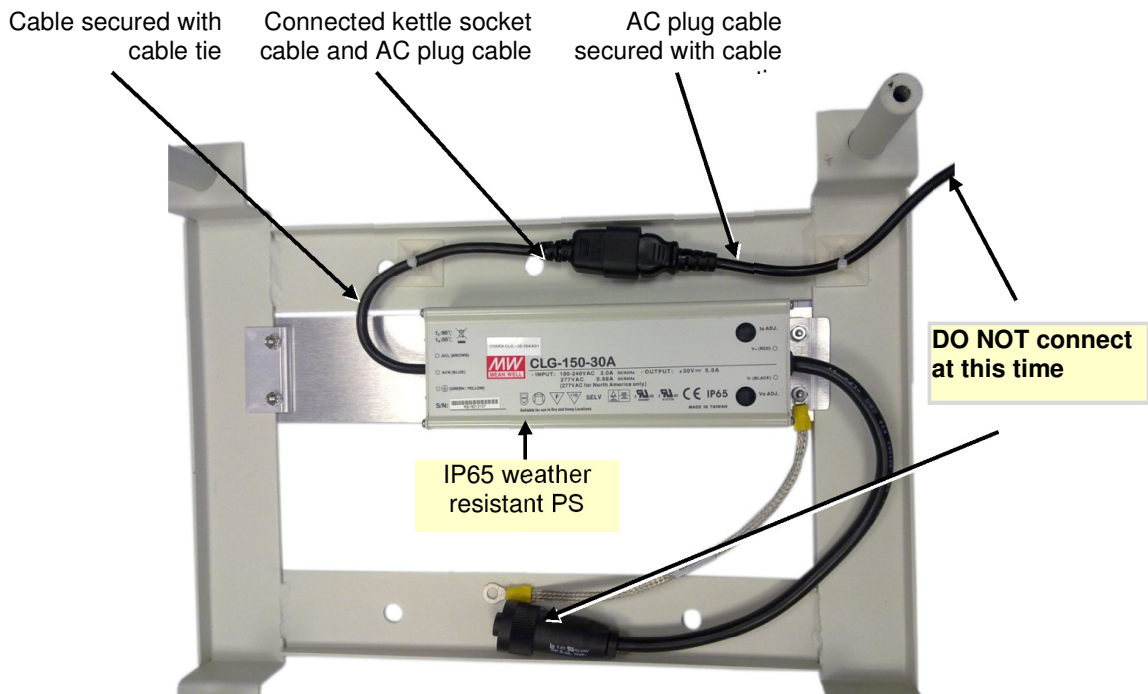

Figure 3-3. D-MBR 3007-3008-PS-NFPA Cables

3.4.4 Mounting the Repeater

1. Pick up the Repeater and align the Repeaters' four installation holes with the Mounting Brackets' pins.
2. Slide the brackets pins through the Repeater holes until the upper side is locked with the installation head nuts at the top of the bracket. See Figure 3-5.
3. Release the four captive screws locking the Repeater cover.

NOTE: The NFPA unit is colored **RED**.

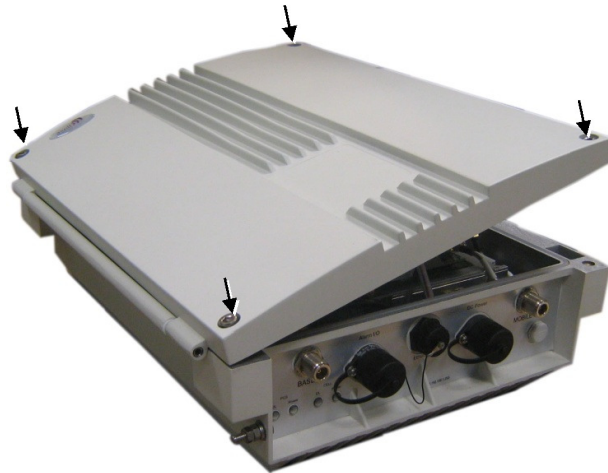

Figure 3-4. Loosen Captive Screws and Swing Open Door

4. Swing the top cover open.

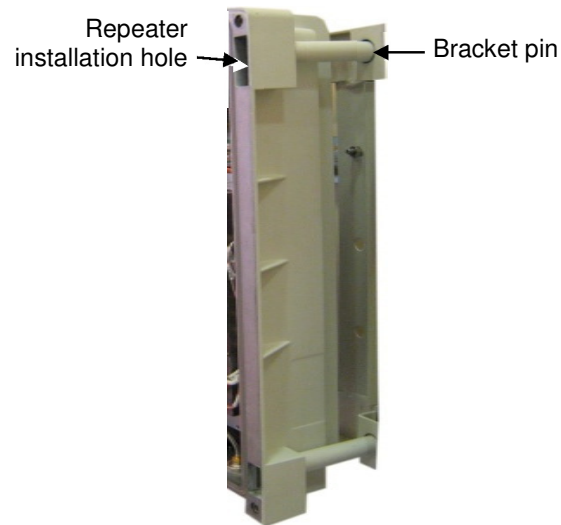

Figure 3-5. D-MBR 3007-3008-PS-NFPA Mounted on Support Bracket

5. Set both clamps with a hex washer head screw (item 3 in Figure 3-1).

6. Insert the clamps including the screws in to the upper orifices leading inside the Repeater.

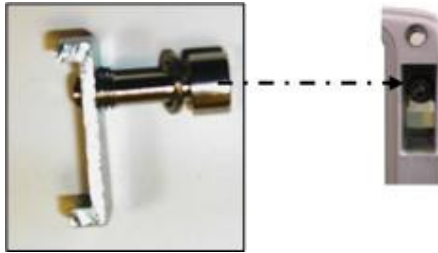

Figure 3-6. Locking Clamp

7. Using the Allen screwdriver (item 8 in Figure 3-1), tighten the hex screw of the clamp.
8. Insert two hex washer head screws (item 3 in Figure 3-1) including spring washers (item 4 in Figure 3-1) into the lower orifices of leading inside the Repeater.

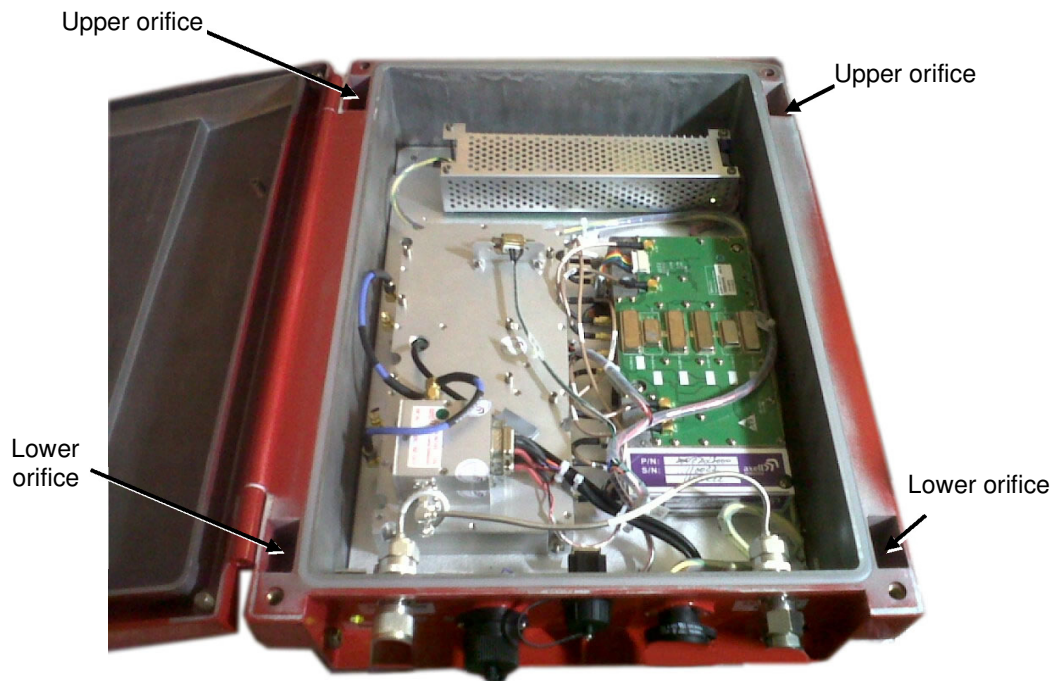

Figure 3-7. Locking Clamp Locations

9. Use the Allen screwdriver (8 in Figure 3-1) to tighten the hex screws.
10. Verify that the Repeater is firmly mounted.
11. Close the Repeater cover. Do not lock yet since you will need to open it to perform the Local setup procedure.

3.5 Grounding

NOTE: Refer to section 3.1.5 for the grounding requirements.



WARNINGS!!! Do not use the grounding bolt to connect external devices.

To ground repeater

Connect main ground to Repeater grounding lug at the *side* of the repeater.

NOTE: The NFPA unit is colored **RED**.



Figure 3-8. Grounding Lug Location

3.6 Before Connecting Antennas or Powering On!



WARNING!

Perform this procedure before connecting the antennas to the Repeater or powering on the Repeater.

The Repeater should not be operated prior to the verification of the operating parameter in its installation environment

3.6.1 Verifying Isolation between Donor and Mobile Antennas

The isolation between the Base/Donor and Mobile/Service antennas is critical especially for high gain, outdoor applications.

- For proper operation of the Repeater, it is recommended that the isolation between the Donor and Service antennas be at least 16dB higher than the Repeaters set gain.
- Insure proper vertical or horizontal distance separation between Donor and Service antennas

NOTE: Lower isolation can lead to high in-band ripple, oscillations and low signal quality.

To measure the isolation, proceed as follows:

1. Inject a known signal from a signal generator into one antenna (preferably the Donor antenna).
2. Measure the coupled output from the Service antenna, using the Spectrum analyzer and LNA if applicable.
3. Perform this procedure across the frequency range of both the Uplink and Downlink bands.
4. Register the lower result for system operation.

3.6.2 Verifying the Link between the BTS and the Repeater

This test checks the signal strength from the BTS antenna to the Repeater.

Proceed as follows:

1. Using a Spectrum analyzer, measure the received signal from BTS at the Donor antenna port near the Repeater.
2. Adjust the Donor antenna direction to receive the maximum signal strength.
3. Compare the received signal strength with the calculated signal strength from the design phase.
 - In case of discrepancy, check for one of the following:
 - Antenna out of direction
 - Antenna tuned to side lobe instead of main lobe
 - Antenna connector or antenna cable faulty
 - Line-of-sight problem (obstruction), etc.
 - Register the signal strength of the downlink channel. for the system operation phase.

3.7 Antenna Connections



WARNING!

Do not connect the antenna cables to the Repeater before verifying the installation parameters - specifically the isolation between the antennas.

DO NOT POWER-ON the Repeater without either the antennas being connected or the antenna connections terminated with dummy loads

NOTE: If the coaxial cables are NOT weather-resistant type, wrap the exterior coaxial cables with insulation and holding tape (Type 3M Rubber splicing tape) for environmental protection and to ensure longer lifetime.

To connect the antennas to the Repeater

1. Install the antenna cables along their path to the Repeater, and connect them to the Antennas.

Note: Be sure to use low loss cables.

2. Connect the **Donor antenna** to the **Repeater BASE port**. (Donor antenna specifications and installation criteria are described in section 2.1).
3. Connect the **Service Antenna** to the **Repeater MOBILE port**. (Mobile antenna specifications and installation criteria are described in section 2.2).
4. Verify all RF connectors are tightened and the cables and antennas are secured.

3.8 Powering Up the D-MBR

NOTE: The Repeater is connected to power via the assembled AC/DC power supply.



WARNING!

This equipment can either be installed indoors or outdoors.

When installing outdoors - Wet conditions increase the potential for electric shock when installing or using electrically powered equipment.

To prevent electrical shock when installing or modifying the system power wiring, disconnect the wiring at the power source before working with un-insulated wires or terminals.

3.8.1 Standard Power Connection

Power-on the Repeater by:

- Connecting the cable from the **AC/DC converter** to the front panel **DC Power port**.
- Connecting the **AC/DC converter power** cable to the **AC outlet**.



Figure 3-9. DC Power Input Connection Location

3.8.2 D-MBR-PS NFPA Power Connection

NOTE: D-MBR 3007-3008-PS NFPA Repeaters may be (if required) connected to the power source via a UPS.

1. Locate the AC power outlet, with at least a 6A slow blow fuse.
2. Connect a 110/220 VAC power source to the UPS and the UPS to the AC/DC converter power cable.
3. You may now connect the **UPS alarms to the Fire Department Control Box** according to the instructions in the UPS Installation Guide provided with the UPS unit.

NOTE: During the Power Up process the CPU requires approximately four minutes to boot up.
NOTE: The NFPA unit is colored **RED**.

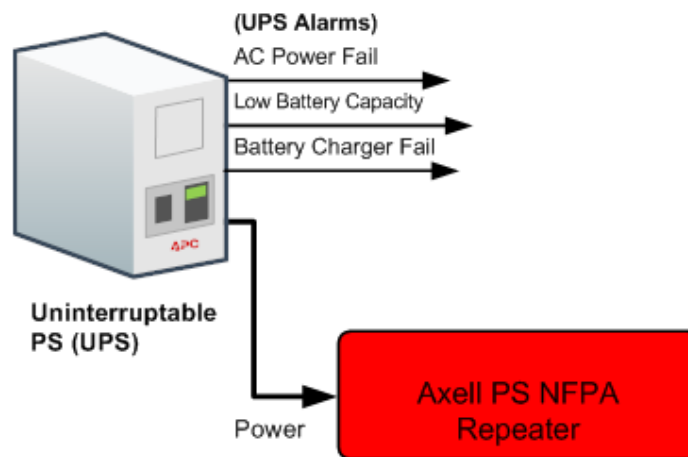

Figure 3-10. NFPA Power Connections

3.9 Alarm Connections

Notes: The alarms can be connected at any time, before or after the system is powered-on.
For an illustration of NFPA connections, see section 3.9.4.

The Repeaters' front panel Alarm connector provides two types of alarm connections:

- **External (Input) Alarms** - connected to external sources such as Repeater Door .

NOTE: External alarms are configured via the CMU/**External Alarms** tab (section 4.4) and monitored via the CMU/Axell-CMU-Alarms tab.

- **Dry Contact (Output) Alarms** - two dry-contact *Normally Closed* output alarms are available: VSWR and Summary alarms.

This section provides the following information:

- Alarms connector pinout
- Load restrictions
- Summary alarm trigger criteria
- Summary alarm connections

3.9.1 Alarm Connector Pinout

Each alarm status is recognized by a separate wire-pair, where the colored wires are internally connected with a 4.7 K ohm resistor (serves as a pull up resistor to +5V. The following figure shows the Alarm connector pinout.

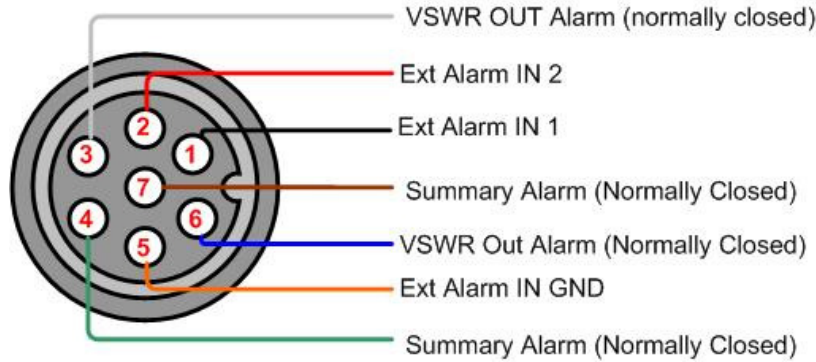

Figure 3-11. Alarm Connector Pinout

Pin No.	Signal Name	Wire Color
1	External Alarm #1	Black
2	External Alarm #2	Red
3	Dry Contact VSWR Alarm (Normally Closed)*	White
4	Dry Contact Summary Alarm (Normally Closed)** Triggered under one of the following conditions: <ul style="list-style-type: none"> • PA Current from FF • Temperature High or Built in Test • Power Failure 	Green
5	GND for External Alarm	Orange
6	Dry Contact Antenna Malfunction (VSWR) Alarm (Normally Closed)*	Blue
7	Dry Contact Summary Alarm (Normally Closed)**	Brown

*Dry Contact VSWR alarm connection is supported by a pair of wires (3,6).

** Dry Contact Summary alarm connection is supported by a pair of wires (4,7)

3.9.2 Load Restrictions

3.9.2.1 Alarm Dry Contact Output Restrictions

- Maximum switching voltage: 220 VDC, 125 VAC
- Maximum switching current: 2A

3.9.2.2 External Alarm Input Restrictions

- Maximum repetitive reverse voltage: 28 V
- Impedance load: 470 Ohm
- To activate the alarm: verify it is configured to operate normally in LOW (section 4.4), where low is short to GND.

3.9.3 Summary Alarms Trigger Criteria

The Summary alarm (pins 4 and 7) is triggered under one (or more) of the following:

- PA Current from FF
- Temperature High
- Built-in Test

The summary alarm pins respond as follows:

STATUS	External Alarm on USER connector	RESULT
Power OFF	Contacts 4,7 OPEN	ALARM
Power ON	Contacts 4,7 CLOSE	NO ALARM
Summary ALARM Active	Contacts 4,7 OPEN	ALARM

3.9.4 D-MBR-PS-NFPA Installation Alarm Connections

The Repeater Alarm connector contains two sets of dry contact alarms that are connected to the Fire Department Control Box (see section 3.9.1 above).

- VSWR (Pins 3,6)
- Summary (Pins 4,7)

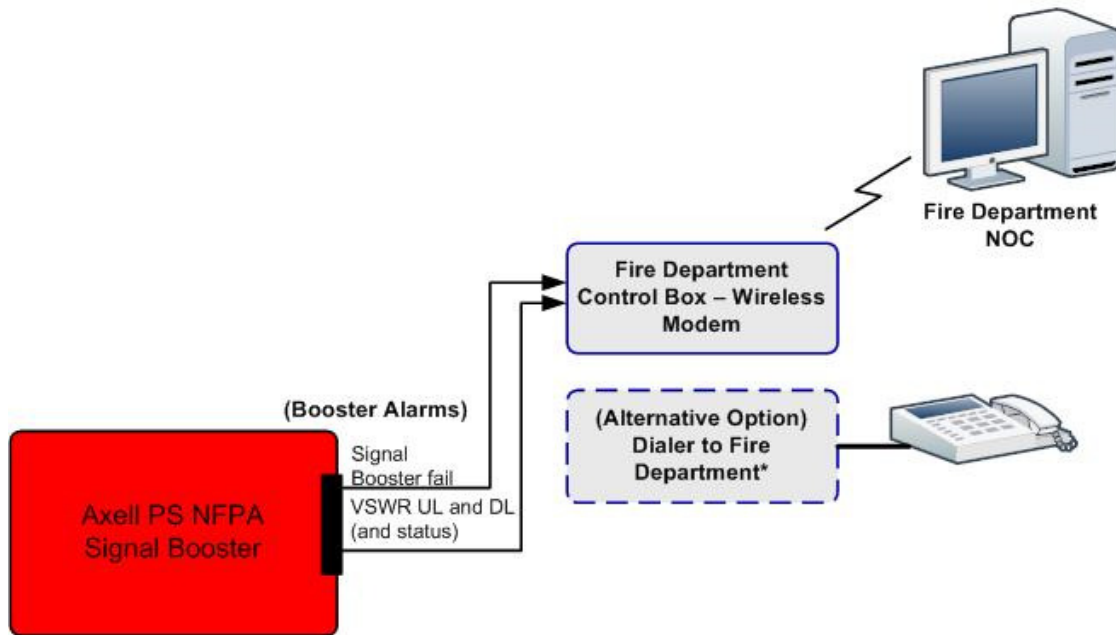

Figure 3-12. D-MBR PS NFPA Architecture

4 Initial Setup and Commissioning

This section describes the setup procedures for the D-MBR PS Repeater. The initial setup procedure is performed through a Web connection from a computer on the *same subnet*, using a cross-over Ethernet cable (supplied).

The setup procedure consists of the following steps:

1. Open a local Web session to the Repeater (this requires configuring the communication parameters of the computer used).
2. If you are not familiar with the Axell Web Access application, we suggest you quickly review the section on Navigating the Web GUI Application. It is only a couple of pages and you will find it useful.
3. Define the **Global Settings** for each of the supported bands, and determine the number of filters assigned to each band.
4. Enable and configure the relevant channels (Filter Switch tab).
5. Verify that no Alarms are generated.
6. Set the Repeater time and date.
7. Configure the external alarms.
8. (If relevant), configure the System IP Address.

4.1 Open a Session to the Repeater

4.1.1 Connect the Repeater to the Computer

To open connect the Repeater to the Computer

Connect the Ethernet cable (supplied) between the front panel **Ethernet** port (see figure below) and the computer Ethernet port.

Note: When performing a local connection, use the supplied Ethernet cross-cable (PN: 1579909499).

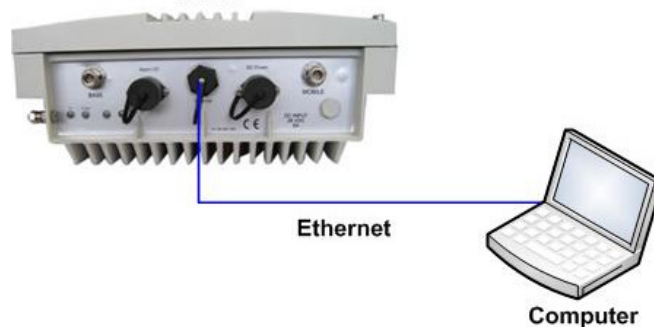

Figure 4-1. Connect Computer to Repeater via Ethernet

4.1.2 Configure the Computer Network Parameters

Configure the computer network parameters to communicate with the Repeater. Note that the procedure may vary slightly depending on the operating system installed on your computer. The following procedure is for Windows 7 OS.

To configure the computer's network parameters:

1. Click the **Start** menu and choose **Control Panel**.
2. In the Control Panel, click Network and Internet Connections.
3. Click Network and Sharing Center and then click Local Area Connection.

The **Local Area Connections Status** dialog appears with the General tab displayed by default.

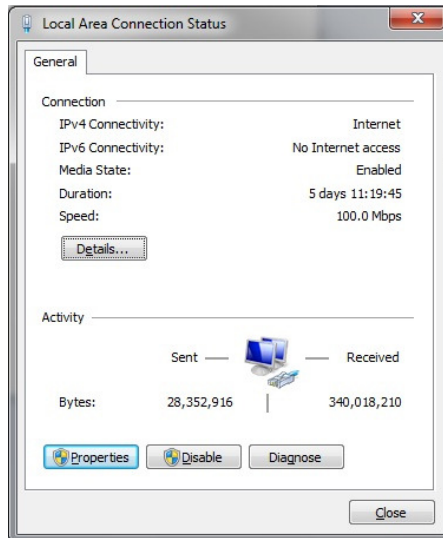

4. Click the **Properties** button in the displayed **Local Area Connection Status** dialog.

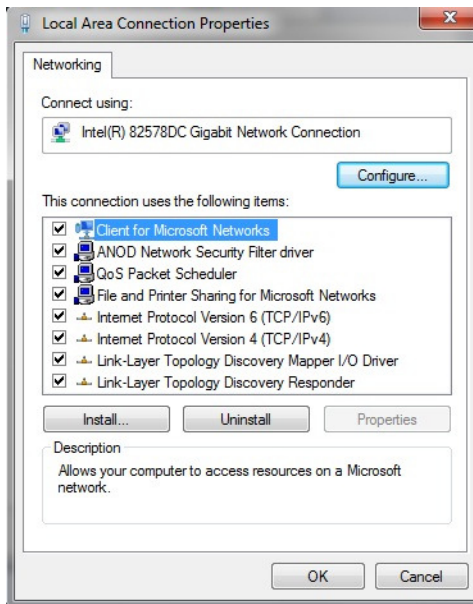

5. In the Items list, double-click Internet Protocol Version 4 (TCP*IPv4) item. The **Internet Protocol Version 4 (TCP/IPv4) Properties** dialog appears.

Note: The Repeater is supplied with the default IP address 192.168.1.253.

6. Assign your computer an IP address in the same subnet, in order to communicate with the unit.
 - In the IP address area:
 - Enter the IP address 192.168.1.x, where 'x' can be any number between 2 and 250 inclusive. For example, (192.168.1.9)
 - Define the subnet mask as shown (255.255.255.0)

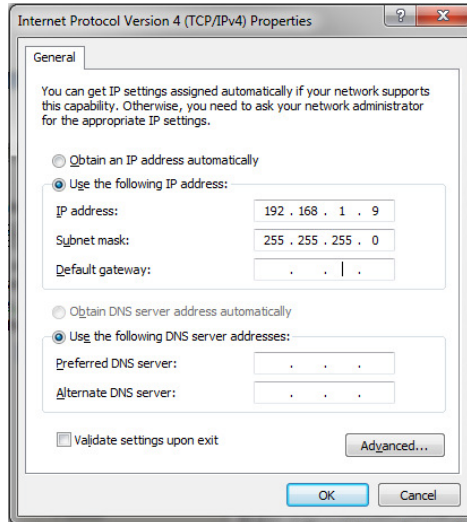

- Click **OK**. The computer communication parameters are now defined and you can open a session to the Repeater.

4.1.3 Login to the Repeater

NOTE: The Repeater is factory assigned the address 192.168.1.253. You will login for the first time using this address and make the necessary modifications according to information provided by your network administrator.

To login to the Repeater

1. Open a standard Flash-enabled browser (e.g. Explorer).
2. In the address line, enter the default (provided) IP address of the Repeater. A session will be established with the Repeater and the login dialog will appear.

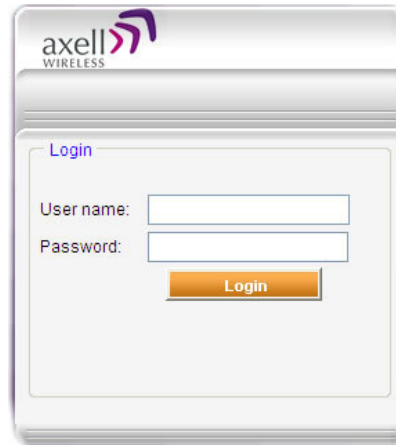

Figure 4-2. Login Prompt

3. Type the default User Name **admin** and the default Password **admin**

Note: Both User name and Password are case sensitive and must be entered with lower case letters.

4. Click **Login**. The application main window appears.

4.2 Configuring RF Parameters and Channels

The gain range is up to 85dB for *all bands* and is set by default to its maximum value of 85dB.

NOTE: The gain will then be modified automatically to its optimum value by the SALC mechanism. This mechanism performs gradual learning of traffic load characteristics and adjusts the Repeater RF Gain accordingly. (See section 1.4 for more information on the SALC mechanism).

The following filter selection options are available:

NOTE: The available filter selection options can be viewed in the Band Info tab (section 5.2.2).

- Narrowband filters: 12.5 to 1,000 kHz (in 12.5KHz steps)
- Wideband filters: 200 to 20,000KHz (in 200KHz steps)
- 5MHz filters: 5,000KHz

4.2.1 Control Params Tab

You can define up to 12 filters according to their bandwidth, power, gain and gain-delta (used for noise control). The defined filters are graphically displayed in the lower part of the screen.

To configure the signal level and channels

1. In the topology tree, click **Root** and then **700/800**.
2. Click the **Control&Params** tab. The displayed window is divided into two main areas:
 - System – overall parameters for the *selected service*.
 - Sub-band (filter) definitions – used to define up to 12 sub-bands and their RF parameters.
 - Sub-bands view – graphical display of defined sub-bands for the service.

The screenshot shows the 'Control&Params' tab for the 700/800 band. It includes a system parameter section, a table of 12 filters, and a graphical view of sub-band allocation.

Global RF parameters (indicated by a red arrow):

- System: RF Transmission Enable (checked), Shut Down Mechanism (checked), Temperature (102F / 39C), DL Output Threshold Delta [dB] (30), Meas. Composite DL Output Power [dBm] (1).
- Max Composite DL Output Power [dBm]: 33
- Max Composite UL Output Power [dBm]: 27

Define up to 12 filters (indicated by a red arrow):

Filter	On	BW	Downlink						Uplink				
			Start Freq [MHz]	Stop Freq [MHz]	Set Ch Max Power	Set Ch Max Gain	Meas RSSI [dBm]	Meas Ch Gain [dB]	Meas.Ch Power [dBm]	Start Freq [MHz]	Stop Freq [MHz]	Gain Δ [dB]	Meas.Ch Gain [dB]
1	✓	12.5K (N)	773.9625	773.975	21	85	-120	85	-35	803.9625	803.975	0	85
2	✓	12.5K (N)	773.65	773.6625	21	85	-119	85	-34	803.65	803.6625	0	85
3	✓	12.5K (N)	773.2375	773.25	21	85	-121	85	-36	803.2375	803.25	0	85
4	✓	12.5K (N)	772.8	772.8125	21	85	-119	85	-34	802.8	802.8125	0	85
5	✓	12.5K (N)	772.425	772.4375	21	85	-120	85	-35	802.425	802.4375	0	85
6	✓	12.5K (N)	772.2625	772.275	21	85	-120	85	-35	802.2625	802.275	0	85
7	✓	12.5K (N)	772.075	772.0875	21	85	-120	85	-35	802.075	802.0875	0	85
8	✓	12.5K (N)	771.9125	771.925	21	85	-119	85	-34	801.9125	801.925	0	85

Graphical view of defined filters (indicated by a red arrow):

The graphical view shows sub-band allocation for UL 788-806 and DL 758-861. It includes a status bar at the bottom indicating 'Status: ok' and '700MHz filters' and '800MHz filters'.

Figure 4-3. Sub-band Allocation Configuration

3. Set the System Level parameters:

System			
RF Transmission Enable	<input checked="" type="checkbox"/>	Temperature	102F 39C
Shut Down Mechanism	<input checked="" type="checkbox"/>	DL Output Threshold Delta [dB]	30
Max Composite DL Output Power [dBm]	33	Meas. Composite DL Output Power [dBm]	1
Max Composite UL Output Power [dBm]	27		

- **RF Transmission Enable** – disables and enables unit RF transmission. Verify that it is checked (RF transmission ON).

NOTE: RF transmission can be disabled by the system if the Shut Down mechanism is enabled and the criteria activated the mechanism is fulfilled.

- **Shut Down Mechanism** – when enabled, the system automatically disables RF transmission if an excessively high input power (from the BTS side) is detected. The shut down criteria is valid only after a specific period of time that valid input power level is exceeded. In that case:
 - **RF Transmission Parameter** is unchecked (transmission is OFF)
 - **System Mute** alarm (Alarms tab) is generated (RED).

NOTE: If the high input power issue is resolved, then it is necessary to enable RF transmission by checkmarking the **RF Transmission Enable** parameter. In addition, reset the **System Mute** alarm (click Ack).

- **Max Composite DL Output Power** – set according to your site requirements and click **Send**. The **Measured Composite DL Output Power** is displayed in the adjacent field. If the composite output power exceeds the defined value, the Smart-ALC feature begins working.
- Set the **Max Composite UL Output Power** according to your site requirements.

NOTE: The Temperature shows the Repeater's ambient temperature. The **DL Output Threshold Delta (dB)** shows the delta from DL Output Power, below which the alarm 'Donor power is too low' is activated.

4. Checkmark **ON** for each filter to be configured. The configuration parameters in that row will be available.

			Downlink Channels							Uplink Channels			
Filter	On	BW	Downlink							Uplink			
			Start Freq [MHz]	Stop Freq [MHz]	Set Ch. Max Power	Set Ch. Max Gain	Meas. RSSI [dBm]	Meas. Ch. Gain [dB]	Meas. Ch. Power [dBm]	Start Freq [MHz]	Stop Freq [MHz]	Gain Δ [dB]	Meas. Ch. Gain [dB]
1	<input type="checkbox"/>	12.5K (N)	773.9625	773.975	28	85	49	-128	-128	803.9625	803.975	0	-128
2	<input type="checkbox"/>	12.5K (N)	773.65	773.6625	22	85	50	-128	-128	803.65	803.6625	0	-128
3	<input type="checkbox"/>	12.5K (N)	773.2375	773.25	21	85	77	-128	-128	803.2375	803.25	0	-128
4	<input type="checkbox"/>	12.5K (N)	772.8	772.8125	22	85	72	-128	-128	802.8	802.8125	0	-128
5	<input type="checkbox"/>	12.5K (N)	772.425	772.4375	21	85	122	-128	-128	802.425	802.4375	0	-128
6	<input type="checkbox"/>	12.5K (N)	772.2625	772.275	21	85	32	-128	-128	802.2625	802.275	0	-128
7	<input type="checkbox"/>	12.5K (N)	772.075	772.0875	21	85	0	-128	-128	802.075	802.0875	0	-128
8	<input type="checkbox"/>	12.5K (N)	771.9125	771.925	21	85	0	-128	-128	801.9125	801.925	0	-128

5. Define the Downlink Channels:

- Set the **Start** and **Stop** DL Frequency (MHz). (The Uplink Start and Stop frequencies will be automatically allocated.)
- Sub-band resolutions ranging between 200KHz and 1MHz can be allocated to a *narrowband* or *wideband* filter. In this case, you will be prompted to select the filter type

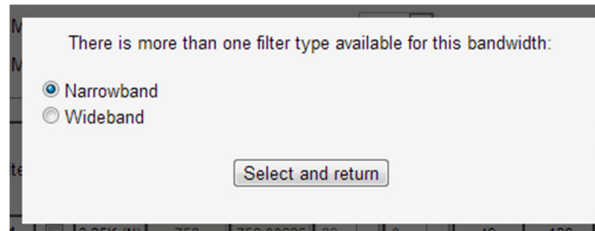

- Select the filter type and click **Select and Return**.
- Click **Send** at the top of the screen.
- Set **Max Gain**: change the default value (maximum) according to the measured/calculated input power and isolation measurements.

More information on DL sub-band parameters:

- DL Set Ch. Max. Gain - Sets the power for the antennas. Recommended Maximum Gain setting is approximately 16 dB less than the isolation between the service and donor antennas.
- DL Measured RSSI - measured DL signal.
- DL Measured Ch. Gain - measured DL Gain (dB) for the selected sub-band.
- DL Measured Ch. Power - measured Power (dBm) for the selected sub-band.

6. Set the Uplink parameters:

NOTE: The uplink channels are automatically allocated according to the downlink channel definitions.

If the site NOISE LEVEL causes interference, adjust the noise level as follows:

- Adjust the Gain Delta parameter – this sets the delta between the uplink and downlink gain (so the uplink gain is relatively lower than the downlink gain).
- Click **Send**.
- Repeat the procedure until the desired coverage is achieved.

More information on DL sub-band parameters:

- UL Gain Δ - used for noise control. Sets the difference between UL and DL gain.
- UL Measured Ch. Gain - measured UL Gain (dB) for the selected sub-band.

7. Click **Send** (top window area option).

8. After the channels have been configured and the required coverage is attained for the location, verify that no Alarms are generated:
 - Click the **Alarms** tab
 - Verify that all the indicators are GREEN in the Alarms tab



Figure 4-4. Alarms Dialog

4.3 Setting Date and Time

It is important to set the correct date and time on the unit since this provides the timestamp for each logged event and alarm.

To set the Repeaters date and time

1. Click on **CMU** in the tree pane.
2. Click on **Date & Time** in the menu bar.

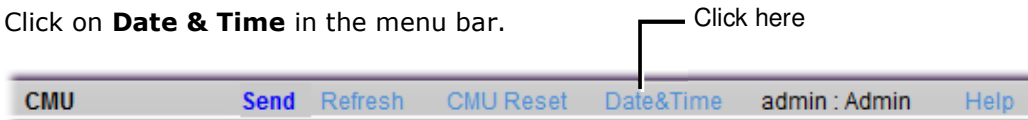

The following dialog appears.

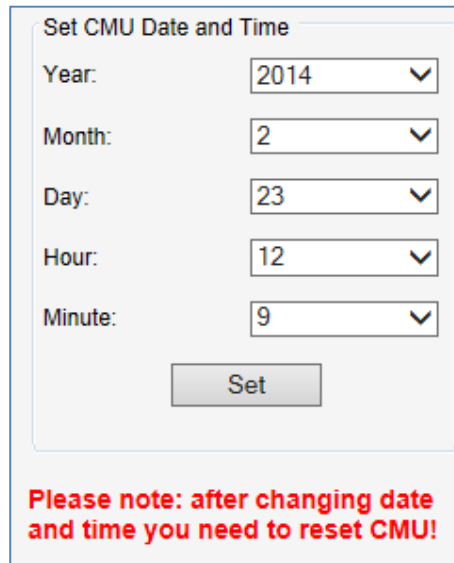

The dialog box is titled 'Set CMU Date and Time'. It contains five dropdown menus for 'Year', 'Month', 'Day', 'Hour', and 'Minute'. The values are 2014, 2, 23, 12, and 9 respectively. Below the dropdowns is a 'Set' button. At the bottom of the dialog, there is a red text note: 'Please note: after changing date and time you need to reset CMU!'.

Figure 4-5. Date & Time Settings Dialog

3. Set the date and time parameters and click on **Set** in the dialog and then **Send** at the top of the screen
4. Click the **CMU Reset** button in the main menu (shown above).

4.4 Configuring the External Alarms

Any connected *external* alarms (section 3.9) must be enabled and configured according to the instructions provided in this section.

To configure external alarms

1. Click on **CMU** in the tree pane and select the **External Alarms** tab. The following dialog appears.

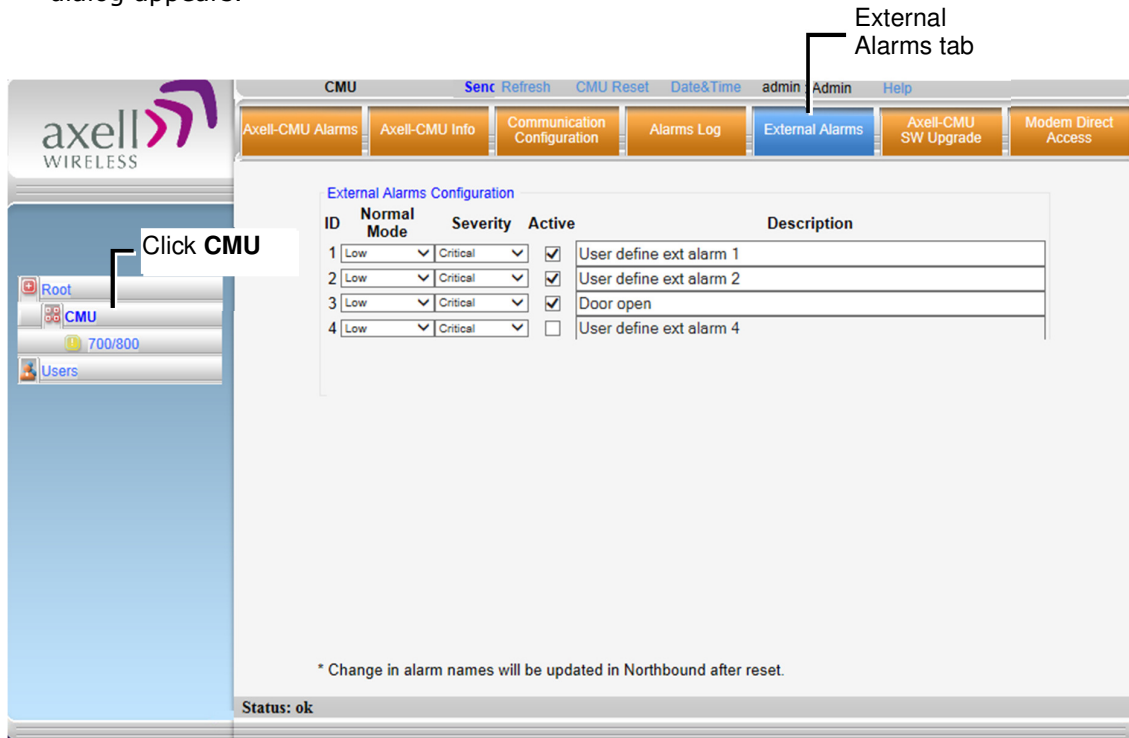

Figure 4-6. External Alarm Configuration Dialog

2. For each connected alarm:
 - Checkmark the **Active** checkbox.
 - Verify the alarm **Normal Mode** is set to Low.
 - Set the alarm **Severity** as Critical, Major or Minor
 - In the **Description** field, assign the alarm an identifiable name (e.g. Door open).

NOTE: Triggered external alarms are displayed in the **Axell-CMU-Alarms** tab.

4.5 Setting the IP Address

The Repeater supports both Static and DHCP addresses. A unique technology enables applying both types to the *same* Ethernet port. Both addresses may enable local and remote management.

- Local IP Address – Static IP assigned by the user to the system. The default Static IP address is 192.168.1.253. It is highly recommended to preserve this setup. In case of a change, make sure you record the newly assign IP.
- DHCP Address – address assigned by DHCP server – used for remote management via an Ethernet connection.

To configure the IP Address

1. Click on **CMU** in the tree pane and select the **Communication Configuration** tab. The following dialog appears.

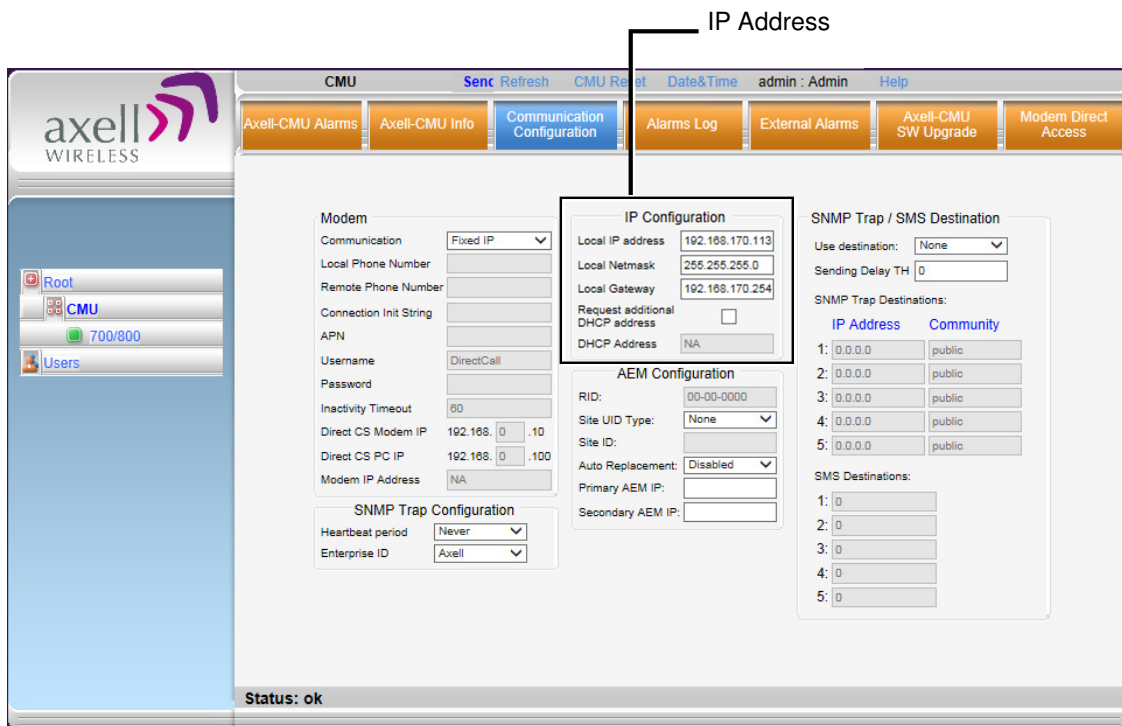

Figure 4-7. Communication Configuration Dialog

2. To assign the unit addresses (in **IP Configuration** area):
 - Local address - in the IP Configuration area, assign the unit the IP address, Netmask and Gateway parameters provided by your system administrator.
 - DHCP server address – checkmark the option Request Additional DHCP Address. The assigned address can be seen in the DHCP Address field.
3. Click **Send**.

5 Administrative Operations

The following administrative operations are described in this section:

- User Management – defining and changing users and passwords.
- Viewing the Repeater information such as software and hardware versions, serial number.
- Software upgrade

5.1 User Management

This section describes how to perform the user management operations. By default, *two* users belonging to one of three authentication levels are defined on the Repeater. You may add new users, modify or delete existing users.

5.1.1 User Levels

Two user levels are available:

- Admin – has access to all administration and configuration options, including user management. (Default Password **admin** and default User Name **admin**.)
- Operator – has access to all configuration options *except* for the Users list or the Loaders screen.

5.1.2 Viewing the List of Defined Users

To display the User Administration pane

From the **Tree Pane**, select **Users**. The list of users is displayed in the Configuration Pane according to the identifying information and authentication level (Role).

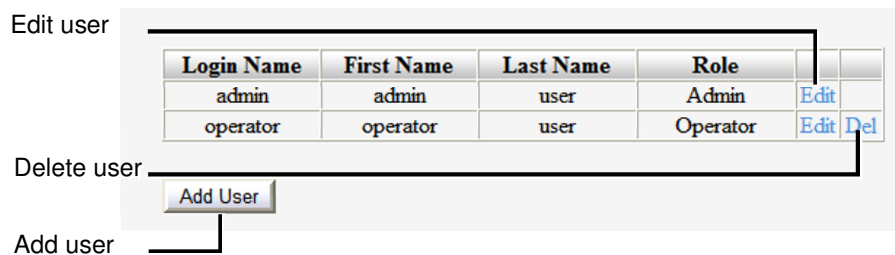

Figure 5-1. User Administration Pane

The following table provides a description of the Users dialog options.

Option	Description
Add User (button)	Adds a new user with to user defined access level and password.
Del(ete)	Deletes a selected user from the list.
Edit	Enables changing the definitions of an existing user.

5.1.3 Adding Users

NOTE: User name and password entries are case sensitive.

To add a user

1. From the Tree Pane, select **Users**. The list of users is displayed in the User's Pane.
2. From the User's Pane, click **Add User**. The Add User dialog box is displayed.



The 'Add User' dialog box contains the following fields and controls:

- Login Name**: Text input field
- First Name**: Text input field
- Last Name**: Text input field
- User Role**: Dropdown menu with 'Admin' selected
- Password**: Text input field
- Verify Password**: Text input field
- OK** and **Cancel** buttons at the bottom.

Figure 5-2. Add User

3. Enter the **Login Name** – name used by user to login.
4. Type the user's **First Name** and **Last Name** – used to identify the user.
5. Select the **User Role** – access level. This defines the operations that the user will be able to perform.
6. Enter the **Password** and in **Verify Password** enter the password again for verification.
7. Click **OK**.

5.1.4 Editing a User

To modify user definitions

1. From the **Tree Pane**, select **Users**. The list of users is displayed in the **User's Pane**.
2. Select the **User** to be edited in the list.
3. Click **Edit**. The user definitions dialog appears.
4. Make the required changes and click **OK**.

5.1.5 Deleting a User

To delete a user

1. From the Tree Pane Select **Users**. The list of users is displayed in the User's Pane.
2. Select the User to be deleted in the list.
3. From the User's Pane, click **Del**. An authorization message dialog box is displayed.



The 'Remove User' dialog box contains the following text and controls:

- Remove User** (Title)
- Are you sure you want to remove the user operator ? (Text)
- Yes** and **No** buttons at the bottom.

Figure 5-3. Remove User

4. Click **Yes**. The User's name is removed from the list.

5.2 Repeater and Band Level Information

The Web GUI provides Repeater level information (via the CMU Info tab) and band level information (via the Band Info tab).

5.2.1 Viewing Repeater Level Information

Use the **CMU Info** screen to view the hardware and software versions of the Axell Repeater and to assign the Repeater a recognizable name.

To access the Band Information window

In the Tree Pane, select **CMU** and click the **Axell CMU Info** tab.

Use the **Log Level** to set the minimum fault level that is logged. Other fields provide version and identification information.

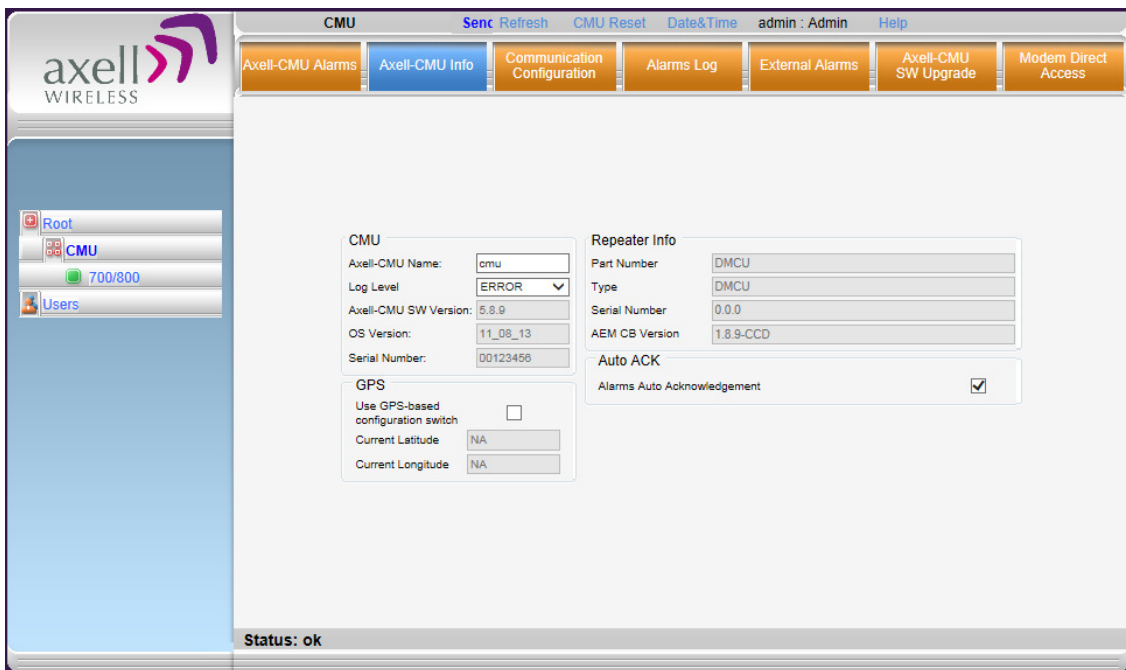

Figure 5-4. CMU Level Info

5.2.2 Viewing Band Level Info

Use the **Repeater Information** screen to view the hardware and software versions of the Axell D-MBR Repeater and to assign the Repeater a recognizable name.

To access the Repeater Information window

1. From the Tree Pane, select the **Band** element (i.e. 700/800).
2. Select the **Band Info** tab. The relevant parameters are displayed.

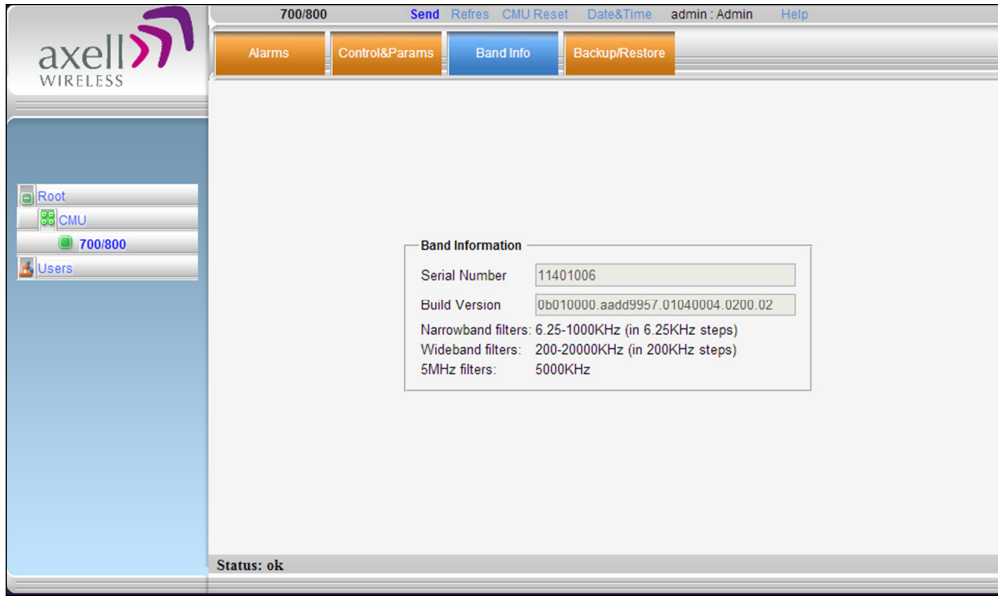

Figure 5-5. Band Level Information

5.3 Configuration Files Backup/Restore

The D-MBR 3007-3008-PS Web GUI management application enables the backup and restore of the repeater configuration files. The procedures are performed via the **Backup/Restore** tab.

A number of configuration files can be stored on the Repeater for access at any time.

You can perform the following operations:

- Backup of the currently active configuration
- Restoring a previously saved file
- Uploading a configuration file from another location to the Repeater
- Downloading a configuration file from the Repeater to another location

5.3.1 The Backup/Restore Tab

To access Backup/Restore tab

From the Tree Pane, select the relevant *band* and click the **Backup/Restore** tab. The following screen appears.

The screen displays the configuration files currently available on the Repeater. Each file is displayed along with the Repeater serial number and is named by default according to the date on which it was created (a user defined name can also be assigned).

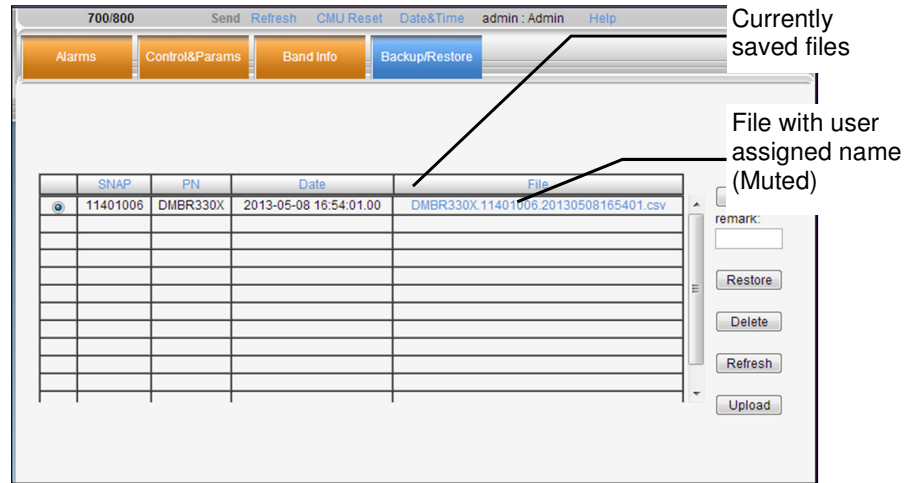

Figure 5-6. Backup and Restore

NOTE: Click links to download files and save to another location.

The file management buttons provide the following options:

Button	Description
Backup	Backup the currently running configuration file
Remark	User defined name that will be assigned to the file saved using the Backup file. (Instead of the system assigned name).
Restore	Activates the system with the <i>selected</i> file.
Delete	Deletes the <i>selected</i> file.
Refresh	Refreshes the displayed list of files.
Upload	Enables uploading a configuration file from another location to the Repeater.

5.3.2 Backup of Repeater Configuration

NOTE: The backed file will automatically be assigned a name according to the backup date and unit ID. The name cannot be modified while the backup file is saved onto the Repeater. However, before the backup procedure begins, the user may assign the file a recognizable name via the Remark field.

To perform backup procedure

1. To assign the configuration file a recognizable name, enter a name in the **remark** field. Otherwise, the file will be assigned a name by the system.
2. Click the **Backup** button located on the right-hand side of the tab.
3. The file will be added to the table displayed in the Backup/Restore tab.

Note: The file name (under File) is a link that enables uploading the file to another location.

	SNAP	PN	Date	File
<input checked="" type="radio"/>	11401006	DMBR330X	2013-05-08 16:54:01.00	DMBR330X.11401006.20130508165401.csv
<input type="radio"/>				
<input type="radio"/>				

Figure 5-7. Backup Repeater Info

5.3.3 Restoring Previous Repeater Configuration

To restore previous configuration

1. Select the required configuration file (enable corresponding radio button) from the available list in the Backup/Restore tab.
2. Click the **Restore** button.

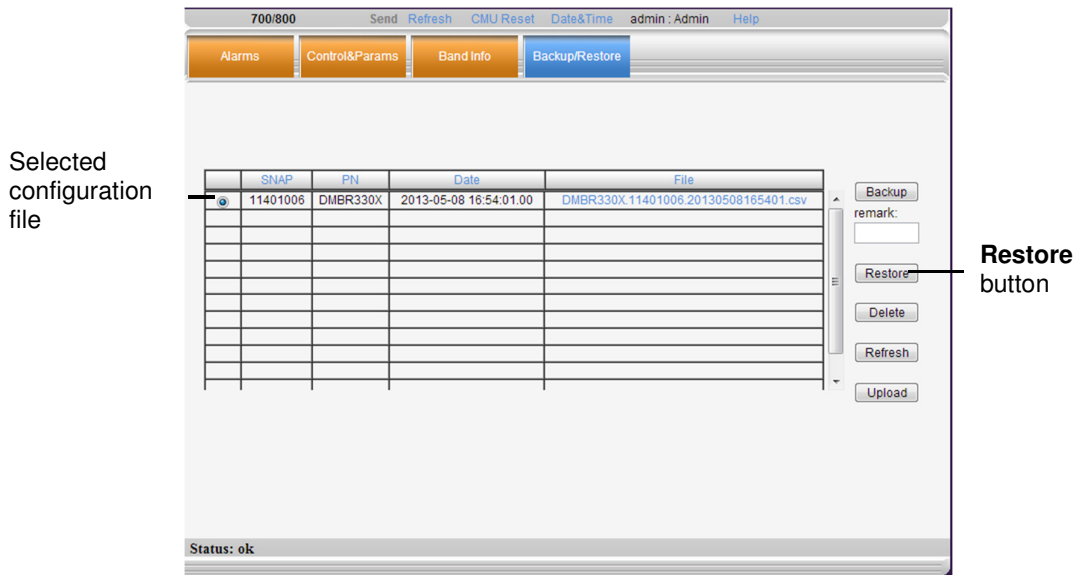

Figure 5-8. Restore Repeater Info

3. Click on the **Control and Params** tab and verify that the required configuration settings have been restored.

5.3.4 Uploading New Configuration File to Repeater

To upload configuration file to Repeater

1. Click the **Upload** button.
2. Select the file from the Browse dialog and click Open.
3. The file appears in the list displayed in the Backup/Restore table.

5.3.5 Saving Configuration File to Computer

To save a configuration file from the available list in the Backup/Restore table to a location in a connected computer:

- Select file from list.
- Click the link in the **File** column.
- Select the location in the Browse dialog.

5.4 CMU Software Upgrade

The procedure described in this section is used to upgrade the repeater CMU.

NOTE: This procedure is performed for every new management version.

The CMU SW upgrade procedure consists of loading the new software version and installing it in the CMU. The CMU can store two versions on two separate data banks enabling restore to a previous version.

To Upgrade the CMU SW

1. In the Tree Pane, select **CMU** and click the **Axell CMU SW Upgrade** tab. The following screen appears (the Browse field will be empty).

Software Upgrade

To upload a new version to the Repeater:

1. Choose the new version file to upload:
2. Select the bank you want to put the uploading version: 5.0.8 5.1.1
3. Press the button to upload the new version file into selected bank.

Here is the list of available versions. Choose the version to install:

5.0.8 (CMU only) : CCD software

5.1.1 (CMU only) : CCD software

Press the button to start the upgrade process.

The activity log:

2. Choose and save the file onto the Repeater:
 - (1) Click **Browse** to search for the location and choose the new software file. It will be displayed adjacent to the Browse button.
 - (2) Select the bank where the file will be stored. (Before it is populated the bank will be named 'slot'. After it is populated, it will take on the name of the stored software version). Any existing software file will be replaced.
 - (3) Press Upload to save the file to the selected bank (slot). The available software files to choose from will be listed.

Software Upgrade

To upload a new version to the Repeater:

1. Choose the new version file to upload:
2. Select the bank you want to put the uploading version: 5.1.1 5.1.2
3. Press the button to upload the new version file into selected bank.

Here is the list of available versions. Choose the version to install:

5.1.1 (CMU only) : CCD software
 5.1.2 (CMU only) : CCD software

Press the button to start the upgrade process.

The activity log:

File uploaded successfully.
Software version 5.1.2 is ready to be installed. Choose it in the list and press the 'Install' button to continue.

3. Choose the required software file and click **Install**.

Software Upgrade

To upload a new version to the Repeater:

1. Choose the new version file to upload:
2. Select the bank you want to put the uploading version: 5.0.8 5.1.1
3. Press the button to upload the new version file into selected bank.

Here is the list of available versions. Choose the version to install:

5.0.8 (CMU only) : CCD software
 5.1.1 (CMU only) : CCD software

Press the button to start the upgrade process.

The activity log:

File uploaded successfully.
 Getting the version number...

4. The Activity Log will indicate status and upgrade completion.

Software Upgrade

To upload a new version to the Repeater:

1. Choose the new version file to upload:
2. Select the bank you want to put the uploading version: 5.1.1 5.1.2
3. Press the button to upload the new version file into selected bank.

Here is the list of available versions. Choose the version to install:

- 5.1.1 (CMU only) : CCD software
- 5.1.2 (CMU only) : CCD software

Press the button to start the upgrade process.

The activity log:

Software upgrade completed. You may log in to the repeater.

6 Monitoring and Troubleshooting

The D-MBR 3007-3008-PS-NFPA provides two types of indications of failure:

- Front panel LED
- Alarms screen in Web access application
- Alarms Log – used to view a record of past generated alarms

The following sections provide a description of the troubleshooting procedures according to the Alarms and log options.

6.1 Front Panel LED

The repeater supports ONE status LED on its front panel. The LED color and steady or blinking status reflects system status (normal or faulty) and fault level as described in this section.

NOTE: The NFPA unit is colored **RED**.



6-1. Axell D-MBR 3007-3008-PS NFPA Front Panel Interfaces

LED color	Description – section 6.2.
Red	<ul style="list-style-type: none"> • System Mute • User Mute • PAmp Current • Temperature High Level • Built in test
Orange	RSSI DL VSWR(DL&UL)
Blinking green	Power Below Threshold

6.2 GUI Alarm Descriptions

The Alarms tab provides the alarms generated by the Repeater, enabling the user to monitor the system operation.

To access the Alarms window

From the Tree Pane, select the 700/800 item and choose the **Alarms** tab. Note that some alarms are dedicated for the UL and DL and other alarms are common to the UL and DL.

NOTE: Use the Ack All button to simultaneously acknowledge all triggered alarms.

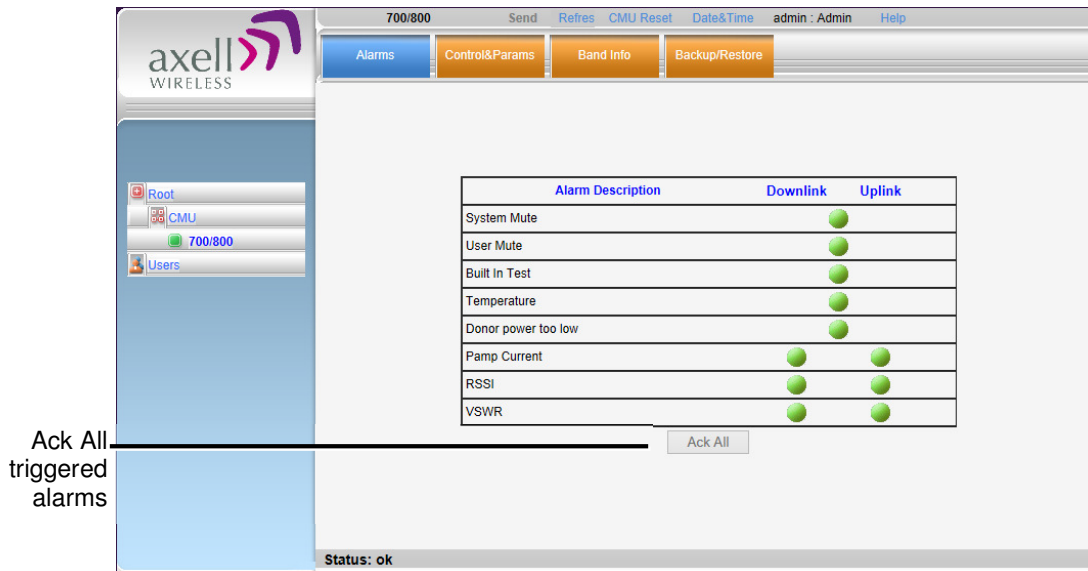

Alarm	Fault and most probable cause and Recommendation
System Mute	<p>Description. Generates an alarm when Repeater amplification is <i>automatically</i> muted.</p> <p>Possible causes:</p> <ul style="list-style-type: none"> • Temperature failure • Synthesizer failure • Hardware failure • High RSSI power DL/UL when the shutdown mechanism is on (Control and Params tab). <p>Recommended action: Check the LEDs and other alarm from the Repeater. Contact Axell Support</p>
User Mute	<p>Description: Manual shutdown performed by operator from the Web GUI.</p> <p>Recommended action: Review unit's log</p>
Built In Test	<p>Possible causes: Hardware failure, Circuitry failure, Software failure</p> <p>Recommended action: Contact Axell Support</p>
Temperature	<p>Description: Repeater temperature is exceedingly high due to excessive external heat.</p>

Alarm	Fault and most probable cause and Recommendation
	<p>Recommended action: Check the Repeater case for external causes (sun, hot environment, air flow is blocked). Eliminate the reason for excessive heat.</p>
Donor Power Too Low	<p>Description: Signal from the Donor antenna (DL) is too low - relatively to the desired output signal configured by the user.</p> <p>Recommended action:</p> <ul style="list-style-type: none"> • Check the Donor/Base connections and antenna position. • Check the signal level of the Donor/Base antenna. • If the Donor Power Too Low alarm is still raised, then you can raise, the value of the DL Output Threshold Delta[dBm] as needed.
(PAmp) Current	<p>Description: Power Amplifier current is not within limits (too high or too low). If the Mute option is enabled, then this is not a fault since it indicates low Power Amplifier current caused by the mute.</p> <p>Recommended action: Check the LEDs status in the Repeater and Contact Axell service support.</p>
RSSI	<p>Description: Generates an alarm when a high <i>donor</i> input signal causes system gain reduction</p>
VSWR	<p>Description: This alarm is triggered when the return loss of the Downlink or Uplink antenna or cable connection exceed the allowed limit.</p> <p>This alarm provides an indication of the status of the cable/antenna connected to the antenna. If a cable/antenna is defective, the VSWR is decreased and the alarm is triggered.</p> <p>Recommended action: Check the cable.</p>

6.3 Alarms Log

The Alarms Logs screen lists the alarms (events) that have occurred. The CMU maintains log files listing every alarm triggered and in the Repeater. This screen provides an analysis tool to get information of any event that has occurred, its originator, when, if they return, and their type.

NOTE: Set the clock in order to synchronize the events time of occurrence (see 4.3).

To view the CMU log screen:

1. Open and login to the Web application.
2. From the Tree Pane, select **CMU**.
3. Click **Alarms Logs**. CMU displays the Alarms Log Table.

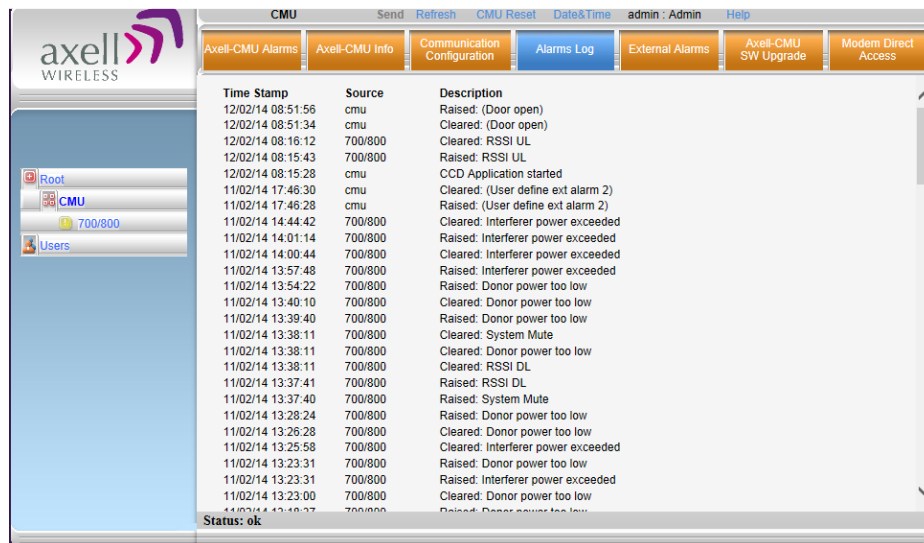

Figure 6-2. CMU Alarms Log Tab

Item	Description
Time Stamp	The date and time the alarm was created
Source	Source of alarm.
Description	Description of event that caused the alarm

Appendix A: Specifications

This appendix provides the electrical, mechanical and environmental specifications of the Axell D-MBR 3007-3008-PS-NFPA.

Electrical	Downlink	Uplink
Frequency Range: SMR 700MHz ,D block SMR 700MHz SMR 800MHz	758 - 763 MHz 763 - 775 MHz 851 - 861 MHz	788 - 793 MHz 793 - 805 MHz 806 - 816 MHz
Passband Max Gain	85dB	
Passband attenuation range	30dB @ 1dB steps	20dB @ 1dB steps
Passband Ripple	± 2.5 dB	± 2.5 dB
Gain attenuation range	30dB	20dB
Filter Bandwidth (SMR 700MHz) (*)	Programmable 12.5KHz to 1MHz at 12.5KHz steps, 1MHz-17MHz at 200KHz steps	
Filter Bandwidth (SMR 800MHz) (*)	Programmable 12.5KHz to 1MHz at 12.5KHz steps, 1MHz-10MHz at 200KHz steps	
Number of filters(SMR 700& 800)	12	
Composite Output Power SMR700MHz	+30 dBm	+27 dBm
Composite Output Power SMR800MHz	+30 dBm	+27 dBm
Noise Figure @ Maximum Gain	5.0 dB	
General		
Dimensions W x D x H	13.78" x 18.1" x 5.7" (350 mm x 460 mm x 145 mm)	
Power Supply	90 to 260 VAC or 48VDC	
Power Consumption	<130 W	
Total RF Input Power (no damage)	+10 dBm	
Impedance Level	50 Ohm	
RF Connector	N-type, Female	
VSWR	1.5:1 maximum	
Compliance	IC/FCC	
Environmental		
Operating Temperature	-5 to 122° F (-10° C to +50° C)	
Humidity	10% to 90% Condensed	
Weight	28.8 lbs. (13kg)	
Enclosure	Aluminum (NEMA4/IP-65)	

(*)Every filter above 10 MHz utilizes 2 FPGA resources

Ordering Information		
IDENTIFICATION	DESCRIPTION PART	NUMBER
D-MBR 3007-3008 PS NFPA AC	Digital Multi Channel Selective Signal Booster 700/800 12 channels, 30dBm composite per band, 85dB gain, AC and DC powering with NFPA and IFC compliant Alarm Outputs and red painted case.	D-MBR 7/8 PS 30DBM 12 FIL NFPA RED
D-MBR 3007-3008 PS NFPA DC	Digital Multi Channel Selective Signal Booster 700/800 12 channels, 30dBm composite per band, 85dB gain, DC powering with NFPA and IFC compliant Alarm Outputs and red painted case.	D-MBR 7/8 PS 30DBM 12F NFPA DC
12 hour battery	Battery back-up unit for 12 hours	BBU-400W-12H
24 hour battery	Battery back-up unit for 24 hours	BBU-400W-24H
PSTN Dialer	PSTN Dialer for NFPA Signal Booster	PSTN-DIALER