

DIGImini Americas High Selectivity Digital Multi-Band Mini-Repeater Rev 3.5

Product Description and User's Manual

THIS DOCUMENT IS VALID FOR THE FOLLOWING REPEATER MODELS:

Product	Part Number	IC ID	FCC ID
DigiMini 850/1900	D-MINI-2108-2019	8749A-DM819	NEO-DMINI21082019
DigiMini 700U/1700	D-MINI-2107U-2017	8749A-DM7U17	NEODMINI2107U2017
DigiMini 700L/1700	D-MINI-2107L-2017	8749A-DM7L17	NEODMINI2107L2017
DIGI mini 4 bands Accessory upgrade kit <i>D-MINI 4B-AK</i>			



Single Band/Dual Band



Tri Band/Quad Band

Copyright © 2012 Axell Wireless Ltd

All rights reserved.

No part of this document may be copied, distributed, transmitted, transcribed, stored in a retrieval system, or translated into any human or computer language without the prior written permission of Axell Wireless Ltd.

The manufacturer has made every effort to ensure that the instructions contained in this document are adequate and free of errors and omissions. The manufacturer will, if necessary, explain issues which may not be covered by this document. The manufacturer's liability for any errors in the document is limited to the correction of errors and the aforementioned advisory services.

This document has been prepared to be used by professional and properly trained personnel, and the customer assumes full responsibility when using them. The manufacturer welcomes customer comments as part of the process of continual development and improvement of the documentation in the best way possible from the user's viewpoint. Please submit your comments to the nearest Axell Wireless sales representative.

Contact Information

Headquarters	Axell Wireless Aerial House Asheridge Road Chesham Buckinghamshire HP5 2QD United Kingdom Tel: +44 1494 777000 Fax: +44 1494 777002
Commercial inquiries	info@axellwireless.com
Web site	www.axellwireless.com
Support issues	support@axellwireless.com
Technical Support Line, English speaking	+44 1494 777 747

Contact information for Axell Wireless offices in other countries can be found on our web site, www.axellwireless.com

About This Manual

This Product Manual provides the following information:

- Description of the DIGImini Repeater
- Procedures for setup, configuration and checking the proper operation of the Mini-Repeater
- Maintenance and troubleshooting procedures

For whom it is Intended

This Product Manual is intended for experienced technicians and engineers. It is assumed that the customers installing, operating, and maintaining Axell Wireless Mini-Repeaters are familiar with the basic functionality of Repeaters.

Notice

Confidential - Authorized Customer Use

This document may be used in its complete form only and is solely for the use of Axell Wireless employees and authorized Axell Wireless channels or customers. The material herein is proprietary to Axell Wireless. Any unauthorized reproduction, use or disclosure of any part thereof is strictly prohibited.

All trademarks and registered trademarks are the property of their respective owners.

Disclaimer of Liability

Contents herein are current as of the date of publication. Axell Wireless reserves the right to change the contents without prior notice. The information furnished by Axell Wireless in this document is believed to be accurate and reliable. However, Axell Wireless assumes no responsibility for its use. In no event shall Axell Wireless be liable for any damage resulting from loss of data, loss of use, or loss of profits and Axell Wireless further disclaims any and all liability for indirect, incidental, special, consequential or other similes damages. This disclaimer of liability applies to all products, publications and services during and after the warranty period.

Guarantees

- **All antennas must be installed with lightning protection.** Damage to power modules, as a result of lightning are not covered by the warranty.
- **Antennas must be connected before switching on AC or DC power.** Switching power on prior to the connection of antenna cables is regarded as faulty installation procedure and therefore not covered by the Axell Wireless warranty.

Exclusive Remedies

- The remedies provided herein are the Buyer's sole and exclusive remedies. Axell Wireless shall not be viable for any direct, incidental, or consequential damages, whether based on contract, tort, or any legal theory.

Compliance with FCC

FCC Part 15

This device complies with part 15 of the FCC Rules. Operation is subject to the following two conditions:

1. This device may not cause harmful interference, and
2. This device must accept any interference received, including interference that may cause undesired operation.

If not installed and used in accordance with the instructions, this equipment generates, uses and can radiate radio frequency energy. However, there is no guarantee that interference will not occur in a particular installation. If this equipment does cause harmful interference to RF reception, which can be determined by turning the equipment off and on, the user is encouraged to try to correct the interference by one or more of the following measures:

- Reorient or relocate the Donor antenna.
- Increase the separation between the equipment and receiver.
- Connect the equipment into an outlet on a circuit different from that to which the receiver is connected.

Unauthorized Changes to Equipment

Changes or Modifications not expressly approved by the manufacturer responsible for compliance could void the user's authority to operate the equipment

FCC RF Exposure Limits

This unit complies with FCC RF exposure limits for an uncontrolled environment. This equipment must be installed and operated with a minimum distance of 20cm between the radiator and any person's body.

Antenna Installation

Installation of an antenna must comply with the FCC RF exposure requirements. The antenna used for this transmitter must be mounted on outdoor or indoor permanent structures.

The maximum antenna gain for indoor operation is 2.2 dBi and for the external antenna is 13dBi (except for 1700MHz – where the maximum antenna gain for external operation is 9 dBi). Cable loss of at least 2dB is taken into account for all cases.

Antennas having a gain greater than these are strictly prohibited for use with this device. In indoor applications the antenna must be installed at a minimum separation distance of 20cm from all nearby persons.

Compliance with IC

Under Industry Canada regulations, this radio transmitter may only operate using an antenna of a type and maximum (or lesser) gain approved for the transmitter by Industry Canada. To reduce potential radio interference to other users, the antenna type and its gain should be so chosen that the equivalent isotropically radiated power (e.i.r.p.) is not more than that necessary for successful communication.

Conformément à la réglementation d'Industrie Canada, le présent émetteur radio peut fonctionner avec une antenne d'un type et d'un gain maximal (ou inférieur) approuvé pour l'émetteur par Industrie Canada. Dans le but de réduire les risques de brouillage radioélectrique à l'intention des autres utilisateurs, il faut choisir le type d'antenne et son gain de sorte que la puissance isotrope rayonnée équivalente (p.i.r.e.) ne dépasse pas l'intensité nécessaire à l'établissement d'une communication satisfaisante.

General Safety Warnings Concerning Use of This System

Always observe standard safety precautions during installation, operation and maintenance of this product.







 <p>Caution labels!</p>	<p>Throughout this manual, there are "Caution" warnings. "Caution" calls attention to a procedure or practice, which, if ignored, may result in injury or damage to the system, system component or even the user. Do not perform any procedure preceded by a "Caution" until the described conditions are fully understood and met.</p>
 <p>Danger: Electrical Shock</p>	<p>To prevent electrical shock when installing or modifying the system power wiring, disconnect the wiring at the power source before working with un insulated wires or terminals.</p>
 <p>Caution: Safety to personnel</p>	<p>Before installing or replacing any of the equipment, the entire manual should be read and understood.</p> <p>The user needs to supply the appropriate AC or DC power to the repeater. Incorrect power settings can damage the repeater and may cause injury to the user.</p> <p>Please be aware that the equipment may, during certain conditions become very warm and can cause minor injuries if handled without any protection, such as gloves.</p>
 <p>Caution: Safety to equipment</p>	<p>When installing, replacing or using this product, observe all safety precautions during handling and operation. Failure to comply with the following general safety precautions and with specific precautions described elsewhere in this manual violates the safety standards of the design, manufacture, and intended use of this product.</p> <p>Changes or modifications not expressly approved by the party responsible for compliance could void the user's authority to operate the equipment Axell Wireless assumes no liability for the customer's failure to comply with these precautions. This entire manual should be read and understood before operating or maintaining the repeater.</p>
 <p>Warning: Restricted Access Location</p>	<p>Access to the Axell unit installation location is restricted to SERVICE PERSONNEL and to USERS who have been instructed on the restrictions and the required precautions to be taken.</p>
 <p>Attention: Electrostatic Sensitivity</p>	<p>Observe electrostatic precautionary procedures. ESD = Electrostatic Discharge Sensitive Device. Static electricity can be conducted to the semiconductor chip from the centre pin of the RF input connector, and through the AC connector pins. When unpacking and otherwise handling the repeater, follow ESD precautionary procedures including use of grounded wrist straps, grounded workbench surfaces, and grounded floor mats.</p>

Table of Contents

1	Introduction	1
1.1	Features and Capabilities.....	2
1.2	Models and Ordering Information	3
1.3	Dual-band and Quad-band Installations	3
1.4	Smart-ALC Function	3
1.5	DMCU - Optional.....	4
1.6	DIGImini Interfaces	4
1.6.1	Front Panel Interfaces	5
1.6.2	Side Panel Interfaces	6
1.7	DIGImini Power Supply.....	6
2	Antenna and Repeater Installation Requirements	7
2.1	Base (Donor) Antenna Requirements	7
2.1.1	Required Antenna Information	7
2.1.2	Donor Antenna specifications.....	7
2.1.3	Installation Criteria.....	8
2.2	Service Antenna Requirements	8
2.2.1	Required Antenna Information	8
2.2.2	Recommended Antennas	8
2.2.3	Mobile (Service) Antenna Installation Criteria	9
2.3	Repeater Pre-Installation Requirements.....	9
2.3.1	Safety Guidelines	9
2.3.2	Required BTS Information.....	9
2.3.3	Criteria for Repeater Installation Location	10
2.3.4	RF Cable Installation Guidelines	10
3	Dual-Band Repeater Installation	11
3.1	Single Unit Installation	11
3.1.1	Overview.....	11
3.1.2	Required Tools and Materials	11
3.1.3	DIGImini Dual-band Kit.....	12
3.1.4	Mounting Repeater.....	13
3.1.5	Before Connecting the Antennas or Power	16
3.1.6	Antenna Connections	17
3.1.7	Power Up.....	18
3.1.8	What Next?.....	18
4	Two Dual Units (Quad-band) Installation	19
4.1	Overview	19
4.2	View of the Quad Band Installation	20
4.3	Required Tools and Materials	21
4.4	DIGImini Tri/Quad-band Kit.....	21
4.4.1	Top Layer Items.....	21
4.4.2	Middle layer Items	22
4.4.3	Bottom Layer Items	22
4.4.4	Additional Items	23
4.5	Upgrading to a Quad-Band System.....	23
4.5.1	Assemble the DIGImini Units	23
4.5.2	Assembling Quad-Band Plates and Labels.....	28
4.5.3	Connect SMA Jumper Cables	30
4.5.4	Before Connecting the Antennas or Power	33

PRODUCT DESCRIPTION AND USER'S MANUAL

4.5.5	Antenna Connections	33
4.5.6	Power Up	34
4.5.7	What Next?	34
5	Setup and Configuration	35
5.1	Open a Direct Local WEB Session to the Repeater	35
5.2	Navigating the Web GUI Application	37
5.2.1	Band Pane and Tabs	38
5.2.2	Operation Buttons	38
5.2.3	Signal Levels and Channel Configuration	39
5.2.4	RF Gain Setting Criteria	39
5.2.5	Bandwidth and the Number of Available Bands	39
5.2.6	Adjusting the Signal Levels and Configuring Channels	40
5.3	Monitoring and Troubleshooting	44
5.3.1	Repeater Alarms and Troubleshooting	44
5.3.2	DIGImini LED Troubleshooting	45
6	DMCU Installation and Management	46
6.1	Features and Capabilities	47
6.2	DMCU Interfaces	47
6.3	DMCU Kit	48
6.4	DMCU Installation Procedure	48
6.4.1	GPRS Modem	48
6.4.2	CDMA Modem	48
6.4.3	SIM Card Installation (GSM/GPRS Modems only)	49
6.4.4	Connecting the DMCU to the Repeater	50
6.4.5	DMCU Dry Contacts	51
6.5	Opening a Web Session via the DMCU	52
6.5.1	Login to the Repeater	55
6.5.2	Navigating the Web GUI Application	56
6.6	Basic Configuration Procedures	58
6.6.1	Configuring Signal Levels and Channels	58
6.6.2	Setting Date and Time	58
6.6.3	Configuring the External Alarms	59
6.7	Communication and System Parameters	60
6.7.1	The Communication Configuration Tab	60
6.7.2	IP Address Configuration	60
6.7.3	General Modem Parameters	61
6.7.4	GSM/GPRS Modem Setup	63
6.7.5	CDMA Modem Setup	64
6.7.6	Verifying Modem RSSI and Registration	66
6.7.7	Direct Circuit Switch Connection	66
6.7.8	Configuring Notification Method - SNMP Trap or SMS	67
6.8	DMCU Administration	70
6.8.1	Viewing Repeater Level Information	70
6.8.2	CMU Software Upgrade	71
6.8.3	Backup/Restore of Repeater Configuration	72
6.8.4	User Management	74
6.9	CMU Monitoring and Troubleshooting Options	76
6.9.1	DMCU LED Troubleshooting	76
6.9.2	Viewing the Alarms Log	77
6.9.3	Viewing External Alarms Log	78
	Appendix A: Specifications (@+25°C)	79

1 Introduction

Axell Wireless DIGImini (digital mini) is a scalable in-building mini-repeater with advanced digital filtering capabilities. Each repeater supports two bands where two repeaters can be easily cascaded into a compact assembly to provide *tri-band* and *quad-band solutions*.

For each band, the user can configure up to six non-contiguous sub-bands, where the gain and power of each of the sub-bands can be individually defined. The Repeater provides highly accurate out-of-band-rejection and simple, GUI based procedures for adjusting the pass band according to the relevant frequency spectrums.

DIGImini includes the SmartALC power control algorithm that automatically optimizes the gain setting by learning the actual range of RSSI levels over a user-specified period of time. The SmartALC algorithm prevents oscillations, reduces the amount of isolation required by the system and optimizes the system to minimize noise rise at the donor cell site.

A state-of-the-art Interference Mitigation and Oscillation Prevention (IMOP) is used to measure the isolation between the antennas and gain is reduced immediately to prevent oscillation. Local Web based management is available via an RJ45 connection.

Optional, complete, remote Web-based management via a GPRS/CDMA modem provided by the DIGImini Control Unit (DMCU). The DMCU is ordered separately, where a single DMCU can support a single DIGImini or two cascaded units.



Figure 1-1. Axell DIGImini Repeater

1.1 Features and Capabilities

- Supported bands and (composite) output power at antenna port (model dependent):
 - 700U or 700L MHz and 1700
 - 850 MHz and 1900 MHz
- Output power at the antenna (composite):
 - 700UMHz, 700LMHz and 850MHz: 21dBm
 - 1700MHz and 1900MHz: 20dBm
- Maximum RF Gain: 73 dB
- Up to six software selectable non-contiguous sub-bands *per 2 bands* (see sec. 5.2.5 for details) can be configured with highly accurate frequency selection and dedicated gain and power settings
- SmartALC™ technology per sub-band:
 - Automatically sets optimum gain
 - Prevents oscillations and balances coverage
 - Ensures transparent network operation
 - Supports multi-operator functionality
- Lightweight and compact footprint for easy installation
- Multi-functional capabilities and modular design
- Continuously monitors and adapts to the RF environment via Auto gain feature
- Easy commissioning and setup via web-based browser
- Variable bandwidth settings from 200KHz to 25 MHz
- LEDs for local alarm indicators
- Optional DIGImini Control Unit (DMCU) – provides complete remote control and monitoring capabilities over GPRS/CDMA (model dependant):
 - Remote control via SMS
 - Remote alarming through SNMP alarm traps

1.2 Models and Ordering Information

The following models are available.

ORDERING INFORMATION for Axell DIGImini Americas Repeaters		
Identification	Description	Part Number
DIGI Mini 850/1900	DIGI MINI 850/1900 21/20dBm 6 Filters	D-MINI-2108-2019
DIGI Mini 700U/1700	DIGI MINI 700U/1700 21/20dBm 6 Filters	D-MINI-2107U-2017
DIGI Mini 700L/1700	DIGI MINI 700L/1700 21/20dBm 6 Filters	D-MINI-2107L-2017
DIGI Mini GPRS Modem	External GPRS modem	DMCU
DIGI Mini CDMA Modem	External CDMA modem	DMCU-CDMA
DIGI Mini Accessory Kit	DIGI MINI 4 bands Accessory upgrade kit	D-MINI 4B-AK

1.3 Dual-band and Quad-band Installations

DIGImini can be installed in two configurations: procedures:

- Single DIGImini unit – details in Chapter 3.
- Quad-band assembly consisting of two DIGImini units – details in Chapter 4

1.4 Smart-ALC Function

The Smart Automatic Level Control (Smart-ALC) is an innovative algorithm for automatic repeater gain adjustment per sub-band.

Combined with advanced control algorithms, SALC is capable of learning the traffic load characteristics and adjusting the Repeater RF Gain to the desired value.

Smart ALC eliminates the need to perform initial settings for maximal traffic load conditions and on-site gain adjustments.

Smart-ALC maintains the Uplink/Downlink gain balance for system transparency. In addition, Smart-ALC prevents oscillations that may occur due to insufficient isolation while maintaining the gain in a linear range operation by adjusting the repeater paths' gain accordingly.

IMOP (Isolation Measurement and Oscillation Prevention) algorithm effectively reduces oscillation problems.

The repeater's power amplifier includes power-monitoring circuits with Automatic Level Control (ALC) that prevents excessive output power while maintaining the power amplifier linearity.

1.5 DMCU - Optional

The DIGImini Control Unit (DMCU) is an optional control unit that is ordered separately. The DMCU is installed externally, where one unit can support a single DIGImini unit as well as an upgrade to a DIGImini Quad-band assembly. The DMCU provides complete remote control and monitoring capabilities over GPRS or CDMA (model dependent), including:

- Remote control via SMS
- Remote alarming through SNMP alarm traps

Refer to Chapter 6 - DMCU Installation and Management for the complete description of the DMCU and the configuration and management capabilities provided by the unit.

1.6 DIGImini Interfaces

The DIGImini is supplied in two physical configurations: Single unit supporting either one or two bands; two cascaded units supporting up to four bands. Power supplies *dedicated to each unit* are connected externally.

An optional DMCU supporting an external modem is also connected externally, where a single DMCU can serve two cascaded units.

The interfaces are located on the *front* and on the *side* panels.

1.6.1 Front Panel Interfaces

The image below shows the unit (the wallmount bracket is not shown).

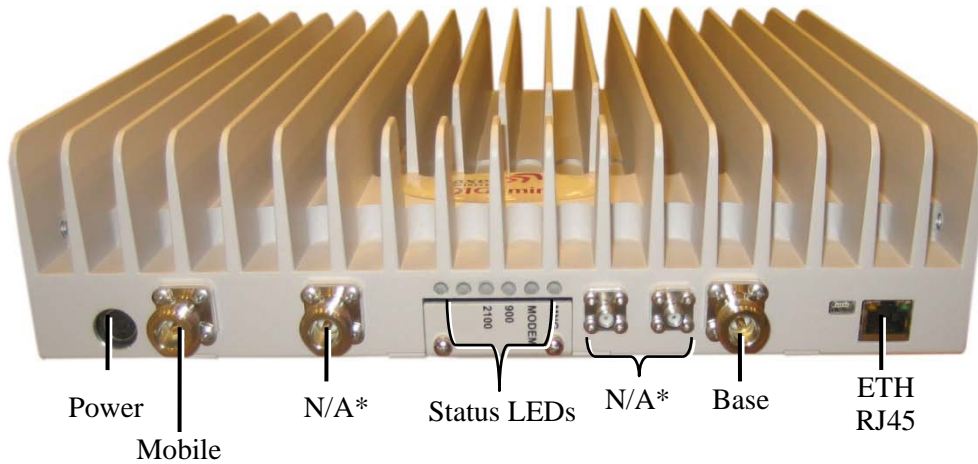

Figure 1-2: DIGImini Single/Dual-Band Front Panel

The following table provides a description of the front panel connectors.

Port	Description
MOBILE	Service antenna connections.
BASE	Donor antenna connections.
DC Power (12V)	Circular, 4-PIN.
RJ 45	Local management and setup port – to be used only if DMCU is <i>not</i> installed. ATTENTION! This port is only for local access. Do not connect this port to your network. It may affect your network!

*Connectors not in use and **no** termination is required.

The following table provides a description of the front panel LED indicators (See 5.3.2 for more info.).

LED	Description
<i>Band specific</i> LED (e.g. 850, 1900, etc)	Downlink path status and RSSI indication: <ul style="list-style-type: none"> Steady Green – Normal operation Orange – Major malfunction Red – Blinking panel mask

1.6.2 Side Panel Interfaces

The DIGImini side panel supports the DMCU interfaces and the side bolts used for hanging the unit on the wall bracket.

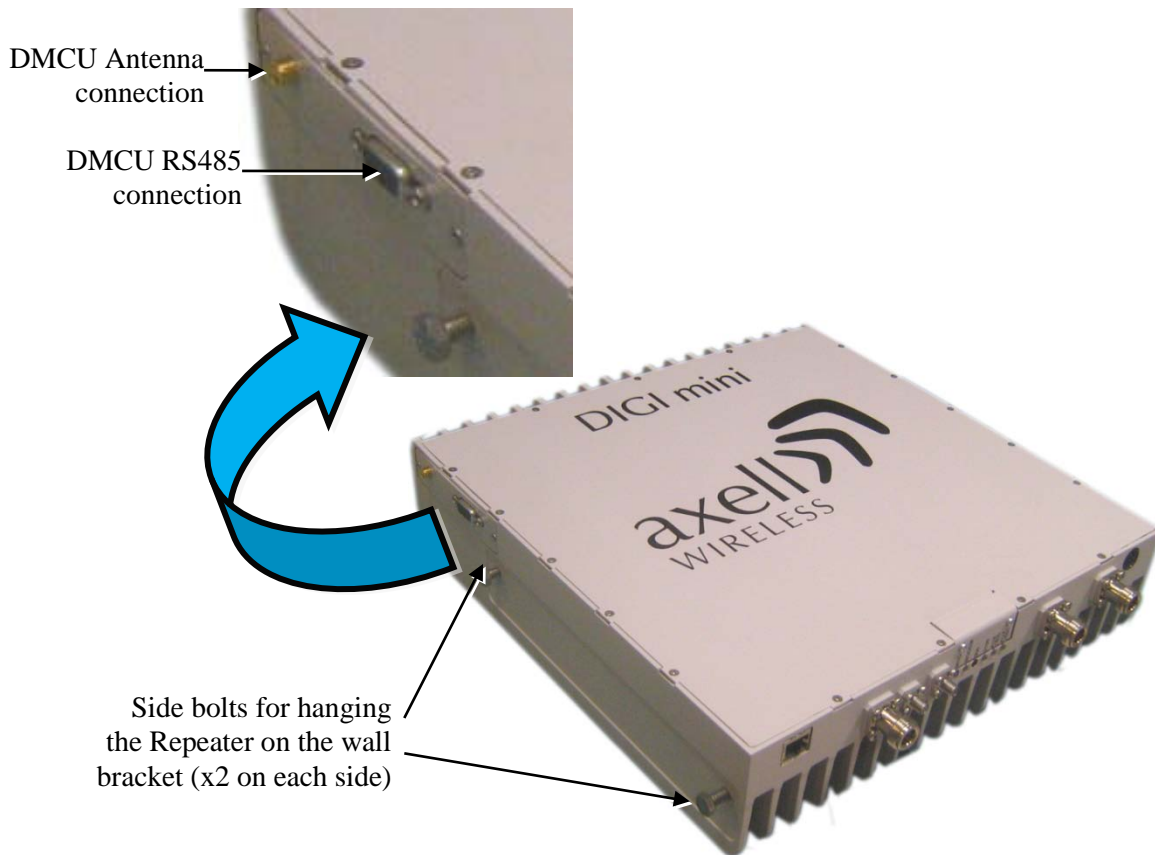

Figure 1-3. DIGImini Side Panel

Side Connector	Description
Modem	Modem Antenna connection - relevant if a DMCU is available.
RS485	RS485 connection to DMCU option.

1.7 DIGImini Power Supply

The power supply requires assembly only during an upgrade procedure from a single-band or dual-band to a triple-band or quad-band solutions in which two DIGImini units are cascaded. Otherwise, it is preassembled.



Figure 1-4: Repeater Power Supply

2 Antenna and Repeater Installation Requirements

This chapter provides information on the specifications of the donor and service antennas suitable for operation with this repeater, on the installation requirements of the antennas and on the Repeater installation site and cable requirements.

ATTENTION!!

The DIGImini models described in this manual have been approved by Industry Canada to operate with the antenna types listed below with the maximum permissible gain and required antenna impedance for each antenna type indicated. Antenna types not included in this list, having a gain greater than the maximum gain indicated for that type, are strictly prohibited for use with this device.

Le présent émetteur radio (identifier le dispositif par son numéro de certification ou son numéro de modèle s'il fait partie du matériel de catégorie I) a été approuvé par Industrie Canada pour fonctionner avec les types d'antenne énumérés ci-dessous et ayant un gain admissible maximal et l'impédance requise pour chaque type d'antenne. Les types d'antenne non inclus dans cette liste, ou dont le gain est supérieur au gain maximal indiqué, sont strictement interdits pour l'exploitation de l'émetteur.

2.1 Base (Donor) Antenna Requirements

The Base (Donor) antenna is usually installed outdoors and is either a directional antenna such as a Yagi or a Panel antenna.

2.1.1 Required Antenna Information

You will require the following antenna information

- Antenna type and characteristics
- Height
- Length and type of coaxial cable required for connecting the Donor antenna to the Repeater and the attenuation.

2.1.2 Donor Antenna specifications

- Yagi type or similar: 8 to 13 dBi gain, except for 1700MHz – where the maximum antenna gain is 9 dBi.
- Very sharp beam pointed to the BTS..
- Cable and jumper loss is at least 2dB.
- Example of antenna's typical specifications:

Gain:	8 dBd (=10.1 dBi)
VSWR:	< 1:5:1
Impedance:	50 ohm

2.1.3 Installation Criteria

Installation requirements:

- Select a location for the Donor antenna and verify that there is enough signal strength at that location.
- Install the Donor Antenna at the designated height.
- The antenna should point to the direction of the base station for maximum input power.
- Verify that the antenna is in the base stations line of sight (raise the antenna if necessary).
- Install the donor antenna at a higher level (i.e. floor) than the mobile antenna.
- Must be installed at a minimum distance of 20cm from any personnel within the area.

2.2 Service Antenna Requirements

The Service antenna is installed indoors, where the type of antenna depends on the application.

2.2.1 Required Antenna Information

The following antenna requirements, specifications and site considerations should be met.

- Service area type and size
- Antenna type and characteristics
- Height
- Length and type of coaxial cable required for connecting the antenna to the Repeater and the attenuation.

2.2.2 Recommended Antennas

- One or a combination of the following antennas can be used: Ceiling Mount Patch antenna, Wall Mount Patch antenna, Corner Reflector.
- Choose an antenna with high side lobe attenuation which enables maximum isolation from the service/ mobile antenna.
- Maximum antenna gain for indoor operation 2.2dBi

2.2.3 Mobile (Service) Antenna Installation Criteria

Determine the antenna installation configuration, according to the transmission requirements and the installation site conditions.

Installation requirements:

- An indoor antenna should be installed at a convenient location. It should be free of metallic obstruction.
- Install the Service Antenna at the designated height and tune it roughly toward the Service coverage area.
- Installation of this antenna must provide a minimum separation distance of 20cm from any personnel within the area.

2.3 Repeater Pre-Installation Requirements

2.3.1 Safety Guidelines

Before installing the Repeater, review the following safety information:

- Follow all local safety regulations when installing the Repeater.
- Only qualified personnel are authorized to install and maintain the Repeater.
- Ground the Repeater with the grounding bolt located on the external lower side of the Repeater).
- Do not use the grounding bolt to connect external devices.
- Follow Electro-Static Discharge (ESD) precautions.
- Use low loss cables to connect the antennas to the Repeater.

2.3.2 Required BTS Information

Required BTS Information

- BTS channels
- BTS output power per channel
- BTS antenna gain
- BTS antenna height
- Distance from Repeater site to BTS

2.3.3 Criteria for Repeater Installation Location

The following criteria should be considered when selecting the Repeater installation site location:

- Application type
- General surroundings
- Available installation
- Install the Repeater in a shielded, ventilated, and easy-to-reach area.
- Verify that there is a minimum of a 50 cm (20") radius of space around the Repeater, enabling easy access to the repeater for maintenance and on-site inspection.
- Distance from antenna site - It is recommended that the installation location be as close as possible to the antenna site in order to maintain the cable loss to a minimum.
- The Repeater is convection cooled so airflow and alternation should be possible.
- Follow Electro-Static Discharge (ESD) precautions.
- Install the Repeater close to the service area to monitor the output power.
- Use low loss cables to connect the antennas to the Repeater.

2.3.4 RF Cable Installation Guidelines

Required:

- For all coaxial connections to/from the Repeater - high performance, flexible, low loss 50Ω coaxial communications cable.
- All cables shall be weather-resistant type.
- Cable length - determined by the Repeater installation plan. When calculating the cable length, take into account excess cable slack so as not to limit the insertion paths.

3 Dual-Band Repeater Installation

This section describes two types of installation procedures:

- Single DIGImini unit – section 3.1
- Quad-band assembly consisting of two DIGImini units – section 14.

3.1 Single Unit Installation

3.1.1 Overview

NOTE: The Donor and Mobile antennas can be positioned and installed (without being connected to the Repeater) at any time either before or after mounting and grounding the Repeater.

1. Unpack the Repeater kit.
2. Mount the Bracket on the wall, hang the Repeater and Power Supply on the bracket (**do not connect power**).
3. Perform the required isolation and link tests.
4. Connect the antennas.
5. Power-on the Repeater.
6. If a DMCU is available, mount the unit (adjacent to the Repeater, on the wall, and connect to the Repeater according to the instructions in Chapter 6 - DMCU Installation and Management.

3.1.2 Required Tools and Materials







The following is required in order to install the Repeater:

- Standard professional tool box
- A computer (i.e. laptop for running the setup)

3.1.3 DIGImini Dual-band Kit

Upon receiving the Repeater, perform the following:

1. Examine the shipping container for damage before unpacking the unit.
2. Perform a visual inspection to reveal any physical damage to the equipment.
3. Verify that all of the equipment (listed below) is included. Otherwise contact Axell Wireless.

DIGImini Repeater Kit	
Description	Image
DIGImini Repeater	
Wallmount Bracket	
Repeater Power Supply (12V)	
2 x Ties for securing power supply	
CD with documentation	
Ethernet Cross-cable	
4 x Repeater Mounting Bolts & Washers	

3.1.4 Mounting Repeater

Choose the location of the Repeater on the wall according to the following criteria:

- The location should be at normal eye level height, above ground.
- Be sure to allow easy access to the Repeater for maintenance and on-site inspection.

WARNING!!! THE REPEATER MUST ALWAYS BE INSTALLED VERTICALLY AND TOP-DOWN, TO ALLOW FREE-FLOW OF COOLING AIR. HORIZONTAL INSTALLATION ON A BENCH FOR PROLONGED PERIOD OF TIME MAY CAUSE DAMAGE TO THE REPEATER DUE TO OVER-HEATING

To mount the Repeater on the wall

1. Using the bracket for reference to the bolt locations, insert the appropriate bolts (not supplied) on the wall, according to the type of wall.
2. Hang the bracket on the wall.

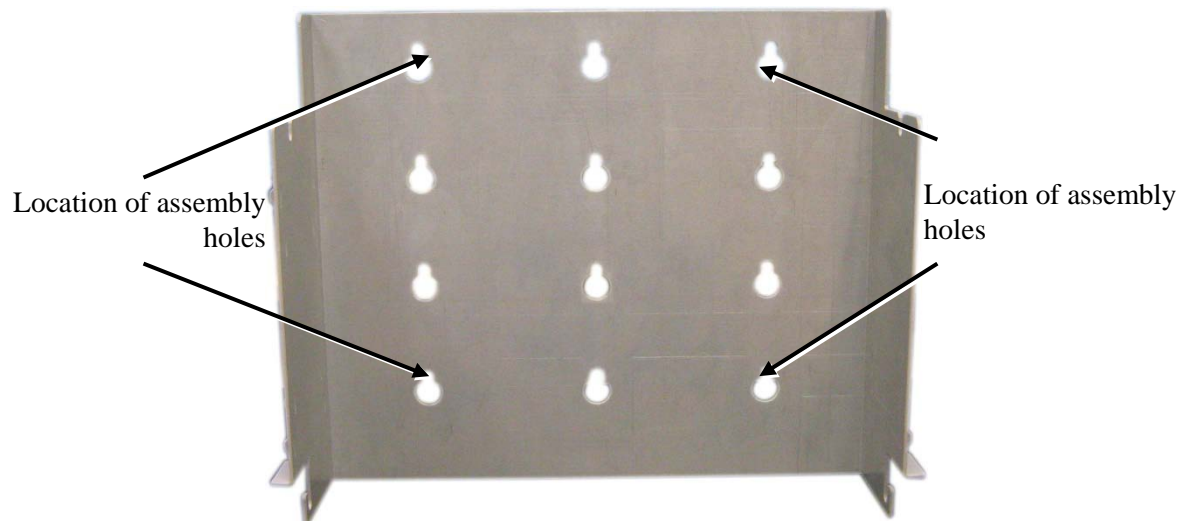

Figure 3-1. Mounting the Bracket on the Wall

PRODUCT DESCRIPTION AND USER'S MANUAL

The bracket provides two main capabilities:

- Four slots (two bottom and two top) on which to hang the Repeater.
- A step and loops on each side of the bracket for securing the power supply (on any of the sides).

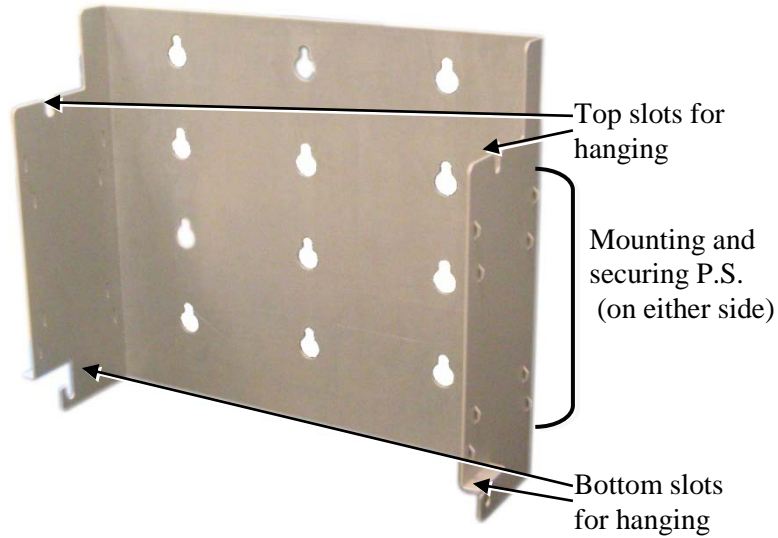

Figure 3-2. Bracket description

3. Hang the Repeater on the Bracket, ridges facing outwards as illustrated below. Use repeater (four) SIDE screws to hang the Repeater securely on the bracket side slots

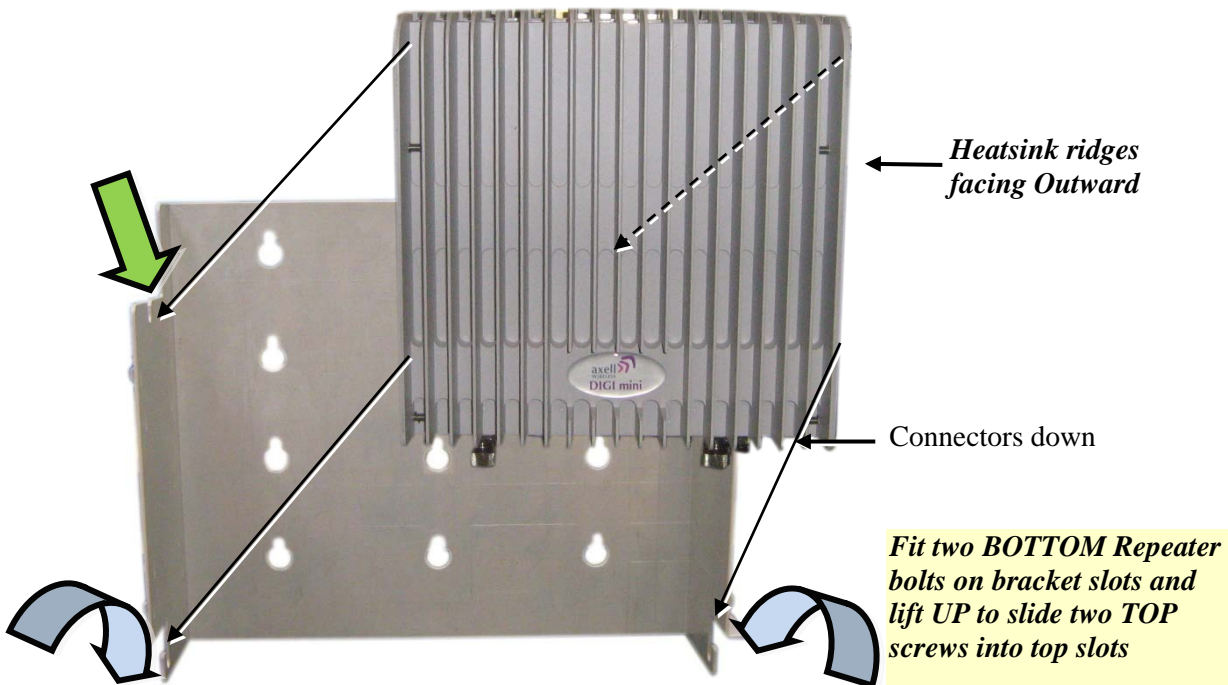

Figure 3-3. DIGImini to Bracket Mounting

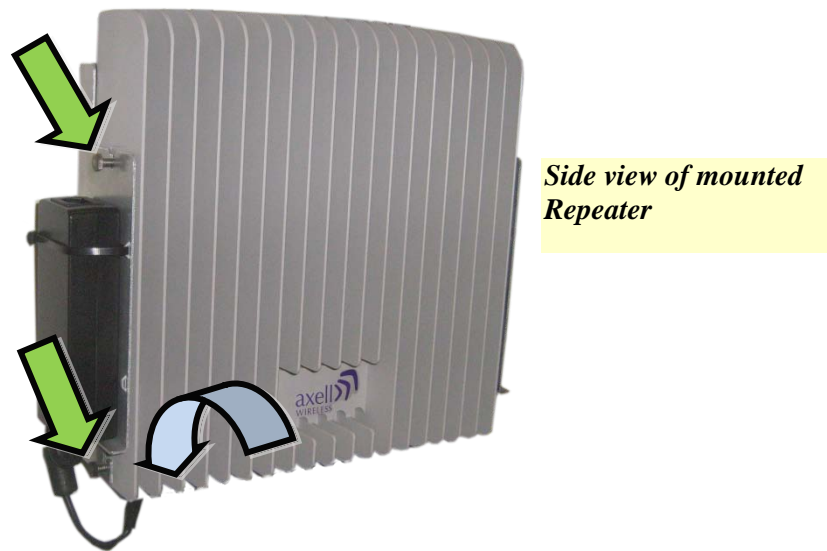

Figure 3-4. Hanging Repeater on Bracket

4. Verify that the Repeater is firmly mounted and *tighten* the Repeater bolts so it is secured to the wall mount bracket.
5. To mount the Repeater Power Supply:
 - Pass two **ties** through the **loops** at the side of the bracket.
 - Position the PS on either side of the bracket, firmly on the **step** and secure the power supply to the bracket using the ties.
 - Trim the ties

WARNING!!! DO NOT CONNECT POWER AT THIS POINT.



Figure 3-5. Mounting P.S.

3.1.5 Before Connecting the Antennas or Power

Before connecting the antennas or power perform the following procedures described in this section:

- Verify isolation between the donor and mobile antennas
- Verify link between the BTS and the Repeater

3.1.5.1 Verifying Antenna Isolation between Donor and Mobile Antennas

The isolation between the Base/Donor and Mobile/Service antennas is critical. Lower isolation can lead to high in-band ripple, oscillations and low signal quality.

The isolation between the Base/Donor and Mobile/Service antennas is critical especially for high gain, outdoor applications.

- For proper operation of the Repeater, it is recommended that the isolation between the Donor and Service antennas be at least 10dB higher than the Repeaters set gain.
- Insure proper vertical or horizontal distance separation between Donor and Service antennas

NOTE: Lower isolation can lead to high in-band ripple, oscillations and low signal quality.

To measure the isolation, proceed as follows:

1. Inject a known signal from a signal generator into one antenna (preferably the Donor antenna).
2. Measure the coupled output from the Service antenna, using the Spectrum analyzer and LNA if applicable.
3. Perform this procedure across the frequency range of both the Uplink and Downlink bands.
4. Register the lower result for system operation.

3.1.5.2 Verifying Link between the BTS and the Repeater

WARNING!

PERFORM THIS PROCEDURE BEFORE CONNECTING THE ANTENNAS TO THE REPEATER OR POWERING ON THE REPEATER. THE REPEATER SHOULD NOT BE OPERATED PRIOR TO THE VERIFICATION OF THE OPERATING PARAMETER IN ITS INSTALLATION ENVIRONMENT.

Before connecting the antennas or powering up the Repeater, verifying the Link between the BTS and the Repeater

This test checks the signal strength from the BTS antenna to the Repeater.

Proceed as follows:

1. Using a Spectrum analyzer, measure the received signal from BTS at the Donor antenna port near the Repeater.
2. Adjust the Donor antenna direction to receive the maximum signal strength.
3. Compare the received signal strength with the calculated signal strength from the design phase.
In case of discrepancy, check for one of the following:
 - Antenna out of direction
 - Antenna tuned to side lobe instead of main lobe
 - Antenna connector or antenna cable faulty
 - Line-of-sight problem (obstruction), etc.
4. Register the signal strength of the downlink channel for the system operation phase.

3.1.6 Antenna Connections

CAUTION! DO NOT CONNECT THE ANTENNA CABLES TO THE REPEATER BEFORE VERIFYING THE INSTALLATION PARAMETERS.

CAUTION! DO NOT POWER-UP THE REPEATER WITHOUT EITHER THE ANTENNAS BEING CONNECTED OR THE ANTENNA CONNECTIONS TERMINATED WITH DUMMY LOADS.

To connect the antennas to the Repeater

NOTE: If the coaxial cables are NOT weather-resistant type, wrap the exterior coaxial cables with insulation and holding tape (Type 3M Rubber splicing tape) for environmental protection and to ensure longer lifetime.

1. Install the antenna cables along their path to the Repeater, and connect them to the Antennas.

NOTE: Be sure to use low loss cables.

2. Connect the Donor antenna to the Repeater BASE port. (Donor antenna specifications and installation criteria are described in section 2.1).
3. Connect the Service antenna to the Repeater MOBILE port. (Mobile antenna specifications and installation criteria are described in section 2.2).
4. Verify all RF connectors are tightened and the cables and antennas are secured.



Figure 3-6. Antenna Connections

3.1.7 Power Up

To power up

Connect the Repeater P.S. to the AC power outlet and to the Repeater DC connector.



Figure 3-7. Powering Up

3.1.8 What Next?

- Installations *without* DIGImini Control Unit (DMCU) – continue to Chapter 5 - Setup and Configuration
- Installations *with* DMCU – refer to Chapter 6 - DMCU Installation and Management.

4 Two Dual Units (Quad-band) Installation

This procedure describes how to assemble and install the DIGImini Quad-band assembly consisting of two repeaters. *If your installation includes a DMCU, only one DMCU is required for the complete quad-band assembly (two repeaters).*

4.1 Overview

NOTE: The Donor and Mobile antennas can be positioned and installed (**without being connected to a Repeater**) at any time either before or after mounting and grounding the Repeater.

1. Unpack the Repeater Tri/Quad-band kit.
2. Mount the wallmount bracket on the wall
3. Assemble the **RF Combiners** and **Combiner Spacers** onto the **Quad-band brackets**.
4. Using the supplied brackets, position the repeaters back to back on a flat surface and interconnect the required interfaces as described in section 4.5.
5. Pick-up the two-Repeater assembly and hang on the mounted wall bracket.
6. Mount the Power Supplies on the wall bracket (**do not connect power**).
7. Perform the required isolation and link tests.
8. Connect the antennas.
9. Power-on the Repeater.
10. For installations with a DMCU is available, mount the unit (adjacent to the Repeater, on the wall, and connect to the Repeater according to the instructions in Chapter 6.

4.2 View of the Quad Band Installation

The following figure illustrates the Triple/Quad-band DIGI-mini assembly.

Note the following:

- The Tri/Quad-band assembly supports the same basic interfaces (ETH, Power, LEDs) as the Single/Dual-band unit (see 1.6. DIGImini Interfaces) *in addition to two RF combiners*, mounted on each side bracket.
- The front panel LED interfaces are interconnected and covered with a common tab.

Note: Illustration below shows a bottom view of the mounted Quad-band assembly (connectors face down when the assembly is wall mounted).

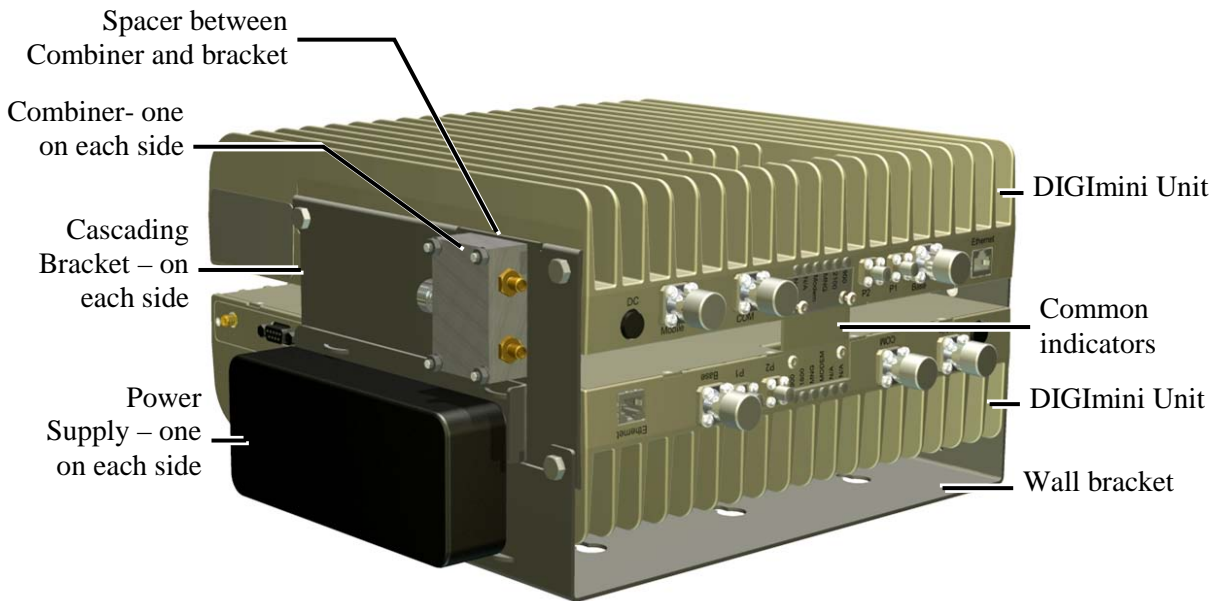

Figure 4-1: Cascaded DIGImini Tri-band/ Quad-band

4.3 Required Tools and Materials

The following is required in order to install the Repeater:

- Standard professional tool box
- A computer (i.e. laptop for running the setup)

4.4 DIGImini Tri/Quad-band Kit

The Quad-Band Upgrade Accessory Kit contents are packaged in a single box, consisting of *three layers* of items as shown and *additional items (screws, ties, etc.) that may be located in any of the layers.*



Figure 4-2. Quad-Band Upgrade Accessory Kit Package

Upon receiving the kit, perform the following:

1. Examine the shipping container for damage before unpacking the unit.
2. Perform a visual inspection to reveal any physical damage to the items.
3. Verify that all of the items are included in the relevant layer as described. Otherwise contact Axell Wireless.

4.4.1 Top Layer Items

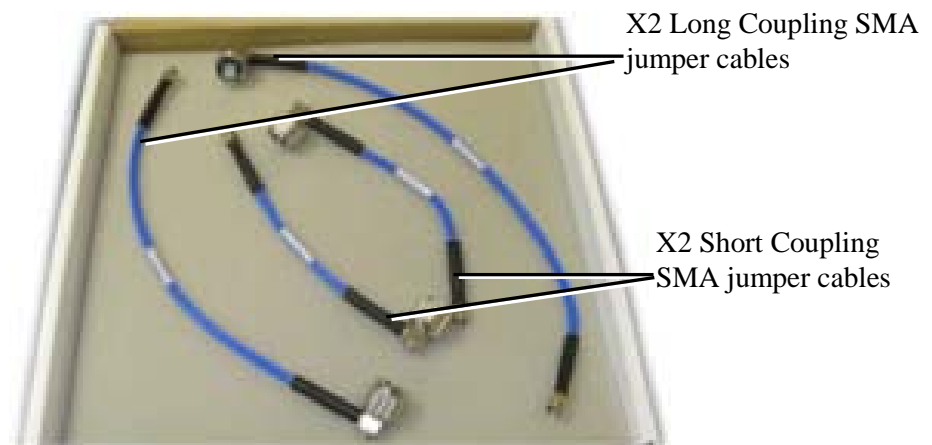

Figure 4-3. Quad-Band Upgrade Accessory Kit – Top Layer

4.4.2 Middle layer Items

NOTE: References to Type I and Type II DIGImini models are explained in the following sections when the relevant instructions are given.

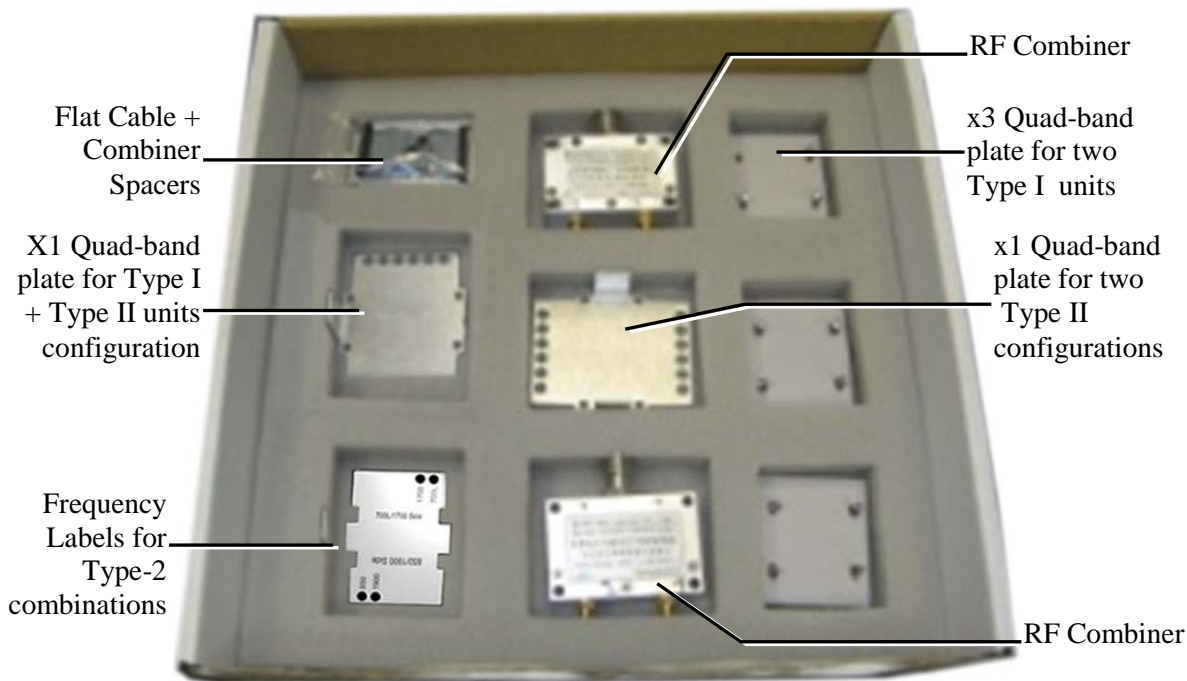

Figure 4-4. Quad-Band Upgrade Accessory Kit -Middle Layer items

4.4.3 Bottom Layer Items

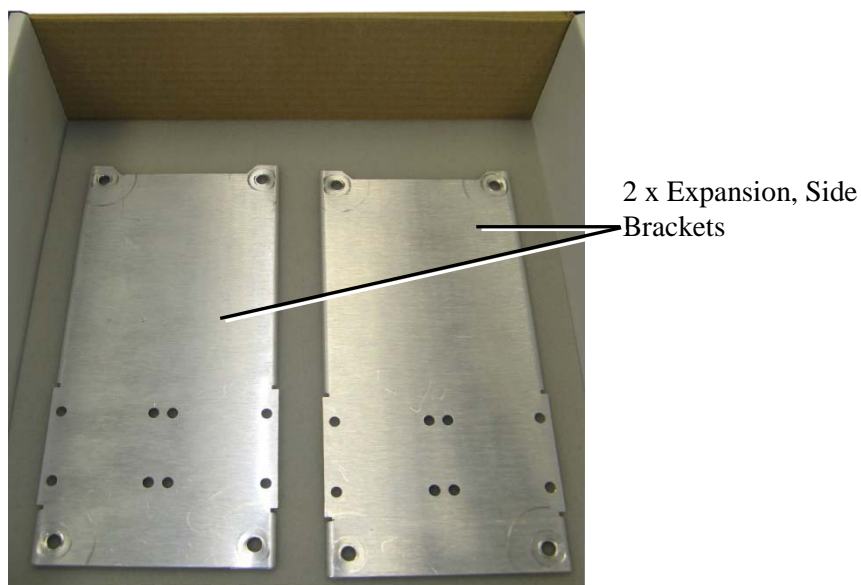



Figure 4-5. Quad-Band Upgrade Accessory Kit-Bottom Layer Items

4.4.4 Additional Items

The following additional items are included in the accessory kit and may be packaged in any one of the layers.

Item	Image
8 x Bolts, 8 x Nuts – for Combiner to Spacer to Bracket assembly	
4 x Repeater Mounting Bolts	
Ties - used for securing power supply (only x2 are required for each power supply – extra ties may be included in the kit)	
4 x Screws (In use only with the flat cable cover plate of new chassis (any Type 2 combination), to connect the plate)	

4.5 Upgrading to a Quad-Band System

4.5.1 Assemble the DIGImini Units

The upgrading procedure is partially performed on a flat surface.

1. To upgrade an existing DIGImini Dual band installation:
 - Remove power from the currently mounted DIGImini.
 - Disconnect all antenna, communication and control cables.
 - Loosen the side screws and remove the Repeater – *leaving the wallmount bracket on the wall.*
 - Continue with step-3.
2. For a complete Tri/Quad-band installation (no existing unit):

*Note: If holes are to be drilled, use the bracket to mark the hole locations **prior** to the following assembly procedure.*

- Follow the (wallmount) bracket mounting instructions in 3.1.4 - Mounting Repeater.
- Continue to following Step -3.

3. **If not already assembled:**

Assemble each **Combiner** and **Spacer** to a **Bracket** – using the supplied bolts, washers and nuts for each assembly. *Note direction of bracket.*

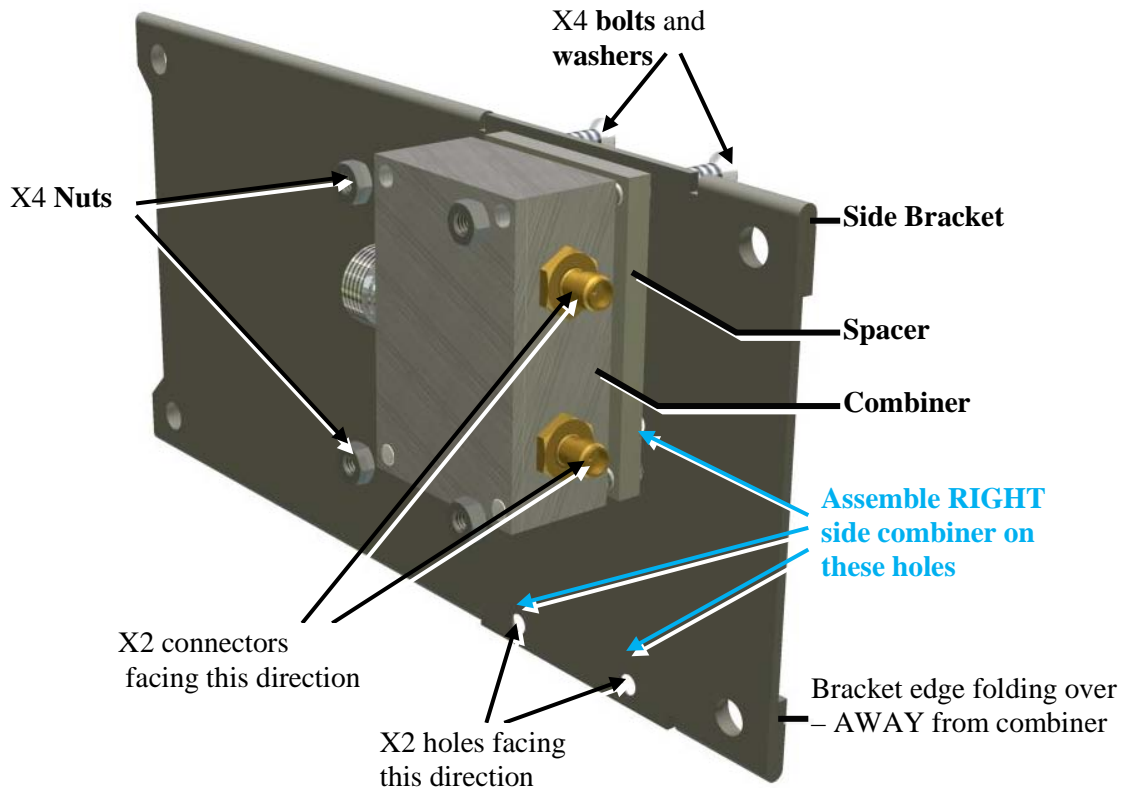

Figure 4-6. Combiner and Spacer Secured to Side Cascading Bracket

4. Assemble Side Brackets on **bottom** Repeater:

- Place one of the Repeaters on a flat surface – **ridges facing down**. This will be the **bottom** repeater.
- **Noting orientation - loosely** assemble the side plate brackets on both sides of the **bottom** repeater.

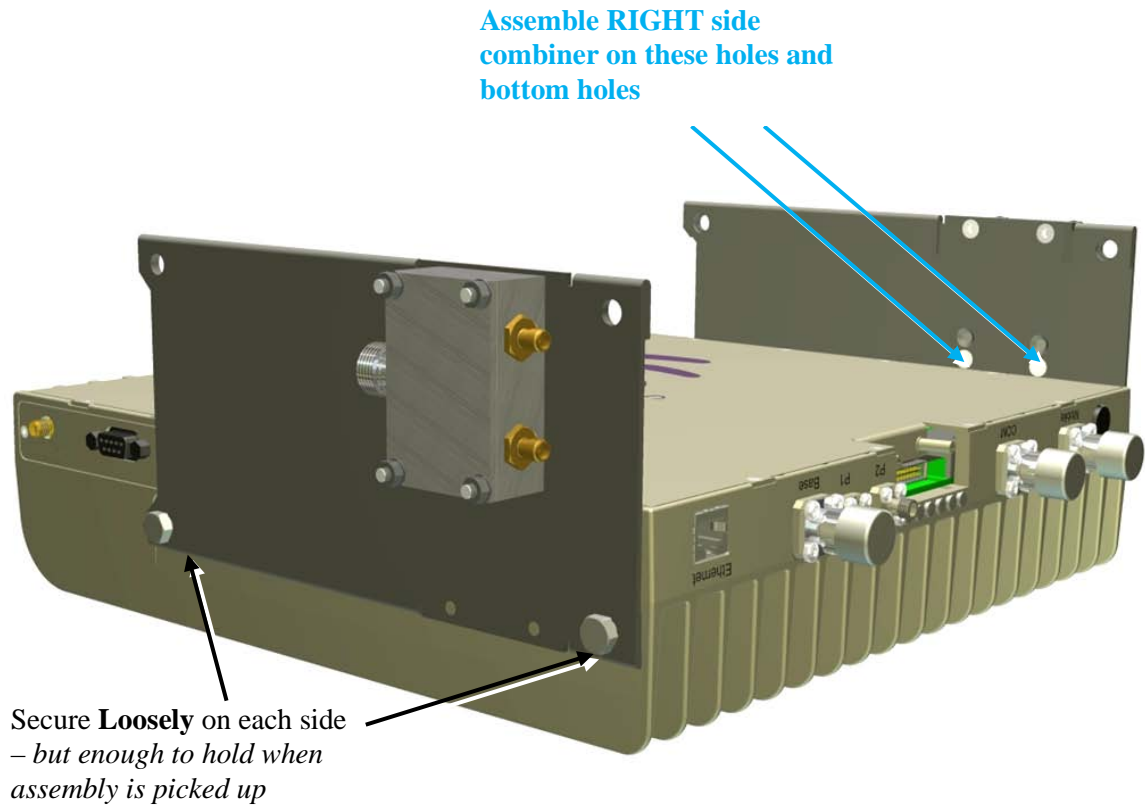

Figure 4-7. Assemble Side Brackets on Bottom Repeater

5. Assemble **top** Repeater:

- Place **second repeater** back-to-back (flat surfaces together) on bottom repeater.
- Align the **top repeater holes** with the **top side bracket holes** and **tightly secure**. (You may need to place your hand between the two repeaters in order to maintain the appropriate separation between the repeaters, allowing the alignment of the bracket holes to the repeaters.)

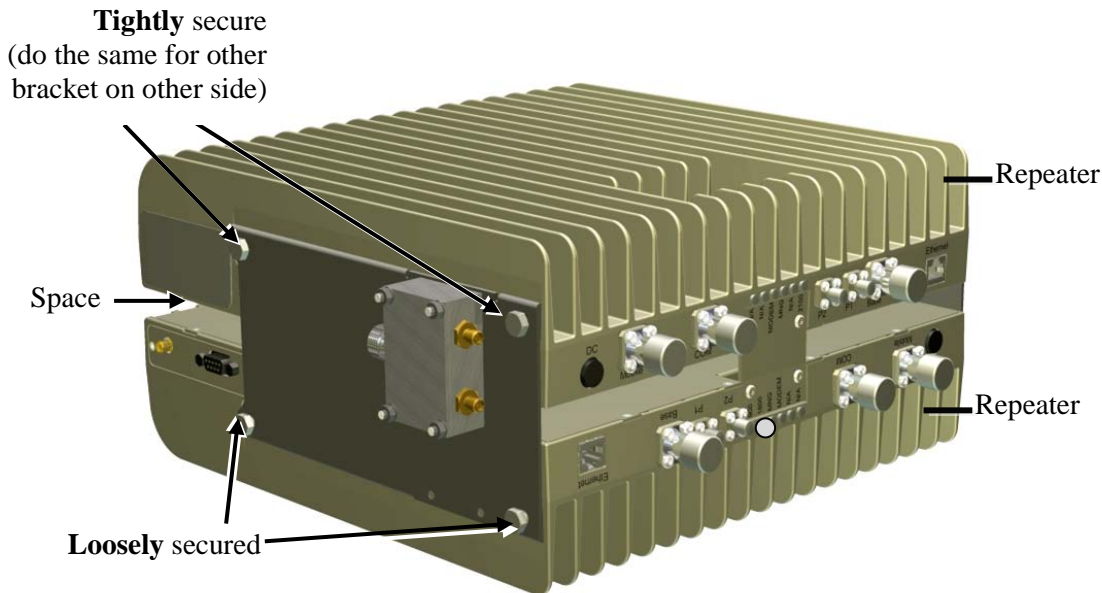

Figure 4-8. Assemble Top Repeater

6. **Remove the LED plates** of BOTH Repeaters and set them aside.

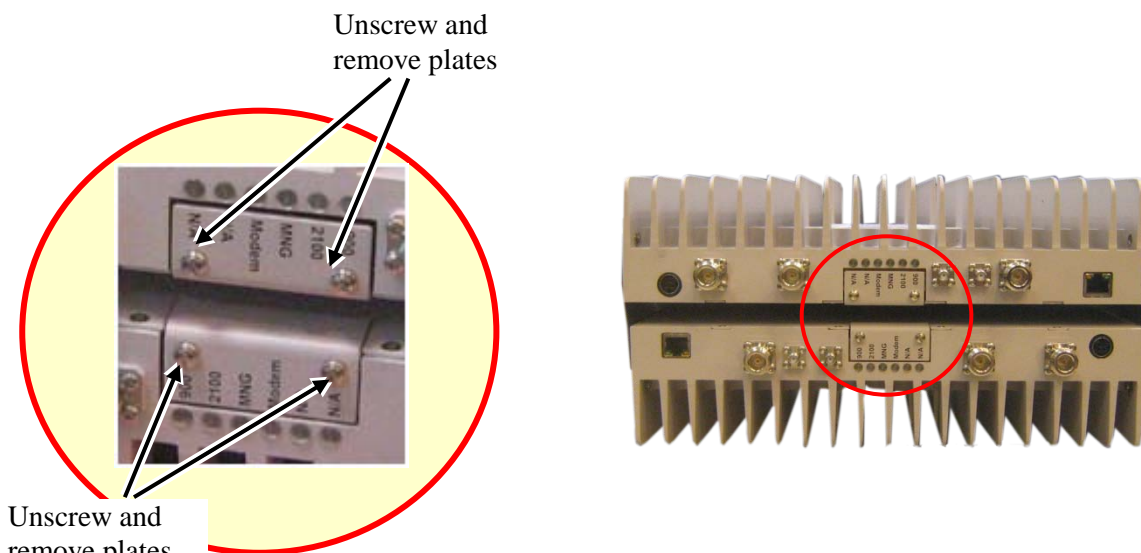

Figure 4-9. Removing Dedicated Tabs

7. **Carefully, connect the supplied flat cable** between the two connectors as shown below. Verify that the flat-cable is securely connected.

NOTE: Handle Flat Cable with care when connecting.

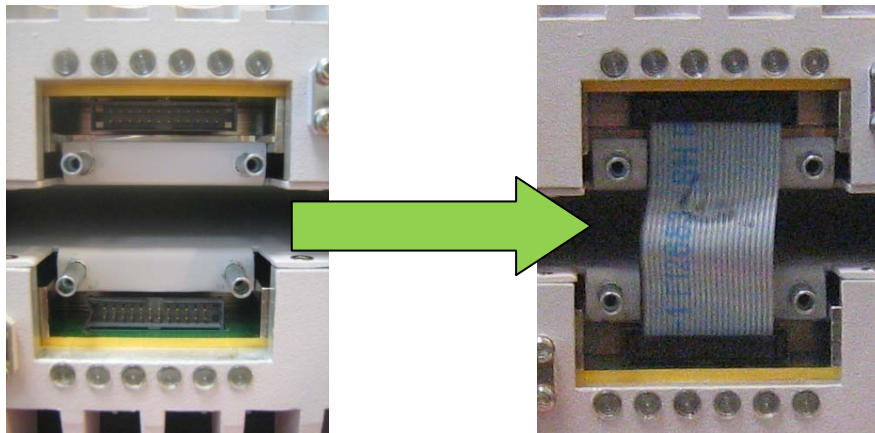

Figure 4-10. Interconnecting Flat cable

8. Cover the flat-cable with the provided **Flat Cable Cover Plate** and secure using the four screws. *Choose the appropriate cover plate (and also label for some plates) according to the criteria described in following section.*

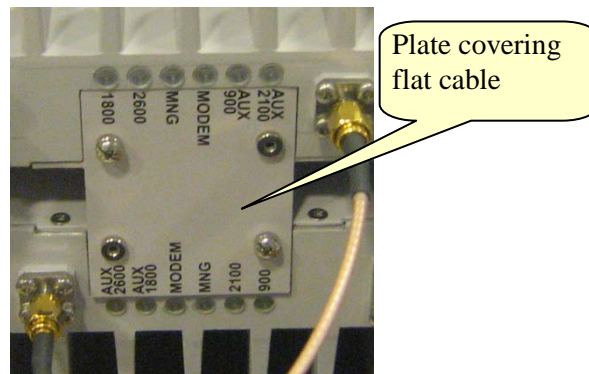

Figure 4-11. Assembling Interconnecting Cover Plate

4.5.2 Assembling Quad-Band Plates and Labels

The LED plates and markings on the DIGImini units to be combined will be one or a combination of Type I, or/and Type II as shown below.

There are two differences:

- Label markings – without N/A (Type I) or with N/A (Type-II)
- LEDs are covered (Type II) or not covered (type I) by tab

NOTE: The frequencies are examples.

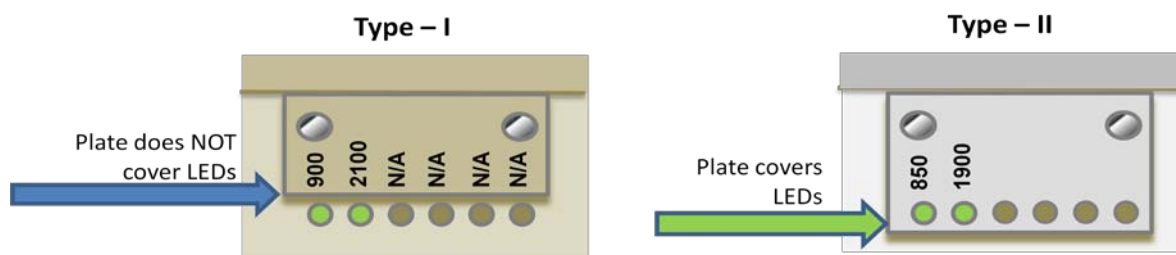

Three different Quad-Band plate types are provided for the following quad-band combinations:

- Both units in quad-band are Type I
- Both units in quad-band are Type II
- One of each Type (Type I + Type II)

4.5.2.1 Both DIGimini Units are Type I

IMPORTANT!!! Be sure to choose the proper frequency label for each unit- note direction.

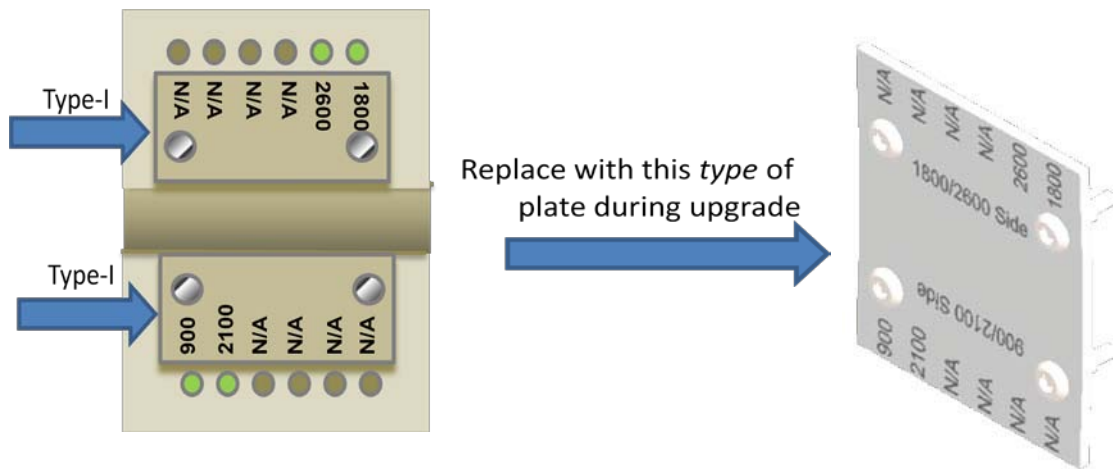

4.5.2.2 Both DIGimini Units are Type II

Use the following **tab** and **label** type (label according to frequency).

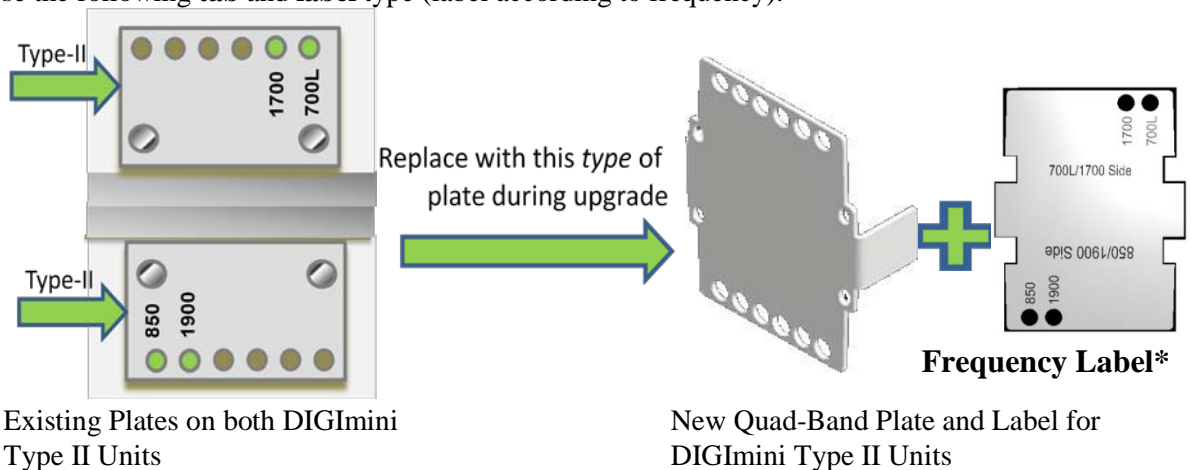

*Choose appropriate label according to the original frequencies of each unit and stick on tab

4.5.2.3 Combination of Type I and Type II DIGimini Units

Use the following **tab** and **label** type (label according to frequency).

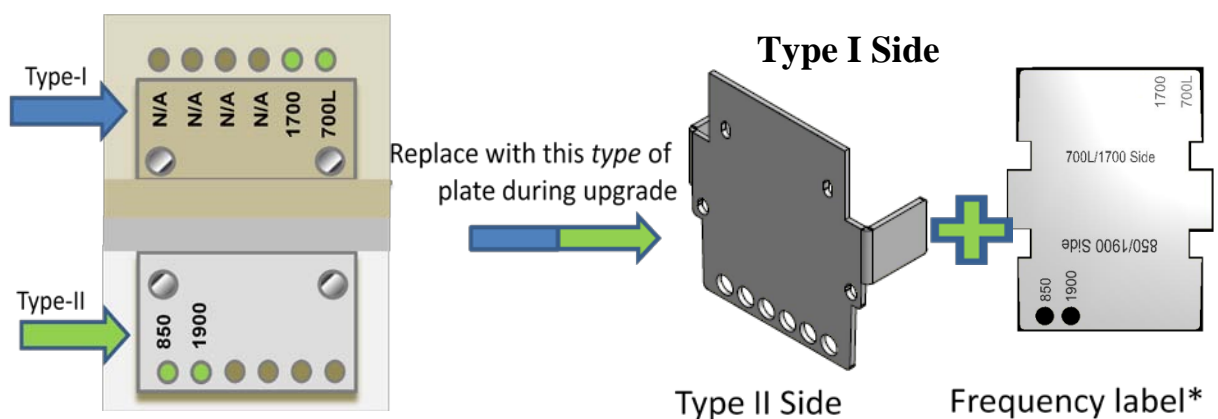

*Choose appropriate label according to the original frequencies of each unit and stick on tab

4.5.3 Connect SMA Jumper Cables

Connect **SMA N-type jumper** cables between **Combiners and Repeater antenna ports** according to the illustration below:

NOTE: Be sure to use recommended Torque value.

Jumper Type	Connect Between
Short (170mm)	Connect between connectors labeled 1 (i.e 1 to 1)
Short (170mm)	Connect between connectors labeled 4 (i.e 4 to 4)
Long (340mm)	Connect between connectors labeled 2 (i.e 2 to 2)
Long (290mm)	Connect between connectors labeled 3 (i.e 3 to 3)

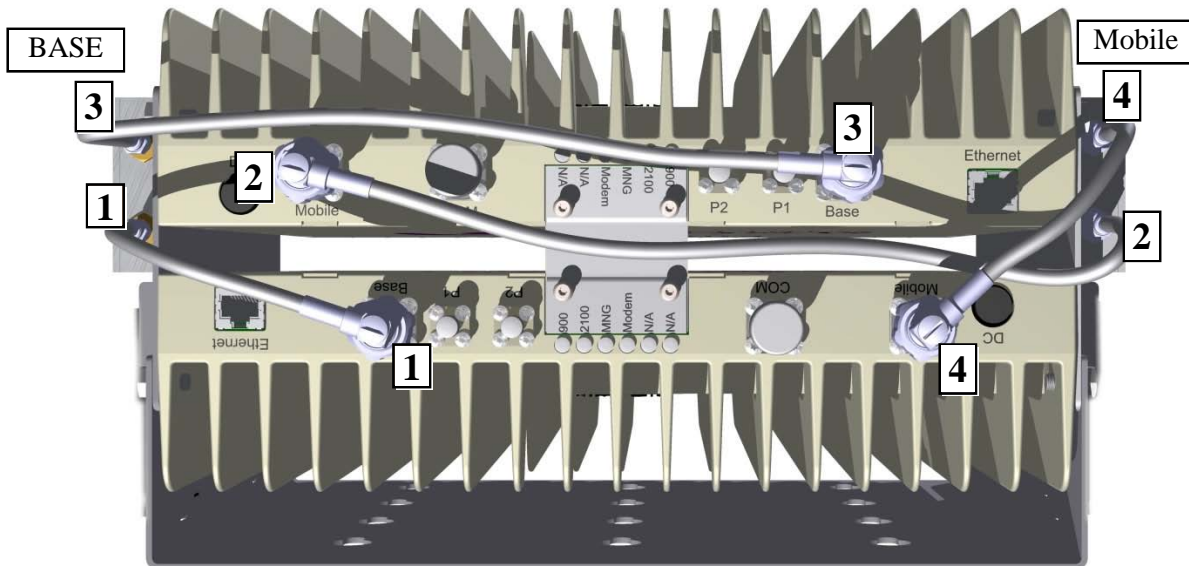

Figure 4-12. DIGImini Tri/Quad-Band Jumper Connections

9. Referring to the following figure:

- *Carefully and securely pick up the assembly.*
- Hang the assembly on the wall bracket, fitting the *looser* bottom Repeater **Side Bracket** screws on the wall bracket.
- **Tighten the loose screws on each side.**

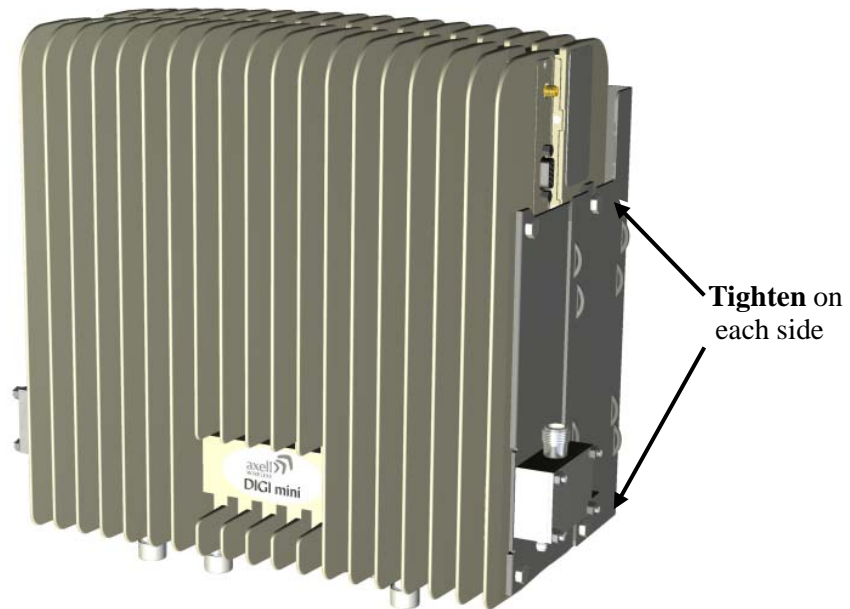

Figure 4-13. Mount Quadband Assembly on Wallbracket

10. **Two Power Supplies should be assembled on the wallbracket** (one on each side of the assembly). Mount one (if this is an upgrade and one is already mounted) or both (if this is a new installation) as follows:

- Thread two ties through the loops in the bracket.

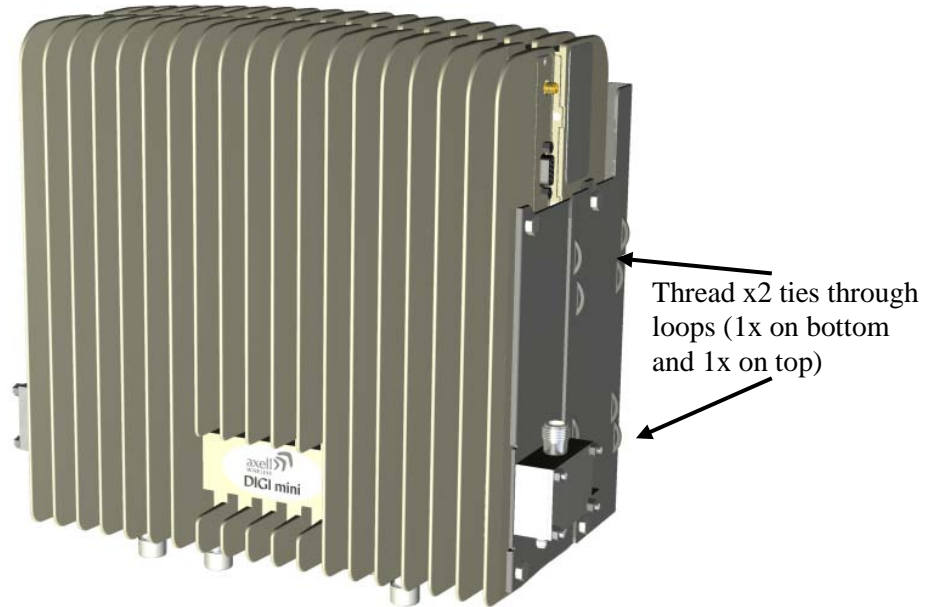

Figure 4-14. Insert Ties for Securing Power Supply

- Fit Power Supplies on ridge(s) on side of wall bracket.
- Secure the ties.

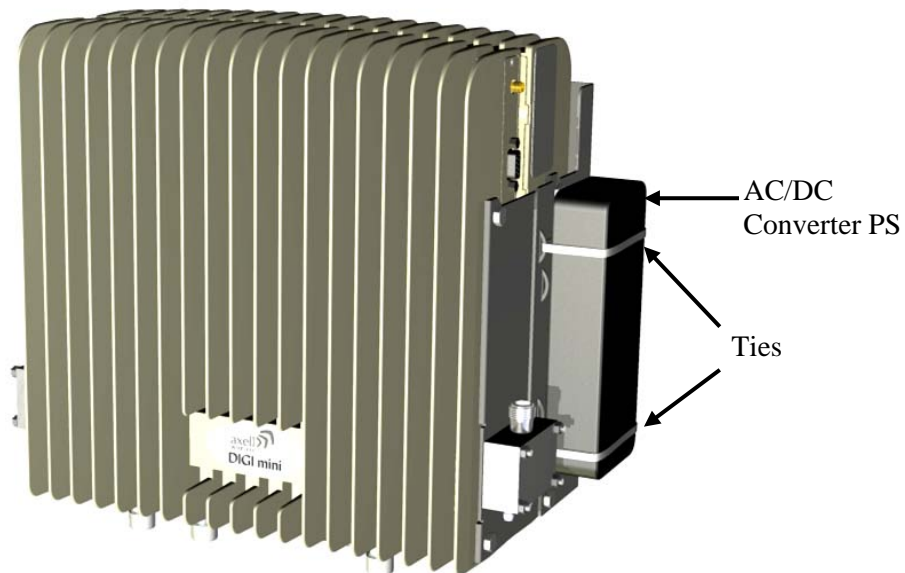

Figure 4-15. Secure Power Supply

4.5.4 Before Connecting the Antennas or Power

Before connecting the antennas or power perform the procedures described in section .

4.5.5 Antenna Connections

CAUTION! DO NOT CONNECT THE ANTENNA CABLES TO THE REPEATER BEFORE VERIFYING THE INSTALLATION PARAMETERS.

CAUTION! DO NOT POWER-UP THE REPEATER WITHOUT EITHER THE ANTENNAS BEING CONNECTED OR THE ANTENNA CONNECTIONS TERMINATED WITH DUMMY LOADS.

To connect the antennas to the Repeater

NOTE: If the coaxial cables are NOT weather-resistant type, wrap the exterior coaxial cables with insulation and holding tape (Type 3M Rubber splicing tape) for environmental protection and to ensure longer lifetime.

1. Install the antenna cables along their path to the Repeater, and connect them to the Antennas.

NOTE: Be sure to use low loss cables.

2. Connect the **Donor (Base)** antenna to the **rear port of the LEFT Combiner** (connected to the Repeater BASE ports). (Donor antenna specifications and installation criteria are described in section 2.1).
3. Connect the **Service** antenna to the **rear port of the RIGHT Combiner** (connected to the Repeater MOBILE ports.) (Mobile antenna specifications and installation criteria are described in section 2.2).
4. Verify all RF connectors are tightened and the cables and antennas are secured.

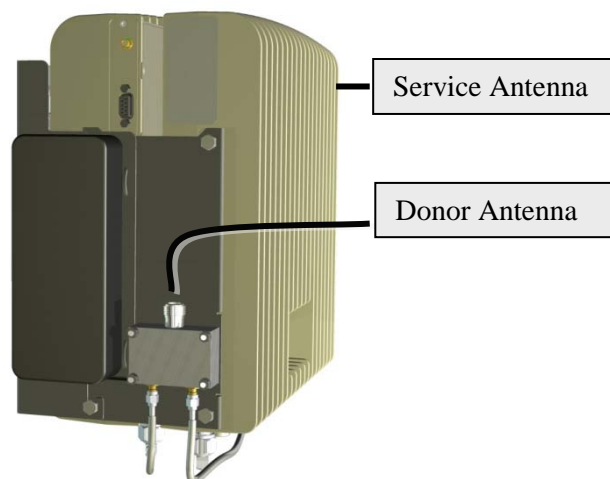

Figure 4-16. Service and Donor Antenna Connections

4.5.6 Power Up

To power up

1. Connect each Power Supply (AC/DC Converter) output to a Repeater front panel **DC power connector**.
2. Connect each of the Repeater P.S. units' to the AC power outlet.

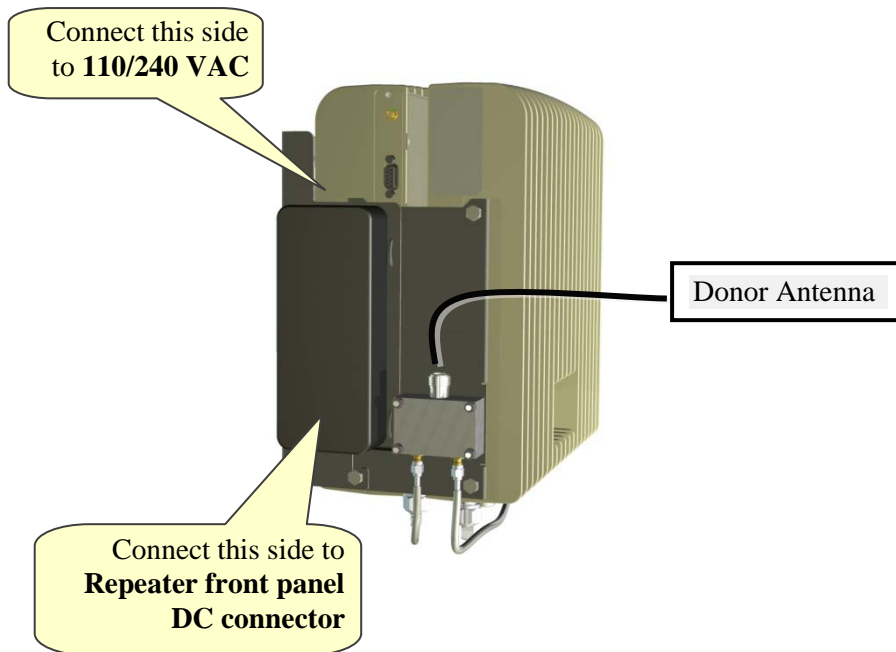

Figure 4-17. Powering Up (shown with illustration of Combiner)

4.5.7 What Next?

- Installations *without* DIGImini Control Unit (DMCU) – continue to 5 - Setup and Configuration.
- Installations *with* DMCU – refer to Chapter 6 - DMCU Installation and Management.

5 Setup and Configuration

*NOTE: This section is relevant to installations that do **not** include DMCU. For installations with DMCU unit, continue to Chapter 6.*

The Mini-Repeater is designed for simple plug-and-play operation, only requiring the setup of a number of parameters (such as DL Output Power, bandwidth, and gain) through a local Web connection and verifying that the system is operating properly.

The setup procedure consists of the following steps:

1. Open a local Web session to the Repeater.
 If you are not familiar with the Axell Web Access application, it is recommended to quickly review the Navigating the Web GUI Application section.
2. Adjust the signal levels and configuring the sub-bands and verify that no Alarms are generated.

5.1 Open a Direct Local WEB Session to the Repeater

These instructions are valid only for installations without a DMCU.

To connect directly to the Repeater

1. Connect the supplied Ethernet cross-cable from the computer to the Repeaters' front panel.

ATTENTION! Do not connect the Repeater ETH port to the network. It may affect your network! Remote management is available only via a DMCU.

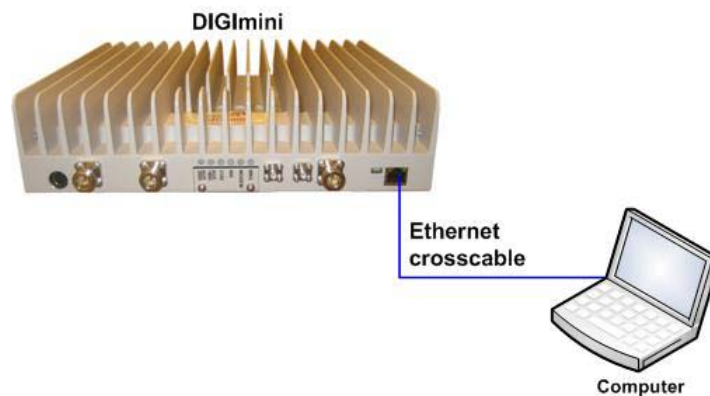

Figure 5-1. Ethernet Connection to a Single DIGImini Repeater

PRODUCT DESCRIPTION AND USER'S MANUAL

- If connecting to the Tri/Quad-band assembly, connect the cable to *any* of the two repeaters. The Web GUI will allow for configuration of **both** repeaters.

Connect to either unit

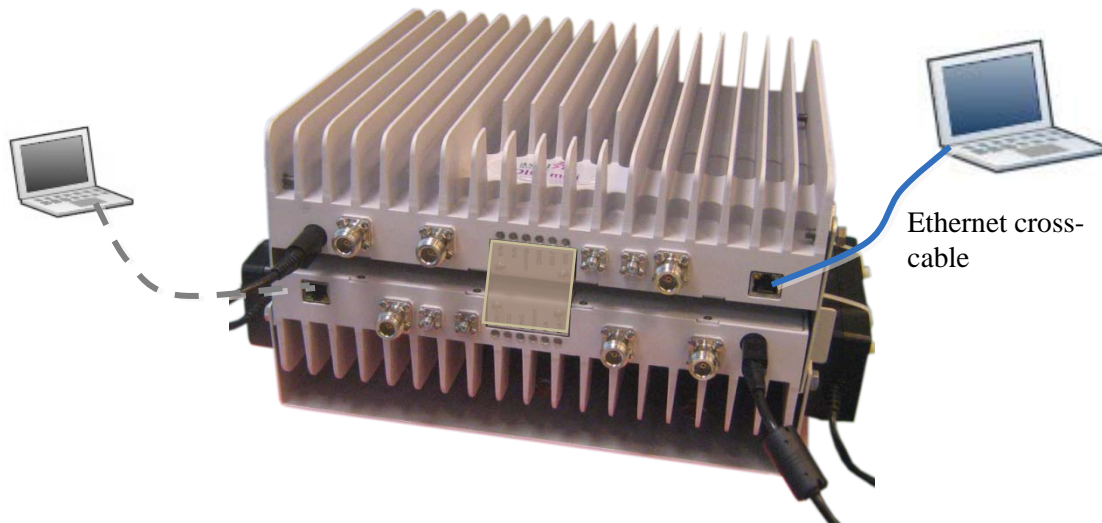
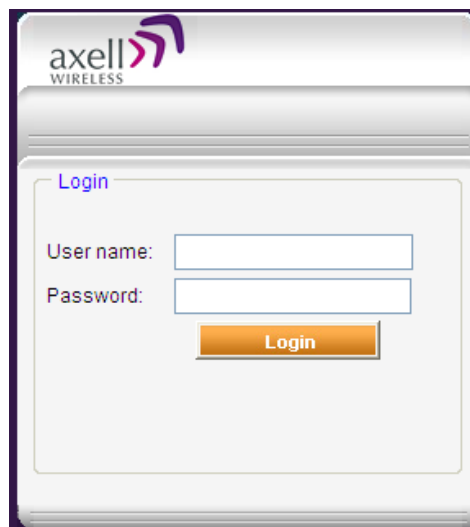

Figure 5-2: Cascaded DIGImini Tri-band and Quad-band

- In the address line, type *digimini* or enter the default IP address of the Repeater. <http://192.168.1.253>. A session will be established with the Repeater and the login dialog appears.



- Type the default User Name **admin** and the default Password **admin**.

NOTE: Bothe entries are case sensitive and must be entered with lower case letters.

- Click **Login**. The application main window appears.
- Quickly review the following section describing the application window and then proceed to configure the signal levels according to section 5.2.3.

5.2 Navigating the Web GUI Application

This section describes how to navigate the Web Management application. The Web Access interface provides Repeater RF parameters control and monitoring options. The displayed bands depend on the supported configuration: Single, Dual, Triple or Quad band configuration.

*NOTE: The **CMU** (Control Monitoring Unit) item in the topology tree is only accessible for sessions opened via the **Digital Monitoring Control Unit (DMCU)** - see section 6.5.2 for details. For sessions opened by direct connection to a DIGImini front panel, the CMU item will appear but will not be accessible.*



Figure 5-3. Example of Web GUI Screen (shows dual-band)

5.2.1 Band Pane and Tabs

The upper area of each selected pane shows the tabs corresponding to that pane.



Item	Description / Values
Alarms	Displays various alarms generated by the Repeater and enables monitoring
Control and Params	Used for adjusting RF parameters and channel configuration (signal level, gain and bandwidth)
Band Info	Shows information on the selected band, including valid definable bandwidth pre sub-band.

5.2.2 Operation Buttons

The following Operation buttons are available.



Item	Description / Values
Selected Tree Item	Shows the currently selected topology tree item. Values: Band (e.g. 850-1900), Users
Send	Click after completing the new data input and values update in any screen in order to insert the new values into the Repeater, and implement the changes
Refresh	Click to refresh the current screen and update the displayed data
Help	Click Help to display an e-guide line for the system operation. This Help is general by its nature and some features may not be included.

5.2.3 Signal Levels and Channel Configuration

This section provides a description of the RF Gain setting criteria (set via the Controls and Params Pane), the criteria determining the number of available bands and a step-by-step procedure of the signal level and channel configuration procedure.

5.2.4 RF Gain Setting Criteria

The RF Gain is set automatically by the Repeater's SALC function. The function sets the optimum gain without exceeding the isolation limit.

The gain range is up to 73dB for *all bands* and is set by default to its maximum value.

The gain will then be modified automatically to its optimum value by the SALC mechanism. This mechanism performs gradual learning of traffic load characteristics and adjusts the Repeater RF Gain accordingly. (See section 1.3 for more information on the SALC mechanism).

5.2.5 Bandwidth and the Number of Available Bands

Each repeater supports either one or two bands (single-band or dual-band). Up to *Six sub-bands* may be defined per *two bands per repeater* (e.g. on a dual-band repeater supporting bands 850MHz and 1900MHz, 4 sub-bands may be set for the 850MHz band and 2 sub-bands for the 1900MHz band, with a total sum of 6 sub-bands). The number of available sub-bands or channels depends on the technology and selected bandwidth as detailed below (note that some bandwidths (e.g. 15 or 20MHz at 700/1900 MHz GSM) take up two channel resources).

The information can be viewed via the **Band Info** tab (described on the following page).

Frequency Band (Technology)	Technology	Filter BW	Number of Sub-band Resources
850/1700/1900MHz	CDMA	2.5MHz – 10MHz (in 2.5MHz steps)	1
850/1700/1900MHz	CDMA	12.5MHz – 25MHz (2.5MHz steps)	2
850MHz	CDMA	1.5, 2.5MHz	1
850MHz	CDMA	11MHz	2
700/850/1700/1900MHz	LTE	1.4, 3, 5, 10MHz	1
700/850/1700/1900MHz	LTE	15,20 MHz	2
850/1700/1900	GSM	200KHz- 11,000KHz (in 200KHz steps)	1
850/1700/1900	GSM	11200KHz-25MHz (in 200KHz steps)	2
700/850/1700/1900MHz	WCDMA	5, 10 MHz	1
700/850/1700/1900MHz	WCDMA	15,20, 25 MHz	2

To access the Band Information window

1. From the Tree Pane, select the band (e.g. 850-1900).
2. Select the **Band Info** tab. The relevant parameters are displayed.

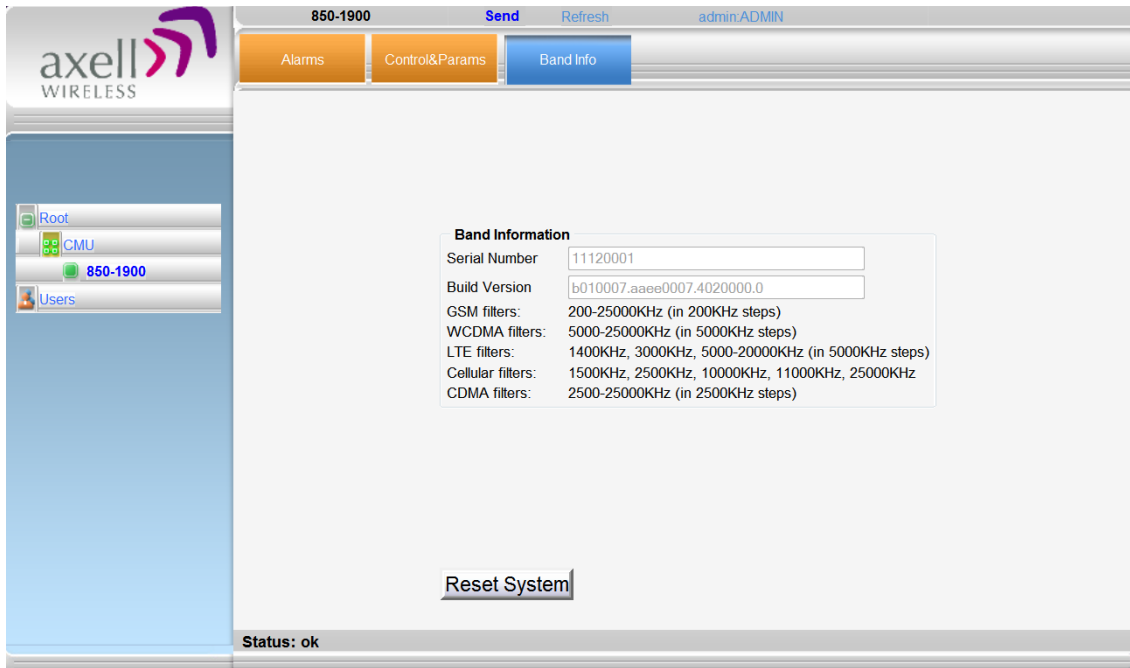

5.2.6 Adjusting the Signal Levels and Configuring Channels

The **Control and Params** (parameters) window is used to configure the sub-bands and Max UL/DL Power for the selected band. A dedicated filter configuration dialog is provided for each of the supported bands (i.e. 700/1700/850/1900) in the **Control and Params** tab. The dialogs and configuration procedures are identical for each band, *except for the parameter values*.

Up to six sub-bands referred to as *filters* can be defined per two bands, where each sub-band is *individually* defined by setting the following:

- Bandwidth - start and stop frequency
- Maximum power
- Maximum gain
- Gain delta

The defined sub-bands are displayed in the lower part of the screen for reference.

To adjust the signal levels and configure the channels

1. In the left pane (Topology Tree), select the supported band configuration (e.g. 850-1900) which includes the **Band** item whose sub-bands are to be configured.
2. Click the **Control and Params** tab. For dual/triple/quad band configurations, *click the required band* for configuration and the corresponding pane appears.

The window is divided into the following areas:

- System – overall parameters for the *selected service*.
- Filter definitions – used to define up to six sub-bands and their RF parameters.
- Sub-bands view – graphical display of defined sub-bands for the service.

Note: You may define up to Six sub-bands per 2 bands, e.g. 4 sub-bands for the 850MHz band and 2 sub-bands for the 1900MHz band (see section 5.2.5 for details).

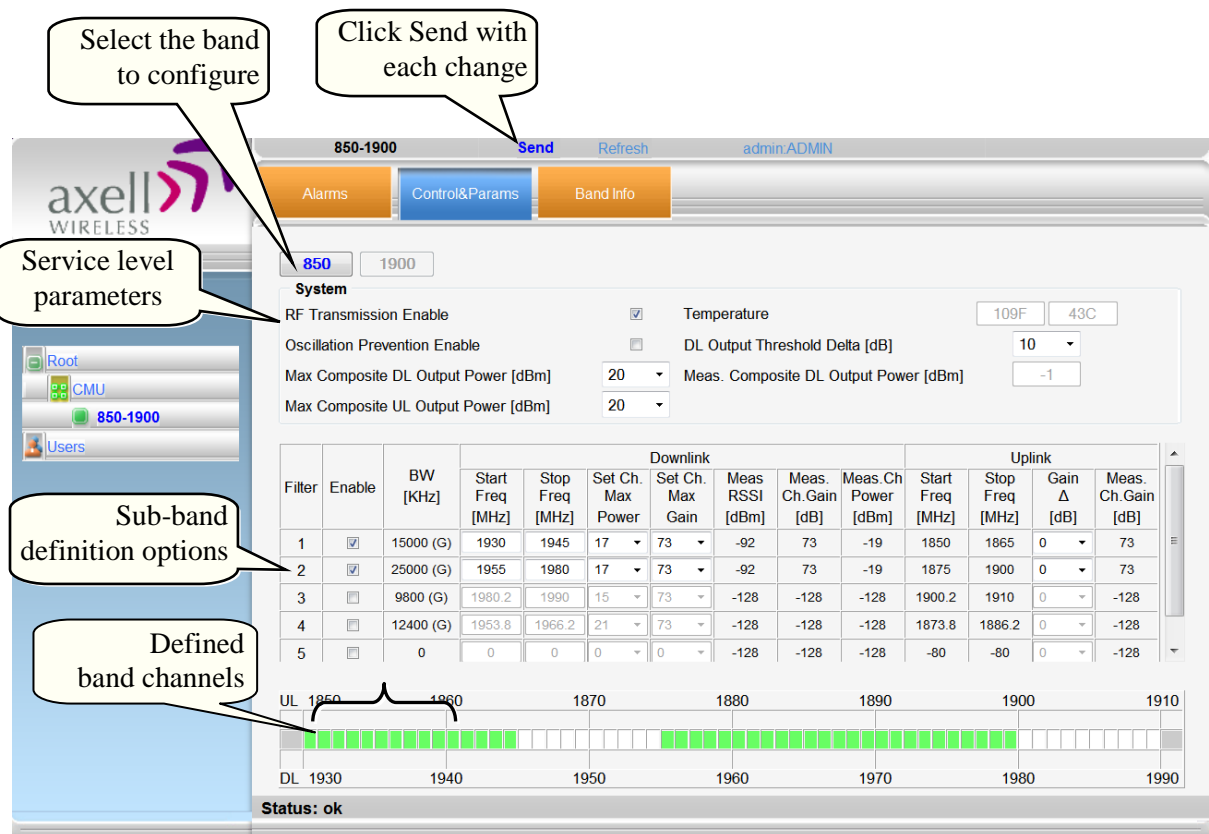

Figure 5-4. Params and Control Tab (example shows quad-band)

3. Set the System Level parameters:
 - Verify that the **RF Transmission Enable** parameter is checked.
 - Set the **Max Composite DL Output Power** according to your site requirements and click **Send**. The Measured Composite DL Output Power is displayed in the adjacent field.

If the composite output power exceeds the defined value, the Smart ALC feature begins working.

- Set the **Max Composite UL Output Power** according to your site requirements.

Additional parameters (not required for initial setup) are:

PRODUCT DESCRIPTION AND USER'S MANUAL

- Oscillation Prevention Enable - Enables oscillation detection mechanism that maintains repeater functionality.
 - Temperature - Displays Repeater ambient temperature.
 - DL Output Threshold Delta (dB) - the delta from the set Composite Output Power, below which the alarm 'Donor power is too low' is activated.
For example, if the DL Output Threshold value is set to 8dB, when the *Measured* Composite DL output power is 8dB less than the *set* Composite Output Power, an alarm is generated.
 - Meas. Composite DL Output Power – displays the currently measured output signal level.
-

4. To configure each sub-band:

- Checkmark **Enable**. The configuration parameters in that row will be available.
- In the Downlink area, set the **Start** and **Stop** DL Frequency (MHz). (The Uplink Start and Stop frequencies will be automatically allocated.)

The defined BW will be displayed in the BW KHz column (to the left of the Start Frequency).

- Set the (Downlink) Max Gain as follows: by default, the **MAX Gain** (DL) parameter is set to its highest level (73dB). Change the **Channel Max Gain** (DL) according to the measured/calculated input power and isolation measurements.
- The recommended Maximum Gain setting is approximately 15 dB less than the isolation between the service and donor antennas.

5. If the site NOISE LEVEL is high enough to cause interference, adjust the noise level as follows:

- Adjust the Gain Delta parameter – this sets the delta between the uplink and downlink gain (so the uplink gain is relatively lower than the downlink gain).
- Click **Send**.
- Repeat the procedure until the desired coverage is achieved.

6. More information on parameters for the *selected* sub-band:

- DL Set Ch. Max. Gain Sets the power for the antennas. The value is about 15 dB less than the isolation between the donor antenna and the mobile antenna.

The Value defined in the DL path is reflected in the UL path, however to define different UL and DL path values the Gain Delta parameter is used and its defined value is added to the UL value.

- DL Measured RSSI - measured DL signal.
 - DL Measured Ch. Gain - measured DL Gain (dB) for the selected sub-band.
 - DL Measured Ch. Power - measured Power (dBm) for the selected sub-band.
 - UL Gain Δ - used for noise control. Sets the difference between UL and DL gain.
 - UL Measured Ch. Gain - measured UL Gain (dB) for the selected sub-band.
-

7. Click **Send** (top window area option).

8. After the channels have been configured and the required coverage is attained for the location, verify that no Alarms are generated:
 - Click the **Alarms** tab
 - Verify that all the indicators are GREEN in the Alarms tab
 - For more information, refer to section 5.3.1.



Figure 5-5. Example of Alarms Tab

5.3 Monitoring and Troubleshooting

DIGimini provides two types of indications of Repeater failure:

- Alarms screen in Web access application
- Status LEDs on Dual-Band Repeater front panel

The following sections provide a description of the troubleshooting procedures according to the Repeater LED indicators and the Web access Alarms.

5.3.1 Repeater Alarms and Troubleshooting

The Alarms tab provides the alarms generated by the Repeater, enabling the user to monitor the system operation.

To access the Alarms window

From the Tree Pane, select the band item and choose the **Alarms** tab. The relevant parameters are displayed for the supported bands.



Alarm	Fault and most probable cause and Recommendation
Built In Test	Self test.
Temperature	High temperature. Most probable cause: Unit temperature becomes high. Excessive heat. Recommendation: Check the Repeater case for external causes (sun, hot environment, air flow is blocked). Eliminate the reason for excessive heat
System Mute	Generates an alarm when Repeater amplification is muted (automatically)
User Mute	Repeater amplification is muted (manually) as a result of an operator action.
Reduced Gain IMOP	Shows when the IMOP mechanism was activated in order to respond to detected oscillations.

Alarm	Fault and most probable cause and Recommendation
	GREEN – normal operation – no oscillations were detected. RED – oscillations were detected and the system reduced gain in order to eliminate the oscillations. Check the Donor and Mobile antenna installations for isolation. After isolation is within the required levels, the system will automatically increase gain (since it will no longer affect oscillations and) and the LED will turn GREEN.
Interferer Power Exceeded	Indicates if there is any external interference at a level that may affect the operation of the unit. Green – low or no interference. Unit operation is not affected. Red – high external interference that may affect the operation of the unit. It is recommended to identify the source of the interference and distance the source or the unit from each other.
RSSI	Fault in the DL or UL path Most probable cause: caused by a excessively high input signal. It is recommended to check the LEDs in the Repeater

5.3.2 DIGImini LED Troubleshooting

The DIGImini repeater includes six LEDs on its front panel (see 1.6.1). The following table provides a description of the LED troubleshooting procedures.

Indicator	Description	
Band Specific LED (i.e 900/1800/2100)	One Indicator per band :	
	RED	Steady - service muted due to general fault Blinking – service muted by user
	ORANGE	Blinking – service initiating on power up or reset Steady – high DL/UL signal or VSWR
	GREEN and ORANGE	Blinking- Reduced gain by IMOP
	GREEN	Blinking – DL power below threshold Steady - normal service operation
(ETHERNET) MNG	N/A	
(ETHERNET) MODEM	N/A	

6 DMCU Installation and Management

NOTE: In case of two cascaded DIGImini repeaters, a single DMCU serves both repeaters.

The DMCU is a separately ordered unit that provides various controls and monitoring functionality, including: Ethernet access, modem functionality (i.e GSM/GPRS, CDMA) and dry-contact alarms. A single unit can serve either a single Repeater or a Quad-band assembly comprising of two units.

The DMCU modem antenna is internal, where communication is established with the Repeater via the external Modem connector at the side of the Repeater.

The DMCU is mounted externally, adjacent to the Repeater, and connected to the Repeater (or to one of the Repeaters in case of a quad-band repeater assembly) via two cables: RS485 and SMA. The unit is powered by the Repeater – no power-supply is required.

This section describes the DMCU interfaces, installation procedure and management capabilities provided by the unit.



Figure 6-1: DMCU

6.1 Features and Capabilities

- Provides complete remote control and monitoring capabilities over GPRS or CDMA, including:
 - Remote control via SMS
 - Remote alarming through SNMP alarm traps
- Ethernet port for local setup or remote management
- Single unit can support a DIGImini Quad-band installation (two Repeaters)
- No power required – acquires power from repeater
- Dry contact alarms – two external alarms and one summary alarm
- Compact and simple to install

6.2 DMCU Interfaces

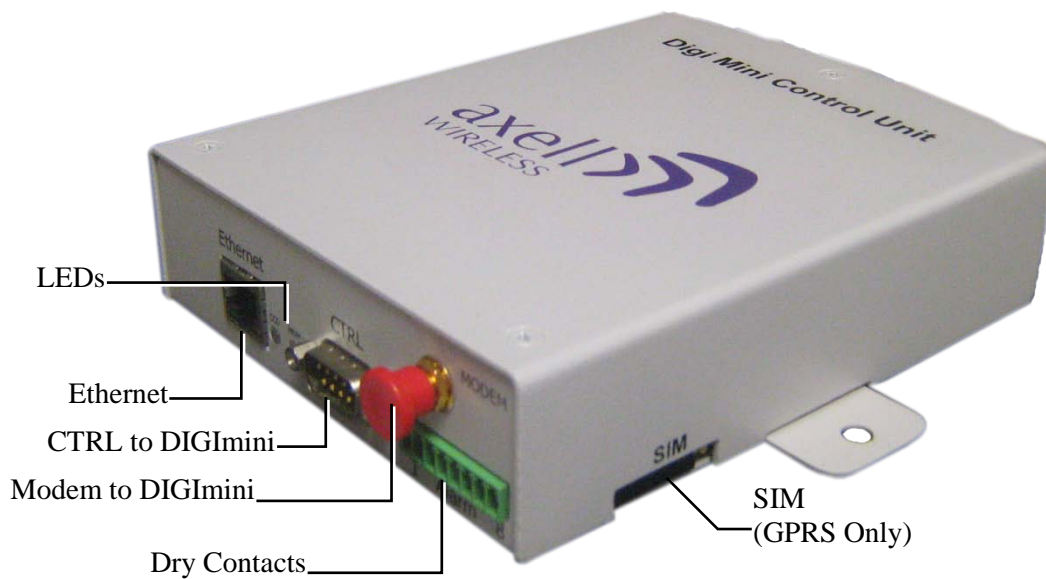



Figure 6-2: DMCU Interfaces

Interface	Description
Ethernet	Ethernet Web session connection for setup.
CTRL	Connect to DIGImini Repeater CTRL connector on the side panel.
Modem	Connects to the Repeater ANTENNA connector on the Repeater side panel.
Dry Contacts	Dry contact connector. See section 6.4.5
SIM (GPRS only)	SIM Card Slot - Applicable only to GSM/GPRS models.
LEDs	Band specific – service status MNG – unit operation status MDM – modem status

6.3 DMCU Kit

The following items are provided in the DMCU kit:

DIGimini Controller Kit - <i>Optional</i>	
DMCU	
RS485 (9 pin) to RS485 9-pin cable	CBL RS485 NO-X 1.8M MALE/FEMALE GRY (1579909492)
Controller Modem to Repeater modem antenna cable	CBL ASSY SMA MALE X2 STR SHLD 1.8M (CC010B0BA8)

6.4 DMCU Installation Procedure

The DMCU installation procedure slightly varies depending on whether it is a GPRS/GSM or CDMA modem.

6.4.1 GPRS Modem

1. Insert the SIM card in the side panel slot.
WARNING! This must be performed before connecting the DMCU to the Repeater.
2. Connect the modem to the Repeater.
3. Optional – you may also wire the DMCU dry-contacts.
4. Configure the communication parameters.

6.4.2 CDMA Modem

1. Connect the modem to the Repeater.
2. Optional – you may also wire the DMCU dry-contacts.
3. Activate the Modem (via the Web GUI Direct Modem Access tab).
4. Configure the communication parameters.

6.4.3 SIM Card Installation (GSM/GPRS Modems only)

WARNING!!! BE SURE TO INSERT THE SIM CARD BEFORE CONNECTING THE DMCU TO THE REPEATER.

Press the protrusion (yellow button), shown in the Figure 6-3 below, CONTINUOUSLY until the SIM tray extracts. You may need to use a small sharp object (*do not use a pencil*).

Note: This section is not relevant to CDMA modem equipped units. See 6.7.5 CDMA Modem .



Figure 6-3. Insert SIM card

6.4.4 Connecting the DMCU to the Repeater

To install the DMCU

1. Secure the DMCU to the wall – near the Repeater.
2. Connect the DMCU power converter to an AC power source and to the DMCU.
3. Connect the supplied RS485 to RS485 cable between the **CTRL** connector of the DMCU and Repeater (side panel).
4. Connect the supplied cable between the Modem connector of the DMCU and Repeater (side panel).
5. Optional - connect the dry-contacts according to the instructions in the following section.

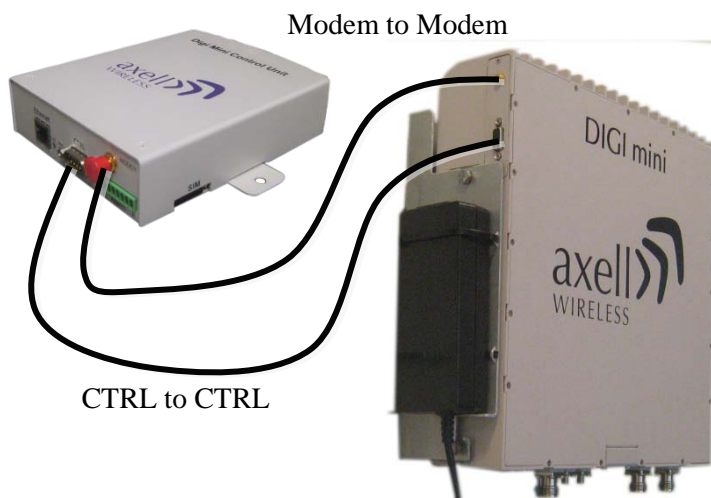

Figure 6-4. DMCU Connections

6.4.5 DMCU Dry Contacts

The DMCU provides two types of alarms:

- X2 External Alarms IN – used to acquire status of connected external devices or sensors such as Door-open, air-conditioner, temperature, etc. These alarms are also defined and enabled through the GUI. If an alarm is generated, it is displayed in the Alarms Log screen.
- X1 Summary Alarm OUT – indicates a fault in the Repeater. It is activated any time any error is generated in the Repeater and can be connected to an external device.

To connect and configure the dry-contacts

1. Wire the dry-contacts according to section 6.4.5.1.
2. Configure the external alarms according to section 6.6.3.
3. You may monitor the external alarms log according to section 6.9.1.

6.4.5.1 DMCU Dry-Contact Wiring

Wire color	Signal	Pins number	
		J1	J2
White	Ext Alarm_1 IN	1	1
Brown	GND	2	5
Green	Ext Alarm_2 IN	3	2
Yellow	GND	4	6
Grey	Ext Alarm_3 IN	5	-
Orange	Dry contact Out	6	7
Blue	Dry contact NC	7	4
Red	Dry contact NO	8	3

Connectors view

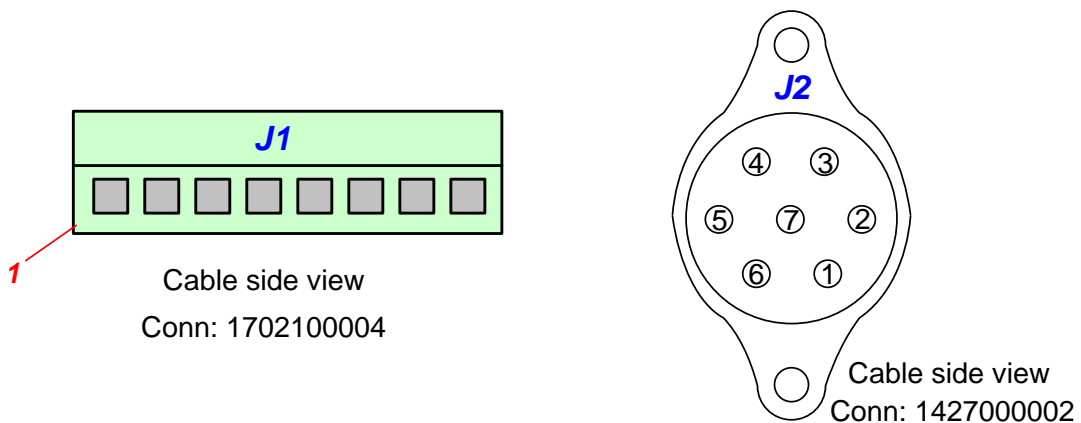

Figure 6-5. DMCU Dry-Contact Alarms

6.5 Opening a Web Session via the DMCU

Connect the computer and the Control Unit front panel **Ethernet** port with the supplied cable as shown below.

NOTE: If connecting the DMCU to a Tri/Quad-band assembly, it may be connected to either of the two DIGImini units. Local setup will then only be done via the DMCU's ETH port.

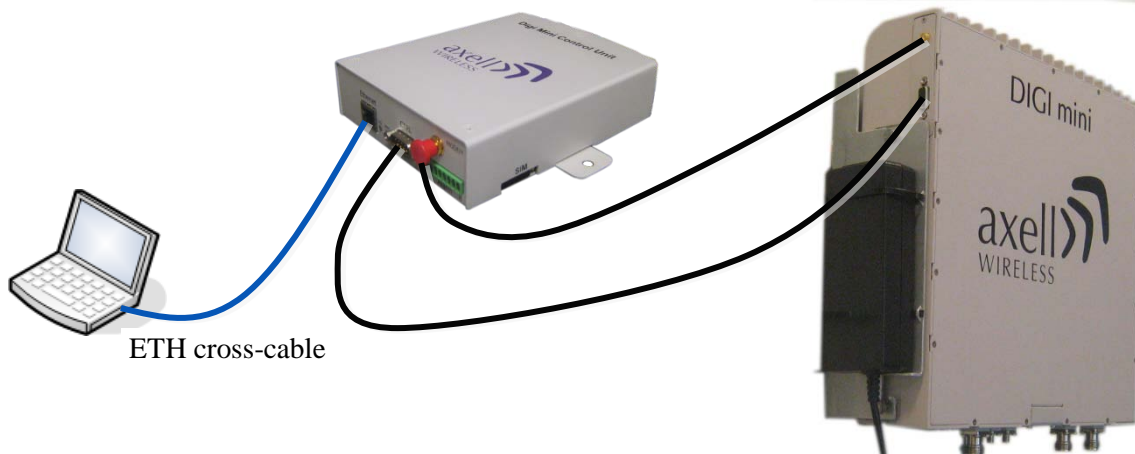

Figure 6-6. DMCU Connections

Configure the computer network parameters to communicate with the DMCU.

NOTE: The procedure may vary slightly depending on the operating system installed on your computer. The following procedure is for Windows 7.

To Configure the Computer's IP Parameters:

1. Click the **Start** menu and choose **Control Panel**.
2. In the **Control Panel**, click **Network and Internet**.
3. Click Network and Sharing Center and then click Local Area Connection.

The **Local Area Connections Status** dialog box appears with the General tab displayed by default.

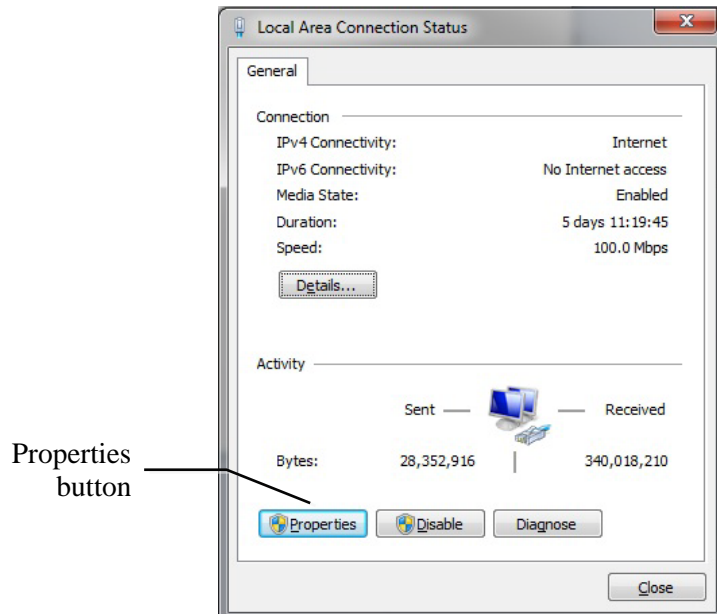

4. Click the **Properties** button (shown above) in the displayed **Local Area Connection Status** dialog. The **Local Area Connection Properties** dialog appears.

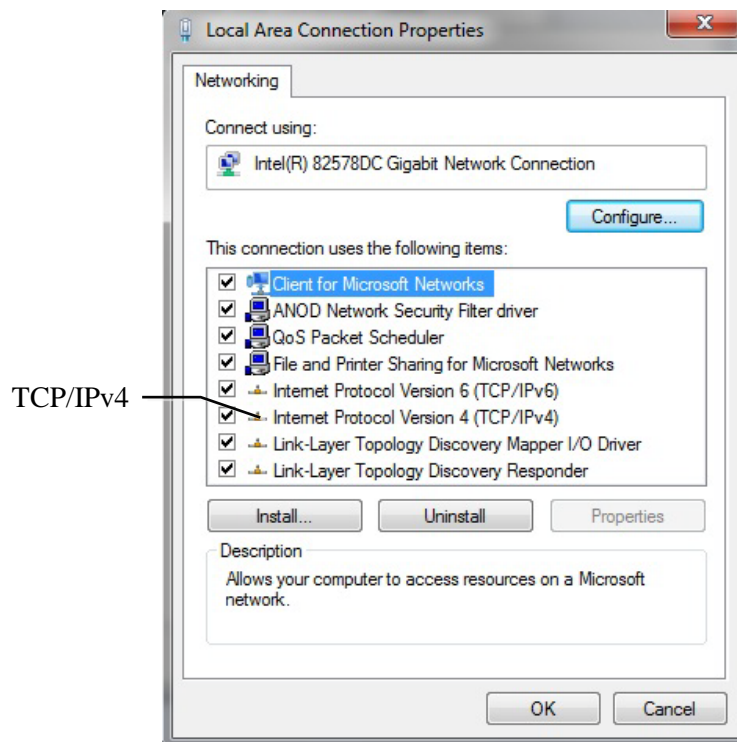

5. In the Items list, double-click the “Internet Protocol Version 4 (TCP/IPv4)” item.
6. The **Internet Protocol Version 4 (TCP/IPv4) Properties** dialog appears.

NOTE: The DMCU is supplied with the default IP address 192.168.1.253.

PRODUCT DESCRIPTION AND USER'S MANUAL

7. Assign your computer an IP address in the same subnet, in order to communicate with the unit.
 - In the IP address area:
 - Enter the IP address 192.168.1.x, where 'x' can be any number between 2 and 250 inclusive. For example, (192.168.1.9)
 - Define the subnet mask as shown (255.255.255.0)

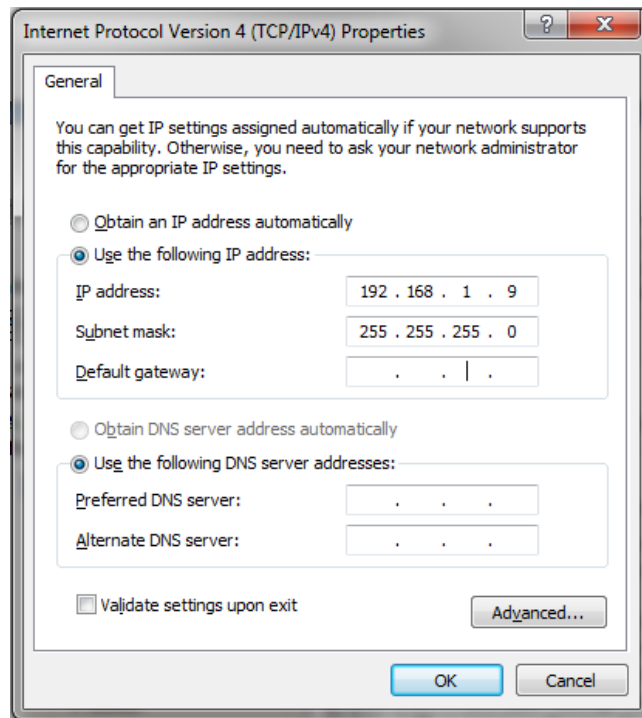

- Click **OK**. The computer communication parameters are now defined and you can open a session to the Repeater.

6.5.1 Login to the Repeater

NOTE: The Repeater is factory assigned the address 192.168.1.253. Initial login is performed using this address; however it is recommended to make the necessary modifications according to information provided by your network administrator.

To login to the Repeater

1. Open one of the Flash-enabled browsers listed in the system requirements.
2. In the address line, enter the IP address of the Repeater. <http://192.168.1.253>. A session will be established with the Repeater and the login dialog appears.

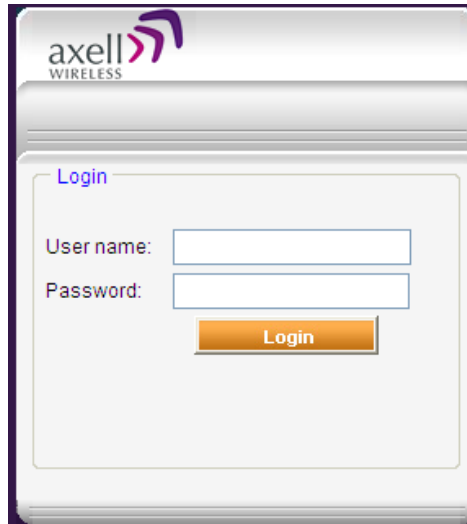

3. Type the default User Name **admin** and the default Password **admin**.

Note that both are case sensitive and must be entered with lower case letters.

4. Click **Login**. The application main window appears.
5. Quickly review the following section describing the application window and then proceed to configure the signal levels according to section 5.2.3.

6.5.2 Navigating the Web GUI Application

When a session is opened via the DMCU, all the available management capabilities are displayed. The Web Access interface provides three groups of options, listed in the left side Topology Tree items:

- **CMU** – system control level options. These include communication parameters, alarms log, external alarms configuration options and more.
- **Band** (e.g. 850-1900) – band specific RF parameters control and monitoring options. The displayed bands depend on the supported configuration: Single, Dual, Triple or Quad band configuration.
- **Users** – Provides user administration options and enables changing user passwords.



Figure 6-7. Example of Web GUI Screen (shows dual-band)

6.5.2.1 Band Tabs

The band pane and tabs are accessed by clicking on the band item (e.g. 850-1900) in the topology tree. The upper area of each selected pane shows the tabs corresponding to that pane.



Item	Description / Values
Alarms	Displays various alarms generated by the Repeater and enables monitoring (see detailed description in section 5.3.1).
Control and Params	Used for adjusting RF parameters and channel configuration (signal level, gain and bandwidth). See detailed description in section 5.2.6).
Band Info	Shows information on the selected band, including valid definable bandwidth pre sub-band. See section 5.2.5.
Backup/Restore	Configuration files management options (configuration files can be stored on the Repeater for access). See section 6.8.3.

6.5.2.2 CMU Tabs

The DMCU tabs and options are accessed by clicking on the CMU item in topology tree.



Item	Description / Values
Axell CMU Info	Provides HW and SW version information, Repeater name definition options and enables setting the minimum alarm log level. See section 6.8.1.
Communication Configuration	Used to set IP, SNMP and SMS destinations, and modem communication parameters. See detailed description in section 6.7.
Alarms Log	Log of past and current alarms. See description in section 6.9.1.
Axell-CMU Alarms	Shows any generated external alarms.
External Alarms	Used to define any connected external alarms. See section 6.6.3.
Axell-CMU SW Upgrade	Enables upgrading the CMU. See section 6.8.2.
Modem Direct Access	Used to troubleshoot GPRS/CDMA modem activation by sending the appropriate commands and viewing responses and used to activate CDMA modem. See section 6.7.5.1

6.5.2.3 Operation Buttons

The following Operation buttons are available.



Item	Description / Values
Selected Tree Item	Shows the currently selected topology tree item. Values: CMU, Band (e.g. 850-1900), Users
Send	Click after completing the new data input and values update in any screen in order to insert the new values into the Repeater, and implement the changes
Refresh	Click to refresh the current screen and update the displayed data
CMU Reset	Click to reset the Web Access application, in case of failure or display problems
Date and Time	Displays Date & Time as set in the Repeater
Help	Click Help to display an e-guide line for the system operation. This Help is general by its nature and some features may not be included.

6.6 Basic Configuration Procedures

Begin by performing the following procedures:

- Configure Signal levels and Channels
- Set the Date and Time
- If external alarms have been connected – enable the external alarms

6.6.1 Configuring Signal Levels and Channels

For signal level and channel configuration refer to Chapter 5.2.3 - Signal Levels and Channel Configuration.

6.6.2 Setting Date and Time

It is important to set the correct date and time on the unit since this provides the timestamp for each logged event and alarm.

To set the Repeaters date and time

1. Click on **CMU** in the tree pane.
2. Click on **Date & Time** in the menu bar. The following dialog appears.

A screenshot of a web-based dialog box titled "Set CMU Date and Time". It contains five dropdown menus for "Year", "Month", "Day", "Hour", and "Minute". The values are set to 2011, 12, 31, 15, and 37 respectively. Below the dropdowns is a "Set" button. At the bottom of the dialog, there is a red text warning: "Please note: after changing date and time you need to reset CMU!".

Field	Value
Year	2011
Month	12
Day	31
Hour	15
Minute	37

3. Set the date and time parameters and click on **Set**.
4. **Reset** the CMU (as described in the following section).

6.6.3 Configuring the External Alarms

Any connected alarms (section 6.4.5) must be enabled and configured according to the instructions provided in this section.

To configure external alarms

1. Click on **CMU** in the tree pane.
2. Click the **External Alarms** tab. The following dialog appears.

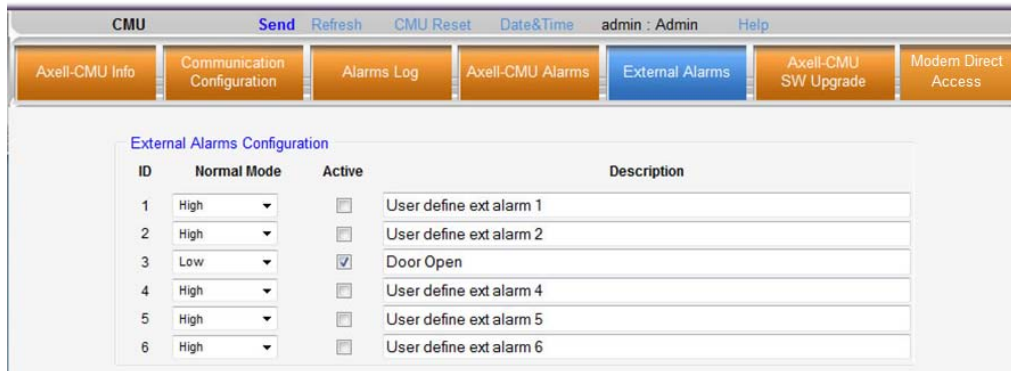

3. For each connected alarm:
 - Checkmark the **Active** checkbox.
 - Set the alarm **Normal Mode** as High or Low.
 - In the **Description** field, assign the alarm an identifiable name.

6.7 Communication and System Parameters

NOTE: All CMU Configuration options (tabs visible in screenshot below) require a CMU be connected to the DIGimini Repeater. If a CMU is not connected the GUI will not display the CMU tab.

The Communication Configuration tab provides the Modem, IP, AEM and SNMP trap configuration parameters.

This section describes how to access the dialog. The following sub-sections provide detailed information on each configuration option.

6.7.1 The Communication Configuration Tab

To access the Communication Configuration tab

In the left tree pane, click **CMU**. From the available tabs in the work area, choose the **Communication Configuration** tab.

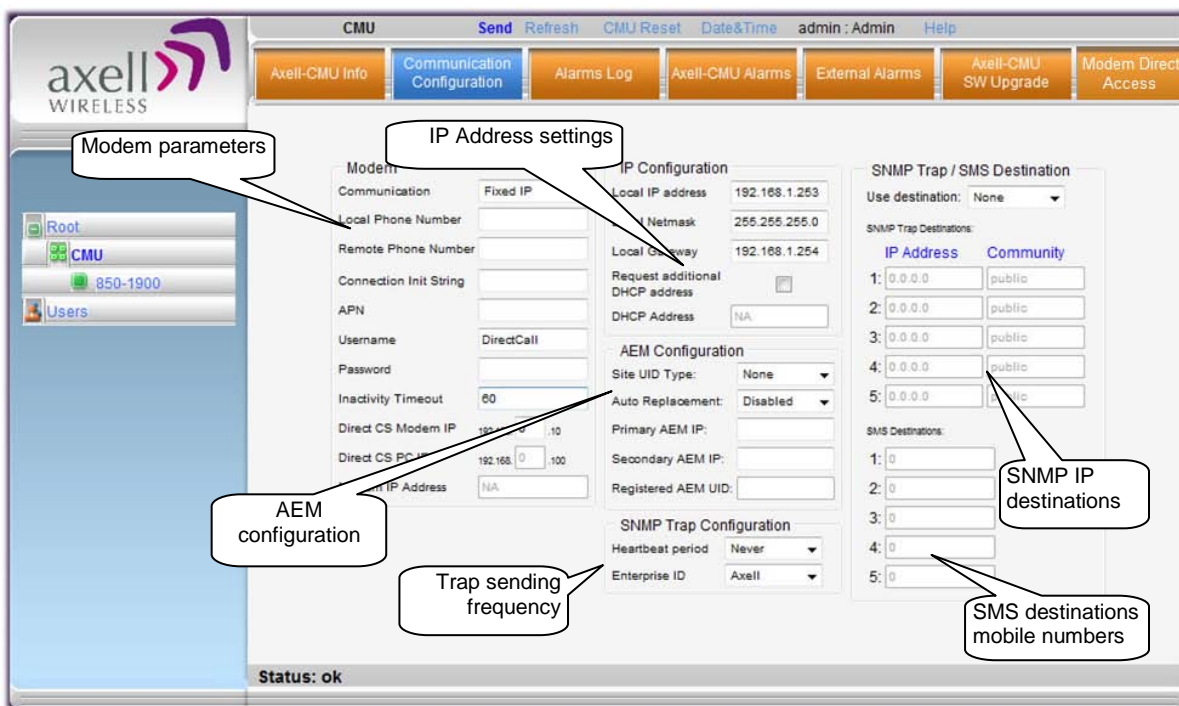

6.7.2 IP Address Configuration

The Repeater supports both Static and DHCP addresses. A unique technology enables applying both types to the *same* Ethernet port. Both addresses may enable local and remote management.

- Local IP Address – Static IP assigned by the user to the system. The default Static IP address is 192.168.1.253. It is highly recommended to preserve this setup. In case of a change, make sure you record the newly assign IP.
- DHCP Address – address assigned by DHCP server – used for remote management via an Ethernet connection.

To assign the unit IP address

1. Click the **CMU** tree item and then click the **Communication Configuration** tab.
2. To assign the unit addresses:
 - Local IP address - in the IP Configuration area, assign the unit the IP address, Netmask and Gateway parameters provided by your system administrator.
 - DHCP server address – checkmark the option Request Additional DHCP Address. The assigned address can be seen in the DHCP Address field.

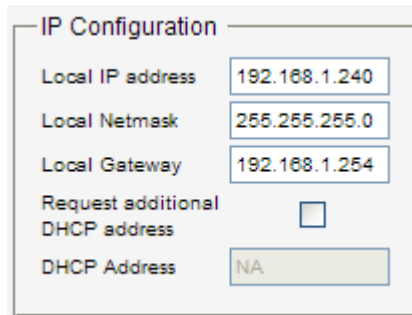

6.7.3 General Modem Parameters

This section describes the available modem parameters. Specific procedures for GSM/GPRS modem, CDMA modem or for Direct CS are described in the relevant sections.

To define the modem parameters

1. Click **CMU** in the left tree pane and select the **Communication Configuration** pane.
2. In the **Modem** area, select the **Communication** mode and define any additional parameters according to the table below. (Any defined fields in the figure below are only an *example!*)

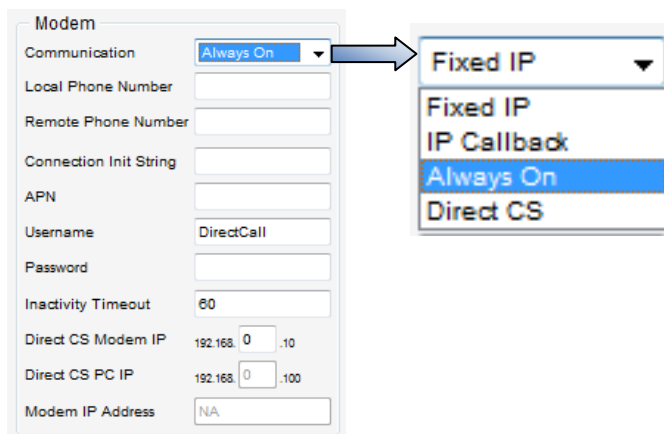

PRODUCT DESCRIPTION AND USER'S MANUAL

<p>In the communication field, select ...</p>	<p>For this communication mode.</p>
<p>Fixed IP</p>	<p>Modem OFF</p>
<p>Always ON</p>	<p>Packet Switch mode. Additional parameters: Also (depending on the configuration required by your operator), define the Connection Init string, APN, User Name and Password. <i>NOTE: After the modem connects to the network, the Modem IP Address is displayed.</i></p>
<p>Direct CS</p>	<p>Direct Circuit Switch. (See section 6.7.7 for details on opening a Direct CS session to the repeater.) Additional parameters: Also (depending on the configuration required by your operator), define the Connection Init string, User Name, Password and Direct CS Modem IP (an internal address used for Web surfing).</p>
<p>IP Callback</p>	<p>Special mode for specific installation types.</p>

6.7.4 GSM/GPRS Modem Setup

NOTE: It is assumed that the SIM card is already installed according to section 6.4.3. If the modem does not respond properly, troubleshoot the modem via the Direct Access tab described in section 6.7.6).

This GSM/GPRS Modem setup consists of configuring the Modem communication parameters via the Communication Configuration tab.

To define the GSM/GPRS modem Communication parameters

1. Click **CMU** in the left tree pane and select the **Communication Configuration** pane.
2. In the **Modem** area, select the **Communication** mode as **Always On** and define any additional parameters according to the table below. (Any defined fields in the figure below are only an *example!*)

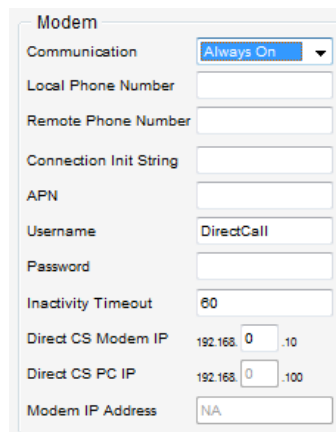

Modem	
Communication	Always On
Local Phone Number	
Remote Phone Number	
Connection Init String	
APN	
Username	DirectCall
Password	
Inactivity Timeout	60
Direct CS Modem IP	192.168.0.10
Direct CS PC IP	192.168.0.100
Modem IP Address	NA

3. If the modem does not run, troubleshoot using the Modem Direct Access Tab (section 6.7.6).

6.7.5 CDMA Modem Setup

NOTE: This procedure describes how to configure the CDMA modem for operation in a Verizon network. For operation in other network, consult your Axell Wireless service personnel for instructions.

This procedure for Verizon network setup consists of the following phases:

- Modem Activation and verification – via the Modem Direct Access tab
- Configuring Modem communication parameters – via the Communication Configuration tab
- If the modem does not respond properly, troubleshoot the modem via the Direct Access tab described in section 6.7.6).

6.7.5.1 Activating Modem on the CDMA Network

For the modem to connect over a CDMA network, it must first be activated according to the following procedure:

To activate modem CDMA functionality

1. Click **CMU** in the left tree pane and select the **Modem Direct Access** tab.

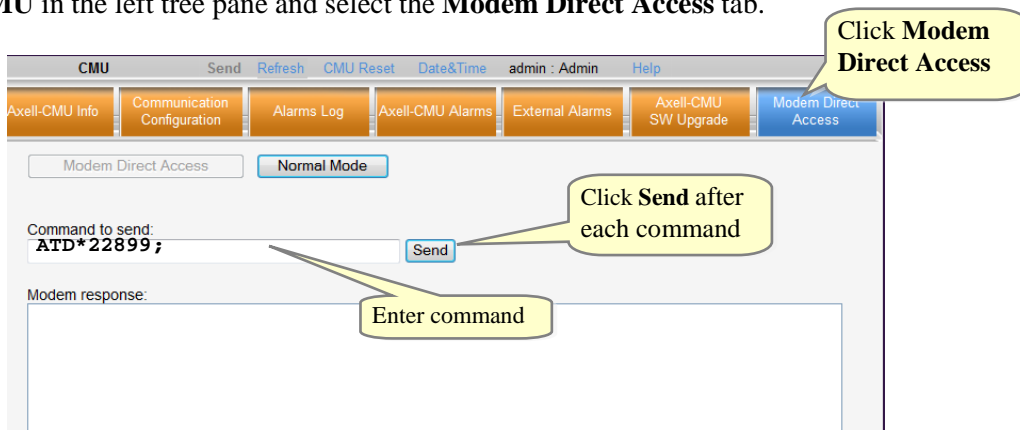

2. Click on the **Modem Direct Access** button. The Command to send text-box and Send button will be available for entering commands.
3. Perform the following command sequence:
 - Type the command **ATD*22899;** (including the *semicolon*) and click **Send**.
 - Wait 10 seconds and then type the command **AT** and click **Send**. The following set of responses should appear in the Modem Response area:

```
+WOT1: "Programming in Progress"
+WOTS: "SPL unlocked"
+WOTP: "PRL download OK"
+WOTM: "MDM download OK"
+WOTC: "Commit successful"
+WOT2: "Programming Successful!"
```
4. If *"Programming Successful!"* does **not** appear, verify RSSI and modem registration according to the procedures in section 6.7.6.
5. Click on the **Normal Mode** button or on **CMU Reset** in the command bar for changes to take effect.

6. After a few minutes, a Modem IP Address should appear on the CMU GUI screen. This indicates the modem is functioning on the CDMA Network. If the modem does not respond properly, troubleshoot the modem via the Direct Access tab described in section 6.7.6).

6.7.5.2 Configuring Modem Communication Parameters

To configure the CDMA VERIZON modem communication parameters

NOTE: For other operators, consult with your Axell Wireless customer support.

1. In the left pane, click **CMU** and choose the **Axell CMU Configuration** tab.
2. In the **Modem** area, define the parameters as follows:
 - Modem Communication = **Always On**
 - The Remote Phone Number = **#777**
 - Connection Init String = **AT**
 - User Name = **1234567890@vzw3**
 - Enterprise ID parameter = **VZW**
3. In the **SNMP Trap Configuration** field area, enter the system identification name

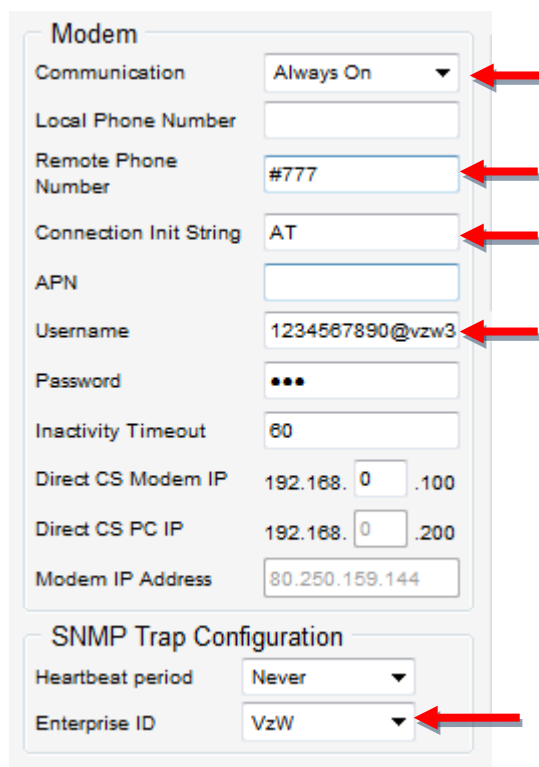

The screenshot shows a configuration interface with two main sections: 'Modem' and 'SNMP Trap Configuration'. The 'Modem' section includes fields for Communication (set to 'Always On'), Local Phone Number, Remote Phone Number (set to '#777'), Connection Init String (set to 'AT'), APN, Username (set to '1234567890@vzw3'), Password (masked with dots), Inactivity Timeout (set to '60'), Direct CS Modem IP (192.168.0.100), Direct CS PC IP (192.168.0.200), and Modem IP Address (80.250.159.144). The 'SNMP Trap Configuration' section includes Heartbeat period (set to 'Never') and Enterprise ID (set to 'VzW'). Red arrows point to the 'Always On' dropdown, the '#777' text box, the 'AT' text box, the '1234567890@vzw3' text box, and the 'VzW' dropdown.

6.7.6 Verifying Modem RSSI and Registration

Use the following **AT** modem commands to verify the RSSI level and the modem Registration to better troubleshoot failure of the modem. Any other standard AT commands may be used as well.

NOTE: The AT commands described in this section are standard commands and more information may be acquired from any standard source.

1. Click **CMU** in the left tree pane and select the **Modem Direct Access** tab.

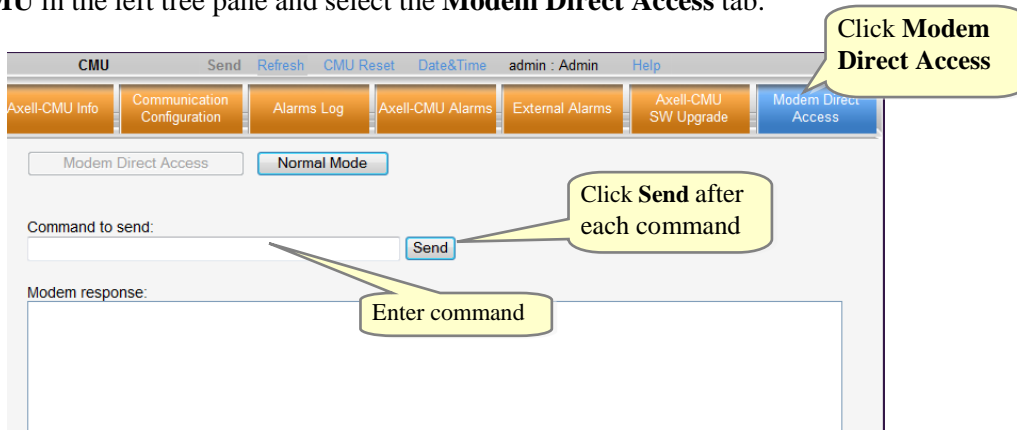

2. Click on the **Modem Direct Access** button. The Command to send text-box and Send button will be available for entering commands.
3. To verify RSSI level (Received Signal Strength Indicator):
 - In the **Modem Direct Access** tab, **Command to Send** area, type: **AT+CSQ** and click **Send**.
 - Response: **+CSQ <rss>, <ber>**
 <ber> is not relevant (ignore)
 <rss> should be **larger than 10**, and **NOT** equal to 99 (*rss>10 & rssi≠99*)
4. To verify modem Registration status, in the **Modem Direct Access** tab, **Command to Send** area:
 - Type: **AT+CREG?** and click **Send**.
 - Response: **+CREG <param1>, <param2>** (note that is not relevant).
 <param1> is not relevant (ignore)
 <param2> should be either **1** (Registered) or **5** (roaming)

6.7.7 Direct Circuit Switch Connection

A. On the Repeater, set the Repeater Modem parameters as follows:

- Communication - Direct CS
- To provide security, set the User Name and Password for the repeater (the same User Name and Password will be defined on the dial-up connection).
- You may modify (optional) the Direct CS Modem IP – this is the Web address used to open a Repeater session. Otherwise, the default displayed value can be used.

B. On your computer, set up a dial-up connection as follows:

1. Via **Network Connections**, create a **Dial-up** connection on your computer (Connect using a dial-up modem). The procedure may vary slightly depending on your Operating System.
2. Define the parameters as follows:

- ISP connection name – user defined, recognizable name for this connection for future reference.
- Phone Number – the number corresponding to the number assigned to the SIM card installed on the Repeater.
- User Name and Password – the User Name and Password (if assigned) that you allocated in the Modem parameters in the Communication dialog (see previous section).

C. Open a session to the Repeater:

1. On your computer, click the relevant dial-up connection item or the icon, to open a dial-up route to the Repeater.
2. Open a Web Browser and enter the **Direct CS Modem IP** that is defined in the Modem parameters on your Repeater. A session will be opened to the Repeater.

6.7.8 Configuring Notification Method - SNMP Trap or SMS

The Repeater can be configured provide fault notification *either* by sending traps to defined IP addresses *or* by sending an SMS message to configured destinations (only *one* option can be selected).

6.7.8.1 Configuring SNMP Trap Destinations

You may configure traps to be sent to five destination addresses each time a fault is triggered. The traps are sent at the defined heartbeat frequency.

To set SNMP Trap Destination parameters

1. In the **Use Destination** field, select the **SNMP** option
2. For each destination:
 - Enter the IP Address (where the IP addresses should be in the same subnet as the repeater).
 - Define the Community names (default = public) of the computers to which traps will be sent.

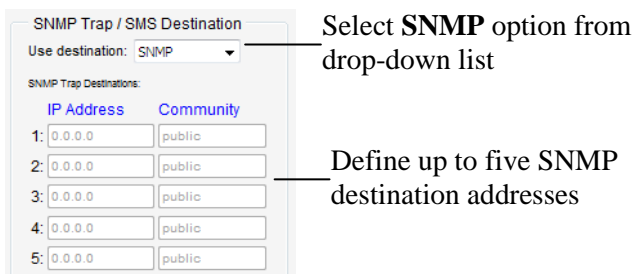

3. In the **SNMP Trap Configuration** area, in the **Heartbeat Period** field, define the frequency (in minutes) at which traps will be sent.

NOTE: It is recommended to maintain the Enterprise ID as Axell.

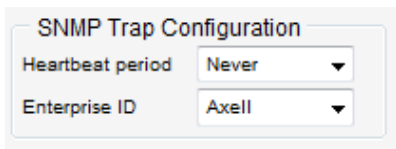

4. Click **Send**.

6.7.8.2 Configuring SMS Notification Destinations

You may configure up to five SMS destinations (mobile numbers).

To set SMS Destination parameters

1. In the **Use Destination** field, select the **SMS** option from drop-down list.

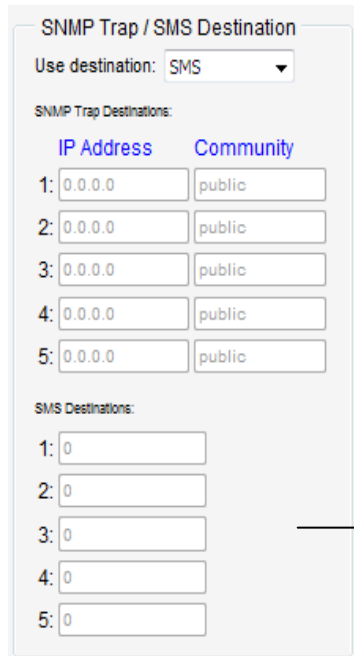

Select **SMS** option from drop-down list

Define the SMS destinations (mobile numbers)

2. Define up to five SMS destinations (for example, + xxx541234567):
3. Click **Send**.

6.7.8.3 AEM (Axell Element Manager) Configuration

Configure the AEM parameters provided by the system administrator so that the 3021D Repeater is integrated in the network and can be centrally managed.

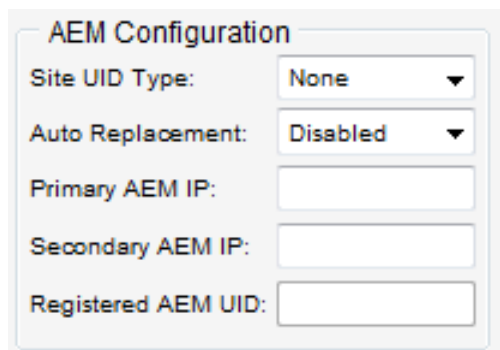

6.8 DMCU Administration

6.8.1 Viewing Repeater Level Information

Use the **CMU-Info** screen to view the hardware and software versions of the DIGImini Repeater. In addition, the screen provides configuration options for setting the minimum Log Level and assigning the Repeater a recognizable name.

NOTE: Read-only or irrelevant parameters are grayed out.

NOTE: Usually, these fields are grayed-out. Grayed-out fields indicate that the display is Read-only. Active fields indicate that the parameter values can be defined.

To access the Repeater Information window

1. From the Tree Pane, **CMU** and choose the Axell-CMU Info tab.

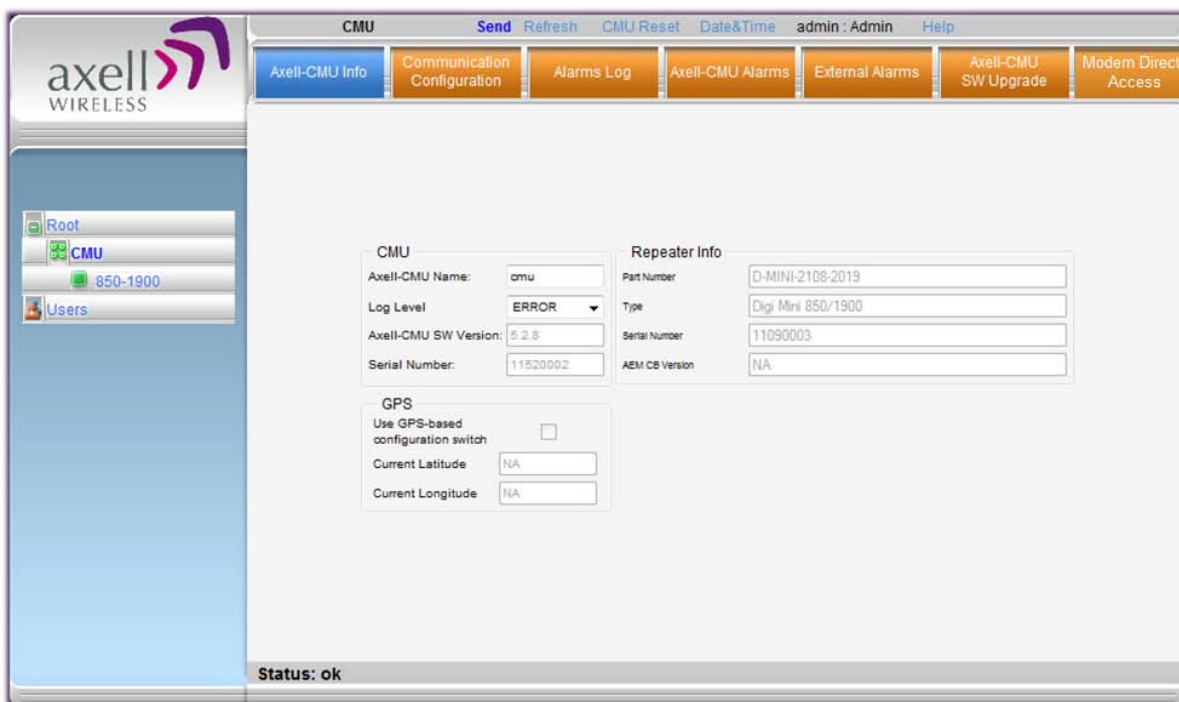

*NOTE: The **Axell-CMU Name** field can be used to assign the module a recognizable name corresponding to the technology.*

6.8.2 CMU Software Upgrade

The procedure described in this section is used to upgrade the repeater CMU.

NOTE: This procedure is performed for every new management version.

To Upgrade the Repeater SW

1. From the Tree Pane, select **CMU**.
2. Select the **Axell CMU SW Upgrade** tab. The CMU SW Upgrade screen shown below appears.
3. Choose the version to upload and perform the procedure according to the instructions on the screen.

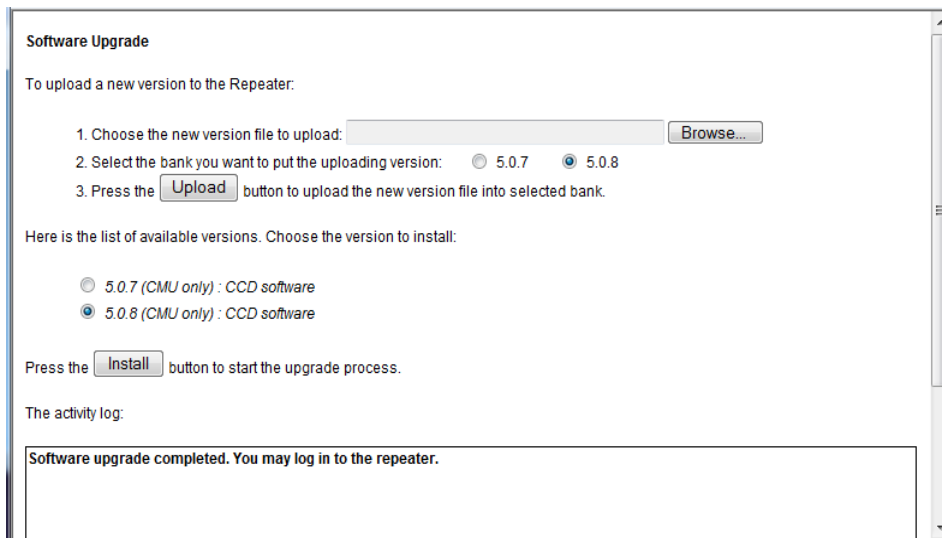

6.8.3 Backup/Restore of Repeater Configuration

NOTE: Backup and Restore procedures are only applicable for web sessions opened via the DMCU (see 6.5 and 6.5.1) as opposed to directly through the Repeater (see 5.1).

The DIGImini Web GUI management application enables the backup and restore of the repeater configuration files. This section provides a description of the following procedures:

- Backup of current Repeater configuration
- Restoring previous Repeater configuration from available files
- Uploading new configuration file from computer
- Saving configuration settings to other location (i.e. computer)

To access Backup/Restore tab

1. From the Tree Pane, select the band item.
2. Select the **Backup/Restore** tab. The following tab appears.

*NOTE: The following figure is only an **example** of the Backup/Restore tab and does not show DIGImini values.*

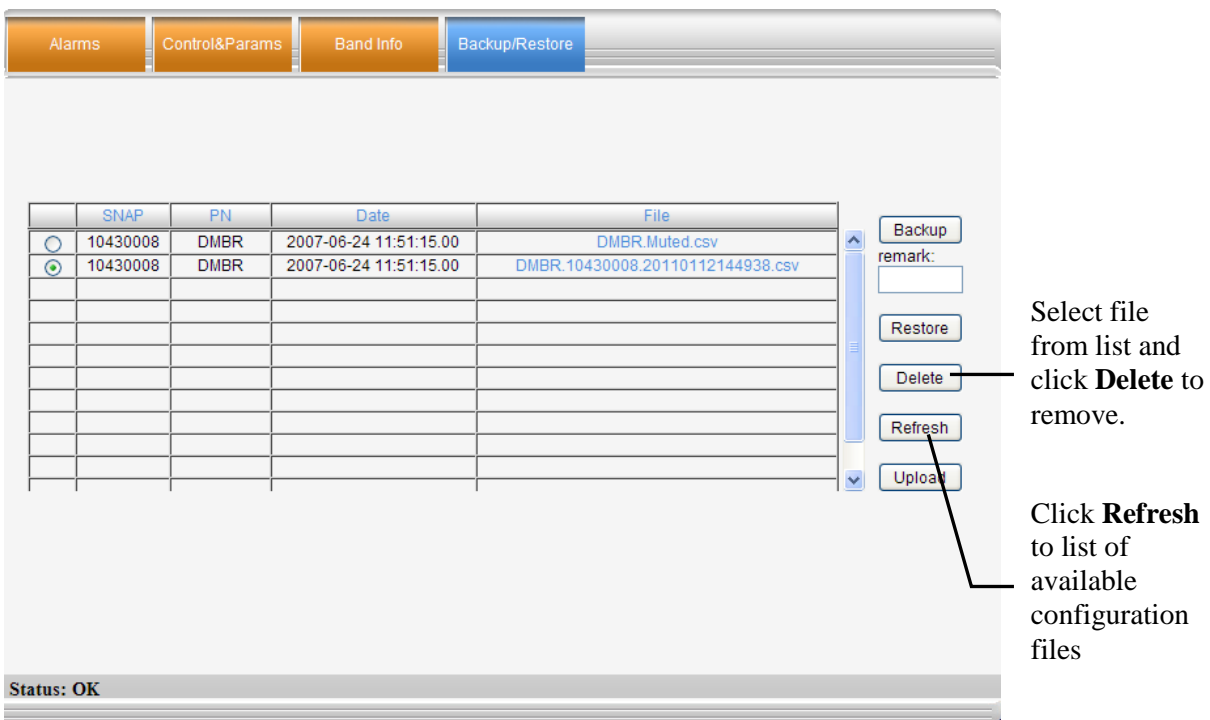

	SNAP	PN	Date	File
	10430008	DMBR	2007-06-24 11:51:15.00	DMBR.Muted.csv
	10430008	DMBR	2007-06-24 11:51:15.00	DMBR.10430008.20110112144938.csv

Buttons: Backup, remark: , Restore, Delete, Refresh, Upload

Annotations:
 - Select file from list and click **Delete** to remove.
 - Click **Refresh** to list of available configuration files

Status: OK

6.8.3.1 Backup of Repeater Configuration

To perform backup procedure

1. To assign the configuration file a recognizable name, enter a name in the **remark** field.

NOTE: This must be performed before performing the backup operation; otherwise the file will automatically be assigned a name according to the backup date and unit ID. The name cannot be modified once the backup has been performed.

2. Click the **Backup** button located on the right-hand side of the tab.
3. The file will be added to the table displayed in the Backup/Restore tab.

6.8.3.2 Restoring Previous Repeater Configuration

To restore previous configuration

1. Select the required configuration file (enable corresponding radio button) from the available list in the Backup/Restore tab.
2. Click the **Restore** button.

*NOTE: The following figure is only an **example** of the Backup/Restore tab.*

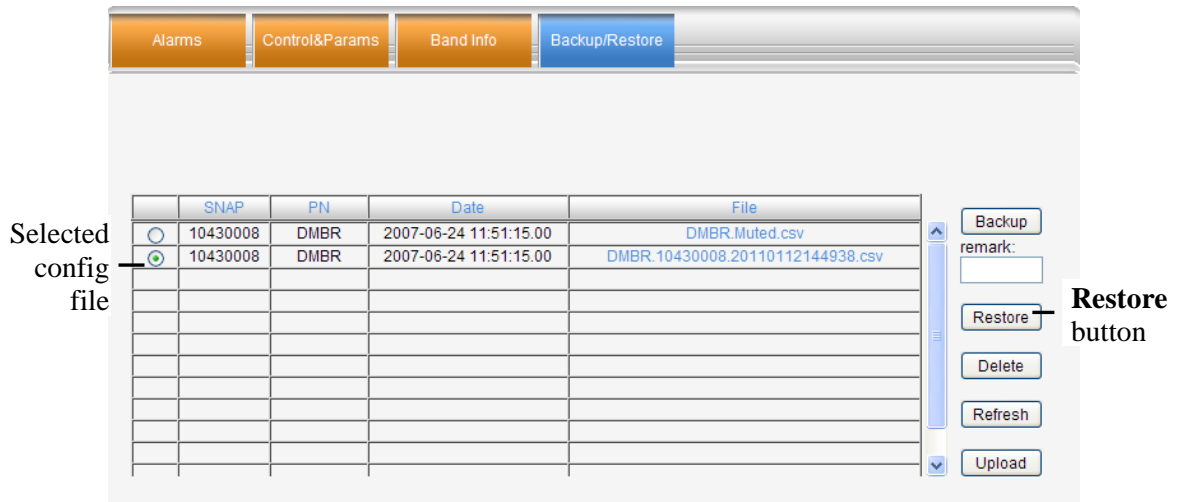

3. Click on the **Control and Params** tab and verify that the required configuration settings have been restored.

6.8.3.3 Uploading New Configuration File to Repeater

To upload configuration file to Repeater

1. Click the **Upload** button.

*NOTE: The following figures are only an **example** of the Backup/Restore tab.*

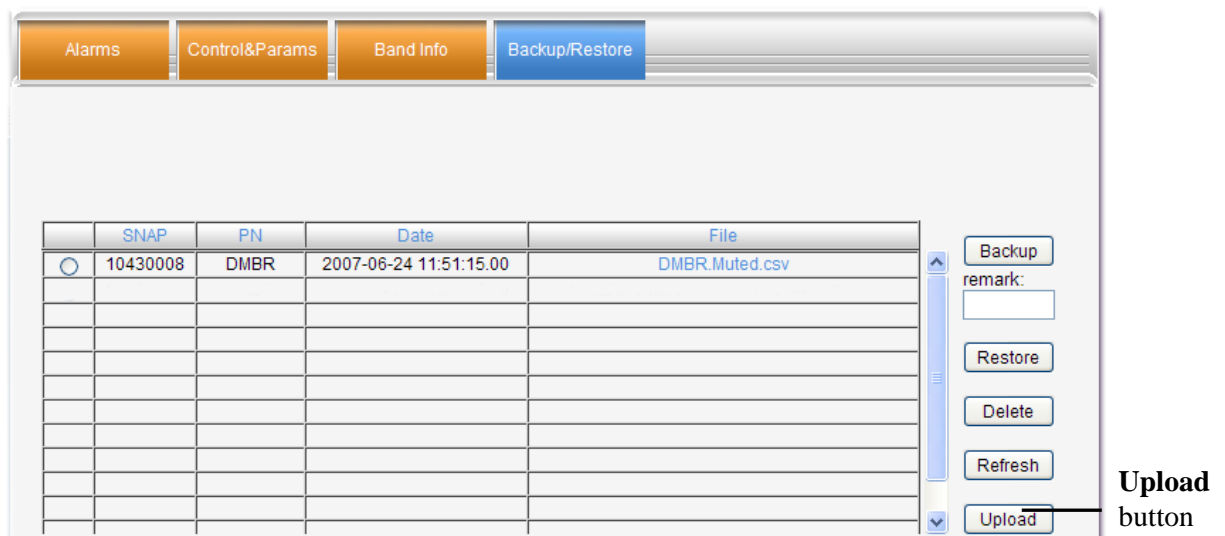

2. Select the file from the Browse dialog and click Open.

3. The file appears in the list displayed in the Backup/Restore table.

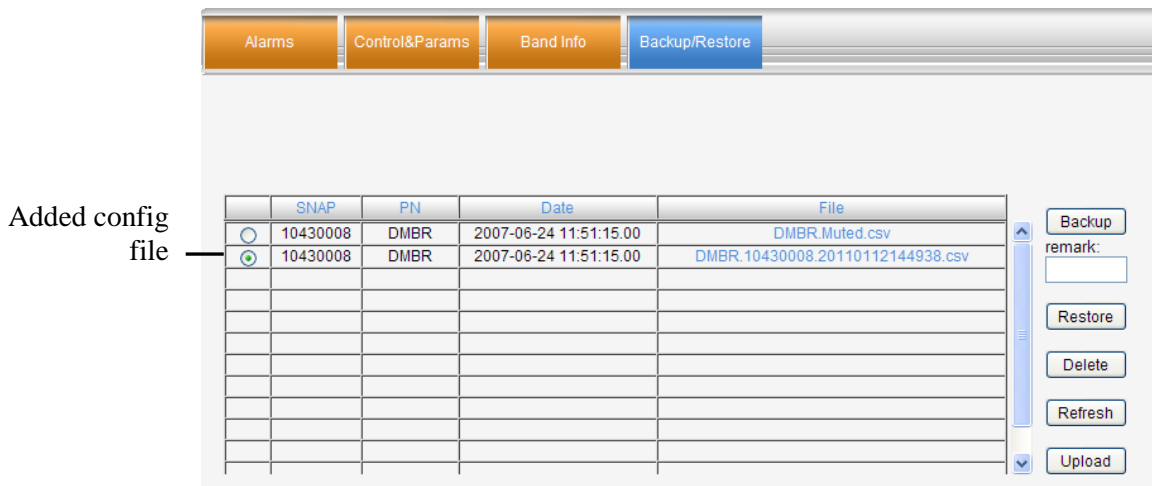

6.8.3.4 Saving Configuration File to Computer

To save a configuration file from the available list in the Backup/Restore table to a location in a connected computer:

- Select file from list.
- Click the link in the **File** column.
- Select the location in the Browse dialog.

6.8.4 User Management

This section describes how to perform the user management operations. By default, *two* users belonging to one of three authentication levels are defined on the Repeater.. You may add new users, modify or delete existing users.

6.8.4.1 User Levels

Three user levels are available:

- Admin – has access to all administration and configuration options, including user management. (Default Password **admin** and default User Name **admin**.)
- Operator – has access to all configuration options *except* for the Users list or the Loaders screen.

6.8.4.2 Viewing the List of Defined Users

To display the User Administration pane

From the **Tree Pane**, select **Users**. The list of users is displayed in the Configuration Pane according to the identifying information and authentication level (Role).

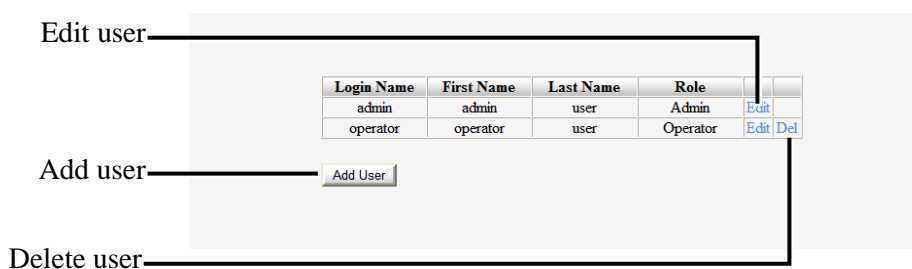

The following table provides a description of the Users dialog options.

Option	Description
Add User (button)	Adds a new user with to user defined access level and password.
Del(ete)	Deletes a selected user from the list.
Edit	Enables changing the definitions of an existing user.

6.8.4.3 Adding Users

NOTE: User name and password entries are case sensitive.

To add a user

1. From the Tree Pane, select **Users**. The list of users is displayed in the User's Pane.
2. From the User's Pane, click **Add User**. The Add User dialog box is displayed.

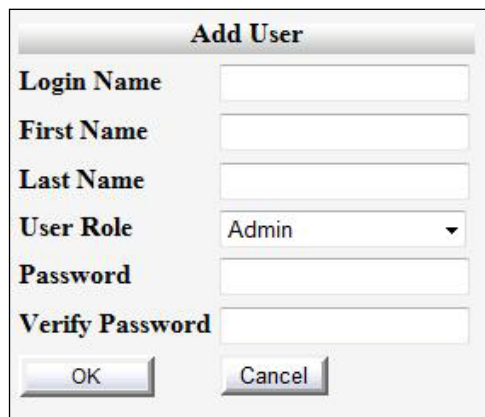

3. Enter the **Login Name** – name used by user to login.
4. Type the user's **First Name** and **Last Name** – used to identify the user.
5. Select the **User Role** – access level. This defines the operations that the user will be able to perform.
6. Enter the **Password** and in **Verify Password** enter the password again for verification.
7. Click **OK**.

6.8.4.4 Editing a User

To modify user definitions

1. From the **Tree Pane**, select **Users**. The list of users is displayed in the **User's Pane**.
2. Select the **User** to be edited in the list.
3. Click **Edit**. The user definitions dialog appears.
4. Make the required changes and click **OK**.

6.8.4.5 Deleting a User

To delete a user

1. From the Tree Pane Select **Users**. The list of users is displayed in the User's Pane.
2. Select the User to be deleted in the list.
3. From the User's Pane, click **Del**. An authorization message dialog box is displayed.

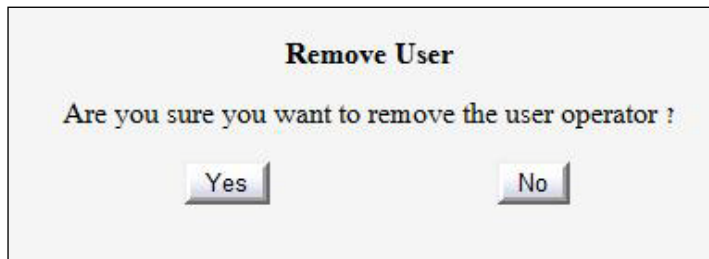

4. Click **Yes**. The User's name is removed from the list.

6.9 CMU Monitoring and Troubleshooting Options

In addition to the Repeater failure indications provided by the DIGImini (described in Chapter 5.3 - Monitoring and Troubleshooting), when a DMCU is connected the following additional monitoring options are provided:

- DMCU Status LEDs located on front panel
- Alarms Log – used to view a record of past generated alarms and events
- CMU Alarms – used to view record of generated external alarms

6.9.1 DMCU LED Troubleshooting

The DIGImini repeater includes six LEDs on its front panel (see 1.6.1). The following table provides a description of the LED troubleshooting procedures.

Indicator	Description	
Band Specific LED (e.g. 850/1900)	One Indicator per band :	
	RED	Steady - service muted due to general fault Blinking – service muted by user
	ORANGE	Blinking – service initiating on power up or reset Steady – high DL/UL signal or VSWR
	GREEN and ORANGE	Blinking- Reduced gain by IMOP
	GREEN	Blinking – DL power below threshold Steady - normal service operation
(ETHERNET) MNG	Green Blinking – normal operation of CCD	
(ETHERNET) MODEM	<ul style="list-style-type: none"> • Green Steady - modem is either not defined, or defined modem is operating normally. • Orange Steady– modem is trying to connect • Red Steady– modem failed to connect 	

6.9.2 Viewing the Alarms Log

The Alarms Logs screen lists the alarms (events) that have occurred. The CMU maintains log files listing every alarm triggered and in the Repeater. This screen provides an analysis tool to get information of any event that has occurred, its originator, when, if they return, and their type.

NOTE: Set the clock in order to synchronize the events time of occurrence (see section 6.6.2).

To view the CMU log screen:

1. Open and login to the Web application.
2. From the Tree Pane, select **CMU**.
3. Click **Alarms Logs**. CMU displays the Alarms Log Table.

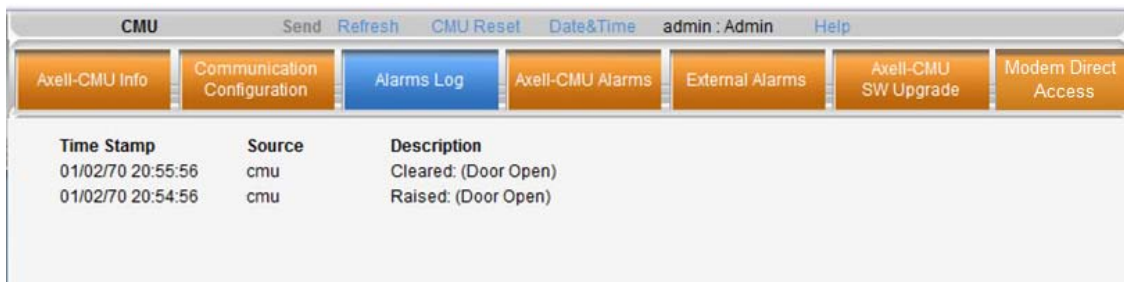

Item	Description
Time Stamp	The date and time the alarm was created
Source	ID of Network Element
Description	Description of event that caused the alarm

6.9.3 Viewing External Alarms Log

This tab is used to view the status of the connected external alarms.

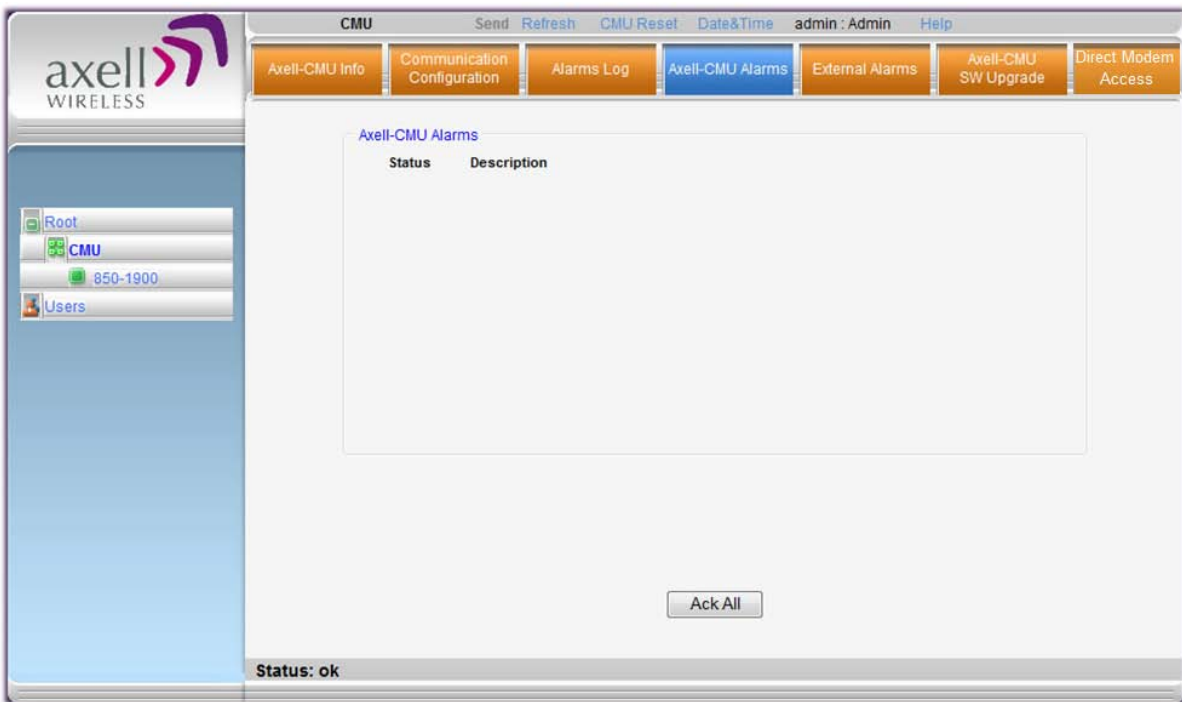

Appendix A: Specifications (@+25°C)

This paragraph provides the electrical, mechanical and environmental specifications of the DIGImini Americas Repeater.

700 MHz	Downlink	Uplink
Frequency Range	Lower Band: 728-746 MHz Upper Band: 746 -757 MHz	Lower Band: 698-716 MHz Upper Band: 776 -787 MHz
No. of Filters per Band*	Up to 6	Up to 6
Passband Max.Gain	73 dB	73 dB
Passband Ripple	±2.5 dB	±2.5 dB
Gain Attenuation Range	0 to 25 dB (in 1 dB steps)	0 to 25 dB (in 1 dB steps)
Composite Output Power	21dBm**	21dBm**
Noise Figure@ Maximum Gain (typical)	6 dB	6 dB
Propagation Delay	6 µsec	6 µsec

1700 MHz	Downlink	Uplink
Frequency Range	2110 – 2155 MHz	1710-1755 MHz
No. of Filters per Band*	Up to 6	Up to 6
Passband Max.Gain	73 dB	73 dB
Passband Ripple	±2.5 dB	±2.5 dB
Gain Attenuation Range	0 to 25 dB (in 1 dB steps)	0 to 25 dB (in 1 dB steps)
Composite Output Power	20dBm**	20dBm**
Noise Figure @ Maximum Gain (typical)	6 dB	6 dB
Propagation Delay	6 µsec	6 µsec

850 MHz	Downlink	Uplink
Frequency Range	869 – 894 MHz	824-849 MHz
No. of Filters per Band*	Up to 6	Up to 6
Passband Max.Gain	73 dB	73 dB
Passband Ripple	±2.5 dB	±2.5 dB
Gain Attenuation Range	0 to 25 dB (in 1 dB steps)	0 to 25 dB (in 1 dB steps)
Composite Output Power	21dBm**	21dBm**
Noise Figure@ Maximum Gain (typical)	6 dB	6 dB
Propagation Delay	6 µsec	6 µsec

PRODUCT DESCRIPTION AND USER'S MANUAL

1900 MHz	Downlink	Uplink
Frequency Range	1930-1990 MHz	1850 – 1910 MHz
No. of Filters per Band*	Up to 6	Up to 6
Passband Max.Gain	73 dB	73 dB
Passband Ripple	±2.5 dB	±2.5 dB
Gain Attenuation Range	0 to 25 dB (in 1 dB steps)	0 to 25 dB (in 1 dB steps)
Composite Output Power	20dBm**	20dBm**
Noise Figure@ Maximum Gain (typical)	6 dB	6 dB
Propagation Delay	6 µsec	6 µsec

(*) Supports every BW option 200KHz-25MHz by setting the Stop-Start frequency. Total numbers of filters is 6 per dual-band. See section 5.2.5 for details.

(**) 3.5dB less in tri/quad band configurations due to combining loss.

Electrical

Parameter	Value
Power Supply	100 - 240 VAC, 150W (typical)
Power Consumption	< 70Watt for dual-band, < 45Watt for single band

Mechanical Specifications

Parameter	Value
Dimensions (b x h x d)	299 x 305 x 77 mm (11.7 x 12 x 3.03 inch)
Installation	Wall Mount
Weight	8.9 lbs for dual-band

Environmental Specifications

Condition	Value
Operating Temperature Range	0 °C to +50 °C (32° to 122° F)
Humidity	85%, ETS 300 019-1-3 Class 3.1
Ingress Protection	IP41
MTBF, Complete System	>70,000 hrs.

Connectors

Connector	Type
RF Connectors: Base/Mobile	N-Type, Female
AC Power	Standard AC socket to AC/DC converter; DC socket to Repeater
Communications	RJ45
Modem Connection	External modem in DMCU
Coupling SMA Connectors (-20 dB): Base/Mobile	SMA female
Alarm inputs – in modem plug (2 external devices)	Dry Contacts – 6 pins: Normally Closed (NC); Common; Normally Open (NO)

Standard Compliance

Model	Compliance
D-MINI-2108-2019	FCC: NEO-DMINI21082019 IC: 8749A-DM819
D-MINI-2107U-2017	FCC: NEO-DMINI2107U2017 IC:8749A-DM7U17
D-MINI-2107L-2017	FCC: NEO-DMINI2107L2017 IC:8749A-DM7L17