

Axell MBF-40 Multi Band Repeater-Americas

PRODUCT DESCRIPTION AND USER'S MANUAL

Doc No. 00071UM Rev. 3.4



Single/Dual-Band
Repeater



Tri/Quad-Band
Repeater



Quad-Band with Fan Hood
Repeater

THIS DOCUMENT IS VALID FOR THE FOLLOWING MBF-40 MODELS:

MBF-40 US Repeaters	
Dual Band	MBF-3708-3719; MBF-3707-3917; MBF-3707-3719; MBF-3707-4317; MBF-4317-3919; MBF-4317-4319;
Tri-Band	MBF-3708-3917-3719; MBF-3707-3708-3917; MBF-3707-3708-3719;
Quad-Band	MBF-3707-3708-3917-3719;
MIMO	MBF-3917-3917M-3719
MBF-40 Canada Repeaters	
Single Band	MBF-4307-AO; MBF-3707S-AO;
Dual Band	MBF-3708S-3709S-M; MBF-4317-4326-M;
Quad-Band	MBF-4308-4317-4319-4326-M-F; MBF-3707-3708-3917-3719 GB 115V
MIMO	MBF-4307-4307-M-AO

Copyright © 2015 Axell Wireless Ltd

All rights reserved.

No part of this document may be copied, distributed, transmitted, transcribed, stored in a retrieval system, or translated into any human or computer language without the prior written permission of Axell Wireless Ltd.

The manufacturer has made every effort to ensure that the instructions contained in this document are adequate and free of errors and omissions. The manufacturer will, if necessary, explain issues which may not be covered by this document. The manufacturer's liability for any errors in the document is limited to the correction of errors and the aforementioned advisory services.

This document has been prepared to be used by professional and properly trained personnel, and the customer assumes full responsibility when using them. The manufacturer welcomes customer comments as part of the process of continual development and improvement of the documentation in the best way possible from the user's viewpoint. Please submit your comments to the nearest Axell Wireless sales representative.

Contact Information

Headquarters	Axell Wireless Aerial House Asheridge Road Chesham Buckinghamshire HP5 2QD United Kingdom Tel: +44 1494 777000 Fax: +44 1494 777002
Commercial inquiries	info@axellwireless.com
Web site	www.axellwireless.com
Support issues	support@axellwireless.com
Technical Support Line, English speaking	+44 1494 777 747

Contact information for Axell Wireless offices in other countries can be found on our web site, www.axellwireless.com

About This Manual

This Product Manual provides the following information:

- Description of the MBF-40 Americas Repeaters
- Procedures for setup, configuration and checking the proper operation of the MBF-40
- Maintenance and troubleshooting procedures

Intended Audience

This Product Manual is intended for experienced technicians and engineers. It is assumed that the customers installing, operating, and maintaining Axell Wireless Remotes are familiar with the basic functionality of Remote repeaters.

Notice

Confidential - Authorized Customer Use

This document may be used in its complete form only and is solely for the use of Axell Wireless employees and authorized Axell Wireless channels or customers. The material herein is proprietary to Axell Wireless. Any unauthorized reproduction, use or disclosure of any part thereof is strictly prohibited.

All trademarks and registered trademarks are the property of their respective owners.

Disclaimer of Liability

Contents herein are current as of the date of publication. Axell Wireless reserves the right to change the contents without prior notice. The information furnished by Axell Wireless in this document is believed to be accurate and reliable. However, Axell Wireless assumes no responsibility for its use. In no event shall Axell Wireless be liable for any damage resulting from loss of data, loss of use, or loss of profits and Axell Wireless further disclaims any and all liability for indirect, incidental, special, consequential or other similes damages. This disclaimer of liability applies to all products, publications and services during and after the warranty period.

Guarantees

- **All antennas must be installed with lightning protection.** Damage to power modules, as a result of lightning are not covered by the warranty.
- **Antennas must be connected before switching on AC or DC power.** Switching power on prior to the connection of antenna cables is regarded as faulty installation procedure and therefore not covered by the Axell Wireless warranty.

Exclusive Remedies

The remedies provided herein are the Buyer's sole and exclusive remedies. Axell Wireless shall not be viable for any direct, incidental, or consequential damages, whether based on contract, tort, or any legal theory.

Compliance with FCC

FCC Part 20 Warning Statement



WARNING: This is NOT a CONSUMER device. It is designed for installation by FCC LICENCEES and QUALIFIED INSTALLERS. You must have an FCC LICENCE or express consent of an FCC Licensee to operate this device. Unauthorized use may result in significant forfeiture penalties, including penalties in excess of \$100,000 for each continuing violation.

If not installed and used in accordance with the instructions, this equipment generates, uses and can radiate radio frequency energy. However, there is no guarantee that interference will not occur in a particular installation. If this equipment does cause harmful interference to RF reception, which can be determined by turning the equipment off and on, the user is encouraged to try to correct the interference by one or more of the following measures:

- Increase the separation between the equipment and receiver.
- Connect the equipment into an outlet on a circuit different from that to which the receiver is connected.

Unauthorized Changes to Equipment

Changes or Modifications not expressly approved by the manufacturer responsible for compliance could void the user's authority to operate the equipment.

FCC RF Exposure Limits

This unit complies with FCC RF exposure limits for an uncontrolled environment. This equipment must be installed and operated with a minimum distance of 110 cm. between the radiator and any person's body.

Antenna Installation

Installation of an antenna must comply with the FCC RF exposure requirements. The antenna used for this booster must be mounted on outdoor or indoor permanent structures.

Compliance with IC

Under Industry Canada regulations, this radio transmitter may only operate using an antenna of a type and maximum (or lesser) gain approved for the transmitter by Industry Canada.

To reduce potential radio interference to other users, the antenna type and its gain should be so chosen that the equivalent isotropically radiated power (e.i.r.p.) is not more than that necessary for successful communication.





The Manufacturer's rated output power of this equipment is for single carrier operation. For situations when multiple carrier signals are present, the rating would have to be reduced by 3.5dB, especially where the output signal is re-radiated and can cause interference to adjacent band users. This power reduction is to be by means of input power or gain reduction and not by an attenuator at the output of the device.

Conformément à la réglementation d'Industrie Canada, le présent émetteur radio peut fonctionner avec une antenne d'un type et d'un gain maximal (ou inférieur) approuvé pour l'émetteur par Industrie Canada.

Dans le but de réduire les risques de brouillage radioélectrique à l'intention des autres utilisateurs, il faut choisir le type d'antenne et son gain de sorte que la puissance isotrope rayonnée équivalente (p.i.r.e.) ne dépasse pas l'intensité nécessaire à l'établissement d'une communication satisfaisante.

La puissance de sortie nominale indiquée par le fabricant pour cet appareil concerne son fonctionnement avec porteuse unique. Pour des appareils avec porteuses multiples, on doit réduire la valeur nominale de 3.5dB, surtout si le signal de sortie est retransmis et qu'il peut causer du brouillage aux utilisateurs de bandes adjacentes. Une telle réduction doit porter sur la puissance d'entrée ou sur le gain, et ne doit pas se faire au moyen d'un atténuateur raccordé à la sortie du dispositif.

General Safety Warnings Concerning Use of System

 Caution labels!	<p>Throughout this manual, there are "Caution" warnings. "Caution" calls attention to a procedure or practice, which, if ignored, may result in injury or damage to the system, system component or even the user. Do not perform any procedure preceded by a "Caution" until the described conditions are fully understood and met.</p>
 Electrical Shock	<p>Danger: To prevent electrical shock when installing or modifying the system power wiring, disconnect the wiring at the power source before working with un insulated wires or terminals.</p>
 Caution: Safety to personnel	<p>Before installing or replacing any of the equipment, the entire manual should be read and understood.</p> <p>The user needs to supply the appropriate AC or DC power to the repeater. Incorrect power settings can damage the repeater and may cause injury to the user.</p> <p>Please be aware that the equipment may, during certain conditions become very warm and can cause minor injuries if handled without any protection, such as gloves.</p>
 Caution: RF Exposure	<p>RF radiation, arising from transmitter outputs connected to AWL's equipment, must be considered a safety hazard.</p> <p>This condition might only occur in the event of cable disconnection, or because a 'spare' output has been left un-terminated. Either of these conditions would impair the system's efficiency. No investigation should be carried out until all RF power sources have been removed. This would always be a wise precaution, despite the severe mismatch between the impedance of an N type connector at 50 ohm, and that of free space at 377 ohm, which would severely compromise the efficient radiation of RF power. Radio frequency burns could also be a hazard, if any RF power carrying components were to be carelessly touched!</p> <p>Antenna positions should be chosen to comply with requirements (both local & statutory) regarding exposure of personnel to RF radiation. When connected to an antenna, the unit is capable of producing RF field strengths, which may exceed guideline safe values especially if used with antennas having appreciable gain. In this regard the use of directional antennas with backscreens and a strict site rule that personnel must remain behind the screen while the RF power is on, is strongly recommended.</p> <p>Where the equipment is used near power lines or in association with temporary masts not having lightning protection, the use of a safety earth connected to the case-earthing bolt is strongly advised.</p>





 <p>Caution: Safety to equipment</p>	<p>When installing, replacing or using this product, observe all safety precautions during handling and operation. Failure to comply with the following general safety precautions and with specific precautions described elsewhere in this manual violates the safety standards of the design, manufacture, and intended use of this product.</p> <p>Changes or modifications not expressly approved by the party responsible for compliance could void the user's authority to operate the equipment.</p> <p>Axell Wireless assumes no liability for the customer's failure to comply with these precautions. This entire manual should be read and understood before operating or maintaining the repeater.</p>
 <p>Warning: Restricted Access Location</p>	<p>Access to the Axell unit installation location is restricted to SERVICE PERSONNEL and to USERS who have been instructed on the restrictions and the required precautions to be taken.</p>
 <p>Attention: Electrostatic Sensitivity</p>	<p>Observe electrostatic precautionary procedures.</p> <p>ESD = Electrostatic Discharge Sensitive Device.</p> <p>Static electricity can be conducted to the semiconductor chip from the centre pin of the RF input connector, and through the AC connector pins. When unpacking and otherwise handling the repeater, follow ESD precautionary procedures including use of grounded wrist straps, grounded workbench surfaces, and grounded floor mats.</p>
 <p>Caution: Class 1 Laser</p>	<p>The repeaters described in this manual are equipped with class 1 lasers, as per definition in EN 60825-1</p> <p>Caution - Un-terminated optical receptacles may emit laser radiation. Exercise caution as follows:</p> <ul style="list-style-type: none"> • Do not stare into beam or view with optical instruments. Optical transmitters in the Fiber optic converter can send out high energy invisible laser radiation. There is a risk for permanent damage to the eye. • Always use protective cover on all cables and connectors which are not connected. • Never look directly into a Fiber cable or a connector. • Consider that a Fiber can carry transmission in both directions. • During handling of laser cables or connections, ensure that the source is switched off. • Regard all open connectors with respect and direct them in a safe direction and never towards a reflecting surface. Reflected laser radiation should be regarded as equally hazardous as direct radiation.

Table of Contents

Unauthorized Changes to Equipment.....	V
FCC RF Exposure Limits.....	V
Antenna Installation	V
1 Introduction.....	1
1.1 Features and Capabilities.....	2
1.2 ALC.....	3
1.3 MIMO Topology	3
1.4 Five-Band Configuration.....	4
1.5 Operating Temperature	5
1.6 MBF-40 Management Web GUI.....	5
1.7 MBF-40 Basic Interfaces	5
1.7.1 Securing the Unit	6
1.7.2 External Interfaces.....	7
1.7.3 Internal Interfaces	8
2 Installation Requirements	11
2.1 MBF-40 Installation requirements	11
2.1.1 Safety Guidelines.....	11
2.1.2 Criteria for Repeater Installation Location.....	11
2.1.3 RF Cable Installation Guidelines	12
2.1.4 F/O Cable Installation Guidelines.....	12
2.2 Service Antenna Requirements (English)	13
2.2.1 Required Antenna Information.....	13
2.2.2 Recommended Antennas	13
2.2.3 Recommended Splitters and Couplers.....	14
2.3 Service Antenna Requirements (French)	14
2.3.1 Antenne Informations Requises.....	14
2.3.2 FCC et IC conformité de l'installation intérieure.....	15
2.3.3 Critères d'installation de l'antenne d'installation d'intérieur	15
2.3.4 Indoor Installations Service/Mobile Antenna Requirements.....	15
2.3.5 Outdoor Installations.....	15
3 Repeater Installation.....	16
3.1 Location Criteria	16
3.2 Standard Repeater Installation.....	17
3.2.1 Unpacking	17
3.2.2 Parts List	17
3.2.3 Bracket Assembly	18
3.2.4 Wall Marking and Drilling.....	19
3.2.5 Mount the Repeater	22
3.3 Repeater with Fan Hood Installation	23
3.3.1 Dimensions	24
3.3.2 Parts List	25
3.3.3 Fan Hood and Bracket Assembly.....	26
3.4 Five-Band System Installation.....	30
3.4.1 Required Items for a Master Slave System	31
3.4.2 Mounting the Master and Slave Units.....	31
3.4.3 Connecting Master and Slave Units.....	32
3.4.4 Master/Slave Connections for External Alarms.....	34

3.5	Grounding	35
3.6	Ensure Good EMV Protection	36
3.7	Fiber Optic Connection	38
3.8	External Alarm and Relay Connections	41
3.8.1	External Alarm	41
3.8.2	Relay	41
3.9	Power and Backup Battery	42
3.9.1	Dual Power Supply Models	42
3.9.2	Circuit Breaker	42
3.9.3	Connecting the Power Source	43
3.9.4	115 VAC Power Source	43
3.9.5	-48V Power Source Connection	44
3.9.6	Backup Battery	45
3.10	Power ON	46
3.10.1	Switching Power ON	46
3.10.2	Verifying LEDs	46
3.11	Closing and Securing the Repeater	46
4	Opening a Session and Navigating GUI	47
4.1	Opening a Direct Web Session	47
4.1.1	Connecting Locally	47
4.1.2	Remote Connection and Login	48
4.2	Open a Session to the MBF-40 via the OMU II	49
4.3	Navigating the Web Interface	50
4.3.1	Management Options Buttons	51
4.3.2	Home Screen Overview	52
4.3.3	Configuration Screen Overview	53
4.3.4	Five Service System GUI	54
5	MBF-40 Commissioning	56
5.1	MBF-40 Optical Loss Adjustment (OLA)	56
5.2	RF Balancing	58
5.2.1	Manual RF Balancing	58
5.2.2	Automatic MBF-40 RF Balancing	60
5.3	Integration into the AEM	61
5.4	What Next?	61
6	MBF-40 Full GUI Description	62
6.1	Configuring General Parameters	62
6.1.1	Site Information – MBF-40 Identification	62
6.1.2	Date & Time	63
6.1.3	Configure External Alarms	63
6.1.4	IP Address	64
6.2	Remote Communication Setup	65
6.2.1	TCP/IP and Ethernet	65
6.3	SNMP Support	66
6.3.1	SNMP Traps Parameters	66
6.3.2	SNMP Agent - Activating and Configuring	66
6.4	User Accounts	67
6.4.1	Default User Accounts	67
6.4.2	User Access Levels	68
6.4.3	Change Password	68
6.5	Reboot	69

6.6	Axell Shell (Command Line Interface)	69
6.7	Attribute Reference	70
7	Monitoring and Fault Sourcing	71
7.1	Monitoring Via the MBF-40 Home Screen	72
7.1.1	General Page Area	73
7.1.2	Detailed view of the MBF-40	74
7.1.3	Detailed view of Fiber Optic Unit	75
7.1.4	Subsystems	75
7.2	Logs Screen	76
7.3	Module LEDs	77
7.3.1	Control Module LEDs	78
7.3.2	F/O Converter LEDs.....	78
7.3.3	Power Supply LEDs.....	79
8	Maintenance	80
8.1	Cautions and General Statements	80
8.2	Batteries	81
	Appendix A - US Specifications	82
	Appendix B - Canada Specifications	83
	Appendix C – F/O Cleaning Procedure	84
	Tools	84
	F/O Cleaning Procedure	85
	Dry Cleaning	85
	Wet Cleaning	87

1 Introduction

The Multi-Band Fiber optic fed system encapsulates solutions for both indoor and outdoor environments for single or multi-operator use. It offers seamless coverage in any indoor environment such as tunnels, subways and large buildings. Signals are coupled off from a nearby base station using an Optical Master Unit (OMU) and then distributed via Fiber to one or more MBF-40 repeaters.

The MBF-40's high output power allows for greater coverage whilst deploying fewer units. Even though providing high output power, the MBF-40 uses convection cooling, subsequently increasing the repeater's MTBF.

These remote units can be installed at a distance of up to 20 km from the base station site, offering great flexibility when providing RF coverage in areas where off air transmission is not a preferable solution.

A distributed antenna system (DAS) can be used to distribute the signal throughout the area to be covered.

Axell Wireless can provide a complete solution including design, site surveys and equipment related to the POI (Point Of Interface) such as combiners, filters, cross band couplers, etc.

The MBF-High Power product family includes single, dual, triple and quad band options conveniently co-located in a single, compact enclosure, as well as a five-band option that requires an Slave unit.

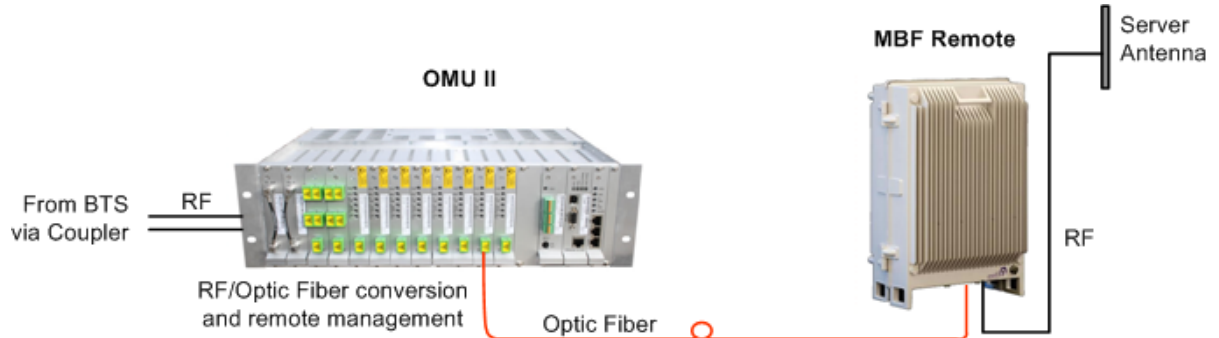

Figure 1-1: Illustration of a standard OMU II MBF Remote Application

1.1 Features and Capabilities

- High-power indoor/outdoor unit, single-band, dual-band, tri-band, quad-band models, supporting the following bands (model dependent):
 - LTE 700MHz (Upper and Lower band)
 - 700/800/900
 - Cellular 850MHz
 - PCS 1900MHz
 - AWS 1700MHz (MIMO model available)
 - 2600
- Up to four frequencies in a single enclosure
- Five-band single fiber-optic solution – implemented using two units MBF-40 Master and MBF-40 Slave models
- Single enclosure MIMO support
- Output power at the antenna (composite): 37dBm, 39dBm, 43dBm (model dependent)
- Very low noise factor - minimizes interference to BTS and increases high speed data throughput
- Single or Dual Fiber feed models available
- Remote commissioning and monitoring:
 - Via OMU II intuitive Web GUI
 - Via AEM – no local setup required
 - SNMP v1/v2c support
- Plug-and-Play: Automatic detection and Optical Gain Setting via the OMU
- Automatic Level Control (ALC) - provides constant gain in both uplink and downlink paths according to the defined maximum output level
- Backup battery for 'last gasp' indication (sending fault error before power failure)
- Optional - two internal power supplies provided for some models ensure robust unit operation
- Power source: 115VAC or -48V power (model dependent)

1.2 ALC

The repeater has a constant gain in both uplink and downlink paths. The repeater has a defined maximum output level. If the input signal amplified by the gain set exceeds the set output limit, an ALC (Automatic Level Control) loop is activated. This ALC ensures that the amplifier does not add distortion to the radio signal. Below are examples of the ALC function for one and two carriers.

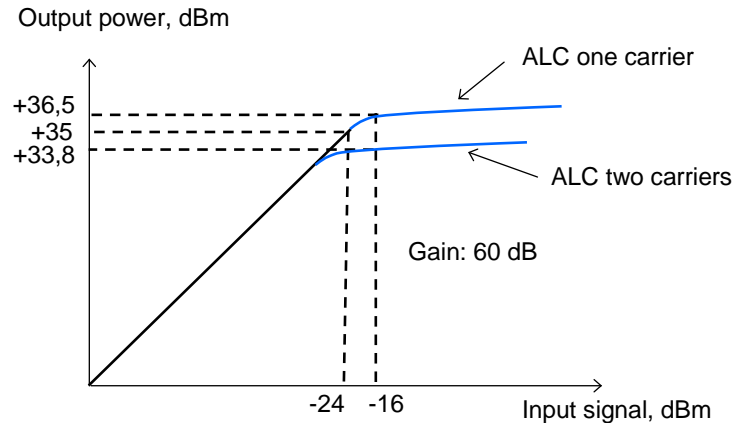

Figure 1-2: ALC

1.3 MIMO Topology

MIMO configuration is supported by specific MBF-40 models. The physical casing of these models supports two antenna ports and includes two (internal) optic conversion modules (see section 1.7.3.4).

MBF-40 MIMO topology requires an OMU II unit that supports at least two sectors. Two dedicated optic Fibers are routed from the OMU II towards the MBF-40.

Where relevant, MIMO specific installation instructions are provided in the manual.

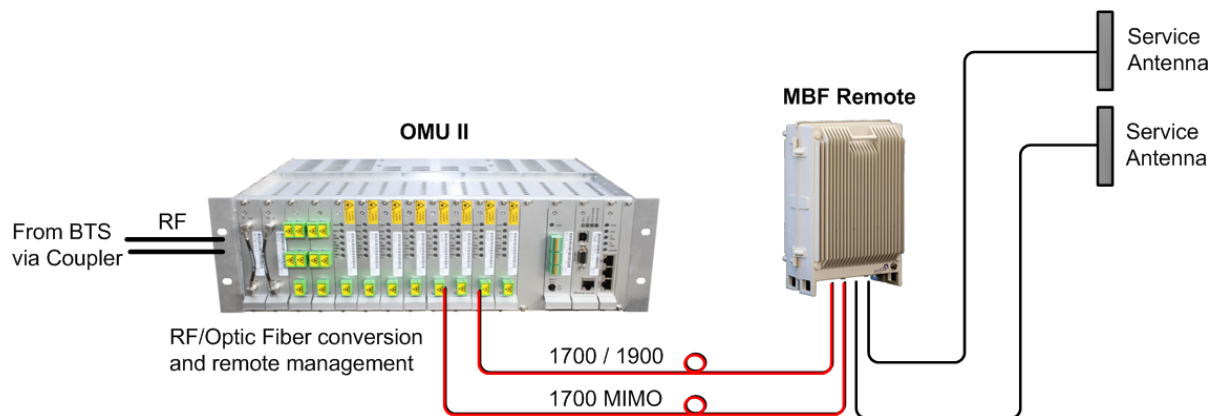

Figure 1-3: MIMO OMU II-MBF-40 Remote Application

1.4 Five-Band Configuration

Cost effective five-band support over a single fiber-optic is implemented using two MBF-units: MBF-40 Slave unit and MBF-40 Master unit. The Master unit can be either tri-band or quad-band unit, where the Slave provides single-band or dual-band support for a total of five bands.

All the services are routed to the Master unit via the optic fiber. The relevant (tri or quad) services are filtered by the Master unit and forwarded along with the unfiltered Slave services towards the Slave unit. At the Slave unit, the additional services are filtered and all five services are routed towards the service antenna for distribution. Five-Band System installation instructions are provided in section 3.4.

NOTE: The Web interface displays the five band service system as a single, 5-band unit. See Section 4.3.4. The connections between the two units are detailed in section 3.4.

The following figure shows a Master/Slave configuration. The figure below shows a five band configuration implemented using a quad-band Master and single-band Slave. The example shows connections for a configuration WITHOUT external alarms.

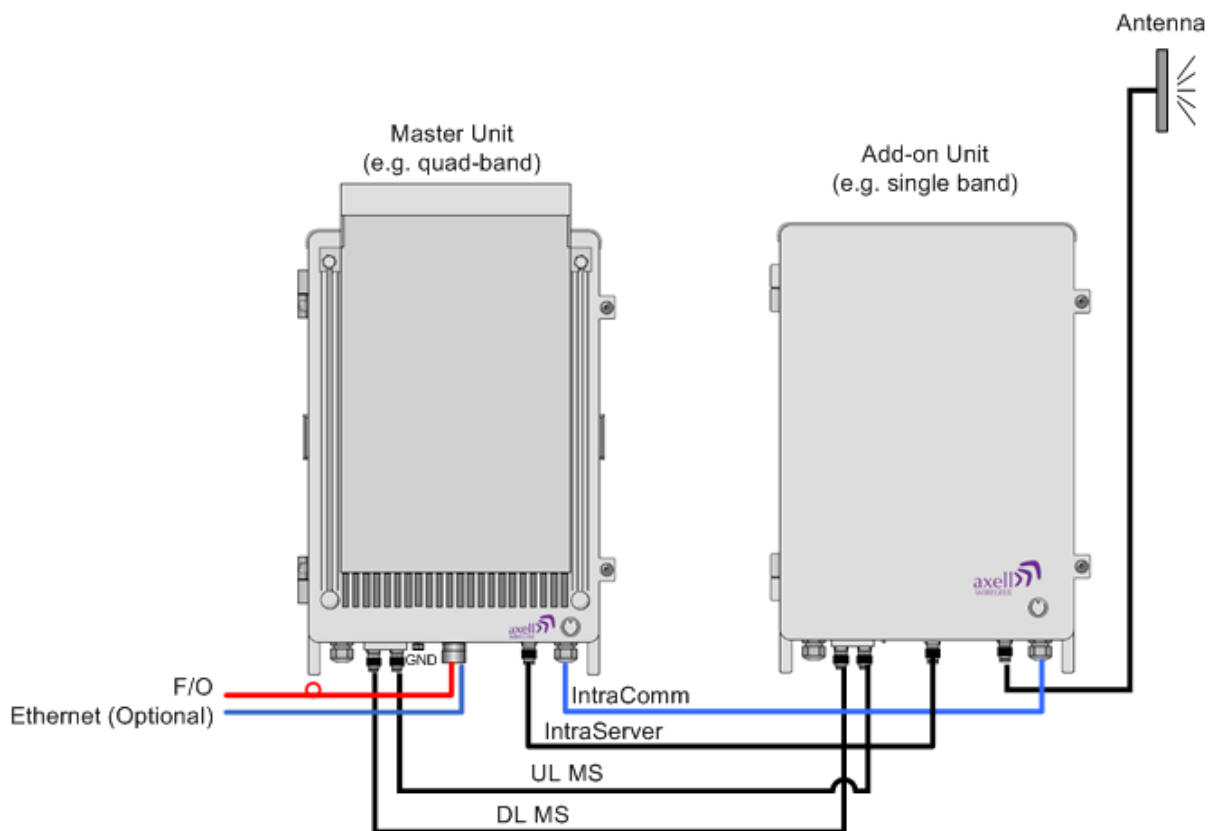

Figure 1-4: Example of Five-band Configuration

1.5 Operating Temperature

The MBF-40 is designed primarily for multi carrier purposes. If the repeater is run at full output power over a long period of time, additional, external cooling may be required; this can take the form of air-conditioning or an external fan assembly.

Specific MBF-40 models, whose power consumption exceeds 400W, are provided with an additional fan hood cooling assembly.

NOTE: The repeater is equipped with a power management function that steps down the power and, if needed, fully shuts down the amplifier chains until temperature reaches normal values.

1.6 MBF-40 Management Web GUI

MBF-40 is remotely commissioned and monitored via an OMUII session. Local access to the unit is not required for commissioning.

Additional configuration and troubleshooting options are available via a direct connection to the MBF-40 IP address. A direct session can be opened locally or remotely.

NOTE: Direct remote communication requires connecting the MBF-40 to an Ethernet network.

1.7 MBF-40 Basic Interfaces

NOTE: This section describes the interfaces for MBF-40 models supporting up to four services and whose power consumption does not exceed 400W. MBF-40 models, supporting five services and with power consumption exceeding 400W are described in the relevant sections in chapter 3.

The MBF unit provides several types of interfaces:

- Lock and screws for protection and security
- External service antenna and GND connections
- Internal connections for power, Fiber optics and alarm cables routed via openings in the screen.
- Internal USB and Ethernet connections for local setup via Web GUI

1.7.1 Securing the Unit

The repeaters are secured with two hex screws (M8) and can also be locked with a key.

NOTE: The two screws must be fully tightened. Failure to do so may affect the IP65 compliancy and therefore any warranty.



Figure 1-5: Securing Single/Dual Band

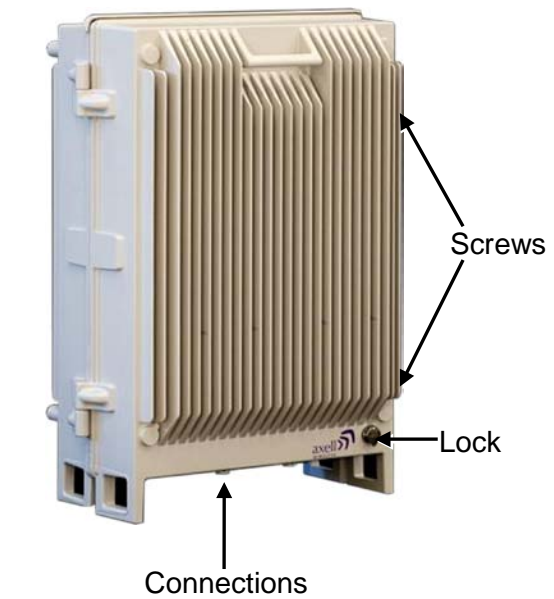

Figure 1-6: Securing Tri/Quad Band

1.7.2 External Interfaces

The repeater's interfaces are located on the underside. Two basic models are available: single and dual service antennas.

NOTE: The external connections at the bottom of the repeater can be protected with a cover which is screwed in place.

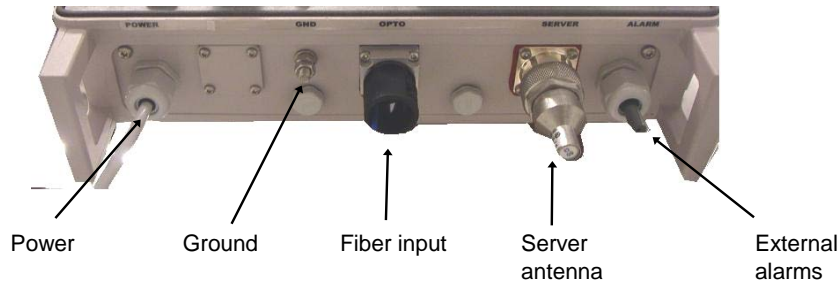

Figure 1-7: Single Service Antenna

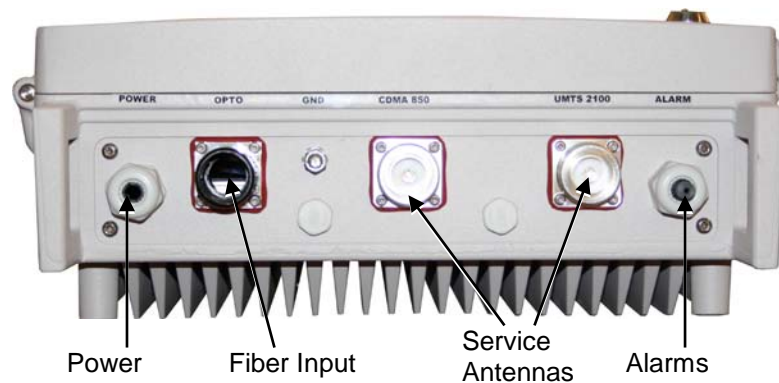

Figure 1-8: Dual/MIMO Service Antenna

The following table provides a description of the front screenl ports and connections.

Port	Description
Server	Service antenna connection - DIN 7/16" connector, female
Optic	SC/APC Fiber optic inlet through which the optic Fiber is routed for internal connections (section 3.7). For MIMO models – route the two Fibers via the Fiber port. NOTE: Optic Fiber Conduit hose fitter may be pre-assembled.
Power	Plinth connection for routing power for internal connection (section 3.9)
Alarms	Plinth connector for routing external alarms and relay wiring cable for internal connections (section 3.8).
GND	Grounding lug (section 3.5)

1.7.3 Internal Interfaces

This section shows the internal interfaces for various models. You will need to open the Repeater in order to do the following:

- Connect power
- Connect optic Fibers
- Connect alarms (if relevant)
- Power-on (Power-ON switch)
- **Optional** – USB/Ethernet port for local setup

1.7.3.1 Single/Dual-Band Single Antenna Model

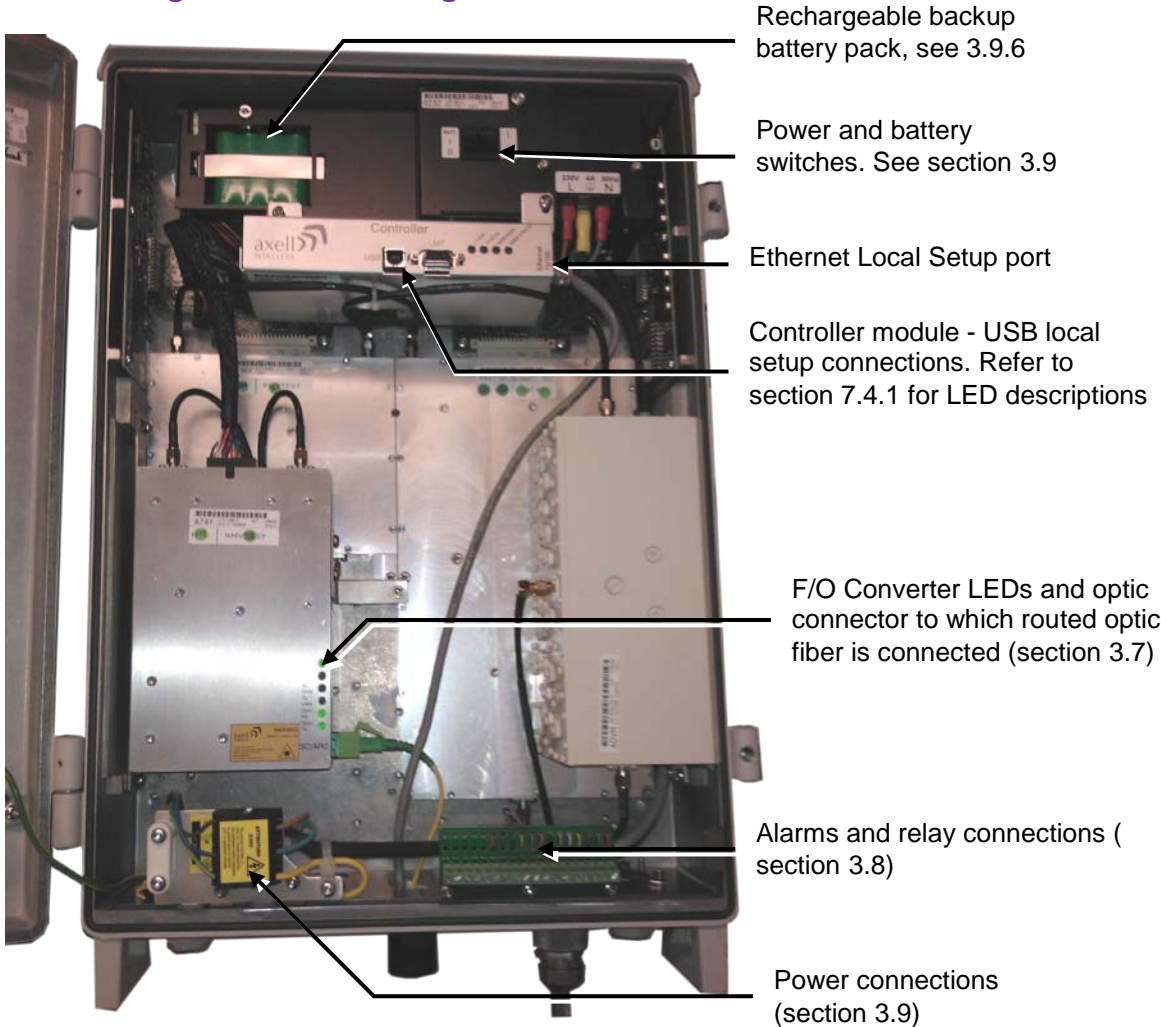

Figure 1-9: Single Band Repeater with Door Open

1.7.3.2 Dual-Band Dual-Antenna Model

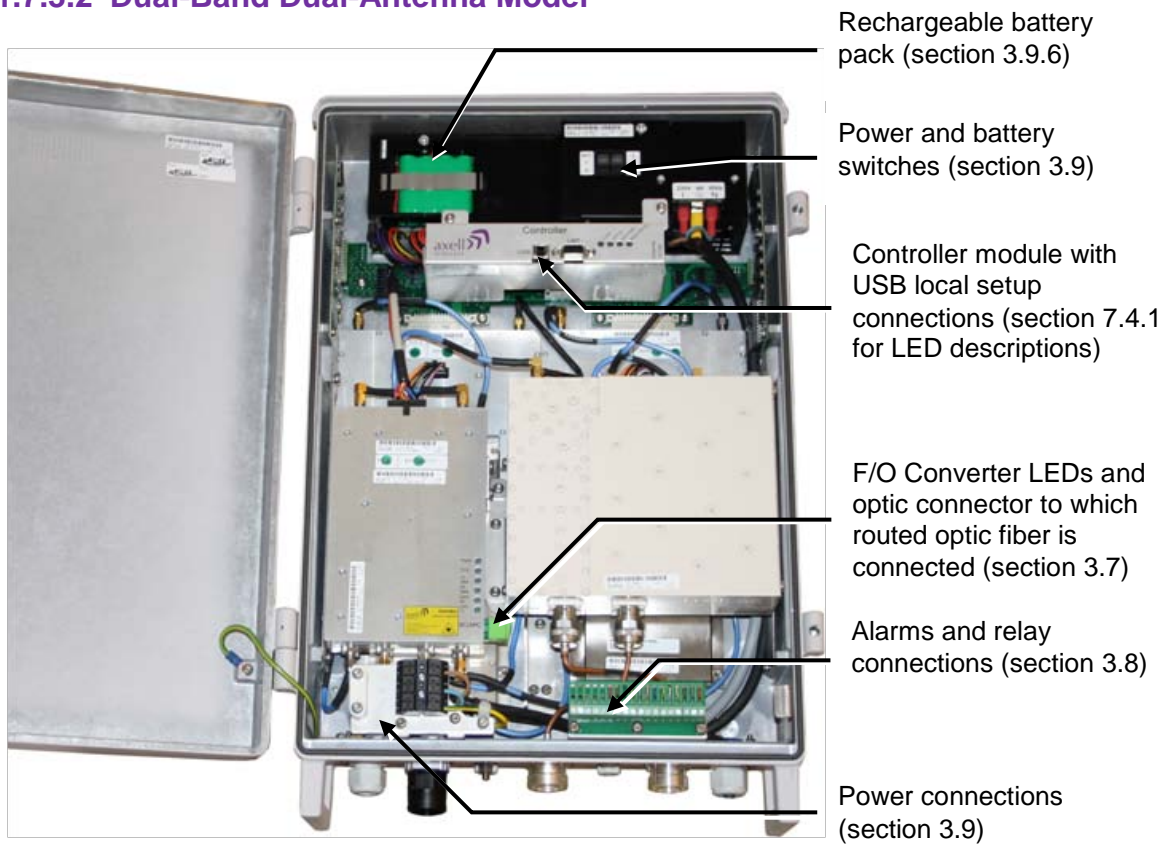

Figure 1-10: Dual band Dual Service Antenna Model

1.7.3.3 Dual Power Supply

The figure below provides an example of a unit with a dual power supply. The internal view of your unit may differ.

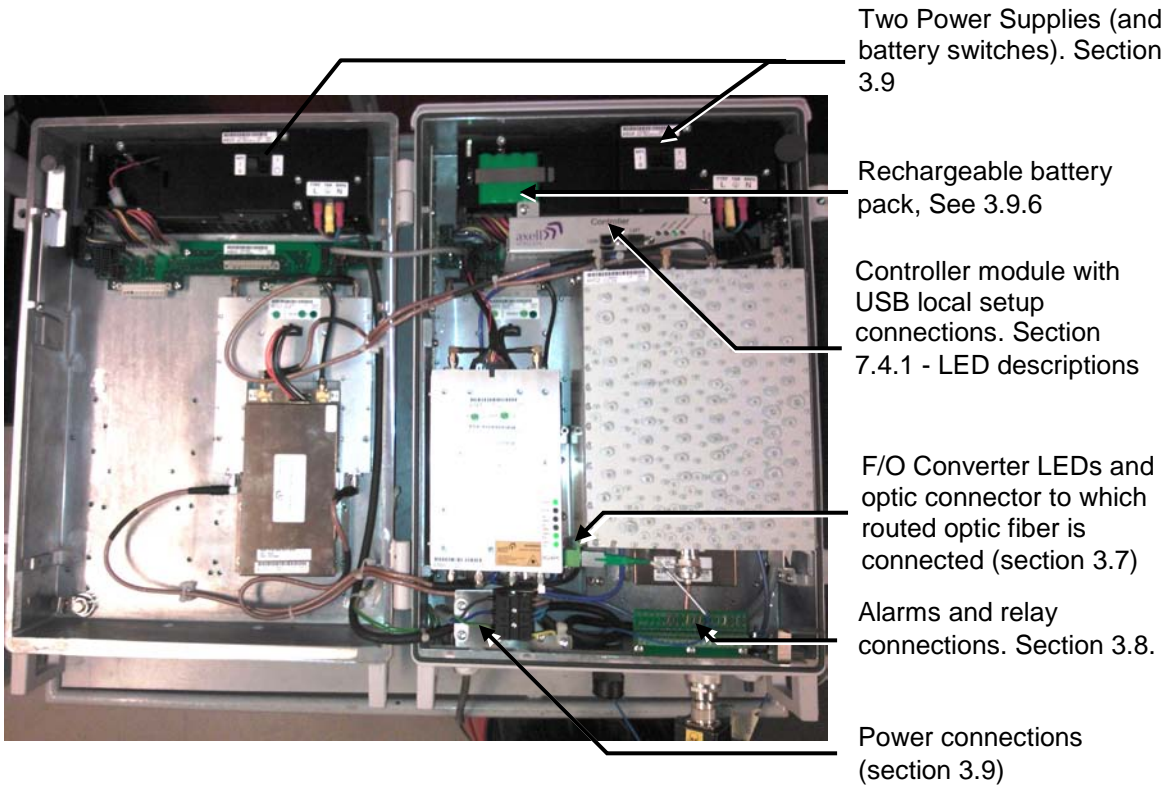

Figure 1-11: Dual band Dual Service Antenna Model

1.7.3.4 MIMO Model

The MIMO model includes two Service Antenna ports and two Optic Converter modules (shown below). All other connections and interfaces are similar to the above models.

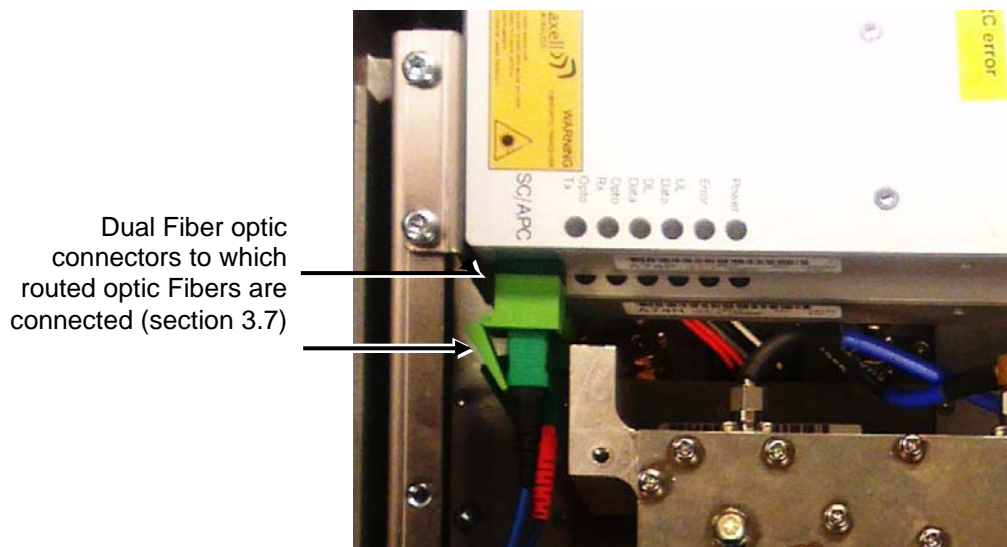

Figure 1-12: MIMO Model

2 Installation Requirements

This chapter provides information on the Remote installation site requirements, on the installation requirements of the antennas, the specifications of the service antennas suitable for operation with this remote and RF and F/O cable requirements.

2.1 MBF-40 Installation requirements



2.1.1 Safety Guidelines

Before installing the Repeater, review the following safety information:

- Follow all local safety regulations when installing the Repeater.
- Only qualified personnel are authorized to install and maintain the Repeater.
- Ground the Repeater with the grounding bolt located on the external lower side of the Repeater).
- Do not use the grounding bolt to connect external devices.
- Follow Electro-Static Discharge (ESD) precautions.
- Use low loss cables to connect the antennas to the Repeater.

Class 1 Laser

This product is equipped with class 1 lasers, as per definition in EN 60825-1.

		<p>Caution!!! Un-terminated optical receptacles may emit laser radiation. Do not stare into beam or view with optical instruments.</p>
---	---	---

2.1.2 Criteria for Repeater Installation Location

The following criteria should be considered when selecting the Repeater installation site location:

- Application type
- General surroundings
- Available installation
- Install the Repeater in a shielded, ventilated, and easy-to-reach area.
- Verify that there is a minimum of a 50 cm (20") radius of space around the Repeater, enabling easy access to the repeater for maintenance and on-site inspection.
- Distance from antenna site - It is recommended that the installation location be as close as possible to the antenna site in order to maintain the cable loss to a minimum.
- The Repeater is convection cooled so airflow and alternation should be possible.
- Follow Electro-Static Discharge (ESD) precautions.
- Install the Repeater close to the service area to monitor the output power.
- Use low loss cables to connect the antennas to the Repeater.

2.1.3 RF Cable Installation Guidelines

- For all coaxial connections to/from the Repeater – use high performance, low-loss, 50 ohm coaxial communication cables.
- All cables shall be weather-resistant type.
- Cable length – determined by the Repeater installation plan. When calculating the cable length, take into account excess cable slack so as not to limit the insertion paths.
- Make sure the cable and the connector are compatible. Using cables and connectors from the same manufacturer is helpful.
- All connectors must be clean and dry.
- Waterproof all outdoor connections using silicon, vulcanizable tape or any other suitable substance, as moisture and dust can impair RF characteristics
- Make sure enough room has been allocated for the bending radius of the cable. RF cables must not be kinked, cut or damaged in any way.
- Connect the RF cable to the antenna tightly but without damaging threads.
- Fasten cable tightly to cable ladder or aluminium sheet.
- For short length feeder cables, use 1/2"; for longer feeder cables, use 7/8". Choose thicker coax cables for lower attenuation. Minimize the length of the coax cables to reduce attenuation.
- Use jumper cable for easy installation. The RF coaxial cable can be substituted at each end with a jumper cable.

2.1.4 F/O Cable Installation Guidelines

Use the following over the complete link between the Remote and OMU:

- Use angled APC connectors at 8deg angle.
- APC type ODF connections.
- Cable length - determined by the Remote installation plan. When calculating the cable length, take into account excess cable slack so as not to limit the insertion paths.

Recommended Fiber-optic cable:

- Single mode 9/125

2.2 Service Antenna Requirements (English)

This section provides information on the specifications of the service antennas suitable for operation with this repeater, on the installation requirements of the antennas and on the Repeater installation site and cable requirements.

ATTENTION!!



- The installer is held accountable for implementing the rules required for deployment.
- Good engineering practice must be used to avoid interference.
- Output power should be reduced to solve any IMD interference issues.
- The installation height of the antenna for AWS band (1700/2100 MHz) operations is limited to 10 meters above ground for compliance with 47 CFR 27.50.

2.2.1 Required Antenna Information

The following antenna requirements, specifications and site considerations should be met.

- Type of installation – indoor or outdoor
- Service area type and size
- Antenna type and characteristics
- Height
- Length and type of coaxial cable required for connecting the Service antenna to the Remote and the attenuation.

2.2.2 Recommended Antennas

The Service antenna is installed indoors, where the type of antenna depends on the application.

Specifications:

- One or a combination of the following antennas can be used: Ceiling Mount Patch antenna, Wall Mount Patch antenna, Corner Reflector.
- Choose an antenna with high side lobe attenuation which enables maximum isolation from other service/ mobile antennas.
- Net gain [Gain Antenna – Cable loss] must not exceed 9 dBi
- Antennas with gain < 9 dBi can be connected *directly* to the MBF-40 ports.
- Higher gain antennas may be connected to the MBF-40 ports along with adequate cable and splitting losses

Typical antenna types:

- Indoor Dome 2.1 dBi; beam width 360°
- Indoor Panel 4.2 dBi; beam width 106°
- Radiating Cable Typically < -50 dBi

2.2.3 Recommended Splitters and Couplers

2.2.3.1 Recommended Splitters

Splitter part numbers	90 - 851102	90 - 851103	90 - 851104
Frequency band	700 – 2700 MHz	700 – 2700 MHz	700 – 2700 MHz
Split	2 way	3 way	4 way
Max Insertion Loss	0.4 dB	0.6 dB	0.6 dB
Split Loss	3 dB	4.8 dB	6 dB

2.2.3.2 Recommended Couplers

Coupler part numbers	90 - 852206	90 - 852210	90 - 852215	90 - 852220
Frequency band	700-2700 MHz	700-2700 MHz	700-2700 MHz	700-2700 MHz
Coupling	-6dB ±0.8dB	-10dB ±1.0dB	-15dB ±1.0dB	-20dB ±1.0dB
Max Mainline Loss	1.7 dB	0.8 dB	0.4 dB	0.22 dB

2.3 Service Antenna Requirements (French)

Cette section fournit des informations sur les spécifications du donneur et des antennes de services adaptés pour fonctionner avec ce répéteur, sur les conditions d'installation des antennes et sur le site d'installation de répéteur et exigences de câblage.

ATTENTION!!



- *L'installateur est tenu pour responsable de la mise en œuvre des règles nécessaires au déploiement.*
- *Les bonnes pratiques d'ingénierie doit être utilisée pour éviter les interférences.*
- *Puissance de sortie doit être réduite pour résoudre tous les problèmes d'interférence de l'IMD.*

2.3.1 Antenne Informations Requises

Les exigences d'antenne suivants, les spécifications et considérations du site doivent être remplies:

- *Type d'installation - à l'intérieur ou à l'extérieur*
- *Type de zone de service et la taille*
- *Type et les caractéristiques de l'antenne*
- *Hauteur*
- *La longueur et le type de câble coaxial requis pour relier l'antenne au répéteur et l'atténuation.*

2.3.2 FCC et IC conformité de l'installation intérieure

L'antenne de service est installé à l'intérieur, où le type d'antenne dépend de l'application.:

- *Un ou une combinaison des antennes suivantes peuvent être utilisées: Antenne Patch pour montage au plafond, antenne Patch pour montage mural, Réflecteur en Coin.*
- *Choisissez une antenne à haute côté atténuation du lobe qui permet une isolation maximum des autres services / antennes mobiles.*
- *Gain net [Gain Antenna - la perte de câble] ne doit pas dépasser 9 dBi*
- *Les antennes à gain < 9 dBi peut être connectée directement aux ports MBF-40.*
- *Antennes à gain plus élevées peuvent être connectés aux ports MBF-40 avec des pertes de câble et de division adéquates.*

2.3.3 Critères d'installation de l'antenne d'installation d'intérieur

Déterminer la configuration de l'installation de l'antenne, selon les exigences de transmission et les conditions du site d'installation.

Exigences d'installation:

- *Une antenne intérieure doit être installée à un endroit pratique. Il doit être libre de tout obstacle métallique.*
- *Installez l'antenne de service à la hauteur désignée et l'accorder à peu près vers la zone de couverture du service.*
- *L'installation de cette antenne doit fournir une distance minimale de séparation de 110 cm de tout le personnel dans la région*

2.3.4 Indoor Installations Service/Mobile Antenna Requirements

Determine the antenna installation configuration, according to the transmission requirements and the installation site conditions.

Installation requirements:

- An indoor antenna should be installed at a convenient location. It should be free of metallic obstruction.
- Install the Service Antenna at the designated height and tune it roughly toward the Service coverage area.

2.3.5 Outdoor Installations

For applications in which the Service/Mobile antenna is installed outdoor, the antenna type is chosen according to the available infrastructure (single-pole or horizontal installation). In addition, isolation between the donor and service antennas must be taken into account when selecting the location of the antennas.

3 Repeater Installation

This chapter describes the installation of various repeater models, including repeaters with fan assemblies (section 3.3) and five service Master / Slave systems (section 3.4).



WARNING!! Maximum input power should not exceed (zero) 0 dBm

3.1 Location Criteria

Location criteria

- **Wall compatibility** - check the suitability of the wall on which the MBF-40 is to be fitted.
- **Plan mount** - check the actual fixing centres (see below) and overall dimensions of the MBF-40 enclosure. The MBF-40 is supplied with two wall mounting brackets; when the MBF-40 is mounted on these brackets adequate ventilation is provided between the MBF-40 and the wall to which it is fixed.
- **Plan connection cable clearances** - the Optical, RF and power connections located on the underside of the MBF-40 will need at least 300mm vertical clearance below the MBF-40 to enable the connections to be made. The minimum bend radius for Optical and RF cables must not be less than the recommendations made by the cable manufacturer. Plan the cable runs and ensure adequate space is available.
- **Allow for door opening** - ensure that there is sufficient space at the front of the MBF-40 to allow the door to be fully opened and for maintenance engineers to get access to the unit with test equipment such as a spectrum analyzer. Allow an additional 500mm of space in front of the MBF-40 when the door is fully open.
- **Allow for heat dispersion** - Mount the repeater so that heat can be dispersed from it.

The repeater wall mounting kit ensures an optimum airflow between the wall and the repeater.) Do not block this air channel as it will cause the MTBF of the repeater to drop dramatically, or even in the worst case cause the repeater to fail completely.

If possible, use a wall in the shade to minimize the overall sun loading. If sufficient shielding cannot be obtained, an additional sun shield should be mounted.



Figure 3-1: Example of a sun shield

3.2 Standard Repeater Installation

NOTE: Refer to this section if your repeater installation does not consist of either a fan assembly or a Master / Slave (five service) system.



3.2.1 Unpacking

Upon receiving the MBF-40 Repeater perform the following:

1. Examine the shipping container for damage before unpacking the unit.
2. Perform a visual inspection to reveal any physical damage to the equipment.
3. Verify that all of the equipment (listed below) is included. Otherwise contact Axell Wireless Ltd. The MBF-40 Repeater is shipped with the following equipment:

3.2.2 Parts List

Package Contents

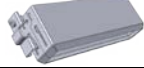
MBF-40 Single/Dual/Tri/Quad- band Repeater												
CD containing User's Manual and USB driver												
Mounting Brackets												
Cable protection KPL												
Additional (supplied) installation components:	<table border="1"> <thead> <tr> <th data-bbox="635 1435 724 1469">Qty.</th> <th data-bbox="732 1435 1431 1469">Description</th> </tr> </thead> <tbody> <tr> <td data-bbox="635 1469 724 1541">4x</td> <td data-bbox="732 1469 1431 1541">M8x12 bolts for securing the Repeater to the brackets</td> </tr> <tr> <td data-bbox="635 1541 724 1581">1x</td> <td data-bbox="732 1541 1431 1581">Insex tool for bolts</td> </tr> <tr> <td data-bbox="635 1581 724 1659">1x</td> <td data-bbox="732 1581 1431 1659">Fiber Conduit inlet hose fitter (may be pre-assembled)</td> </tr> <tr> <td data-bbox="635 1659 724 1700">1 x</td> <td data-bbox="732 1659 1431 1700">Key</td> </tr> </tbody> </table>		Qty.	Description	4x	M8x12 bolts for securing the Repeater to the brackets	1x	Insex tool for bolts	1x	Fiber Conduit inlet hose fitter (may be pre-assembled)	1 x	Key
Qty.	Description											
4x	M8x12 bolts for securing the Repeater to the brackets											
1x	Insex tool for bolts											
1x	Fiber Conduit inlet hose fitter (may be pre-assembled)											
1 x	Key											
Optional equipment	AC Cable [30 ft.] – Long cable for AC power Alarm Cable [30 ft.] – Long cable for External Alarms Input											

3.2.3 Bracket Assembly

The repeater can be mounted on the wall or in a 19 inch rack.

Using the 4 provided M8 Fixing bolts and 4 spring washers assemble the brackets as illustrated below – according to your required mounting location (wall or rack).

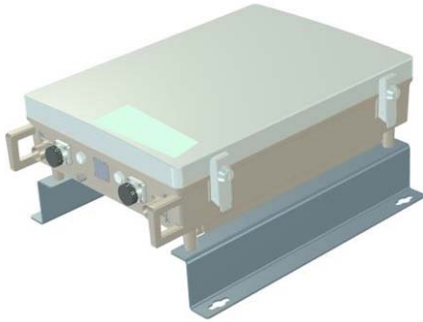

Figure 3-2: Wall mount bracket position



Figure 3-3: Rack-mount bracket position

- **Fix mounting brackets to MBF** – use the supplied four M8 bolts and spring washers.

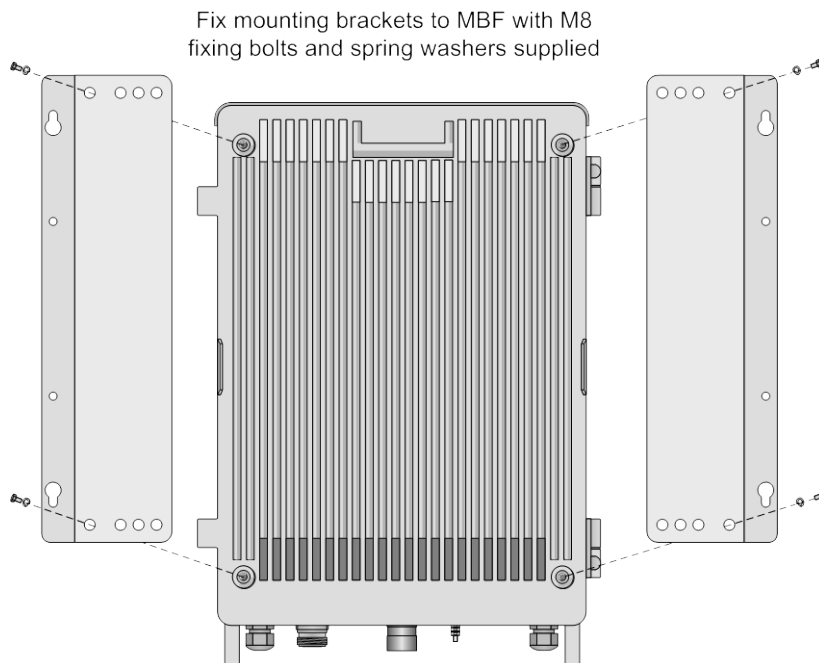

Figure 3-4: Fix mounting brackets to MBF

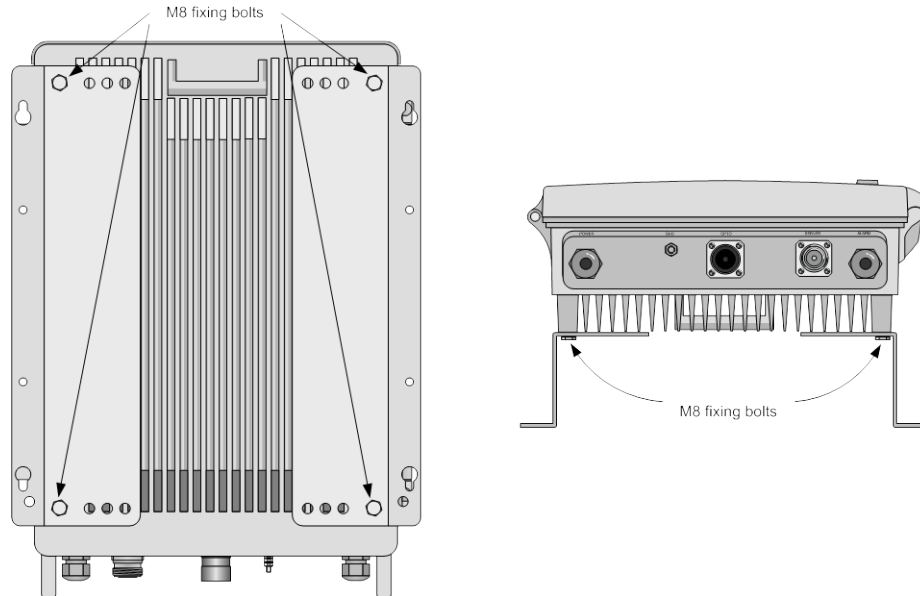

Figure 3-5: Mounting Plates Fixed to MBF

3.2.4 Wall Marking and Drilling

- The Repeater wall mount brackets assembly should be fixed to a solid wall (these include brickwork, blockwork, and concrete.);



WARNING!! Due to the weight of the Repeater, it is NOT recommended to fix to a hollow wall).

- To provide secure fixing to a solid wall, the most common method is drilling and plugging. The size of fixing is dependent on the item to be fixed and the nature of the wall, The Repeater should be fixed with mild steel, M6 (50mm to 75mm) rawlbolts or similar.
- Care must be taken to ensure the alignment of the four fixings. A spirit level or plumb line should be used to ensure horizontal/vertical alignment.

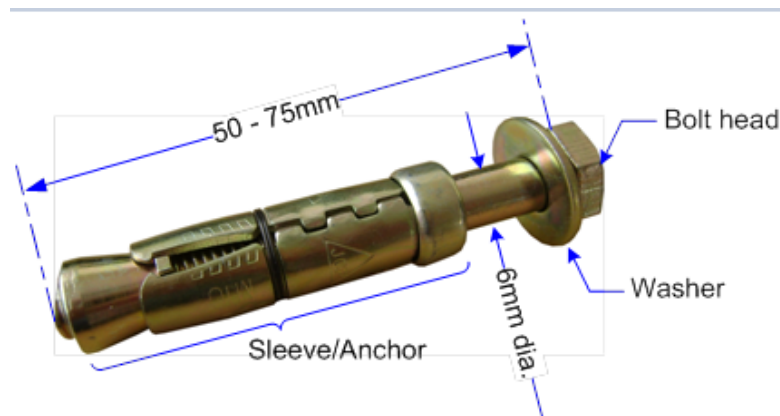

Figure 3-6: M6 Rawlbolt – recommended for wallmount.



IMPORTANT!! Always check that there are no pipes or cables hidden in the wall beneath the area to be drilled. Various pipe and cable detectors are available for this type of inspection.

To mark and drill the wall

1. Mark out the fixing centres of the repeater on the chosen wall. Refer to the repeater dimensions are shown below.

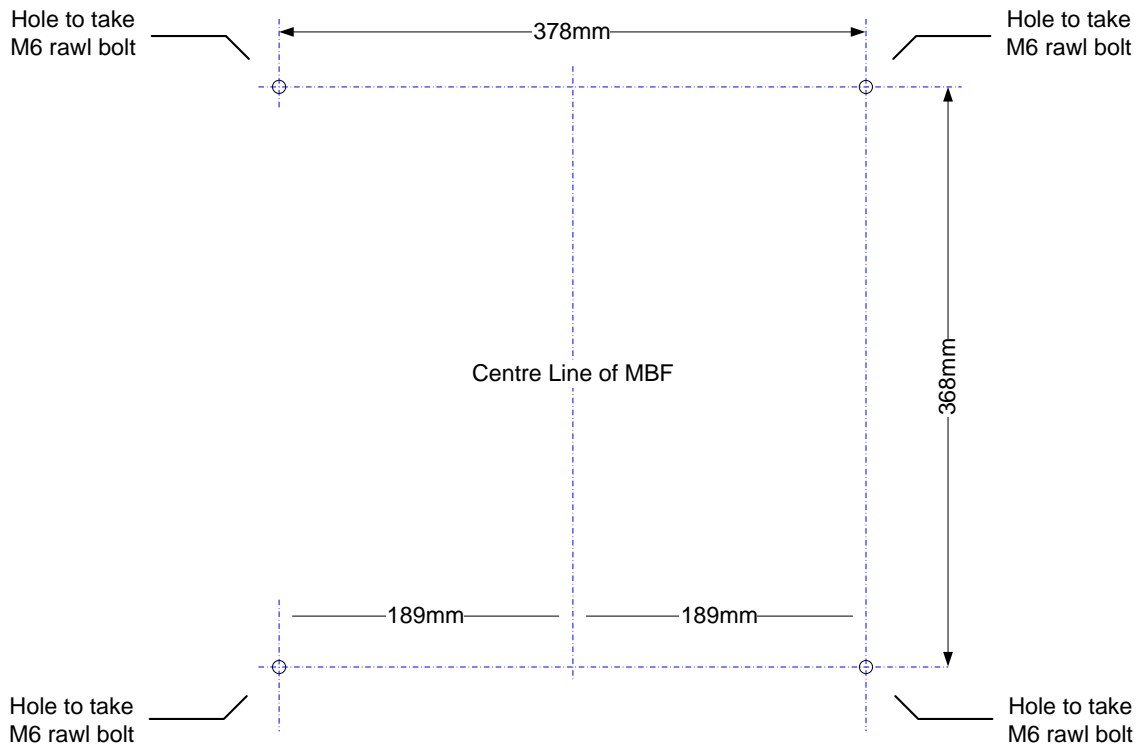

Figure 3-7: Fixing Centres

2. Mark and drill the wall with the correct size masonry bit as specified by the fixing manufacturer.

NOTE: It is good practice to wear goggles to protect your eyes from flying debris when using power tools.

3. Hold the drill bit against the mark and begin drilling slowly so that the bit does not wander from the position. The wall should be drilled to a depth which is sufficient to accommodate the full length of the fixing.
4. Insert the fixings so that the top of the sleeve/anchor section is level with the wall surface.

5. Gently tighten the bolt by hand so that the anchor section of the fixing expands and grips the inside of the hole.

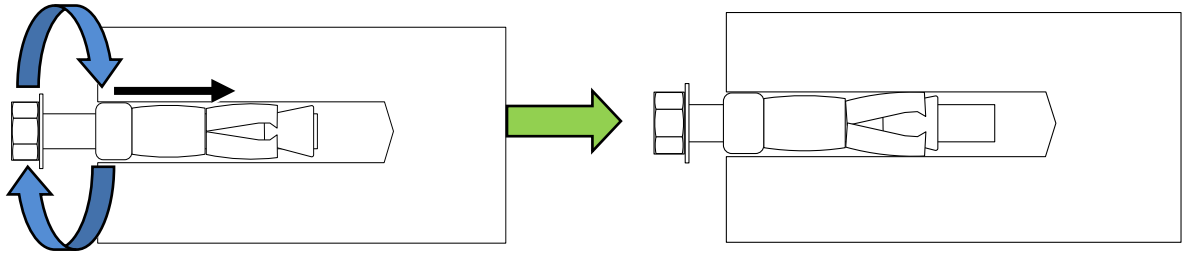

Figure 3-8: Inserting Fixing and Tightening.

6. As the bolt pulls its way in, the sides of the anchor section are forced outwards, gripping the surrounding surface.

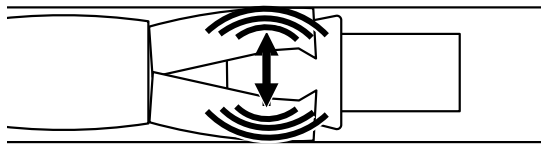

Figure 3-9: Anchor Sides Pushed Outwards.

7. Once all four fixings are in place, carefully withdraw the four bolts.

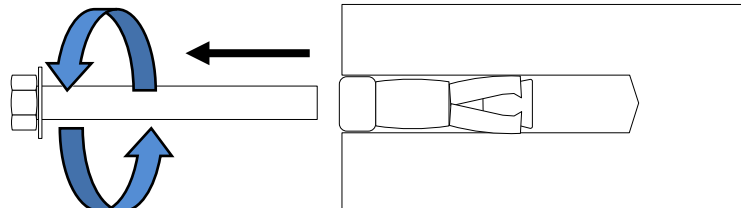

Figure 3-10: Withdraw Bolts.

3.2.5 Mount the Repeater



CAUTION!!! It is recommended that two people lift the repeater since (depending upon the configuration) the MBF-40 weighs between 20 and 38 kg (44 and 84 lb)

To mount the repeater

- Align repeater with the four fixings. Great care should be exercised here as the repeater is very heavy. (A suitably rated heavy duty scissor lift table/trolley may be suitable for this operation.)
- Once repeater is held in the chosen position, carefully insert the fixing bolts through the mounting lugs of the Repeater and into the sleeve/anchor sections of the fixing in the wall and tighten the bolts.
- ***The repeater needs to be mounted tightly to eliminate vibration.***

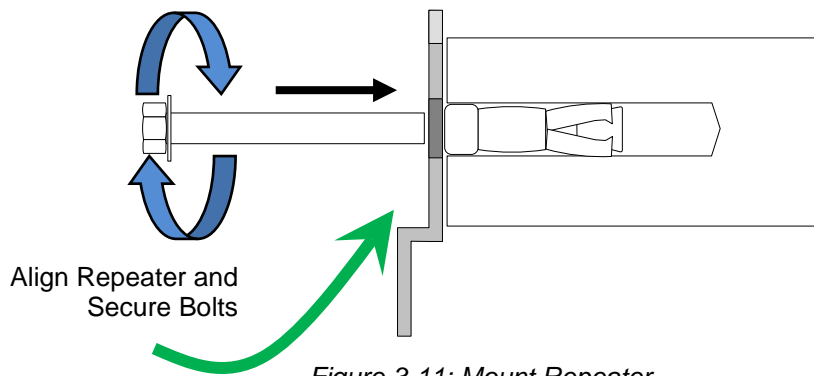



Figure 3-11: Mount Repeater

3.3 Repeater with Fan Hood Installation

Some repeater models with power consumption exceeding 400W are supplied with a fan-hood assembly kit. This section describes the bracket and fan assemblies for the relevant repeater models.



WARNINGS!!!

- The fan modules can only be assembled on the appropriate repeater models.
- This installation requires two people.

The following figure shows the assembled system. It includes the mounting brackets and two fan assembly units. The *dimensions*, *parts list* and *assembly instructions* are provided in the following sections.

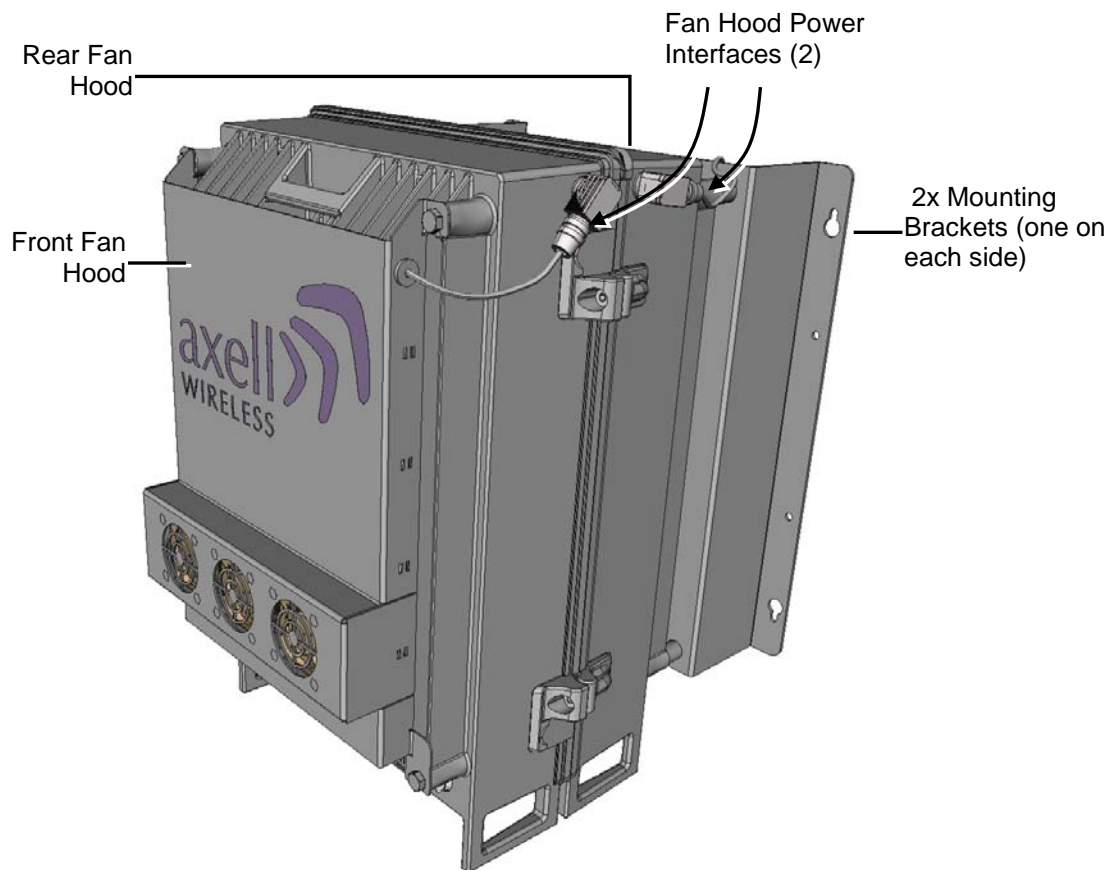

Figure 3-12: MBF-40 including Fan Hood

3.3.1 Dimensions

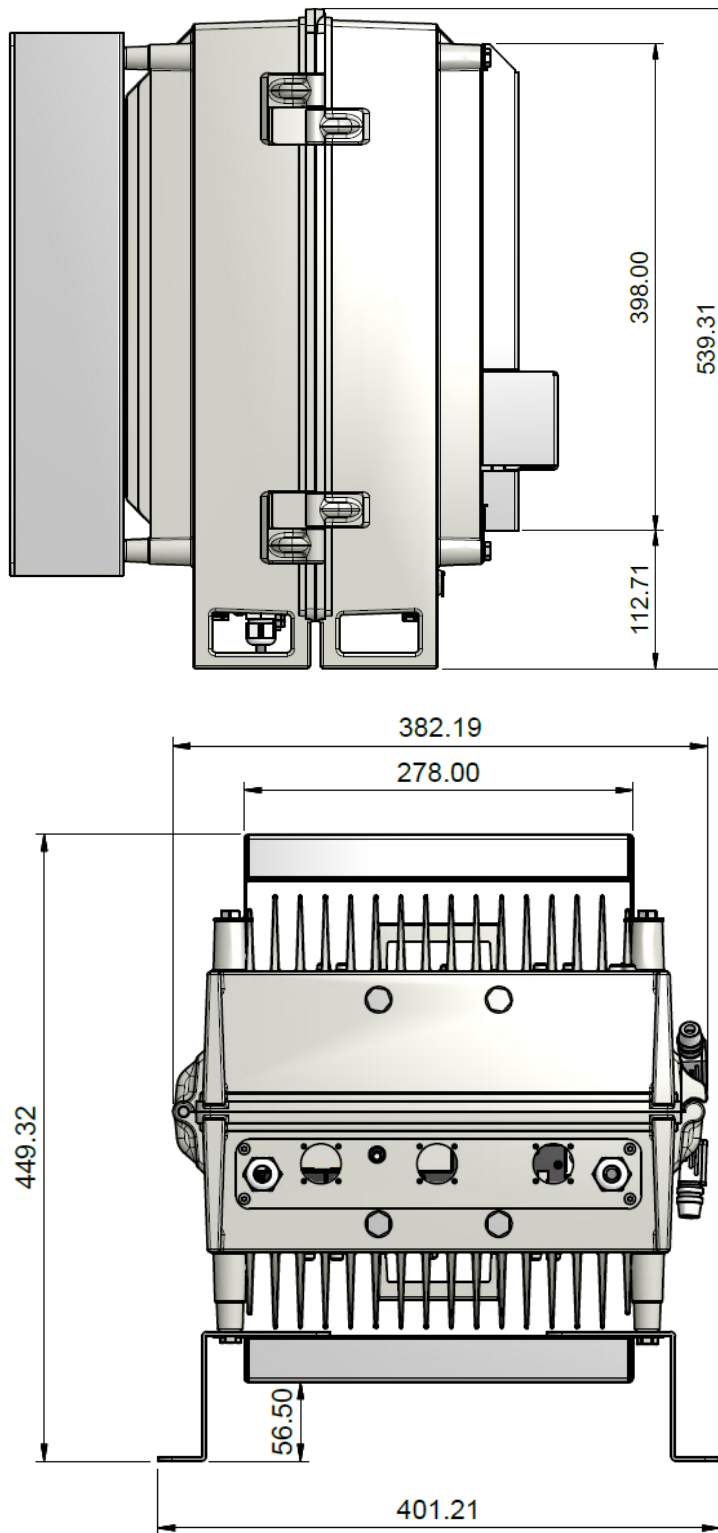



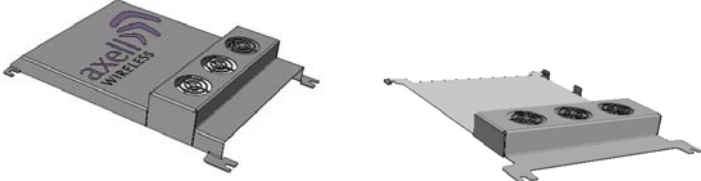

Figure 3-13: MBF-40 including Fan Hood – Assembly Dimensions

3.3.2 Parts List

NOTE: The Front Fan Hood and the Rear Fan Hood are NOT interchangeable.

Package Contents

<p>MBF-40 Repeater</p>											
<p>CD for OMU II and MBF Variants EMEA/Americas</p>											
<p>Mounting Brackets</p>											
<p>Cable protection KPL</p>											
<p>Front Fan Hood Rear Fan Hood</p>	 <p style="text-align: center;">Rear fan hood (no edges) Front fan hood (edged)</p>										
<p>Additional (supplied) installation components:</p>	<table border="1"> <thead> <tr> <th data-bbox="635 1249 724 1285">Qty.</th> <th data-bbox="724 1249 1442 1285">Description</th> </tr> </thead> <tbody> <tr> <td data-bbox="635 1285 724 1361">6x</td> <td data-bbox="724 1285 1442 1361">M8x12 bolts and washers for securing the Repeater to the brackets and fan hoods</td> </tr> <tr> <td data-bbox="635 1361 724 1406">1x</td> <td data-bbox="724 1361 1442 1406">Insex tool for bolts</td> </tr> <tr> <td data-bbox="635 1406 724 1473">1x</td> <td data-bbox="724 1406 1442 1473">Fiber Conduit inlet hose fitter (may be pre-assembled)</td> </tr> <tr> <td data-bbox="635 1473 724 1514">1 x</td> <td data-bbox="724 1473 1442 1514">Key</td> </tr> </tbody> </table>	Qty.	Description	6x	M8x12 bolts and washers for securing the Repeater to the brackets and fan hoods	1x	Insex tool for bolts	1x	Fiber Conduit inlet hose fitter (may be pre-assembled)	1 x	Key
Qty.	Description										
6x	M8x12 bolts and washers for securing the Repeater to the brackets and fan hoods										
1x	Insex tool for bolts										
1x	Fiber Conduit inlet hose fitter (may be pre-assembled)										
1 x	Key										
<p>Optional equipment</p>	<p>AC Cable [30 ft.] – Long cable for AC power Alarm Cable [30 ft.] – Long cable for External Alarms Input</p>										

3.3.3 Fan Hood and Bracket Assembly



WARNING!!

- This Fan Hood is to be assembled only on the MBF-40 units for which it is designed and with which it is supplied.
- Do NOT assemble this fan hood on any repeater models for which it is not specifically designed.
- Be sure to CAREFULLY follow all instructions – beginning with **Step-1**.

The fan hood and bracket assembly procedure is as follows:

- Assemble rear fan hood and mounting brackets
- Mount the repeater on the wall
- Assemble the front fan hood
- Connect power to both fan hoods

To assemble the fan hood

1. Place the repeater on a flat surface, repeater **door panel facing down**, interfaces towards you.
2. *Loosely* assemble the mounting brackets:
 - Align *innermost* bracket holes to *repeater* mounting holes.
 - *Loosely* insert bolts and washers.

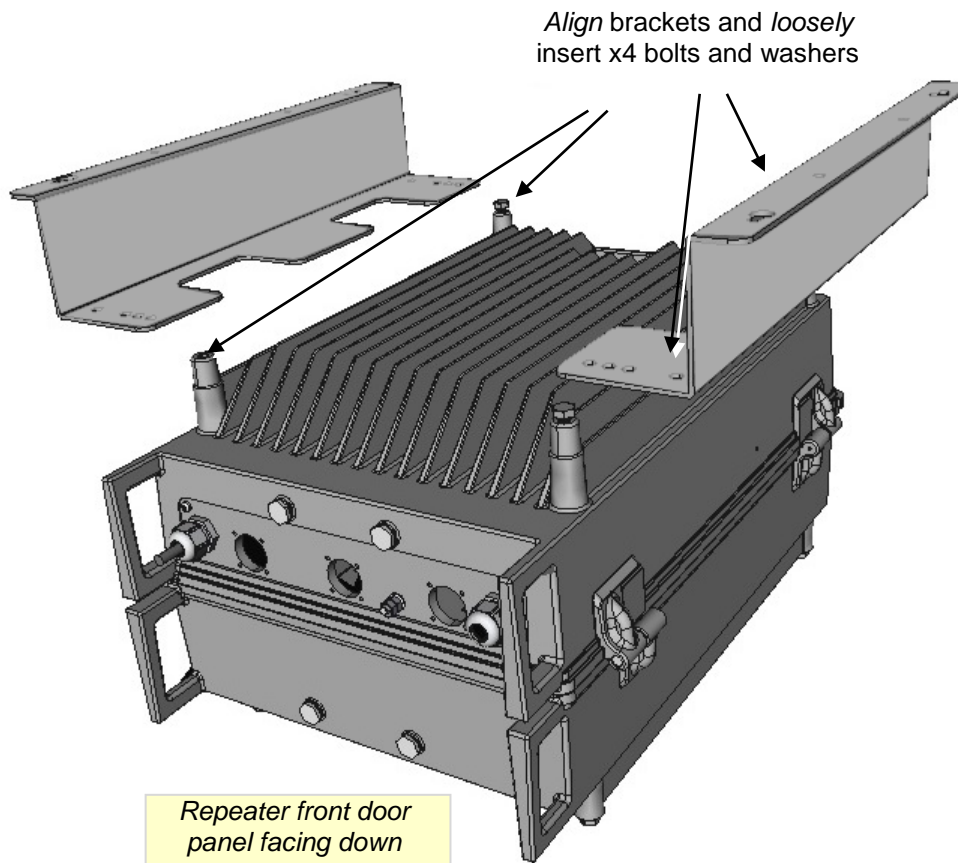

Figure 14: Place Brackets on top the MBF

3. Assemble Rear Fan Hood:

- Position the Rear Fan Hood under the (inserted) bolts and washers.
- Tighten the *four* bolts.

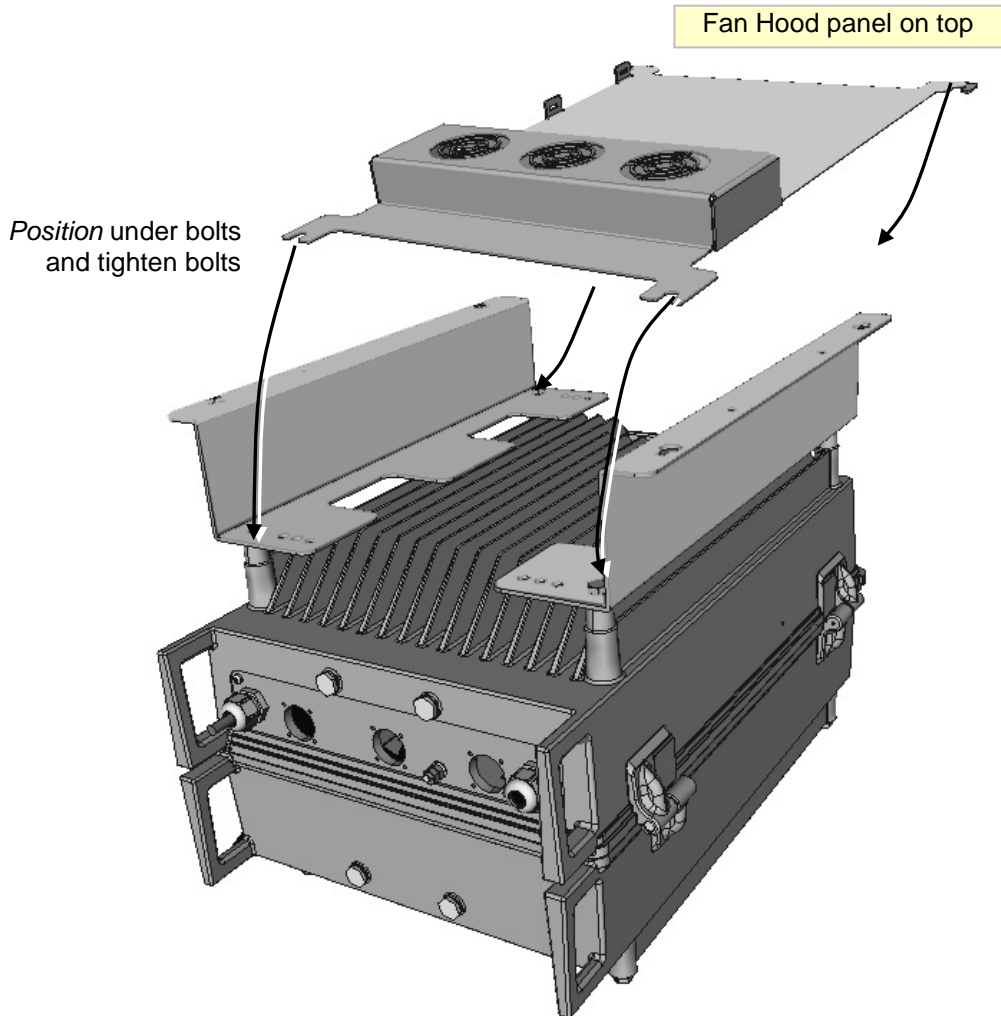

Figure 3-15: Assemble Rear Fan Hood

The brackets and Rear Fan Assembly is shown below.

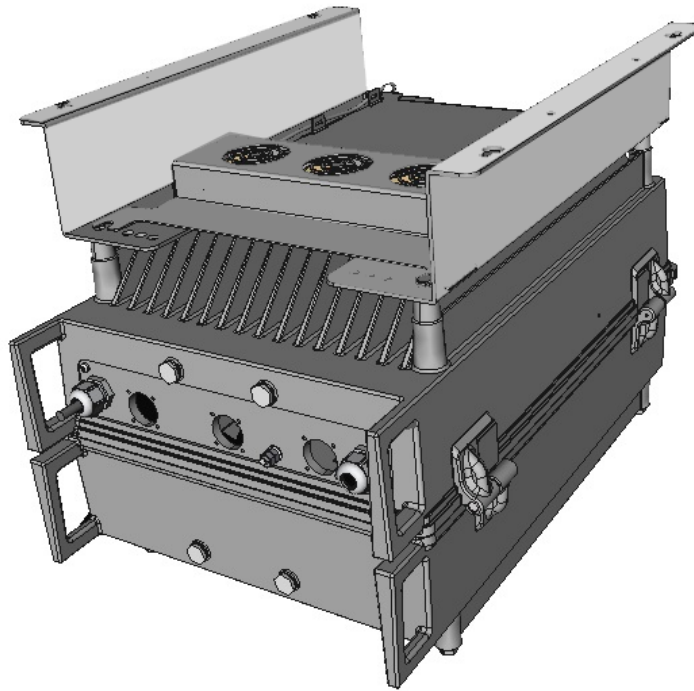

Figure 3-16: Assembled Rear Fan Hood and Mounting Brackets

4. Referring to the MBF-40 User's Manual, prepare the mounting area and hang the repeater on the wall:
- Drill the holes in the wall.
 - Mount the Repeater.

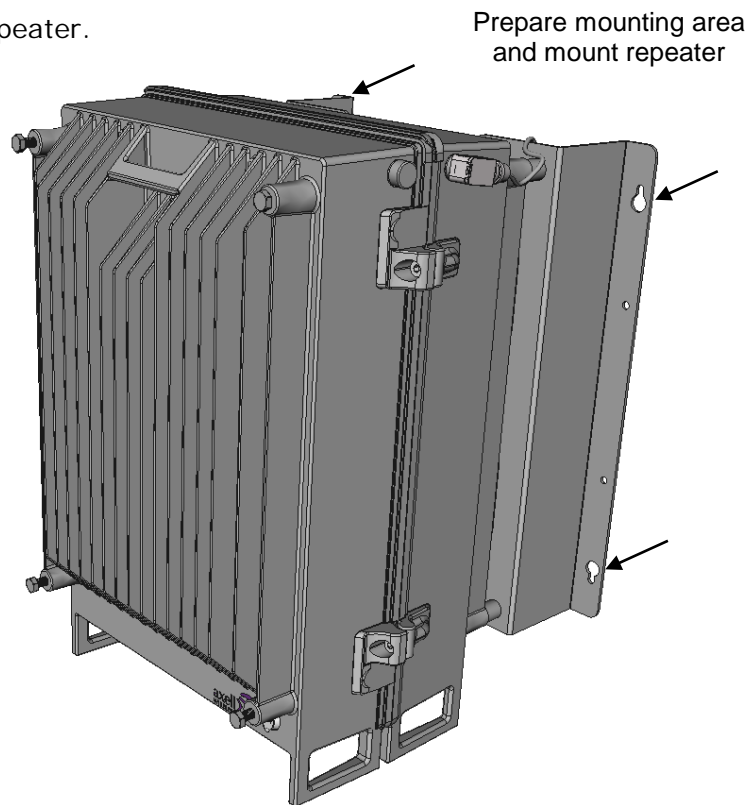

Figure 3-17: Mount the Repeater

5. Assemble Front Hood Fan:

- Loosely insert the x4 M8x12 bolts and washers.
- Hang the Front Fan Hood on the repeater and tighten the bolts.

Hang the Front Fan Hood
on the bolts and tighten

Loosely insert x4
bolts and washers

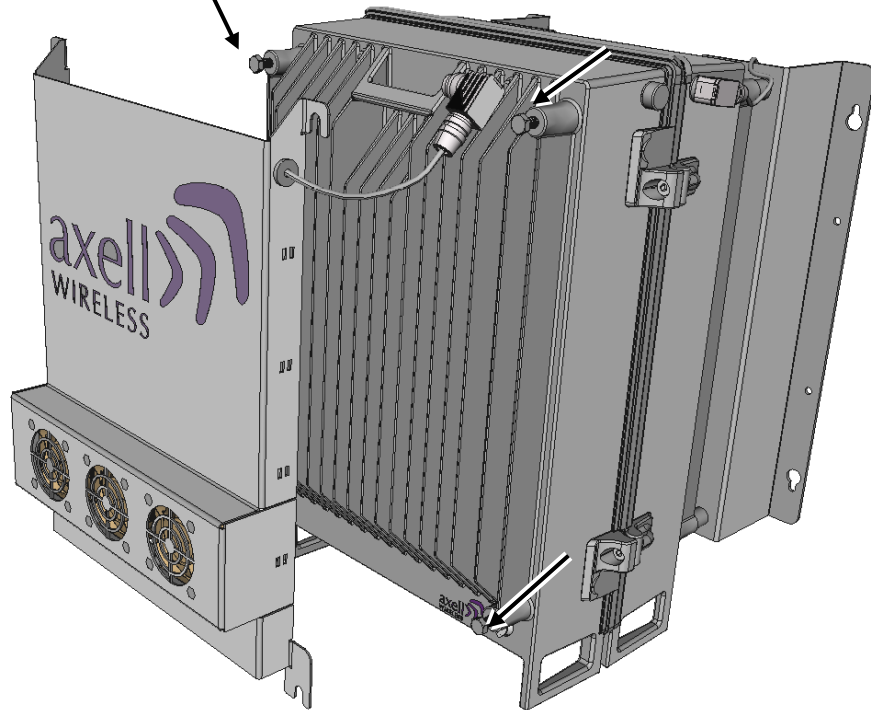

Figure 3-18: Insert the Two M8x12 Bolts

6. Fan Hood power connections:

Connect the Front Fan Hood and the Rear Fan Hood power connectors to the Repeater power connectors.



Figure 19: Slide Front Fan Hood onto MBF

3.4 Five-Band System Installation

NOTE: Both Master MBF-40 and Slave MBF-40 (5-band system) unit models differ from the standard MBF-40 single-clamshell and dual-clamshell models. The installation of the latter models is described in section 3.2

This section describes the installation procedure for a five-band system. The 5-band system consists of two units: Master MBF-40 and Slave MBF-40. All the services are routed to the Master unit via the optic fiber, where the Master and Slave are managed as a single unit via the Master connections.

3.4.1 Required Items for a Master Slave System

In addition to the items provided in the Master/Slave Repeater package, you will require the following cables for interconnecting the Master Slave units:

- 2 high power 50ohm coaxial (jumper) cables with N male connectors on both side
- 1 low loss, high quality 50ohm jumper cable with 7/16 male connectors on both side
- 1 standard straight CAT5 (or above) Ethernet cable with RJ45 connectors on both side

NOTE: The length of the cables depend on the distance that the Master and Slave units are mounted from each other.

3.4.2 Mounting the Master and Slave Units

The Master and Slave units are mounted near each other on the wall.

ATTENTION!!! Recommended distance between the units depends on RF jumper cables used and their loss. **Maximum** distance for low loss cables ~5m

To mount the Master and Slave Units

1. Mark the intended location of the Master and Slave units on your wall.
2. Mount the Master as follows:
 - For Master units provided WITH a Fan Hood assembly kit, mount according to section 3.3.
 - For Master units WITHOUT a Fan Hood assembly kit, mount according to section 3.2.
3. Mount the Slave unit according to section 3.2.

3.4.3 Connecting Master and Slave Units

The following figure provides an example of a five band configuration implemented using a quad-band Master and single-band Slave.

The connections vary depending on whether external alarms are connected. The figure below shows the connections WITHOUT external alarms.

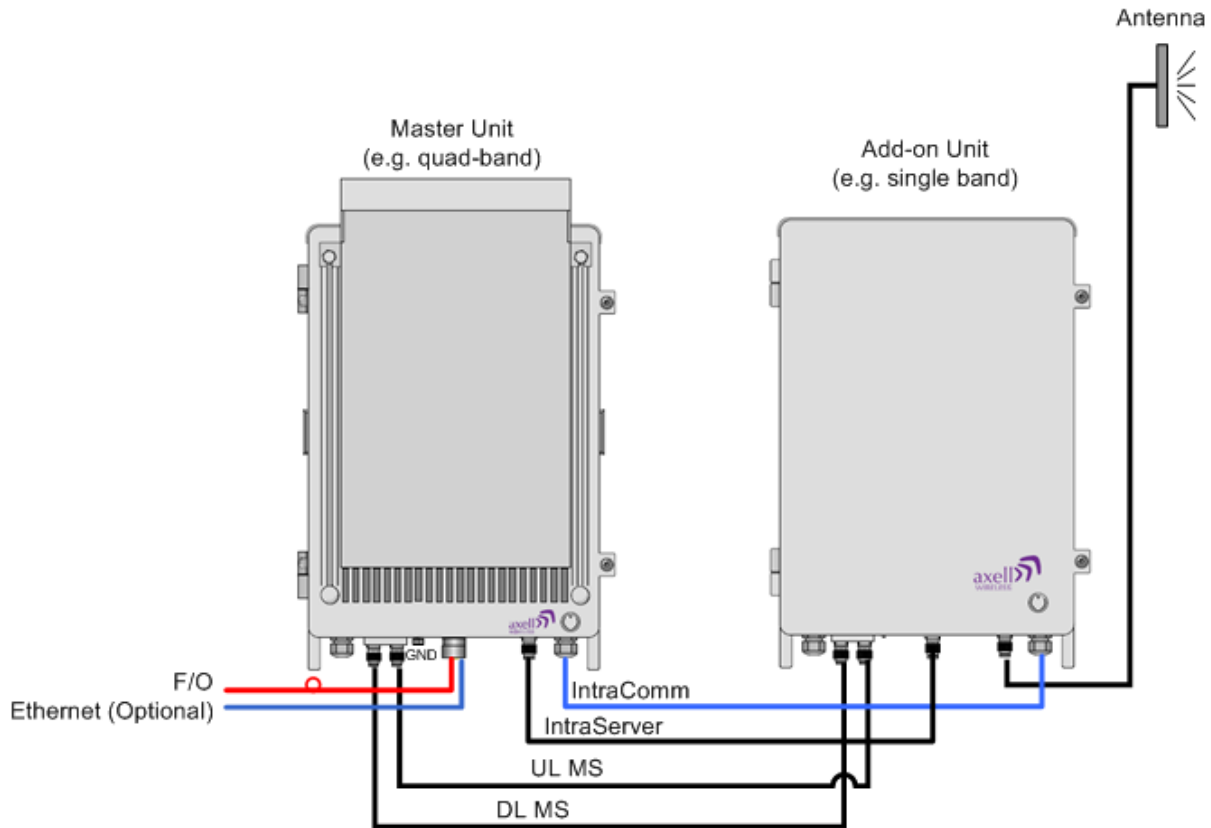

Figure 3-20: Connections WITHOUT External Alarms

To connect the Master and Slave (refer to the previous figure)

1. GND BOTH the Master and Slave units according to section 3.5.
2. Ensure good EMV protection according to section 3.6.
3. Interconnect Master and Slave as follows:
 - 2 high quality 50ohm coaxial (jumper) cables with N male connectors on both side
 - 1 low loss, high quality 50ohm jumper cable with 7/16 male connectors on both side
 - 1 standard straight CAT5 (or above) Ethernet cable with RJ45 connectors on both side

MASTER Port	SLAVE Port	Description	CABLE Type (section 0)
SERVER	LINK INPUT		Jumper cable with 7/16 male connectors
DL MS	DL MS	Downlink intermediate connector Master-Slave	RF Low Power 50ohm coaxial (jumper) cable with N male connectors
UL MS	UL MS	UL intermediate connector Master-Slave	50ohm coaxial (jumper) cable with N male connectors
IntraComm	IntraComm		If NO external alarms are connected: LAN/ CAT5 (If external alarms are connected, refer to section 3.4.4)

4. Route the following cables through the MASTER **DONOR** port and connect internally:

Cable	Condition	Details
Optic Fibre	Always	See section <input type="checkbox"/>
ETH (opt)	If the unit is to be connected to the Ethernet infrastructure	To the Controller ETH port. See section 1.7.3

5. Connect the Server antenna to the SLAVE unit Server antenna port as illustrated.
6. Connect power, power-up, close and secure both units according to sections 3.9, 3.10 and 3.11.

3.4.4 Master/Slave Connections for External Alarms

To connect external alarms, modify the connections to the Master and Slave as follows:

Port location	Connection type and details
Master DONOR port	Route and connect ALARMS according to section 3.8
IntrComm (Master to Slave)	Interconnect RS-485 internal bus of MASTER and of SLAVE according to the following figure.

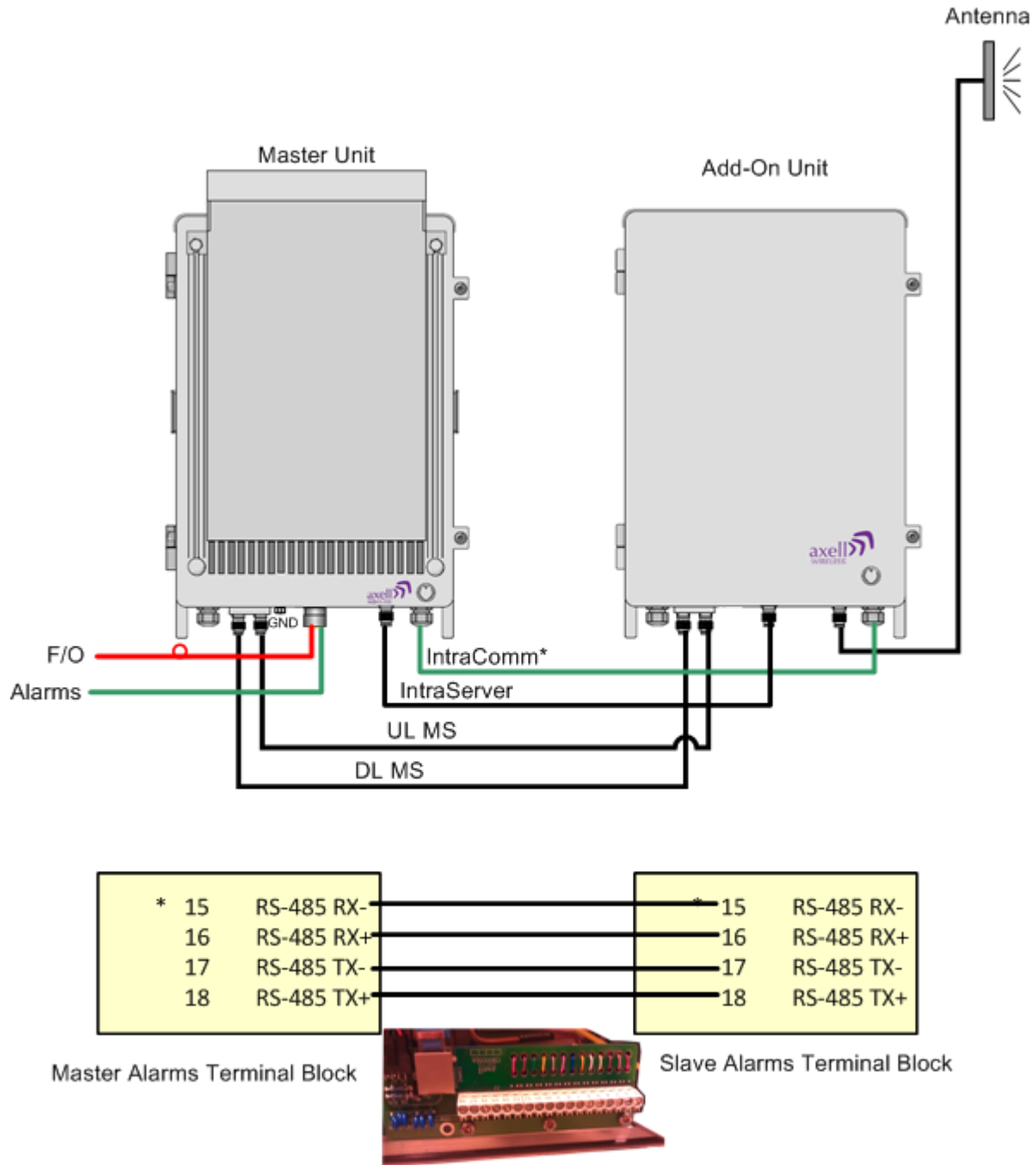

Figure 3-21: Connections WITH External Alarms

3.5 Grounding

Connect the grounding protection as follows:

- Ensure that good grounding protection measures are taken to create a reliable repeater site.
- Make sure to use adequately dimensioned grounding cables. The minimum recommended conductive area for a grounding cable is 16mm²
- Make sure the grounding product used is suitable for the kind and size of cable being used.
- Connect the repeater box bolt to the same ground.

NOTE: For Dual Unit assemblies (five frequency band support), ground **both** units.



Figure 3-22: Grounding the MBF-40

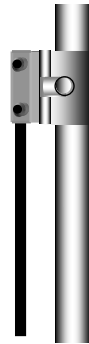

3.6 Ensure Good EMV Protection



CAUTION!!! If insufficient Electromagnetic Protection is provided, or if EMV measures are not taken, warranties issued by Axell Wireless are not valid.

Connect the lightning protection

The lightning hazard to electric and electronic equipment consists in the interferences of direct lightning current infections and high surge voltages induced by the electromagnetic field of nearby lightning channels or down conductors. Amplitudes from cloud-to-earth lightning amounts to several 10kA and may last longer than 2ms. The damage caused depends on the energy involved and on the sensitivity of the electronics systems.

Ensure that lightning protection measures are taken to create a reliable repeater site. Protect all coaxial cables and power cables from the transients caused by lightning. Fit all cables with suitable lightning protection devices.

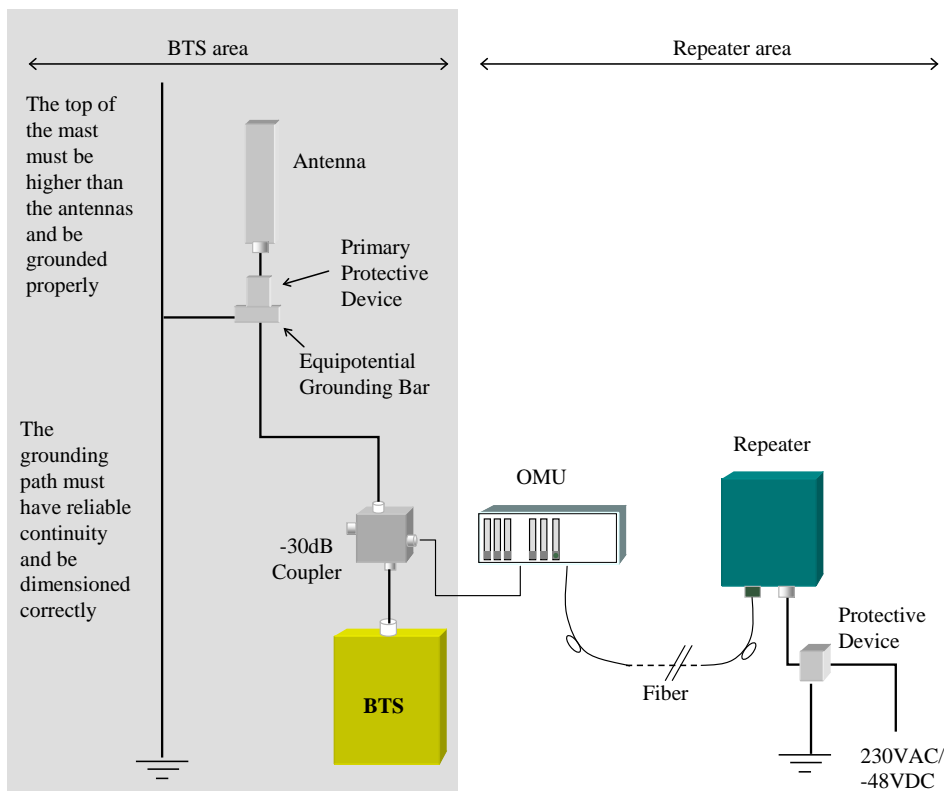

Figure 3-23: Example of EMV protection for a repeater system

For detailed information please refer to IEC 61024-1 and 61312-1 for international standards for protection of information systems against LEMP (Lightning Electromagnetic Pulse), including radio transmitters. They define proper planning, installation and inspection of effective lightning protection systems.

The Axell Wireless repeaters comply with the EN standard ETS 301 498-8 which stipulates demands on lightning/surge protection for typical infrastructure telecom equipment installations.

Several lightning protection devices should be used in series with declining threshold voltages to help attenuate the pulse component which makes it through the first layer of protection.

The primary protective device is part of the site installation and is not supplied by Axell Wireless. Coaxial lightning protection is normally one of these three types: Gas capsule, High-pass and Bandpass.

There also need to be a protective device installed on the power supply cord.



Figure 3-24: Protective device installed in connection with the power supply

3.7 Fiber Optic Connection



WARNING!! Maximum input power should not exceed (zero) 0 dBm

NOTE: Clean the Fiber connectors (receptacles and cables) before connecting. See Appendix C – F/O Cleaning Procedure for details on F/O cleaning procedures.

Class 1 Laser

This product is equipped with class 1 lasers, as per definition in EN 60825-1.



Caution!!!

Un-terminated optical receptacles may emit laser radiation.

Do not stare into beam or view with optical instruments.

Use the following over the complete link between the Repeater and OMU:

- Use angled APC connectors at 8deg angle
- APC type ODF connections

Connecting the Fiber Optic Cable

NOTE: The procedure below includes F/O connection instructions for both single sector and for MIMO topologies.

1. Select type of optic Fiber (Recommended Fiber cable is single mode 9/125).

2. Run the Fiber through a corrugated sleeve (not supplied). For MIMO models, route both Fibers through the same sleeve.



Figure 3-25: Run Optic Fibers through Sleeve

3. Insert the optic Fiber hose fitter (may be pre-assembled) and route the Fiber cable(s) via the Fiber input (see front panel interfaces in section 1.7.2).

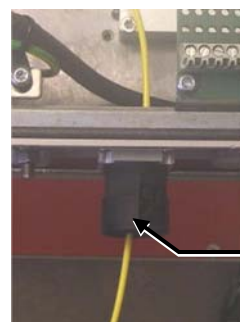

Fiber hose fitter

Figure 3-26: Route Optic Fiber(s) via the Fiber Input

4. Connect the Fiber(s) to the Fiber Optic Converter(s) inside the repeater:
 - Single sector MBF-40 – one optic converter is installed in the repeater.
 - MIMO MBF-40 – two optic converters are installed in the repeater (connect both).

NOTE: Make sure the Fiber is not bent too sharply inside the repeater as to avoid communication disruptions.

Single F/O Connector

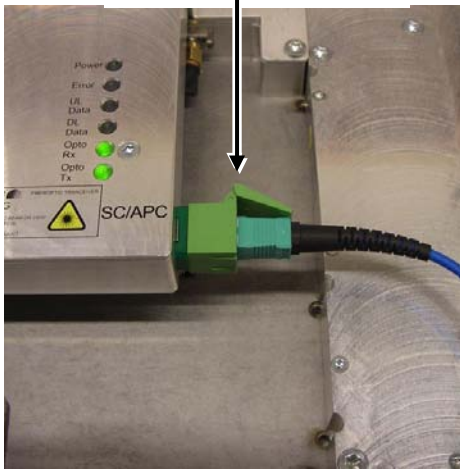

Figure 3-27: Single F/O Connection

Dual F/O Connectors

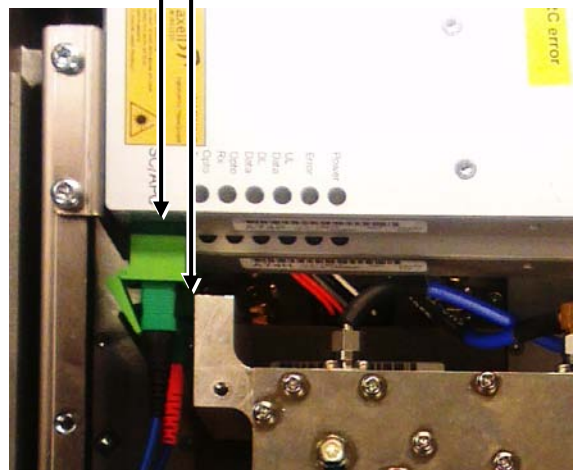

Figure 3-28: MIMO Dual F/O Connection

5. Place the Fiber(s) in the rubber seal (for MIMO, run both Fibers in the same rubber seal).



Figure 3-29: Run Fiber in the Rubber Seal (for MIMO, Run Both Fibers in the Same Rubber Seal)

NOTE: The sleeve (not supplied), together with the rubber seal, meets the protection standard IP65/NEMA4.

6. Adjust the Fiber(s) length inside the repeater and insert the seal into the Fiber inlet.



Figure 3-30: Adjust F/O Length

7. Attach the sleeve to the Fiber optic inlet. *This completes the procedure.*

Note: Clean the Fiber connector before connecting it to the system. See instruction in Appendix C – F/O Cleaning Procedure.



Figure 3-31: Connect Sleeve

3.8 External Alarm and Relay Connections

The repeater is equipped with an external alarm interface card. The connector plinth for the external alarms is located at the bottom of the repeater.

The strain relief fitting in is a Pg 13.5 suitable for a 6-12 mm cable diameter.

Connect the alarm cords to the plinth according to the pin layout below (in the standard version pins 14 – 18 are not used).

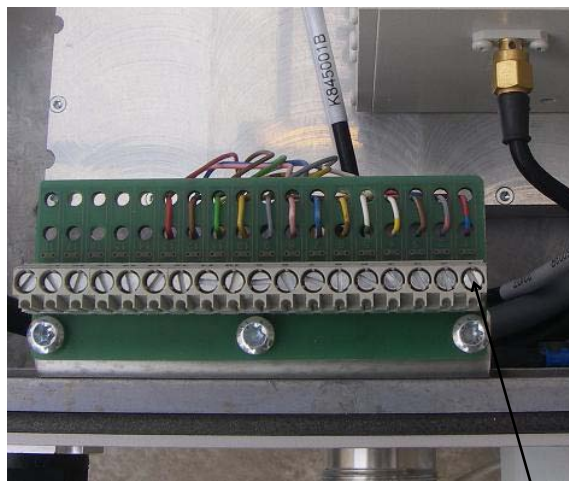

Pin 1

Pin #	Signal
1	External alarm 1A
2	External alarm 1B
3	External alarm 2A
4	External alarm 2B
5	External alarm 3A
6	External alarm 3B
7	External alarm 4A
8	External alarm 4B
9	Alarm +15V
10	Alarm 0V
11	Relay Output 1A
12	Relay Output 1B
13	GND
14	NC
15	NC
16	NC
17	NC
18	NC

Figure 3-32: External Alarm and Relay Pinout

3.8.1 External Alarm

- Four external alarm sources can be connected to the repeater.
- Alarm operating voltage: between 12 and 24VDC.
- Alarm polarity can be configured:
 - Active-low - when there is no voltage the alarm indicator will turn red
 - Active-high - an applied voltage of between 12 and 24 V will cause the external alarm indicator to turn red.
- The repeater can supply +15 VDC to an external alarm source through pin 9 and 10. The maximum allowed load is 100mA.

3.8.2 Relay

- Relay (pin 11 and 12) can be connected to an external device to indicate an alarm.
- Can be configured to trigger on any number of internal and external alarms. The maximum current that can be supplied is 100mA.

3.9 Power and Backup Battery

CAUTION!!



- Make sure the antenna cables or 50 ohm terminations are connected to the repeater's antenna connectors before the repeater is turned on.
- Be sure a CIRCUIT BREAKER meeting the instructions given in this section is connected near the unit at an easily reachable and accessible location from the unit.

The image below shows the location of the various power elements. These are described in detail in the following sections.

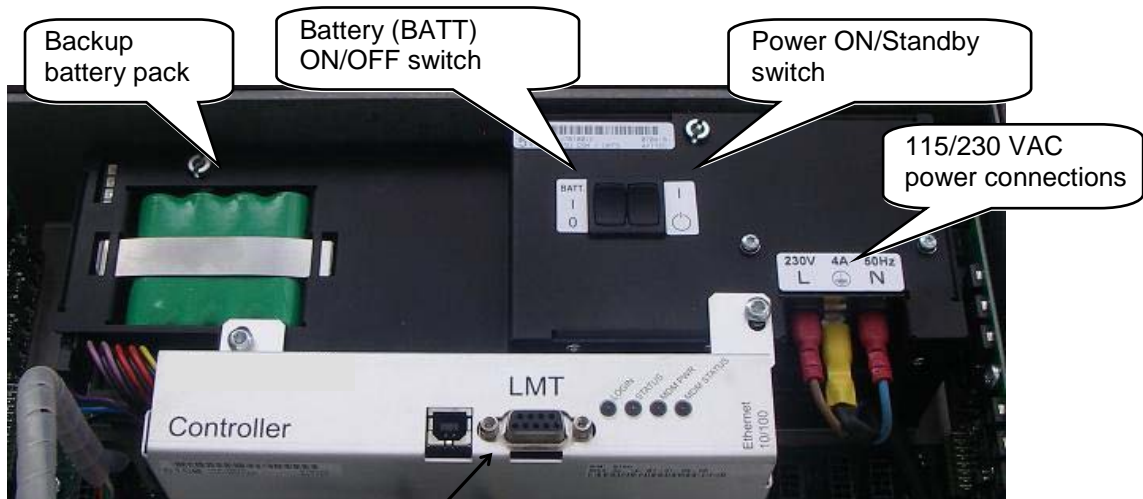

Figure 3-33: Power Elements Inside Repeater

3.9.1 Dual Power Supply Models

In dual power supply models, the two power supplies are installed and both are active at all times. The power supplies are interconnected internally; therefore, a single power connection activates them both.

The required power wiring and circuit breaker does not differ from the single power supply models.

3.9.2 Circuit Breaker

The power connections to the unit are hard-wired. To disconnect the unit (either manually or automatically in case of overcurrent), it is required to install a circuit breaker *on the wall near the unit*, at an easily accessible distance and location from the unit.

Circuit-breaker minimum requirements

- 10A, 250VAC
- Needs to be SAFETY approved
- Requires minimum contact separation of 3mm.
- Install on the wall near the unit

3.9.3 Connecting the Power Source

- Power Source: 115 VAC 60 Hz or -48 VDC
- The -48VDC version of the power supply is designed to turn off if the supply voltage falls below -36V ($\pm 1V$). It will turn on again as the supply voltage reaches -43V ($\pm 1V$).
- The power supply has a switch which allows it to be set in “on” position or in “stand by”.

NOTES the following:

- In the stand by position the repeater is still connected to the power supply but not operational.
- On repeaters mounted in an extended box with two power supplies, both power supplies needs to be switched on.

3.9.4 115 VAC Power Source

Cable requirements:

- Cable should be NRTL (safety) approved with a minimum of 14AWG or 2.5mm² per conductor, and maximum of 12AWG or 4mm² per conductor.
- For safety, the GND cable must be **10mm longer** than the Phase and Neutral cables.

Connect the power cable to the plinth as show below:

- **Phase** linked to the **Black** cable
- **Neutral** linked to the **White**
- **Ground** to the **Green** where for SAFETY, the GND cable must be **10mm longer** than the Phase and Neutral cables.



Figure 3-34: 115VAC Power Connections

3.9.5 -48V Power Source Connection

Note: The -48VDC version of the power supply is designed to turn off if the supply voltage falls below -36V ($\pm 1V$), not to drain the feeding battery. It will turn on again as the supply voltage reaches -43V ($\pm 1V$).

-48V power supply requirements

The 48VDC power supply must comply with SELV requirements, as defined in EN60950, which implies double isolation. The output power needs to be 48VDC +25%/-15%. The maximum input current is 8A.

Connect the power cable to the plinth as show below:

- **Phase** linked to the **Brown** cable
- **Neutral** linked to the **Blue**
- **Ground** to the **Green and Yellow**. See illustration below.



Figure 3-35: -48VDC Power Connections

Recommended cable areas for 48VDC

Distance	Cable Area
0 - 10 meters between repeater and power supply	2,5 mm ²
10 – 50 meters between repeater and power supply	4 mm ²
Over 50 meters between repeater and power supply	Recommendation is to reconfigure the installation, or to make special arrangements to increase cable area

3.9.6 Backup Battery

- On the Power Supply unit a rechargeable battery pack is mounted. This part also includes charging and supervision electronics.
- The backup battery will provide the Control Module with enough capacity to send an alarm in case of input power failure.
- The battery can be switched on and off. The switch is placed adjacent to the main power switch on the power supply.
- At delivery the back-up battery is connected.
- The battery is replaced by lifting the battery pack out of the crate and disconnecting the cable.

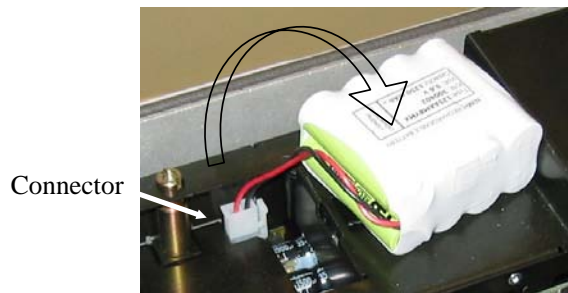

Figure 3-36: Backup Battery

3.10 Power ON

3.10.1 Switching Power ON



CAUTION!! Make sure the antenna cables or 50 ohm terminations are connected to the repeater's antenna connectors before the repeater is turned on.

To switch power on

1. Switch on the **Main Power Switch**.
2. Switch on the **Secondary Power Supply** (model dependent).
3. Switch on the **Battery** power.

Note: **Both** power supplies must be switched ON to power up the unit.

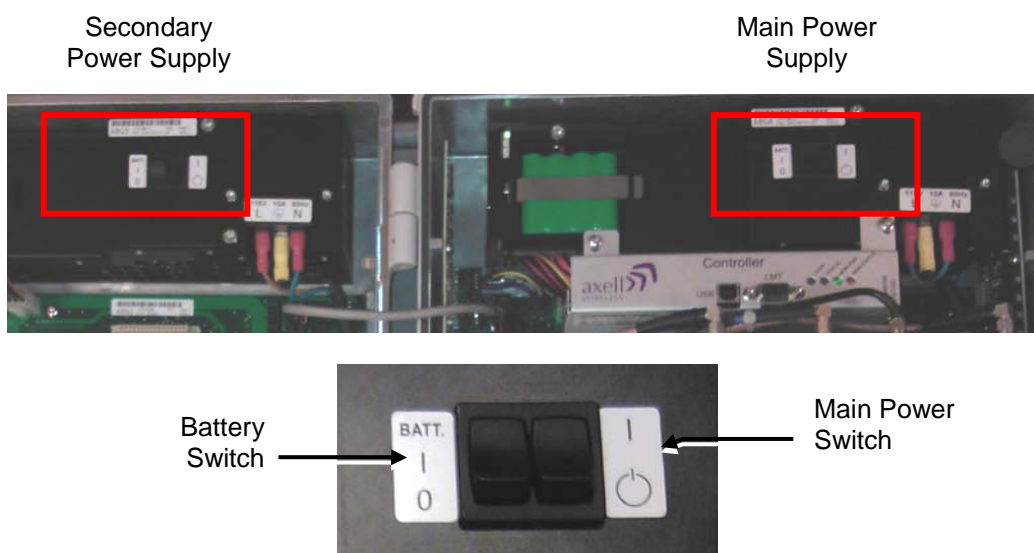

Figure 3-37: MBF-40 Power Module

NOTE: The power switches have two positions: "on" and "stand by". In the stand by position the repeater is still connected to the power supply but not operational.

3.10.2 Verifying LEDs

Verify the LEDs from the following modules are indicating correct operation (see section 7.3):

- Control module
- F/O converter(s)
- Power supply module(s)

3.11 Closing and Securing the Repeater

Close lid, **tighten the screws** and lock repeater. Continue with the following section to setup the repeater.

NOTE: The two screws must be fully tightened. Failure to do so may affect the IP65 compliancy and therefore any warranty.

4 Opening a Session and Navigating GUI

4.1 Opening a Direct Web Session

4.1.1 Connecting Locally

NOTE: This connection requires downloading the USB driver from the provided setup disk (or connection to the internet, where the driver is automatically loaded).

To open a local session:

1. Open the MBF-40 cover
 - Connect to the USB port on the Controller module. If the USB driver is not already installed on your laptop, the system will search for the driver on the provided setup disk or on the internet (if a network connection is available).
 - Run a browser and login according to the following section.



Figure 4-1: MBF-40 Controller Module Connection

1. Open the web browser and type "axell-ne" in the address bar.



The Axell login dialog appears.



Figure 4-2: Login Screen

2. Use the following username and password to login:
 - Username: **axell**
 - Password: AxellPasswd

Note: It is highly recommended to change the default password according to section 6.4.3.

The Web GUI Main Window appears. This is the same window is also viewed via the OMU II.

4.1.2 Remote Connection and Login

This type of Web session requires connecting the Repeater to the network.

4.2 Open a Session to the MBF-40 via the OMU II

1. Open a local or remote session to the host OMU II:
 - Remote session – open a Browser session in the same subnet as the host OMU II and enter the IP of the host OMU II (see OMU user manual for detailed procedure). Enter the OMU II User Name (e.g. **axell**) and Password (provided by your system administrator).
 - Local session– connect to the OMU II Control Module's USB or Ethernet ports. Enter the OMU II User Name (e.g. **axell**) and Password (provided by your system administrator).
 - After accessing an OMU II session, commission the MBF-40 according to the following section.



Figure 4-3: Connection to OMU II

4.3 Navigating the Web Interface

The Web GUI window provides access to the management options of the MBF-40. Several tabs (and sub-tabs) are available: Home, Nodes, Logs, etc., while the Home tab (illustrated below), is displayed on login.

NOTE: for 5-Band MBF-40 home screen, see Figure 4-5.

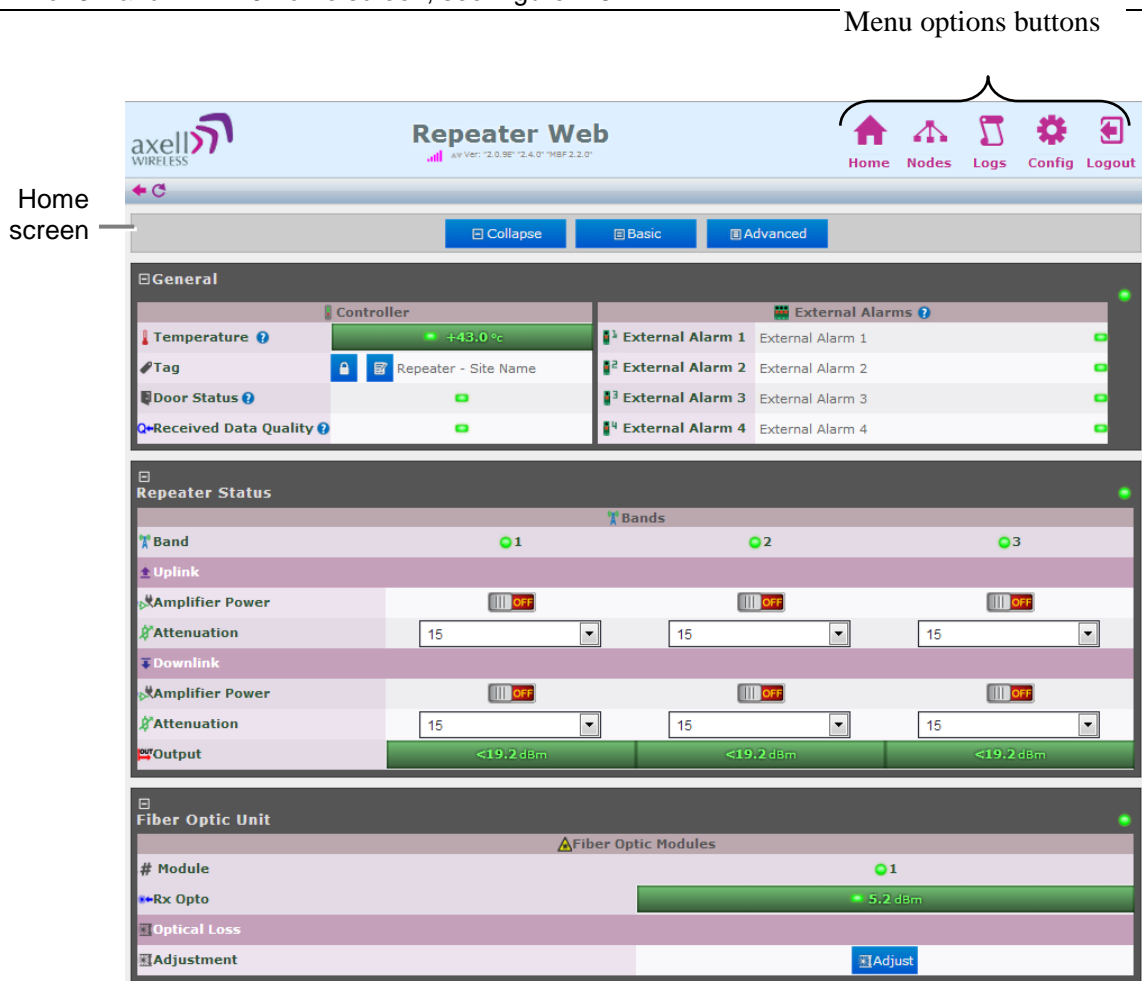
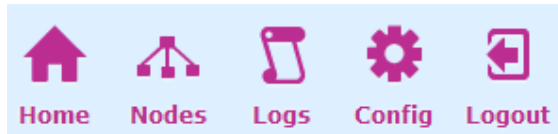







Figure 4-4: MBF-40 Home Screen

4.3.1 Management Options Buttons

The following table briefly describes the main functions of each tab:



Tab	Description
 Home	Provides a general status and alarm information. Switching to <i>Advanced View</i> will toggle a more detailed view of each band and module. Section 4.3.2.
 Nodes	Lists the remote nodes – corresponding OMU and units connected the specific OMU.
 Logs	List of recent operations. Section 7.2.
 Config	Provides a range of MBF-40 configuration procedures such as communication, RF, Date and Time, Password, etc. Section 6.1.
 Logout	Logout of the system.

4.3.2 Home Screen Overview

The screen is divided into four basic areas:

- Controller – shows general information on the MBF-40 device such as identification and temperature level.
- External Alarms – shows status of external alarms and the defined names.
- Repeater Status – RF connection status is divided into two sections:
 - Band – shows general band status and band name (e.g. 800MHz GSM).
 - Uplink/Downlink – gain, attenuation and connection status in the specific direction.
- Fiber Optic Unit – shows status on connection to remote OMU and allows for optical link adjustment.
- Sub-systems – overall status of all sub-systems such as power supplies, battery, communication etc.

The screenshot shows the 'Repeater Web' interface with the following sections and annotations:

- General:** Includes 'Controller' (Temperature: +42.0 °C, Tag: Repeater - Site Name) and 'External Alarms' (External Alarm 1-4).
- External Alarms:** A list of four external alarms, each with a status indicator.
- UL and DL output control options:** 'Repeater Status' section showing 'Bands' (1, 2, 3) and 'Uplink/Downlink' settings for Amplifier Power (OFF) and Attenuation (15).
- Fiber Optic options:** 'Fiber Optic Unit' section showing 'Fiber Optic Modules' (Module 1, Rx Opto: 5.2 dBm) and an 'Adjust' button.
- Power monitoring options:** 'Subsystems' section showing 'Master Power Supply', 'Slave Power Supply', and 'Ref. Gen.' with various status icons.

4.3.3 Configuration Screen Overview

The configuration screen provides access to the MBF-40 configuration options.

To access the configuration screen

Click on the **Config** menu option in the Main window. The following screen appears.



Option	Description
Site Information	Configure and display MBF-40 identification information. See section 6.1.1
External Alarms	Used to activate and assign names to external alarms. See section 6.1.3
Change password	Used to update system login password for the logged-in user. See section 6.4.3
Date and Time	Used to configure the time stamp for dating MBF-40 events. See section 6.1.2.
Ethernet	Used to define the IP Address for remote access via Ethernet. See section 6.1.4
Remote Communication	Used to configure remote communication parameters and AEM integration. See section 6.2
Axell Shell	Command line used to communicate with the remote units. List of commands is found under Help. See section 6.6
Attribute Reference	CLI commands and attributes directory. See section 6.7
Reboot controller	Soft restarts the MBF-40 device. See section 6.5.
SNMP Agent	SNMP Agent configuration. See section 6.3

4.3.4 Five Service System GUI

The five service system GUI has no significant differences with other GUIs. It is displayed as one 5-band unit with same configurations and options.

The Home screen displays all the 5 bands in a time (same as in a tri-band/quad-band), as shown in Figure 4-5.

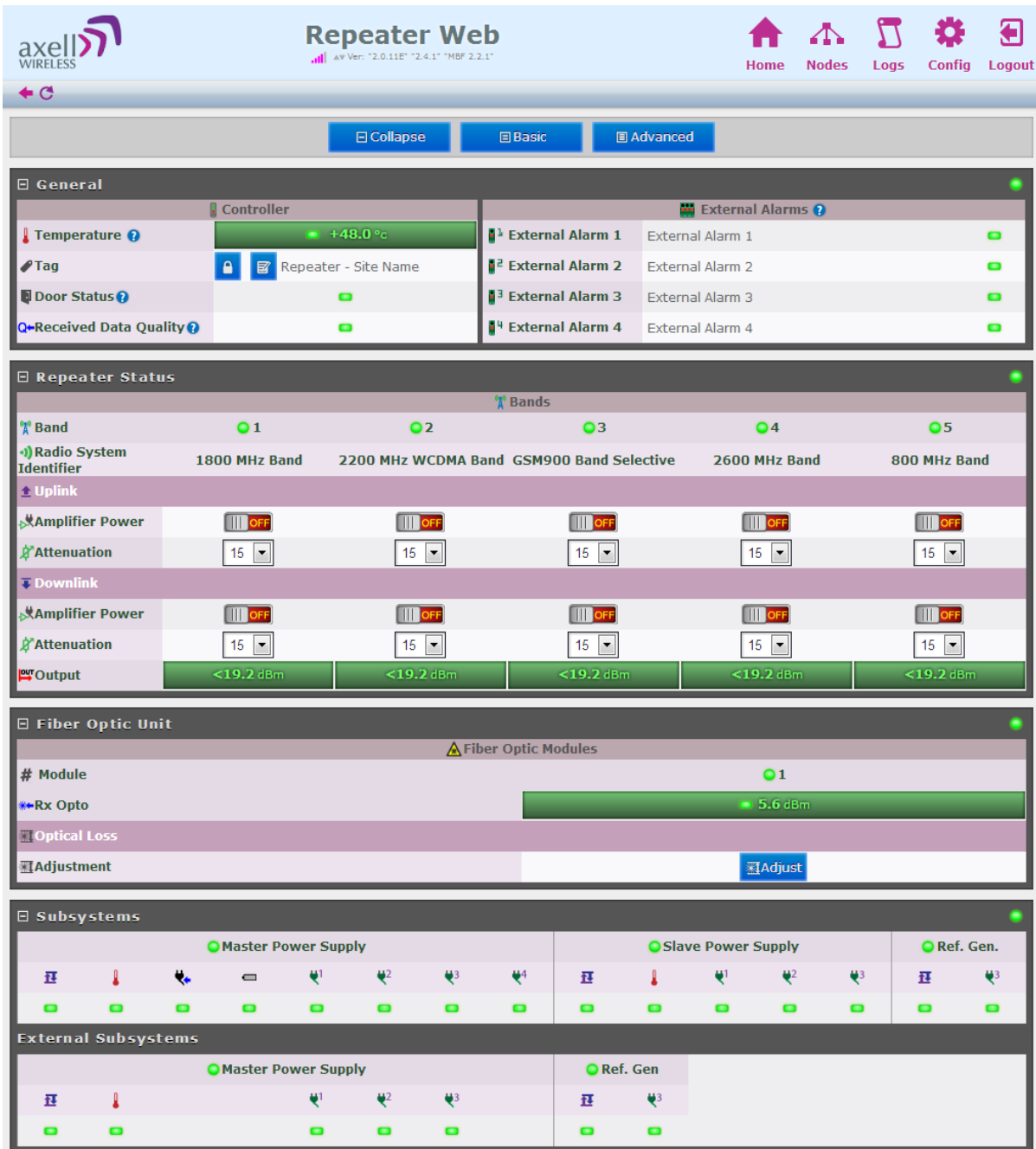

Figure 4-5: 5-Band MBF-40 Home Screen



The screenshot shows the 'Repeater Web' interface. At the top, there is a navigation bar with the Axell Wireless logo, the title 'Repeater Web', and a status bar showing 'Av Ver: *2.0.11E* *2.4.1* *MBF 2.2.1*'. To the right of the navigation bar are icons for Home, Nodes, Logs, Config, and Logout. Below the navigation bar, there are two main sections: 'Control Module' and 'Site Information'. Each section contains a table of key-value pairs. At the bottom of the interface is a 'Reload' button.

Control Module	
Serial Number	BX3P
Hardware Version	H481003K
Target Version	MBF 2.2.1
Common Version	2.4.1
System Version	2.0.11E
Boot Version	AviBoot 2.0.0

Site Information	
Model	MBF40-3718-4321-4009-4326-4008-S
Serial Number	C5T7
Article Number	MBF4018A
TAG	Repeater - Site Name
ID	00-00-C5T7

[Reload](#)

Figure 4-6: 5-Band MBF-40 Site Information

5 MBF-40 Commissioning

After the repeater is connected, it is identified by the OMU II via the Fiber connection and the unit is commissioned from the OMU II. The commissioning process consists of a few simple steps.

MBF-40 Setup and Commissioning consists of the following

1. Opening an **OMU II session** – for accessing the MBF-40 configuration window (via OMU II)
2. Performing **Optical Loss Adjustment** on the connected MBF-40
3. Setting the required **RF attenuation and gain levels** on the remote MBF-40
4. Assigning the unit a **recognizable name** (according to its location)

5.1 MBF-40 Optical Loss Adjustment (OLA)

MBF-40 OLA is performed from the OMU II.

For MBF-40 remotes, the maximum compensation is increased to 26dB to support shorter Fiber optic distances.

To perform MBF-40 OLA (via OMU II)

1. From the OMU II main window, click the **Opto Adjust** button.

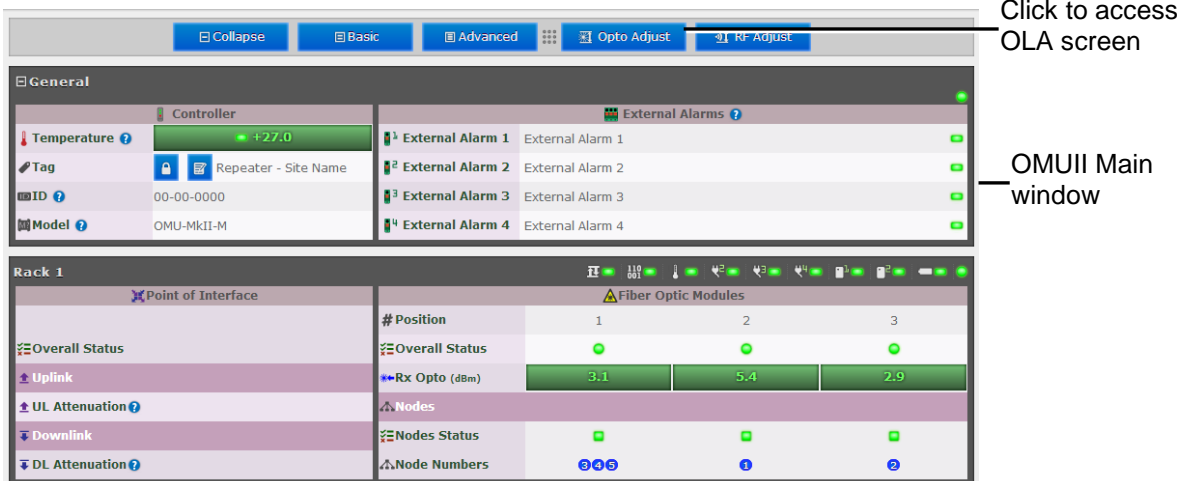

Figure 5-1: OMU II Main window

The OLA screen appears. The screen lists the OLA options (and status) for each link. (The links are listed according to the OMU II slot to which the remote is connected.).

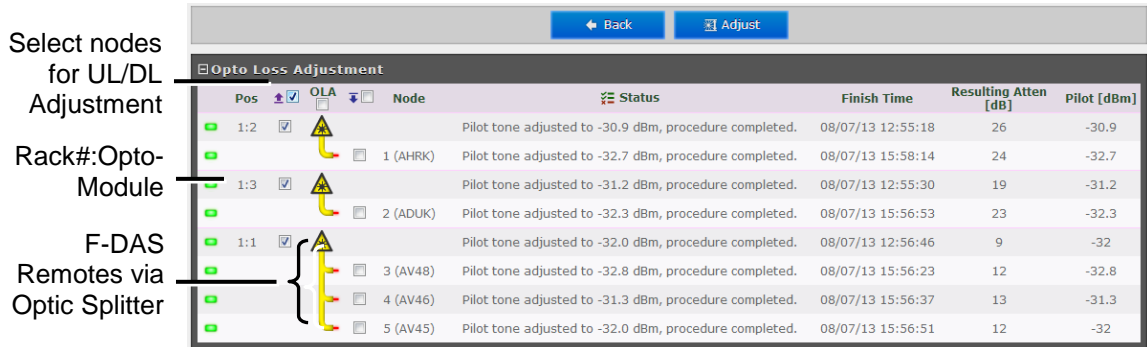

Figure 5-2. Configure and Initiate Optical Loss Adjustment

Column	Description
Pos	Each Rack corresponds to an OMU unit whereas each Slot corresponds to an Opto-Module. Slots are numbered according to their position in the OMU Chassis (numbered left to right).
Select All	Batch selection options: <input type="checkbox"/> - mark all remotes for UL opto-adjustment. <input type="checkbox"/> - mark all remotes for DL opto-adjustment. <input checked="" type="checkbox"/> OLA - mark all remotes for DL and UL adjustment.
Node	Node list number and identification (e.g. AHRK)
Status	Displays an Error if process failed. If successful the pilot tone used and the adjustment level will be displayed.
Resulting Attenuation	Compensation level used for the opto-module (in dB).

3. Mark the check-boxes corresponding to the remotes (each connected to the designated Opto-module/Opto-Splitter) to which to perform the adjustment.
4. OLA (DL/UL) may be performed on each node individually (or a batch) or on **all** nodes at once by marking the checkbox next to the desired corresponding Opto-module and clicking **Adjust**.

To easily mark all checkboxes mark the checkbox named **OLA**.

NOTE: The process may take several minutes depending on the size of the system and remote distance.

5.2 RF Balancing

The MBF-40 RF Balancing procedure can be performed manually (the automatic option specified in section 5.2.2 will be available in the future) via the OMU II web interface.

5.2.1 Manual RF Balancing

NOTE: If connected locally, enter the MBF-40 Home screen and skip to step 2.

The manual balancing procedure consists of the following steps:

- Verifying the DL RF output level is maximized by setting the required DL attenuation of the signal.
- Setting the UL attenuation according to the DL.
- In case of noise, adjusting the UL attenuation to reduce noise

To balance the MBF-40 UL and DL outputs

1. Access the MBF-40 Configuration window:
 - Click on the **Nodes** button. The below pane appears
 - Click **Control** next to the node to be balanced.

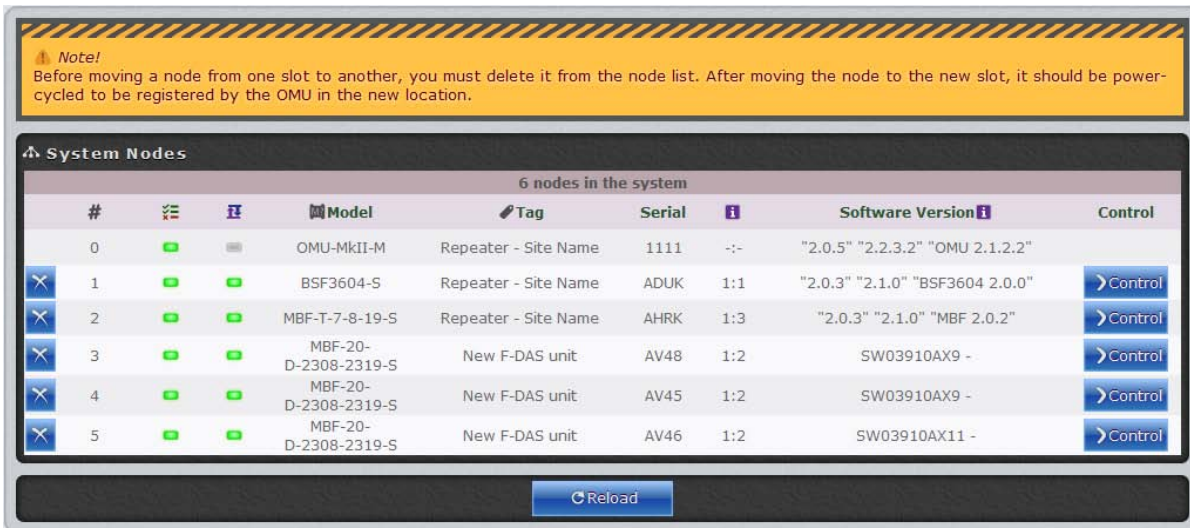

2. The resulting pane can be displayed in two views:
 - Basic – default view (**Basic** button)
 - Advanced – provides more information (**Advanced** button)

The dialog below shows an example of the Basic (default) view.



Figure 5-3: Example of MBF-40 Tri-Band Configuration window

3. In the Downlink:

- Verify the **Amplifier** for each band is ON.
- Set **Attenuation** to maximum value (15dB).
- Lower the **Attenuation** level step by step until the desired Output power level is reached (Zero attenuation = maximum gain).
- Verify the Amplifier Saturation is GREEN.



4. In the Uplink:

- Verify the **Amplifier** for each band is ON.
- Set **Attenuation** equal to the value set in the DL (above).
- Verify the Amplifier Saturation is GREEN.

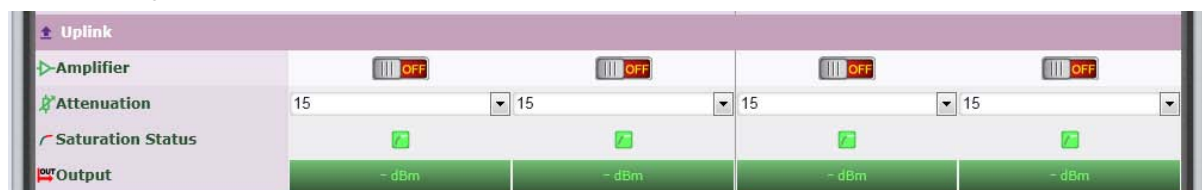

NOTE: If noise is detected on the link, reduce only the Uplink for optimal signal.

5.2.2 Automatic MBF-40 RF Balancing

NOTE: This feature will be available in future release.

To access the Automatic RF Adjustment pane

1. Access the OMU II **Home** window and click on **RF Adjustment**.

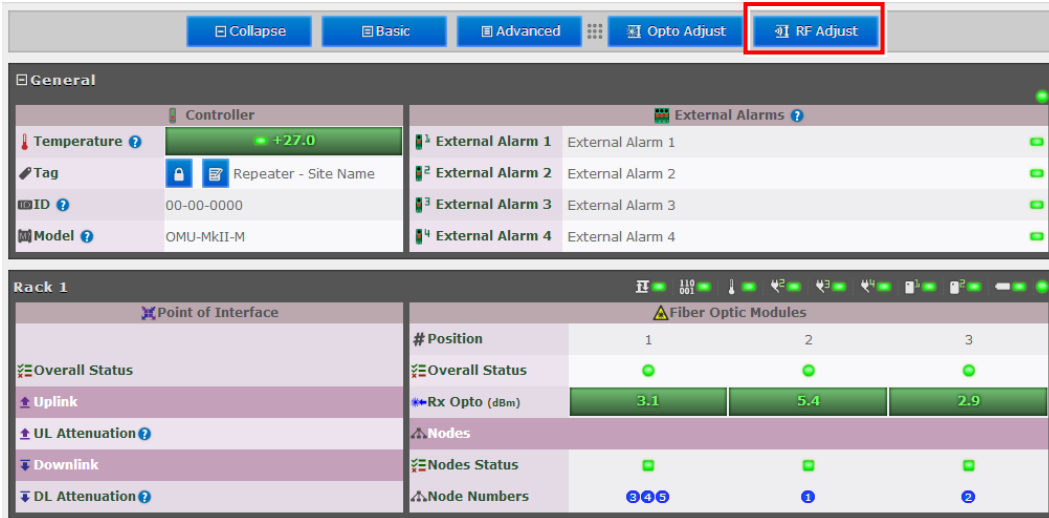

Figure 5-4: OMU II Main window

2. The following pane appears.

Select All Select None Adjust

Note:
 The automatic RF Adjustment procedure will adjust the output in the downlink path for each chain to the nominal level and then set uplink gain according to the Delta configuration. For this to work, there must be a downlink signal enabled in the downlink from the base station allowing to reach the desired output power level. Before performing RF Adjustments it is strongly recommended to adjust corresponding opto links in the opto adjustment page.

Node #3, AV48, MBF-20-D-2308-2319-S, New F-DAS unit, 1:1							
?	Freq [MHz]	Nominal Level [dBm]	Uplink Delta [dB]	Status	Finish Time	Resulting Atten [dB]	Output Level [dBm]
<input type="checkbox"/>	850	0	5	MBF-20 RF Adjustments failed. Cannot read OPL, Verify you have input power.	08/07/13 14:43:40	3	-
<input checked="" type="checkbox"/>	1900	0	5	MBF-20 RF Adjustments failed. Cannot read OPL, Verify you have input power.	08/07/13 14:43:29	3	-

Node #4, AV46, MBF-20-D-2308-2319-S, New F-DAS unit, 1:1							
?	Freq [MHz]	Nominal Level [dBm]	Uplink Delta [dB]	Status	Finish Time	Resulting Atten [dB]	Output Level [dBm]
<input checked="" type="checkbox"/>	850	0	5	MBF-20 RF Adjustments failed. Cannot read OPL, Verify you have input power.	08/07/13 14:43:23	3	-
<input type="checkbox"/>	1900	0	5	MBF-20 RF Adjustments failed. Cannot read OPL, Verify you have input power.	08/07/13 14:43:17	3	-

Node #5, AV45, MBF-20-D-2308-2319-S, New F-DAS unit, 1:1							
?	Freq [MHz]	Nominal Level [dBm]	Uplink Delta [dB]	Status	Finish Time	Resulting Atten [dB]	Output Level [dBm]
<input checked="" type="checkbox"/>	850	0	5	MBF-20 RF Adjustments failed. Cannot read OPL, Verify you have input power.	08/07/13 14:43:11	3	-
<input checked="" type="checkbox"/>	1900	0	5	MBF-20 RF Adjustments failed. Cannot read OPL, Verify you have input power.	08/07/13 14:43:05	3	-

Remote with selected bands to adjust

3. Select the bands of each remote to be adjusted (e.g. 1900MHz band on Node #3)
4. Adjust the following for each band:
 - Nominal Level (dBm)
 - Uplink Delta (dB)
5. Click **Adjust**. The procedure may take several minutes depending on the number of units selected.

5.3 Integration into the AEM

NOTE: Integration into the AEM is only performed from the AEM side – no action is required from the MBF-40 side.

The AEM automatically connects to the repeater, downloads all the repeater parameters and statuses into a database. When all parameters have been downloaded, the AEM configures the repeater with the IP address where alarms and reports should be sent to, and optionally with a secondary IP address where the repeater can connect to in case connection to primary IP fails.

When heartbeat reports and alarms are sent from the repeater to the AEM also the latest information about the status and RF-configuration is included. This means that the AEM operator always has information about the current status in the AEM database (and does not need to call the repeater to find this out).

NOTE: Once the repeater is integrated to the AEM, all changes to the repeater should preferably be done from the Axell Element Manager in order to ensure that the database always contains correct information.

5.4 What Next?

The MBF-40 unit is now ready for operation. You may monitor the unit's general status via the OMU II Main window and if the node is faulty (red LED), access the dedicated configuration screen in Basic or Advanced view for more information.

NOTE: Consult the OMU II User Manual for additional information on RF and Optical adjustments.

6 MBF-40 Full GUI Description

This chapter provides a detailed description of the complete MBF-40 specific Web GUI accessible when opening a *direct* session to the MBF-40.

When an *indirect session* (via OMU II) is opened to the MBF-40, only the MBF-40 Main window is available. Additional options are available when a *direct* session is opened to the MBF-40 (*not* via OMU II).

This chapter describes how to open local and remote indirect sessions to the Remote and the available options when such a session is opened.

6.1 Configuring General Parameters

6.1.1 Site Information – MBF-40 Identification



It is recommended to assign each MBF-40 a recognizable name that will identify the location, site name, etc. The Site Information button provides access to MBF-40 hardware and software version information.

To set MBF-40 TAG

1. In the **Home** window, click the edit button next to Tag.

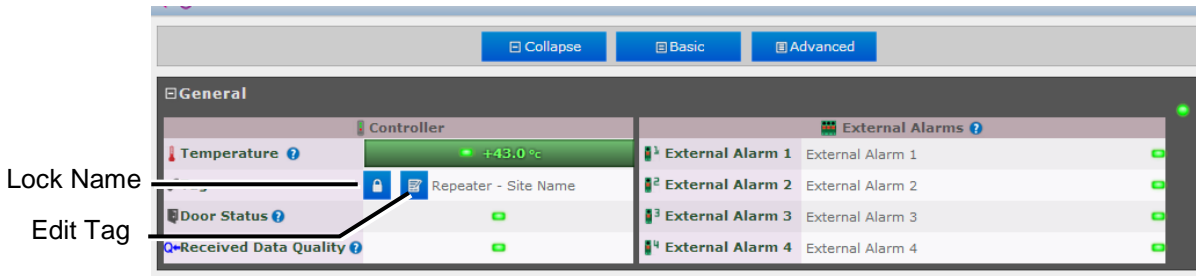

Figure 6-1. Set MBF-40 TAG Name

2. Enter the Name (up to 30 characters), click OK and click **Apply**.

To view MBF-40 Site Information

Click the **Config** button and click on the **Site Information** icon. Two areas are displayed:

- Control Module – provides hardware and software version information.
- Site Information – provides MBF-40 identification information.

NOTE: for 5-band MBF-40 Site Information, see Figure 4-6.

Control Module	
Serial Number	ADGR
Hardware Version	H481003J
Target Version	MBF 2.2.0
Common Version	2.4.0
System Version	2.0.9E
Boot Version	AviBoot 2.0.0

Site Information	
Model	MBF-T-9-18-22-S
Serial Number	AHRK
Article Number	A2170001A
TAG	Repeater - Site Name
ID	00-00-AHRK

[Reload](#)

Figure 6-2. MBF-40 Site Information

6.1.2 Date & Time

NOTE: The date and time are automatically set from the OMU II.

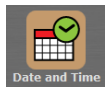

Be sure to set the correct date and time in order to accurately timestamp all events occurring on the MBF-40.

To set the Date & Time:

1. Click the **Config** button.
2. Click on **Date & Time**.
3. Do one of the following:
 - Either, enter the correct date and time according to the displayed formats.
 - Or, click on **Local Time** to set the time according to the PC running the Web-GUI.
4. Click **Apply**.

Setting date and time

Date / / (DD/MM/YY) ?

Time : : (HH:MM:SS) ?

Set to local time [Local Time](#)

[Reload](#) [Local Time](#) [Apply](#)

Figure 6-3. Configure Date and Time

6.1.3 Configure External Alarms

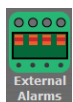

It is required to configure any connected external alarms according to the trigger (high or low) and it is recommended to assign the alarms recognizable names (such as Door Open, High Temperature, etc.)

To configure the external alarms

1. In the Main menu, click the **Config** button.
2. Click on the **External Alarms** icon.

- For each alarm:
 - Set the Trigger as High or Low as required.
 - Assign the alarm a recognizable description
- Click **Apply**.

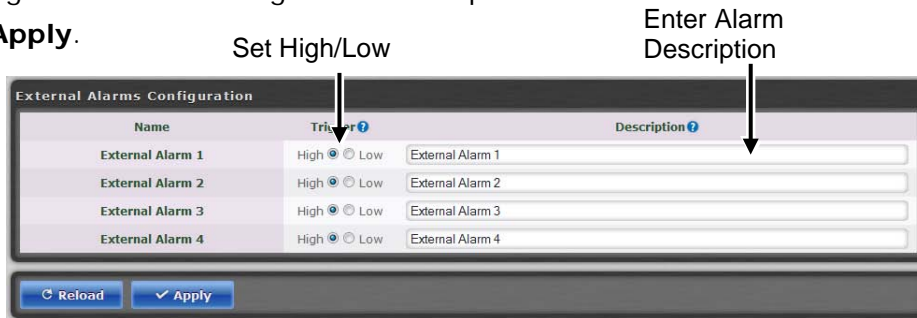

Figure 6-4: Configure External Alarms

6.1.4 IP Address



This procedure describes how to set up the IP address either manually or configure for acquisition via DHCP (usually configured for local management options).

To configure the IP address

- In the Main menu, click the **Config** button.
- Click on **Ethernet**.
- For manual IP address configuration:
 - Select Manually Configure IP Address.
 - Set the IP, Subnet Mask, Default Gateway and DNS addresses.
 - Click **Apply**.
- For DHCP IP address configuration:
 - Select Automatically Obtain IP Address (DHCP).
 - No other settings are required.
 - Click **Apply**.

The Manual configuration settings are illustrated below.

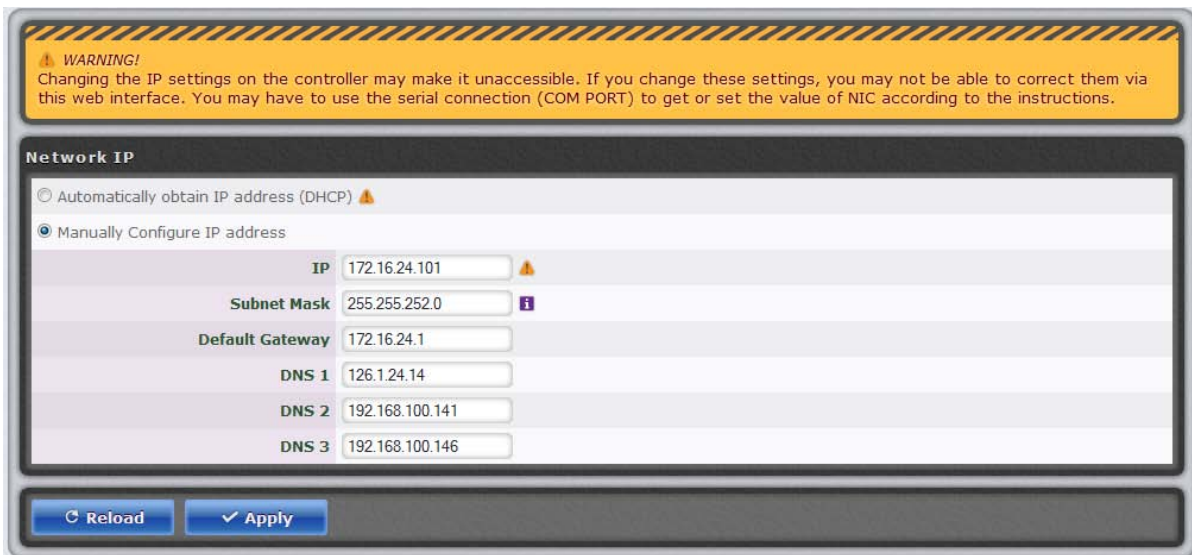
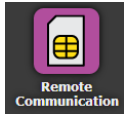

Figure 6-5: Configure Local Network Parameters

6.2 Remote Communication Setup



This section describes the Ethernet and SNMP setup. The SNMP setup option also available in this dialog is described in section 6.3. SNMP .

Select an option (ETH:TCP or ETH:SNMP) and configure. Then select the next relevant option.

NOTE: The configuration of each option is saved and active. It is not relevant which option is currently selected (ETH:TCP or ETH:SNMP).

6.2.1 TCP/IP and Ethernet

1. Click on the **Config** button.
2. From **Device:Method** select **ETH:TCP** (Ethernet:TCP/IP).
3. Click **Apply**.

Remote Communication	
All Remote Communications	ON
Device:Method	ETH:TCP
Communication Device	Ethernet Connection
Communication Method	TCP/IP connection
TCP	
AEM Main IP Address	-
AEM Main Port	1024
AEM Secondary IP Address	
AEM Secondary Port	1025
<input type="button" value="Reload"/> <input type="button" value="Apply"/>	

Figure 6-6: Remote ETH Configuration

6.3 SNMP Support

The MBF-40 includes SNMP support, including an SNMP Agent and SNMP traps (alarms). All SNMP queries and traps are supported either via the OMU II or a direct connection to the unit.

6.3.1 SNMP Traps Parameters

The MBF-40 sends SNMP traps to user defined destination addresses.

NOTE: One destination address can currently be defined via the Web. Seven more destination addresses can be defined via the Axell Shell.

To configure the SNMP traps destination address

1. Click on the **Configure** button (top right corner).
2. Select **Remote Communication**.
3. In the **Device:Method** field, select **ETH:SNMP**

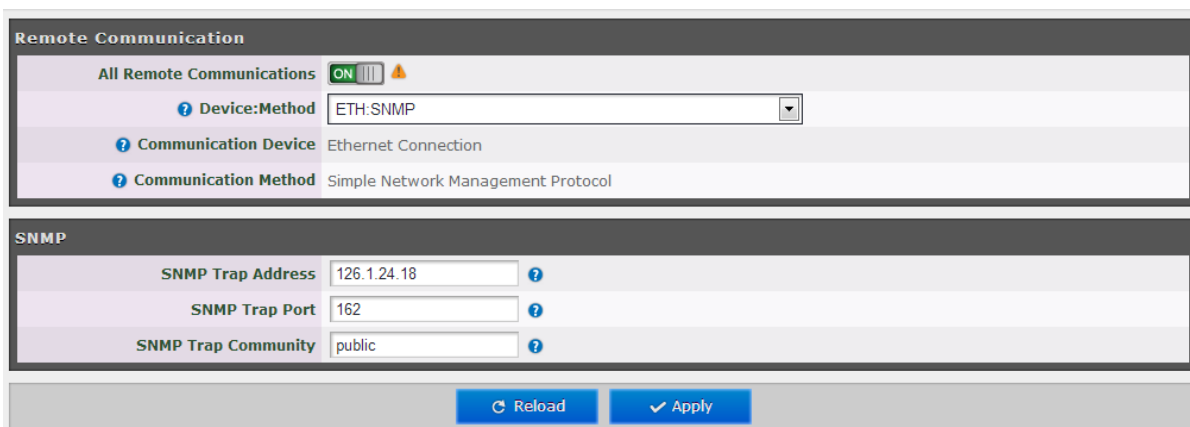

4. Define the SNMP trap destination IP address (additional addresses can be defined via the Axell Shell.).
5. Enter the (destination address device) Trap Port and its Community parameters.
6. Click **Apply**.

6.3.2 SNMP Agent - Activating and Configuring

The SNMP agent provides inventory management for hosted repeaters (on which the SNMP agent is enabled) and a table of active alarms in the controller or Fiber system for remote querying.

The SNMP Agent is responsible for responding to queries and carries out requests. The SNMP Agent also provides the proprietary Axell MIB (AXELL-AM-MIB), accessible via any SNMP manager (e.g. HP OpenView).

All SNMP queries to the remote are implemented via an OMU session.

To allow SNMP agent queries

- To allow SNMP queries of the OMU II – the SNMP agent must be enabled on the OMU II.
- To allow SNMP queries of the remote devices via OMU II – the SNMP agent must be enabled on the OMU II *and* on the remote devices.

- Remote units configured with an IP address and connected to the communication infrastructure, can be queried directly.

To activate the MBF-40 SNMP Agent

1. Click on the **Config** button (top right corner) and select **SNMP Agent Config**. The following pane appears:

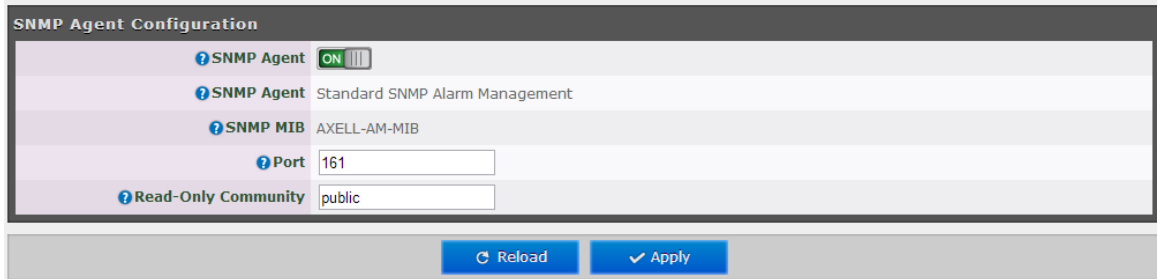

2. Set the **SNMP Agent** toggle to **ON**.
3. Set the **port** and the **Read-Only community**.
4. Click **Apply**.

6.4 User Accounts

The MBF-40 comes pre-configured with default usernames and passwords in the various administration levels.

At the moment, updating user accounts is available only via Command Line Interface (CLI) or Axell Shell. See the Common Commands and Attributes v2.4.0 document for detailed commands and syntax or click on the **Help** button at the top right of the Web-GUI screen.

6.4.1 Default User Accounts

User Name	Default Password	Details
Axell	AxellPasswd	Default user name.
omcuname	iwnkhoob	Axell Element Manager (AEM) user account. This account will not generate VLI, LGO or CLR alarms.
sysadmin	AxellAdmin4050	This is the system administration password which is used for firmware upgrades and user administration. Escalation to this level is achieved by issuing command SYSADMIN from the user prompt.
useradmin	UseradminPwd23	This account contains user administration privileges. Escalation to this level is achieved by issuing command USERADMIN from the user prompt.

NOTE: It is strongly recommended to change the default user names and passwords immediately at commissioning. This is done by using the command **ACT PASSWORD**. Please refer to the User Administration section in Common Commands and Attributes document for detailed syntax.

6.4.2 User Access Levels

In this generation of the system, standard users can be promoted to login via the Web Interface, inheriting the Read-Write or Read-Only access to this interface.

There are five different access levels:

Access Level	Default User Levels
Read-Only	axell, omcuname, useradmin, sysadmin
Read-Write	axell, omcuname, useradmin, sysadmin
Web	axell
User Administrator	omcuname, useradmin, sysadmin
System Administrator	omcuname, sysadmin

Note: New users added to the system have read-only access.

Users may be promoted to read-write and/or web access using the **ACT USERPROMOTE** command. See **Common Commands and Attributes** document for details on promoting users.

Note: Users omcuname, sysadmin and useradmin cannot be promoted to Web Access due to security reasons.

6.4.3 Change Password

To prevent unauthorized access, it is highly recommended to change the default password of the user.

NOTE: Note that you can only change the password for the User Name with which the session was accessed.

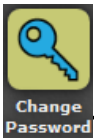

To change the Password

1. In the Main menu, click the **Config** button.
2. Click the **Change Password** button.
3. For the current User Name (e.g. **axell**):
 - Enter the New password.
 - Repeat the entry.
4. Click **Apply**.

NOTE: The password is not encrypted during transmission. Use this screen only if the connection to the repeater is safe. Use the CLI commands using an encrypted connection, if possible (i.e. SSH).



The screenshot shows a web interface titled "Change Password". It contains a "User Name" field with the value "axell". Below it are two password input fields: "New Password" and "Repeat Password". A small warning icon is visible next to the "New Password" field. At the bottom of the form is a blue button with a checkmark and the text "Apply".

6.5 Reboot



CAUTION!! Use this function in Emergency Cases ONLY

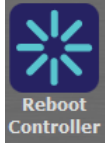

To reboot the Control Module:

1. Click the **Config** tab.
2. Click on the **Reboot** icon.
3. Approve the Reboot sequence.



6.6 Axell Shell (Command Line Interface)

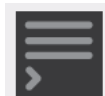

To access the Axell Shell:

1. Click on the **Config** button.
2. Select the **Axell Shell** option.

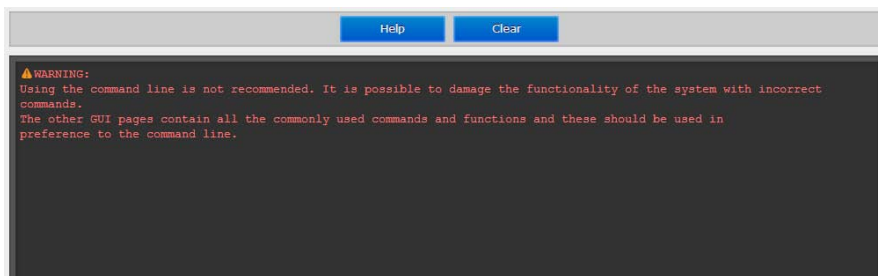

The **Axell Shell** button invokes the CLI pane. It is used to run some of the commands that are currently not provided by the Web GUI (user privileges and administration) and/or for advanced troubleshooting and configurations procedures.

All configuration and management procedures can be implemented using this interface. Please refer to the *Attribute Reference* section (by clicking the **Config** button on the top right and selecting **Attribute Reference** – see 6.7) for detailed syntax and available commands. You may also consider viewing the *MBF-40 Commands and Attributes* document.

6.7 Attribute Reference

To access the Attribute Reference

1. Click on the **Config** button.
2. Select the **Attribute Reference** option.

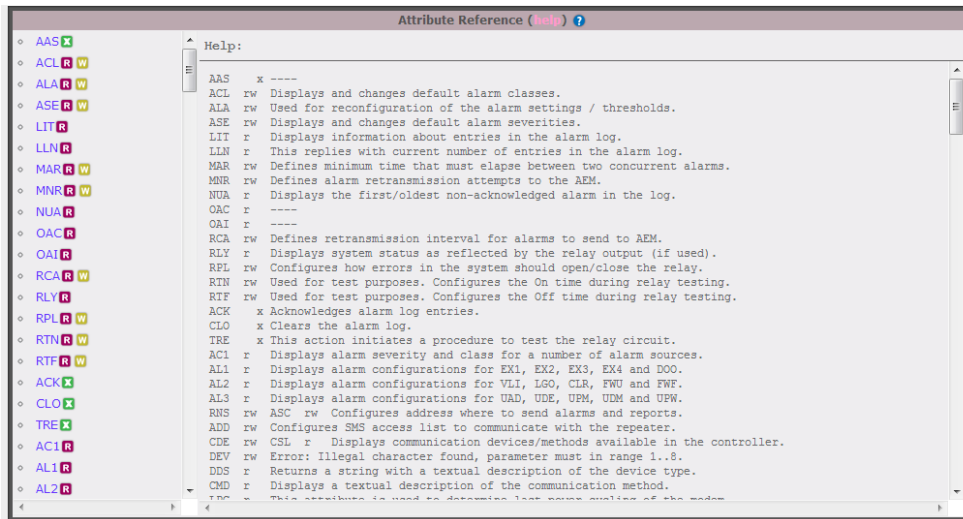

The Attribute Reference lists all available CLI commands and includes details and examples on how to use the commands. Additional information may be found in the *MBF-40 Commands and Attributes* document.

7 Monitoring and Fault Sourcing

MBF-40 provides the following monitoring and fault sourcing options:

- Web GUI Home screen Advanced mode – shows general status of system and components
- Web GUI Logs screen – provides logs of faults and operations
- Module LEDs – can be seen locally when opening the Repeater

This chapter describes these fault sourcing tools. *Be sure to review the Cautions and General Statements below.*

Note the following

- The Input / Output RF level power level monitoring windows are for indication only and should not be considered a replacement for laboratory test equipment accuracy of measurement of actual signal levels. The error of measurement will be high at low input levels.
- The normal operating range of signal measurement is as follows:
 - Downlink Output range +20dBm to +43dBm
 - Uplink Output range -10dBm to +5dBm

7.1 Monitoring Via the MBF-40 Home Screen

In addition to RF settings and readings, the MBF-40 Home screen provides detailed information on the operation status of internal modules. This information can be used to aid in remotely troubleshooting the Remote.

To access the MBF-40 Main Monitoring and Configuration window

1. Access the OMU II main windows, click the **Nodes** button, choose the remote related node and click the adjacent **Control** button. The MBF-40 Home window appears in Basic View. To view more details, click **Advanced**.

The screenshot shows the MBF-40 Main Screen in Advanced view. The interface includes a top navigation bar with 'Collapse', 'Basic', and 'Advanced' tabs. The main content is organized into several sections:

- General:** Displays Controller information (Temperature: +12.5 °C, Tag: Repeater - Site Name, Door Status, Received Data Quality) and External Alarms (External Alarm 1-4).
- Repeater Status:** Shows Bands (1, 2, 3) with details for GSM850, GSM1900, and GSM900. It includes sections for Uplink and Downlink, each with Amplifier Power, Attenuation, Amplifier, Saturation, Input, and Output. It also shows MCCA, Comm, Temperature, Condition, and Fatal Condition.
- Fiber Optic Unit:** Displays Fiber Optic Modules with details for # Module, Comm, Temperature (+16.4 °C), Tx Opto, Rx Opto, Pilot Tone Synth, Firmware, Optical Loss, Received Pilot Level, Adjustment, and Compensation (24 dB).
- Sub-systems:** Shows Master Power Supply, Slave Power Supply, and Ref. Gen. with various status indicators.

Annotations on the left side of the image identify these sections:

- General (Same as Basic view)
- Detailed Repeater Status view
- Detailed fiber optic status
- Power measurements status

Figure 7-1: MBF-40 Main Screen Advanced

7.1.1 General Page Area

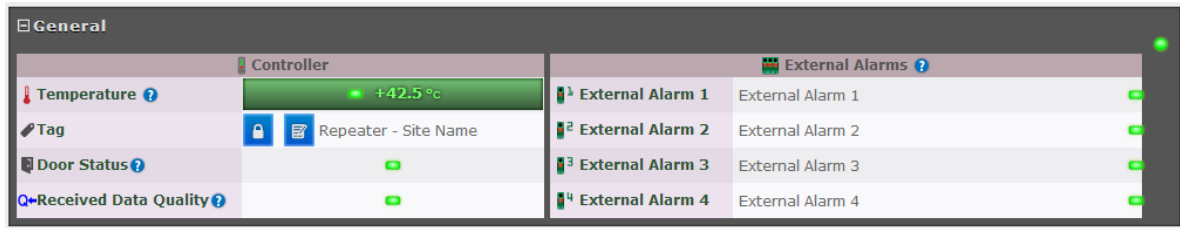

Figure 7-2: MBF-40 General

Indicator	Description
Temperature	Current ambient temperature
Tag	Name of Repeater, user customizable
Door Status	Green if closed
Received Data Quality	Check data for consistencies

7.1.2 Detailed view of the MBF-40



Figure 7-3: MBF-40 Repeater Status

Indicator	Description
Band	Overall band status.
Radio System Identifier	Band(s) and technologies in use
Comm	DL/UL status
Power	Power indication
Radio Board Firmware	Firmware related error
Radio Board Temp	Radio board temperature indicator
Amplifier Power	Turn amp. on/off.
Attenuation	Use to define DL/UL RF attenuation level per band
Amplifier	Amplifier status
Saturation	Saturation level status
Power Level	Power supply status
Input/Output	Input/output power levels
Comm	Communication status
Temperature	Temperature level and status indicator
Condition	Signal conditioning status
Fatal Condition	Critical condition indicator (RED = fault)

7.1.3 Detailed view of Fiber Optic Unit

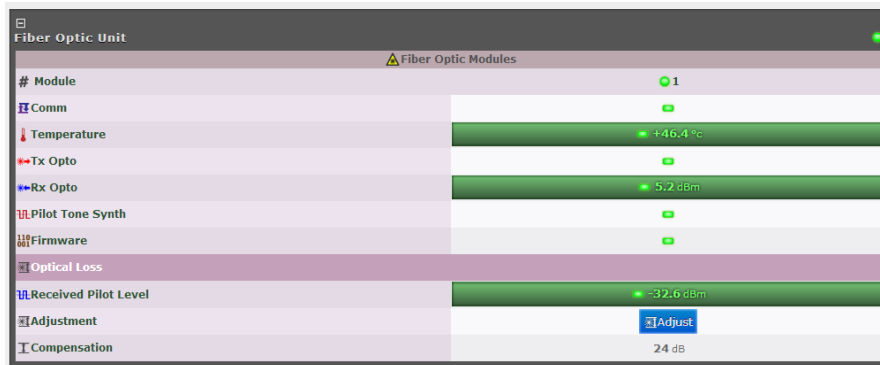
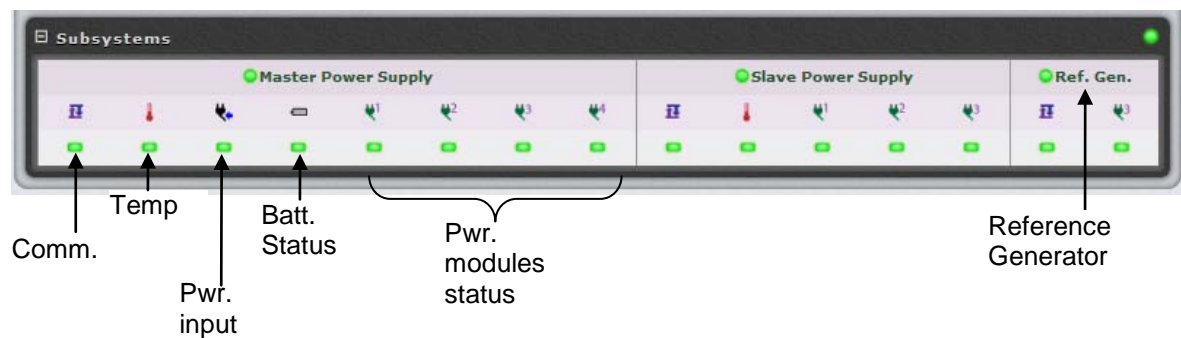

Figure 7-4: MBF-40 F/O Status

Indicator	Description
#Module	Overall optic module status
Comm	Optic connection status
Temperature	Temperature level and status indicator
Tx Opto	DL optic signal status
Rx Opto	UL optic signal strength and status
Pilot Tone Synth	Pilot tone synthesizer status
Firmware	Firmware related error
Received Pilot Level	Pilot tone level received in optic module
Adjustment	Perform UL OLA (on repeater side)
Compensation	Compensation performed on the optic link

7.1.4 Subsystems



7.2 Logs Screen

The Alarms Log displays the last 100 alarms and/or user actions on the remote system in a chronological order. By hovering with the mouse over each alarm, full alarm details are available, including alarm descriptions, severities, alarm classes and time of event.

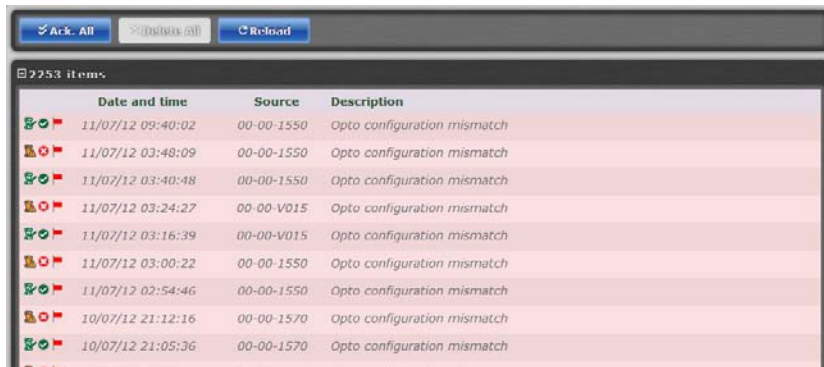

Figure 7-5: Logs

To receive a summary containing all information on a reported incident in the Log list, simply hover with the mouse over the specified Log and view all details contained in the Log (see below).

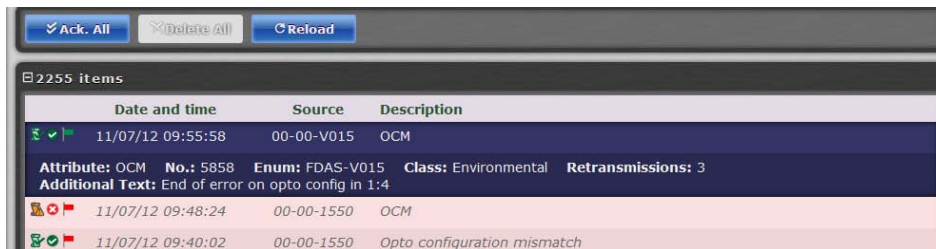







Figure 7-6: Logs – Summary

Column	Description
Date & Time	Time of occurrence
Source	ID of reporting source
Description	Additional alarm information (e.g. Open Door)

Icon	Description
	Alarm attended to and cleared.
	System alarm – displayed when system functionality may be compromised.
	Alarm status: OK
	Alarm status: Error
	Acknowledge alarm – Green = Acknowledged.
	Click to change acknowledgement. Use the Ack All button to acknowledge all alarm logs.

7.3 Module LEDs

This section describes the LEDs of the internal modules. The modules are accessed if the remote is opened. An example of the MBF-40 Dual-band, dual-service antenna model is given below:

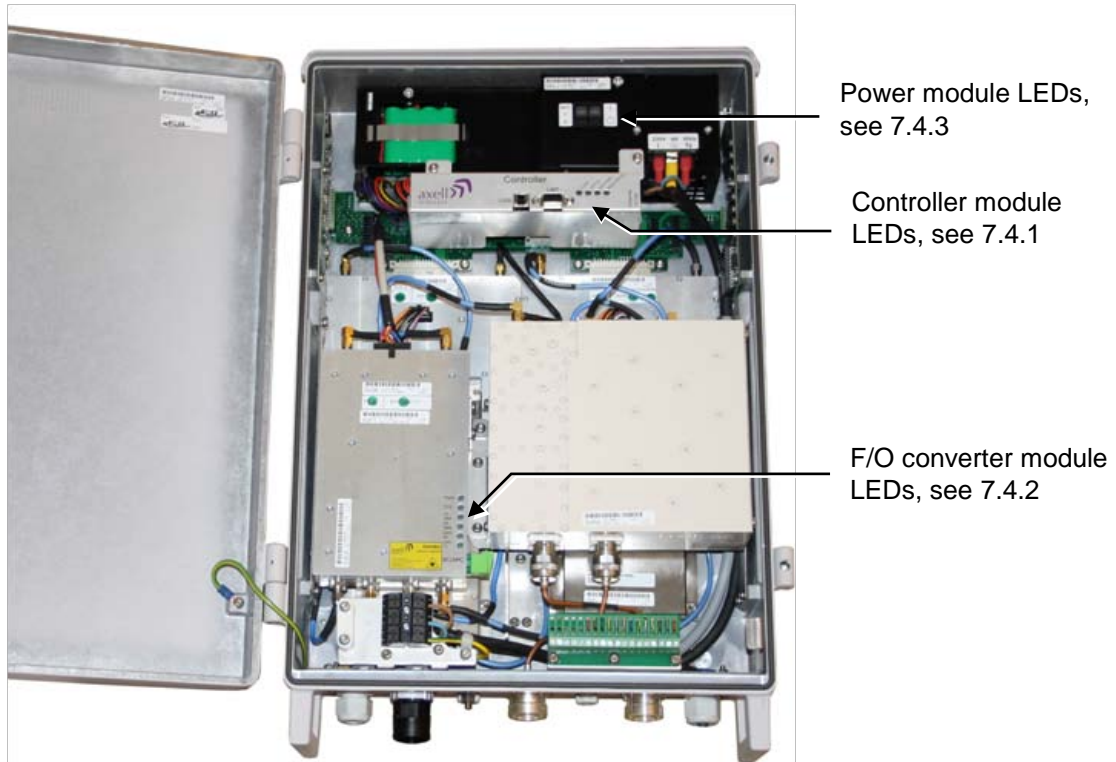

Figure 7-7: Dual band Dual Service Antenna Model

NOTE: MIMO models include two optic converter modules with separate LED indicators. Both modules' LED status should be checked.

7.3.1 Control Module LEDs

The Control Module has four LEDs which give information regarding the status of the MBF-40.

The two LEDs "Modem Power" and "Modem Status" do not fill any function and can be disregarded.

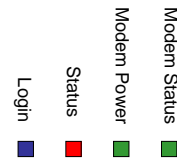

Blue LED - Login		
	Quick flash	Control Module switched on, someone logged in locally and/or remotely
	Off (except for a quick flash every 10th second)	Control Module switched on, no one logged in
	Off (permanent)	Control Module switched OFF
Red LED - Status		
	Quick flash	Control Module switched on, one or more errors/alarms detected
	Off (except for a quick flash every 10th second)	Control Module switched on, status OK
	Off (permanent)	Control Module switched off

7.3.2 F/O Converter LEDs

NOTE: MIMO models include **two** optic converters with separate status LEDs.

There are 6 LEDs on the module to indicate the status.



LED 1, Power, Green	
On	Unit is powered on
Off	Unit has no power
LED 2, Error, Red	
On	Error detected
Off	No error
LED 3, UL Data, Yellow	
On	Communication is ongoing in the uplink direction
Off	No communication
LED 4, DL Data, Yellow	
On	Communication is ongoing in the downlink direction
Off	No communication
LED 5, Opto Rx, Green	
On	Received RF signal on Fiber channel is above threshold
Off	Input level below threshold
LED 6, Opto Tx, Green	
On	Transmitted RF signal on Fiber channel is above threshold
Off	Output level below threshold

7.3.3 Power Supply LEDs

This section provides a detailed description of the LEDs and fault examples.

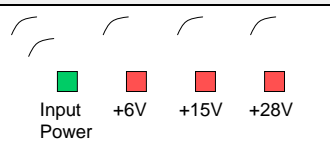
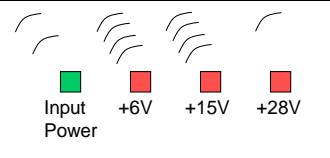
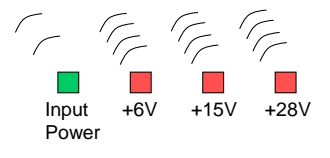

LED 1, Input Power, Green	
Slow flash	Power supply unit operating on AC or DC
OFF	Power supply unit not operating
LED 2, +6V, Red	
Slow flash (every 10 seconds)	+6V power supply operating
Quick flash	+6V power supply not operating or operating with malfunction
LED 3, +15V, Red	
Slow flash (every 10 seconds)	+15V power supply operating
Quick flash	+15V power supply not operating or operating with malfunction
LED 4, +28V, Red	
Slow flash (every 10 seconds)	+28V power supply operating
Quick flash	+28V power supply not operating or operating with malfunction

Examples	
	<p>LED 1 is flashing slowly, LED 2 – 4 are flashing slowly (once every 10 seconds) => power supply unit is operating without problem</p>
	<p>LED 1 is flashing slowly, one or two of the red LEDs are flashing quickly => Input power is operating but there is a problem with some of the other voltages</p>
	<p>LED 1 is flashing slowly, all of the red LEDs are flashing quickly => Input power is out and unit is operating on backup battery</p>

8 Maintenance

8.1 Cautions and General Statements

- The system normally operates without any operator intervention or maintenance. If in the unlikely event of any unit failure, the faulty repeater should be replaced. A failed unit can be removed and replaced with a spare while the rest of the system (other repeaters) is still operating. However, the power supply of the failed repeater should be isolated from the power before anything is replaced.
- In the event of a malfunction in the system, the status of the antenna systems as well as the continuity of the cabling should be checked before replacing any modules within the repeater.
- The Input / Output RF level power level monitoring windows are for indication only and should not be considered a replacement for laboratory test equipment accuracy of measurement of actual signal levels. The error of measurement will be high at low input levels.
- The normal operating range of signal measurement is as follows:
 - Downlink Output range +20dBm to +43dBm
 - Uplink Output range -10dBm to +5dBm
- In the event of a failure Axell Wireless's support service should be contacted for advice on a possible module replacement or other action to be taken.
- If a shipment of a repeater back to Axell Wireless is made within the period of guarantee the original packing must be used.
- Component Replacement - None of the modules in the repeater can be replaced without removing the repeater from its mounting and opening the cover of the repeater.
- Product Disposal - Disposal of this product must be handled according to all national laws and regulations. For detailed information regarding materials, please refer to Axell Wireless.



CAUTION!!

Please be aware that the equipment may, during certain conditions become very warm and can cause minor injuries if handled without any protection, such as gloves.

8.2 Batteries

The Repeater contains two types of batteries:

- A battery pack in the power supply unit, consisting of 8X NiMh batteries.
- A button cell CR1216 on the controller board.



CAUTION!!

Please be aware that the equipment may, during certain conditions become very warm and can cause minor injuries if handled without any protection, such as gloves.

Risk of explosion if battery is replaced by an incorrect type. Dispose of used batteries according to local laws and instructions.

Appendix A - US Specifications

Frequency Range		Uplink (UL)	Downlink (DL)	Operational BW	Composite Output Power (*)
LTE700	Lower band	698-716MHz	728-746MHz	29MHz	+37 dBm
	Upper band	776-787MHz	746-757MHz	29MHz	+37 dBm
800MHz (Sprint)		817-824 MHz	862-869 MHz	32MHz	+37 dBm
850MHz (Cellular)		824-849MHz	869-894MHz	32MHz	+37 dBm
1900MHz (PCS)		1850-1915MHz	1930-1995MHz	65MHz	+37 /+43 dBm**
1700MHz (AWS)		1710-1755MHz	2110-2155MHz	45MHz	+39 / +43 dBm**
General Parameters					
Noise Figure		3dB Typical (maximum gain)			
Ripple		±2dB			
Propagation Delay		< 2µs			
Gain UL/DL		Adjustable, in 1dB steps			
System Impedance		50Ω			
Return loss at antenna connections		>14dB			
Antenna Connectors		DIN 7/16			
No. of antenna ports		1 for single/dual/tri/quad band, 2 connectors for MIMO			
Electrical ratings		115VAC 60Hz, -48VDC			
Optical Parameters					
Wavelength DL/UL		1310/1550nm			
Max optical Loss		10dBo			
F/O Connector		1 SC/APC for SISO, 2 for MIMO			
Modulation Accuracy at nominal output power					
GSM/GMSK		<2.5° RMS and <10° peak			
EDGE/8-PSK		<3% EVM RMS			
WCDMA/EVM		<12.5% RMS (composite according to ETSI TS 25.106 with TM1/64 DPCH)			
LTE/EVM		< 8% (composite according to 3GPP TS 136 106)			
PkCDE		<-33dB (ETSI TS 25.106 with TM 1/64 DPCH and spreading factor 256)			
Power Consumption	Single Band	Dual Band	Tri Band	Quad Band	
	140W	220W / 350W ***	350W	400W	
Mechanical	Single Band	Dual Band	Tri Band	Quad Band	
Dimensions	21.3" x 15" x 7.8" 540 x 382 x 198mm	21.3" x 15" x 7.8" 540 x 382 x 198 mm	21.3" x 15" x 12.3" 540 x 382 x 313 mm	21.3" x 15" x 12.3" 540 x 382 x 313 mm	
Weight	44lbs (20kg)	48.5lbs (22kg)	76lbs (34kg)	82lbs (37kg)	
Enclosure	Aluminum (IP65)				
Environmental					
EMC		FCC			
Operating Temperature		-77 to +121°F (-25 to +50°C)			
Storage Temperature		-86 to +158°F (-30 to +70°C)			
Humidity		ETSI EN 300 019-2-4 (see compliance below)			
Complies With					
Radio	FCC parts 22, 24 and 27 where applicable.				
Safety	UL 60 950-1, 1st Edition "Information Technology Equipment – Safety - Part 1: General requirements" UL 50, 11th Edition "Enclosures for Electrical Equipment"				

* In repeaters that share a common downlink Fiber for 900MHz and 1800MHz a minimum of 4 carriers in each band is required for the full composite output power to be attainable maintaining full ETSI compliance.

** The composite output power is model dependent.

*** Power consumption of all dual-band models except for MBF-4317-4319, is 220W. Power consumption for MBF-4317-4319 is 350 W.







Appendix B - Canada Specifications

Frequency Range		Uplink (UL)	Downlink (DL)	Operational BW	Composite Output Power (*)
LTE700	Lower band	698-716MHz	728-746MHz	29MHz	+43dBm
	Upper band	776-787MHz	746-757MHz	29MHz	+43dBm
850MHz (Cellular)		824-849MHz	869-894MHz	25MHz	+43dBm
1900MHz		1850-1915MHz	1930-1995MHz	65MHz	+43dBm
1700MHz (AWS)		1710-1755MHz	2110-2155MHz	45MHz	+43dBm
2600MHz		2500-2570MHz	2620-2690MHz	70MHz	+43dBm
General Parameters					
Noise Figure		3dB Typical (maximum gain)			
Ripple		±2dB			
Propagation Delay		< 2µs			
Gain UL/DL		Adjustable, in 1dB steps			
System Impedance		50Ω			
Return loss at antenna connections		>14dB			
Antenna Connectors		DIN 7/16			
No. of antenna ports		1 for single/dual/tri/quad band, 2 connectors for MIMO			
Electrical ratings		115VAC 60Hz, -48VDC			
Cooling		Convection in single, dual and tri-band. Quad-band requires fan hood			
Optical Parameters					
Wavelength DL/UL		1310/1550nm			
Max optical Loss		10dB _o			
F/O Connector		1 SC/APC for SISO, 2 for MIMO			
Modulation Accuracy at nominal output power					
GSM/GMSK		<2.5° RMS and <10° peak			
EDGE/8-PSK		<3% EVM RMS			
WCDMA/EVM		<12.5% RMS (composite according to ETSI TS 25.106 with TM1/64 DPCH)			
LTE/EVM		< 8% (composite according to 3GPP TS 136 106)			
P _k CDE		<-33dB (ETSI TS 25.106 with TM 1/64 DPCH and spreading factor 256)			
Power Consumption	Single Band	Dual Band	Tri Band	Quad Band	
	140W	220W	350W	400W	
Mechanical	Single Band	Dual Band	Tri Band	Quad Band	
Dimensions	21.3" x 15" x 7.8" 540 x 382 x 198mm	21.3" x 15" x 7.8" 540 x 382 x 198 mm	21.3" x 15" x 12.3" 540 x 382 x 313 mm	21.3" x 15" x 12.3" 640 x 382 x 313 mm	
Weight	44lbs (20kg)	48.5lbs (22kg)	76lbs (34kg)	83lbs (38kg)	
Enclosure	Aluminum (IP65)				
Environmental					
EMC	IC				
Operating Temperature	-77 to +121°F (-25 to +50°C)				
Storage Temperature	-86 to +158°F (-30 to +70°C)				
Humidity	ETSI EN 300 019-2-4 (see compliance below)				

Appendix C – F/O Cleaning Procedure

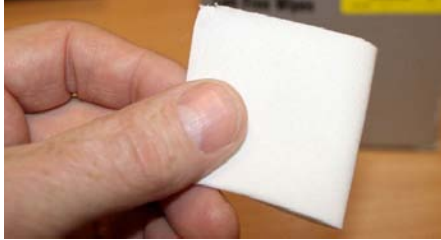
NOTE: The process is demonstrated on an OMU F/O module and is similar to all F/O equipment supplied by Axell.

Tools

Tool Description	Illustration
Fiberscope connected to a PC running the appropriate viewing software. It is highly recommended that some form of Fiber viewing equipment such as a Fiberscope is used to ensure that all Fiber connections are clean before termination; failure to do so could result in poor system performance	
Lint-free swabs (box), Axell P/N 99-000127	
Lint-free wipes (pack) Axell P/N 99-000125	
Fujikura "One Click" cleaner Axell P/N 98-900004.	
99% isopropyl alcohol (can), Axell P/N 99-000126	
Cletop type S Cassette Cleaner, Axell P/N 98-900001	

F/O Cleaning Procedure

There are two types of procedures:

- Dry
- Web

Dry Cleaning



ATTENTION!! Invisible laser radiation might be emitted from disconnected Fibers or connectors. Do not stare into beams or view directly with optical instruments.

1. Before cleaning the optical connectors on the OMU it is advisable to clean the connector of the mating cable being attached to the optical port.

An unclean optical connector is often the cause for reduced system performance. A bit of dust or oil from a finger can easily interfere with, or block light. Fortunately, it is very easy to clean the connector. Be sure to use the correct procedure for the given connector. When disconnected, cap the SC/APC connector to keep it clean and prevent scratching the tip of the ferrule.

Use a product specially designed for the purpose, such as the Cletop type S Cassette Cleaner.



2. Begin by dry cleaning the F/O bulkhead connector (shown below is the Fujikura One-Click in use).



IMPORTANT!! Always make sure there is a way of inspecting the connector after cleaning. Cleaning can actually leave the end-face in a worse condition, since alcohol residue is one of the most difficult contaminants to remove.

3. Remove the protective cap from the cleaning-head end of the "One Click" cleaner, lift the protective end-cap on the Fiber connector and offer-up the end to the Fiber connector



4. With the cleaning-head end fully engaged in the connector, push until an audible "click" is heard

5. Without fully withdrawing the cleaning head end push it in again twice more, each time until an audible "click" is heard.



6. Withdraw the "One Click" cleaner and replace the protective end cap.

7. Inspect the Fiber connector using a Fiberscope. On the PC monitor, verify that there is no contamination present on the connector end-face.

8. If the connector is dirty, clean it with a wet cleaning technique followed immediately by dry cleaning. This is to remove any remaining residue from the wet clean (the following steps demonstrate a wet cleaning technique).

Wet Cleaning

 ATTENTION!	<p>Invisible laser radiation might be emitted from disconnected fibers or connectors. Do not stare into beams or view directly with optical instruments.</p>
--	--

1. Lightly moisten a new lint-free wipe with 99% isopropyl alcohol. (Step 1 below).

Tip: Have a dry lint-free swab available for immediately drying after performing the wet-cleaning.

2. Lightly press and turn a clean lint-free swab in the moistened area of the wipe to moisten the swab. It is important that the swab is not too wet. (Step 2 below).
3. Insert the moistened lint-free swab into the bulkhead adapter. Lightly press and rotate several times in the same direction (Step 3 below).

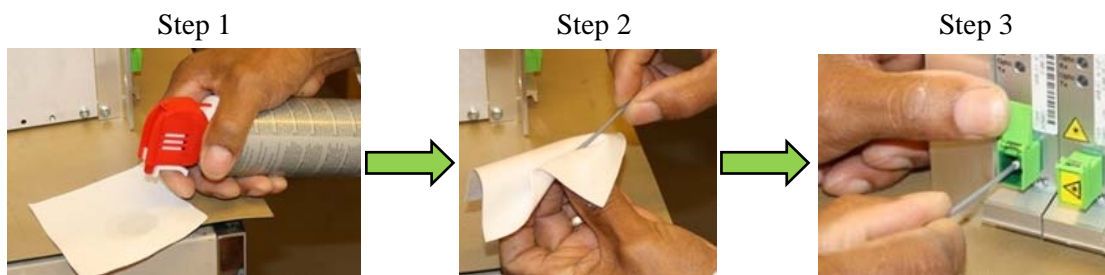

Figure 8-1: Wet-Cleaning Technique

4. Immediately use a dry lint-free swab to clear any remaining alcohol residue.

NOTE: Do **not** re-use any of the wipes and/or swabs. Dispose of them properly.

5. Follow steps 3 to 6 of Dry Cleaning above
6. Re-inspect the Fiber using the Fiberscope. On the PC monitor, verify that there is no contamination present on the connector end-face.
7. If the Fiber is still dirty, go back to step 1 (Wet Cleaning) and repeat the entire process.

NOTE: The entire wet/dry cleaning cycle should only be used twice, if the Fiber is still dirty after two cycles of wet/dry cleaning seek advice from the Axell Wireless Support Desk.
