

PDI Communication Systems



22" Healthcare LCD TV



User Manual

Model

PDI-CV2200



CAUTION: TO REDUCE THE RISK OF ELECTRIC SHOCK DO NOT REMOVE COVER (OR BACK) NO USER SERVICEABLE PARTS INSIDE REFER SERVICING TO QUALIFIED SERVICE PERSONNEL

	This lightning flash with arrowhead symbol within an equilateral triangle is intended to alert the user to the presence of uninsulated dangerous voltage within the product's enclosure that may be of sufficient magnitude to constitute a risk of electric shock to persons.
	The exclamation point within an equilateral triangle is intended to alert the user to the presence of important operating and maintenance (servicing) instructions in the literature accompanying the product.

WARNING: To reduce the risk of fire or electric shock, do not expose this apparatus to rain or moisture.

WARNING: To prevent injury, this apparatus must be securely attached to the floor/wall in accordance with the installation instructions.

WARNING: Do not install this equipment in a confined space such as a bookcase or similar unit.

CAUTION: Do not block ventilation openings. Install in accordance with the manufacturer's instructions.

REGULATORY INFORMATION

FCC Part 15

This equipment has been tested and found to comply with the limits for a Class B digital device, pursuant to Part 15 of the FCC Rules.

These limits are designed to provide reasonable protection against harmful interference in a residential installation. This equipment generates, uses and can radiate radio frequency energy and, if not installed and used in accordance with the instructions, may cause harmful interference to radio communications.

However, there is not guarantee that interference will not occur in a particular installation. If this equipment does cause harmful interference to radio or television reception, which can be determined by turning the equipment off and on, the user is encouraged to try to correct the interference by one or more of the following measures:

- Reorient or relocate the receiving antenna.
- Increase the separation between the equipment and receiver.
- Connect the equipment into an outlet on a circuit different from that to which the receive is connected.
- Consult the dealer or an experienced radio/TV technician for help.

Modifications

Any changes or modifications made to this device that are not expressly approved by PDI may void the user's authority to operate the equipment.

Cables

Connections to this device must be made with shielded cables with metallic RFI/EMI connector hoods to maintain compliance with FCC Rules and Regulations.

Healthcare Grade Television

The PDI Healthcare series television is specifically designed for installation and use in a healthcare environment. The TV's special design and safety features have been investigated by the Underwriters Laboratory and Listed for use in Hospitals, Nursing Facilities, Dialysis Clinics, and similar healthcare services.

SERVICING

User Servicing

If your product is not operating correctly or exhibits a marked change in performance and you are unable to restore normal operation by following the detailed procedure in its operating instructions, do not attempt to service it yourself as opening or removing covers may expose you to dangerous voltage or other hazards. Refer all servicing to qualified service personnel.

Damage Requiring Service

Unplug this product from the wall outlet and refer servicing to qualified service personnel under the following conditions:

- When the power supply cord or plug is damaged.
- If liquid has been spilled, or objects have fallen into the product.
- If the product has been exposed to rain or water.
- If the product does not operate normally by following the operating instructions. Adjust only those controls that are covered by the operating instructions as an improper adjustment of other controls may result in damage and will often require extensive work by a qualified technician to restore the product to its normal operation.
- If the product has been dropped or damaged in any way.
- When the product exhibits a distinct change in performance which indicates a need for service.

Replacement Parts

When replacement parts are required, be sure the service technician has used replacement parts specified by the manufacturer or have the same characteristics as the original part. Unauthorized substitutions may result in fire, electric shock, or other hazards.

Safety Check

Upon completion of any service or repairs to this product, ask the service technician to perform safety checks to determine that the product is in safe operating conditions.

Cleaning & Disinfecting

- Unplug the TV Before Cleaning.
- Use a soft damp cloth to clean.
- Do not use harsh chemicals such as solvents.
- Wipe off water droplets from the cabinet and screen as soon as possible as they may leave spots.

IMPORTANT SAFETY INSTRUCTIONS

1. Read these instructions.
2. Keep these instructions.
3. Heed all warnings.
4. Follow all instructions.
5. Do not use this apparatus near water.
6. Clean only with dry cloth.
7. Do not block any ventilation openings. Install in accordance with the manufacturer's instructions.
8. Do not install near any heat sources such as radiators, heat registers, stoves, or other apparatus (including amplifiers) that produce heat.
9. Do not defeat the safety purpose of the polarized or grounding-type plug. A polarized plug has two blades with one wider than the other. A grounding type plug has two blades and a third grounding prong. The wide blade or the third prong are provided for your safety. If the provided plug does not fit into your outlet, consult an electrician for replacement of the obsolete outlet.
10. Protect the power cord from being walked on or pinched particularly at plugs, convenience receptacles, and the point where they exit from the apparatus.
11. Only use attachments/accessories specified by the manufacturer.
12. Use only with the cart, stand, tripod, bracket, or table specified by the manufacturer, or sold with the apparatus. When a cart is used, use caution when moving the cart/apparatus combination to avoid injury from tip-over.
13. Unplug this apparatus during lightning storms or when unused for long periods of time.
14. Refer all servicing to qualified service personnel. Servicing is required when the apparatus has been damaged in any way, such as power-supply cord or plug is damaged, liquid has been spilled or objects have fallen into the apparatus, the apparatus has been exposed to rain or moisture, does not operate normally, or has been dropped.
15. This appliance should be mounted to a wall or ceiling only as recommended by the manufacturer.
16. Care should be taken so that objects do not fall



and liquids are not spilled into the enclosure through openings.

17. If an outside antenna or cable system is connected to the video product, be sure the antenna or cable system is grounded so as to provide some protection against voltage surges and built-up static charges. Section 810 of the National Electrical Code, ANSI/NFPA 70, provides information with respect to proper grounding of the mast and supporting structure, grounding of the lead-in wire to an antenna discharge unit, size of grounding conductors, location of antenna-discharge unit, connection to grounding electrodes, and requirements for the grounding electrode. See Figure A.

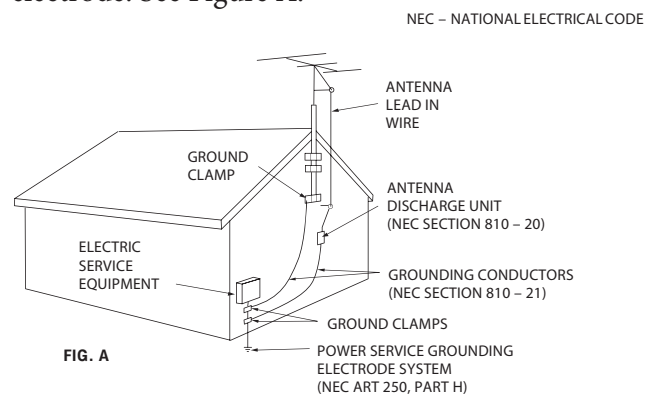

NOTE: This reminder is provided to call the CATV system installer's attention to article 820-40 of the NEC that provides guidelines for proper grounding and, in particular, specifies that the cable ground shall be connected to the grounding system of the building, as close to the point of cable entry as practical.

OPTIONAL ACCESSORIES

The following optional accessories are available for your PDI Healthcare television.

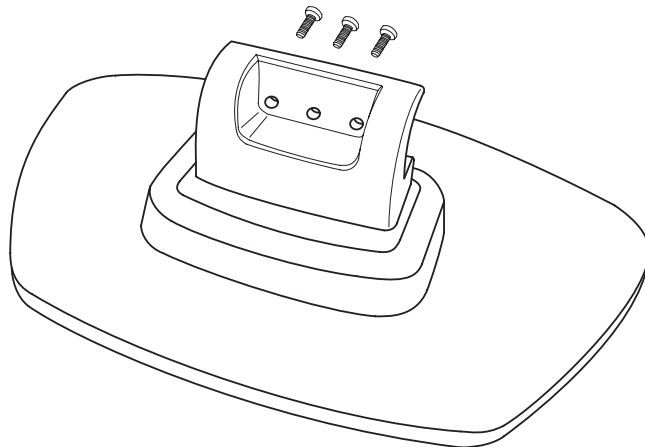

CV2200 Table Stand CV1002

Programming Remote

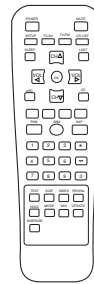

PD108-420

Patient Remotes

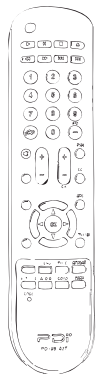

PD108-421 PD108-427

INSTALLATION

LOCATION

Locate a mounting position on the foot wall in front of the hospital bed. Other locations may be used depending upon the mounting means and room type. Healthcare televisions are normally mounted near the ceiling to provide needed clearance.

Note: Ceiling mounted fluorescent lights and windows may produce unwanted glare and should be considered when selecting a mounting location.

TV MOUNT

The PDI Healthcare television utilizes a 75 mm VESA pattern. Selection of an appropriate mount will depend primarily upon the mount's capacity and intended functionality. Install the TV as recommended by the mount's manufacturer.

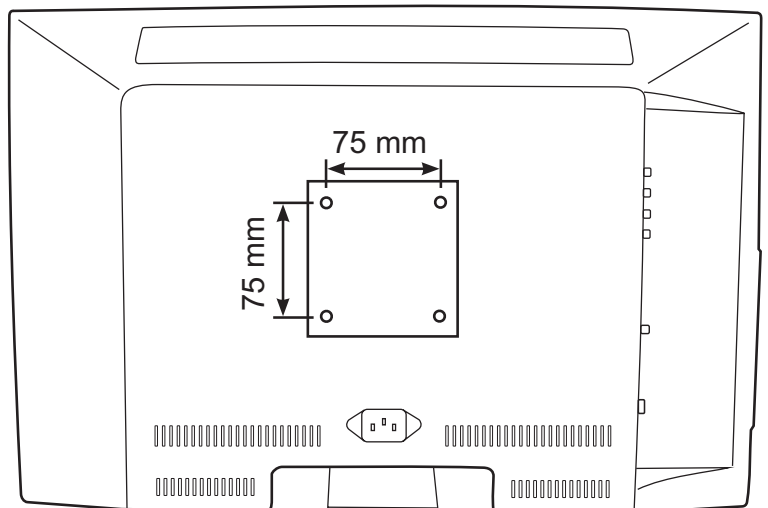

CV2200 SPECIFICATIONS

Weight: 10 lbs
Mount: 75 mm VESA, 4mm Thread
Dimensions: 21" x 14" x 3½" (WHD)

PILLOW SPEAKER CONNECTIONS

PILLOW SPEAKER STYLES

Control of the TV is possible using either a single-button Analog or multi-button Digital style pillow speaker (neither supplied with TV).

TV PILLOW SPEAKER WIRING

The PDI Healthcare television series utilizes the industry standard 3-wire interface via a 1/4 inch stereo jack located on the back of the TV.

Additionally, the TV employs a universal pillow speaker interface that can be configured to operate with many different model pillow speakers. Move the pillow speaker slide switch located next to the Pillow Jack to match the appropriate style pillow speaker. Refer to your nurse call system wiring instructions for the pillow speaker's bed side connections.

Slide Switch Position	Pillow Speaker Type
CR	RCA
OFF	Disables Pillow Speaker Control
CP	Phillips
CZ	Zenith and Analog

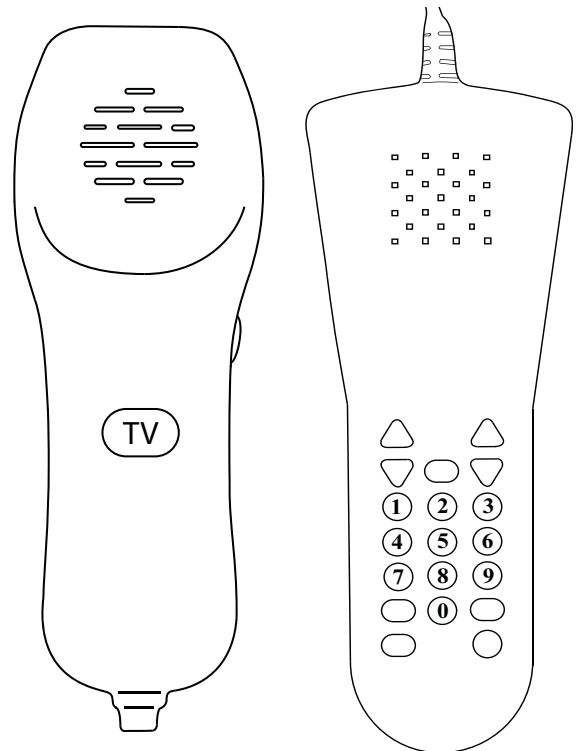

ANALOG

DIGITAL

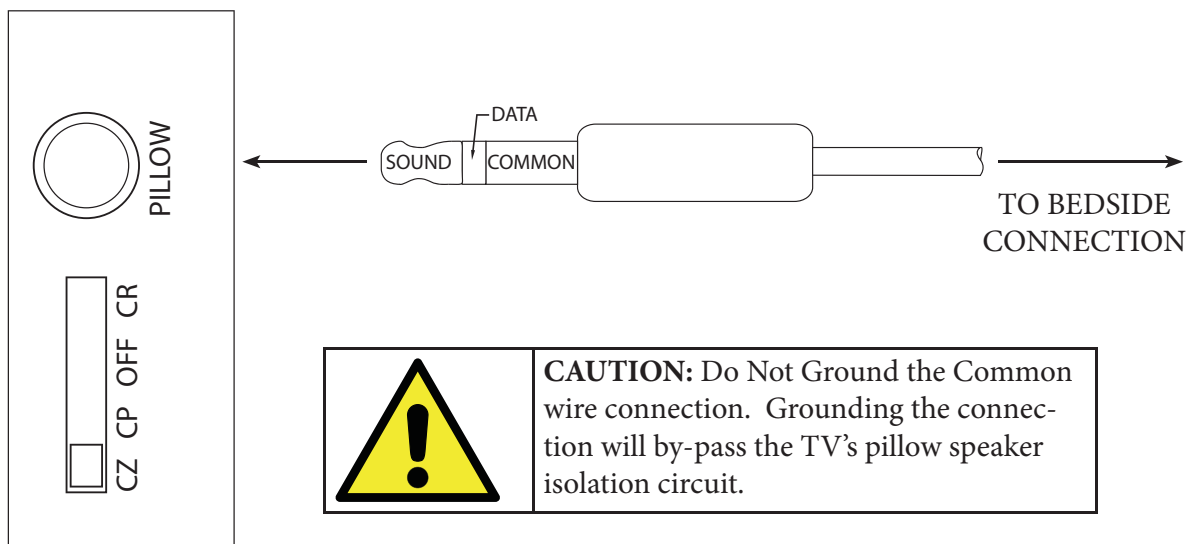

TV CONTROLS & CONNECTIONS

TV Controls

Standard TV controls are located on the TV's lower left cabinet side. Basic control is provided.

- 1 TV/AV** Switches the TV between various Enabled Sources. Press the button once to verify the current sources. Press the button additional times to advance to the next active source.
- 2 CC** Closed Caption (Sub-Title) control. Press the button once to verify the current Closed Caption mode. Press the button additional times to advance to the next Closed Caption Mode.
- 3 CH▲/▼** Selects the next or previous channel. If a menu item is active, selects the next or previous menu item.
- 4 VOL▲/▼** Increases or decreases the volume. If a menu item is active, adjusts the menu item's settings.
- 5 POWER** Turns TV On and Off.

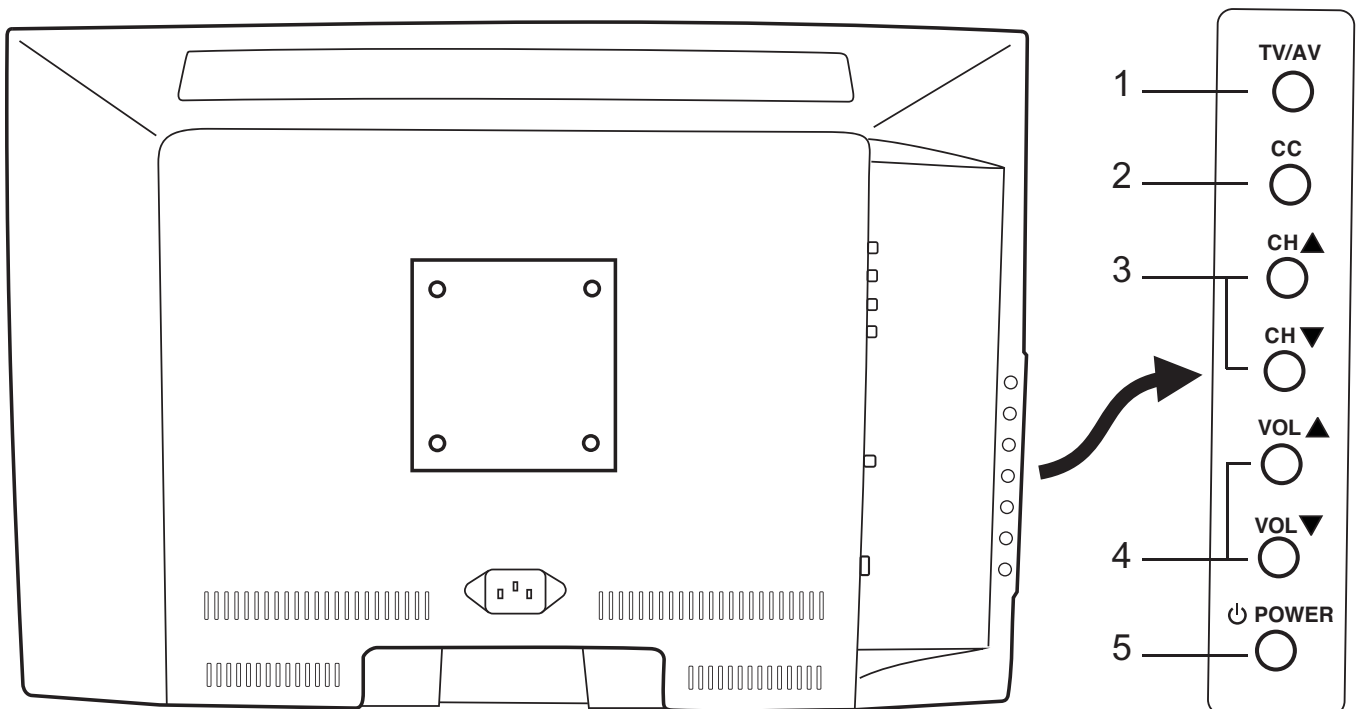

TV Connections

The PDI CV series televisions offer connection jacks for many different types of external devices such as DVD players, Game Boxes, and other similar devices. Connections are located along the side edge of the television.

TV Connectors

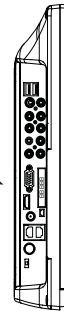

TV Connectors

CLONE <i>See Page 13</i>	USB port for Clone operation and updating the TV's operational firmware.
S-VIDEO	S-Video, L (Left channel sound), R (Right channel sound) inputs.
COMPOSITE VIDEO	Composite Video, L (Left channel sound), R (Right channel sound) inputs.
Y/PB/PR AUDIO	Left and Right sound input jacks for Component IN.
VGA AUDIO	PC Audio Input jack. The TV's internal speakers can be used for computer sound.
Component IN	Input for a Component signal, with Y, P _B , & P _R jacks.
VGA	VGA Video input jack. The TV can be used as a computer monitor.
HOURL METER	Readout of hours the TV has been in use.
HDMI	HDMI signal jack. Input for the high quality HDMI signal.
ANT TV/FM	Connection for hospital Cable TV Coax cable.
EXT +5	Maintenance port to supply +5V for TV diagnostics.
MTI	Multiple Television Interface jack. Use with external control boxes. NOTE: Do NOT connect to a hospital's network as damage will result to the TV.
CCI	Computer Control Interface jack. NOTE: Do NOT connect to a hospital's network as damage will result to the TV.
PILLOW	Pillow Speaker Jack. See <i>PILLOW SPEAKER CONNECTIONS</i> for details.
CR-OFF-CP-CZ	Pillow Speaker compatibility switch. See <i>PILLOW SPEAKER CONNECTIONS</i> for details.



Powering the TV

The TV offers power conservation features when the unit is turned Off and Idle (in standby). Two Standby Power modes are available:

Low

TV is asleep and requires 15 seconds to wake up (Turn On).

Normal

TV is awake and can be turned On in a quick manner.



NOTE: Changing the TV's Standby Power setting to Normal reduces the wait time the patient experiences while the TV awakens from standby mode.

1. Turn the TV On.
2. Press the Setup button on the remote.
3. From the **Setup** menu, select **Features**.
4. In the **Features** menu, select **Standby Power**.
5. Set Standby Power to the appropriate mode.

SETUP MODE	
▪ Service Level	Free
▪ Picture	▶
▪ Sound	▶
▪ Channel Setup	▶
▪ Features	▶
▪ OSD Language	English
▪ Source Setup	▶
▪ FM Radio Setup	▶
Position: ▲▼	
Exit: SETUP	
Next: ◀▶	

Features	
▪ Power On Caption Mode	Last
▪ Auto Power On	Disabled
▪ Power Management	Disabled
▪ Bed A/B	A
▪ Caption Text Modes	Disabled
▪ Digital Captions	▶
▪ Digital Mode Time Setup	▶
▪ Diagnostics	▶
▪ Channel Up Power Off	Disabled
▪ Channel to other Sources	Enabled
▪ Power on ARC Mode	Last
▪ Slot Standby Power	Disabled
▪ Standby Power	Low
Position: ▲▼	
Exit: SETUP	
Next: ◀▶	

Programming the TV

Connect the TV to a Cable TV signal before proceeding. Programming is accomplished with a programming remote control. Verify the handheld remote control operates the TV.

1. Press the setup button on the remote.
2. From the **Setup** menu, select **Channel Setup**.
3. In the **Channels Setup** menu, select **Signal**. Set the signal to one appropriate to your healthcare facility. The possible choices are,
 - Cable STD Standard Cable TV
 - Cable IRC Incrementally Related Carrier
 - Cable HRC Harmonically Related Carrier
 - Air Air (Antenna)
4. In the **Channel Setup** menu, select **Auto Program**.
5. In the **Auto Program** menu, select **Mode**. The TV can be set to search and locate different styles of TV signals; **Analog Only**, **Digital Only**, or both **Analog and Digital** channels. Select the style of signal.
6. In the **Auto Program** menu, select **Channel Sequence** and select the manner in which channels are viewed. The possible selections are:
 - Interleave A+D Analog & Digital appear grouped together
 - All A then D Analog appear first, followed by Digital
7. The **Additional Digital Signal** selection allows for auto programming of a second block of channels using a different signal type. For example, first Auto Program the TV for CATV STD signals, then use the **Additional Digital Signal** set to AIR provides a second auto programming of air type signals to be included in addition to the channels found during normal Auto Program searching into the same Service Level.
8. The TV offers 3 discrete groups of channels or **Service Levels**. Free, Basic, or Premium can each be programmed and used as needed. Select the desired Service Level to program.
9. Press the **Yes** (Channel Up button) to begin Auto Programming or **No** (Channel Down button) to exit. Auto Programming takes approximately 2 to 12 minutes.

SETUP MODE	
▪ Service Level	Free
▪ Picture	▶
▪ Sound	▶
▪ Channels Setup	▶
▪ Features	▶
▪ OSD Language	English
▪ Sources Setup	▶
▪ FM Radio Setup	▶
Position: ▲▼	
Exit: SETUP	Next: ◀▶

Channel Setup	
▪ Signal	Cable STD
▪ Auto Program	▶
▪ Add/Delete Channels	▶
▪ Clear Service Level	▶
▪ Copy Service Level	▶
▪ Parental Control	▶
▪ Power On Channel	▶
▪ Channel Lock	Disabled
▪ Channel Memory Override	Enabled
Position: ▲▼	
Exit: SETUP	Next: ◀▶

Auto Program	
▪ Mode	Analog Only
▪ Channel Sequence	Interleave A+D
▪ Additional Digital Signal	None
▪ Free	Programmed ▶
▪ Basic	Blank ▶
▪ Premium	Blank ▶
Position: ▲▼	
Exit: SETUP	Next: ◀▶

Confirm Auto Program	
▪ Confirmation	▶
Exit: SETUP	
	Yes ▲
	No ▼

Pillow Speaker Sound Setup

Proper setup of the TV's Sound is required for use with a wired Pillow Speaker. Setup involves disabling the TV's internal speakers and then setting the audio level to the pillow speaker.

1. Press the setup button on the handheld programming remote control.
2. From the **Setup Mode** menu, select **Sound**.
3. In the **Sound** menu, select **Internal Speaker Enable**.
4. In the **Internal Speaker Enable** menu select the source you wish to disable. For television select TV.
5. For Pillow Speakers with a thumb wheel volume control, in the **Sound** Menu, select **Minimum Volume**, and set the level to approximately 50% to provide a fixed level of sound for the pillow speaker to adjust.
NOTE: Pillow Speakers with dedicated Volume Up and Volume Down buttons do not require a Minimum Volume adjustment.

SETUP MODE	
▪ Service Level	Free
▪ Picture	▶
▪ Sound	▶
▪ Channel Setup	▶
▪ Features	▶
▪ OSD Language	English
▪ Sources Setup	▶
▪ FM Radio Setup	▶
Position: ▲▼	
Exit: SETUP	Next: ◀▶

Sound	
▪ Balance	0
▪ Minimum Volume	0
▪ Maximum Volume	100
▪ Power On Volume	Last
▪ Internal Speaker Enable	▶
▪ HDMI Audio Port	HDMI
▪ Composite / S-Video Sound Mode	L + R
Position: ▲▼	
Exit: SETUP	Next: ◀▶

Internal Speaker Enable	
▪ TV	Speaker Disabled
▪ Composite Video	Disabled
▪ S-VIDEO	Disabled
▪ Component	Disabled
▪ HDMI	Disabled
▪ PC-ANALOG	Disabled
▪ FM RADIO	Disabled
▪ Slot 1	Disabled
▪ Slot 2	Disabled
Position: ▲▼	
Exit: SETUP	Next: ◀▶

Sound	
▪ Balance	0
▪ Minimum Volume	50
▪ Maximum Volume	100
▪ Power On Volume	Last
▪ Internal Speaker Enable	▶
▪ HDMI Audio Port	HDMI
▪ Composite / S-Video	L + R
Position: ▲▼	
Exit: SETUP	Next: ◀▶

Programming the TV's FM Radio

Connect the TV to a Cable TV signal before proceeding. Verify the handheld remote control operates the TV.

1. Press the setup button on the remote.
2. From the **Setup Mode** menu, select **FM Radio Setup**.
 NOTE: if the FM Radio item is non-selectable, enable **FM Radio** in the **Sources** menu first.

SETUP MODE	
▪ Service Level	Free
▪ Picture	▶
▪ Sound	▶
▪ Channels Setup	▶
▪ Features	▶
▪ OSD Language	English
▪ Sources Setup	▶
▪ FM Radio Setup	▶
Position: ▲▼	
Exit: SETUP	Next: ◀▶

3. In the **FM Radio Setup** menu, select **Auto Program**. A confirmation screen will appear.

FM Radio Setup	
▪ Auto Program	▶
▪ Frequency	100.7 MHz
▪ Add/Delete	Added
Position: ▲▼	
Exit: SETUP	Next: ◀▶

4. In the **Confirm FM Radio Program** menu, press Channel Up on the remote to begin or Channel Down to abort. The TV will now search every available FM frequency and memorize frequencies that contain radio stations. NOTE: FM radio signals must be present on the coax input cable for the TV's FM radio feature to work properly.

Confirm FM Radio Program	
▪ Confirmation	▶
Exit: SETUP	
	Yes: ▲ No: ▼

Troubleshooting

Problem	CHECK
No Picture and No Sound	<ul style="list-style-type: none"> • Ensure the TV is connected to a powered AC outlet. The TV's front lamp will glow Red when correctly connected to power. • Operate the TV directly by pressing the TV's POWER button located on the side of the cabinet. • Try to cycle power to the TV by pulling the power cord from the AC outlet, wait for 30 seconds, plug it back into the outlet, wait 15 seconds or more and then try to turn On the TV again. • Set the Standby Power in the Features menu to Normal.
No Picture, Sound OK	<ul style="list-style-type: none"> • Verify TV is set to an active Video Source or set directly to TV by pressing the TV/AV button on the side of the TV or the TV/AV button on the remote control. • If an Auxiliary Input Source is selected, verify the Video input signal cable is connected and the video source is playing.
Picture OK, No Sound	<ul style="list-style-type: none"> • Verify the Sound has not been muted. • Check the Volume settings. • Verify pillow speaker is connected and the volume control on the pillow speaker is properly adjusted. • If an Auxiliary Input Source is selected, verify the Audio input signal cable is connected and the video source is playing.
No Sound from Internal TV Speaker	<ul style="list-style-type: none"> • Verify the sound has not been muted. • Verify the TV's internal speakers have not been disabled in the "Internal Speaker Enable" setup menu.
Picture is too Light	<ul style="list-style-type: none"> • Check that external light sources, such as windows or overhead lights are not creating glare on the TV's screen. • Check the TV's Brightness and Contrast settings in the TV's Picture menu.
Picture is too Dark	<ul style="list-style-type: none"> • Check the TV's Brightness and Contrast settings in the TV's Picture menu.
Picture Breaks-Up or Jitters	<ul style="list-style-type: none"> • Verify the coax cable is connected correctly. • The cable TV signal may be too weak.
Picture has Ghost Images	<ul style="list-style-type: none"> • The cable TV signal may be too weak. • The coax cable connection may be loose.
Picture has Stripes or Dots	<ul style="list-style-type: none"> • The cable TV signal may be too weak. • The coax cable connection may be loose.
Pillow Speaker does not Control TV	<ul style="list-style-type: none"> • Check the TV's Pillow Speaker Selector switch is correctly set. • Replace Pillow Speaker.
Remote Control does not work	<ul style="list-style-type: none"> • Replace the remote's batteries. • Verify that strong fluorescent lights are not flooding the TV's IR windows • For patient remote controls, verify remote is set to the correct Bed Code.

Cloning the TV - Saving Settings

The TV settings can be saved to a USB Flash Drive (user supplied) and then used to program another television. Please contact PDI should you require additional assistance.

SAVING A TV'S SETTINGS

1. Turn the TV On and insert the Flash Drive into the USB Clone port located on the TV's connector panel on the side of the TV. A Cloning Main Menu will appear when the USB Drive is properly installed.
2. From the **Cloning Main Menu**, select **Save Settings to USB Drive**.

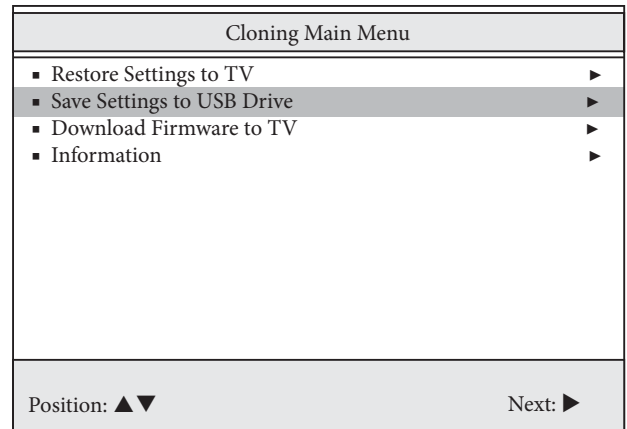

3. In the **Save Settings to USB Drive** menu, select the appropriate model. A confirmation menu will appear. NOTE: file names may appear different than those shown.

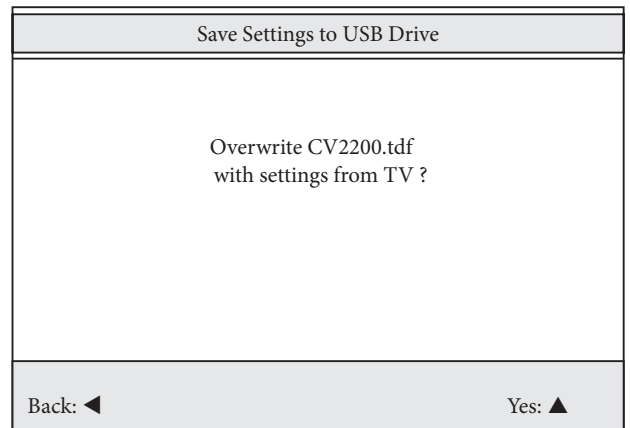

4. In the confirmation menu, select Channel Up for Yes to save the settings. Otherwise, press Volume Down to exit without saving the TV's setting.
5. The Flash Drive can now be removed and used to program another television with its settings.

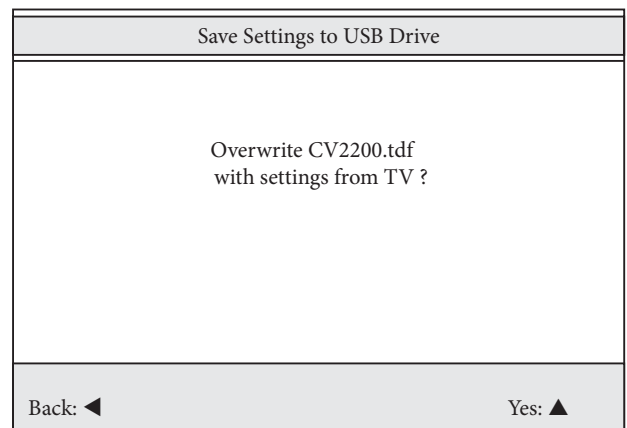

Cloning the TV - Restoring Settings

A TV's settings once saved to a USB Flash Drive (user supplied) can then be used to program another television. Please contact PDI should you require additional assistance.

RESTORE A TV'S SETTINGS

1. Turn the TV On and insert the Flash Drive into the USB Clone port. A Cloning Main Menu will appear when the Drive is properly installed.
2. From the **Cloning Main Menu**, select **Restore Settings to TV**.
3. In the **Restore Settings to TV** menu, select the appropriate model. A confirmation menu will appear.
4. In the confirmation menu, select Channel Up for Yes to restore the settings. Otherwise, press Volume Down to exit without restoring the TV's setting.
5. The Flash Drive can now be removed and the TV checked for correct programming.

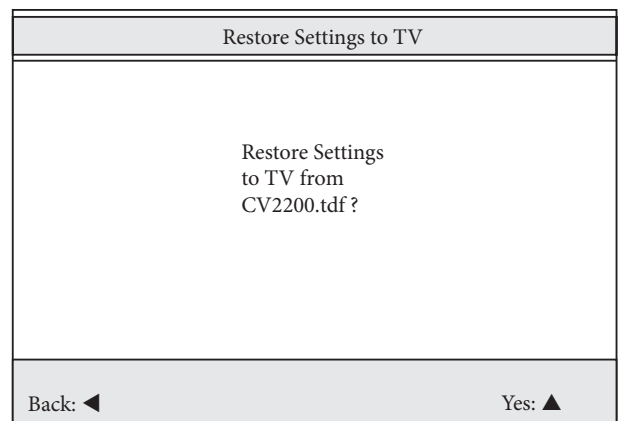
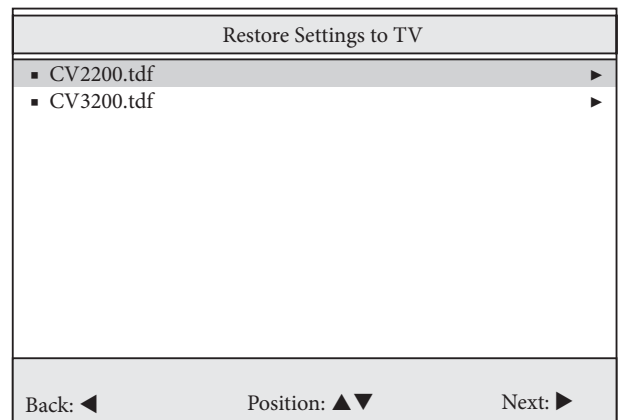
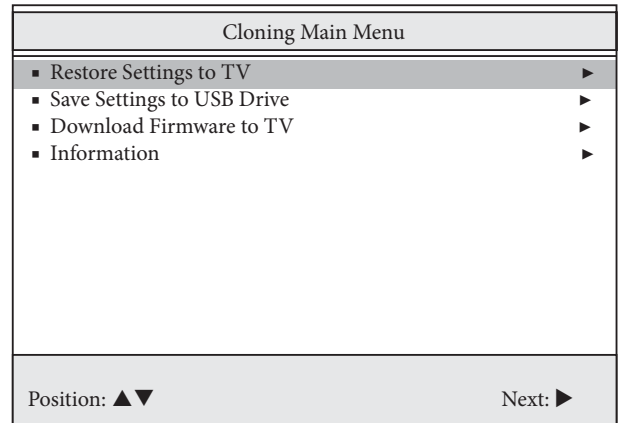

TV Menu Navigation

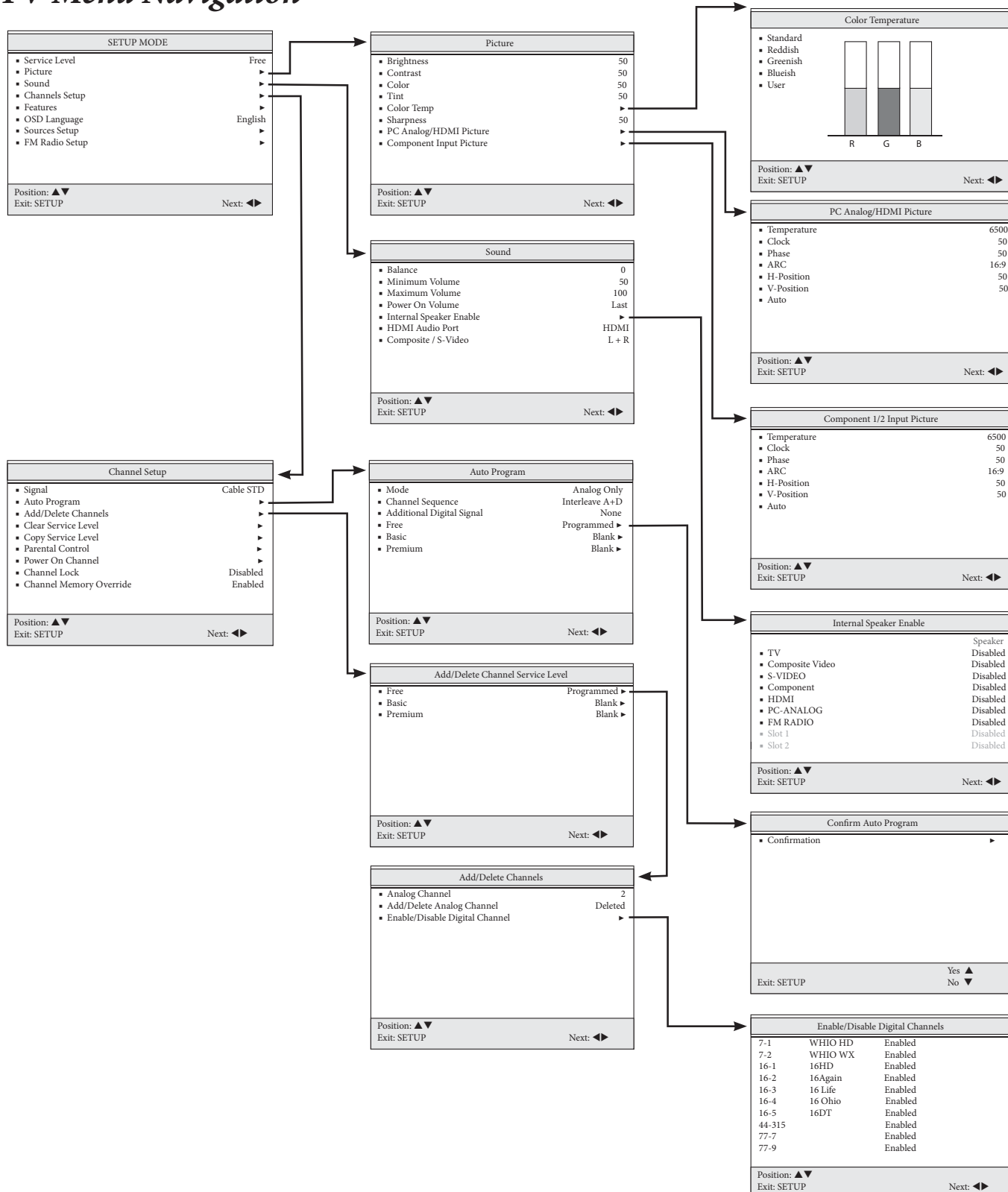

Sample Channel Listing Shown for Illustrative purposes. Actual Channel Listing will vary.

TV Menu Navigation- continued

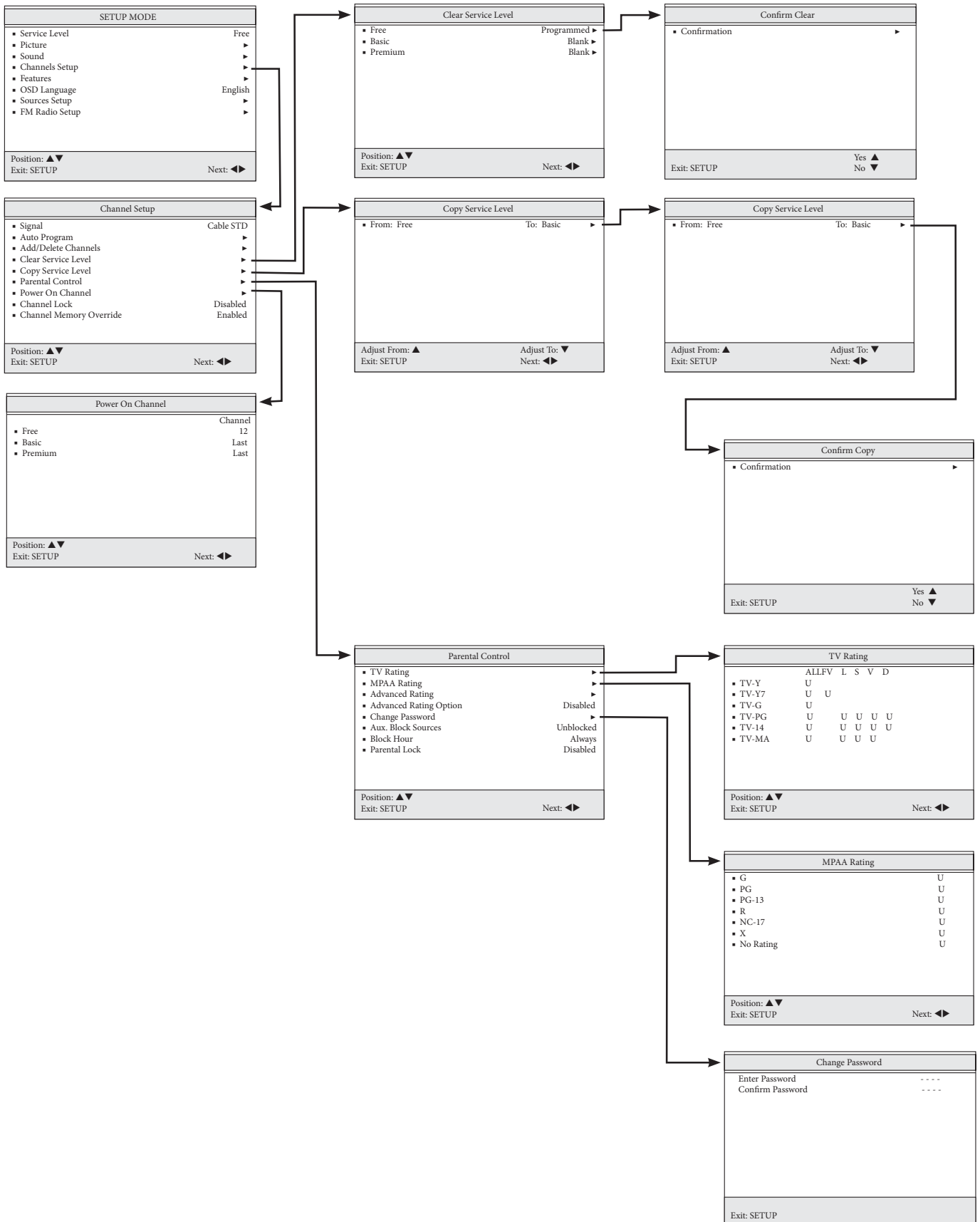

TV Menu Navigation- continued

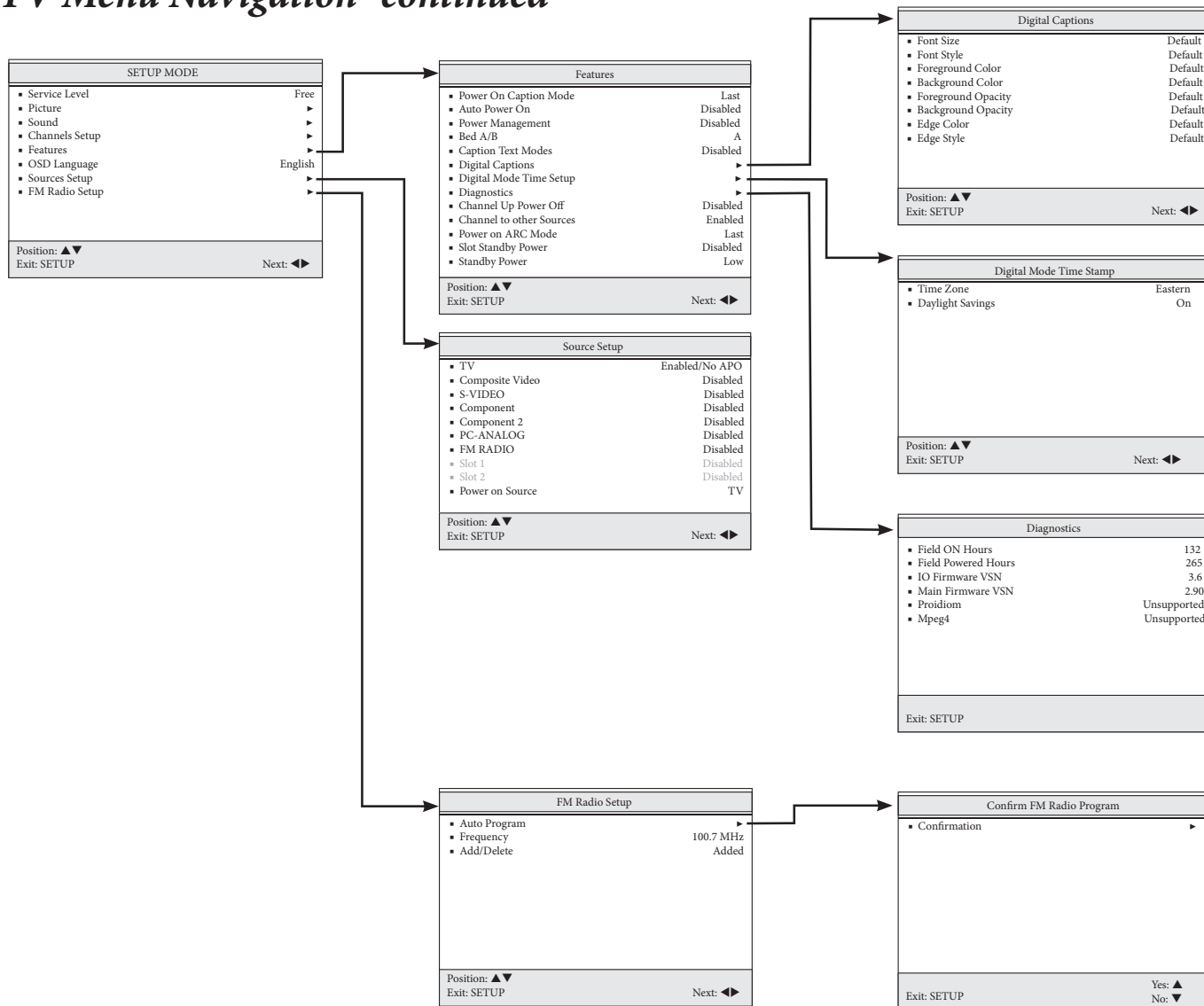

TV Menu Explanations

Menu	Item	Explanation	Sub-Item	Explanation
Setup				
	Service Level	3 programmable Service Levels (banks of channels) plus a Disable service level.		
	Picture	Adjusts picture appearance.	Brightness	Adjust the brightness of the dark areas in the picture. 50% is the default value.
			Contrast	Adjust the brightness of the light areas in the picture. 50% is the default value.
			Color	Adjust the strength of the color in the picture. 50% is the default value.
			Tint	Adjust the tint of the picture. 50% is the default value.
			Color Temperature	Opens a sub-menu that provides adjustment to the color balance of the picture.
			Sharpness	Adjust the amount of detail present in the picture. 50% is the default value.
			PC Analog/HDMI Picture	Opens a sub-menu that provides adjustment to the picture when the TV is used in computer mode. Temperature: Color warmth of picture. Clock: Adjust the horizontal screen size. Phase: Removes horizontal noise. ARC: Selects the screen size ratios. H-Position: Move Picture left or right. V-Position: Moves Picture up or down. Auto: Automatically adjust picture.
			Component Input Picture	Opens a sub-menu that provides adjustment to the picture when viewing a component signal. Temperature: Color warmth of picture. Clock: Adjust the horizontal screen size. Phase: Removes horizontal noise. ARC: Selects the screen size ratios. H-Position: Move Picture left or right. V-Position: Moves Picture up or down. Auto: Automatically adjust picture.
	Sound	Adjusts sound parameters.	Balance	Moves sound between the Left and Right Speakers.
			Minimum Volume	Sets a minimum sound level. The TV's sound level can not be adjusted below the minimum volume setting. The default value is 0.
			Maximum Volume	Sets a maximum sound level. The TV's sound level can not be adjusted above the maximum volume setting. The default value is 100.
			Power On Volume	Sets an initial sound level when the TV is first turned on. The default value is LAST.
			Internal Speaker Enable	Opens a sub-menu that provide Disabling/Enabling the TV's internal speakers. Items are shown in the default setting. TV Enabled Composite Video Enabled S-VIDEO Enabled Component Enabled HDMI Enabled PC-Analog Enabled FM Radio Enabled Slot1 Disabled Slot2 Disabled
			HDMI Audio Port	Audio Ports HDMI, PC-ANALOG, and COMPONENT can be selected as an HDMI Audio port.
			Composite/S-Video Sound Mode	Sets sound for Stereo (L+R), Left (L+L), or Right (R+R).

TV Menu Explanations - continued

Menu	Item	Explanation	Sub-Item	Explanation
Channel Setup		Programs different channels and sources into each of the 3 service levels		
	Signal	Sets the TV to tune 1 of 4 different signal styles: Air, Cable STD, Cable IRC, Cable HRC		
	Auto Program	TV automatically scans for active channels and memorizes them into the selected service level.	Mode	Scan for "Analog Only", "Digital Only", or "Analog and Digital" channels.
			Channel Sequence	Set the sequence in which the TV displays channels. Interleave A+D, Analog and Digital appear grouped together. All A then D, Analog appear first, followed by Digital.
			Additional Digital Signal	Provides a second auto search for channels using a different signal type. None Disabled Air Antenna Tuning Cable STD Standard Cable Cable IRC Incremental Related Cable Cable HRC Harmonic Relate Cable
	Free	One of three different service levels (channel banks) used to hold different groupings of channels.	Confirm Auto Program	Begins the Auto Program process. Auto Program requires 2 to 12 minutes to complete.
	Basic	One of three different service levels (channel banks) used to hold different groupings of channels.	Confirm Auto Program	Begins the Auto Program process. Auto Program requires 2 to 12 minutes to complete.
	Premium	One of three different service levels (channel banks) used to hold different groupings of channels.	Confirm Auto Program	Begins the Auto Program process. Auto Program requires 2 to 12 minutes to complete.
Add/Delete Channels		Add or Delete Channels from a Service Level.		
	Free	Selects the Free service level edit menu.		
	Basic	Selects the Basic service level edit menu.		
	Premium	Selects the Premium service level edit menu.		
			Analog Channel	Selects the channel to be edited.
			Add/Delete Analog Channel	Sets the indicated Analog channel to either "Deleted" or "Added".
			Enable/Disable Digital Channel	Displays a list of auto programmed Digital Channels. Each channel can be "Enabled" or "Disabled" for viewing.
Clear Service Level		Erase the programmed channels from a service level. "Blank" indicates an empty service level.		
	Free	Selects the Free Service level to Clear.	Confirm Clear	Confirmation Menu before clearing service level.
	Basic	Selects the Basic Service level to Clear.	Confirm Clear	Confirmation Menu before clearing service level.
	Premium	Selects the Premium Service level to Clear.	Confirm Clear	Confirmation Menu before clearing service level.
Copy Service Level		Copy an existing service level to a destination service level.		
	From:	Sets the service level to be copied.		
	To:	Sets the service level to be programmed.		
			Confirm Copy	Confirmation Menu to before copying service levels.

TV Menu Explanations - continued

Menu	Item	Explanation	Sub-Item	Explanation
Parental Control		Control Access of TV and Movie content.		
	TV Rating	Displays a list of parental TV viewing levels and allows for Blocking or Unblocking of TV content.		
	MPAA Rating	Displays a list of parental Movie viewing levels and allows for Blocking or Unblocking of Movie content.		
	Advanced Rating	Digital TV content Rating levels listing menu.		
	Advanced Rating Option	Enable or Disable the Advanced Rating menu for digital TV content.		
	Change Password	Displays a menu and allows creation of a new parental password.		
	Aux. Block Sources	Enable or Disable the Aux. Block Source item to restrict program content inputted through the TV's auxiliary inputs.		
	Block Hours	Sets the number of hours the parental lock is enabled.		
	Parental Lock	Enable or Disable the settings in the Parental Control menus.		
Power On Channel		TV displays a preset TV channel upon initial powering for each service level.	Free	TV powers on to this set channel number. Entering "Last" causes the TV to power on to the last channel viewed.
			Basic	TV powers on to this set channel number. Entering "Last" causes the TV to power on to the last channel viewed.
			Premium	TV powers on to this set channel number. Entering "Last" causes the TV to power on to the last channel viewed.
Channel Lock		Enable or Disable the Channel Lock feature. When Enabled the TV is locked to the last channel viewed. Prevents the TV from being tuned to any other channel or source. Disabled allows the TV to be tuned to other channels.		
Channel Memory Override		Enable means the TV will tune to all possible channels. Disable means the TV can only be tuned to channels in the currently selected service level.		
Features				
	Power on Caption Mode	Sets the Caption mode TV when the powers On. Off = TV powers on with captions disabled. Last = TV powers on in last caption setting.		
	Auto Power On	TV remains in On condition and can not be turned Off except by interrupting AC power.		
	Power Management	TV turns Off after a preset time of inactivity. Adjustable by 10 minute increments or Disable.		
	Bed A / B	TV Bed A or Bed B seletable IR codes for independent control of a single TV in a 2 television room. Patient remote is set to corresponding Bed code..		
	Caption Text Mode	Teletext function, Normally Disabled for US.		

TV Menu Explanations - continued

Menu	Item	Explanation	Sub-Item	Explanation
Features				
	Digital Captions	Customize the look of captions when tuned to a digital channel.	Mode	Default or Custom. Custom enables additional menu items.
			Font	Default, Style 0 thru Style 7
			Size	Default, Normal, Large, Small
			FG Color	Foreground color: Default, White, Black, Red, Green, Blue, Yellow, Magenta, Cyan
			BG Color	Background Color: Default, White, Black, Red, Green, Blue, Yellow, Magenta, Cyan
			FG Opacity	Default, Solid, Translucent, Transparent, Flashing
			BG Opacity	Default, Solid, Translucent, Transparent, Flashing
	Digital Mode Time Setup	Timing information provided by Digital channels can be set to the specific Time Zone and also Daylight Savings.	Time Zone	Sets the current Time zone to +0 (Newfoundland), Eastern, Central, Mountain, Pacific, Alaska, Hawaii.
			Daylight Saving	Turns Daylight Saving On or Off.
	Diagnostics	A display menu that provides a readout of the TV's internal operations.	Field ON Hours	Readout of the number of hours the TV has been turned On.
			Field Power Hours	Readout of the number of hours the TV has been plugged into a powered outlet.
			IO Firmware VSN	IO firmware version resident inside the TV.
			Main Firmware VSN	Main firmware version resident inside the TV.
	Channel Up Power Off	When Enabled the TV shuts off when it reaches the highest channel.		
	Channel to Other Sources	When Enabled the External sources connected to the TV appear in the TV's channel listing. If Disabled the External sources do not appear in the TV's channel listing.		
	Power on ARC Mode	The TV can be set to turn On with a specific picture Aspect Ratio: Last, 4:3, 14:9, 16:9, and 16:9 Panorama.		
	Slot Standby Power	Enable or Disable Slot power to run externally connected options.		
	Standby Power	TV's standby power can be set for Low power consumption or Normal.		
OSD Language		The menu system On Screen Display language settings are English, Spanish, and French		
Sources		The individual auxiliary input connectors on the back of the TV can be turned On or Off. The source can also be set to Auto Power Off (APO) after 5 minutes of a no signal condition.	TV	Disabled, Enabled/APO, Enabled/No APO
			Composite Video	Disabled, Enabled/APO, Enabled/No APO
			S-VIDEO	Disabled, Enabled/APO, Enabled/No APO
			Component	Disabled, Enabled/APO, Enabled/No APO
			HDMI	Disabled, Enabled/APO, Enabled/No APO
			PC-ANALOG	Disabled, Enabled/APO, Enabled/No APO
			FM RADIO	Disabled, Enabled/APO, Enabled/No APO
			Slot 1	Disabled, Enabled
			Slot 2	Disabled, Enabled
			Power On Source	Last, (Any Enabled Source)

TV Menu Explanations - continued

Menu	Item	Explanation	Sub-Item	Explanation
Setup				
	FM Radio	FM Radio Setup menu	Auto Program	Automatic search for FM radio stations present on the connected coax cable.
			Frequency	User selectable Frequency
			Add/Delete	Add or Delete a Frequency

PDI Limited Warranty

PDI Communication Systems (PDI) warrants this product, except as set forth below, ONLY TO THE ORIGINAL PURCHASER to be FREE FROM DEFECTIVE MATERIAL AND WORKMANSHIP from the date of original purchase for a period of 2 years for parts and 2 years for labor (“The Warranty Period”). THIS LIMITED WARRANTY IS VALID ONLY IN THE FIFTY (50) UNITED STATES, THE DISTRICT OF COLUMBIA, AND CANADA.

If this product is found to be defective, PDI will repair or replace defective parts at no charge to the original owner during the warranty period. Such repair and replacement services shall be rendered by PDI or a PDI Authorized Servicer during normal business hours. Parts used for replacement or repair are warranted only for the remainder of the Warranty Period.

To return a product for service please obtain a Return Material Authorization (RMA) from PDI. Products returned without a RMA will not be serviced.

WHAT IS NOT COVERED

This limited warranty provided by PDI does NOT cover:

1. Product which has been subject to abuse, accident, alteration, modification, tampering, negligence, misuse, faulty installation, lack of reasonable care, or if affixed to any attachment not specified for the product;
2. Product that has either the model number or serial number altered, tampered with, defaced or removed;
3. Initial installation and removal for repair;
4. Operational adjustments covered in the Owner’s Manual, normal maintenance, and cleaning;
5. Damage that occurs in shipment, due to act of God, and cosmetic damage;
6. Signal reception problems and failures due to line power surge;
7. The cost for shipping the product to PDI’s service center;
8. Accessories;
9. Batteries;

There are no expressed warranties except as listed above.

THE DURATION OF ANY IMPLIED WARRANTIES, INCLUDING THE IMPLIED WARRANTY OF MERCHANTABILITY, IS LIMITED TO THE DURATION OF THE EXPRESSED WARRANTY HEREIN. PDI SHALL NOT BE LIABLE FOR THE LOSS OF USE OF THE PRODUCT, INCONVENIENCE, LOSS OR ANY OTHER DAMAGES, WHETHER DIRECT, INCIDENTAL OR CONSEQUENTIAL RESULTING FROM THE USE OF THIS PRODUCT, OR ARISING OUT OF ANY BREACH OF THIS WARRANTY. ALL EXPRESSED AND IMPLIED WARRANTIES, INCLUDING THE WARRANTIES OF MERCHANTABILITY AND FITNESS FOR A PARTICULAR PURPOSE, ARE LIMITED TO THE WARRANTY PERIOD SET FORTH ABOVE.

Some states do not allow the exclusion of incidental or consequential damages or limitations on how long an implied warranty lasts, so these limitations or exclusions may not apply to you. This warranty gives you specific legal rights and you may also have other rights which vary from state to state.

Refurbished products carry a separate warranty. This warranty does not apply. For details of refurbished product warranty, please refer to the refurbished product warranty information packaged with each refurbished product.

PDI Communication Systems, Inc.
40 Greenwood Lane
Springboro, Ohio 45066

PH: 937-743-6010 FX: 937-743-5664



PDI Communication Systems, Inc.
40 Greenwood Lane
Springboro, Ohio 45066

Document Number: PD196-171R1.DOC