



REVIEW DRAFT - CISCO CONFIDENTIAL



Cisco IP Phone 8811, 8841, 8845, 8851, 8851NR, 8861, and 8865 User Guide for Cisco Unified Communications Manager 11.0

First Published: February 17, 2015

Americas Headquarters

Cisco Systems, Inc.
170 West Tasman Drive
San Jose, CA 95134-1706
USA
<http://www.cisco.com>
Tel: 408 526-4000
800 553-NETS (6387)
Fax: 408 527-0883

THE SPECIFICATIONS AND INFORMATION REGARDING THE PRODUCTS IN THIS MANUAL ARE SUBJECT TO CHANGE WITHOUT NOTICE. ALL STATEMENTS, INFORMATION, AND RECOMMENDATIONS IN THIS MANUAL ARE BELIEVED TO BE ACCURATE BUT ARE PRESENTED WITHOUT WARRANTY OF ANY KIND, EXPRESS OR IMPLIED. USERS MUST TAKE FULL RESPONSIBILITY FOR THEIR APPLICATION OF ANY PRODUCTS.

THE SOFTWARE LICENSE AND LIMITED WARRANTY FOR THE ACCOMPANYING PRODUCT ARE SET FORTH IN THE INFORMATION PACKET THAT SHIPPED WITH THE PRODUCT AND ARE INCORPORATED HEREIN BY THIS REFERENCE. IF YOU ARE UNABLE TO LOCATE THE SOFTWARE LICENSE OR LIMITED WARRANTY, CONTACT YOUR CISCO REPRESENTATIVE FOR A COPY.

The following information is for FCC compliance of Class A devices: This equipment has been tested and found to comply with the limits for a Class A digital device, pursuant to part 15 of the FCC rules. These limits are designed to provide reasonable protection against harmful interference when the equipment is operated in a commercial environment. This equipment generates, uses, and can radiate radio-frequency energy and, if not installed and used in accordance with the instruction manual, may cause harmful interference to radio communications. Operation of this equipment in a residential area is likely to cause harmful interference, in which case users will be required to correct the interference at their own expense.

The following information is for FCC compliance of Class B devices: This equipment has been tested and found to comply with the limits for a Class B digital device, pursuant to part 15 of the FCC rules. These limits are designed to provide reasonable protection against harmful interference in a residential installation. This equipment generates, uses and can radiate radio frequency energy and, if not installed and used in accordance with the instructions, may cause harmful interference to radio communications. However, there is no guarantee that interference will not occur in a particular installation. If the equipment causes interference to radio or television reception, which can be determined by turning the equipment off and on, users are encouraged to try to correct the interference by using one or more of the following measures:

- Reorient or relocate the receiving antenna.
- Increase the separation between the equipment and receiver.
- Connect the equipment into an outlet on a circuit different from that to which the receiver is connected.
- Consult the dealer or an experienced radio/TV technician for help.

Modifications to this product not authorized by Cisco could void the FCC approval and negate your authority to operate the product

The Cisco implementation of TCP header compression is an adaptation of a program developed by the University of California, Berkeley (UCB) as part of UCB's public domain version of the UNIX operating system. All rights reserved. Copyright © 1981, Regents of the University of California.

NOTWITHSTANDING ANY OTHER WARRANTY HEREIN, ALL DOCUMENT FILES AND SOFTWARE OF THESE SUPPLIERS ARE PROVIDED "AS IS" WITH ALL FAULTS. CISCO AND THE ABOVE-NAMED SUPPLIERS DISCLAIM ALL WARRANTIES, EXPRESSED OR IMPLIED, INCLUDING, WITHOUT LIMITATION, THOSE OF MERCHANTABILITY, FITNESS FOR A PARTICULAR PURPOSE AND NONINFRINGEMENT OR ARISING FROM A COURSE OF DEALING, USAGE, OR TRADE PRACTICE.

IN NO EVENT SHALL CISCO OR ITS SUPPLIERS BE LIABLE FOR ANY INDIRECT, SPECIAL, CONSEQUENTIAL, OR INCIDENTAL DAMAGES, INCLUDING, WITHOUT LIMITATION, LOST PROFITS OR LOSS OR DAMAGE TO DATA ARISING OUT OF THE USE OR INABILITY TO USE THIS MANUAL, EVEN IF CISCO OR ITS SUPPLIERS HAVE BEEN ADVISED OF THE POSSIBILITY OF SUCH DAMAGES.

Any Internet Protocol (IP) addresses and phone numbers used in this document are not intended to be actual addresses and phone numbers. Any examples, command display output, network topology diagrams, and other figures included in the document are shown for illustrative purposes only. Any use of actual IP addresses or phone numbers in illustrative content is unintentional and coincidental.

Cisco and the Cisco logo are trademarks or registered trademarks of Cisco and/or its affiliates in the U.S. and other countries. To view a list of Cisco trademarks, go to this URL: <http://www.cisco.com/go/trademarks>. Third-party trademarks mentioned are the property of their respective owners. The use of the word partner does not imply a partnership relationship between Cisco and any other company. (1110R)

© 2015 Cisco Systems, Inc. All rights reserved.



CONTENTS

CHAPTER 1

Getting Started 1

- Accessibility Features 1
- Cisco IP Phone 8811 1
 - Phone Connections 1
 - Buttons and Hardware 3
- Cisco IP Phone 8841 6
 - Phone Connections 6
 - Buttons and Hardware 8
- Cisco IP Phone 8845 11
 - Phone Connections 11
 - Buttons and Hardware 12
- Cisco IP Phone 8851 and 8851NR 14
 - Phone Connections 14
 - Buttons and Hardware 16
- Cisco IP Phone 8861 19
 - Phone Connections 19
 - Buttons and Hardware 21
- Cisco IP Phone 8865 24
 - Phone Connections 24
 - Buttons and Hardware 25
- Power Save and Power Save Plus 27
 - Power Save 27
 - Power Save Plus 28
- Additional Information 28

CHAPTER 2

Phone Setup 29

- Connect Footstand 29
- Adjust the Handset Rest 30

REVIEW DRAFT - CISCO CONFIDENTIAL

Secure the Phone with a Cable Lock 30

CHAPTER 3**Basic Operations 33**

Clean the Phone Display 33

Make Calls 34

 Redial a Number 34

 Place a Call Using the Speakerphone 34

 Place a Call Using a Headset 35

 Release a Call and Start Another Call 35

 Dial an International Number 35

 Redial a Number 36

Navigate and Select Items 36

View All Calls on the Phone 37

Answer Calls 37

 Answer the Oldest Call First 38

 Call Pickup 38

 Answer a Call Using PickUp 39

 Answer a Call Using Group PickUp and a Phone Number 40

 Answer a Call Using Group PickUp and a Group PickUp Number 40

 Answer a Call Using Other PickUp 41

Automatically Answer Calls 41

Respond to a Call Waiting Notification 42

Manage Calls 42

 Decline a Call 42

 Transfer a Call to Another Number 43

 Toggle Between Calls Before Completing a Transfer 43

 Monitor and Record Calls 44

Call Forward 44

 Forward All Calls 44

Mute Phone 45

Hold Calls 45

 Swap Between Active and Held Calls 45

 Put a Call on Hold by Answering a New Call 46

 Respond to a Hold Reversion Notification 46

 Determine If a Shared Line Is On Hold 46

REVIEW DRAFT - CISCO CONFIDENTIAL

Remote Hold	46
Set Up Call Back Notification	47
Call Park	47
Park and Retrieve a Call Using Call Park	48
Park a Call Using Assisted Directed Call Park	48
Park a Call Using Manual Directed Call Park	49
Manage Intercom Calls	49
Place a Dedicated Intercom Call	49
Place a Dialable Intercom Call	50
Receive an Intercom Call	50
View Phone Information	50
Video Calls	51
Hide or Show Video	51
Hide Softkeys in Full-Screen Video	51
Enable Full Screen Video	52
Mute Video	52
Swap Views	52
Adjust Picture-In-Picture Position	53
Sign In To the Cisco Unified Communications Self Care Portal	53

CHAPTER 4

Contacts	55
Corporate Directory	55
Search and Dial a Contact	55
Search and Dial a Contact While On a Call	56
Personal Directory	56
Sign In and Out of the Personal Directory	57
Add a Personal Directory Entry from the Phone	57
Search for an Entry in the Personal Directory	57
Dial a Number from the Personal Directory	58
Edit a Personal Directory Entry	58
Delete a Personal Directory Entry	59
Fast Dial	59
Place a Call With a Fast-Dial Button	59
Fast-Dial Codes with Personal Directory	59
Assign a Fast Dial Code to a Personal Directory Entry	60

REVIEW DRAFT - CISCO CONFIDENTIAL

Place a Call Using a Fast Dial Code 60

Delete a Fast Dial Code 60

Cisco WebDialer 61

Use Cisco WebDialer with Another Online Corporate Directory 61

Change Cisco WebDialer Preferences 61

Sign Out of Cisco WebDialer 62

CHAPTER 5**Call History 63**

Call History Overview 63

View the Call History 65

View Call Record Details 65

Filter the Call History 65

Dial From the Call History 66

Edit a Phone Number 66

Clear the Call History 67

Delete a Call Record 67

CHAPTER 6**Voicemail 69**

Access Voicemail 69

Check for Voice Messages 69

Listen to Voice Messages 70

Visual Voicemail 70

CHAPTER 7**Advanced Calling Features 73**

Conference 73

Add a Third Party to a Conference 74

Join Calls Into a Conference 74

Swap Between Calls Before Completing a Conference 74

View Conference Participants 75

Remove Conference Participants 75

Meet Me Conference 75

Host a Meet Me Conference 76

Join a Meet Me Conference 76

Speed Dial 76

Place a Call with a Speed-Dial Button 77

REVIEW DRAFT - CISCO CONFIDENTIAL

Use a Speed-Dial Code On Hook	77
Use a Speed-Dial Code Off Hook	77
Pause in Speed Dial	77
Do Not Disturb	78
Turn DND On and Off	79
Malicious Call Identification	79
Trace a Suspicious Call	79
Extension Mobility	79
Enable Extension Mobility	80
Mobile Connect	80
Enable Mobile Connect	81
Turn Mobile Connect On or Off for All Remote Destinations from a Desk Phone	81
Switch a Desk Phone Call to a Mobile Phone	81
Switch a Mobile Call to the Desk Phone	81
Hand Off a Call from a Mobile Phone to the Desk Phone	82
Line Status	82
Line Status Indicators	82
Custom Line Filters	83
Add a Line Filter	84
Select an Active Line Filter	84
Delete a Line Filter	84
Duplicate a Line Filter	85
Edit a Line Filter	85
Rename a Line Filter	86
Hunt Groups	86
Sign In and Out of a Hunt Group	86
Display Queue Statistics	87
Barge	87
Set Up Barge Alert	87
Add Yourself to a Call on a Shared Line	87
Enable Privacy on a Shared Line	87
Dismiss the Barge Alert Prompt Window	88
Call Chaperone	88
Record a Chaperoned Call	89
Uniform Resource Identifier Dialing	89

REVIEW DRAFT - CISCO CONFIDENTIAL

Intelligent Proximity for Mobile Devices	90
Pair a Mobile Device	91
Switch Connected Mobile Devices	91
Delete a Mobile Device	92
Answer a Mobile Call	92
Decline a Mobile Call	92
Ignore a Mobile Call	92
Place a Mobile Call	93
Move a Call Between the IP Phone and a Mobile Phone	93
Adjust the Mobile Device Volume	93
Mobile Contacts and Mobile Call History Sharing	93
Synchronize Bluetooth Contacts	94
Save Bluetooth Contacts	94
Delete Bluetooth Contacts	94
Intelligent Proximity for Tablets	94
Pair a Tablet	95
Move Audio from the Tablet to the Phone	95
Manage Tablet Audio on Phone	96
<hr/>	
CHAPTER 8	Advanced Operations 97
Applications	97
View Active Applications	97
Switch to Active Applications	98
Close Active Applications	98
Mobile and Remote Access Through Expressway	98
Phone Features Available for Mobile and Remote Access Through Expressway	99
Sign in with Mobile and Remote Access Through Expressway	100
Cisco Collaboration Problem Reporting Tool	101
Report a Problem with Cisco Collaboration Problem Reporting Tool	101
Set Up a VPN Phone for Mobile and Remote Access Through Expressway	102
Set Up a Phone for Use with VPN	102
Turn Off the Alternate TFTP Server	103
Video Calls and Security	103
Call Functions	104
Agent Greeting	104

REVIEW DRAFT - CISCO CONFIDENTIAL

- Alert Calls 104
- Actionable Incoming Call Alert 104
- Answer 104
- Client Matter Code 105
- Forced Authorization Code 105
- Secure and Nonsecure Indication Tones 105
- Shared Lines 106
- Feature Buttons and Softkey 106
- Survivable Remote Site Telephony Overview 108

CHAPTER 9**User Preferences 111**

- Change the Wallpaper 111
- Change the Ringtone 112
- Adjust the Phone Screen Brightness 112
- Adjust Phone Screen Contrast 112
- Change the Font Size 113
- Change the Phone Name 114
- Adjust the Headset Sidetone 114
- Phone Services 115
- Line Settings 115

CHAPTER 10**Cisco Unified Video Camera 117**

- Install Cisco Unified Video Camera 117
 - Mount Camera on Phone 117
 - Mount Camera on Monitor 118
- View Camera Details 119
- Cisco Unified Video Camera Features 119
- Camera Lens Shutter 120
 - Close Camera Lens Shutter 121
- Camera Preferences 121
 - Enable Auto Transmit 121
 - Adjust Camera Brightness 122
 - Adjust Camera View Area 122
 - Access Preview Video 123
 - Enable Video 123

REVIEW DRAFT - CISCO CONFIDENTIAL

Reset Camera **124**

CHAPTER 11**Accessories 125**

Accessory List **125**

View the Accessories List **126**

View Accessories Details **126**

USB Devices **127**

Mobile Device Charging **127**

Set Up Wideband for an Analog Headset **128**

Bluetooth Headsets **129**

Add a Bluetooth Accessory **130**

Connect a Bluetooth Accessory **130**

Turn On Bluetooth **131**

Disconnect a Bluetooth Accessory **131**

Delete a Bluetooth Accessory **131**

USB Headsets **132**

Cisco IP Phone 8800 Key Expansion Module **132**

Cisco IP Phone 8800 Key Expansion Module Features **133**

Place a Call on the Key Expansion Module **136**

Configure KEM Buttons **136**

Adjust Key Expansion Module Brightness **137**

CHAPTER 12**Frequently Asked Questions 139**

Why Can't I See All Active Calls on My Phone? **140**

How Do I Redirect an Incoming Call? **140**

How Do I Silence a Ringing Call If I'm On a Call? **140**

How Do I Resume a Call That is On Hold? **140**

What Is the Difference Between Buttons on the Left and Those on the Right of the Screen? **141**

Why Do Softkeys Keep Changing? **141**

What Is the Best Way to Look at Calls When I Have a Shared Line or Multiple Lines? **141**

What Should I Do If I Accidentally Press a Button While on a Call? **142**

How Do I Check Missed Calls? **142**

How Do I Exit from a Running Application? **142**

How Do I Connect Two Calls and then Drop from the Line Myself? **143**

REVIEW DRAFT - CISCO CONFIDENTIAL

What Does the Swap Softkey Do?	143
How Do I Cancel a Conference or Transfer After I Start It?	143
How Can I Combine Two Calls Into a Single Conference Call?	144
Why Does My Phone Not Wake Up?	144
What Do Four Rings in Succession Mean?	144
Where Should I Mount My Cisco Unified Video Camera?	145
How Can I Prevent Theft of my Cisco Unified Video Camera?	145
Why Do Some Calls Not Present Video On My Video Phone?	145
What Happens to Video When I Put a Call On Hold?	146
What Do the Light Colors on My Cisco Unified Video Camera Indicate?	146
How Do I Close the Shutter on my Cisco Unified Video Camera?	146
Why Does the Video on my Cisco Unified Video Camera Appear Too Dark?	146

CHAPTER 13**Troubleshooting 149**

Missing Alert Calls Button	149
Missing All Calls Button	149
Missing Mobile and Remote Access through Expressway Sign-in Window	150
Cannot Sign In to Personal Directory	150
Cannot Access Self Care Portal	151
Security Error Message	151
Report Phone Problems	151
Documentation, Service Requests, and Additional Information	152

CHAPTER 14**Product Safety and Security 153**

Safety and Performance Information	153
Power Outage	153
External Devices	153
Bluetooth Wireless Headset Performance	154
Power Information	154
FCC Compliance Statements	154
FCC Part 15.21 Statement	154
FCC RF Radiation Exposure Statement	154
FCC Receivers and Class B Digital Statement	155
Cisco Product Security Overview	155

REVIEW DRAFT - CISCO CONFIDENTIAL

CHAPTER 15

Warranty 157

Cisco One-Year Limited Hardware Warranty Terms **157**



Getting Started

- [Accessibility Features](#), page 1
- [Cisco IP Phone 8811](#), page 1
- [Cisco IP Phone 8841](#), page 6
- [Cisco IP Phone 8845](#), page 11
- [Cisco IP Phone 8851 and 8851NR](#), page 14
- [Cisco IP Phone 8861](#), page 19
- [Cisco IP Phone 8865](#), page 24
- [Power Save and Power Save Plus](#), page 27
- [Additional Information](#), page 28

Accessibility Features

Cisco IP Phones provide accessibility features for the vision impaired, the blind, and the hearing and mobility impaired.

For detailed information about the accessibility features on these phones, see <http://www.cisco.com/c/en/us/support/collaboration-endpoints/unified-ip-phone-8800-series/products-technical-reference-list.html>.

You can also find more information about accessibility at this Cisco website:

<http://www.cisco.com/web/about/responsibility/accessibility/index.html>

Cisco IP Phone 8811

The following sections describe attributes of the Cisco IP Phone 8811.

Phone Connections

Connect your phone to the corporate IP telephony network, using the following diagram.

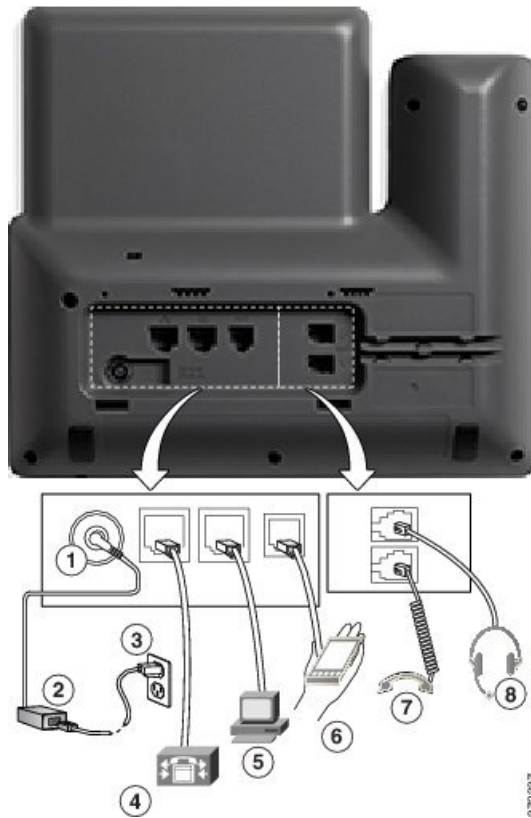
REVIEW DRAFT - CISCO CONFIDENTIAL

1	DC adaptor port (DC48V).	5	Access port (10/100/1000 PC) connection.
2	AC-to-DC power supply (optional).	6	Auxiliary port.
3	AC power wall plug (optional).	7	Handset connection.
4	Network port (10/100/1000 SW) connection. IEEE 802.3at power enabled.	8	Analog headset connection (optional).

**Note**

The Cisco IP Phone 8811 does not support the Cisco IP Phone 8800 Key Expansion Module.





REVIEW DRAFT - CISCO CONFIDENTIAL

Buttons and Hardware











1	Handset light strip	Indicates an incoming call (flashing red) or new voice message (steady red).
2	Phone screen	Shows information about your phone such as directory number, active call and line status, softkey options, speed dials, placed calls, and phone menu listings. The Cisco IP Phone 8811 screen is grayscale.



REVIEW DRAFT - CISCO CONFIDENTIAL

3	Programmable feature buttons and Session buttons 	<p>Your phone provides quick access to your phone lines, features, and call sessions:</p> <ul style="list-style-type: none"> • Programmable feature buttons (left side): Use to view calls on a line or access features such as Speed Dial or All Calls. These buttons are also called feature buttons. • Session buttons (right side): Use to perform tasks such as answering a call, resuming a held call, or (when not being used for an active call) initiating phone functions such as displaying missed calls. Each call on your phone is associated with a session button. <p>Note If you are using a locale that reads right to left, such as Arabic, the line button and session button locations are swapped. Depending on how your system administrator sets up the phone, the buttons provide access to:</p> <ul style="list-style-type: none"> • Phone lines and intercom lines • Speed-dial numbers (speed-dial buttons, including the Line Status speed-dial features) • Web-based services (for example, a Personal Address Book button) • Call features (for example, a Privacy button) <p>Buttons illuminate to indicate status:</p> <ul style="list-style-type: none"> • Green, steady: Active call or two-way intercom call • Green, flashing: Held call • Amber, steady: Privacy in use, one-way intercom call, DND active, or logged into Hunt Group • Amber, flashing: Incoming call or reverting call • Red, steady: Remote line in use (shared line or Line Status) • Red, flashing: Remote line on hold
4	Softkey buttons 	Depending on how your system administrator sets up the phone, enable softkey options displayed on your phone screen.
5	Navigation cluster and Select button 	The Navigation cluster and Select button allows you to scroll through menus, highlight items, and select the highlighted item.
6	Release Button 	Ends a connected call or session.

REVIEW DRAFT - CISCO CONFIDENTIAL

7	Hold/Resume button 	Places an active call on hold and resumes the held call.
8	Conference button 	Creates a conference call.
9	Transfer button 	Transfers a call.
10	Speakerphone button 	Toggles the speakerphone on or off. When the speakerphone is on, the button is lit.
11	Mute button 	Toggles the microphone on or off. When the microphone is muted, the button is lit.
12	Headset button 	Toggles the headset on or off. When the headset is on, the button is lit.
13	Keypad	Allows you to dial phone numbers, enter letters, and select menu items (by entering the item number).
14	Volume button 	Controls the handset, headset, and speakerphone volume (off hook) and the ringer volume (on hook).
15	Contacts button 	Opens or closes the Directories menu. Use the Contacts button to access personal and corporate directories.
16	Applications button 	Opens or closes the Applications menu. Use the Applications button to access call history, user preferences, phone settings, and phone model information.

REVIEW DRAFT - CISCO CONFIDENTIAL

17	Messages button 	Autodials your voice messaging system (varies by system).
18	Back button 	Returns to the previous screen or menu.
19	Handset	Phone handset.

Cisco IP Phone 8841

The following sections describe attributes of the Cisco IP Phone 8841.

Phone Connections

Connect your phone to the corporate IP telephony network, using the following diagram.

REVIEW DRAFT - CISCO CONFIDENTIAL

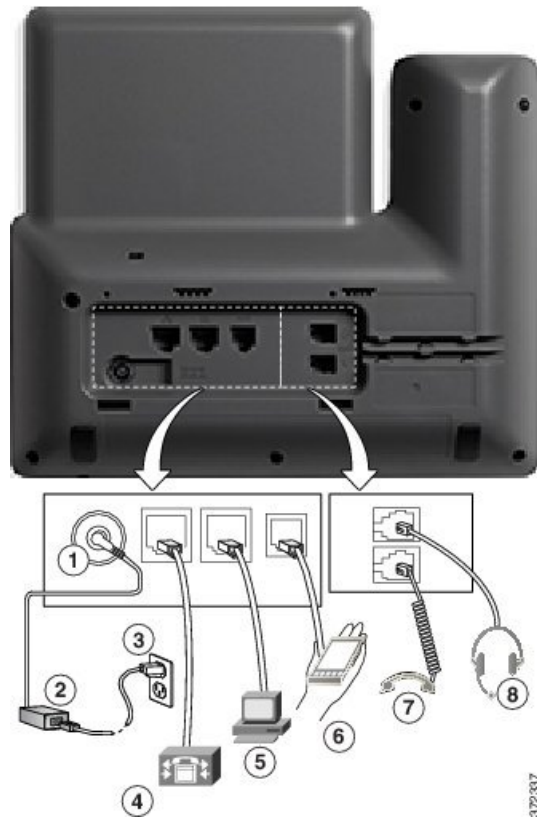

1	DC adaptor port (DC48V).	5	Access port (10/100/1000 PC) connection.
2	AC-to-DC power supply (optional).	6	Auxiliary port.
3	AC power wall plug (optional).	7	Handset connection.
4	Network port (10/100/1000 SW) connection. IEEE 802.3at power enabled.	8	Analog headset connection (optional).







Note

The Cisco IP Phone 8841 does not support the Cisco IP Phone 8800 Key Expansion Module.









REVIEW DRAFT - CISCO CONFIDENTIAL**Buttons and Hardware**

1	Handset light strip	Indicates an incoming call (flashing red) or new voice message (steady red).
2	Phone screen	Shows information about your phone such as directory number, active call and line status, softkey options, speed dials, placed calls, and phone menu listings.



REVIEW DRAFT - CISCO CONFIDENTIAL

3	<p>Programmable feature buttons and Session buttons</p> 	<p>Your phone provides quick access to your phone lines, features, and call sessions:</p> <ul style="list-style-type: none"> • Programmable feature buttons (left side): Use to view calls on a line or access features such as Speed Dial or All Calls. These buttons are also called feature buttons. • Session buttons (right side): Use to perform tasks such as answering a call, resuming a held call, or (when not being used for an active call) initiating phone functions such as displaying missed calls. Each call on your phone is associated with a session button. <p>Note If you are using a locale that reads right to left, such as Arabic, the line button and session button locations are swapped. Depending on how your system administrator sets up the phone, the buttons provide access to:</p> <ul style="list-style-type: none"> • Phone lines and intercom lines • Speed-dial numbers (speed-dial buttons, including the Line Status speed-dial features) • Web-based services (for example, a Personal Address Book button) • Call features (for example, a Privacy button) <p>Buttons illuminate to indicate status:</p> <ul style="list-style-type: none"> • Green, steady: Active call or two-way intercom call • Green, flashing: Held call • Amber, steady: Privacy in use, one-way intercom call, DND active, or logged into Hunt Group • Amber, flashing: Incoming call or reverting call • Red, steady: Remote line in use (shared line or Line Status) • Red, flashing: Remote line on hold
4	<p>Softkey buttons</p> 	<p>Depending on how your system administrator sets up the phone, enable softkey options displayed on your phone screen.</p>
5	<p>Navigation cluster and Select button</p> 	<p>The Navigation cluster and Select button allows you to scroll through menus, highlight items and select the highlighted item.</p>
6	<p>Release Button</p> 	<p>Ends a connected call or session.</p>

REVIEW DRAFT - CISCO CONFIDENTIAL

7	Hold/Resume button 	Places an active call on hold and resumes the held call.
8	Conference button 	Creates a conference call.
9	Transfer button 	Transfers a call.
10	Speakerphone button 	Toggles the speakerphone on or off. When the speakerphone is on, the button is lit.
11	Mute button 	Toggles the microphone on or off. When the microphone is muted, the button is lit.
12	Headset button 	Toggles the headset on or off. When the headset is on, the button is lit.
13	Keypad	Allows you to dial phone numbers, enter letters, and select menu items (by entering the item number).
14	Volume button 	Controls the handset, headset, and speakerphone volume (off hook) and the ringer volume (on hook).
15	Contacts button 	Opens or closes the Directories menu. Use the Contacts button to access personal and corporate directories.
16	Applications button 	Opens or closes the Applications menu. Use the Applications button to access call history, user preferences, phone settings, and phone model information.

REVIEW DRAFT - CISCO CONFIDENTIAL

17	Messages button 	Autodials your voice messaging system (varies by system).
18	Back button 	Returns to the previous screen or menu.
19	Handset	Phone handset.

Cisco IP Phone 8845

The following sections describe attributes of the Cisco IP Phone 8845.

Phone Connections

Connect your phone to the corporate IP telephony network, using the following diagram.

Draft comment: Design Team: Please provide graphic.

1	DC adaptor port (DC48V).	5	Access port (10/100/1000 PC) connection.
2	AC-to-DC power supply (optional).	6	Auxiliary port.
3	AC power wall plug (optional).	7	Handset connection.
4	Network port (10/100/1000 SW) connection. IEEE 802.3at power enabled.	8	Analog headset connection (optional).
		9	Camera pin holes (for Cisco Unified Video Camera)

**Note**









The Cisco IP Phone 8845 does not support the Cisco IP Phone 8800 Key Expansion Module.

REVIEW DRAFT - CISCO CONFIDENTIAL**Buttons and Hardware**





Draft comment: Design Team: Please provide graphic.

1	Handset light strip	Indicates an incoming call (flashing red) or new voice message (steady red).
2	Phone screen	Shows information about your phone such as directory number, active call and line status, softkey options, speed dials, placed calls, and phone menu listings.
3	Programmable feature buttons and Session buttons 	<p>Your phone provides quick access to your phone lines, features, and call sessions:</p> <ul style="list-style-type: none"> • Programmable feature buttons (left side): Use to view calls on a line or access features such as Speed Dial or All Calls. These buttons are also called feature buttons. • Session buttons (right side): Use to perform tasks such as answering a call, resuming a held call, or (when not being used for an active call) initiating phone functions such as displaying missed calls. Each call on your phone is associated with a session button. <p>Note If you are using a locale that reads right to left, such as Arabic, the line button and session button locations are swapped. Depending on how your system administrator sets up the phone, the buttons provide access to:</p> <ul style="list-style-type: none"> • Phone lines and intercom lines • Speed-dial numbers (speed-dial buttons, including the Line Status speed-dial features) • Web-based services (for example, a Personal Address Book button) • Call features (for example, a Privacy button) <p>Buttons illuminate to indicate status:</p> <ul style="list-style-type: none"> • Green, steady: Active call or two-way intercom call • Green, flashing: Held call • Amber, steady: Privacy in use, one-way intercom call, DND active, or logged into Hunt Group • Amber, flashing: Incoming call or reverting call • Red, steady: Remote line in use (shared line or Line Status) • Red, flashing: Remote line on hold

REVIEW DRAFT - CISCO CONFIDENTIAL

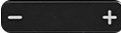
4	Softkey buttons 	Depending on how your system administrator sets up the phone, enable softkey options displayed on your phone screen.
5	Navigation cluster and Select button 	The Navigation cluster and Select button allows you to scroll through menus, highlight items and select the highlighted item.
6	Release Button 	Ends a connected call or session.
7	Hold/Resume button 	Places an active call on hold and resumes the held call.
8	Conference button 	Creates a conference call.
9	Transfer button 	Transfers a call.
10	Speakerphone button 	Toggles the speakerphone on or off. When the speakerphone is on, the button is lit.
11	Mute button 	Toggles the microphone on or off. When the microphone is muted, the button is lit.
12	Headset button 	Toggles the headset on or off. When the headset is on, the button is lit.
13	Keypad	Allows you to dial phone numbers, enter letters, and select menu items (by entering the item number).

REVIEW DRAFT - CISCO CONFIDENTIAL

14	Volume button 	Controls the handset, headset, and speakerphone volume (off hook) and the ringer volume (on hook).
15	Contacts button 	Opens or closes the Directories menu. Use the Contacts button to access personal and corporate directories.
16	Applications button 	Opens or closes the Applications menu. Use the Applications button to access call history, user preferences, phone settings, and phone model information.
17	Messages button 	Autodials your voice messaging system (varies by system).
18	Back button 	Returns to the previous screen or menu.
19	Handset	Phone handset.

Cisco IP Phone 8851 and 8851NR

The following sections describe attributes of the Cisco IP Phone 8851 and 8851NR.

**Note**

Cisco IP Phone 8851NR is only supported by firmware release 10.3(1) and later.

Phone Connections

Connect your phone to the corporate IP telephony network, using the following diagram.

REVIEW DRAFT - CISCO CONFIDENTIAL

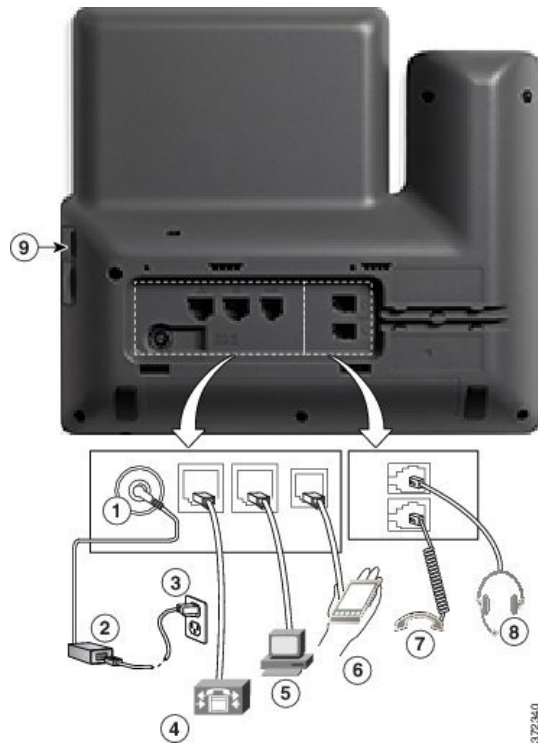

1	DC adaptor port (DC48V).	5	Access port (10/100/1000 PC) connection.	9	USB port
2	AC-to-DC power supply (optional).	6	Auxiliary port.		
3	AC power wall plug (optional).	7	Handset connection.		
4	Network port (10/100/1000 SW) connection. IEEE 802.3at power enabled.	8	Analog headset connection (optional).		







Note

Each USB port supports the connection of up to five supported and nonsupported devices. Each device connected to the phone is included in the maximum device count. For example, your phone can support five USB devices (such as two Cisco IP Phone 8800 Key Expansion Modules, one headset, one hub, and one other standard USB device) on the side port. Many third-party USB products count as multiple USB devices, for example, a device containing USB hub and headset can count as two USB devices. For more information, see the USB device documentation.









REVIEW DRAFT - CISCO CONFIDENTIAL**Buttons and Hardware**

1	Handset light strip	Indicates an incoming call (flashing red) or new voice message (steady red).
2	Phone screen	Shows information about your phone such as directory number, active call and line status, softkey options, speed dials, placed calls, and phone menu listings.



REVIEW DRAFT - CISCO CONFIDENTIAL

3	<p>Programmable feature buttons and Session buttons</p> 	<p>Your phone provides quick access to your phone lines, features, and call sessions:</p> <ul style="list-style-type: none"> • Programmable feature buttons (left side): Use to view calls on a line or access features such as Speed Dial or All Calls. These buttons are also called feature buttons. • Session buttons (right side): Use to perform tasks such as answering a call, resuming a held call, or (when not being used for an active call) initiating phone functions such as displaying missed calls. Each call on your phone is associated with a session button. <p>Note If you are using a locale that reads right to left, such as Arabic, the line button and session button locations are swapped. Depending on how your system administrator sets up the phone, the buttons provide access to:</p> <ul style="list-style-type: none"> • Phone lines and intercom lines • Speed-dial numbers (speed-dial buttons, including the Line Status speed-dial features) • Web-based services (for example, a Personal Address Book button) • Call features (for example, a Privacy button) <p>Buttons illuminate to indicate status:</p> <ul style="list-style-type: none"> • Green, steady: Active call or two-way intercom call • Green, flashing: Held call • Amber, steady: Privacy in use, one-way intercom call, DND active, or logged into Hunt Group • Amber, flashing: Incoming call or reverting call • Red, steady: Remote line in use (shared line or Line Status) • Red, flashing: Remote line on hold
4	<p>Softkey buttons</p> 	<p>Depending on how your system administrator sets up the phone, enable softkey options displayed on your phone screen.</p>
5	<p>Navigation cluster and Select button</p> 	<p>The Navigation cluster and Select button allows you to scroll through menus, highlight items and select the highlighted item.</p>
6	<p>Release Button</p> 	<p>Ends a connected call or session.</p>

REVIEW DRAFT - CISCO CONFIDENTIAL

7	Hold/Resume button 	Places an active call on hold and resumes the held call.
8	Conference button 	Creates a conference call.
9	Transfer button 	Transfers a call.
10	Speakerphone button 	Toggles the speakerphone on or off. When the speakerphone is on, the button is lit.
11	Mute button 	Toggles the microphone on or off. When the microphone is muted, the button is lit.
12	Headset button 	Toggles the headset on or off. When the headset is on, the button is lit.
13	Keypad	Allows you to dial phone numbers, enter letters, and select menu items (by entering the item number).
14	Volume button 	Controls the handset, headset, and speakerphone volume (off hook) and the ringer volume (on hook).
15	Contacts button 	Opens or closes the Directories menu. Use the Contacts button to access personal and corporate directories.
16	Applications button 	Opens or closes the Applications menu. Use the Applications button to access call history, user preferences, phone settings, and phone model information.

REVIEW DRAFT - CISCO CONFIDENTIAL

17	Messages button 	Autodials your voice messaging system (varies by system).
18	Back button 	Returns to the previous screen or menu.
19	Handset	Phone handset.

Cisco IP Phone 8861

The following sections describe attributes of the Cisco IP Phone 8861.

Phone Connections

Connect your phone to the corporate IP telephony network, using the following diagram.

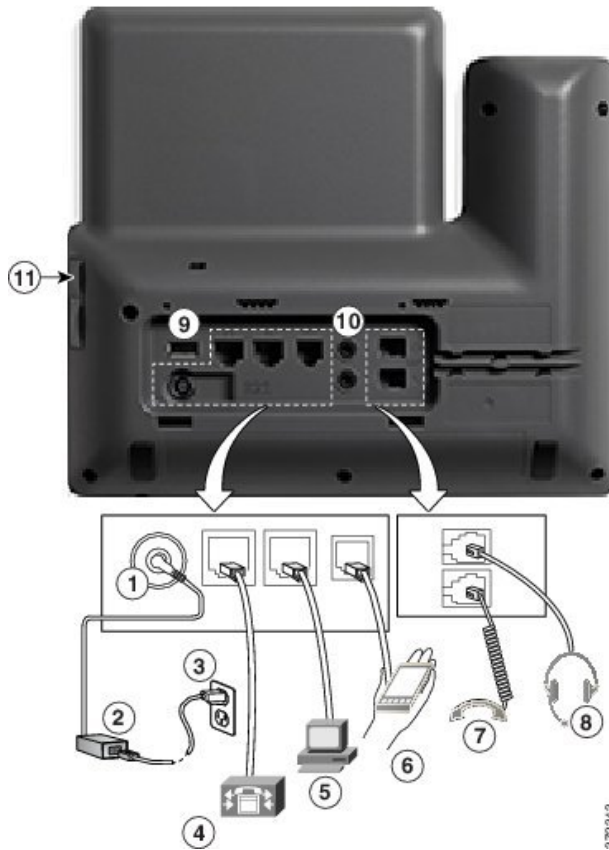
REVIEW DRAFT - CISCO CONFIDENTIAL

1	DC adaptor port (DC48V).	6	Auxiliary port.	11	USB port
2	AC-to-DC power supply (optional).	7	Handset connection.		
3	AC power wall plug (optional).	8	Analog headset connection (optional).		
4	Network port (10/100/1000 SW) connection. IEEE 802.3at power enabled.	9	USB port		
5	Access port (10/100/1000 PC) connection.	10	Audio In/Out ports		

REVIEW DRAFT - CISCO CONFIDENTIAL



Note





Each USB port supports the connection of up to five supported and nonsupported devices. Each device connected to the phone is included in the maximum device count. For example, your phone can support five USB devices (such as three Cisco IP Phone 8800 Key Expansion Modules, one hub, and one other standard USB device) on the side port and five additional standard USB devices on the back port. Many third-party USB products count as multiple USB devices, for example, a device containing USB hub and headset can count as two USB devices. For more information, see the USB device documentation.

Buttons and Hardware











1	Handset light strip	Indicates an incoming call (flashing red) or new voice message (steady red).
2	Phone screen	Shows information about your phone such as directory number, active call and line status, softkey options, speed dials, placed calls, and phone menu listings.



REVIEW DRAFT - CISCO CONFIDENTIAL

3	Programmable feature buttons and Session buttons 	<p>Your phone provides quick access to your phone lines, features, and call sessions:</p> <ul style="list-style-type: none"> • Programmable feature buttons (left side): Use to view calls on a line or access features such as Speed Dial or All Calls. These buttons are also called feature buttons. • Session buttons (right side): Use to perform tasks such as answering a call, resuming a held call, or (when not being used for an active call) initiating phone functions such as displaying missed calls. Each call on your phone is associated with a session button. <p>Note If you are using a locale that reads right to left, such as Arabic, the line button and session button locations are swapped. Depending on how your system administrator sets up the phone, the buttons provide access to:</p> <ul style="list-style-type: none"> • Phone lines and intercom lines • Speed-dial numbers (speed-dial buttons, including the Line Status speed-dial features) • Web-based services (for example, a Personal Address Book button) • Call features (for example, a Privacy button) <p>Buttons illuminate to indicate status:</p> <ul style="list-style-type: none"> • Green, steady: Active call or two-way intercom call • Green, flashing: Held call • Amber, steady: Privacy in use, one-way intercom call, DND active, or logged into Hunt Group • Amber, flashing: Incoming call or reverting call • Red, steady: Remote line in use (shared line or Line Status) • Red, flashing: Remote line on hold
4	Softkey buttons 	Depending on how your system administrator sets up the phone, enable softkey options displayed on your phone screen.
5	Navigation cluster and Select button 	The Navigation cluster and Select button allows you to scroll through menus, highlight items and select the highlighted item.
6	Release Button 	Ends a connected call or session.

REVIEW DRAFT - CISCO CONFIDENTIAL

7	Hold/Resume button 	Places an active call on hold and resumes the held call.
8	Conference button 	Creates a conference call.
9	Transfer button 	Transfers a call.
10	Speakerphone button 	Toggles the speakerphone on or off. When the speakerphone is on, the button is lit.
11	Mute button 	Toggles the microphone on or off. When the microphone is muted, the button is lit.
12	Headset button 	Toggles the headset on or off. When the headset is on, the button is lit.
13	Keypad	Allows you to dial phone numbers, enter letters, and select menu items (by entering the item number).
14	Volume button 	Controls the handset, headset, and speakerphone volume (off hook) and the ringer volume (on hook).
15	Contacts button 	Opens or closes the Directories menu. Use the Contacts button to access personal and corporate directories.
16	Applications button 	Opens or closes the Applications menu. Use the Applications button to access call history, user preferences, phone settings, and phone model information.

REVIEW DRAFT - CISCO CONFIDENTIAL

17	Messages button 	Autodials your voice messaging system (varies by system).
18	Back button 	Returns to the previous screen or menu.
19	Handset	Phone handset.

Cisco IP Phone 8865

The following sections describe attributes of the Cisco IP Phone 8865.

Phone Connections

Draft comment: Design Team: Please provide graphic.

1	DC adaptor port (DC48V).	6	Auxiliary port.	11	USB port
2	AC-to-DC power supply (optional).	7	Handset connection.		
3	AC power wall plug (optional).	8	Analog headset connection (optional).		
4	Network port (10/100/1000 SW) connection. IEEE 802.3at power enabled.	9	USB port		
5	Access port (10/100/1000 PC) connection.	10	Audio In/Out ports		









Each USB port supports the connection of up to five supported and nonsupported devices. Each device connected to the phone is included in the maximum device count. For example, your phone can support five USB devices (such as three Cisco IP Phone 8800 Key Expansion Modules, one hub, and one other standard USB device) on the side port and five additional standard USB devices on the back port. Many third-party USB products count as multiple USB devices, for example, a device containing USB hub and headset can count as two USB devices. For more information, see the USB device documentation.

REVIEW DRAFT - CISCO CONFIDENTIAL**Buttons and Hardware**





Draft comment: Design Team: Please provide graphic.

1	Handset light strip	Indicates an incoming call (flashing red) or new voice message (steady red).
2	Phone screen	Shows information about your phone such as directory number, active call and line status, softkey options, speed dials, placed calls, and phone menu listings.
3	Programmable feature buttons and Session buttons 	<p>Your phone provides quick access to your phone lines, features, and call sessions:</p> <ul style="list-style-type: none"> • Programmable feature buttons (left side): Use to view calls on a line or access features such as Speed Dial or All Calls. These buttons are also called feature buttons. • Session buttons (right side): Use to perform tasks such as answering a call, resuming a held call, or (when not being used for an active call) initiating phone functions such as displaying missed calls. Each call on your phone is associated with a session button. <p>Note If you are using a locale that reads right to left, such as Arabic, the line button and session button locations are swapped. Depending on how your system administrator sets up the phone, the buttons provide access to:</p> <ul style="list-style-type: none"> • Phone lines and intercom lines • Speed-dial numbers (speed-dial buttons, including the Line Status speed-dial features) • Web-based services (for example, a Personal Address Book button) • Call features (for example, a Privacy button) <p>Buttons illuminate to indicate status:</p> <ul style="list-style-type: none"> • Green, steady: Active call or two-way intercom call • Green, flashing: Held call • Amber, steady: Privacy in use, one-way intercom call, DND active, or logged into Hunt Group • Amber, flashing: Incoming call or reverting call • Red, steady: Remote line in use (shared line or Line Status) • Red, flashing: Remote line on hold

REVIEW DRAFT - CISCO CONFIDENTIAL

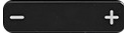
4	Softkey buttons 	Depending on how your system administrator sets up the phone, enable softkey options displayed on your phone screen.
5	Navigation cluster and Select button 	The Navigation cluster and Select button allows you to scroll through menus, highlight items and select the highlighted item.
6	Release Button 	Ends a connected call or session.
7	Hold/Resume button 	Places an active call on hold and resumes the held call.
8	Conference button 	Creates a conference call.
9	Transfer button 	Transfers a call.
10	Speakerphone button 	Toggles the speakerphone on or off. When the speakerphone is on, the button is lit.
11	Mute button 	Toggles the microphone on or off. When the microphone is muted, the button is lit.
12	Headset button 	Toggles the headset on or off. When the headset is on, the button is lit.
13	Keypad	Allows you to dial phone numbers, enter letters, and select menu items (by entering the item number).

REVIEW DRAFT - CISCO CONFIDENTIAL

14	Volume button 	Controls the handset, headset, and speakerphone volume (off hook) and the ringer volume (on hook).
15	Contacts button 	Opens or closes the Directories menu. Use the Contacts button to access personal and corporate directories.
16	Applications button 	Opens or closes the Applications menu. Use the Applications button to access call history, user preferences, phone settings, and phone model information.
17	Messages button 	Autodials your voice messaging system (varies by system).
18	Back button 	Returns to the previous screen or menu.
19	Handset	Phone handset.

Power Save and Power Save Plus

There are two levels of energy-saving modes that your system administrator can set up:

- Backlight turns off when not in use for a period of time, reducing the power requirements.
- Power Save Plus: The phone display goes blank, turning the phone off and on at predetermined times. The power to the phone is significantly reduced.

Power Save

Depending on how your system administrator set up your phone, the phone display may go into a power-save mode (the phone screen appears blank and the Select button is lit white).

To turn on the phone display, press any button or pick up the handset.

REVIEW DRAFT - CISCO CONFIDENTIAL

Power Save Plus

Your phone supports the Cisco EnergyWise (EW) program, also known as Power Save Plus. Your system administrator sets up sleep (power down) and wake (power up) times for your phone to save energy. If your phone goes into the Power Save Plus mode, the Select button is lit white.

Ten minutes before the scheduled sleep time, the Select button lights up and you receive a message that your phone will power off at a specific time. If enabled by your system administrator, you also hear your ringtone play. The ringtone plays according to the following schedule:

- At 10 minutes before power off, the ringtone plays four times
- At 7 minutes before power off, the ringtone plays four times
- At 4 minutes before power off, the ringtone plays four times
- At 30 seconds before power off, the ring tone plays 15 times or until the phone powers off

If your phone is inactive (idle) at the sleep time, you see a message to remind you that your phone is about to power down. To keep the phone active, you need to press OK in the message or any key on the phone. If you do not press the button or any key, your phone powers down.

If your phone is active (for example, on a call), your phone waits until it has been inactive for a period of time before telling you of the pending power shutdown. Before the shutdown happens, you see a message to remind you that your phone is about to power off.

After your phone goes to sleep, press Select to wake up your phone. After the phone is inactive for a period of time, a message displays to alert you that the phone is about to power down. At the configured wake time, your phone powers up.

Wake and sleep times are also linked to the configured days that you normally work. If your requirements change (for example, your work hours or work days change), contact your system administrator to have your phone reconfigured.

For more information about EnergyWise and your phone, contact your system administrator.

Additional Information

You can access the Cisco website at this URL: <http://www.cisco.com/>

Within the Cisco website, you can find the following information:

- Quick reference cards, quick start guides, and end-user guides:

<http://www.cisco.com/c/en/us/support/collaboration-endpoints/unified-ip-phone-8800-series/products-user-guide-list.html>

- Licensing information:

<http://www.cisco.com/c/en/us/support/collaboration-endpoints/unified-ip-phone-8800-series/products-licensing-information-listing.html>

- Cisco international websites:

Allows access to international Cisco websites from www.cisco.com by clicking the Worldwide [change] link at the top of the web page.



Phone Setup

- [Connect Footstand, page 29](#)
- [Adjust the Handset Rest, page 30](#)
- [Secure the Phone with a Cable Lock, page 30](#)

Connect Footstand

The phone includes an adjustable footstand. If the phone is placed on a table or desk, the footstand can be connected to the back of the phone. The footstand enables the phone angle to be adjusted from a minimum of 35 degrees to a maximum of 50 degrees to ensure an optimal viewing angle.

**Note**

Adjusting the footstand to the required angle may require more force than you expect.

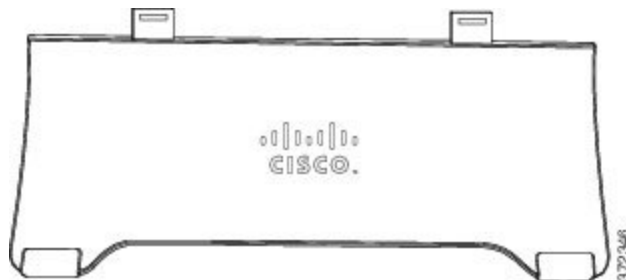

Procedure

- Step 1** Insert the connectors into the slots provided.
 - Step 2** Press the footstand until the connectors snap into place.
 - Step 3** Adjust the angle by pressing down or pulling up on the footstand. The connectors are made of a flexible material.
-

REVIEW DRAFT - CISCO CONFIDENTIAL

Adjust the Handset Rest

If your phone is wall-mounted, you may need to adjust the handset rest to ensure that the receiver does not slip out of the cradle.

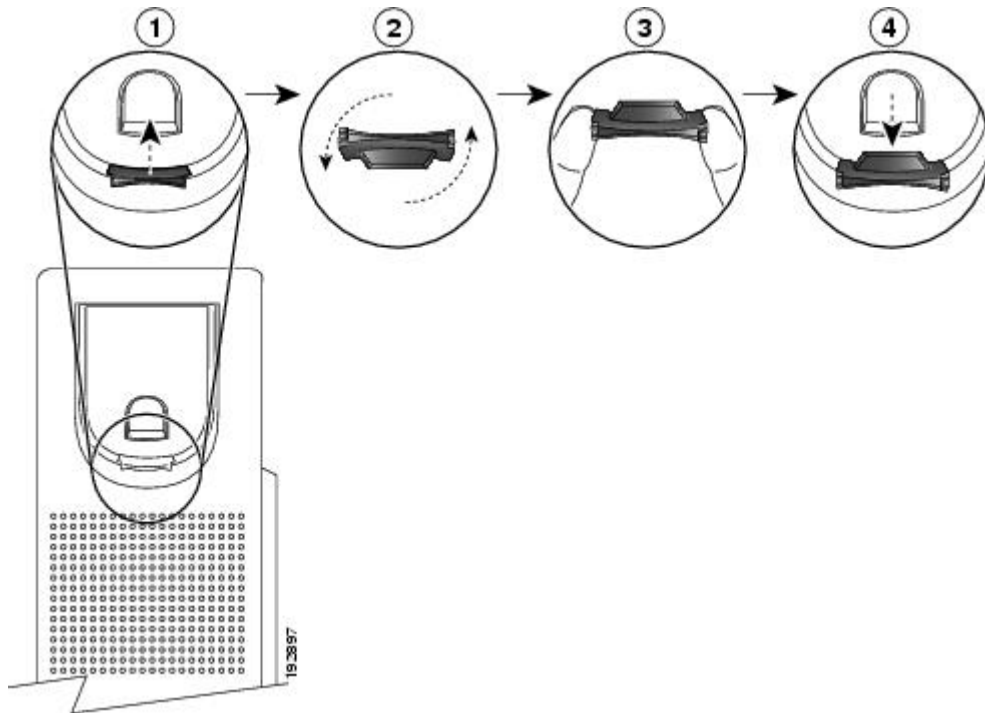

Procedure

-
- Step 1** Remove the handset from the cradle and pull the plastic tab from the handset rest.
 - Step 2** Rotate the tab 180 degrees.
 - Step 3** Hold the tab between two fingers, with the corner notches facing you.
 - Step 4** Line up the tab with the slot in the cradle and press the tab evenly into the slot. An extension protrudes from the top of the rotated tab.
 - Step 5** Return the handset to the handset rest.
-

Secure the Phone with a Cable Lock

You can secure the phone to a desktop with a laptop cable lock. The lock connects to the antitheft security connector on the back of the phone and the cable can be secured to a desktop.

REVIEW DRAFT - CISCO CONFIDENTIAL

The security slot can accommodate a lock up to 20 mm wide. Compatible laptop cable locks include the Kensington laptop cable lock and laptop cable locks from other manufacturers that can fit into the security slot on the back of the phone.

Procedure

- Step 1** Wrap the looped end of the cable lock and wrap it around object to which you want to secure your phone.
- Step 2** Pass the lock through the looped end of the cable.
- Step 3** Unlock the cable lock.
- Note** There are two kinds of cable locks: keyed and combination. Depending on the type of lock you have, unlock it by using the key or the correct combination.
- Step 4** Press and hold the locking button to align the locking teeth.
- Step 5** Insert the cable lock into the lock slot of your phone and release the locking button.
- Step 6** Lock the cable lock.
- Note** For keyed locks, turn the key 90 degrees in the clockwise direction and pull the key out of the lock. For combination locks, rotate the lock 90 degrees and then scramble the combination.
-

REVIEW DRAFT - CISCO CONFIDENTIAL



Basic Operations

- [Clean the Phone Display, page 33](#)
- [Make Calls, page 34](#)
- [Navigate and Select Items, page 36](#)
- [View All Calls on the Phone, page 37](#)
- [Answer Calls, page 37](#)
- [Automatically Answer Calls, page 41](#)
- [Respond to a Call Waiting Notification, page 42](#)
- [Manage Calls, page 42](#)
- [Call Forward, page 44](#)
- [Mute Phone, page 45](#)
- [Hold Calls, page 45](#)
- [Set Up Call Back Notification, page 47](#)
- [Call Park, page 47](#)
- [Manage Intercom Calls, page 49](#)
- [View Phone Information, page 50](#)
- [Video Calls, page 51](#)
- [Sign In To the Cisco Unified Communications Self Care Portal, page 53](#)

Clean the Phone Display

Phone displays that are not touchscreens can be easily cleaned.

Procedure

Wipe the screen with a soft, dry cloth.

REVIEW DRAFT - CISCO CONFIDENTIAL

Caution Use only a soft, dry cloth to wipe the phone display. Do not use any liquids or powders on the phone because they can contaminate phone components and cause failures.



Make Calls

If the phone window displays the `Unprovisioned` message for your primary line, contact your system administrator to get the primary line set up.

Predial a Number

You can dial a number while your phone is on-hook (without hearing dial tone); this dialing action is called predial.

Procedure

- Step 1** Enter a number using the keypad.
- Step 2** Go off-hook using one of the following actions:
- Lift the handset.
 - Press **Call**.
 - Press **Handset** .
 - Press **Speakerphone** .
-

Place a Call Using the Speakerphone

Your administrator can configure your phone so that the speakerphone is disabled. If the speakerphone is disabled, the softkeys are dimmed or blank.

Procedure

- Step 1** Press **Speakerphone** .
- Step 2** Enter a number.
-

REVIEW DRAFT - CISCO CONFIDENTIAL

Place a Call Using a Headset

Procedure

- Step 1** Press **New Call**.
- Step 2** Ensure the headset button is lit. If the headset button is not lit, press **Headset** .
- Step 3** Enter a number.
-

Release a Call and Start Another Call

When you are on an active call or dialing, and want to release the call, the following actions occur:

- The active call ends.
- The phone provides dial tone.
- You can dial the new call.

Procedure

- Step 1** When you are on an active call or while dialing, press **End Call**.
- Step 2** Enter the required number and press **Call**.
-

Dial an International Number

Plus Dialing allows you to press and hold the star (*) key for at least 1 second to insert a plus (+) sign as the first digit in a phone number for international dialing. The plus sign applies only for on-hook or off-hook calling.

When you see phone numbers with the + sign in them, you can select and dial the entry without having to add digits for international calls.

Procedure

- Step 1** Press and hold star (*) for at least 1 second.
The plus (+) sign displays as the first digit in the phone number. The corresponding tone stops to indicate that the * has changed to a + sign. You can only hear the tone in off-hook state.
- Step 2** Dial the number.
-

REVIEW DRAFT - CISCO CONFIDENTIAL**Redial a Number**

Redial allows you to call the most recently dialed phone number.

Procedure

-
- Step 1** To place a call from any phone line, press **Redial**.
- Step 2** To place the call on a specific phone line, select the line to obtain dial tone and press **Redial**.
-

Navigate and Select Items

Task	Action	Example
Scroll to highlight an item.	Press the Navigation cluster and Select button.	Highlight a call from the missed call list.
Select an item by number.	Press the corresponding number on the keypad.	Press 2 to select the second item in the Applications menu.
Select an item using the Select button.	Press Select at the center of the Navigation cluster and Select button.	Highlight the Settings application and press Select .
Navigate to a submenu. (A right arrow (>)) next to the menu item indicates that a submenu exists.)	Highlight the menu item and press the item number on the keypad. Or press the Navigation cluster and Select button.	Highlight the Network Setup menu, then press 1 to open the submenu.
Select a line to use a calling feature (when the line is idle).	Press the line button. Indicators of your line selection include: <ul style="list-style-type: none"> • The selected line is displayed on the phone screen header. • On phones with color screens, the color of the icon (on the line label) changes to blue. 	Press the line button and then press Forward All to forward calls on that line.

REVIEW DRAFT - CISCO CONFIDENTIAL

Task	Action	Example
Select a line to use a calling feature (when the line has one or more active calls).	Press the line button. Indicators of your line selection include: <ul style="list-style-type: none"> • The selected line is displayed on the phone screen header. • On phones with color screens, the color of the icon (on the line label) changes to blue. 	Press the line button twice and then press Forward All to forward calls on that line.

View All Calls on the Phone

All Calls allows you to view a list, sorted in chronological order (oldest first), of all active calls on all of your phone lines. You see the normal phone calls as well as shared line, barged calls, and conference calls.

You use this feature if you have multiple lines or if you share lines with other users. With the All Calls view:

- All active calls display on one place, making it easy to view and interact with calls on any line.
- When you lift the handset, the phone selects your primary line, which helps prevent inadvertent use of a shared line for dialing.
- You can press the flashing amber session button to answer a ringing call on any line. You do not need to first select the line with the ringing call before answering it.

Your system administrator sets up the All Calls button depending on your call-handling needs and work environment.

The All Calls button is the session key with an associated icon. When the icon changes, you have missed a call. Press the icon to view the call history information for the missed call.

Your system administrator can also set up your primary line to automatically display all calls. Your system administrator can also set up your phone so that after a call completes, the primary line with the All Calls view displays.

Procedure

-
- Step 1** To view all calls, press **All Calls**.
- Step 2** If you do not see the All Calls button, press **Primary Line**.
-

Answer Calls

Answer allows you to answer the oldest call that is available on all line appearances on your phone, including Hold Reversion and Park Reversion calls that are in an alerting state. Incoming calls always have priority over Held or Park Reversion calls.

REVIEW DRAFT - CISCO CONFIDENTIAL

Your system administrator sets up the Answer button depending on your call-handling needs and work environment. This feature is typically set up for users who have multiple lines.

When you get a call, you see a notification window on the phone screen, called a call toast. The call toast remains visible for a preset amount of time. If an incoming call has been call forwarded from another phone, you may see additional information in the call toast to identify that the call has been forwarded.

If an incoming call has been call forwarded from another phone, you may see additional information to identify that the call has been forwarded. Your system administrator controls the amount of additional information that is displayed. Additional information can identify the person who forwarded the call to you and the caller information.

For more information, contact your system administrator.

Answer the Oldest Call First

Answer allows you to answer the oldest call that is available on all line appearances on your phone, including Hold Reversion and Park Reversion calls that are in an alerting state. Incoming calls always have priority over Held or Park Reversion calls.

Your system administrator sets up the Answer button depending on your call-handling needs and work environment. Typically, the Answer is set up if you have multiple lines.

When you get a call, you see a notification window on the phone screen, called a call toast. The call toast remains visible for a preset amount of time. Your system administrator sets up the default time.

If an incoming call has been call forwarded from another phone, you may see additional information in the call toast to identify that the call has been forwarded. Your system administrator controls the amount of additional information displayed. Additional information can identify the person who forwarded the call to you and the caller information.

Procedure

To answer the oldest incoming call first, press **Answer**.

Call Pickup

Call Pickup allows you to answer a call that is ringing on a coworker's phone by redirecting the call to your phone. Your system administrator sets up call groups and can assign you to one or more call groups. Your system administrator also sets up the Call Pickup softkeys depending on your call-handling needs and work environment.

You might use Call Pickup if you share call-handling tasks with coworkers.

There are three ways you can pick up a call:

Pickup

Allows you to answer a call that is ringing on another phone within your call pickup group.

If multiple calls are available for pick up, your phone picks up the oldest call first (the call that has been ringing for the longest time).

REVIEW DRAFT - CISCO CONFIDENTIAL

Group Pickup

Allows you to answer a call on a phone that is outside your call pickup group by:

- Using a group pickup number (provided by your system administrator).
- Dialing the number of the ringing phone.

Other Pickup

Allows you to answer a call that is ringing on another phone within in your call pickup group or in an associated call pickup group.

You can also monitor and pick up ringing calls using Line Status indicators if your system administrator has set up Line Status indicators on speed-dial buttons for you. Line Status indicators allow you to see if a line associated with a speed-dial button is idle, in-use, in a Do Not Disturb state, or ringing.

Related Topics

[Line Status Indicators](#), on page 82

Answer a Call Using Pickup

Call Pickup allows you to answer a call ringing on a coworker's phone by redirecting the call to your phone. You might use Call Pickup if you share call-handling tasks with coworkers.

There are three ways you can pick up a call:

- **PickUp**: Allows you to answer a call ringing on another phone within your call pickup group. If multiple calls are available for pick up, your phone picks up the oldest call first (the call that has been ringing for the longest time).
- **Group Pickup**: Allows you to answer a call on a phone that is outside your call pickup group by:
 - Using a group pickup number (provided by your system administrator).
 - Dialing the number of the ringing phone.
- **Other Pickup**: Allows you to answer a call ringing on another phone within in your call pickup group or in an associated call pickup group.

Your system administrator sets up your call pickup group and your call pickup softkeys, depending on your call-handling needs and work environment.

You can also monitor and pick up ringing calls using Line Status indicators if your system administrator has set up Line Status indicators on speed-dial buttons for you. Line Status indicators allow you to see if a line that is associated with a speed-dial button is idle, in-use, in a Do Not Disturb state, or ringing.

Procedure

Step 1 Perform one of the following actions:

- Press **PickUp** to transfer a ringing call within your pickup group to your phone.

REVIEW DRAFT - CISCO CONFIDENTIAL

- If you have multiple lines and want to pick up the call on a nonprimary line, first press the desired line button, then press **PickUp**.

If your phone supports autpickup, you are connected to the call.

Step 2 If the call rings, press **Answer** to connect to the call.

Answer a Call Using Group PickUp and a Phone Number

Procedure

Step 1 Perform one of the following actions:

- Press **Group PickUp**.
- If you have multiple lines and want to pick up the call on a nonprimary line, first press the desired line button, and then press **Group PickUp**.

Step 2 Enter the number of the phone line with the call that you want to pick up.
For example, if the call is ringing on line 12345, enter 12345.

If your phone supports autpickup, you are now connected to the call.

Step 3 If the call rings, press **Answer** to connect to the call.

Answer a Call Using Group PickUp and a Group PickUp Number

Procedure

Step 1 Perform one of the following actions:

- Press **Group PickUp** to answer a call on a phone outside your pickup group.
- If you have multiple lines and want to pick up the call on another line, first press the desired line button, then press **Group PickUp**.

Step 2 Enter the group pickup number.
If your phone supports autpickup, you are now connected to the call.

Step 3 If the call rings, press **Answer** to connect to the call.

REVIEW DRAFT - CISCO CONFIDENTIAL

Answer a Call Using Other PickUp





Procedure

- Step 1** Perform one of the following actions:
- Press **OPickUp** to answer a call in your pickup group or in an associated group to your phone.
 - If you have multiple lines and want to pick up the call on another line, first press the desired line button, then press **OPickUp**.
- Step 2** If the call rings, press **Answer** to connect to the call.
-

Automatically Answer Calls

Incoming calls can be answered automatically by your phone after one ring. Your administrator sets up the Auto Answer feature to work with either your speakerphone or headset. For more information, contact your administrator.

Procedure

- Step 1** When your phone is set up to autoanswer calls using your headset,
- a) To answer calls automatically with a headset, prepare your phone in the following way:
- Ensure that your headset is connected to the phone.
 - Ensure that the headset button  is illuminated.
- When you get a call, the call answers automatically and you interact with the caller using the headset.
- b) To end calls or make calls, use the buttons and softkeys. Do not use the headset button .
- c) If you do not want calls to automatically answer on your headset, press the headset button  to turn off the headset and use the handset or speakerphone to make and answer calls.
- Step 2** When your phone is set up to autoanswer calls using the speakerphone,
- a) To answer calls automatically on the speakerphone, prepare your phone in the following way:
- Ensure that the headset button  is not illuminated.
 - Leave the handset in the cradle.
- When you get a call, the call answers automatically and you interact with the caller using the speakerphone.

REVIEW DRAFT - CISCO CONFIDENTIAL

- b) If you do not want calls to answer automatically on your speakerphone, press the headset button  to make and answer calls using a headset or the handset.
-

Respond to a Call Waiting Notification

Call Waiting provides the following to notify you that a new call is ringing on your phone when you are talking on another call:

- Call Waiting tone (single beep)
- An amber flashing line button

This feature is configured by the administrator.

Procedure

- Step 1** To answer the ringing call, press the flashing amber session button or press **Answer** to answer the call. You can also scroll to the call and press **Select** to answer it. Your phone puts the original call on hold automatically and connects the ringing call.
- Step 2** If the call is on a different line, you must first press the line button or **All Calls**, if available, to display the ringing session and then answer the call.
- Step 3** If the call is on the same line and not visible, as there are many calls, then you must scroll to display the sessions.
- Step 4** If a programmable feature button is set up by your system administrator to answer calls, you can press the feature button to answer a ringing call, regardless of the line of the call or the line that is currently visible. The phone automatically switches the line to display the call.
-

Manage Calls

Decline a Call

Decline allows you to send an active or ringing call to your voicemail system or to a predetermined phone number. For more information, contact your system administrator.

You can silence the incoming (ringing) call. Press Volume down once, then let the incoming call go to the target number (voicemail or predetermined number set up the system administrator).

REVIEW DRAFT - CISCO CONFIDENTIAL

Procedure

- Step 1** To redirect an incoming (ringing) call while on another call, highlight the incoming call, then press **Decline**. Otherwise, press **Decline** to redirect the current, active call.
 - Step 2** To redirect an incoming call while not on a call, press **Decline**.
 - Step 3** To redirect a held call, first resume the call and then press **Decline**.
-



Transfer a Call to Another Number

Transfer allows you to redirect a connected call from your phone to another number.

- You can redirect a single call to another number that you specify.
- You can connect two calls to each other without remaining on the line yourself.

Your system administrator controls the ability to transfer calls from one line to another line.

Procedure

- Step 1** Verify that you are on an active call (not on hold).
 - Step 2** Press **Transfer** .
 - Step 3** Enter the transfer recipient's phone number or press a speed-dial button.
 - Step 4** Wait for the recipient to answer or skip to Step 5 while the call is ringing.
 - Step 5** Press **Transfer**  again.
-

Toggle Between Calls Before Completing a Transfer

After you connect to the transfer recipient, but before you transfer a call to this party, you can press **Swap** to toggle between the two calls. This allows you to consult privately with the party on each call before you complete the transfer.

Procedure

- Step 1** Call a new conference participant, but do not add the participant to the conference.
 - Step 2** Press **Swap** to toggle between the participant and the conference.
-

REVIEW DRAFT - CISCO CONFIDENTIAL

Monitor and Record Calls

Monitoring and Recording allows you to monitor and record calls if desired. Your system administrator enables this feature, which can be set up for automatic recording of all calls or recording of individual calls, when required.

Procedure

To start or stop recording, press **Record** on your phone.

You may hear notification tones while you monitor and record calls. By default, the person who monitors the call and records it (if also configured) does not hear the notification tones.

Call Forward

Call Forward allows you to forward calls from any line on your phone to another number.

There are two types of call-forwarding features that your system administrator may set up on your phone:

- Unconditional call forwarding (Call Forward All): Applies to all calls that you receive. You can set up Call Forward All directly on your phone for any line. To set up Call Forward All remotely, go to the Self Care Portal.
- Conditional call forwarding (Call Forward No Answer, Call Forward Busy, Call Forward No Coverage): Applies to certain calls that you receive, according to conditions, and is set up from the Self Care Portal.

When forwarding calls from your phone:

- Enter the call forward target number exactly as you would dial it from your phone. For example, enter an access code or the area code, if necessary.
- Call forward is phone-line specific. If a call reaches you on a line where call forwarding is not enabled, the call rings as usual.
- Your system administrator can set up other call-forward options:
 - Allow calls placed from the call forward target number to your phone to ring through, rather than be forwarded.
 - Prevent you from creating a call-forward loop or exceeding the maximum number of links in a call forwarding chain.

Forward All Calls

Procedure

Step 1 On any idle line from which you want to forward your calls, press **Forward All**.

Step 2 Enter a phone number, or select an entry from the Call History list.

REVIEW DRAFT - CISCO CONFIDENTIAL

Depending on how your voicemail system is set up, you may be able to press **Messages** to forward all calls to voicemail.

Visual confirmation displays for a few seconds to confirm the number to which your calls will be forwarded.

Step 3 To verify that your calls are forwarded, look for:

- A Forward All  icon in the line label.
- The forwarding information in the header.

Step 4 To cancel call forwarding, press **Forward Off**.

Mute Phone

Mute allows you to block audio input for your handset, headset, and speakerphone, so that you can hear other parties on the call but they cannot hear you.

When the Separate Audio and Video Mute feature is enabled, you mute the audio but continue to transmit a video image when you press Mute during a video call. This allows the other parties to see you but not to hear you. When this feature is disabled, you mute both the audio and the video image when you press Mute during a video call.

The Separate Audio and Video Mute feature is disabled by default. See your administrator to have it enabled.

Procedure

Step 1 Press **Mute**  to turn Mute on.

Step 2 Press **Mute** again to turn Mute off.

Hold Calls

Hold allows you to put an active call into a held state. Your phone allows one active call at a time; other calls are put on hold. Hold works with your phone handset as well as with USB headsets.

Procedure

While on an active call, press **Hold**.

Swap Between Active and Held Calls

Use the line buttons to swap between held and connected calls.

REVIEW DRAFT - CISCO CONFIDENTIAL

Procedure

If you have a held call and an active call, press the line button for the held call to resume that call and place the other call on hold automatically.

Put a Call on Hold by Answering a New Call

If you are already on a call and receive a new call, answering the new call puts the first call on hold automatically.

Procedure

Press flashing amber line button or press **Answer** to answer the ringing call.

Respond to a Hold Reversion Notification

Hold Reversion notifies you when a call is left on hold.

A Hold Reversion notification is similar to a new call notification and includes these cues:

- Single ring, repeating at intervals
- Flashing amber line button
- Flashing message indicator on the handset
- Visual notification on the phone screen

Procedure

Press the flashing amber line button or **Answer** to resume the held call.

Determine If a Shared Line Is On Hold

If a call on a shared line has been put on hold remotely by another user, a pulsing red line button and the Hold



icon are displayed.

Remote Hold

When you place a call on hold while using a shared line, the line button pulses green and the phone displays

the Hold  icon. When another phone places a call on hold, the line button pulses red and the phone displays the Remote Hold icon.

REVIEW DRAFT - CISCO CONFIDENTIAL

Set Up Call Back Notification

Procedure

-
- Step 1** Press **Callback** while listening to the busy tone or ring sound.
- Step 2** Press **Exit** to exit the confirmation screen.
Your phone alerts you when the line is free.
- Step 3** Press **Call** to place the call again.
-

Call Park

Call Park allows you to use your phone to park (temporarily store) a call, which you can then retrieve from another phone (such as a phone at a coworker's desk or in a conference room).

There are two ways you can park a call:

Park

Allows you to park an active call that you answered on your phone, and retrieve it using another phone in the Cisco Unified Communications Manager system.

Directed Call Park

Allows you to park and retrieve an active call in two different ways:

- **Assisted Directed Call Park:** Allows you to park an active call using a feature button, which your system administrator sets up as a speed-dial line.
With this type of directed call, you can monitor the status of the line (in-use or idle) using Line Status indicators.
- **Manual Directed Call Park:** Allows you to park an active call by transferring it to a Directed Call number, which your system administrator sets up.
You retrieve the call at another phone by dialing a park retrieval prefix number (provided by your system administrator) and then dialing the Directed Call number you used to park the call.

Your system administrator sets up either the Directed Call Park or the Park feature on your phone, but not both.

Related Topics

[Line Status](#), on page 82

REVIEW DRAFT - CISCO CONFIDENTIAL

Park and Retrieve a Call Using Call Park

Procedure

- Step 1** During a call, press **Park**, and then hang up.
Your phone displays the number where the system parked the call. The parked call is put on hold, and you can press **Resume** to resume the call on your phone.
- Step 2** From any other Cisco IP Phone in your network, enter the number where the call is parked to retrieve the call.
- Step 3** If you do not retrieve the call within a certain amount of time (set by your system administrator) you receive an alert tone, at which time you can:
- Press **Answer** to answer the call on your phone.
 - Retrieve the call from another phone.

If you fail to retrieve or answer the call within a specified amount of time, the call is redirected to another destination (set up by your system administrator), such as voicemail. If the call gets redirected, it can no longer be retrieved by using Call Park.

Park a Call Using Assisted Directed Call Park

Procedure

- Step 1** During a call, press **BLF Directed Call Park** on a line that displays an idle Line Status indicator.
- Step 2** Retrieve the call from any other Cisco IP Phone in your network as follows:
- a) Enter the park retrieval prefix.
 - b) Dial the Directed Call number.
- Step 3** If you do not retrieve the call within the time that your system administrator has set, you receive an incoming call with notification of CallPark Reversion. At that time, you can press answer to answer the call. The other phones can no longer retrieve that call.
- Press **Resume** to resume the call on your phone.
 - Retrieve the call from another phone.
-

REVIEW DRAFT - CISCO CONFIDENTIAL

Park a Call Using Manual Directed Call Park

Procedure

- Step 1** During a call, press **Transfer** .
- Step 2** Enter the Directed Call number where you will park the call.
- Step 3** Press **Transfer** again to finish parking the call and then hang up.
- Step 4** Retrieve the call from any other Cisco IP Phone in your network as follows:
- Enter the park retrieval prefix.
 - Dial the Directed Call number.
- Step 5** If you do not retrieve the call within the time that your system administrator has set, you receive an alert tone. At that time, you can:
- Press **Resume** to resume the call on your phone.
 - Retrieve the call from another phone.
-

Manage Intercom Calls

Intercom allows you to place and receive one-way calls using a dedicated or dialable intercom line.

When you place an intercom call, the recipient's phone autoanswers with mute activated (whisper mode) and broadcasts your message through the recipient's speakerphone, headset, or handset, if one of these devices is active.

After receiving the intercom call, the recipient can initiate two-way audio (connected mode) to allow for further conversation.

Place a Dedicated Intercom Call

Intercom allows you to place and receive one-way calls using a dedicated or dialable intercom line.

When you place an intercom call, the recipient phone autoanswers with mute activated (whisper mode) and broadcasts your message through the recipient's speakerphone, headset, or handset, if one of these devices is active.

After receiving the intercom call, the recipient can initiate two-way audio (connected mode) to allow for further conversation.

Procedure

- Step 1** Press **Intercom**.

REVIEW DRAFT - CISCO CONFIDENTIAL

Note Your phone enters whisper mode until the recipient accepts the intercom call. If you are on an active call, that call is placed on hold.

Step 2 Listen for the intercom alert tone, then begin speaking.

Step 3 Press **Intercom** to end the call.

Place a Dialable Intercom Call

Procedure

Step 1 Press **Intercom**.

Step 2 Enter the intercom code.

Note Your phone enters whisper mode until the recipient accepts the intercom call. If you are on an active call, that call is placed on hold.

Step 3 Listen for the intercom alert tone, then begin speaking.

Step 4 Press **Intercom** to end the call.

Receive an Intercom Call

Intercom allows you to place and receive one-way calls using a dedicated or dialable intercom line.

After receiving the intercom call, the recipient can initiate two-way audio (connected mode) to allow for further conversation.

Procedure

Step 1 When an intercom call comes to your phone, you receive a message on your phone screen, an audible alert, and your phone answers the intercom call with mute activated. You can handle the intercom call in one of these ways:

- Listen to the intercom caller in whisper mode. Any current call activity you are already engaged in continues simultaneously. In whisper mode, the intercom caller cannot hear you.
- Press **Intercom** to switch to connected mode. In connected mode, you can speak to the intercom caller.

Step 2 Press **Intercom** to end the call.

View Phone Information

Phone Information allows you to view the following information for your phone:

REVIEW DRAFT - CISCO CONFIDENTIAL

- Model Number
- IP Address
- Host Name
- Active Load
- Last Upgrade
- Active Server
- Stand-by-Server

Procedure

- Step 1** Press **Applications** .
- Step 2** Select **Phone Information**.
- Step 3** Press **Exit** to return to the Applications screen.
- Note** You can press Show detail to view the upgrade process during an upgrade.
-

Video Calls

The Cisco Unified IP Phones supports phone calls that contain video (if present). With these phones, you do not need to install the Cisco Unified Video camera to receive the video portion of a call.

Press **Turn On** to enable the Enable Video On/Off feature, or press **Return** to return to the Setup screen.

Hide or Show Video

Your system administrator sets up the default softkey (either Show Video or Hide Video) and the default view (video hidden or video displayed).

Procedure

- Step 1** To hide the video, press **Hide Video**.
- Step 2** To show the video, press **Show Video**.
-

Hide Softkeys in Full-Screen Video

The softkeys display on the screen when a full-screen video call is enabled. If there is no user activity, the softkeys automatically hide after 10 seconds.

REVIEW DRAFT - CISCO CONFIDENTIAL

Procedure

To display the softkeys, do one of the following actions:

- Press **Mute**.
- Change the state of the video such as by plugging in the camera.
- Touch the phone screen (Cisco Unified IP Phone 9971 only).
- Press any softkey (Cisco Unified IP Phone 9951 only).

Enable Full Screen Video

Procedure

-
- Step 1** Press **Full Screen**.
- Step 2** Press **Minimize** to return to the original view.
-

Mute Video

Mute allows you to block audio input for your handset, headset, and speakerphone, so that you can hear other parties on the call but they cannot hear you.

When the Separate Audio and Video Mute feature is enabled, you mute the audio but continue to transmit a video image when you press Mute during a video call. This allows the other parties to see you but not to hear you. When this feature is disabled, you mute both the audio and the video image when you press Mute during a video call.

The Separate Audio and Video Mute feature is disabled by default. See your administrator to have it enabled.

Procedure

-
- Step 1** Press **Mute Video**.
- Step 2** Press **Unmute Video** to unmute the video.
-

Swap Views

Procedure

Press **Swap** to toggle between the full-screen view and the picture-in-picture (PIP) view.

REVIEW DRAFT - CISCO CONFIDENTIAL

The **Swap** is only available if you are in full-screen view.

Adjust Picture-In-Picture Position

Procedure

- Step 1** Press **PIP** to move the picture-in-picture (PIP) window to a different quadrant of the screen.
 - Step 2** To disable PIP, press **PIP** five times.
-

Sign In To the Cisco Unified Communications Self Care Portal

Your phone is a network device that can share information with other network devices in your company, including your personal computer. You can use your computer to sign in to the Cisco Unified Communications Self Care Portal, where you can control features, settings, and services for your phone. For example, you can manage your phone display language, set up services, add entries to your personal address book, and set up speed-dial codes.

Before you can access any of your options, such as Speed Dial or Personal Address Book, you must sign in. When you are finished using portal, you must sign out.

In some cases, you can access the Cisco Unified Communications Self Care Portal without having to sign in. For more information, contact your system administrator.

For assistance in using the portal, see the *Cisco Unified Communications Self Care Portal User Guide*, located at http://www.cisco.com/en/US/products/sw/voicesw/ps556/products_user_guide_list.html.

Procedure

- Step 1** Obtain the portal URL, user ID, and default password from your system administrator. Typically, the portal URL is `http://<ip_address or hostname>/ucmuser`.
 - Step 2** Open a web browser on your computer and enter the URL.
 - Step 3** If prompted to accept security settings, select **Yes** or **Install Certificate**.
 - Step 4** Enter your user ID in the Username field.
 - Step 5** Enter your password in the Password field.
 - Step 6** Select **Login**.
 - Step 7** To sign out, select **Logout**.
-

REVIEW DRAFT - CISCO CONFIDENTIAL



CHAPTER 4

Contacts

- [Corporate Directory](#), page 55
- [Personal Directory](#), page 56
- [Fast Dial](#), page 59
- [Fast-Dial Codes with Personal Directory](#), page 59
- [Cisco WebDialer](#), page 61

Corporate Directory



The Corporate Directory menu contains corporate contacts that you can access on your phone. Your system administrator sets up and maintains the directory.

Search and Dial a Contact

Procedure

- Step 1** Press **Contacts** .
- Step 2** Use the Navigation cluster and Select button to scroll and select **Corporate Directory**.
- Step 3** Select one or all of these search criteria to search for a coworker:
- First Name
 - Last Name
- Step 4** Enter the search criteria information, press **Submit**, and select a contact.
- Step 5** To dial, perform one of these actions:
- Press **Call**.
 - Press **Select**.

REVIEW DRAFT - CISCO CONFIDENTIAL

- From the keypad, press the number that displays in the upper right corner of the contact label.
 - Press **Speakerphone** .
 - Press **Headset** .
 - Pick up the handset.
-

Search and Dial a Contact While On a Call

Procedure

- Step 1** Press **Contacts** .
- Step 2** Use the Navigation cluster and Select button to scroll and select **Corporate Directory**.
- Step 3** Select one or both of these search criteria to search for a coworker:
- First Name
 - Last Name
- Step 4** Enter the search criteria information and press **Search** .
- Step 5** Press **Call**.
The phone puts the existing call on hold and makes the new call.
-

Personal Directory

The personal directory contains a list of your personal contacts. You can assign fast-dial codes to your personal directory entries for fast-dialing.

You can set up your personal directory from your phone or from the Cisco Unified Communications Self Care Portal. Use your phone to assign fast-dial codes to the directory entries. For more information, see the *Cisco Unified Communications Self Care Portal User Guide*, located at http://www.cisco.com/en/US/products/sw/voicesw/ps556/products_user_guide_list.html.

REVIEW DRAFT - CISCO CONFIDENTIAL

Sign In and Out of the Personal Directory

Procedure

- Step 1** Press **Contacts** .
- Step 2** Select **Personal Directory**.
- Step 3** Enter the user ID and PIN, and press **Submit**.
- Step 4** Select **Log Out**, press **Select**, and then press **OK**.
-

Add a Personal Directory Entry from the Phone

Procedure

- Step 1** Press **Contacts** .
- Step 2** Sign in to Personal Directory.
- Step 3** Select **Personal Address Book**.
- Step 4** Press **Submit**.
- Step 5** Press **New**. You may need to press **More** first.
- Step 6** Enter the nickname information.
You can also enter a name.
- Step 7** Press **Phones** and enter the phone numbers.
Make sure you include any required access codes, such as 9 or 1.
- Step 8** Press **Submit** to add the entry to your personal directory.
-

Search for an Entry in the Personal Directory

Procedure

- Step 1** Press **Contacts** .
- Step 2** Sign in to Personal Directory.
- Step 3** Select **Personal Address Book**.
- Step 4** Select one or all of the following:
- Last Name

REVIEW DRAFT - CISCO CONFIDENTIAL

- First Name
- Nickname

Step 5 Enter the search criteria information and press **Submit**.

Dial a Number from the Personal Directory

Procedure

- Step 1** Press **Contacts** .
- Step 2** Sign in to Personal Directory.
- Step 3** Select **Personal Directory** and search for an entry.
- Step 4** Select the personal address book entry that you want to dial.
- Step 5** Press **Call**.
-

Edit a Personal Directory Entry

Procedure

- Step 1** Press **Contacts** .
- Step 2** Sign in to Personal Directory.
- Step 3** Select **Personal Address Book** and search for an entry.
- Step 4** Press **Select**.
- Step 5** Press **Edit**.
- Step 6** Modify the entry information.
- Step 7** Press **Phones** to modify a phone number.
- Step 8** Press **Update**.
-

REVIEW DRAFT - CISCO CONFIDENTIAL

Delete a Personal Directory Entry

Procedure

- Step 1** Press **Contacts** .
 - Step 2** Sign in to Personal Directory.
 - Step 3** Select **Personal Address Book** and search for an entry.
 - Step 4** Press **Select**.
 - Step 5** Press **Edit**.
 - Step 6** Press **Delete**.
You may need to press **More** first.
 - Step 7** Press **OK** to confirm the deletion.
-

Fast Dial

Fast Dial allows you dial a phone number from the Fast Dial service on your phone.

Place a Call With a Fast-Dial Button

Procedure

- Step 1** Press **Fast Dial**.
 - Step 2** Sign in to Personal Directory.
 - Step 3** Select **Personal Fast Dials**.
 - Step 4** Select a fast-dial code and then press the **Dial** softkey.
-

Fast-Dial Codes with Personal Directory

You manage the fast-dial codes with Personal Directory using the Contacts menu on your phone.

REVIEW DRAFT - CISCO CONFIDENTIAL

Assign a Fast Dial Code to a Personal Directory Entry

Procedure

- Step 1** Press **Contacts** .
- Step 2** Select **Personal Directory**.
- Step 3** Select **Personal Address Book**.
- Step 4** Enter the name and press **Submit**.
- Step 5** Press **Select** and then press **FastDial**.
- Step 6** Select a number and press **Select**.
- Step 7** Scroll to an unassigned fast-dial index and press **Submit**.
-

Place a Call Using a Fast Dial Code

Procedure

- Step 1** Press **Contacts** .
- Step 2** Sign in to Personal Directory.
- Step 3** Select **Personal Fast Dials** and scroll to a fast-dial code.
Note To get more fast-dial codes, press **Next**.
- Step 4** Select the required fast-dial code and press **Call**.
-

Delete a Fast Dial Code

Procedure

- Step 1** Press **Contacts** .
- Step 2** Sign in to the Personal Directory.
- Step 3** Select **Personal Fast Dials** and search for a fast-dial code.
- Step 4** Select the required code and press **Remove**.
- Step 5** Select the index and press **Remove**.
-

REVIEW DRAFT - CISCO CONFIDENTIAL

Cisco WebDialer

Cisco WebDialer allows you to make calls on your Cisco IP Phone to directory contacts by selecting items in a web browser.

For more information, contact your system administrator.

Use Cisco WebDialer with Another Online Corporate Directory

Procedure

Step 1

Draft comment: Once the engineering team provides the information, the correct access details will be added.

In a web browser, type the address of the Cisco WebDialer-enabled page.

Step 2 Search for the required name and select the required number.

Step 3 When prompted, enter your user ID and password.

Note If you are using Cisco WebDialer for the first time, review preferences on the Make Call window.

Step 4 Select **Call**.

Step 5 Select **Hang up** or hang up the handset after your call completes.

Change Cisco WebDialer Preferences

Procedure

Step 1 Initiate a call using Cisco WebDialer to access the Make Call window.

Step 2 Select one of the following options from the Make Call window:

- Preferred language
- Preferred device

Step 3 Choose a line or a phone.

Note If you have one phone with a single line, the appropriate phone and line are automatically selected.

If you have more than one phone of the same type, the list identifies the phone by device type and MAC address. To display the MAC address on your phone, select **Applications > Phone Information**.

Step 4 If you have an Extension Mobility profile, select **Extension Mobility** from the Calling Device drop-down menu.

Step 5 Ensure that you do not select **Do not display call information** nor **Disable Auto Close**.

REVIEW DRAFT - CISCO CONFIDENTIAL

Note If you select **Do not display call information**, the Make Call Window is not displayed when you next use the phone. If you select **Disable auto close**, the call window does not automatically close after 15 seconds.

Sign Out of Cisco WebDialer

Procedure

- Step 1** Access the Make Call or Hang Up window.
 - Step 2** Select **Sign Out**.
-



Call History

- [Call History Overview, page 63](#)
- [View the Call History, page 65](#)
- [View Call Record Details, page 65](#)
- [Filter the Call History, page 65](#)
- [Dial From the Call History, page 66](#)
- [Edit a Phone Number, page 66](#)
- [Clear the Call History, page 67](#)
- [Delete a Call Record, page 67](#)



Call History Overview

Call History allows you to view information about the last 150 calls on your phone. The Call History lists individual calls and call groups chronologically from the most recent call to the oldest one. If your phone has multiple lines, calls on all lines are added together. The oldest calls over the 150-call limit are dropped from the history.

In the Call History screen, the line information (such as “Line: 5623”) displays in the upper-right corner to indicate the line name or number for which the call history is displayed.

If set up by your administrator, you see icons beside each Call History entry. The icon shows the status (Unknown, Idle, Busy, or DND) of the person who made the call.

For each call record or call group, an icon to the left of the caller ID shows the call type:

- Received: 
- Placed: 
- Missed: 

REVIEW DRAFT - CISCO CONFIDENTIAL

Note On the Cisco IP Phone 8811, the icon is gray.

If the caller ID is unavailable, “Unknown” is displayed, and the phone number is listed.

Calls for the same caller ID and phone number are grouped together only when if they occur in chronological order and do not have calls associated. For each group, the time of the latest call and the number of calls (such as “(3)”) are displayed:

- Incoming (Received) and outgoing (Placed) calls are grouped together.
- Missed calls are grouped together in a separate group.

For each individual call record or call group, the phone number is listed in blue and is contact sensitive for touch dialing.

Hunt group and multiparty calls show an icon to the right of the caller ID that differentiates the call from a normal call, and these calls are not grouped even when they are next to each other in the list.

A plus (+) symbol on entries in call history, redial, or call directory indicates that your phone is set up to list international calls. For more information, contact your system administrator.

The received and placed calls from shared lines are logged in the Call History. To view all the call history logs, open the Call History screen. The following table describes the call state, icon, and tag for shared lines.

Call State	Call Icon	Tag
Locally placed calls		Placed
Locally received calls		Received
Remotely placed calls		Remote Placed
Remotely received calls		Remote Received
Missed calls	 Note On the Cisco IP Phone 8811, the icon is gray.	Missed

Your Call History list displays the status of monitored lines, if the feature is enabled by your system administrator. Each call history item in the Call History lists displays an icon to identify the state of the line. The following states are available:

- Offline
- Idle
- Busy
- DND

REVIEW DRAFT - CISCO CONFIDENTIAL

View the Call History

Procedure

- Step 1** Press **Applications** .
 - Step 2** Select **Recents**.
 - Step 3** Scroll and select a call record or call group.
 - Step 4** Press **Exit** to return to the Applications screen.
-

View Call Record Details

Procedure

- Step 1** If you are on a connected call, press **Show Detail** to show the Call Details screen. This screen displays single call information and call duration and updates each second.
 - Step 2** If you are not on a connected call, follow the steps below.
 - a) Press **Applications**  and select **Recents**.
 - b) Select a call record or group and press **Show Detail**.
 - Note** When you are on a call record, you can keep the Navigation cluster and Select button highlighted to display the call details.
 - c) Press **Return** to return to the Call History screen.
 - d) Press **Exit** to return to the Applications screen.
-

Filter the Call History



Procedure

- Step 1** Press **Applications**  and select **Recents**.
 - Step 2** To sort calls for a specific line, select the required phone line and view the individual calls.
 - Step 3** To sort by missed calls for a specific line, select the required phone line press **Missed Calls**.
 - Step 4** Press **Exit** to return to the Applications screen.
-

REVIEW DRAFT - CISCO CONFIDENTIAL



Dial From the Call History

Procedure

- Step 1** If the phone is not in idle state, perform the following steps:
- a) Press **Applications**  and select **Recents**.
 - b) Select the call record that you want to dial and perform one of the following:
 - Press **Call**.
 - Pick up the handset.
 - Press **Details**.
 - Press **Speakerphone**  or **Headset** .
- Step 2** If the phone is in idle state, press down on the Navigation cluster and Select button to display the On-Hook Dialing screen.
-

Edit a Phone Number

Procedure

- Step 1** Press **Applications**  and select **Recents**.
- Step 2** Press **All Lines** or the required line.
- Step 3** Select the call you want to edit and press **EditDial**.
- Note** Press the Navigation pad right or left to move the cursor.
- Press  to delete the character to the left of the cursor.
- Step 4** Press **Call** to dial the number.
- Step 5** Press **Return**  to return to the Call History list.
-

REVIEW DRAFT - CISCO CONFIDENTIAL

Clear the Call History

Procedure

- Step 1** Press **Applications**  and select **Recents**.
 - Step 2** Select **All Lines** or the required line.
 - Step 3** Press **Clear list** and then press **Delete** to delete the call history list.
 - Step 4** Press **Cancel** to go back to the Call History screen.
-

Delete a Call Record

Procedure

- Step 1** Press **Applications**  and select **Recents**.
 - Step 2** Highlight the individual call record or call group that you want to delete.
 - Step 3** Press **Delete** to delete an individual call record or all calls in a group.
A Delete Record alert message appears for verification.
 - Step 4** Press **Delete** to delete the record.
 - Step 5** Press **Exit** to return to the Applications screen.
-

REVIEW DRAFT - CISCO CONFIDENTIAL



Voicemail

- [Access Voicemail, page 69](#)
- [Check for Voice Messages, page 69](#)
- [Listen to Voice Messages, page 70](#)
- [Visual Voicemail, page 70](#)

Access Voicemail

Procedure

- Step 1** Press **Messages**.
 - Step 2** Follow the voice prompts.
-

Check for Voice Messages

Procedure

Check for voice messages in any of these ways:

- Look for a solid red light on your handset.
You can set up the visual message waiting lamp using the Self Care Portal.
- Look for a colored box beside the line button.

The colored background indicates that there are new voice messages and the number of missed calls and voice mail messages displays in the box.

Note On the Cisco IP Phone 8811, the box is gray.

REVIEW DRAFT - CISCO CONFIDENTIAL

When you select a line with a Message icon, the Login screen displays on the phone screen.

Note If you had selected **Yes** in the Remember me screen when you last logged in, the messages list is displayed.

If there are more than 99 new voice messages, the message count is replaced by a plus (+) sign.

If call forwarding is set up on a line that has new voice messages, the Call Forward icon  replaces the Message icon on the line label.

Note On the Cisco IP Phone 8811, the Call Forward icon is gray.

- Listen for a stutter tone (if available) from your handset, headset, or speakerphone when you place a call.

The stutter tone is line-specific. You hear it only when using the line that has new voice messages.

You can set up audible message waiting tones using the Self Care Portal.

Listen to Voice Messages

After you listen to your new voice messages, the message indicators are updated on the phone screen. If there are no new voice messages, the Message icon is removed from the line label, and the Voicemail icon is removed from the right side of the phone screen.

Procedure

Step 1 To listen to voice messages, do one of the following:

- Press **Messages** . The Login screen displays.

Note If you selected Yes in the Remember me screen when you last logged in, the messages list displays.
- Select a line with colored box beside it. The box indicates the number of messages waiting.

The Cisco IP Phone 8881 displays a gray box.
- Press the line button and then **Voicemail** .

Step 2 Follow the prompts to listen to your voice message.

Visual Voicemail

Visual Voicemail is an alternative to audio voicemail. You use the screen on your phone to work with your messages, rather than respond to audio prompts. You can view a list of your messages and play your messages. You can also compose, reply to, forward, and delete messages.

REVIEW DRAFT - CISCO CONFIDENTIAL

For more information, see *Quick Start Guide for Visual Voicemail* at <http://www.cisco.com/c/en/us/support/unified-communications/unity-connection/products-user-guide-list.html>.

REVIEW DRAFT - CISCO CONFIDENTIAL



Advanced Calling Features

- [Conference, page 73](#)
- [Meet Me Conference, page 75](#)
- [Speed Dial, page 76](#)
- [Do Not Disturb, page 78](#)
- [Malicious Call Identification, page 79](#)
- [Extension Mobility, page 79](#)
- [Mobile Connect, page 80](#)
- [Line Status, page 82](#)
- [Custom Line Filters, page 83](#)
- [Hunt Groups, page 86](#)
- [Barge , page 87](#)
- [Call Chaperone, page 88](#)
- [Uniform Resource Identifier Dialing, page 89](#)
- [Intelligent Proximity for Mobile Devices, page 90](#)
- [Intelligent Proximity for Tablets, page 94](#)

Conference

Conference allows you to talk simultaneously with multiple parties in an ad hoc meeting.

When you are talking on a call, use **Conference** to dial another party and add them to the call.

If you have multiple phone lines, you can alternately use **Conference** to combine two calls across two lines. For example, if you have a call on Line 1 and a call on Line 2, you can combine the calls into a conference.

As the conference host, you can remove individual participants from the conference. The conference ends when all participants hang up.

REVIEW DRAFT - CISCO CONFIDENTIAL

Add a Third Party to a Conference

Procedure

- Step 1** Start with a connected call that is not on hold.
- Step 2** Press **Conference**  and do one of the following:
- Enter the phone number for the party you want to add and press **Call**.
 - Press a speed-dial button.
 - Press **Speed Dial**, enter a speed-dial number, and press **Speed Dial** again.
 - Press **Active Calls** and select a call.
 - Select a call from the Call History.
- Step 3** Wait for the party to answer or skip to step 4 while the call is ringing.
- Step 4** Press **Conference**.
The conference begins.
-

Join Calls Into a Conference

The conference is established on the line that had the active call.

Your system administrator controls the ability to transfer calls from one line to another line.

Procedure

- Step 1** Start with two connected calls.
- Step 2** Make sure that one of the calls is active (not on hold). If both calls are on hold, resume one call.
- Step 3** Press **Conference** .
- Step 4** Press the line button for the other (held) call or if the held call is on another line:
- a) Press **Active Calls**.
 - b) Choose a call from the list.
 - c) Press **Conference**.
- The conference begins. The conference is established on the line that had the active call.
-

Swap Between Calls Before Completing a Conference

You can consult privately with the conference and another person, before adding the person into the conference.

REVIEW DRAFT - CISCO CONFIDENTIAL

Procedure

- Step 1** Call a new conference participant, but do not add the participant to the conference. You must wait until the call is connected.
- Step 2** Press **Swap** to toggle between the participant and the conference.
-

View Conference Participants

You can view the details of the last 16 participants who joined the conference.

Procedure

While in a conference, press **Show Details** to view a list of participants.

Note When you place a call to another party and the person that you called creates a conference with a third phone, the **Show Details** softkey displays only for the person who created the conference.

Remove Conference Participants

Procedure

- Step 1** While in a conference, press **Show Details**.
- Step 2** Highlight the participant that you want to remove, then press **Remove**.
-

Meet Me Conference

Meet Me allows you to call a predetermined number at a scheduled time to host or join a Meet Me conference.

The Meet Me conference begins when the host connects. Participants who call the conference before the host has joined hear a busy tone and must dial again.

The conference ends when all participants hang up; the conference does not automatically end when the host disconnects.

REVIEW DRAFT - CISCO CONFIDENTIAL

Host a Meet Me Conference

Procedure

- Step 1** Obtain a Meet Me phone number from your system administrator.
 - Step 2** Distribute the Meet Me phone number to participants.
 - Step 3** When you are ready to start the meeting, lift the handset to get a dial tone and press **Meet Me**.
 - Step 4** Dial the Meet Me phone number.
-

Join a Meet Me Conference

Procedure

- Step 1** Dial the Meet Me phone number that the conference host provides.
 - Step 2** If you hear a busy tone, the host has not yet joined the conference. In this case, hang up and try your call again.
-

Speed Dial

Speed Dial allows you to press a button and enter a preset code to place a call. Before you can use Speed Dial features on your phone, you must set up speed-dial in the Self Care Portal.

Depending on setup, your phone can support these Speed Dial features:

- **Speed-dial buttons:** Allow you to quickly dial a phone number from one or more line buttons set up for speed dialing.
If your system administrator has set up the Line Status feature, you can monitor the status of a speed-dial line by using the line status indicators.
- **Speed-dial codes:** Allow you to dial a phone number from a code (sometimes referred to as abbreviated dialing).

You can also use Speed Dial to reach telephone numbers that require a Forced Authorization Code (FAC), Client Matter Code (CMC), or additional digits (such as a user extension, a meeting access code, or a voicemail password). These numbers usually require you to input pause characters in the digit string.

Related Topics

[Pause in Speed Dial, on page 77](#)

REVIEW DRAFT - CISCO CONFIDENTIAL

Place a Call with a Speed-Dial Button

Before You Begin

Before you can use speed-dial buttons on your phone, you must set up Speed Dial in the Self Care Portal.

Procedure

To place a call, press a speed-dial button  on the left side of your phone.

Use a Speed-Dial Code On Hook

Before You Begin

Before you can use speed-dial codes on your phone, you must set up Speed Dial in the Self Care Portal.

Procedure

Enter the speed-dial code and press **Speed Dial**.

Use a Speed-Dial Code Off Hook

Before You Begin

Before you can use speed-dial codes on your phone, you must set up Speed Dial in the Self Care Portal.

Procedure

-
- Step 1** Lift the handset and press **Speed Dial**.
 - Step 2** Enter the speed-dial code and press **Speed Dial** again to complete the call.
-

Pause in Speed Dial

You can use Speed Dial to reach destinations that require a Forced Authorization Code (FAC), Client Matter Code (CMC), dialing pauses, or additional digits (such as a user extension, a meeting access code, or a voice mail password). When you press the configured Speed Dial, the phone establishes the call to the destination number and sends the specified FAC, CMC, and additional digits with dialing pauses inserted.

To include dialing pauses in the speed dial, include a comma (,) as part of the speed-dial string. This comma specifies a pause of 2 seconds. It also allows you to separate FAC and CMC from the other digits in the speed-dial string.

REVIEW DRAFT - CISCO CONFIDENTIAL**Note**

Be aware of the following requirements when you include FAC and CMC in the speed-dial string:

- FAC must always precede CMC in the speed-dial string.
- A speed-dial label is required for speed dials with FAC and DTMF digits.
- Only one comma is allowed between FAC and CMC digits in the string.

Each comma you include represents an additional pause of 2 seconds. For example, two commas (,,) represent a pause of 4 seconds.

**Note**

Before you configure the speed-dial, try to dial the specified digits manually at least once to ensure that the digit sequence is correct.

The phone does not save the FAC, CMC, or additional digits from the speed dial in the call history. If you press **Redial** after connecting to a destination using the speed-dial, the phone prompts you to enter any required FAC, CMC, or DTMF digits manually.

Example 1

Consider the following requirements to access voicemail:

- Called number to access voicemail: 8000
- PIN: 123456# after announcement of 2 seconds
- Voicemail response: Enter option 3 to read latest message after a pause of 6 seconds (while the automated announcement lists the available options)

To set up the speed-dial to access this voice mailbox, specify the following speed-dial string:

8000,123456#,,,3

Example 2

Consider the following call requirements

- Called number: 95556543
- FAC: 1234
- CMC: 9876
- Automated phone system response, required 4 seconds after the call is connected: 56789#

To access this destination, specify the following speed-dial string:

95556543,1234,9876,,56789#

Do Not Disturb

Do Not Disturb (DND) allows you to turn off one of the following incoming call indicators:

REVIEW DRAFT - CISCO CONFIDENTIAL

- The ringer on your phone
- The ringer and any visual notification that you have an incoming call

When DND is enabled, your incoming calls forward to another number, such as your voicemail, if it is set up and the call is not saved or listed in your Call History.

The DND feature affects all lines on a phone. The feature does not affect intercom or 911 calls.

You can change your DND options from the Self Care Portal. For information on customizing your Do Not Disturb options, see the *Cisco Unified Communications Self Care Portal User Guide*, located at http://www.cisco.com/en/US/products/sw/voicesw/ps556/products_user_guide_list.html.

Turn DND On and Off

Procedure

-
- Step 1** Press **DND** to turn on DND.
Visual confirmation displays briefly.
- Step 2** Press **DND** again to turn off DND.
Visual confirmation displays briefly.
-

Malicious Call Identification

Malicious Call Identification (MCID) allows you to identify an active call as suspicious, which initiates a series of automated tracking and notification messages.

Trace a Suspicious Call

Procedure

Press **Report Caller** to send a silent notification message to your system administrator.
When the silent notification message is sent, your phone provides both a visual and audible confirmation.

Extension Mobility



Cisco Extension Mobility (EM) allows you to configure a different Cisco IP Phone as your own temporarily. After you sign in to EM, the phone adopts your user profile, including your phone lines, features, established services, and web-based settings. Your system administrator sets up EM for you.

The Cisco Extension Mobility ChangePIN feature allows you to change your PIN from your Cisco IP Phone.

REVIEW DRAFT - CISCO CONFIDENTIAL

Enable Extension Mobility

Procedure

- Step 1** Press **Applications** .
- Step 2** Select **Extension Mobility** (name can vary, including EM Service).
- Step 3** Enter your user ID and PIN (provided by your system administrator).
- Step 4** Select a device profile if prompted.
- Step 5** Press **Applications**  to sign out.
- Step 6** Select **Services**.
- Step 7** Select **Extension Mobility**.
- Step 8** Press **Yes** when prompted to sign out.
-

Mobile Connect

Mobile Connect allows you to use your mobile phone to handle calls that are associated with your desk phone number.

When using Cisco Mobile Connect, you must add your mobile and other phones that you want to use to make and receive calls using the same directory numbers as your desk phone. These phones are called remote destinations. You can also define access lists to restrict or allow calls from certain numbers to be sent to your mobile phone.

When you enable Mobile Connect:

- Your desk phone and remote destinations (your mobile phones) receive calls simultaneously.
- When you answer the call on your desk phone, the remote destinations stop ringing, are disconnected, and display a missed call message.
- When you answer the call on one remote destination, the other remote destinations and desk phone stop ringing and are disconnected, and a missed call message is shown on the other remote destinations.
- When you answer the call on one remote destination and then switch the call to a Cisco Unified device that shares lines, the Cisco Unified devices that share the same line display a `Remote In Use` message.

REVIEW DRAFT - CISCO CONFIDENTIAL

Enable Mobile Connect

Procedure

- Step 1** Press **Mobility** to display the current remote destination status (Enabled or Disabled).
- Step 2** Press **Select** to change the status.
-

Turn Mobile Connect On or Off for All Remote Destinations from a Desk Phone

Procedure

- Step 1** Press **Mobility** or **To Mobile** to display the current remote destination status (Enabled or Disabled).
- Step 2** Press **Select** to change the status.
-

Switch a Desk Phone Call to a Mobile Phone

Procedure

- Step 1** Press **Mobility**.
- Step 2** Press **Select** to send a call to mobile phone.
- Step 3** Answer the in-progress call on your mobile phone.
- Note** You cannot use the same phone line for any other calls, but if your desk phone supports multiple lines, you can use another line to make or receive calls.
-

Switch a Mobile Call to the Desk Phone

Procedure

- Step 1** Hang up the call on your mobile phone to disconnect the mobile phone, but not the call.
- Step 2** Press the line on your desk phone to resume the call on your desk phone within 5 to 10 seconds and start talking on the desk phone.
-

REVIEW DRAFT - CISCO CONFIDENTIAL

Hand Off a Call from a Mobile Phone to the Desk Phone

Procedure





-
- Step 1** While on your mobile phone, enter the access code for the hand off feature. For more information, contact your system administrator.
- Step 2** Hang up the call on your mobile phone to disconnect the mobile phone, but not the call.
- Step 3** Press **Answer** on your desk phone within 10 seconds and start talking on the desk phone. For more information, contact your system administrator. The Cisco Unified devices that share the same line display a Remote In Use message.
-

Line Status

Line Status indicators allow you to view the state of a phone line that is associated with a speed-dial button. Your system administrator sets up Line Status indicators on your phone.

Line Status Indicators

Line Status indicators show the state of a line.

Icon	Indicator
	Line is in use.
	Line is idle.
	Line is ringing. (Only for Call Pickup.)
	Line is in a Do Not Disturb (DND) state.

Line Status indicators can be set up on speed-dial buttons by your system administrator and can be used with these features:

Speed Dial

Allows you to monitor the status of (and dial) a specific number on a speed-dial button. If the monitored line is unavailable, the Line Status button changes to a normal speed-dial button.

REVIEW DRAFT - CISCO CONFIDENTIAL

Directed Call Park

Allows you to monitor the line status of and dial a Directed Call Park number on a speed-dial button.

Call Pickup

Allows you to monitor the line status of (and pick up a ringing call on) a ringing call on a speed-dial button.

Your system administrator can also set up your phone to play an audible alert when a call rings on the monitored line.

Related Topics

[Call Park](#), on page 47

[Speed Dial](#), on page 76

Custom Line Filters

Custom Line Filters enable you to reduce alert activity by filtering it to high-priority lines by allowing you to set the alerting call notification priority on a subset of lines covered by an alert filter. The custom filter generates either traditional pop-up alerts or actionable alerts for incoming calls on the selected lines. For each filter, only the subset of lines under coverage will generate an alert. If a filter is turned off, lines under its coverage will not show alert notifications.

If this feature has been configured, there are three, selectable, filter types available to you:

- All Calls (on all lines)
- Daily schedule
- Custom user

The administrator configures the default line filter, which is visible to you as the Daily schedule filter. Even if the administrator has not configured the default filter, the all calls filter and custom filter options are available to you. If you have not created any custom filters all provisioned lines are covered by the default line filter if it exists, or all calls if it does not.

You cannot edit either the All Calls filter or the Daily schedule filter, but you can use the Daily schedule filter as a template for a new, custom filter by duplicating and then editing the duplicate filter.

You save the custom filters directly to your phone so that you can quickly select and change coverage. You can define a maximum of 20 custom filters, but only one filter may be active at a time.



Note

If both the Custom Line Filters and the Actionable Incoming Call Alert features are enabled, actionable call alerts apply only to the lines that are covered by filters.

REVIEW DRAFT - CISCO CONFIDENTIAL

Add a Line Filter

Procedure

- Step 1** On your phone, go to **Applications > Settings**.
- Step 2** Highlight **Call notifications**, and press **Select**.
The current filter displays next to the option.
- Step 3** Highlight **Add new filter** and press **Select**.
The maximum number of custom filters is 20. If you have already created the maximum number of custom filters, delete a filter before continuing with this procedure.
- Step 4** Press **Select** a second time to make the text editable.
The Show incoming call notification for selected lines screen with available phone lines displays.
- Step 5** Accept the default name for the new filter, or enter a new one.
- Step 6** Select the lines to add to the new filter.
All available lines are displayed in the list. If you require a line that is not in the list, contact your administrator.
- Step 7** Click **Apply**.
- Step 8** To view the filter, press **Back**.
-

Select an Active Line Filter

Procedure

- Step 1** On your phone, select **Applications > Settings**.
- Step 2** Highlight **Call notifications**, and press **Select**.
The currently available filter options display.
- Step 3** Highlight the filter to apply and press **Select**.
-

Delete a Line Filter

Procedure

- Step 1** On your phone, go to **Applications > Settings**.
- Step 2** Highlight **Call notifications**, and press **Select**.
- Step 3** Highlight the filter to be deleted and press **Delete**.

REVIEW DRAFT - CISCO CONFIDENTIAL

The filter is deleted and no longer appears in the list of filters.

Duplicate a Line Filter

Procedure

- Step 1** On your phone, go to **Applications > Settings**.
 - Step 2** Highlight **Call notifications**, and press **Select**.
 - Step 3** Highlight the filter to be duplicated and press **Duplicate**.
 - Step 4** Highlight the duplicated filter and press **Edit**.
 - Step 5** (Optional) Enter a new name for the filter.
 - Step 6** Add or remove available lines from the filter.
 - Step 7** Click **Apply**.
 - Step 8** To view the filter, press **Back**.
-

Edit a Line Filter

Procedure

- Step 1** On your phone, go to **Applications > Settings**.
 - Step 2** Highlight **Call notifications**, and press **Select**.
 - Step 3** Highlight the filter to be edited and press **Edit**.
Note You cannot edit the Daily schedule filter. For more information, contact your administrator.
 - Step 4** (Optional) Enter a new name for the filter.
 - Step 5** Add or remove available lines from the filter.
 - Step 6** Click **Apply**.
 - Step 7** To view the filter, press **Back**.
-

REVIEW DRAFT - CISCO CONFIDENTIAL

Rename a Line Filter

Procedure

- Step 1** On your phone, go to **Applications > Settings**.
 - Step 2** Highlight **Call notifications**, and press **Select**.
 - Step 3** Highlight the filter to be renamed and press **Edit**.
 - Step 4** Enter a new name for the filter.
 - Step 5** Click **Apply**.
 - Step 6** To view the filter, press **Back**.
-

Hunt Groups

Hunt Groups are used to share the call load in organizations that receive a large number of incoming calls.

Your system administrator sets up a hunt group with a series of directory numbers. When the first directory number in the hunt group is busy, the system hunts for the next available directory number in the group and directs the call to that phone.

If you are a member of a hunt group, you sign in to a hunt group when you want to receive calls, and you sign out of the group when you want to prevent calls from ringing on your phone.

Your administrator sets up the Queue Status button so that you can view statistics about the queue for the hunt group.

Calls in the group call queue display the same call identification number, no matter which group phone accesses the list.

Sign In and Out of a Hunt Group

Signing out of a hunt group does not prevent direct calls from ringing your phone.

Procedure

- Step 1** Press **Hunt Group** to sign in.
Visual confirmation displays briefly.
 - Step 2** Press **Hunt Group** again to sign out.
-

REVIEW DRAFT - CISCO CONFIDENTIAL

Display Queue Statistics

Use the queue statistics to check the status of the hunt group queue.

Procedure

- Step 1** Press **Queue Status**.
The Queue status window appears.
 - Step 2** To refresh the statistics, press **Update**.
 - Step 3** To exit, press **Exit**.
-

Barge

Barge allow you to add yourself to nonprivate calls on a shared line. You access the Barge function using the Merge softkey. A conference call is set up with yourself and the participants of the nonprivate call on the Cisco Unified Communications Manager.

Set Up Barge Alert

By default, the Barge Alert option is set to Off and you can barge into an eligible shared lined without receiving a prompt. When the Barge Alert is set to On, an alert prompt is displayed.

Procedure

- Step 1** On your phone, go to **Applications > Settings**.
 - Step 2** At the **Barge Alert** menu item, click **On** to enable the alert or **Off** to enable Barge.
By default, the barge alert prompt is toggled Off.
-

Add Yourself to a Call on a Shared Line

Procedure

Press the line button for the shared line.

Enable Privacy on a Shared Line

Privacy allows you to prevent others who share your line from seeing information about your calls.

REVIEW DRAFT - CISCO CONFIDENTIAL

Privacy applies to all shared lines on your phone. If you have multiple shared lines and Privacy is enabled, others cannot view any of your shared lines.

If the phone that shares your line has Privacy enabled, you can make and receive calls using the shared line as usual.

Procedure

- Step 1** Press **Privacy** to enable the feature.
Visual confirmation displays on your phone screen for as long as the feature is enabled.
- Step 2** Press **Privacy** again to turn off the feature.
-

Dismiss the Barge Alert Prompt Window

When the Prompt for Barge feature is enabled on your phone, you see a pop-up window when you start to barge into a call.

Procedure

Press **No** to cancel the barge, or press any line or session key.

Note The alert closes automatically if the phone opens a new window, if a new alert window opens, or if the current session is no longer available for barge.

Call Chaperone

Call Chaperone allows an authorized Call Chaperone user (the chaperone) to supervise (chaperone) and record a call. Chaperoned calls have a minimum of three parties: the calling party, the chaperone, and the called party. To determine if you are an authorized chaperone, contact your system administrator.

The chaperone answers a call, creates a conference call, and remains on the conference call to chaperone and record the call. Cisco IP Phones that are set up with the Call Chaperone feature also have a **Record** button.

When the chaperone hangs up the call, the entire conference ends.

The chaperone can perform only the following tasks while chaperoning the call:

- Record the call.
- Conference in one participant. A chaperone can conference the first participant only; subsequent participants can be added to the conference only by the other participants in the conference.
- End the call.

REVIEW DRAFT - CISCO CONFIDENTIAL

Record a Chaperoned Call

Procedure

- Step 1** Answer an incoming call.
Record displays if the system determines that the call must be chaperoned and recorded.
- Step 2** Press **Conference**  to create a conference call.
- Step 3** Enter the phone number for the party you want to add and press **Call**.
- Step 4** When the called party answers, press **Conference**.
The conference begins.
- Step 5** Press **Record** to begin recording the conference call.
Alternatively, you can begin recording the call before the conference call is established. In this case, press **Conference** after answering the incoming call. The call gets put on hold automatically, and the recording stops while you set up the conference call. The recording restarts automatically when the conference call is established.
- Step 6** Press **End Call** to end the chaperoned call; all parties are disconnected.
-

Uniform Resource Identifier Dialing

You can place calls using Uniform Resource Identifier (URI) Dialing, using the alphanumeric URI address as a directory number; for example, *bob@cisco.com*. You must enter the URI address to select the contact.

The phone screen displays the call information for the URI call. The phone stores the URI call information in the Call History and the Details page. When you receive a call with a URI address, the URI address is stored in your Call History. Press Redial to call the most recently dialed URI address.

Depending upon how the administrator configures your phone, you may see either the URI or the Directory Number (DN) displayed for the incoming call alerts, call sessions and call history. If the phone is set to display the DN but only the URI is available, then the URI displays. If the phone is set to display the URI and only the DN is available, then the DN displays.



Note URI calls cannot be placed using the soft keypad.

To place an on-hook call using a URI address, you need to press the ABC softkey to switch the keypad mode.

To place an off-hook call using a URI address, the URI address must be stored in your Call History or Speed Dial list.

REVIEW DRAFT - CISCO CONFIDENTIAL

**Note**

When you enter a URI address to place a call, do not pause for more than 10 seconds between key presses. After 10 seconds of inactivity, the phone assumes that it has the complete address and attempts to place the call.

When you dial or receive a call through URI dialing, the call window and incoming call alert display the complete URI address.

When you enter a URI address, the maximum length is 254 characters. You can enter the complete domain name to override the default domain.

URI dialing works with the other features of your phone:

- You can configure a URI address as a speed dial entry to place a call.
- You can configure the Call Forward All destination using the Speed Dial or Call History entries.
- You can initiate a conference call and add multiple parties using URI Dialing if the URI address is stored in the Speed Dial list or Call History.
- You cannot use URI addresses during Meet Me conferences or for Group Call Pickup.
- You can initiate a transfer call using URI dialing if the URI address is stored in the Speed Dial list or Call History.
- You can monitor the state (in-use or idle) of a call using URI Dialing associated with Speed Dial or Call History.
- You can initiate URI Dialing when a busy or unavailable party becomes available.
- You can hide the display of the URI address information.
- When the phones are connected to the Cisco Unified Communications Manager Express and Survivable Remote Site Telephony (CME/SRST), the URI Dialing functions are disabled. The ABC softkey does not appear on the phone screen.

Intelligent Proximity for Mobile Devices

Intelligent Proximity allows you to pair your mobile device to use the mobile line through your Cisco IP Phone. Once the mobile device is paired, you can place and receive calls on the mobile line from your Cisco IP Phone, with either the handset or the speaker. You can also use calling features such as hold and redial with the mobile line.

**Note**

If your Cisco IP Phone does not support Bluetooth then it also does not support Intelligent Proximity for Mobile Devices. For more information, contact your administrator.

You can share your mobile contacts and call history with the Cisco IP Phone, and move calls between your mobile device and Cisco IP Phone. You can also view signal strength and battery level of the mobile device on the Cisco IP Phone.

REVIEW DRAFT - CISCO CONFIDENTIAL



Note You may experience some variances for feature availability due to the operating system and other differences in mobile devices.

Pair a Mobile Device

You can connect one mobile device and one Bluetooth headset at the same time. You cannot connect one mobile device and one tablet at the same time. You can pair multiple mobile devices with the phone, but only one mobile device and one Bluetooth headset can be active at the same time.



Note When you connect your Bluetooth headset and your mobile device at the same time, the Bluetooth headset cannot be used to answer the audio from the mobile device.



Note If your Cisco IP Phone does not support Bluetooth then it also does not support Pair a Mobile Device. For example, Cisco IP Phone 8851NR does not support Bluetooth. For more information, contact your administrator.

You pair the device with the phone to establish a communication path. After you pair your mobile device to your Cisco IP Phone, the phone automatically connects to the mobile device when the device is in range, and disconnects from the mobile device when the device is out of range. When the mobile device disconnects, the mobile line is gray and displays `not connected`.

Procedure

- Step 1** Put the mobile device in discoverable mode.
Note For more information about discoverable mode, see your mobile device documentation.
- Step 2** On your Cisco IP Phone, press **Applications**.
- Step 3** Select **Bluetooth > Add Bluetooth**.
- Step 4** Add new device and select the mobile device from the available devices list to pair.
- Step 5** Verify the passkey on the mobile device and the Cisco IP Phone.
- Step 6** When you are prompted to save mobile contacts, choose to make your mobile device contacts and call history available on your Cisco IP Phone.
-

Switch Connected Mobile Devices

If you have more than one paired mobile device in range of your Cisco IP Phone, you can choose which mobile device to connect.

REVIEW DRAFT - CISCO CONFIDENTIAL**Procedure**

- Step 1** Press the **Applications** button and select **Bluetooth**.
- Step 2** Select a mobile device from the available devices list.
The previously connected mobile device is disconnected, and the selected mobile device is connected.
-

Delete a Mobile Device**Procedure**

- Step 1** Select the mobile device in the available devices list.
- Step 2** Press **Delete**.
-

Answer a Mobile Call**Procedure**

Select **Answer**.

Decline a Mobile Call**Procedure**

Select **Decline**.
The call ends.

Ignore a Mobile Call**Procedure**

Select **Ignore**.
The call ends.

REVIEW DRAFT - CISCO CONFIDENTIAL

Place a Mobile Call

Procedure

- Step 1** Select a mobile line.
 - Step 2** Enter a ten digit number or select a contact from the call history.
 - Step 3** Press **Call**.
-

Move a Call Between the IP Phone and a Mobile Phone

Use your Cisco IP Phone to move an active call to or from your mobile device.

Procedure

- Step 1** To move the call from your Cisco IP Phone to your mobile device, select **Move audio**.
 - Step 2** To move the call from your mobile device to your Cisco IP Phone, select **Move audio**.
-

Adjust the Mobile Device Volume

Volume controls on your Cisco IP Phone and mobile device are synchronized. Synchronization only occurs when there is an active call.

Procedure

While on a call, adjust the volume on either the desk phone or on your mobile device to adjust the mobile device volume.

Mobile Contacts and Mobile Call History Sharing

A paired mobile device displays in **Bluetooth > Accounts** as `Bluetooth`. This account remains until the mobile device is unpaired.

Mobile Contacts can be checked from the Recents menu on the IP phone; Mobile Call History sharing can be found using the New Call softkey.



- Note** If your Cisco IP Phone does not support Bluetooth then it also does not support Mobile Contacts and Mobile Call History Sharing. For example, Cisco IP Phone 8851NR does not support Bluetooth or Mobile Contacts and Mobile Call History Sharing. For more information, contact your administrator.
-

REVIEW DRAFT - CISCO CONFIDENTIAL**Synchronize Bluetooth Contacts**

The contacts automatically synchronize to the Cisco IP phone when the mobile device connected. The contacts update when a call ends or when the mobile device reconnects. There is no need to sync contact manually.

Use the following procedure to check the status of the contacts.

Procedure

-
- Step 1** Press **Contacts**.
- Step 2** Select **Settings**.
- Step 3** Select **Phone Book Access**.
-

Save Bluetooth Contacts

Use this procedure if your Bluetooth Phone Book Access Profile option is No.



Note This procedure only applies to Cisco IP Phone 8851 and 8861. Cisco IP Phone 8851NR does not support Bluetooth.

Procedure

On the Contacts screen, select your mobile phone and check **Save**.

Delete Bluetooth Contacts

Use this procedure if your Bluetooth Phone Book Access Profile option is Save.



Note This procedure only applies to Cisco IP Phone 8851 and 8861. Cisco IP Phone 8851NR does not support Bluetooth.

Procedure

On the Contacts screen, select your mobile phone and check **Delete**.

Intelligent Proximity for Tablets

If you have a tablet, you can pair the tablet to the phone using Bluetooth. After pairing, audio from a soft client phone call on the tablet can be played on the phone. There are no phone call management options for calls from tablets.

The phone supports connections from Android and iOS tablets.

REVIEW DRAFT - CISCO CONFIDENTIAL



Note If your Cisco IP Phone does not support Bluetooth then it also does not support Intelligent Proximity for Tablets. For example, Cisco IP Phone 8851NR does not support Bluetooth and thus it does not support Intelligent Proximity for Tablets. For more information, contact your administrator.

Pair a Tablet

You can connect a tablet and a Bluetooth headset at the same time. You cannot connect a tablet and a mobile phone at the same time.

After you pair your tablet to your Cisco IP Phone, the phone will automatically connect to the tablet when the tablet is in range, and disconnect from the tablet when the tablet is out of range.



Note When you connect your Bluetooth headset and your tablet at the same time, the Bluetooth headset cannot be used to answer the audio from the or tablet.

Cisco IP Phone 8851NR does not support Bluetooth

Procedure

-
- Step 1** Put the tablet in discoverable mode.
- Note** For more information about discoverable mode, see your tablet documentation.
- Step 2** On your Cisco IP Phone, press **Applications**.
- Step 3** Choose **Bluetooth > Add Bluetooth device**.
- Step 4** Select the tablet from the available devices list to pair.
- Step 5** Verify the passkey on the tablet and the Cisco IP Phone.
-

Move Audio from the Tablet to the Phone

Cisco IP Phone 8851NR does not support Bluetooth

Procedure

-
- Step 1** When the soft client call comes to the tablet, set the audio path to use the Bluetooth connection to the phone.
- Step 2** Listen to the audio on the phone using the headset, handset, or speakerphone.
-

REVIEW DRAFT - CISCO CONFIDENTIAL

Manage Tablet Audio on Phone

Cisco IP Phone 8851NR does not support Bluetooth

Procedure

- Step 1** To move the audio from the phone handset to the phone headset, press **Headset**.
 - Step 2** To move the audio from the phone handset to the phone speakerphone, press **Speakerphone**.
 - Step 3** To move the audio from the headset or the speakerphone to the handset, pick up the handset.
 - Step 4** To move the audio back to the tablet, hang up the handset or press **Release**.
 - Step 5** To handle an incoming phone call on the phone, answer the phone.
The audio for the active soft client reverts to the tablet automatically.
-



Advanced Operations

- [Applications](#), page 97
- [Mobile and Remote Access Through Expressway](#), page 98
- [Video Calls and Security](#), page 103
- [Call Functions](#), page 104
- [Feature Buttons and Softkey](#), page 106
- [Survivable Remote Site Telephony Overview](#), page 108

Applications

You can view the applications that are running on your phone, including those that are not under Applications menu; for example, Directories. You may first see the disclaimer required for remote workers, if you have not already accepted it.

View Active Applications

Procedure

- Step 1** Press **Applications** .
- Step 2** Use the Navigation cluster and Select button to scroll and select **Running Applications**. The phone displays a list of applications running on the phone including those that are not under the Application menu.
- Step 3** Press **Exit** to return to the Applications screen.
-

REVIEW DRAFT - CISCO CONFIDENTIAL

Switch to Active Applications

Procedure

- Step 1** Press **Applications** .
- Step 2** Use the Navigation cluster and Select button to scroll and select **Running Applications**.
- Step 3** Choose a running application and press **Switch To** to open and use the selected application.
- Step 4** Press **Exit** to close the application.
-

Close Active Applications

Procedure

- Step 1** Press **Applications** .
- Step 2** Use the Navigation cluster and Select button to scroll and select **Running Applications**.
- Step 3** Select a running application and press **Close App** to close the application. Choose one of the following actions in the alert pop up:
- Press **Close** to close the application without saving the changes.
 - Press **Cancel** to cancel the close application operations.
- Step 4** Press **Exit** to return back to the Applications screen.
-

Mobile and Remote Access Through Expressway

Mobile and Remote Access Through Expressway lets you easily and securely connect into your corporate network when working away from your corporate office (off-site). This feature is enabled by default.

When your phone detects that it is in off-premises mode, the Mobile and Remote Access Through Expressway sign-in window appears, and you can sign in to your corporate network.



Note If your phone firmware is not up to date, you must upgrade the firmware while you are on-site. Otherwise Mobile and Remote Access Through Expressway may not function correctly. For more information, contact your administrator.

REVIEW DRAFT - CISCO CONFIDENTIAL**Note**

If the DHCP option 150 is enabled on your network router, you may have trouble logging in to the corporate network. Disable DHCP option 150 on your router and configure the static IP address directly.

Phone Features Available for Mobile and Remote Access Through Expressway

Mobile and Remote Access Through Expressway provides secure VPN-less access to collaboration services for Cisco mobile and remote users. But to preserve network security, it limits access to phone features.

The following table shows the phone features available with Mobile and Remote Access Through Expressway.

Table 1: Available Phone Features for Mobile and Remote Access Through Expressway

	Available Phone Feature
1.	Abbreviated Dialing
2.	Assisted Directed Call Park
3.	Busy Lamp Field (BLF)
4.	Busy Lamp Field (BLF) Pickup
5.	Busy Lamp Field (BLF) Speed Dial
6.	Call Back
7.	Call Forward
8.	Call Forward Notification
9.	Call Park
10.	Call Pickup
11.	Conference
12.	Direct Transfer
13.	Directed Call Park
14.	Divert
15.	Do Not Disturb (DND)
16.	Group Call Pickup
17.	Hold/Resume

REVIEW DRAFT - CISCO CONFIDENTIAL

	Available Phone Feature
18.	Hold Reversion
19.	Immediate Divert
20.	Join
21.	Meet Me Conference
22.	Message Waiting Indicator
23.	Mobile Connect
24.	Mobile Voice Access
25.	Music On Hold
26.	Mute
27.	Onhook Dialing
28.	Plus Dialing
29.	Redial
30.	Speed Dial
31.	Transfer
32.	Uniform Resource Identifier (URI) Dialing
33.	Visual Voicemail
34.	Voice Message System

Sign in with Mobile and Remote Access Through Expressway

**Tip**

You can store your login information with User Credentials Persistent for Expressway Sign-In. Contact your administrator to enable this feature.

Before You Begin

Before you can connect to your corporate network using Mobile and Remote Access Through Expressway, you must have a valid service name, username, and password. If you do not have this information, contact your administrator.

REVIEW DRAFT - CISCO CONFIDENTIAL

Procedure

Step 1 Enter your service name in the **Service Name** field.

Draft comment: Design team: Please provide the updated information on how to enter the menu.

Step 2 Enter your username in the **Username** field.

Step 3 Enter your password in the **Password** field.

Step 4 Press **Submit**.

If a login is unsuccessful, an error message appears; log in again, or cancel the login procedure.

Cisco Collaboration Problem Reporting Tool

When you are signed in to your network with Mobile and Remote Access Through Expressway, you can use the Cisco Collaboration Problem Report Tool (PRT) to collect and send phone logs - and to report problems to your system administrator. This tool is found on the **Phone Information** screen.

PRT is available only when your phone is Off-Premises mode and you are connected to your corporate network with Mobile and Remote Access Through Expressway.

Report a Problem with Cisco Collaboration Problem Reporting Tool



Note The Cisco Collaboration Problem Reporting Tool may fail to upload your phone logs. If this happens, an error message appears with an IP address. Use the generated IP address to access the logs from the phone.

Before You Begin

You must be logged in to your corporate network with Mobile and Remote Access Through Expressway before you can report a Problem with Cisco Collaboration Problem Reporting Tool (PRT).

REVIEW DRAFT - CISCO CONFIDENTIAL**Procedure**

-
- Step 1** Press **Applications**.
 - Step 2** Select **Phone Information**.
 - Step 3** Press **Report Problem**.
 - Step 4** Enter the current date in the **Date of Problem** field. Use the format dd/mm/yyyy. The current date appears in this field by default.
 - Step 5** Enter a time into the **Time of Problem** field. The current time appears in this field by default.
 - Step 6** Select **Problem Description**.
 - Step 7** Select a description from the displayed list.
 - Step 8** Press **Submit**.
-

Set Up a VPN Phone for Mobile and Remote Access Through Expressway

If your phone is set up for use with a virtual private network (VPN), you must reset the Network Settings to clear the Alternate TFTP setting before you can access your company network with Mobile and Remote Access Through Expressway. This ensures that the phone detects the off-premises network and stops the phone from making a VPN connection.

Before You Begin

Draft comment: Design Team: Please confirm this procedure

To complete this procedure, you must have a valid service name, username, and password. If you do not have this information, contact your administrator.

Procedure

-
- Step 1** Choose **Admin Settings** from the **Applications** menu.
 - Step 2** Choose **Reset Settings**.
 - Step 3** Choose **Network Settings**.
 - Step 4** Log in to your network with Mobile and Remote Access Through Expressway.
-

Set Up a Phone for Use with VPN**Before You Begin**

REVIEW DRAFT - CISCO CONFIDENTIAL

Draft comment: Design Team: Please confirm this procedure

To complete this procedure, you must have a valid TFTP server address, service name, username, and password. If you do not have this information, contact your administrator.

Procedure

-
- Step 1** Choose **Admin Settings** from the **Applications** menu.
 - Step 2** Choose **Reset Settings**.
 - Step 3** Choose **Network Settings**.
 - Step 4** Log in to your network with Mobile and Remote Access Through Expressway.
 - Step 5** Choose **Admin Settings** from the **Applications** menu.
 - Step 6** Choose **Ethernet Setup**.
 - Step 7** Choose **IPv4 Setup**.
 - Step 8** Choose **TFTP server 1**.
 - Step 9** Enter your TFTP server address in the **TFTP server 1** field.
 - Step 10** Choose **Apply**.
 - Step 11** Choose **Exit**.
-

Turn Off the Alternate TFTP Server

If you are off-premises but the Mobile and Remote Access Through Expressway sign-in window does not appear on your phone, the Alternate TFTP setting may be turned on. The Alternate TFTP setting must be set to Off. To turn off the Alternate TFTP setting, follow these steps.

Procedure

-
- Step 1** Choose **Applications** .
 - Step 2** Choose **Admin Settings > Ethernet Setup > IPv4 Setup**.
 - Step 3** Set the Alternate TFTP Setting to **Off**.
-

Video Calls and Security

The audio for a call can be secure or nonsecure. Similarly, the video stream for a call can be secure or nonsecure. Depending on the system configuration, the Secure icon displays when only audio stream is secure or when both audio and video streams are secure. For more information, contact your system administrator.

REVIEW DRAFT - CISCO CONFIDENTIAL

Call Functions

This section provides information about some of the advanced call functions that are available on Cisco IP Phones.

Agent Greeting

Agent Greeting allows you to create and update a prerecorded greeting that plays at the beginning of a call, such as a customer call, before you begin the conversation with the caller. You can prerecord a single greeting or multiple greetings as needed.

When a customer calls, both parties hear the prerecorded greeting. You can remain on mute until the greeting ends or answer the call over the greeting.

For more information, contact your system administrator.

Alert Calls

The Alert Calls feature allows you to view a list of all Alert Calls in chronological order (oldest to most recent). You interact with this feature using a programmable line key, which makes it easier to view all of the Alert Calls that are received across your phone lines.

An Alert Call is a specific phone number that you consider important and want to be alerted to when you receive a call from or make a call to this number.

System administrators set up the Alert Calls button. For more information, contact your system administrator.

Actionable Incoming Call Alert

The Actionable Incoming Call Alert displays an actionable alert instead of a toast alert when you receive an incoming call. In addition to displaying incoming caller details, the actionable alert allows you to answer, ignore, or divert the call.

Your administrator configures the Actionable Incoming Call Alert. By default, this actionable alert is disabled.

**Note**

If both the Custom Line Filters and the Actionable Incoming Call Alert features are enabled, actionable call alerts apply only to the lines that are covered by filters.

Answer

Answer allows you to answer the oldest call that is available on all line appearances on your phone, including Hold Reversion and Park Reversion calls that are in an alerting state. Incoming calls always have priority over Held or Park Reversion calls.

Your system administrator sets up the **Answer** button depending on your call-handling needs and work environment. Typically, the Answer is set up if you have multiple lines.

REVIEW DRAFT - CISCO CONFIDENTIAL

When you get a call, you see a notification window on the phone screen, called a call toast. The call toast remains visible for a preset amount of time. Your system administrator sets up the default time.

If an incoming call has been call forwarded from another phone, you may see additional information in the call toast to identify that the call has been forwarded. Your system administrator controls the amount of additional information displayed. Additional information can identify the person who forwarded the call to you and the caller information.

Client Matter Code

Your administrator may require that you enter a Client Matter Code (CMC) after you dial a phone number. The CMC can be used for accounting or billing codes. For more information, contact your system administrator.

When you need to enter a CMC, the phone displays `Enter Client Matter Code`, the dialed number changes to `*****`, and you hear a special tone. Enter the CMC for the call using the keypad.

Related Topics

[Forced Authorization Code, on page 105](#)

Forced Authorization Code

Your administrator may require that you enter a Forced Authorization (FACC) after you dial a phone number. The FAC controls access to phone numbers. For more information, contact your system administrator.

When you need to enter an FAC, the phone displays `Enter Authorization Code`, the dialed number changes to `*****`, and you hear a special tone. Enter the FAC for the call using the keypad. For security reasons, the phone displays a `*` instead of the number entered.

Related Topics

[Client Matter Code, on page 105](#)

Secure and Nonsecure Indication Tones

When a phone is configured as secure (encrypted and trusted), it can be given a “protected” status. After a phone is protected, it can be configured to play an indication tone at the beginning of a call.

You will hear these secure or nonsecure indication tones only on protected phones. If the overall call status changes during the call, the protected phone plays the appropriate tone.

When the Play Secure Indication Tone option is enabled (True), the following circumstances determine the type of tone the protected phone plays:

- If end-to-end secure media is established and the call status is secure, the phone plays the secure indication tone (three long beeps with pauses)
- If end-to-end nonsecure media is established and the call status is not secure, the phone plays the nonsecure indication tone (six short beeps with brief pauses)
- When the Play Secure Indication Tone option is disabled, no tone plays.

For more information, contact your system administrator.

REVIEW DRAFT - CISCO CONFIDENTIAL

Shared Lines

Shared lines allow you to use one phone number for multiple phones and either you or your coworker can answer the call. When the line flashes red, your coworker can pick up the call.

If you share a line with a coworker:

- When a call comes in on the shared line:
 - Your phone rings, the line button is solid amber, and the session button flashes amber.
 - Your coworker's phone rings, the line button is solid amber, and the session button flashes amber.
- When your coworker has a call on the shared line:
 - If your coworker has privacy enabled, the shared line button is solid red, the session button is solid red, but the call information does not display on your phone.
 - If your coworker does not have privacy enabled, the shared line button is solid red, the session button is solid red, and the call information (name and number, if available) displays on your phone.
- If you put the call on hold:
 - Your line button is solid green and the session button pulses green
 - Your coworker's line button is solid red and the session button pulses red.
- You or the coworker can join a call on the shared line using the Barge feature. Barge converts the call into a conference. To barge, press the red session button for the remote in-use call on the shared line.

Feature Buttons and Softkey

Depending on how your system administrator set up your phone, some features included in this guide may not be available to you.

The following table provides information about some of the features that are available on softkeys and dedicated feature buttons and some that your system administrator can set up on programmable feature buttons. Features that appear on softkeys are set up by your system administrator.

Feature name	Dedicated feature button	Programmable feature button	Softkey
Alert Calls		X	
All Calls		X	
Answer		X	X
Barge			X Displays as Merge
Call Back		X	X

REVIEW DRAFT - CISCO CONFIDENTIAL

Feature name	Dedicated feature button	Programmable feature button	Softkey
Call Forward All			X
Call Park		X	X
Call Park Line Status		X	
Call Pickup (Pick Up)		X	X
Call Pickup Line Status		X	
Conference	X		X
Decline			X
Do Not Disturb		X	X
Group Pickup (Group Pick Up)		X	X
Hold	X		X
Hunt Groups		X	
Intercom		X	
Malicious Call Identification (MCID)		X	X
Meet Me		X	X
Mobile Connect (Mobility)		X	X
Mute	X		
Other Pickup		X	X
PLK Support for Queue Status			X
Privacy		X	
Queue Status		X	
Quality Reporting Tool (QRT)		X	X
Record			X

REVIEW DRAFT - CISCO CONFIDENTIAL

Feature name	Dedicated feature button	Programmable feature button	Softkey
Redial		X	X
Speed Dial		X	X
Speed Dial Line Status		X	X
Support for Hold Button on USB Headsets			X
Transfer	X		X

Survivable Remote Site Telephony Overview

If communication between your phone and the Cisco Unified Communications Server is interrupted, you receive an alert message on your phone. If you are on an active call, the call remains established, and you enter a failover situation. This failover is the Survivable Remote Site Telephony (SRST) feature.

While in failover, not all the features of your phone are available. The following table describes typical feature and feature availability, although not all the features may be supported on your phone. For more information about feature availability during failover, contact your system administrator.

**Note**

SRST does not support IPv6.

Table 2: Feature Support During Failover

Feature	Supported	Notes
New Call	Yes	
End Call	Yes	
Redial	Yes	
Answer	Yes	
Hold	Yes	
Resume	Yes	
Conference	Yes	
Conference to Active Calls (Join)	No	The Active Calls softkey does not display.

REVIEW DRAFT - CISCO CONFIDENTIAL

Feature	Supported	Notes
Conference List	No	
Transfer	Yes	
Transfer to Active Calls (Direct Transfer)	No	
Auto Answer	Yes	
Call Waiting	Yes	
Caller ID	Yes	
Audible Message Waiting Indicator	Yes	
All Calls Programmable Line Key	Yes	
Answer Programmable Line Key	Yes	
Unified Session Presentation	Yes	Conference is the only feature supported.
Voicemail	Yes	Your voicemail will not be synchronized with other users in the Cisco Unified Communications Manager cluster.
Speed Dial	Yes	
Service IRL Programmable Line Key	Yes	
To Voicemail (iDivert)	No	The iDivert softkey does not display.
Line Filters	Partial	Lines are supported but cannot be shared.
Park Monitoring	No	The Park softkey does not display.
Merge	No	The Merge softkey does not display.
Enhanced Message Waiting Indication	No	Message count badges do not appear on the phone screen. Only the Message Waiting icon displays.

REVIEW DRAFT - CISCO CONFIDENTIAL

Feature	Supported	Notes
Directed Call Park	No	The softkey does not display.
Hold Reversion	No	Calls remain on hold indefinitely.
Remote Hold	No	Calls appear as Local Hold calls.
Meet Me	No	The Meet Me softkey does not display.
PickUp	No	The softkey causes no action.
Group PickUp	No	The softkey causes no action.
Other PickUp	No	The softkey causes no action.
Malicious Call ID	No	The softkey causes no action.
QRT	No	The softkey causes no action.
Hunt Group	No	The softkey causes no action.
Intercom	No	The softkey causes no action.
Mobility	No	The softkey causes no action.
Privacy	No	The softkey causes no action.
Call Back	No	The Call Back softkey does not display.
Shared line	Yes	
BLF Speed Dial	Yes	
Video	Yes	Video conference is not supported.

When your phone loses connectivity, your phone may display a message like this: *Service interruption. Some features unavailable.*



User Preferences

- [Change the Wallpaper, page 111](#)
- [Change the Ringtone, page 112](#)
- [Adjust the Phone Screen Brightness, page 112](#)
- [Adjust Phone Screen Contrast, page 112](#)
- [Change the Font Size, page 113](#)
- [Change the Phone Name, page 114](#)
- [Adjust the Headset Sidetone, page 114](#)
- [Phone Services, page 115](#)
- [Line Settings, page 115](#)

Change the Wallpaper

Your system administrator controls if you can change the wallpaper. If you can change the wallpaper, you can set up your phone with wallpapers that are provided with the phone, or with your own custom wallpaper. For more information, contact your system administrator.

Procedure



- Step 1** Press **Applications** .
 - Step 2** Use the Navigation cluster and Select button to scroll and select **Settings**.
 - Step 3** Select **Wallpaper** and select a wallpaper option.
 - Step 4** Press **Preview** to see the wallpaper on your phone screen.
 - Step 5** Press **Set** to apply the wallpaper to the phone.
-

REVIEW DRAFT - CISCO CONFIDENTIAL

Change the Ringtone

You can choose a different ringtone for each line that your phone plays to indicate an incoming call. For information about adding custom ringtones to your phone, contact your system administrator.

Procedure

- Step 1** Press **Applications** .
- Step 2** Use the Navigation cluster and Select button to scroll and select **Settings**.
- Step 3** Select **Ringtone**.
- Step 4** If your phone has multiple lines, select a line and press **Edit** or **Select**.
- Step 5** Highlight a ringtone.
- Step 6** Press **Select** or **Edit**.
- Step 7** Press **Play** to play the sample ringtone.
- Step 8** Press **Set** to apply the ringtone.
- Step 9** To apply the ringtone to all lines, press **Apply To All**.
- Step 10** Press **Return**  to return to the Settings screen.
-

Adjust the Phone Screen Brightness

You can adjust your phone screen brightness level.

Procedure

- Step 1** Press **Applications** .
- Step 2** Use the Navigation cluster and Select button to scroll and select **Settings**.
- Step 3** Select **Brightness**.
- To increase brightness, press up or right on the Navigation cluster.
 - To decrease brightness, press down or left on the Navigation cluster.
- Step 4** Press **Save** to set the brightness, or press **Cancel** to exit.
-

Adjust Phone Screen Contrast

You can adjust the contract on the Cisco IP Phone 8811.

REVIEW DRAFT - CISCO CONFIDENTIAL**Procedure**

-
- Step 1** Press **Applications** .
- Step 2** Use the Navigation cluster and Select button to scroll and select **Settings**.
- Step 3** Select **Contrast**.
- To increase contrast, press up or right on the Navigation cluster.
 - To decrease contrast, press down or left on the Navigation cluster.
- Step 4** Press **Save** to set the contrast, or press **Cancel** to exit.
-

Change the Font Size

You can increase or decrease the maximum number of characters the phone displays by changing the font size for the displayed characters. To increase the maximum number of displayed characters, select a smaller font size. To decrease the maximum number of displayed characters, select a larger font size.

The font size affects the following labels:

- call screen (caller name and feature key label)
- caller name in the Call History
- line label on the phone screen
- line label on the Cisco IP Phone 8800 Key Expansion Module (KEM)

The following table describes the configuration setting and the corresponding font sizes.

Configuration Setting	Line Label	Call Session: Caller Name	Call Session: Caller Number	Call History	KEM
Huge	1st Line: 26 px 2nd Line: 22 px	26 px	22 px	Name: 26 px Number: 24 px	1st Line: 26 px 2nd Line: 22 px
Large	1st Line: 24 px 2nd Line: 20 px	24 px	20 px	Name: 24 px Number: 22 px	1st Line: 24 px 2nd Line: 20 px
Regular (default)	1st Line: 22 px 2nd Line: 18 px	22 px	18 px	Name: 22 px Number: 20 px	1st Line: 22 px 2nd Line: 18 px
Small	1st Line: 20 px 2nd Line: 16 px	20 px	16 px	Name: 20 px Number: 18 px	1st Line: 20 px 2nd Line: 16 px
Tiny	1st Line: 18 px 2nd Line: 14 px	18 px	14 px	Name: 18 px Number: 16 px	1st Line: 18 px 2nd Line: 14 px

REVIEW DRAFT - CISCO CONFIDENTIAL

Procedure

- Step 1** Press **Applications** .
- Step 2** Use the Navigation cluster and Select button to scroll and choose **Settings**.
- Step 3** Choose **Font Size**.
- Step 4** Choose **Huge**, **Large**, **Regular**, **Small**, or **Tiny** and press **Set**.
- Step 5** Press **Exit** to return to the Settings screen.
-

Change the Phone Name

You can change the name of the phone from the default name.

Procedure

- Step 1** On the phone, select **Applications > Settings**.
- Step 2** Scroll and select **Phone Name**.
- Step 3** Use the keypad to enter a name.
- Step 4** Press **Apply** to save the changes or press **Revert** to cancel the change.
- Step 5** Press **Exit**.
-

Adjust the Headset Sidetone

If your system administrator has sets the Headset Sidetone Controls feature for your phone, you can specify the volume of your headset from your phone.

Procedure

- Step 1** Press **Applications** .
- Step 2** Use the Navigation cluster and Select button to select **Settings**.
- Step 3** Select **Headset Sidetone**.
- Step 4** Select one of these sidetone levels:
- Off
 - Low
 - Normal

REVIEW DRAFT - CISCO CONFIDENTIAL

- High
-





Phone Services

Phone services can include special phone features, network data, and web-based information (such as stock quotes and movie listings). You must subscribe to a phone service using the Self Care Portal before you access it on your phone.

For more information, contact your system administrator.

If only one service is set up, the service opens by default. If more than one service is set up, select an option from the menu.

Select a service by using one of these feature buttons:

-  (Feature button that your system administrator sets up)
-  Messages
-  Applications
-  Contacts

For information on Cisco Unified Communications Self Care Portal, see the *Cisco Unified Communications Self Care Portal User Guide*, located at http://www.cisco.com/en/US/products/sw/voicesw/ps556/products_user_guide_list.html.

Line Settings

Line settings affect a specific phone line (directory number) on your phone. Line settings can include call forwarding, visual and audio message-waiting indicators, voice-message indicators, ring patterns, and other line-specific settings.

You can change your line settings using the Cisco Unified Communications Self Care Portal. For information, see the *Cisco Unified Communications Self Care Portal User Guide*, located at http://www.cisco.com/en/US/products/sw/voicesw/ps556/products_user_guide_list.html.

REVIEW DRAFT - CISCO CONFIDENTIAL



Cisco Unified Video Camera

- [Install Cisco Unified Video Camera, page 117](#)
- [View Camera Details, page 119](#)
- [Cisco Unified Video Camera Features, page 119](#)
- [Camera Lens Shutter, page 120](#)
- [Camera Preferences, page 121](#)
- [Reset Camera, page 124](#)

Install Cisco Unified Video Camera

The Cisco Unified Video Camera can be mounted on your Cisco Unified IP Phone 8845 or 8865, or it can be mounted on your computer monitor. If you need help installing or positioning your camera, contact your system administrator.

Mount Camera on Phone

Procedure

- Step 1** Remove the protective plastic from the camera lens and body.
- Step 2** On the phone, remove the small plastic cover located on the topside of the phone display.
- Step 3** With your phone idle (no calls), slide the camera USB connector (on the bottom of the camera) into the Phone USB port (on the back of the phone display).
As you do this, pins on the underside of the camera fit into pinholes on the top of the phone display to further stabilize the camera.

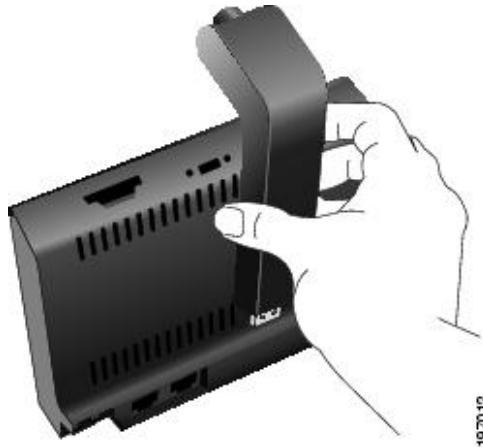
REVIEW DRAFT - CISCO CONFIDENTIAL

- Step 4** Look for the installation confirmation message on the phone screen.
- Step 5** After installation is complete, adjust the View Area and Brightness settings as needed.
-

Mount Camera on Monitor**Procedure**

- Step 1** Obtain a mounting clip and USB extension cable from your system administrator.
- Step 2** Remove the protective plastic from the camera lens and body.
- Step 3** Plug the USB extension cable into the USB port on the back of the phone display.
- Step 4** Place the camera in the mounting clip, as shown in the following figure.



- Step 5** With your phone idle (no calls), attach the USB cable to the USB connector on the bottom of the camera.
- Step 6** Adjust the mounting clip as needed to rest securely on your computer monitor.

REVIEW DRAFT - CISCO CONFIDENTIAL

As shown in the following figure, the mounting clip has two removable sliding supports (small and large). Choose the support that best fits your computer monitor; you can remove the remaining support.

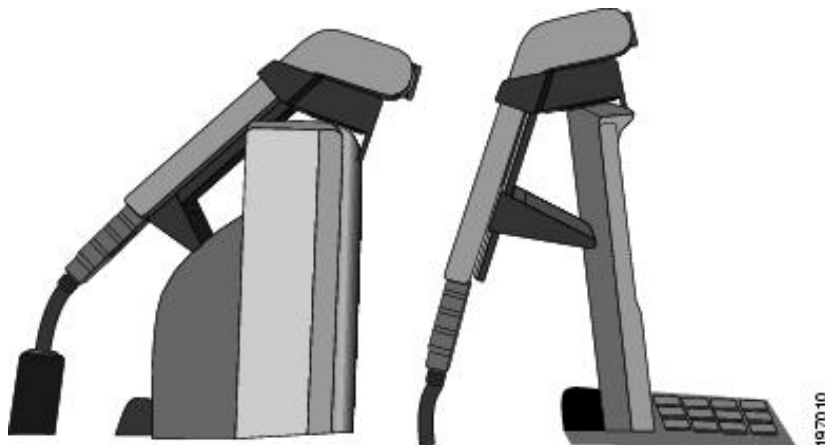



Step 7 Look for the installation confirmation message on the phone screen.

Step 8 After installation is complete, adjust the View Area and Brightness settings as needed.

View Camera Details

Procedure

- Step 1** Press **Applications** .
 - Step 2** Use the Navigation pad and Select button to scroll and select **Accessories**.
 - Step 3** Select **Cisco Unified Video Camera** and press **Details**.
 - Step 4** Press **Return**  to return to the Accessories screen.
-

Cisco Unified Video Camera Features

The Cisco Unified Video Camera includes the following features.

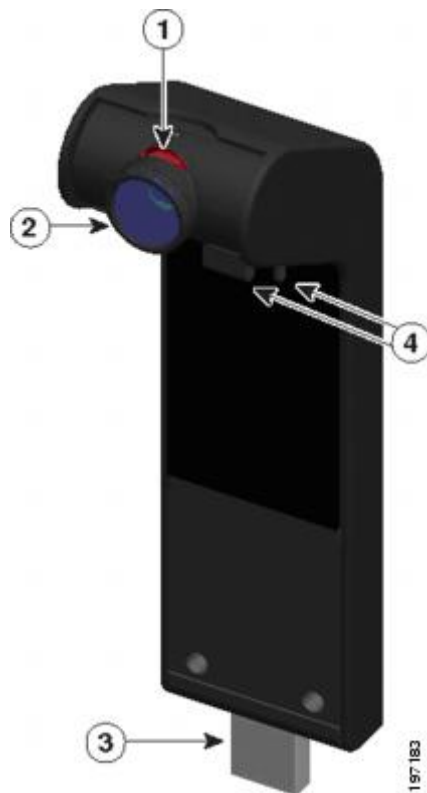
REVIEW DRAFT - CISCO CONFIDENTIAL

1	LED: Indicates the state of the camera as follows: <ul style="list-style-type: none"> • Video transmitting—Green • Video muted—Red 	2	Camera lens: Swivels up and down to adjust the camera angle. The lens shutter can close to block video transmission.
3	USB connector	4	Mounting pins: Secures the camera to your Cisco Unified IP Phone. The pins fit into the designated slots on top of the phone.

Camera Lens Shutter

The camera lens shutter allows you to physically block video transmission from your camera.

REVIEW DRAFT - CISCO CONFIDENTIAL

Close Camera Lens Shutter



The following figure shows the location of the camera lens shutter.

Procedure

-
- Step 1** To close the shutter, rotate the lens clockwise.
- Step 2** To open the shutter, rotate the lens counterclockwise.
-

Camera Preferences

Camera preferences allows you to set user preferences for the following items:

- Auto Transmit
- Brightness
- Viewing Areas



Enable Auto Transmit

When Auto Transmit Video is on, the camera streams video automatically during calls.

When Auto Transmit is off, video for each call is automatically muted (however, your phone still receives video).

REVIEW DRAFT - CISCO CONFIDENTIAL

Procedure



- Step 1** Press **Applications** .
- Step 2** Use the Navigation pad and Select button to scroll and select **Accessories**.
- Step 3** Select **Cisco Unified Video Camera**.
- Step 4** Press **Set-up**.
- Step 5** Press **Turn On** to enable the Auto Transmit feature, or press **Return**  to return to the Set-up screen.
-

Adjust Camera Brightness

The brightness setting affects the video that you transmit to others; it does not affect video that you receive from other parties.

Because the field of view can affect brightness, adjust the View Area before adjusting the brightness.

Procedure

- Step 1** Press **Applications** .
- Step 2** Use the Navigation pad and Select button to scroll and select **Accessories**.
- Step 3** Select **Cisco Unified Video Camera**.
- Step 4** Select **Brightness**.
- To increase brightness, press the right or up arrow on the Navigation pad.
 - To decrease brightness, press the left or down arrow on the Navigation pad.
- Step 5** Press **Save** to set the brightness, or press **Return**  to return to the Setup screen.
-



Adjust Camera View Area

The view area acts as a wide angle and zoom function for your camera:

- Increasing the view area allows the camera to capture a wider image field.
- Decreasing the view area acts as a zoom and narrows the image field.

REVIEW DRAFT - CISCO CONFIDENTIAL

Procedure

- Step 1** Press **Applications** .
- Step 2** Use the Navigation pad and Select button to scroll and select **Accessories**.
- Step 3** Select **Cisco Unified Video Camera**.
- Step 4** Select **View Area**
- To increase the camera viewing area, press the right or up arrow on the Navigation pad.
 - To decrease the camera viewing area, press the left or down arrow on the Navigation pad.
- Step 5** Press **Save** to set the contrast, or press **Return**  to return to the Setup screen.
-

Access Preview Video

Preview Video allows you to see the view from your camera when you are not in a video call. Use Preview Video before making video calls to help set up and position your camera effectively.

Procedure

- Step 1** Press **More**.
- Step 2** Press **Preview Video**.
-

Enable Video

The Enable Video On/Off settings in the phone menu controls the ability to control the video capability of the phone. If you enable video, you identify the phone as being capable of sending and receiving video. If you disable video, your calls use only audio. Your system administrator controls the ability to use video for calls.

Follow these steps to turn this feature on or off:

Procedure

- Step 1** Press **Applications**.
- Step 2** Use the navigation pad and Select button to select **Preferences**.
- Step 3** Select **Video**.
- Step 4** Press **On/Off** softkey or **Select** button to toggle video on or off.
-

REVIEW DRAFT - CISCO CONFIDENTIAL

Reset Camera

Procedure

- Step 1** Press **Applications** .
- Step 2** Use the Navigation pad and Select button to scroll and select **Accessories**.
- Step 3** Select **Cisco Unified Video Camera** and press **Reset**.
The phone resets the default configuration of the Cisco Unified Video Camera.
- Step 4** Press **Cancel** to return to the Accessories screen.
-



Accessories

- [Accessory List](#), page 125
- [View the Accessories List](#), page 126
- [View Accessories Details](#), page 126
- [USB Devices](#), page 127
- [Set Up Wideband for an Analog Headset](#), page 128
- [Bluetooth Headsets](#), page 129
- [USB Headsets](#), page 132
- [Cisco IP Phone 8800 Key Expansion Module](#), page 132

Accessory List

Your phone supports accessories from Cisco and third-party manufacturers.

Cisco Accessories					
Cisco IP Phone 8800 Key Expansion Module	Add-on module	—	X	X	X
Cisco Unified Camera	Add-on module	—	—	—	—
Virtual desktop infrastructure (VDI) client	Add-on module	X	X	X	X
Third-Party Accessories					

REVIEW DRAFT - CISCO CONFIDENTIAL

Headset	Analog	X	X	X	X
	Analog Wideband	X	X	X	X
	Bluetooth	—	X	—	X
	USB	—	X	X	X
Microphone	External PC	—	—	—	X
Speakers	External PC	—	—	—	X

View the Accessories List

You can connect external hardware to your phone using the headjack, Bluetooth, or USB. The accessory list, by default, contains an analog headset that can be set up to enable wideband.

Procedure

-
- Step 1** Press **Applications** .
- Step 2** To view most accessories, use the Navigation cluster and Select button to scroll and select **Accessories**. A list of phone accessories displays.
- Step 3** To view the Bluetooth accessories, use the Navigation cluster and Select button to scroll and select **Bluetooth**. A list of Bluetooth accessories displays.
- Step 4** Press **Exit** to return to the Applications screen.
-

View Accessories Details

Procedure

-
- Step 1** Press **Applications** .
- Step 2** Use the Navigation cluster and Select button to scroll and select **Accessories**. A list of phone accessories displays.
- Step 3** Select an accessory from list and press **Show Detail**. The phone screen displays the details of selected accessory. The information displayed on the phone screen depends on the accessory selected. Most of the accessories provide these details:
- Device Name
 - Hostname

REVIEW DRAFT - CISCO CONFIDENTIAL

- Device Type
- Device Service
- Firmware Version
- Paired Status (for Bluetooth devices)
- Connected Status
- Configured Status

Step 4 Press **Setup** to configure the selected accessory for your phone.

Step 5 Press **Exit** to return to the Applications screen.

USB Devices

Each USB port supports a maximum of five supported and nonsupported devices that are connected to the phone. Each device connected to the phone is included in the maximum device count.

For example, your phone can support five USB devices on the side port and five additional standard USB devices on the back port. Many third-party USB products contain more than one USB device, and thus count as more than one device. For example, a third-party USB device may contain an internal hub and a headset, and thus count as two USB devices.

If you use a USB hub and remove the USB cable from the phone or device port during an active call, it may cause your phone or device to reboot. For more information, contact your system administrator.

Mobile Device Charging

You can use the USB port on your Cisco IP phone to charge your mobile device if the device has a USB connection. USB charging is supported on the following ports:

- Side Port: Supports low current charging with a maximum value of 500mA charging current (2.5 Watt)
- Back Port: Supports SDP and DCP modes, with SDP supporting a maximum of 500mA charging current and the DCP supporting fast charging with a maximum 2.1A charging current (10.5 Watt)



Note The back port is only available on the Cisco IP Phone 8861 and 8865.

Your Cisco IP phone keeps charging the mobile device while in power saving mode but stops charging in deep sleep mode.

The USB charging feature supports the following mobile devices:

- Apple
 - iPad 1, 2,3, and 4
 - iPad Air

REVIEW DRAFT - CISCO CONFIDENTIAL

- iPad mini
- iPhone 4 and iPhone 5 series
- Samsung
 - Tablet
 - Note 2 and Note 3 series
 - Galaxy S4 series



Note Other mobile devices are supported but there may be instances of incompatibility where they will not get charged.

When charging your mobile device using your Cisco IP Phone, the following conditions apply:

- When you plug in a tablet, it takes about 3 seconds for the charging to begin. When it gets fully charged or nearly fully charged, the charging icon does not display and the battery capacity may decrease over time.



Note You can force the charging icon to display by unplugging and re-plugging in your device.

- In the PoE mode, when you plug-in a tablet, it does not display the charging icon and the battery capacity may decrease over time.
- If the battery capacity of your mobile device is lower than 90% when you plug it in, you will notice that charging starts immediately, stops for 2 seconds, and then resumes.
- If you unplug your tablet and immediately plug-in a USB headset to the tablet, there will be a delay of 3 seconds before the phone recognizes the USB headset.
- When more than one Cisco IP Phone 8800 Key Expansion Module is attached, back USB port cannot fast-charge the device.

Set Up Wideband for an Analog Headset

Procedure

-
- Step 1** Press **Applications** .
- Step 2** Use the Navigation cluster and Select button to scroll and select **Accessories**.
A list of phone accessories displays.
- Step 3** Select **Analog Headset** and press **Setup**.
The phone screen displays the wideband status for the analog headset.

REVIEW DRAFT - CISCO CONFIDENTIAL

Step 4 Press **On** or **Off** to enable or disable wideband for the analog headset.

Step 5 Press **Return**  to return to the Accessories screen.

Bluetooth Headsets

For Cisco IP Phone 8845, 8851, 8861 and 8865 only; Cisco IP Phone 8851NR does not support Bluetooth.

The Cisco IP Phone 8845, 8851, 8861 and 8865 support Bluetooth Class 1 technology when the headsets support Bluetooth. Bluetooth enables low-bandwidth wireless connections within a range of 66 feet (20 meters). The best performance is in the 3- to 6-foot (1- to 2-meter) range.

When using Bluetooth headsets with your phone, these conditions apply:

- You can pair and connect up to 50 Bluetooth headsets and smart phones to your phone, but the last Bluetooth headset or smart phone connected becomes the default for use with the phone.
- After a Bluetooth headset is connected, turning it off and on reconnects it to the phone. The following instructions apply when using the Bluetooth headset:
 - If you have both a Bluetooth headset and an analog headset attached to the phone, only one type of headset works at any time. Using a USB headset disables both the Bluetooth and analog headset.
 - Enable the Bluetooth headset to disable the analog headset.
 - Disable the Bluetooth headset to enable the analog headset.
 - Unplug the USB headset and then enable either the Bluetooth headset or the analog headset.
- For optimum headset coverage, use your Bluetooth headset within 10 ft of the phone, although Bluetooth coverage extends to about 30 ft from the phone.
- Your phone supports the Bluetooth Handsfree Profile. If your Bluetooth headset supports these features, you can perform these call functions from your Bluetooth headset:
 - Answer a call
 - End a call
 - Change the headset volume for a call
 - Redial
 - Caller ID
 - Reject
 - Divert
 - Hold and Accept
 - Release and Accept

For more information, see the documentation from your Bluetooth headset manufacturer.

REVIEW DRAFT - CISCO CONFIDENTIAL

While using Bluetooth headset, there can be potential interference issues. Therefore Cisco recommends that you reduce the proximity of other 802.11b/g devices, Bluetooth devices, microwave ovens, and large metal objects.

For a Bluetooth wireless headset to work, it does not need to be within direct line-of-sight of the phone, but some barriers, such as walls or doors, and interference from other electronic devices, can affect the connection.

Add a Bluetooth Accessory

For Cisco IP Phone 8845, 8851, 8861 and 8865 only. Cisco IP Phone 8851NR does not support Bluetooth.

Before you add a Bluetooth accessory, it must be discoverable by the phone. Look for a flashing LED on a Bluetooth accessory as an indication that it is discoverable. For more information, see the documentation from the Bluetooth accessory manufacturer.

Procedure

-
- Step 1** Press **Applications** .
 - Step 2** Select **Bluetooth**.
 - Step 3** Select **Add Bluetooth Accessory**.
The phone searches for discoverable accessories that are supported. When an accessory is found, it is added to the list in the Adding Bluetooth Accessory screen.
 - Step 4** Select the accessory and press **Connect**.
The phone automatically attempts to connect the accessory using a Bluetooth device PIN of "0000".
 - Step 5** If your accessory requires a different PIN and the Adding PIN screen appears, enter the PIN for your accessory. When the connection completes, a checkmark appears next to the connected accessory.

When Bluetooth is turned on, the Bluetooth active icon  appears on the phone screen header.

Connect a Bluetooth Accessory

For Cisco IP Phone 8845, 8851, 8861, and 8865 only. Cisco IP Phone 8851NR does not support Bluetooth.

Before You Begin

Before you can connect a Bluetooth accessory, it must be already added as an accessory to the phone.

Procedure

-
- Step 1** Press **Applications** .
 - Step 2** Select a Bluetooth accessory and press **Connect**.
When the connection completes, a checkmark appears next to the connected accessory.





REVIEW DRAFT - CISCO CONFIDENTIAL

When Bluetooth is turned on, the Bluetooth active icon  appears on the phone screen header.

Turn On Bluetooth

For Cisco IP Phone 8845, 8851, 8861 and 8865 only. Cisco IP Phone 8851NR does not support Bluetooth. If your system administrator has set up the Bluetooth feature for your phone, you can turn it on and off from your phone.

Procedure

- Step 1** Press **Applications** .
 - Step 2** Use the Navigation cluster and Select button to scroll and select **Bluetooth**.
 - Step 3** Press **On**.
The Bluetooth icon  appears on the phone screen header.
 - Step 4** (Optional) To add a Bluetooth accessory from this screen, select **Bluetooth** again and press **Add Accessory**.
 - Step 5** To turn off Bluetooth, press **Applications** .
 - Step 6** Use the Navigation pad and Select button to scroll and select **Settings**.
 - Step 7** Select **Bluetooth**.
 - Step 8** Press **Off**.
The Bluetooth icon  disappears from the phone screen header.
-

Disconnect a Bluetooth Accessory

For Cisco IP Phone 8845, 8851, 8861 and 8865 only. Cisco IP Phone 8851NR does not support Bluetooth.

Procedure

- Step 1** Press **Applications** .
 - Step 2** Select a Bluetooth accessory and then press **Disconnect**.
-

Delete a Bluetooth Accessory

For Cisco IP Phone 8845, 8851, 8861 and 8865 only. Cisco IP Phone 8851NR does not support Bluetooth.

REVIEW DRAFT - CISCO CONFIDENTIAL

Procedure

Step 1 Press **Applications** .

Step 2 Select a Bluetooth accessory and press **Delete**.
The Bluetooth accessory disconnects (if it was connected) and does not display on the Accessories list.

USB Headsets

For Cisco IP Phones 8851, 8851NR, 8861 and 8865 only.

Your phone supports USB headset devices attaching to all USB ports including side USB, back USB, and Key Expansion Module USB ports.

The following USB Headsets are supported:

- Jabra
 - PRO9400 and GO6400 series
 - PRO930, Biz2400, GN2000 series
 - Speak 450, Handset 450, and UC Voice 550
- Plantronics
 - Blackwire 600 and 400 series
 - Savi DECT 740, CS5xx DECT
 - Voyager Pro UC

USB headsets not listed above may not function properly when attached to the USB port. For more information, see the documentation from your USB headset manufacturer.

When using USB headsets with your phone, these conditions apply:

- The priority of USB headset over Bluetooth or analog headsets depends on the connected state of the headset (only one headset can be connected at a time).
- During a call using headset, the audio path changes automatically if you plug in a USB headset but does not change automatically if you plug out a USB headset.
- The phone displays an appropriate message when you plug in the USB headset or adjust the volume using the phone volume control key.

Cisco IP Phone 8800 Key Expansion Module

The Cisco IP Phone 8800 Key Expansion Module (KEM) attaches to your Cisco IP Phone 8851, 8851NR, or Cisco IP Phone 8861 and allows you to add up to 36 extra line appearances or programmable buttons to your

REVIEW DRAFT - CISCO CONFIDENTIAL

phone. The programmable buttons can be set up as phone line buttons, speed-dial buttons, or phone feature buttons.

You can add multiple Expansion Modules to the Cisco IP Phone 8851, 8851NR, and Cisco IP Phone 8861.

Cisco Unified IP Phone model	Number of Expansion Modules supported
8851 and 8851NR	2 Expansion Modules with 72 lines or buttons
8861	3 Expansion Modules with 108 lines or buttons

**Note**

The Cisco IP Phone 8811 and Cisco IP Phone 8841 do not support the Cisco IP Phone 8800 Key Expansion Module.

When multiple KEMs are attached, they are numbered according to the order in which they are connected to the phone. For example:

- Key Expansion Module 1 is the Expansion Module closest to the phone.
- Key Expansion Module 2 is the Expansion Module in the middle.
- Key Expansion Module 3 is the Expansion Module farthest to the right.

The following figure shows a Cisco IP Phone 8861 with three Cisco IP Phone 8800 Key Expansion Modules.

**Attention**

The slots in the side of the phone are designed for the KEM spine connector only. Inserting other objects will cause permanent damage to the phone.

Cisco IP Phone 8800 Key Expansion Module Features

The Cisco IP Phone 8800 Key Expansion Module includes the following features.

REVIEW DRAFT - CISCO CONFIDENTIAL

	<p>LCD screen: Displays the phone number, speed-dial number (or name or other text label), phone service, phone feature, or Privacy assigned to each button.</p> <p>Icons indicating line status appear similar to, and function the same as, those on the Cisco IP Phone to which the Key Expansion Module is attached.</p>
1	<p>Lighted Buttons: 18 line buttons. Depending on the mode, each button or pair of buttons corresponds to one line (as with the Cisco IP Phone). For mode information, see the description of one-column and 2-column mode following the table. The lights beneath each button indicate the state of the corresponding line as follows:</p> <ul style="list-style-type: none"> • Line available: light off • Line in use by you: solid green light • Line in use by someone else: solid red light • Line ringing: solid amber light • You have a call on hold: solid green light • Someone else has a call on hold on a shared line: solid red light • Call transfer: solid green light • Call is ringing on an inactive page: light off
2	<p>Shift Buttons: 2 buttons. Each button corresponds to one page of 18 line keys. The button for page one is labeled with the number 1 and the button for page two is labeled with the number 2. The lights beneath each button indicate the state of the page as follows:</p> <ul style="list-style-type: none"> • Page is in view: solid green light • Page is not in view: light off • Page is not in view, with one or more alerting calls on the page: solid amber light • Page is in view with one or more alerting calls on the page: solid green light

REVIEW DRAFT - CISCO CONFIDENTIAL

Your administrator sets up the Key Expansion Module to display in one-column or two-column mode.

One-column mode

In one-column mode, each row in the display corresponds to one line, and this line can be accessed by either the button on the left or the button on the right. In this configuration, the Key Expansion Module displays 9 lines on page 1, and 9 lines on page 2. The following graphic shows the one-column mode.



REVIEW DRAFT - CISCO CONFIDENTIAL

Two-column mode

In two-column mode, each of the buttons on the left and right of the screen is assigned to different lines. In this configuration, the Key Expansion Module displays 18 lines on page 1, and 18 lines on page 2. The following graphic shows the two-column mode.



372330

Place a Call on the Key Expansion Module

Procedure

-
- Step 1** Press the line button on the Key Expansion Module.
- Step 2** Dial a telephone number.
-

Configure KEM Buttons

Before you can set up KEM buttons, contact your system administrator for the following information to access your Self Care Portal:

- URL
- username and password

After you have this information, you can configure your speed-dial numbers or program buttons to access phone services. Phone services can include, for example, weather, stock quotes, or corporate calendars and directories.

REVIEW DRAFT - CISCO CONFIDENTIAL

Adjust Key Expansion Module Brightness

Procedure

- Step 1** Press **Applications**  on the phone.
- Step 2** Use the Navigation pad and Select to scroll and select **Settings**.
- Step 3** Select **Brightness**.
- Step 4** Select **Key Expansion Module**.
- Step 5** If required, select the KEM number.
- Step 6** Adjust brightness.
- To increase brightness, press the right arrow on the Navigation pad.
 - To decrease brightness, press the left arrow on the Navigation pad.
- Step 7** Press **Save** to set the brightness, or press **Cancel** to exit.
-

REVIEW DRAFT - CISCO CONFIDENTIAL



Frequently Asked Questions

- [Why Can't I See All Active Calls on My Phone?](#), page 140
- [How Do I Redirect an Incoming Call?](#), page 140
- [How Do I Silence a Ringing Call If I'm On a Call?](#), page 140
- [How Do I Resume a Call That is On Hold?](#), page 140
- [What Is the Difference Between Buttons on the Left and Those on the Right of the Screen?](#), page 141
- [Why Do Softkeys Keep Changing?](#), page 141
- [What Is the Best Way to Look at Calls When I Have a Shared Line or Multiple Lines?](#), page 141
- [What Should I Do If I Accidentally Press a Button While on a Call?](#), page 142
- [How Do I Check Missed Calls?](#), page 142
- [How Do I Exit from a Running Application?](#), page 142
- [How Do I Connect Two Calls and then Drop from the Line Myself?](#), page 143
- [What Does the Swap Softkey Do?](#), page 143
- [How Do I Cancel a Conference or Transfer After I Start It?](#), page 143
- [How Can I Combine Two Calls Into a Single Conference Call?](#), page 144
- [Why Does My Phone Not Wake Up?](#), page 144
- [What Do Four Rings in Succession Mean?](#), page 144
- [Where Should I Mount My Cisco Unified Video Camera?](#), page 145
- [How Can I Prevent Theft of my Cisco Unified Video Camera?](#), page 145
- [Why Do Some Calls Not Present Video On My Video Phone?](#), page 145
- [What Happens to Video When I Put a Call On Hold?](#), page 146
- [What Do the Light Colors on My Cisco Unified Video Camera Indicate?](#), page 146
- [How Do I Close the Shutter on my Cisco Unified Video Camera?](#), page 146
- [Why Does the Video on my Cisco Unifed Video Camera Appear Too Dark?](#), page 146

REVIEW DRAFT - CISCO CONFIDENTIAL

Why Can't I See All Active Calls on My Phone?

Question

Why can't I see all the active calls on my phone?

Answer

When there are more calls than available session buttons on the phone, you can scroll to see them. Calls are sorted from oldest to newest, with the oldest call at the top of the list.

How Do I Redirect an Incoming Call?

Question

How do I redirect an incoming call when I am on a call?

Answer

To redirect an incoming (ringing) call while on another call, highlight the incoming call, and then press **Decline**. Otherwise press **Decline** to redirect the current, active call.

How Do I Silence a Ringing Call If I'm On a Call?

Question

How do I silence a ringing call, if I'm on a call?

Answer

You can silence the incoming (ringing) call. Press **Volume** down once, and then let the incoming call go to the target number (voice mail or predetermined number set up the system administrator).

How Do I Resume a Call That is On Hold?

Question

How do I resume a call that is on hold?

Answer

To resume a call on hold, you can use any of the following methods:

- Press the pulsing green session button.
- Press the call session on the phone display.

REVIEW DRAFT - CISCO CONFIDENTIAL

- Press **Resume**.
- Highlight the call by using the Navigation cluster and press Select button.
- Press **Hold**.

What Is the Difference Between Buttons on the Left and Those on the Right of the Screen?

Question

What is the difference between the buttons on the left and those on the right of the screen?

Answer

Your phone has feature buttons on the left and call session buttons on the right. Use the feature buttons to access features (such as speed dial) or select a phone line. Use call session buttons to perform call-related tasks, such as making a new call, resuming a held call, or checking your voicemail. The positions of the session buttons and feature buttons can be reversed on phones that use a locale with a right-to-left reading orientation, such as Hebrew and Arabic.

Why Do Softkeys Keep Changing?

Question

Why do the softkeys keep changing?

Answer

Softkeys act on the selected (highlighted) call or menu item only. The softkeys that display depend on the call or item you have selected.

What Is the Best Way to Look at Calls When I Have a Shared Line or Multiple Lines?

Question

What is the best way to look at calls when I have a shared line or multiple lines?

Answer

If you have a shared line or multiple lines, it is recommended that you use the All Calls feature to view calls. When you press the **All Calls** button (on the left), all calls for all your lines are listed on the phone screen in chronological order (oldest first). If you do not have an **All Calls** button, contact your system administrator to set up this feature. Your administrator can also set up your primary line key to act the same as the **All Calls** button.

REVIEW DRAFT - CISCO CONFIDENTIAL

What Should I Do If I Accidentally Press a Button While on a Call?

Question

What should I do if I accidentally press a button while on a call?

Answer

If you are on a call and press a button for another line, your line view will change. Your current call disappears from view and calls for the newly selected line are displayed. To redisplay the call you are on, select the line that it is on, press **All Calls**, or, press the **Primary line** key if it is set up by your administrator to display all calls.

How Do I Check Missed Calls?

Question

How do I check missed calls on my phone?

Answer

To check missed calls on your phone:

- Press **Applications** , select **Recents**, and press **Missed Calls**.
- Press **All Calls**, and then press **Missed Calls**.

How Do I Exit from a Running Application?

Question

How do I exit from a running application?

Answer

To exit from a running applications you must:

- 1 Press **Applications** .
- 2 Scroll and select **Running Applications**.
- 3 Select a running application and press **Close App** to close the application.
When prompted, save your changes.
- 4 Press **Exit** to end the running application.

If you do not exit a running application, it continues to run in the background.

REVIEW DRAFT - CISCO CONFIDENTIAL

How Do I Connect Two Calls and then Drop from the Line Myself?

Question

How do I connect two calls and then drop from the line myself?

Answer

When you are on an active call (not on hold), do the following:

- 1 Press **Transfer**  and enter the transfer recipient's phone number in one of these ways:
 - Press the session button of a held call.
 - Enter the transfer recipient's phone number.
 - Scroll to a Call History record and press **Call**.
 - Press a speed-dial button.
 - Press **Speed Dial**, enter a speed-dial number or highlight the number you want to call, and press **Speed Dial** again.
 - Press **Active Calls** and select a held call. The transfer completes immediately.
- 2 Press **Transfer** again. You do not have to wait for the recipient to answer to complete the transfer.

What Does the Swap Softkey Do?

Question

What does the Swap softkey do?

Answer

The **Swap** softkey allows you to toggle between two calls before completing the transfer or creating a conference. This allows you to consult privately with the party or parties on each call before combining the calls into a conference.

How Do I Cancel a Conference or Transfer After I Start It?

Question

Can I cancel a conference or transfer procedure after I have started it?

REVIEW DRAFT - CISCO CONFIDENTIAL**Answer**

Yes, before completing a conference or transfer, you can press **Release** or **Cancel** to cancel it.

How Can I Combine Two Calls Into a Single Conference Call?

Question

How can I combine two calls on hold into a single conference call?

Answer

Make sure that one of the calls is active (not on hold). If both calls are on hold, resume one call, and then:

- 1 Press **Conference** .
- 2 Press the line button for the other (held) call.

The conference begins. The conference is established on the line that had the active call.

Why Does My Phone Not Wake Up?

Question

Why does my phone not work “wake up” when it worked before?

Answer

If your system administrator has set up your phone for EnergyWise, the phone may be sleeping (powered down). Your system administrator sets your phone to sleep at a certain time and wake (power up) at a certain time. Your phone wakes up at the time your system administrator configured. You can press the **Select** button to wake your phone up. Contact your system administrator to have the sleep and wake up times changed.

What Do Four Rings in Succession Mean?

Question

My phone played the ring tone four times in succession, but there is no call. What does this mean?

Answer

The phone is notifying you that your phone will power down (sleep) soon to conserve energy (the EnergyWise feature). Your system administrator sets your phone to sleep at a certain time and wakes (power up) at a certain time. Your phone wakes up at the time your system administrator configured, or you can press Select to wake it up. Contact your system administrator to have the sleep and wake up times changed.

REVIEW DRAFT - CISCO CONFIDENTIAL

Where Should I Mount My Cisco Unified Video Camera?

Question

Should I mount my Cisco Unified Video Camera on my phone or on my computer monitor?

Answer

For casual video calling, a camera mounted directly on the phone is recommended. If you plan to turn to face your computer monitor often (for example, if you are presenting slides), a camera mounted on monitor might be preferable. Experiment with both and see what works best for you.

If you prefer to mount your camera on your computer monitor, ask your system administrator for a camera mounting clip and USB extension cable.

How Can I Prevent Theft of my Cisco Unified Video Camera?

Question

How can I keep my Cisco Unified Video Camera secure to prevent theft?

Answer

If you are concerned about theft, you can place the camera in a locked drawer when not in use. If you plan to remove the camera regularly for this reason, consider attaching the camera to a USB extension cable (available from your system administrator) rather than mounting the camera directly on the phone.

Connecting and disconnecting the camera is easy and neither resets the phone nor disrupts the audio portion of an active call. However, you may find connecting and disconnecting the camera easier if a USB cable is used rather than directly removing and reattaching the camera to the phone.

Note that the Cisco wall mount kit contains a security mechanism which locks the camera to the phone.

Why Do Some Calls Not Present Video On My Video Phone?

Question

Why do not all calls display video on my phone?

Answer

To see an image of the other party on your phone screen, the other party's phone must support video and the other party must have a camera installed and enabled on the phone. During conference calls, the conference system used during the call must support video conferencing.

REVIEW DRAFT - CISCO CONFIDENTIAL

What Happens to Video When I Put a Call On Hold?

Question

What happens to video when I put a call on hold?

Answer

Video transmission is muted (blocked) until you resume the call.

What Do the Light Colors on My Cisco Unified Video Camera Indicate?

Question

What do the different light colors on my Cisco Unified Video Camera indicate?

Answer

The colors indicate video transmission states as follows:

- Green: Your video is transmitting.
- Red: Your video is muted.

How Do I Close the Shutter on my Cisco Unified Video Camera?

Question

How can I close the shutter on my Cisco Unified Video Camera?

Answer

Close the camera shutter by rotating the camera lens clockwise. Rotate counter-clockwise to open the shutter again

Why Does the Video on my Cisco Unified Video Camera Appear Too Dark?

Question

Why does video from my Cisco Unified Video Camera appear too dark (or too light)?

REVIEW DRAFT - CISCO CONFIDENTIAL**Answer**

Lighting conditions (such as windows and ceiling lights) within the camera field of view affect the brightness. Try moving the camera to see if the brightness improves. You can also adjust the brightness setting.

REVIEW DRAFT - CISCO CONFIDENTIAL



Troubleshooting

- [Missing Alert Calls Button, page 149](#)
- [Missing All Calls Button, page 149](#)
- [Missing Mobile and Remote Access through Expressway Sign-in Window, page 150](#)
- [Cannot Sign In to Personal Directory, page 150](#)
- [Cannot Access Self Care Portal, page 151](#)
- [Security Error Message, page 151](#)
- [Report Phone Problems, page 151](#)
- [Documentation, Service Requests, and Additional Information, page 152](#)

Missing Alert Calls Button

Issue

I would like to use the Alert Calls button but it is not on my phone.

Possible Cause

It has not been set up by your system administrator.

Solution

Contact your system administrator to enable the Alert Calls feature for you.

Missing All Calls Button

Issue

I would like to use the All Calls button, but it is not on my phone.

REVIEW DRAFT - CISCO CONFIDENTIAL

Possible Cause

It has not been set up by your system administrator or your system administrator may have set up your phone so that the primary line button performs the All Calls function.

Solution

Contact your system administrator to enable the All Calls feature for you or check with your administrator about the primary line button functionality.

Missing Mobile and Remote Access through Expressway Sign-in Window

Issue

The Mobile and Remote Access through Expressway sign-in window did not appear on my phone.

Possible Cause

The DHCP setting is enabled on your network router.

Solution

Check your network router settings and, if necessary, disable the DHCP setting and configure the static IP on the phone directly. Contact your administrator for assistance.

Cannot Sign In to Personal Directory

Problem

You are unable to sign in to your personal directory.

Possible Cause

- You are using your password to sign in, not your personal identification number (PIN).
- Your PIN needs to be reset.

Solution

- Use your PIN, not your password.
- Contact your system administrator.

REVIEW DRAFT - CISCO CONFIDENTIAL

Cannot Access Self Care Portal

Problem

You are unable to access your Self Care Portal.

Possible Cause

Your password needs to be reset or your administrator may have changed your access to the pages.

Solution

Contact your system administrator.

Security Error Message

Problem

Your phone displays `Security Error`.

Cause

Your phone firmware has identified an internal error.

Solution

If the message persists, contact your system administrator.

Report Phone Problems

Your system administrator may temporarily configure your phone with the Quality Reporting Tool (QRT) to troubleshoot performance problems. Depending on configuration, use the QRT to:

- Immediately report an audio problem on a current call.
- Select a general problem from a list of categories and choose reason codes.

Procedure

- Step 1** Press **Report Quality**.
- Step 2** Scroll and select the item that closely matches your problem.
- Step 3** Press the **Select** softkey.
The information is sent to your system administrator.
-

REVIEW DRAFT - CISCO CONFIDENTIAL

Documentation, Service Requests, and Additional Information

For information about how to obtain documentation, submit a service request, and gather additional information, see the monthly What's New in Cisco Product Documentation, which also lists all new and revised Cisco technical documentation, at <http://www.cisco.com/c/en/us/td/docs/general/whatsnew/whatsnew.html>.

Subscribe to the What's New in Cisco Product Documentation as a Really Simple Syndication (RSS) feed and set content to be delivered directly to your desktop using a reader application. The RSS feeds are a free service and Cisco currently supports RSS Version 2.0.



Product Safety and Security

- [Safety and Performance Information, page 153](#)
- [FCC Compliance Statements, page 154](#)
- [Cisco Product Security Overview, page 155](#)

Safety and Performance Information

Power Outage

Power outages and other devices can affect your Cisco IP Phone.

Your access to emergency service through the phone requires that the phone receive power. If a power interruption occurs, Service and Emergency Calling Service dialing will not function until power is restored. In case of a power failure or disruption, you may need to reset or reconfigure the equipment before you can use the Service or Emergency Calling Service dialing.

External Devices

We recommend using good-quality external devices, such as headsets, cables, and connectors, that are shielded against unwanted radio frequency (RF) and audio frequency (AF) signals.



Note

Not all Cisco IP Telephony products support external devices, cords or cables. For more information, consult the documentation for your endpoint.

Depending on the quality of these devices and their proximity to other devices, such as mobile phones or two-way radios, some audio noise may still occur. In these cases, Cisco recommends that you take one or more of these actions:

- Move the external device away from the source of the RF or AF signals.
- Route the external device cables away from the source of the RF or AF signals.

REVIEW DRAFT - CISCO CONFIDENTIAL

- Use shielded cables for the external device, or use cables with a better shield and connector.
- Shorten the length of the external device cable.
- Apply ferrites or other such devices on the cables for the external device.

Cisco cannot guarantee the performance of external devices, cables, and connectors.

**Caution**

In European Union countries, use only external speakers, microphones, and headsets that are fully compliant with the EMC Directive [89/336/EC].

Bluetooth Wireless Headset Performance

The Cisco IP Phones support Bluetooth Class 2 technology when the headsets support Bluetooth. Bluetooth enables low-bandwidth wireless connections within a range of 30 feet (10 meters). The best performance is in the 3- to 6-foot (1- to 2-meter) range. You can connect up to five headsets, but only the last one connected is used as the default.

Because there can be potential interference issues, Cisco recommends that you move 802.11b/g devices, Bluetooth devices, microwave ovens, and large metal objects away from the wireless headset.

For a Bluetooth wireless headset to work, it does not need to be within direct line-of-sight of the phone, but some barriers, such as walls or doors, and interference from other electronic devices, can affect the connection.

Power Information

Connect your Cisco IP phone to your LAN using a CAT 5e Ethernet cable to enable full functionality of your Cisco IP phone. If your Ethernet port is equipped with Power over Ethernet (PoE), your Cisco IP phone can be powered through the LAN port. Do not extend the LAN Ethernet cable outside the building.

FCC Compliance Statements

The Federal Communications Commission requires compliance statements for the following:

FCC Part 15.21 Statement

Changes or modifications not expressly approved by the party responsible for compliance could void the user's authority to operate the equipment.

FCC RF Radiation Exposure Statement

This equipment complies with FCC radiation exposure limits set forth for an uncontrolled environment. End users must follow the specific operating instructions for satisfying RF exposure compliance. This transmitter must be at least 20 cm from the user and must not be collocated or operating in conjunction with any other antenna or transmitter.

REVIEW DRAFT - CISCO CONFIDENTIAL

FCC Receivers and Class B Digital Statement

This product has been tested and complies with the specifications for a Class B digital device, pursuant to Part 15 of the FCC Rules. These limits are designed to provide reasonable protection against harmful interference in a residential installation. This equipment generates, uses, and can radiate radio frequency energy and, if not installed and used according to the instructions, may cause harmful interference to radio communications. However, there is no guarantee that interference will not occur in a particular installation.

If this equipment does cause harmful interference to radio or television reception, which is found by turning the equipment off and on, the user is encouraged to try to correct the interference by one or more of the following measures:

- Reorient or relocate the receiving antenna
- Increase the separation between the equipment or devices
- Connect the equipment to an outlet other than the receiver's
- Consult a dealer or an experienced radio/TV technician for assistance

Cisco Product Security Overview

This product contains cryptographic features and is subject to United States and local country laws governing import, export, transfer, and use. Delivery of Cisco cryptographic products does not imply third-party authority to import, export, distribute, or use encryption. Importers, exporters, distributors, and users are responsible for compliance with U.S. and local country laws. By using this product you agree to comply with applicable laws and regulations. If you are unable to comply with U.S. and local laws, return this product immediately.

Further information regarding U.S. export regulations may be found at <http://www.bis.doc.gov/index.php/regulations/export-administration-regulations-ear>.

REVIEW DRAFT - CISCO CONFIDENTIAL



Warranty

- [Cisco One-Year Limited Hardware Warranty Terms, page 157](#)

Cisco One-Year Limited Hardware Warranty Terms

Special terms apply to your hardware warranty and services that you can use during the warranty period. Your formal Warranty Statement, including the warranties and license agreements applicable to Cisco software, is available on Cisco.com at the following URL: <http://www.cisco.com/go/hwwarranty>.

REVIEW DRAFT - CISCO CONFIDENTIAL